

# ARM® Architecture Reference Manual

## ARMv7-A and ARMv7-R edition

**ARM®**

# ARM Architecture Reference Manual

## ARMv7-A and ARMv7-R edition

Copyright © 1996-1998, 2000, 2004-2012 ARM. All rights reserved.

### Release Information

The following changes have been made to this document.

#### Change History

Date	Issue	Confidentiality	Change
05 April 2007	A	Non-Confidential	New edition for ARMv7-A and ARMv7-R architecture profiles. Document number changed from ARM DDI 0100 to ARM DDI 0406 and contents restructured.
29 April 2008	B	Non-Confidential	Addition of the VFP Half-precision and Multiprocessing Extensions, and many clarifications and enhancements.
23 November 2011	C (C.a)	Non-Confidential	Addition of the Virtualization Extensions, Large Physical Address Extension, Generic Timer Extension, and other additions. Many other clarifications and enhancements.
24 July 2012	C.b	Non-Confidential	Errata release for issue C.a.

**Note that** issue C.a, the first publication of issue C of this manual, was originally identified as issue C.

From ARMv7, the ARM® architecture defines different architectural profiles and this edition of this manual describes only the A and R profiles. For details of the documentation of the ARMv7-M profile see [Additional reading on page xxiii](#). Before ARMv7 there was only a single *ARM Architecture Reference Manual*, with document number DDI 0100. The first issue of this was in February 1996, and the final issue, issue I, was in July 2005. For more information see [Additional reading on page xxiii](#).

### Proprietary Notice

This ARM Architecture Reference Manual is protected by copyright and the practice or implementation of the information herein may be protected by one or more patents or pending applications. No part of this ARM Architecture Reference Manual may be reproduced in any form by any means without the express prior written permission of ARM. **No license, express or implied, by estoppel or otherwise to any intellectual property rights is granted by this ARM Architecture Reference Manual.**

Your access to the information in this ARM Architecture Reference Manual is conditional upon your acceptance that you will not use or permit others to use the information for the purposes of determining whether implementations of the ARM architecture infringe any third party patents.

This ARM Architecture Reference Manual is provided “as is”. ARM makes no representations or warranties, either express or implied, included but not limited to, warranties of merchantability, fitness for a particular purpose, or non-infringement, that the content of this ARM Architecture Reference Manual is suitable for any particular purpose or that any practice or implementation of the contents of the ARM Architecture Reference Manual will not infringe any third party patents, copyrights, trade secrets, or other rights.

This ARM Architecture Reference Manual may include technical inaccuracies or typographical errors.

To the extent not prohibited by law, in no event will ARM be liable for any damages, including without limitation any direct loss, lost revenue, lost profits or data, special, indirect, consequential, incidental or punitive damages, however caused and regardless of the theory of liability, arising out of or related to any furnishing, practicing, modifying or any use of this ARM Architecture Reference Manual, even if ARM has been advised of the possibility of such damages.

Words and logos marked with ® or TM are registered trademarks or trademarks of ARM Limited, except as otherwise stated below in this proprietary notice. Other brands and names mentioned herein may be the trademarks of their respective owners.

Copyright © 1996-1998, 2000, 2004-2012 ARM Limited

110 Fulbourn Road, Cambridge, England CB1 9NJ

This document consists solely of commercial items. You shall be responsible for ensuring that any use, duplication or disclosure of this document complies fully with any relevant export laws and regulations to assure that this document or any portion thereof is not exported, directly or indirectly, in violation of such export laws.

**This document is Non-Confidential but any disclosure by you is subject to you providing notice to and the acceptance by the recipient of, the conditions set out above.**

In this document, where the term ARM is used to refer to the company it means “ARM or any of its subsidiaries as appropriate”.

———— **Note** —————

The term ARM can refer to versions of the ARM architecture, for example ARMv6 refers to version 6 of the ARM architecture. The context makes it clear when the term is used in this way.

---





# Contents

## ARM Architecture Reference Manual ARMv7-A and ARMv7-R edition

### Preface

About this manual .....	xiv
Using this manual .....	xvi
Conventions .....	xxi
Additional reading .....	xxiii
Feedback .....	xxiv

## Part A

### Application Level Architecture

#### Chapter A1

#### Introduction to the ARM Architecture

A1.1	About the ARM architecture .....	A1-28
A1.2	The instruction sets .....	A1-29
A1.3	Architecture versions, profiles, and variants .....	A1-30
A1.4	Architecture extensions .....	A1-32
A1.5	The ARM memory model .....	A1-35

#### Chapter A2

#### Application Level Programmers' Model

A2.1	About the Application level programmers' model .....	A2-38
A2.2	ARM core data types and arithmetic .....	A2-40
A2.3	ARM core registers .....	A2-45
A2.4	The Application Program Status Register (APSR) .....	A2-49
A2.5	Execution state registers .....	A2-50
A2.6	Advanced SIMD and Floating-point Extensions .....	A2-54
A2.7	Floating-point data types and arithmetic .....	A2-63
A2.8	Polynomial arithmetic over {0, 1} .....	A2-93
A2.9	Coprocessor support .....	A2-94

A2.10	Thumb Execution Environment .....	A2-95
A2.11	Jazelle direct bytecode execution support .....	A2-97
A2.12	Exceptions, debug events and checks .....	A2-102
<b>Chapter A3</b>	<b>Application Level Memory Model</b>	
A3.1	Address space .....	A3-106
A3.2	Alignment support .....	A3-108
A3.3	Endian support .....	A3-110
A3.4	Synchronization and semaphores .....	A3-114
A3.5	Memory types and attributes and the memory order model .....	A3-125
A3.6	Access rights .....	A3-141
A3.7	Virtual and physical addressing .....	A3-144
A3.8	Memory access order .....	A3-145
A3.9	Caches and memory hierarchy .....	A3-155
<b>Chapter A4</b>	<b>The Instruction Sets</b>	
A4.1	About the instruction sets .....	A4-160
A4.2	Unified Assembler Language .....	A4-162
A4.3	Branch instructions .....	A4-164
A4.4	Data-processing instructions .....	A4-165
A4.5	Status register access instructions .....	A4-174
A4.6	Load/store instructions .....	A4-175
A4.7	Load/store multiple instructions .....	A4-177
A4.8	Miscellaneous instructions .....	A4-178
A4.9	Exception-generating and exception-handling instructions .....	A4-179
A4.10	Coprocessor instructions .....	A4-180
A4.11	Advanced SIMD and Floating-point load/store instructions .....	A4-181
A4.12	Advanced SIMD and Floating-point register transfer instructions .....	A4-183
A4.13	Advanced SIMD data-processing instructions .....	A4-184
A4.14	Floating-point data-processing instructions .....	A4-191
<b>Chapter A5</b>	<b>ARM Instruction Set Encoding</b>	
A5.1	ARM instruction set encoding .....	A5-194
A5.2	Data-processing and miscellaneous instructions .....	A5-196
A5.3	Load/store word and unsigned byte .....	A5-208
A5.4	Media instructions .....	A5-209
A5.5	Branch, branch with link, and block data transfer .....	A5-214
A5.6	Coprocessor instructions, and Supervisor Call .....	A5-215
A5.7	Unconditional instructions .....	A5-216
<b>Chapter A6</b>	<b>Thumb Instruction Set Encoding</b>	
A6.1	Thumb instruction set encoding .....	A6-220
A6.2	16-bit Thumb instruction encoding .....	A6-223
A6.3	32-bit Thumb instruction encoding .....	A6-230
<b>Chapter A7</b>	<b>Advanced SIMD and Floating-point Instruction Encoding</b>	
A7.1	Overview .....	A7-254
A7.2	Advanced SIMD and Floating-point instruction syntax .....	A7-255
A7.3	Register encoding .....	A7-259
A7.4	Advanced SIMD data-processing instructions .....	A7-261
A7.5	Floating-point data-processing instructions .....	A7-272
A7.6	Extension register load/store instructions .....	A7-274
A7.7	Advanced SIMD element or structure load/store instructions .....	A7-275
A7.8	8, 16, and 32-bit transfer between ARM core and extension registers .....	A7-278
A7.9	64-bit transfers between ARM core and extension registers .....	A7-279
<b>Chapter A8</b>	<b>Instruction Details</b>	
A8.1	Format of instruction descriptions .....	A8-282

A8.2	Standard assembler syntax fields .....	A8-287
A8.3	Conditional execution .....	A8-288
A8.4	Shifts applied to a register .....	A8-291
A8.5	Memory accesses .....	A8-294
A8.6	Encoding of lists of ARM core registers .....	A8-295
A8.7	Additional pseudocode support for instruction descriptions .....	A8-296
A8.8	Alphabetical list of instructions .....	A8-300

**Chapter A9****The ThumbEE Instruction Set**

A9.1	About the ThumbEE instruction set .....	A9-1112
A9.2	ThumbEE instruction set encoding .....	A9-1115
A9.3	Additional instructions in Thumb and ThumbEE instruction sets .....	A9-1116
A9.4	ThumbEE instructions with modified behavior .....	A9-1117
A9.5	Additional ThumbEE instructions .....	A9-1123

**Part B****System Level Architecture****Chapter B1****The System Level Programmers' Model**

B1.1	About the System level programmers' model .....	B1-1134
B1.2	System level concepts and terminology .....	B1-1135
B1.3	ARM processor modes and ARM core registers .....	B1-1139
B1.4	Instruction set states .....	B1-1155
B1.5	The Security Extensions .....	B1-1156
B1.6	The Large Physical Address Extension .....	B1-1159
B1.7	The Virtualization Extensions .....	B1-1161
B1.8	Exception handling .....	B1-1164
B1.9	Exception descriptions .....	B1-1204
B1.10	Coprocessors and system control .....	B1-1225
B1.11	Advanced SIMD and floating-point support .....	B1-1228
B1.12	Thumb Execution Environment .....	B1-1239
B1.13	Jazelle direct bytecode execution .....	B1-1240
B1.14	Traps to the hypervisor .....	B1-1247

**Chapter B2****Common Memory System Architecture Features**

B2.1	About the memory system architecture .....	B2-1264
B2.2	Caches and branch predictors .....	B2-1266
B2.3	IMPLEMENTATION DEFINED memory system features .....	B2-1291
B2.4	Pseudocode details of general memory system operations .....	B2-1292

**Chapter B3****Virtual Memory System Architecture (VMSA)**

B3.1	About the VMSA .....	B3-1308
B3.2	The effects of disabling MMUs on VMSA behavior .....	B3-1314
B3.3	Translation tables .....	B3-1318
B3.4	Secure and Non-secure address spaces .....	B3-1323
B3.5	Short-descriptor translation table format .....	B3-1324
B3.6	Long-descriptor translation table format .....	B3-1338
B3.7	Memory access control .....	B3-1356
B3.8	Memory region attributes .....	B3-1366
B3.9	Translation Lookaside Buffers (TLBs) .....	B3-1378
B3.10	TLB maintenance requirements .....	B3-1381
B3.11	Caches in a VMSA implementation .....	B3-1392
B3.12	VMSA memory aborts .....	B3-1395
B3.13	Exception reporting in a VMSA implementation .....	B3-1409
B3.14	Virtual Address to Physical Address translation operations .....	B3-1438
B3.15	About the system control registers for VMSA .....	B3-1444
B3.16	Organization of the CP14 registers in a VMSA implementation .....	B3-1468
B3.17	Organization of the CP15 registers in a VMSA implementation .....	B3-1469

B3.18	Functional grouping of VMSAv7 system control registers .....	B3-1491
B3.19	Pseudocode details of VMSA memory system operations .....	B3-1503
<b>Chapter B4</b>	<b>System Control Registers in a VMSA implementation</b>	
B4.1	VMSA System control registers descriptions, in register order .....	B4-1522
B4.2	VMSA system control operations described by function .....	B4-1740
<b>Chapter B5</b>	<b>Protected Memory System Architecture (PMSA)</b>	
B5.1	About the PMSA .....	B5-1754
B5.2	Memory access control .....	B5-1759
B5.3	Memory region attributes .....	B5-1760
B5.4	PMSA memory aborts .....	B5-1763
B5.5	Exception reporting in a PMSA implementation .....	B5-1767
B5.6	About the system control registers for PMSA .....	B5-1772
B5.7	Organization of the CP14 registers in a PMSA implementation .....	B5-1784
B5.8	Organization of the CP15 registers in a PMSA implementation .....	B5-1785
B5.9	Functional grouping of PMSAv7 system control registers .....	B5-1797
B5.10	Pseudocode details of PMSA memory system operations .....	B5-1804
<b>Chapter B6</b>	<b>System Control Registers in a PMSA implementation</b>	
B6.1	PMSA System control registers descriptions, in register order .....	B6-1808
B6.2	PMSA system control operations described by function .....	B6-1941
<b>Chapter B7</b>	<b>The CPUID Identification Scheme</b>	
B7.1	Introduction to the CPUID scheme .....	B7-1948
B7.2	The CPUID registers .....	B7-1949
B7.3	Advanced SIMD and Floating-point Extension feature identification registers .....	B7-1955
<b>Chapter B8</b>	<b>The Generic Timer</b>	
B8.1	About the Generic Timer .....	B8-1958
B8.2	Generic Timer registers summary .....	B8-1967
<b>Chapter B9</b>	<b>System Instructions</b>	
B9.1	General restrictions on system instructions .....	B9-1970
B9.2	Encoding and use of Banked register transfer instructions .....	B9-1971
B9.3	Alphabetical list of instructions .....	B9-1976
<b>Part C</b>	<b>Debug Architecture</b>	
<b>Chapter C1</b>	<b>Introduction to the ARM Debug Architecture</b>	
C1.1	Scope of part C of this manual .....	C1-2020
C1.2	About the ARM Debug architecture .....	C1-2021
C1.3	Security Extensions and debug .....	C1-2025
C1.4	Register interfaces .....	C1-2026
<b>Chapter C2</b>	<b>Invasive Debug Authentication</b>	
C2.1	About invasive debug authentication .....	C2-2028
C2.2	Invasive debug with no Security Extensions .....	C2-2029
C2.3	Invasive debug with the Security Extensions .....	C2-2031
C2.4	Invasive debug authentication security considerations .....	C2-2033
<b>Chapter C3</b>	<b>Debug Events</b>	
C3.1	About debug events .....	C3-2036
C3.2	BKPT instruction debug events .....	C3-2038
C3.3	Breakpoint debug events .....	C3-2039
C3.4	Watchpoint debug events .....	C3-2057

C3.5	Vector catch debug events .....	C3-2065
C3.6	Halting debug events .....	C3-2073
C3.7	Generation of debug events .....	C3-2074
C3.8	Debug event prioritization .....	C3-2076
C3.9	Pseudocode details of Software debug events .....	C3-2078
<b>Chapter C4</b>	<b>Debug Exceptions</b>	
C4.1	About debug exceptions .....	C4-2088
C4.2	Avoiding debug exceptions that might cause UNPREDICTABLE behavior ....	C4-2090
<b>Chapter C5</b>	<b>Debug State</b>	
C5.1	About Debug state .....	C5-2092
C5.2	Entering Debug state .....	C5-2093
C5.3	Executing instructions in Debug state .....	C5-2096
C5.4	Behavior of non-invasive debug in Debug state .....	C5-2104
C5.5	Exceptions in Debug state .....	C5-2105
C5.6	Memory system behavior in Debug state .....	C5-2109
C5.7	Exiting Debug state .....	C5-2110
<b>Chapter C6</b>	<b>Debug Register Interfaces</b>	
C6.1	About the debug register interfaces .....	C6-2114
C6.2	Synchronization of debug register updates .....	C6-2115
C6.3	Access permissions .....	C6-2117
C6.4	The CP14 debug register interface .....	C6-2121
C6.5	The memory-mapped and recommended external debug interfaces .....	C6-2126
C6.6	Summary of the v7 Debug register interfaces .....	C6-2128
C6.7	Summary of the v7.1 Debug register interfaces .....	C6-2137
<b>Chapter C7</b>	<b>Debug Reset and Powerdown Support</b>	
C7.1	Debug guidelines for systems with energy management capability .....	C7-2148
C7.2	Power domains and debug .....	C7-2149
C7.3	The OS Save and Restore mechanism .....	C7-2152
C7.4	Reset and debug .....	C7-2160
<b>Chapter C8</b>	<b>The Debug Communications Channel and Instruction Transfer Register</b>	
C8.1	About the DCC and DBGITR .....	C8-2164
C8.2	Operation of the DCC and Instruction Transfer Register .....	C8-2167
C8.3	Behavior of accesses to the DCC registers and DBGITR .....	C8-2171
C8.4	Synchronization of accesses to the DCC and the DBGITR .....	C8-2176
<b>Chapter C9</b>	<b>Non-invasive Debug Authentication</b>	
C9.1	About non-invasive debug authentication .....	C9-2182
C9.2	Non-invasive debug authentication .....	C9-2183
C9.3	Effects of non-invasive debug authentication .....	C9-2185
<b>Chapter C10</b>	<b>Sample-based Profiling</b>	
C10.1	Sample-based profiling .....	C10-2188
<b>Chapter C11</b>	<b>The Debug Registers</b>	
C11.1	About the debug registers .....	C11-2192
C11.2	Debug register summary .....	C11-2193
C11.3	Debug identification registers .....	C11-2196
C11.4	Control and status registers .....	C11-2197
C11.5	Instruction and data transfer registers .....	C11-2198
C11.6	Software debug event registers .....	C11-2199
C11.7	Sample-based profiling registers .....	C11-2200
C11.8	OS Save and Restore registers .....	C11-2201

C11.9	Memory system control registers .....	C11-2202
C11.10	Management registers .....	C11-2203
C11.11	Register descriptions, in register order .....	C11-2209

**Chapter C12 The Performance Monitors Extension**

C12.1	About the Performance Monitors .....	C12-2300
C12.2	Accuracy of the Performance Monitors .....	C12-2304
C12.3	Behavior on overflow .....	C12-2305
C12.4	Effect of the Security Extensions and Virtualization Extensions .....	C12-2307
C12.5	Event filtering, PMUv2 .....	C12-2309
C12.6	Counter enables .....	C12-2311
C12.7	Counter access .....	C12-2312
C12.8	Event numbers and mnemonics .....	C12-2313
C12.9	Performance Monitors registers .....	C12-2326

**Part D Appendixes**

**Appendix A Recommended External Debug Interface**

A.1	About the recommended external debug interface .....	AppxA-2336
A.2	Authentication signals .....	AppxA-2338
A.3	Run-control and cross-triggering signals .....	AppxA-2340
A.4	Recommended debug slave port .....	AppxA-2344
A.5	Other debug signals .....	AppxA-2346

**Appendix B Recommended Memory-mapped and External Debug Interfaces for the Performance Monitors**

B.1	About the memory-mapped views of the Performance Monitors registers	AppxB-2352
B.2	PMU register descriptions for memory-mapped register views .....	AppxB-2361

**Appendix C Recommendations for Performance Monitors Event Numbers for IMPLEMENTATION DEFINED Events**

C.1	ARM recommendations for IMPLEMENTATION DEFINED event numbers	AppxC-2376
-----	--	------------

**Appendix D Example OS Save and Restore Sequences for External Debug Over Powerdown**

D.1	Example OS Save and Restore sequences for v7 Debug .....	AppxD-2388
D.2	Example OS Save and Restore sequences for v7.1 Debug .....	AppxD-2392

**Appendix E System Level Implementation of the Generic Timer**

E.1	About the Generic Timer specification .....	AppxE-2396
E.2	Memory-mapped counter module .....	AppxE-2397
E.3	Counter module control and status register summary .....	AppxE-2400
E.4	About the memory-mapped view of the counter and timer .....	AppxE-2402
E.5	The CNTBaseN and CNTPL0BaseN frames .....	AppxE-2403
E.6	The CNTCTLBase frame .....	AppxE-2405
E.7	System level Generic Timer register descriptions, in register order .....	AppxE-2406
E.8	Providing a complete set of counter and timer features .....	AppxE-2423
E.9	Gray-count scheme for timer distribution scheme .....	AppxE-2425

**Appendix F Common VFP Subarchitecture Specification**

F.1	Scope of this appendix .....	AppxF-2429
F.2	Introduction to the Common VFP subarchitecture .....	AppxF-2430
F.3	Exception processing .....	AppxF-2432
F.4	Support code requirements .....	AppxF-2436
F.5	Context switching .....	AppxF-2438
F.6	Subarchitecture additions to the Floating-point Extension system registers	AppxF-2439

F.7	Earlier versions of the Common VFP subarchitecture .....	AppxF-2446
<b>Appendix G</b>	<b>Barrier Litmus Tests</b>	
G.1	Introduction .....	AppxG-2448
G.2	Simple ordering and barrier cases .....	AppxG-2451
G.3	Exclusive accesses and barriers .....	AppxG-2458
G.4	Using a mailbox to send an interrupt .....	AppxG-2460
G.5	Cache and TLB maintenance operations and barriers .....	AppxG-2461
<b>Appendix H</b>	<b>Legacy Instruction Mnemonics</b>	
H.1	Thumb instruction mnemonics .....	AppxH-2468
H.2	Other UAL mnemonic changes .....	AppxH-2469
H.3	Pre-UAL pseudo-instruction NOP .....	AppxH-2472
<b>Appendix I</b>	<b>Deprecated and Obsolete Features</b>	
I.1	Deprecated features .....	AppxI-2474
I.2	Obsolete features .....	AppxI-2483
I.3	Use of the SP as a general-purpose register .....	AppxI-2484
I.4	Explicit use of the PC in ARM instructions .....	AppxI-2485
I.5	Deprecated Thumb instructions .....	AppxI-2486
<b>Appendix J</b>	<b>Fast Context Switch Extension (FCSE)</b>	
J.1	About the FCSE .....	AppxJ-2488
J.2	Modified virtual addresses .....	AppxJ-2489
J.3	Debug and trace .....	AppxJ-2491
<b>Appendix K</b>	<b>VFP Vector Operation Support</b>	
K.1	About VFP vector mode .....	AppxK-2494
K.2	Vector length and stride control .....	AppxK-2495
K.3	VFP register banks .....	AppxK-2496
K.4	VFP instruction type selection .....	AppxK-2497
<b>Appendix L</b>	<b>ARMv6 Differences</b>	
L.1	Introduction to ARMv6 .....	AppxL-2500
L.2	Application level register support .....	AppxL-2501
L.3	Application level memory support .....	AppxL-2504
L.4	Instruction set support .....	AppxL-2508
L.5	System level register support .....	AppxL-2513
L.6	System level memory model .....	AppxL-2516
L.7	System Control coprocessor, CP15, support .....	AppxL-2523
<b>Appendix M</b>	<b>v6 Debug and v6.1 Debug Differences</b>	
M.1	About v6 Debug and v6.1 Debug .....	AppxM-2548
M.2	Invasive debug authentication, v6 Debug and v6.1 Debug .....	AppxM-2549
M.3	Debug events, v6 Debug and v6.1 Debug .....	AppxM-2550
M.4	Debug exceptions, v6 Debug and v6.1 Debug .....	AppxM-2554
M.5	Debug state, v6 Debug and v6.1 Debug .....	AppxM-2555
M.6	Debug register interfaces, v6 Debug and v6.1 Debug .....	AppxM-2559
M.7	Reset and powerdown support .....	AppxM-2562
M.8	The Debug Communications Channel and Instruction Transfer Register .....	AppxM-2563
M.9	Non-invasive debug authentication, v6 Debug and v6.1 Debug .....	AppxM-2564
M.10	Sample-based profiling, v6 Debug and v6.1 Debug .....	AppxM-2566
M.11	The debug registers, v6 Debug and v6.1 Debug .....	AppxM-2567
M.12	Performance monitors, v6 Debug and v6.1 Debug .....	AppxM-2578
<b>Appendix N</b>	<b>Secure User Halting Debug</b>	
N.1	About Secure User halting debug .....	AppxN-2580

N.2	Invasive debug authentication in an implementation that supports SUHD	AppxN-2581
N.3	Effects of SUHD on Debug state .....	AppxN-2582

**Appendix O ARMv4 and ARMv5 Differences**

O.1	Introduction to ARMv4 and ARMv5 .....	AppxO-2588
O.2	Application level register support .....	AppxO-2589
O.3	Application level memory support .....	AppxO-2590
O.4	Instruction set support .....	AppxO-2595
O.5	System level register support .....	AppxO-2601
O.6	System level memory model .....	AppxO-2604
O.7	System Control coprocessor, CP15 support .....	AppxO-2612

**Appendix P Pseudocode Definition**

P.1	About the ARMv7 pseudocode .....	AppxP-2642
P.2	Pseudocode for instruction descriptions .....	AppxP-2643
P.3	Data types .....	AppxP-2645
P.4	Expressions .....	AppxP-2649
P.5	Operators and built-in functions .....	AppxP-2651
P.6	Statements and program structure .....	AppxP-2656
P.7	Miscellaneous helper procedures and functions .....	AppxP-2660

**Appendix Q Pseudocode Index**

Q.1	Pseudocode operators and keywords .....	AppxQ-2666
Q.2	Pseudocode functions and procedures .....	AppxQ-2669

**Appendix R Register Index**

R.1	Alphabetic index of ARMv7 registers, by register name .....	AppxR-2684
R.2	Full registers index .....	AppxR-2695

**Glossary**



# Preface

This preface introduces the *ARM® Architecture Reference Manual, ARM®v7-A and ARM®v7-R edition*. It contains the following sections:

- *About this manual* on page xiv
- *Using this manual* on page xvi
- *Conventions* on page xxi
- *Additional reading* on page xxiii
- *Feedback* on page xxiv.

## About this manual

This manual describes the A and R profiles of the ARM® architecture v7, ARMv7. It includes descriptions of:

- The processor instruction sets:
  - the original ARM instruction set
  - the high code density Thumb® instruction set
  - the ThumbEE instruction set, that includes specific support for *Just-In-Time* (JIT) or *Ahead-Of-Time* (AOT) compilation.
- The modes and states that determine how a processor operates, including the current execution privilege and security.
- The exception model.
- The memory model, that defines memory ordering and memory management:
  - the ARMv7-A architecture profile defines a *Virtual Memory System Architecture* (VMSA)
  - the ARMv7-R architecture profile defines a *Protected Memory System Architecture* (PMSA).
- The programmers' model, and its use of a coprocessor interface to access system control registers that control most processor and memory system features.
- The OPTIONAL *Floating-point* (VFP) Extension, that provides high-performance floating-point instructions that support:
  - single-precision and double-precision operations
  - conversions between double-precision, single-precision, and half-precision floating-point values.
- The OPTIONAL Advanced SIMD Extension, that provides high-performance integer and single-precision floating-point vector operations.
- The OPTIONAL Security Extensions, that facilitate the development of secure applications.
- The OPTIONAL Virtualization Extensions, that support the virtualization of Non-secure operation.
- The Debug architecture, that provides software access to debug features in the processor.

---

**Note**

ARMv7 introduces the architecture profiles. A separate Architecture Reference Manual describes the third profile, the Microcontroller profile, ARMv7-M. For more information see [Architecture versions, profiles, and variants on page A1-30](#).

---

This manual gives the assembler syntax for the instructions it describes, meaning it can specify instructions in textual form. However, this manual is not a tutorial for ARM assembler language, nor does it describe ARM assembler language, except at a very basic level. To make effective use of ARM assembler language, read the documentation supplied with the assembler being used.

This manual is organized into parts:

- Part A** Describes the application level view of the architecture. It describes the application level view of the programmers' model and the memory model. It also describes the precise effects of each instruction in *User mode*, the normal operating mode, including any restrictions on its use. This information is of primary importance to authors and users of compilers, assemblers, and other programs that generate ARM machine code. Software execution in User mode is at the PL0 privilege level, also described as *unprivileged*.

---

**Note**

User mode is the only mode where software execution is unprivileged.

---

- Part B** Describes the system level view of the architecture. It gives details of system registers, most of which are not accessible from PL0, and the system level view of the memory model. It also gives full details of the effects of instructions executed with some level of *privilege*, where these are different from their effects in unprivileged execution.
- Part C** Describes the Debug architecture. This is an extension to the ARM architecture that provides configuration, breakpoint and watchpoint support, and a *Debug Communications Channel* (DCC) to a debug host.
- Appendixes** Provide additional information that is not part of the ARMv7 architectural requirements, including descriptions of:
- features that are recommended but not required
  - differences in previous versions of the architecture.

## Using this manual

The information in this manual is organized into parts, as described in this section.

### Part A, Application Level Architecture

Part A describes the application level view of the architecture. It contains the following chapters:

#### **Chapter A1 *Introduction to the ARM Architecture***

Gives an overview of the ARM architecture, and the ARM and Thumb instruction sets.

#### **Chapter A2 *Application Level Programmers' Model***

Describes the application level view of the ARM programmers' model, including the application level view of the Advanced SIMD and Floating-point Extensions. It describes the types of values that ARM instructions operate on, the ARM core registers that contain those values, and the Application Program Status Register.

#### **Chapter A3 *Application Level Memory Model***

Describes the application level view of the memory model, including the ARM memory types and attributes, and memory access control.

#### **Chapter A4 *The Instruction Sets***

Describes the range of instructions available in the ARM, Thumb, Advanced SIMD, and VFP instruction sets. It also contains some details of instruction operation that are common to several instructions.

#### **Chapter A5 *ARM Instruction Set Encoding***

Describes the encoding of the ARM instruction set.

#### **Chapter A6 *Thumb Instruction Set Encoding***

Describes the encoding of the Thumb instruction set.

#### **Chapter A7 *Advanced SIMD and Floating-point Instruction Encoding***

Describes the encoding of the Advanced SIMD and Floating-point Extension (VFP) instruction sets.

#### **Chapter A8 *Instruction Details***

Gives a full description of every instruction available in the Thumb, ARM, Advanced SIMD, and Floating-point Extension instruction sets, with the exception of information only relevant to execution with some level of privilege.

#### **Chapter A9 *The ThumbEE Instruction Set***

Gives a full description of the Thumb Execution Environment variant of the Thumb instruction set. This means it describes the ThumbEE instruction set.

## Part B, System Level Architecture

Part B describes the system level view of the architecture. It contains the following chapters:

### Chapter B1 *The System Level Programmers' Model*

Describes the system level view of the programmers' model.

### Chapter B2 *Common Memory System Architecture Features*

Describes the system level view of the memory model features that are common to all memory systems.

### Chapter B3 *Virtual Memory System Architecture (VMSA)*

Describes the system level view of the *Virtual Memory System Architecture* (VMSA) that is part of all ARMv7-A implementations. This chapter includes a description of the organization and general properties of the system control registers in a VMSA implementation.

### Chapter B4 *System Control Registers in a VMSA implementation*

Describes all of the system control registers in VMSA implementation, including the registers that are part of the OPTIONAL extensions to a VMSA implementation. The registers are described in alphabetical order.

### Chapter B5 *Protected Memory System Architecture (PMSA)*

Describes the system level view of the *Protected Memory System Architecture* (PMSA) that is part of all ARMv7-R implementations. This chapter includes a description of the organization and general properties of the system control registers in a PMSA implementation.

### Chapter B6 *System Control Registers in a PMSA implementation*

Describes all of the system control registers in PMSA implementation, including the registers that are part of the OPTIONAL extensions to a PMSA implementation. The registers are described in alphabetical order.

### Chapter B7 *The CPUID Identification Scheme*

Describes the CPUID scheme. This provides registers that identify the architecture version and many features of the processor implementation. This chapter also describes the registers that identify the implemented Advanced SIMD and VFP features, if any.

### Chapter B8 *The Generic Timer*

Describes the OPTIONAL Generic Timer architecture extension.

### Chapter B9 *System Instructions*

Provides detailed reference information about system instructions, and more information about instructions that behave differently when executed with some level of privilege.

## Part C, Debug Architecture

Part C describes the Debug architecture. It contains the following chapters:

### Chapter C1 *Introduction to the ARM Debug Architecture*

Introduces the Debug architecture, defining the scope of this part of the manual.

### Chapter C2 *Invasive Debug Authentication*

Describes the authentication of invasive debug.

### Chapter C3 *Debug Events*

Describes the debug events.

#### **Chapter C4 *Debug Exceptions***

Describes the debug exceptions that handle debug events when the processor is configured for Monitor debug-mode.

#### **Chapter C5 *Debug State***

Describes Debug state that is entered if a debug event occurs when the processor is configured for Halting debug-mode.

#### **Chapter C6 *Debug Register Interfaces***

Describes the permitted debug register interfaces and the options for their implementation.

#### **Chapter C7 *Debug Reset and Powerdown Support***

Describes the reset and powerdown support in the Debug architecture, including support for debug over powerdown.

#### **Chapter C8 *The Debug Communications Channel and Instruction Transfer Register***

Describes the *Debug Communication Channel* (DCC) and *Instruction Transfer Register* (ITR), and how an external debugger uses these features to communicate with the debug logic.

#### **Chapter C9 *Non-invasive Debug Authentication***

Describes the authentication of non-invasive debug.

#### **Chapter C10 *Sample-based Profiling***

Describes sample-based profiling, that provides sampling of the program counter.

#### **Chapter C11 *The Debug Registers***

Describes the debug registers.

#### **Chapter C12 *The Performance Monitors Extension***

Describes the OPTIONAL Performance Monitors Extension.

### **Part D, Appendixes**

This manual contains the following appendixes:

#### **Appendix A *Recommended External Debug Interface***

Describes the recommended external interface to the ARM debug architecture.

———— **Note** —————

This description is not part of the ARM architecture specification. It is included here as supplementary information, for the convenience of developers and users who might require this information.

---

#### **Appendix B *Recommended Memory-mapped and External Debug Interfaces for the Performance Monitors***

Describes the recommended external interfaces to the Performance Monitors Extension.

———— **Note** —————

This description is not part of the ARM architecture specification. It is included here as supplementary information, for the convenience of developers and users who might require this information.

---

### **Appendix C Recommendations for Performance Monitors Event Numbers for IMPLEMENTATION DEFINED Events**

Gives the ARM recommendations for the use of the event numbers in the IMPLEMENTATION DEFINED event number space.

———— **Note** —————

This description is not part of the ARM architecture specification. It is included here as supplementary information, for the convenience of developers and users who might require this information.

---

### **Appendix D Example OS Save and Restore Sequences for External Debug Over Powerdown**

Gives software examples that perform the OS Save and Restore sequences, for v7 Debug and v7.1 Debug implementations.

———— **Note** —————

[Chapter C7 Debug Reset and Powerdown Support](#) describes the OS Save and Restore mechanism, for both v7 Debug and v7.1 Debug.

---

### **Appendix E System Level Implementation of the Generic Timer**

Contains the ARM Generic Timer architecture specification for the memory-mapped interface to the Generic Timer.

———— **Note** —————

This description is not part of the ARM architecture specification. It is included here as supplementary information, for the convenience of developers and users who might require this information.

---

### **Appendix F Common VFP Subarchitecture Specification**

Defines version 2 of the Common VFP Subarchitecture.

———— **Note** —————

This specification is not part of the ARM architecture specification. This sub-architectural information is included here as supplementary information, for the convenience of developers and users who might require this information.

---

### **Appendix G Barrier Litmus Tests**

Gives examples of the use of the barrier instructions provided by the ARMv7 architecture.

———— **Note** —————

These examples are not part of the ARM architecture specification. They are included here as supplementary information, for the convenience of developers and users who might require this information.

---

### **Appendix H Legacy Instruction Mnemonics**

Describes the legacy mnemonics and their Unified Assembler Language equivalents.

### **Appendix I Deprecated and Obsolete Features**

Lists the deprecated architectural features, with references to their descriptions in parts A to C of the manual.

### **Appendix J Fast Context Switch Extension (FCSE)**

Describes the *Fast Context Switch Extension* (FCSE). See the appendix for information about the status of this in different versions of the ARM architecture.

#### **Appendix K VFP Vector Operation Support**

Describes the VFP vector operations. ARM deprecates the use of these operations.

#### **Appendix L ARMv6 Differences**

Describes how the ARMv6 architecture differs from the description given in parts A and B of this manual.

#### **Appendix M v6 Debug and v6.1 Debug Differences**

Describes how the two debug architectures for ARMv6 differ from the description given in part C of this manual.

#### **Appendix N Secure User Halting Debug**

Describes the *Secure User halting debug* (SUHD) feature.

#### **Appendix O ARMv4 and ARMv5 Differences**

Describes how the ARMv4 and ARMv5 architectures differ from the description given in parts A and B of this manual.

#### **Appendix P Pseudocode Definition**

The formal definition of the pseudocode used in this manual.

#### **Appendix Q Pseudocode Index**

Gives indexes to definitions of pseudocode operators, keywords, functions, and procedures.

#### **Appendix R Register Index**

Gives indexes to register descriptions in the manual.



## Conventions

The following sections describe conventions that this book can use:

- *Typographic conventions*
- *Signals*
- *Numbers on page xxii*
- *Pseudocode descriptions on page xxii*
- *Assembler syntax descriptions on page xxii.*

### Typographic conventions

The typographical conventions are:

***italic*** Introduces special terminology, and denotes citations.

**bold** Denotes signal names, and is used for terms in descriptive lists, where appropriate.

**monospace** Used for assembler syntax descriptions, pseudocode, and source code examples.  
Also used in the main text for instruction mnemonics and for references to other items appearing in assembler syntax descriptions, pseudocode, and source code examples.

#### SMALL CAPITALS

Used in body text for a few terms that have specific technical meanings, and are defined in the *Glossary*.

**Colored text** Indicates a link. This can be:

- a URL, for example, <http://infocenter.arm.com>
- a cross-reference, that includes the page number of the referenced information if it is not on the current page, for example, *Pseudocode descriptions on page xxii*
- a link, to a chapter or appendix, or to a glossary entry, or to the section of the document that defines the colored term, for example *Simple sequential execution* or *SCTLR*.

#### ———— **Note** —————

Many links are to a register or instruction definition. Remember that:

- many system control registers are defined both in *Chapter B4 System Control Registers in a VMSA implementation* and in *Chapter B6 System Control Registers in a PMSA implementation*
- many instructions are defined in multiple forms, and in some cases the ARM encodings of an instruction are defined separately to the Thumb encodings.

Ensure that any linked definition you refer to is appropriate to your context.

---

## Signals

In general this specification does not define processor signals, but it does include some signal examples and recommendations. The signal conventions are:

**Signal level** The level of an asserted signal depends on whether the signal is active-HIGH or active-LOW. Asserted means:

- HIGH for active-HIGH signals
- LOW for active-LOW signals.

**Lower-case n** At the start or end of a signal name denotes an active-LOW signal.

## Numbers

Numbers are normally written in decimal. Binary numbers are preceded by `0b`, and hexadecimal numbers by `0x`. In both cases, the prefix and the associated value are written in a monospace font, for example `0xFFFF0000`.

## Pseudocode descriptions

This manual uses a form of pseudocode to provide precise descriptions of the specified functionality. This pseudocode is written in a monospace font, and is described in [Appendix P Pseudocode Definition](#).

## Assembler syntax descriptions

This manual contains numerous syntax descriptions for assembler instructions and for components of assembler instructions. These are shown in a monospace font, and use the conventions described in [Assembler syntax on page A8-283](#).

## Additional reading

This section lists relevant publications from ARM and third parties.

See the Infocenter, <http://infocenter.arm.com>, for access to ARM documentation.

### ARM publications

- *ARM® Debug Interface v5 Architecture Specification* (ARM IHI 0031).
- *ARM®v7-M Architecture Reference Manual* (ARM DDI 0403).
- *CoreSight™ Architecture Specification* (ARM IHI 0029).
- *ARM® Architecture Reference Manual* (ARM DDI 0100I).

#### ————— Note —————

- Issue I of the *ARM Architecture Reference Manual* (DDI 0100I) was issued in July 2005 and describes the first version of the ARMv6 architecture, and all previous architecture versions.
  - Addison-Wesley Professional publish *ARM Architecture Reference Manual, Second Edition* (December 27, 2000). The contents of this are identical to issue E of the *ARM Architecture Reference Manual* (DDI 0100E). It describes ARMv5TE and earlier versions of the ARM architecture, and is superseded by DDI 0100I.
- 
- *Embedded Trace Macrocell Architecture Specification* (ARM IHI 0014).
  - *CoreSight™ Program Flow Trace Architecture Specification* (ARM IHI 0035).
  - *ARM® Generic Interrupt Controller Architecture Specification* (ARM IHI 0048).

### Other publications

The following books are referred to in this manual, or provide more information:

- IEEE Std 1596.5-1993, *IEEE Standard for Shared-Data Formats Optimized for Scalable Coherent Interface (SCI) Processors*, ISBN 1-55937-354-7.
- IEEE Std 1149.1-2001, *IEEE Standard Test Access Port and Boundary Scan Architecture (JTAG)*.
- ANSI/IEEE Std 754-2008, and ANSI/IEEE Std 754-1985, *IEEE Standard for Binary Floating-Point Arithmetic*. See also [Floating-point standards, and terminology on page A2-55](#).
- JEDEC Solid State Technology Association, *Standard Manufacturer's Identification Code, JEP106*.
- *Tim Lindholm and Frank Yellin, The Java Virtual Machine Specification*, Second Edition, Addison Wesley, ISBN: 0-201-43294-3.
- *Kourosh Gharachorloo, Memory Consistency Models for Shared Memory-Multiprocessors*, 1995, Stanford University Technical Report CSL-TR-95-685.

## Feedback

ARM welcomes feedback on its documentation.

### Feedback on this manual

If you have comments on the content of this manual, send e-mail to [errata@arm.com](mailto:errata@arm.com). Give:

- the title
- the number, ARM DDI 0406C.b
- the page numbers to which your comments apply
- a concise explanation of your comments.

ARM also welcomes general suggestions for additions and improvements.

# Part A

## **Application Level Architecture**



# Chapter A1

## Introduction to the ARM Architecture

This chapter introduces the ARM architecture and contains the following sections:

- *About the ARM architecture* on page A1-28
- *The instruction sets* on page A1-29
- *Architecture versions, profiles, and variants* on page A1-30
- *Architecture extensions* on page A1-32
- *The ARM memory model* on page A1-35.

## A1.1 About the ARM architecture

The ARM architecture supports implementations across a wide range of performance points. The architectural simplicity of ARM processors leads to very small implementations, and small implementations mean devices can have very low power consumption. Implementation size, performance, and very low power consumption are key attributes of the ARM architecture.

The ARM architecture is a *Reduced Instruction Set Computer* (RISC) architecture, as it incorporates these RISC architecture features:

- a large uniform register file
- a *load/store* architecture, where data-processing operations only operate on register contents, not directly on memory contents
- simple addressing modes, with all load/store addresses being determined from register contents and instruction fields only.

In addition, the ARM architecture provides:

- instructions that combine a shift with an arithmetic or logical operation
- auto-increment and auto-decrement addressing modes to optimize program loops
- Load and Store Multiple instructions to maximize data throughput
- conditional execution of many instructions to maximize execution throughput.

These enhancements to a basic RISC architecture mean ARM processors achieve a good balance of high performance, small program size, low power consumption, and small silicon area.

This Architecture Reference Manual defines a set of behaviors to which an implementation must conform, and a set of rules for software to use the implementation. It does not describe how to build an implementation.

Except where the architecture specifies differently, the programmer-visible behavior of an implementation must be the same as a simple sequential execution of the program. This programmer-visible behavior does not include the execution time of the program.

The ARM architecture includes definitions of:

- An associated debug architecture, see [Debug architecture versions on page A1-31](#) and Part C of this manual.
- Associated trace architectures, that define trace macrocells that implementers can implement with the associated processor. For more information see the *Embedded Trace Macrocell Architecture Specification* and the *CoreSight Program Flow Trace Architecture Specification*.



## A1.2 The instruction sets

The ARM instruction set is a set of 32-bit instructions providing comprehensive data-processing and control functions.

The Thumb instruction set was developed as a 16-bit instruction set with a subset of the functionality of the ARM instruction set. It provides significantly improved code density, at a cost of some reduction in performance. A processor executing Thumb instructions can change to executing ARM instructions for performance critical segments, in particular for handling interrupts.

ARMv6T2 introduced Thumb-2 technology. This technology extends the original Thumb instruction set with many 32-bit instructions. The range of 32-bit Thumb instructions included in ARMv6T2 permits Thumb code to achieve performance similar to ARM code, with code density better than that of earlier Thumb code.

From ARMv6T2, the ARM and Thumb instruction sets provide almost identical functionality. For more information, see [Chapter A4 The Instruction Sets](#).

### A1.2.1 Execution environment support

Two additional instruction sets support execution environments:

- The architecture can provide hardware acceleration of Java bytecodes. For more information, see:
  - [Jazelle direct bytecode execution support on page A2-97](#), for application level information
  - [Jazelle direct bytecode execution on page B1-1240](#), for system level information.

The Virtualization Extensions do not support hardware acceleration of Java bytecodes. That is, they support only a trivial implementation of the Jazelle® extension.

- The ThumbEE instruction set is a variant of the Thumb instruction set that minimizes the code size overhead of a *Just-In-Time* (JIT) or *Ahead-Of-Time* (AOT) compiler. JIT and AOT compilers convert execution environment source code to a native executable. For more information, see:
  - [Thumb Execution Environment on page A2-95](#), for application level information
  - [Thumb Execution Environment on page B1-1239](#), for system level information.

From the publication of issue C.a of this manual, ARM deprecates any use of the ThumbEE instruction set.

## A1.3 Architecture versions, profiles, and variants

The ARM architecture has evolved significantly since its introduction, and ARM continues to develop it. Seven major versions of the architecture have been defined to date, denoted by the version numbers 1 to 7. Of these, the first three versions are now obsolete.

ARMv7 provides three profiles:

- ARMv7-A** Application profile, described in this manual:
- Implements a traditional ARM architecture with multiple modes.
  - Supports a *Virtual Memory System Architecture* (VMSA) based on a *Memory Management Unit* (MMU). An ARMv7-A implementation can be called a VMSAv7 implementation.
  - Supports the ARM and Thumb instruction sets.
- ARMv7-R** Real-time profile, described in this manual:
- Implements a traditional ARM architecture with multiple modes.
  - Supports a *Protected Memory System Architecture* (PMSA) based on a *Memory Protection Unit* (MPU). An ARMv7-R implementation can be called a PMSAv7 implementation.
  - Supports the ARM and Thumb instruction sets.
- ARMv7-M** Microcontroller profile, described in the *ARMv7-M Architecture Reference Manual*:
- Implements a programmers' model designed for low-latency interrupt processing, with hardware stacking of registers and support for writing interrupt handlers in high-level languages.
  - Implements a variant of the ARMv7 PMSA.
  - Supports a variant of the Thumb instruction set.

---

### Note

Parts A, B, and C of this Architecture Reference Manual describe the ARMv7-A and ARMv7-R profiles:

- Appendixes describe how the ARMv4-ARMv6 architecture versions differ from ARMv7.
- Separate Architecture Reference Manuals define the M-profile architectures, see [Additional reading on page xxiii](#).

---

Architecture versions can be qualified with variant letters to specify additional instructions and other functionality that are included as an architecture extension.

Some extensions are described separately instead of using a variant letter. For details of these extensions see [Architecture extensions on page A1-32](#).

The valid variants of ARMv4, ARMv5, and ARMv6 are as follows:

- ARMv4** The earliest architecture variant covered by this manual. It includes only the ARM instruction set.
- ARMv4T** Adds the Thumb instruction set.
- ARMv5T** Improves interworking of ARM and Thumb instructions. Adds Count Leading Zeros (CLZ) and software Breakpoint (BKPT) instructions.
- ARMv5TE** Enhances arithmetic support for *digital signal processing* (DSP) algorithms. Adds Preload Data (PLD), Load Register Dual (LDRD), Store Register Dual (STRD), and 64-bit coprocessor register transfer (MCRR, MRRC) instructions.
- ARMv5TEJ** Adds the BXJ instruction and other support for the Jazelle® architecture extension.
- ARMv6** Adds many new instructions to the ARM instruction set. Formalizes and revises the memory model and the Debug architecture.

- ARMv6K** Adds instructions to support multiprocessing to the ARM instruction set, and some extra memory model features.
- ARMv6T2** Introduces Thumb-2 technology, that supports a major development of the Thumb instruction set to provide a similar level of functionality to the ARM instruction set.

———— **Note** —————

Where appropriate, the terms ARMv6KZ or ARMv6Z describe the ARMv6K architecture with the ARMv6 Security Extensions, that were an OPTIONAL addition to the VMSAv6 architecture.

For detailed information about how earlier versions of the ARM architecture differ from ARMv7, see [Appendix L ARMv6 Differences](#) and [Appendix O ARMv4 and ARMv5 Differences](#).

The following architecture variants are now obsolete:

ARMv1, ARMv2, ARMv2a, ARMv3, ARMv3G, ARMv3M, ARMv4xM, ARMv4TxM, ARMv5, ARMv5xM, ARMv5TxM, and ARMv5TEp.

Contact ARM if you require details of obsolete variants.

Each instruction description in this manual specifies the architecture versions that include the instruction.

### A1.3.1 Debug architecture versions

Before ARMv6, the debug implementation for an ARM processor was IMPLEMENTATION DEFINED. ARMv6 defined the first debug architecture.

The debug architecture versions are:

- v6 Debug** Introduced with the original ARMv6 architecture definition.
- v6.1 Debug** Introduced to ARMv6K with the OPTIONAL Security Extensions, described in [Architecture extensions on page A1-33](#). A VMSAv6 implementation that includes the Security Extensions must implement v6.1 Debug.
- v7 Debug** First defined in issue A of this manual, and required by any ARMv7-R implementation  
An ARMv7-A implementation that does not include the Virtualization Extensions must implement either v7 Debug or v7.1 Debug.  
For more information about the Virtualization Extensions, see [Architecture extensions on page A1-33](#).
- v7.1 Debug** First defined in issue C.a of this manual, and required by any ARMv7-A implementation that includes the Virtualization Extensions.

For more information, see:

- [Chapter C1 Introduction to the ARM Debug Architecture](#), for v7 Debug and v7.1 Debug
- [About v6 Debug and v6.1 Debug on page AppxM-2548](#), for v6 Debug and v6.1 Debug.

———— **Note** —————

In this manual:

- debug usually refers to *invasive debug*, that permits modification of the state of the processor
- trace usually refers to *non-invasive debug*, that does not permit modification of the state of the processor.

For more information see [About the ARM Debug architecture on page C1-2021](#).

## A1.4 Architecture extensions

*Instruction set architecture extensions* summarizes the extensions that mainly affect the *Instruction Set Architecture* (ISA), either extending the instructions implemented in the ARM and Thumb instruction sets, or implementing an additional instruction set.

*Architecture extensions on page A1-33* describes other extensions to the architecture.

### A1.4.1 Instruction set architecture extensions

This manual describes the following extensions to the ISA:

- Jazelle** Is the Java bytecode execution extension that extended ARMv5TE to ARMv5TEJ. From ARMv6, the architecture requires at least the trivial Jazelle implementation, but a Jazelle implementation is still often described as a Jazelle extension.
- The Virtualization Extensions require that the Jazelle implementation is the trivial Jazelle implementation.
- ThumbEE** Is a variant of the Thumb instruction set that is designed as a target for dynamically generated code. In the original release of the ARMv7 architecture, ThumbEE was:
- A required extension to the ARMv7-A profile.
  - An optional extension to the ARMv7-R profile.
- From publication of issue C.a of this manual, ARM deprecates any use of ThumbEE instructions. However, ARMv7-A implementations must continue to include ThumbEE support, for backwards compatibility.
- Floating-point** Is a floating-point coprocessor extension to the instruction set architectures. For historic reasons, the Floating-point Extension is also called the *VFP Extension*. There have been the following versions of the Floating-point (VFP) Extension:
- VFPv1** Obsolete. Details are available on request from ARM.
- VFPv2** An optional extension to:
- the ARM instruction set in the ARMv5TE, ARMv5TEJ, ARMv6, and ARMv6K architectures
  - the ARM and Thumb instruction sets in the ARMv6T2 architecture.
- VFPv3** An OPTIONAL extension to the ARM, Thumb, and ThumbEE instruction sets in the ARMv7-A and ARMv7-R profiles.
- VFPv3 can be implemented with either thirty-two or sixteen doubleword registers, as described in *Advanced SIMD and Floating-point Extension registers on page A2-56*. Where necessary, the terms VFPv3-D32 and VFPv3-D16 distinguish between these two implementation options. Where the term VFPv3 is used it covers both options.
- VFPv3U is a variant of VFPv3 that supports the trapping of floating-point exceptions to support code, see *VFPv3U and VFPv4U on page A2-62*.
- VFPv3 with Half-precision Extension**
- VFPv3 and VFPv3U can be extended by the OPTIONAL Half-precision Extension, that provides conversion functions in both directions between half-precision floating-point and single-precision floating-point.
- VFPv4** An OPTIONAL extension to the ARM, Thumb, and ThumbEE instruction sets in the ARMv7-A and ARMv7-R profiles.
- VFPv4U is a variant of VFPv4 that supports the trapping of floating-point exceptions to support code, see *VFPv3U and VFPv4U on page A2-62*.

VFPv4 and VFPv4U add both the Half-precision Extension and the fused multiply-add instructions to the features of VFPv3. VFPv4 can be implemented with either thirty-two or sixteen doubleword registers, see [Advanced SIMD and Floating-point Extension registers on page A2-56](#). Where necessary, these implementation options are distinguished using the terms:

- VFPv4-D32, or VFPv4U-D32, for a thirty-two register implementation
- VFPv4-D16, or VFPv4U-D16, for a sixteen register implementation.

Where the term VFPv4 is used it covers both options.

If an implementation includes both the Floating-point and Advanced SIMD Extensions:

- It must implement the corresponding versions of the extensions:
  - if the implementation includes VFPv3 it must include Advanced SIMDv1
  - if the implementation includes VFPv3 with the Half-precision Extension it must include Advanced SIMDv1 with the half-precision extensions
  - if the implementation includes VFPv4 it must include Advanced SIMDv2.
- The two extensions use the same register bank. This means VFP must be implemented as VFPv3-D32, or as VFPv4-D32.
- Some instructions apply to both extensions.

**Advanced SIMD** Is an instruction set extension that provides *Single Instruction Multiple Data* (SIMD) integer and single-precision floating-point vector operations on doubleword and quadword registers. There have been the following versions of Advanced SIMD:

#### **Advanced SIMDv1**

It is an OPTIONAL extension to the ARMv7-A and ARMv7-R profiles.

#### **Advanced SIMDv1 with Half-precision Extension**

Advanced SIMDv1 can be extended by the OPTIONAL Half-precision Extension, that provides conversion functions in both directions between half-precision floating-point and single-precision floating-point.

#### **Advanced SIMDv2**

It is an OPTIONAL extension to the ARMv7-A and ARMv7-R profiles.

Advanced SIMDv2 adds both the Half-precision Extension and the fused multiply-add instructions to the features of Advanced SIMDv1.

See the description of the Floating-point Extension for more information about implementations that include both the Floating-point Extension and the Advanced SIMD Extension.

## **A1.4.2 Architecture extensions**

This manual also describes the following extensions to the ARMv7 architecture:

### **Security Extensions**

Are an OPTIONAL set of extensions to VMSAv6 implementations of the ARMv6K architecture, and to the ARMv7-A architecture profile, that provide a set of security features that facilitate the development of secure applications.

### **Multiprocessing Extensions**

Are an OPTIONAL set of extensions to the ARMv7-A and ARMv7-R profiles, that provides a set of features that enhance multiprocessing functionality.

### **Large Physical Address Extension**

Is an OPTIONAL extension to VMSAv7 that provides an address translation system supporting physical addresses of up to 40 bits at a fine grain of translation.

The Large Physical Address Extension requires implementation of the Multiprocessing Extensions.

### Virtualization Extensions

Are an OPTIONAL set of extensions to VMSAv7 that provides hardware support for virtualizing the Non-secure state of a VMSAv7 implementation. This supports system use of a virtual machine monitor, also called a hypervisor, to switch Guest operating systems.

The Virtualization Extensions require implementation of:

- the Security Extensions
- the Large Physical Address Extension
- the v7.1 Debug architecture, see *Scope of part C of this manual on page C1-2020*.

If an implementation that includes the Virtualization Extensions also implements:

- The Performance Monitors Extension, then it must implement version 2 of that extension, PMUv2, see *About the Performance Monitors on page C12-2300*.
- A trace macrocell, that trace macrocell must support the Virtualization Extensions. In particular, if the trace macrocell is:
  - an *Embedded Trace Macrocell* (ETM), the macrocell must implement ETMv3.5 or later, see the *Embedded Trace Macrocell Architecture Specification*
  - a *Program Trace Macrocell* (PTM), the macrocell must implement PFTv1.1 or later, see the *CoreSight Program Flow Trace Architecture Specification*.

In some tables in this manual, an ARMv7-A implementation that includes the Virtualization Extensions is described as ARMv7VE, or as v7VE.

### Generic Timer Extension

Is an OPTIONAL extension to any ARMv7-A or ARMv7-R, that provides a system timer, and a low-latency register interface to it.

This extension is introduced with the Large Physical Address Extension and Virtualization Extensions, but can be implemented with any earlier version of the ARMv7 architecture. The Generic Timer Extension does not require the implementation of any of the extensions described in this subsection.

For more information see [Chapter B8 The Generic Timer](#).

### Performance Monitors Extension

The ARMv7 architecture:

- reserves CP15 register space for IMPLEMENTATION DEFINED performance monitors
- defines a recommended performance monitors implementation.

From issue C.a of this manual, this recommended implementation is called the *Performance Monitors Extension*.

The Performance Monitors Extension does not require the implementation of any of the extensions described in this subsection.

If an ARMv7 implementation that includes v7.1 Debug also includes the Performance Monitors Extension, it must implement PMUv2.

For more information see [Chapter C12 The Performance Monitors Extension](#).

### ————— Note —————

The *Fast Context Switch Extension* (FCSE) is an older ARM extension, described in [Appendix J](#):

- ARM deprecates any use of this extension. This means in ARMv7 implementations before the introduction of the Multiprocessing Extensions, the FCSE is OPTIONAL and deprecated.
- The Multiprocessing Extensions obsolete the FCSE. This means that any processor that includes the Multiprocessing Extensions cannot include the FCSE. This includes all processors that implement the Large Physical Address Extension.

## A1.5 The ARM memory model

The ARM instruction sets address a single, flat address space of  $2^{32}$  8-bit bytes. This address space is also regarded as  $2^{30}$  32-bit words or  $2^{31}$  16-bit halfwords.

The architecture provides facilities for:

- generating an exception on an unaligned memory access
- restricting access by applications to specified areas of memory
- translating virtual addresses provided by executing instructions into physical addresses
- altering the interpretation of word and halfword data between big-endian and little-endian
- controlling the order of accesses to memory
- controlling caches
- synchronizing access to shared memory by multiple processors.

For more information, see:

- [Chapter A3 Application Level Memory Model](#)
- [Chapter B2 Common Memory System Architecture Features](#)
- [Chapter B3 Virtual Memory System Architecture \(VMSA\)](#)
- [Chapter B5 Protected Memory System Architecture \(PMSA\)](#).





# Chapter A2

## Application Level Programmers' Model

This chapter gives an application level view of the ARM programmers' model. It contains the following sections:

- *About the Application level programmers' model* on page A2-38
- *ARM core data types and arithmetic* on page A2-40
- *ARM core registers* on page A2-45
- *The Application Program Status Register (APSR)* on page A2-49
- *Execution state registers* on page A2-50
- *Advanced SIMD and Floating-point Extensions* on page A2-54
- *Floating-point data types and arithmetic* on page A2-63
- *Polynomial arithmetic over {0, 1}* on page A2-93
- *Coprocessor support* on page A2-94
- *Thumb Execution Environment* on page A2-95
- *Jazelle direct bytecode execution support* on page A2-97
- *Exceptions, debug events and checks* on page A2-102.

---

**Note**

In this chapter, system register names usually link to the description of the register in [Chapter B4 System Control Registers in a VMSA implementation](#), for example FPSCR. If the register is included in a PMSA implementation, then it is also described in [Chapter B6 System Control Registers in a PMSA implementation](#).

---

## A2.1 About the Application level programmers' model

This chapter contains the programmers' model information required for application development.

The information in this chapter is distinct from the system information required to service and support application execution under an operating system, or higher level of system software. However, some knowledge of that system information is needed to put the Application level programmers' model into context.

Depending on the implemented architecture extensions, the architecture supports multiple levels of execution privilege, that number upwards from PL0, where PL0 is the lowest privilege level and is often described as unprivileged. The Application level programmers' model is the programmers' model for software executing at PL0. For more information see [Processor privilege levels, execution privilege, and access privilege on page A3-141](#).

System software determines the privilege level at which application software runs. When an operating system supports execution at both PL1 and PL0, an application usually runs unprivileged. This:

- permits the operating system to allocate system resources to an application in a unique or shared manner
- provides a degree of protection from other processes and tasks, and so helps protect the operating system from malfunctioning applications.

This chapter indicates where some system level understanding is helpful, and if appropriate it gives a reference to the system level description in [Chapter B1 The System Level Programmers' Model](#), or elsewhere.

The Security Extensions extend the architecture to provide hardware security features that support the development of secure applications, by providing two Security states. The Virtualization Extensions further extend the architecture to provide virtualization of operation in Non-secure state. However, application level software is generally unaware of these extensions. For more information, see [The Security Extensions on page B1-1156](#) and [The Virtualization Extensions on page B1-1161](#).

### ———— Note —————

- When an implementation includes the Security Extensions, application and operating system software normally executes in Non-secure state.
- The virtualization features accessible only at PL2 are implemented only in Non-secure state. Secure state has only two privilege levels, PL0 and PL1.
- Older documentation, describing implementations or architecture versions that support only two privilege levels, often refers to execution at PL1 as *privileged* execution.
- In this manual, the following terms have special meanings, defined in the [Glossary](#):
  - IMPLEMENTATION DEFINED, see [IMPLEMENTATION DEFINED](#).
  - OPTIONAL, see [OPTIONAL](#).
  - SUBARCHITECTURE DEFINED, see [SUBARCHITECTURE DEFINED](#).
  - UNDEFINED, see [UNDEFINED](#).
  - UNKNOWN, see [UNKNOWN](#).
  - UNPREDICTABLE, see [UNPREDICTABLE](#).

## A2.1.1 Instruction sets, arithmetic operations, and register files

The ARM and Thumb instruction sets both provide a wide range of integer arithmetic and logical operations, that operate on register file of sixteen 32-bit registers, the *ARM core registers*. As described in *ARM core registers on page A2-45*, these registers include the special registers SP, LR, and PC. *ARM core data types and arithmetic on page A2-40* gives more information about these operations.

In addition, if an implementation includes:

- the Floating-point (VFP) Extension, the ARM and Thumb instruction sets include floating-point instructions
- the Advanced SIMD Extension, the ARM and Thumb instruction sets include vector instructions.

Floating-point and vector instructions operate on an independent register file, described in *Advanced SIMD and Floating-point Extension registers on page A2-56*. In an implementation that includes both of these extensions, they share a common register file. The following sections give more information about these extensions and the instructions they provide:

- *Advanced SIMD and Floating-point Extensions on page A2-54*
- *Floating-point data types and arithmetic on page A2-63*
- *Polynomial arithmetic over {0, 1} on page A2-93.*

## A2.2 ARM core data types and arithmetic

All ARMv7-A and ARMv7-R processors support the following data types in memory:

<b>Byte</b>	8 bits
<b>Halfword</b>	16 bits
<b>Word</b>	32 bits
<b>Doubleword</b>	64 bits.

Processor registers are 32 bits in size. The instruction set contains instructions supporting the following data types held in registers:

- 32-bit pointers
- unsigned or signed 32-bit integers
- unsigned 16-bit or 8-bit integers, held in zero-extended form
- signed 16-bit or 8-bit integers, held in sign-extended form
- two 16-bit integers packed into a register
- four 8-bit integers packed into a register
- unsigned or signed 64-bit integers held in two registers.

Load and store operations can transfer bytes, halfwords, or words to and from memory. Loads of bytes or halfwords zero-extend or sign-extend the data as it is loaded, as specified in the appropriate load instruction.

The instruction sets include load and store operations that transfer two or more words to and from memory. Software can load and store doublewords using these instructions.

———— **Note** —————

For information about the atomicity of memory accesses see [Atomicity in the ARM architecture on page A3-127](#).

When any of the data types is described as *unsigned*, the N-bit data value represents a non-negative integer in the range 0 to  $2^N-1$ , using normal binary format.

When any of these types is described as *signed*, the N-bit data value represents an integer in the range  $-2^{N-1}$  to  $+2^{N-1}-1$ , using two's complement format.

The instructions that operate on packed halfwords or bytes include some multiply instructions that use just one of two halfwords, and SIMD instructions that perform parallel addition or subtraction on all of the halfwords or bytes.

Direct instruction support for 64-bit integers is limited, and most 64-bit operations require sequences of two or more instructions to synthesize them.

## A2.2.1 Integer arithmetic

The instruction set provides a wide variety of operations on the values in registers, including bitwise logical operations, shifts, additions, subtractions, multiplications, and many others. The pseudocode described in [Appendix P Pseudocode Definition](#) defines these operations, usually in one of three ways:

- By direct use of the pseudocode operators and built-in functions defined in [Operators and built-in functions](#) on page AppxP-2651.
- By use of pseudocode helper functions defined in the main text. These can be located using the table in [Appendix Q Pseudocode Index](#).
- By a sequence of the form:
  1. Use of the SInt(), UInt(), and Int() built-in functions defined in [Converting bitstrings to integers](#) on page AppxP-2653 to convert the bitstring contents of the instruction operands to the unbounded integers that they represent as two's complement or unsigned integers.
  2. Use of mathematical operators, built-in functions and helper functions on those unbounded integers to calculate other such integers.
  3. Use of either the bitstring extraction operator defined in [Bitstring extraction](#) on page AppxP-2652 or of the saturation helper functions described in [Pseudocode details of saturation](#) on page A2-44 to convert an unbounded integer result into a bitstring result that can be written to a register.

### Shift and rotate operations

The following types of shift and rotate operations are used in instructions:

#### Logical Shift Left

(LSL) moves each bit of a bitstring left by a specified number of bits. Zeros are shifted in at the right end of the bitstring. Bits that are shifted off the left end of the bitstring are discarded, except that the last such bit can be produced as a carry output.

#### Logical Shift Right

(LSR) moves each bit of a bitstring right by a specified number of bits. Zeros are shifted in at the left end of the bitstring. Bits that are shifted off the right end of the bitstring are discarded, except that the last such bit can be produced as a carry output.

#### Arithmetic Shift Right

(ASR) moves each bit of a bitstring right by a specified number of bits. Copies of the leftmost bit are shifted in at the left end of the bitstring. Bits that are shifted off the right end of the bitstring are discarded, except that the last such bit can be produced as a carry output.

**Rotate Right** (ROR) moves each bit of a bitstring right by a specified number of bits. Each bit that is shifted off the right end of the bitstring is re-introduced at the left end. The last bit shifted off the right end of the bitstring can be produced as a carry output.

#### Rotate Right with Extend

(RRX) moves each bit of a bitstring right by one bit. A carry input is shifted in at the left end of the bitstring. The bit shifted off the right end of the bitstring can be produced as a carry output.

### Pseudocode details of shift and rotate operations

These shift and rotate operations are supported in pseudocode by the following functions:

```
// LSL_C()
// =====

(bits(N), bit) LSL_C(bits(N) x, integer shift)
    assert shift > 0;
    extended_x = x : Zeros(shift);
    result = extended_x<N-1:0>;
    carry_out = extended_x<N>;
```

```
    return (result, carry_out);
// LSL()
// =====

bits(N) LSL(bits(N) x, integer shift)
    assert shift >= 0;
    if shift == 0 then
        result = x;
    else
        (result, -) = LSL_C(x, shift);
    return result;

// LSR_C()
// =====

(bits(N), bit) LSR_C(bits(N) x, integer shift)
    assert shift > 0;
    extended_x = ZeroExtend(x, shift+N);
    result = extended_x<shift+N-1:shift>;
    carry_out = extended_x<shift-1>;
    return (result, carry_out);

// LSR()
// =====

bits(N) LSR(bits(N) x, integer shift)
    assert shift >= 0;
    if shift == 0 then
        result = x;
    else
        (result, -) = LSR_C(x, shift);
    return result;

// ASR_C()
// =====

(bits(N), bit) ASR_C(bits(N) x, integer shift)
    assert shift > 0;
    extended_x = SignExtend(x, shift+N);
    result = extended_x<shift+N-1:shift>;
    carry_out = extended_x<shift-1>;
    return (result, carry_out);

// ASR()
// =====

bits(N) ASR(bits(N) x, integer shift)
    assert shift >= 0;
    if shift == 0 then
        result = x;
    else
        (result, -) = ASR_C(x, shift);
    return result;

// ROR_C()
// =====

(bits(N), bit) ROR_C(bits(N) x, integer shift)
    assert shift != 0;
    m = shift MOD N;
    result = LSR(x,m) OR LSL(x,N-m);
    carry_out = result<N-1>;
    return (result, carry_out);
```

```
// ROR()
// =====

bits(N) ROR(bits(N) x, integer shift)
    if shift == 0 then
        result = x;
    else
        (result, -) = ROR_C(x, shift);
    return result;

// RRX_C()
// =====

(bits(N), bit) RRX_C(bits(N) x, bit carry_in)
    result = carry_in : x<N-1:1>;
    carry_out = x<0>;
    return (result, carry_out);

// RRX()
// =====

bits(N) RRX(bits(N) x, bit carry_in)
    (result, -) = RRX_C(x, carry_in);
    return result;
```

## Pseudocode details of addition and subtraction

In pseudocode, addition and subtraction can be performed on any combination of unbounded integers and bitstrings, provided that if they are performed on two bitstrings, the bitstrings must be identical in length. The result is another unbounded integer if both operands are unbounded integers, and a bitstring of the same length as the bitstring operand(s) otherwise. For the precise definition of these operations, see [Addition and subtraction on page AppxP-2654](#).

The main addition and subtraction instructions can produce status information about both unsigned carry and signed overflow conditions. When necessary, multi-word additions and subtractions are synthesized from this status information. In pseudocode the `AddWithCarry()` function provides an addition with a carry input and carry and overflow outputs:

```
// AddWithCarry()
// =====

(bits(N), bit, bit) AddWithCarry(bits(N) x, bits(N) y, bit carry_in)
    unsigned_sum = UInt(x) + UInt(y) + UInt(carry_in);
    signed_sum   = SInt(x) + SInt(y) + UInt(carry_in);
    result       = unsigned_sum<N-1:0>; // same value as signed_sum<N-1:0>
    carry_out    = if UInt(result) == unsigned_sum then '0' else '1';
    overflow     = if SInt(result) == signed_sum then '0' else '1';
    return (result, carry_out, overflow);
```

An important property of the `AddWithCarry()` function is that if:

```
(result, carry_out, overflow) = AddWithCarry(x, NOT(y), carry_in)
```

then:

- if `carry_in == '1'`, then `result == x-y` with:
  - `overflow == '1'` if signed overflow occurred during the subtraction
  - `carry_out == '1'` if unsigned borrow did not occur during the subtraction, that is, if  $x \geq y$
- if `carry_in == '0'`, then `result == x-y-1` with:
  - `overflow == '1'` if signed overflow occurred during the subtraction
  - `carry_out == '1'` if unsigned borrow did not occur during the subtraction, that is, if  $x > y$ .

Together, these mean that the `carry_in` and `carry_out` bits in `AddWithCarry()` calls can act as *NOT borrow* flags for subtractions as well as *carry* flags for additions.

## Pseudocode details of saturation

Some instructions perform *saturating arithmetic*, that is, if the result of the arithmetic overflows the destination signed or unsigned N-bit integer range, the result produced is the largest or smallest value in that range, rather than wrapping around modulo  $2^N$ . This is supported in pseudocode by:

- the SignedSatQ() and UnsignedSatQ() functions when an operation requires, in addition to the saturated result, a Boolean argument that indicates whether saturation occurred
- the SignedSat() and UnsignedSat() functions when only the saturated result is required.

```
// SignedSatQ()
// =====

(bits(N), boolean) SignedSatQ(integer i, integer N)
  if i > 2^(N-1) - 1 then
    result = 2^(N-1) - 1; saturated = TRUE;
  elsif i < -(2^(N-1)) then
    result = -(2^(N-1)); saturated = TRUE;
  else
    result = i; saturated = FALSE;
  return (result<N-1:0>, saturated);
// UnsignedSatQ()
// =====

(bits(N), boolean) UnsignedSatQ(integer i, integer N)
  if i > 2^N - 1 then
    result = 2^N - 1; saturated = TRUE;
  elsif i < 0 then
    result = 0; saturated = TRUE;
  else
    result = i; saturated = FALSE;
  return (result<N-1:0>, saturated);

// SignedSat()
// =====

bits(N) SignedSat(integer i, integer N)
  (result, -) = SignedSatQ(i, N);
  return result;

// UnsignedSat()
// =====

bits(N) UnsignedSat(integer i, integer N)
  (result, -) = UnsignedSatQ(i, N);
  return result;
```

SatQ(i, N, unsigned) returns either UnsignedSatQ(i, N) or SignedSatQ(i, N) depending on the value of its third argument, and Sat(i, N, unsigned) returns either UnsignedSat(i, N) or SignedSat(i, N) depending on the value of its third argument:

```
// SatQ()
// =====

(bits(N), boolean) SatQ(integer i, integer N, boolean unsigned)
  (result, sat) = if unsigned then UnsignedSatQ(i, N) else SignedSatQ(i, N);
  return (result, sat);
// Sat()
// =====

bits(N) Sat(integer i, integer N, boolean unsigned)
  result = if unsigned then UnsignedSat(i, N) else SignedSat(i, N);
  return result;
```



## A2.3 ARM core registers

In the application level view, an ARM processor has:

- thirteen general-purpose 32-bit registers, R0 to R12
- three 32-bit registers with special uses, SP, LR, and PC, that can be described as R13 to R15.

The special registers are:

### SP, the stack pointer

The processor uses SP as a pointer to the active stack.

In the Thumb instruction set, most instructions cannot access SP. The only instructions that can access SP are those designed to use SP as a stack pointer.

The ARM instruction set provides more general access to the SP, and it can be used as a general-purpose register. However, ARM deprecates the use of SP for any purpose other than as a stack pointer.

---

**Note**

---

Using SP for any purpose other than as a stack pointer is likely to break the requirements of operating systems, debuggers, and other software systems, causing them to malfunction.

Software can refer to SP as R13.

### LR, the link register

The link register is a special register that can hold return link information. Some cases described in this manual require this use of the LR. When software does not require the LR for linking, it can use it for other purposes. It can refer to LR as R14.

### PC, the program counter

- When executing an ARM instruction, PC reads as the address of the current instruction plus 8.
- When executing a Thumb instruction, PC reads as the address of the current instruction plus 4.
- Writing an address to PC causes a branch to that address.

Most Thumb instructions cannot access PC.

The ARM instruction set provides more general access to the PC, and many ARM instructions can use the PC as a general-purpose register. However, ARM deprecates the use of PC for any purpose other than as the program counter. See [Writing to the PC on page A2-46](#) for more information.

Software can refer to PC as R15.

See [ARM core registers on page B1-1143](#) for the system level view of these registers.

---

**Note**

---

In general, ARM strongly recommends using the names SP, LR and PC instead of R13, R14 and R15. However, sometimes it is simpler to use the R13-R15 names when referring to a group of registers. For example, it is simpler to refer to *Registers R8 to R15*, rather than *Registers R8 to R12, the SP, LR and PC*. These two descriptions of the group of registers have exactly the same meaning.

---

### A2.3.1 Writing to the PC

In ARMv7, many data-processing instructions can write to the PC. Writes to the PC are handled as follows:

- In Thumb state, the following 16-bit Thumb instruction encodings branch to the value written to the PC:
  - encoding T2 of *ADD (register, Thumb)* on page A8-310
  - encoding T1 of *MOV (register, Thumb)* on page A8-486.The value written to the PC is forced to be halfword-aligned by ignoring its least significant bit, treating that bit as being 0.
- The B, BL, CBNZ, CBZ, CHKA, HB, HBL, HBLP, HBP, TBB, and TBH instructions remain in the same instruction set state and branch to the value written to the PC.  
The definition of each of these instructions ensures that the value written to the PC is correctly aligned for the current instruction set state.
- The BLX (immediate) instruction switches between ARM and Thumb states and branches to the value written to the PC. Its definition ensures that the value written to the PC is correctly aligned for the new instruction set state.
- The following instructions write a value to the PC, treating that value as an interworking address to branch to, with low-order bits that determine the new instruction set state:
  - BLX (register), BX, and BXJ
  - LDR instructions with <Rt> equal to the PC
  - POP and all forms of LDM except LDM (exception return), when the register list includes the PC
  - in ARM state only, ADC, ADD, ADR, AND, ASR (immediate), BIC, EOR, LSL (immediate), LSR (immediate), MOV, MVN, ORR, ROR (immediate), RRX, RSB, RSC, SBC, and SUB instructions with <Rd> equal to the PC and without flag-setting specified.

For details of how an interworking address specifies the new instruction set state and instruction address, see [Pseudocode details of operations on ARM core registers on page A2-47](#).

#### ————— **Note** —————

- The register-shifted register instructions, that are available only in the ARM instruction set and are summarized in [Data-processing \(register-shifted register\) on page A5-198](#), cannot write to the PC.
- The LDR, POP, and LDM instructions first have interworking branch behavior in ARMv5T.
- The instructions listed as having interworking branch behavior in ARM state only first have this behavior in ARMv7.

In the cases where later versions of the architecture introduce interworking branch behavior, the behavior in earlier architecture versions is a branch that remains in the same instruction set state. For more information, see:

- [Interworking on page AppxL-2501](#), for ARMv6
- [Interworking on page AppxO-2589](#), for ARMv5 and ARMv4.

- 
- Some instructions are treated as exception return instructions, and write both the PC and the CPSR. For more information, including which instructions are exception return instructions, see [Exception return on page B1-1193](#).
  - Some instructions cause an exception, and the exception handler address is written to the PC as part of the exception entry. Similarly, in ThumbEE state, an instruction that fails its null check causes the address of the null check handler to be written to the PC, see [Null checking on page A9-1113](#).

### A2.3.2 Pseudocode details of operations on ARM core registers

In pseudocode, the uses of the R[] function are:

- reading or writing R0-R12, SP, and LR, using n == 0-12, 13, and 14 respectively
- reading the PC, using n == 15.

This function has prototypes:

```
bits(32) R[integer n]
    assert n >= 0 && n <= 15;
R[integer n] = bits(32) value
    assert n >= 0 && n <= 14;
```

*Pseudocode details of ARM core register operations on page B1-1144* explains the full operation of this function.

Descriptions of ARM store instructions that store the PC value use the PCStoreValue() pseudocode function to specify the PC value stored by the instruction:

```
// PCStoreValue()
// =====

bits(32) PCStoreValue()
    // This function returns the PC value. On architecture versions before ARMv7, it
    // is permitted to instead return PC+4, provided it does so consistently. It is
    // used only to describe ARM instructions, so it returns the address of the current
    // instruction plus 8 (normally) or 12 (when the alternative is permitted).
    return PC;
```

Writing an address to the PC causes either a simple branch to that address or an *interworking* branch that also selects the instruction set to execute after the branch. A simple branch is performed by the BranchWritePC() function:

```
// BranchWritePC()
// =====

BranchWritePC(bits(32) address)
    if CurrentInstrSet() == InstrSet_ARM then
        if ArchVersion() < 6 && address<1:0> != '00' then UNPREDICTABLE;
        BranchTo(address<31:2>:'00');
    elsif CurrentInstrSet() == InstrSet_Jazelle then
        if JazelleAcceptsExecution() then
            BranchTo(address<31:0>);
        else
            newaddress = address;
            newaddress<1:0> = bits(2) UNKNOWN;
            BranchTo(newaddress);
    else
        BranchTo(address<31:1>:'0');
```

An interworking branch is performed by the BXWritePC() function:

```
// BXWritePC()
// =====

BXWritePC(bits(32) address)
    if CurrentInstrSet() == InstrSet_ThumbEE then
        if address<0> == '1' then
            BranchTo(address<31:1>:'0'); // Remaining in ThumbEE state
        else
            UNPREDICTABLE;
    else
        if address<0> == '1' then
            SelectInstrSet(InstrSet_Thumb);
            BranchTo(address<31:1>:'0');
        elsif address<1> == '0' then
            SelectInstrSet(InstrSet_ARM);
            BranchTo(address);
        else // address<1:0> == '10'
```

UNPREDICTABLE;

The LoadWritePC() and ALUWritePC() functions are used for two cases where the behavior was systematically modified between architecture versions:

```
// LoadWritePC()
// =====

LoadWritePC(bits(32) address)
    if ArchVersion() >= 5 then
        BXWritePC(address);
    else
        BranchWritePC(address);
// ALUWritePC()
// =====

ALUWritePC(bits(32) address)
    if ArchVersion() >= 7 && CurrentInstrSet() == InstrSet_ARM then
        BXWritePC(address);
    else
        BranchWritePC(address);
```

———— **Note** ————

The behavior of the PC writes performed by the ALUWritePC() function is different in Debug state, where there are more UNPREDICTABLE cases. The pseudocode in this section only handles the non-debug cases. For more information, see [Behavior of Data-processing instructions that access the PC in Debug state](#) on page C5-2100.

## A2.4 The Application Program Status Register (APSR)

Program status is reported in the 32-bit *Application Program Status Register* (APSR). The APSR bit assignments are:

31	30	29	28	27	26	24	23	20	19	16	15							0		
N	Z	C	V	Q	RAZ/ SBZP	Reserved, UNK/SBZP			GE[3:0]		Reserved, UNK/SBZP									

The APSR bit categories are:

- Reserved bits, that are allocated to system features, or are available for future expansion. Unprivileged execution ignores writes to fields that are accessible only at PL1 or higher. However, application level software that writes to the APSR must treat reserved bits as *Do-Not-Modify* (DNM) bits. For more information about the reserved bits, see [Format of the CPSR and SPSRs on page B1-1148](#).
- Bits that can be set by many instructions:
  - The Condition flags:
    - N, bit[31]** Negative condition flag. Set to bit[31] of the result of the instruction. If the result is regarded as a two's complement signed integer, then the processor sets N to 1 if the result is negative, and sets N to 0 if it is positive or zero.
    - Z, bit[30]** Zero condition flag. Set to 1 if the result of the instruction is zero, and to 0 otherwise. A result of zero often indicates an equal result from a comparison.
    - C, bit[29]** Carry condition flag. Set to 1 if the instruction results in a carry condition, for example an unsigned overflow on an addition.
    - V, bit[28]** Overflow condition flag. Set to 1 if the instruction results in an overflow condition, for example a signed overflow on an addition.
  - The Overflow or saturation flag:
    - Q, bit[27]** Set to 1 to indicate overflow or saturation occurred in some instructions, normally related to *digital signal processing* (DSP). For more information, see [Pseudocode details of saturation on page A2-44](#).
  - The Greater than or Equal flags:
    - GE[3:0], bits[19:16]**  
The instructions described in [Parallel addition and subtraction instructions on page A4-171](#) update these flags to indicate the results from individual bytes or halfwords of the operation. These flags can control a later SEL instruction. For more information, see [SEL on page A8-602](#).
- Bits[26:24] are RAZ/SBZP. Therefore, software can use MSR instructions that write the top byte of the APSR without using a read, modify, write sequence. If it does this, it must write zeros to bits[26:24].

Instructions can test the N, Z, C, and V condition flags, combining these with the *condition code* for the instruction to determine whether the instruction must be executed. In this way, execution of the instruction is conditional on the result of a previous operation. For more information about conditional execution see [Conditional execution on page A4-161](#) and [Conditional execution on page A8-288](#).

In ARMv7-A and ARMv7-R, the APSR is the same register as the *CPSR*, but the APSR must be used only to access the N, Z, C, V, Q, and GE[3:0] bits. For more information, see [Program Status Registers \(PSRs\) on page B1-1147](#).

## A2.5 Execution state registers

The execution state registers modify the execution of instructions. They control:

- Whether instructions are interpreted as Thumb instructions, ARM instructions, ThumbEE instructions, or Java bytecodes. For more information, see [Instruction set state register, ISETSTATE](#).
- In Thumb state and ThumbEE state only, the condition codes that apply to the next one to four instructions. For more information, see [IT block state register, ITSTATE](#) on page A2-51.
- Whether data is interpreted as big-endian or little-endian. For more information, see [Endianness mapping register, ENDIANSTATE](#) on page A2-53.

In ARMv7-A and ARMv7-R, the execution state registers are part of the Current Program Status Register. For more information, see [Program Status Registers \(PSRs\)](#) on page B1-1147.

There is no direct access to the execution state registers from application level instructions, but they can be changed by side-effects of application level instructions.

### A2.5.1 Instruction set state register, ISETSTATE

The instruction set state register, ISETSTATE, format is:



The J bit and the T bit determine the current *instruction set state* for the processor. [Table A2-1](#) shows the encoding of these bits.

**Table A2-1 J and T bit encoding in ISETSTATE**

J	T	Instruction set state
0	0	ARM
0	1	Thumb
1	0	Jazelle
1	1	ThumbEE

<b>ARM state</b>	The processor executes the ARM instruction set described in <a href="#">Chapter A5 ARM Instruction Set Encoding</a> .
<b>Thumb state</b>	The processor executes the Thumb instruction set as described in <a href="#">Chapter A6 Thumb Instruction Set Encoding</a> .
<b>Jazelle state</b>	The processor executes Java bytecodes as part of a <i>Java Virtual Machine</i> (JVM). For more information, see: <ul style="list-style-type: none"> <li>• <a href="#">Jazelle direct bytecode execution support</a> on page A2-97, for application level information</li> <li>• <a href="#">Jazelle direct bytecode execution</a> on page B1-1240, for system level information.</li> </ul>
<b>ThumbEE state</b>	The processor executes a variation of the Thumb instruction set specifically targeted for use with dynamic compilation techniques associated with an execution environment. This can be Java or other execution environments. This feature is required in ARMv7-A, and optional in ARMv7-R. For more information, see: <ul style="list-style-type: none"> <li>• <a href="#">Thumb Execution Environment</a> on page A2-95, for application level information</li> <li>• <a href="#">Thumb Execution Environment</a> on page B1-1239, for system level information.</li> </ul>

## Pseudocode details of ISETSTATE operations

The following pseudocode functions return the current instruction set and select a new instruction set:

```

enumeration InstrSet {InstrSet_ARM, InstrSet_Thumb, InstrSet_Jazelle, InstrSet_ThumbEE};
// CurrentInstrSet()
// =====

InstrSet CurrentInstrSet()
    case ISETSTATE of
        when '00' result = InstrSet_ARM;
        when '01' result = InstrSet_Thumb;
        when '10' result = InstrSet_Jazelle;
        when '11' result = InstrSet_ThumbEE;
    return result;

// SelectInstrSet()
// =====

SelectInstrSet(InstrSet iset)
    case iset of
        when InstrSet_ARM
            if CurrentInstrSet() == InstrSet_ThumbEE then
                UNPREDICTABLE;
            else
                ISETSTATE = '00';
        when InstrSet_Thumb
            ISETSTATE = '01';
        when InstrSet_Jazelle
            ISETSTATE = '10';
        when InstrSet_ThumbEE
            ISETSTATE = '11';
    return;

```

### A2.5.2 IT block state register, ITSTATE

The IT block state register, ITSTATE, format is:

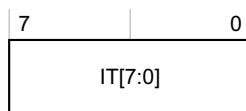

This field holds the If-Then execution state bits for the Thumb IT instruction, that applies to the *IT block* of one to four instructions that immediately follow the IT instruction. See [IT on page A8-390](#) for a description of the IT instruction and the associated IT block.

ITSTATE divides into two subfields:

**IT[7:5]** Holds the *base condition* for the current IT block. The base condition is the top 3 bits of the condition code specified by the <firstcond> field of the IT instruction.

This subfield is 0b000 when no IT block is active.

**IT[4:0]** Encodes:

- The size of the IT block. This is the number of instructions that are to be conditionally executed. The size of the block is implied by the position of the least significant 1 in this field, as shown in [Table A2-2 on page A2-52](#).
- The value of the least significant bit of the condition code for each instruction in the block.

**Note**

Changing the value of the least significant bit of a condition code from 0 to 1 has the effect of inverting the condition code.

This subfield is 0b00000 when no IT block is active.

When an IT instruction is executed, these bits are set according to the <firstcond> condition code in the instruction, and the *Then* and *Else* (T and E) parameters in the instruction. For more information, see *IT* on page A8-390.

When permitted, an instruction in an IT block is conditional, see *Conditional instructions* on page A4-162 and *Conditional execution* on page A8-288. The condition code used is the current value of IT[7:4]. When an instruction in an IT block completes its execution normally, ITSTATE advances to the next line of Table A2-2. A few instructions, for example BKPT, cannot be conditional and therefore are always executed, ignoring the current ITSTATE.

For details of what happens if an instruction in an IT block:

- Takes an exception see *Overview of exception entry* on page B1-1170.
- In ThumbEE state, causes a branch to a check handler, see *IT block and check handlers* on page A9-1114.

An instruction that might complete its normal execution by branching is only permitted in an IT block as the last instruction in the block. This means that normal execution of the instruction always results in ITSTATE advancing to normal execution.

**Table A2-2 Effect of IT execution state bits**

	IT bits <sup>a</sup>					Note
	[7:5]	[4]	[3]	[2]	[1]	
cond_base	P1	P2	P3	P4	1	Entry point for 4-instruction IT block
cond_base	P1	P2	P3	1	0	Entry point for 3-instruction IT block
cond_base	P1	P2	1	0	0	Entry point for 2-instruction IT block
cond_base	P1	1	0	0	0	Entry point for 1-instruction IT block
000	0	0	0	0	0	Normal execution, not in an IT block

a. Combinations of the IT bits not shown in this table are reserved.

On a branch or an exception return, if ITSTATE is set to a value that is not consistent with the instruction stream being branched to or returned to, then instruction execution is UNPREDICTABLE.

ITSTATE affects instruction execution only in Thumb and ThumbEE states. In ARM and Jazelle states, ITSTATE must be '00000000', otherwise the behavior is UNPREDICTABLE.

### Pseudocode details of ITSTATE operations

ITSTATE advances after normal execution of an IT block instruction. This is described by the ITAdvance() pseudocode function:

```
// ITAdvance()
// =====

ITAdvance()
    if ITSTATE<2:0> == '000' then
        ITSTATE.IT = '00000000';
    else
        ITSTATE.IT<4:0> = LSL(ITSTATE.IT<4:0>, 1);
```

The following functions test whether the current instruction is in an IT block, and whether it is the last instruction of an IT block:

```
// InITBlock()
// =====

boolean InITBlock()
    return (ITSTATE.IT<3:0> != '0000');
```



```
// LastInITBlock()
// =====

boolean LastInITBlock()
    return (ITSTATE.IT<3:0> == '1000');
```

### A2.5.3 Endianness mapping register, ENDIANSTATE

ARMv7-A and ARMv7-R support configuration between little-endian and big-endian interpretations of data memory, as shown in [Table A2-3](#). The endianness is controlled by ENDIANSTATE.

**Table A2-3 ENDIANSTATE encoding of endianness**

ENDIANSTATE	Endian mapping
0	Little-endian
1	Big-endian

The ARM and Thumb instruction sets both include an instruction to manipulate ENDIANSTATE:

SETEND BE     Sets ENDIANSTATE to 1, for big-endian operation.  
SETEND LE     Sets ENDIANSTATE to 0, for little-endian operation.

The SETEND instruction is unconditional. For more information, see [SETEND on page A8-604](#).

#### Pseudocode details of ENDIANSTATE operations

The BigEndian() pseudocode function tests whether big-endian memory accesses are currently selected.

```
// BigEndian()
// =====

boolean BigEndian()
    return (ENDIANSTATE == '1');
```

## A2.6 Advanced SIMD and Floating-point Extensions

Advanced SIMD and Floating-point (VFP) are two OPTIONAL extensions to ARMv7.

The Advanced SIMD Extension performs packed *Single Instruction Multiple Data* (SIMD) operations, either integer or single-precision floating-point. The Floating-point Extension performs single-precision or double-precision floating-point operations.

Both extensions permit *floating-point exceptions*, such as overflow or division by zero, to be handled without trapping. When handled in this way, a floating-point exception causes a cumulative status register bit to be set to 1 and a default result to be produced by the operation.

The ARMv7 Floating-point Extension implementation can be VFPv3 or VFPv4, see [Architecture extensions on page A1-32](#). ARMv7 also defines variants of VFPv3 and VFPv4, VFPv3U and VFPv4U, that support the trapping of floating-point exceptions, see [VFPv3U and VFPv4U on page A2-62](#). VFPv2 also supports the trapping of floating-point exceptions.

The Advanced SIMD implementation can be Advanced SIMDv1 or Advanced SIMDv2.

If an implementation includes both the Advanced SIMD and the Floating-point Extensions then the versions of the two extensions must align, as described in [Instruction set architecture extensions on page A1-32](#).

For more information about floating-point exceptions see [Floating-point exceptions on page A2-70](#).

Each version of these extensions can be implemented at a number of levels. [Table A2-4](#) shows the permitted combinations of implementations of the two extensions.

**Table A2-4 Permitted combinations of Advanced SIMD and Floating-point Extensions**

Advanced SIMD	Floating-point (VFP)
Not implemented	Not implemented
Integer only	Not implemented
Integer and single-precision floating-point	Single-precision floating-point only <sup>a</sup>
Integer and single-precision floating-point	Single-precision and double-precision floating-point
Not implemented	Single-precision floating-point only <sup>a</sup>
Not implemented	Single-precision and double-precision floating-point

a. Must be able to load and store double-precision data using the bottom 16 double-precision registers, D0-D15.

The Half-precision Extension provides conversion functions in both directions between half-precision floating-point and single-precision floating-point. This extension:

- Can be implemented with any Advanced SIMDv1 or VFPv3 implementation that supports single-precision floating-point, and the Half-precision extension applies to both VFP and Advanced SIMD if they are both implemented.
- Is included in any Advanced SIMDv2 or VFPv4 implementation that supports single-precision floating-point.

For system level information about the Advanced SIMD and Floating-point Extensions see [Advanced SIMD and floating-point support on page B1-1228](#).

———— **Note** ————

Before ARMv7, the Floating-point Extension was called the *Vector Floating-point Architecture*, and was used for vector operations. For details of these deprecated operations see [Appendix K VFP Vector Operation Support](#). In ARMv7:

- ARM recommends that the Advanced SIMD Extension is used for single-precision vector floating-point operations.
- An implementation that requires support for vector operations must implement the Advanced SIMD Extension.

## A2.6.1 Floating-point standards, and terminology

The ARM floating-point implementation includes support for all the required features of ANSI/IEEE Std 754-2008, *IEEE Standard for Binary Floating-Point Arithmetic*, referred to as IEEE 754-2008. However, the original implementation was based on the 1985 version of this standard, referred to as IEEE 754-1985. In this manual:

- Floating-point terminology generally uses the IEEE 754-1985 terms. This section summarizes how IEEE 754-2008 changes these terms.
- References to IEEE 754 that do not include the issue year apply to either issue of the standard.

[Table A2-5](#) shows how the terminology in this manual differs from that used in IEEE 754-2008.

**Table A2-5 Floating-point terminology**

This manual, based on IEEE 754-1985 <sup>a</sup>	IEEE 754-2008
Normalized	Normal
Denormal, or denormalized	Subnormal
Round towards Minus Infinity	roundTowardsNegative
Round towards Plus Infinity	roundTowardsPositive
Round to Zero	roundTowardZero
Round towards Nearest	roundTiesToEven
Rounding mode	Rounding-direction attribute

a. Except that *normalized number* is used in preference to *normal number*, because of the other specific uses of *normal* in this manual.

The fused multiply add operations are first defined in IEEE 754-2008, and are introduced in VFPv4 and Advanced SIMDv2. The following sections describe the instructions that perform these operations:

- [VFMA, VFMS on page A8-892](#)
- [VFNMA, VFNMS on page A8-894](#).

All other ARMv7 floating-point operations are defined in both issues of IEEE 754.

———— **Note** ————

ARMv7 does not support the IEEE 754-2008 roundTiesToAway rounding mode. However, IEEE 754-compliance does not require support for this mode.

## A2.6.2 Advanced SIMD and Floating-point Extension registers

From VFPv3, the Advanced SIMD and Floating-point (VFP) Extensions use the same register set. This is distinct from the ARM core register set. These registers are generally referred to as the *extension registers*.

The extension register set consists of either thirty-two or sixteen doubleword registers, as follows:

- If VFPv2 is implemented, it consists of sixteen doubleword registers.
- If VFPv3 is implemented, it consists of either thirty-two or sixteen doubleword registers. Where necessary, these two implementation options are distinguished using the terms:
  - VFPv3-D32, for an implementation with thirty-two doubleword registers
  - VFPv3-D16, for an implementation with sixteen doubleword registers.
- If VFPv4 is implemented, it consists of either thirty-two or sixteen doubleword registers. Where necessary, these two implementation options are distinguished using the terms:
  - VFPv4-D32, for an implementation with thirty-two doubleword registers
  - VFPv4-D16, for an implementation with sixteen doubleword registers.
- If Advanced SIMD is implemented, it consists of thirty-two doubleword registers.
- If Advanced SIMD and Floating-point are both implemented, Floating-point must be implemented as VFPv3-D32 or VFPv4-D32.

The Advanced SIMD and Floating-point views of the extension register set are not identical. The following sections describe these different views.

Figure A2-1 on page A2-57 shows the views of the extension register set, and the way the word, doubleword, and quadword registers overlap.

### Advanced SIMD views of the extension register set

Advanced SIMD can view this register set as:

- Sixteen 128-bit quadword registers, Q0-Q15.
- Thirty-two 64-bit doubleword registers, D0-D31. This view is also available in VFPv3-D32 and VFPv4-D32.

These views can be used simultaneously. For example, a program might hold 64-bit vectors in D0 and D1 and a 128-bit vector in Q1.

### Floating-point views of the extension register set

In VFPv4-D32 or VFPv3-D32, the extension register set consists of thirty-two doubleword registers, that VFP can view as:

- Thirty-two 64-bit doubleword registers, D0-D31. This view is also available in Advanced SIMD.
- Thirty-two 32-bit single word registers, S0-S31. Only half of the set is accessible in this view.

In VFPv4-D16, VFPv3-D16, and VFPv2, the extension register set consists of sixteen doubleword registers, that VFP can view as:

- Sixteen 64-bit doubleword registers, D0-D15.
- Thirty-two 32-bit single word registers, S0-S31.

In each case, the two views can be used simultaneously.

## Advanced SIMD and Floating-point register mapping

Figure A2-1 shows the different views of Advanced SIMD and Floating-point register banks, and the relationship between them.

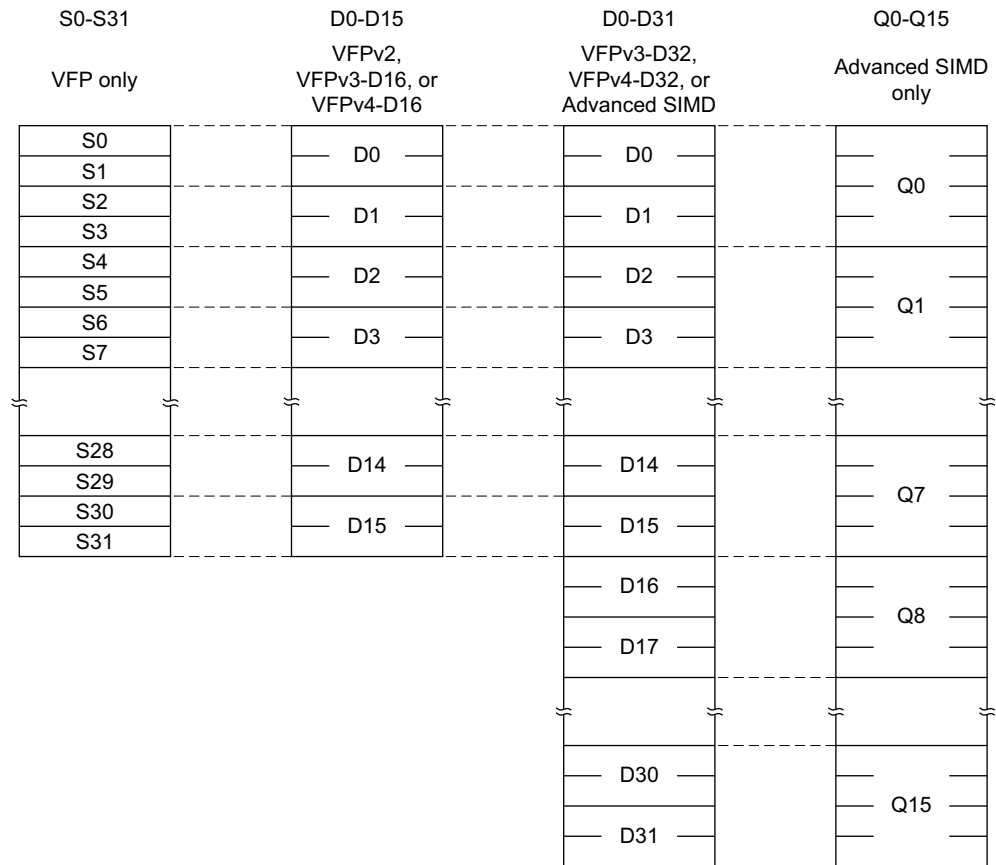

Figure A2-1 Advanced SIMD and Floating-point Extensions register set

The mapping between the registers is as follows:

- $S_{\langle 2n \rangle}$  maps to the least significant half of  $D_{\langle n \rangle}$
- $S_{\langle 2n+1 \rangle}$  maps to the most significant half of  $D_{\langle n \rangle}$
- $D_{\langle 2n \rangle}$  maps to the least significant half of  $Q_{\langle n \rangle}$
- $D_{\langle 2n+1 \rangle}$  maps to the most significant half of  $Q_{\langle n \rangle}$ .

For example, software can access the least significant half of the elements of a vector in  $Q_6$  by referring to  $D_{12}$ , and the most significant half of the elements by referring to  $D_{13}$ .

### Pseudocode details of Advanced SIMD and Floating-point Extension registers

The pseudocode function `VFPsmallRegisterBank()` returns `FALSE` if all of the 32 registers  $D_0$ - $D_{31}$  can be accessed, and `TRUE` if only the 16 registers  $D_0$ - $D_{15}$  can be accessed:

```
boolean VFPsmallRegisterBank()
```

In more detail, `VFPsmallRegisterBank()`:

- returns `TRUE` for a VFPv2, VFPv3-D16, or VFPv4-D16 implementation
- for a VFPv3-D32 or VFPv4-D32 implementation:
  - returns `FALSE` if `CPACR.D32DIS` is set to 0
  - returns `TRUE` if `CPACR.D32DIS` and `CPACR.ASEDIS` are both set to 1
  - results in UNPREDICTABLE behavior if `CPACR.D32DIS` is set to 1 and `CPACR.ASEDIS` is set to 0.

For details of the CPACR, see either:

- CPACR, Coprocessor Access Control Register, VMSA on page B4-1551
- CPACR, Coprocessor Access Control Register, PMSA on page B6-1829.

The following functions provide the S0-S31, D0-D31, and Q0-Q15 views of the registers:

```
// The 64-bit extension register bank for Advanced SIMD and VFP.
```

```
array bits(64) _D[0..31];
```

```
// Clone the 64-bit Advanced SIMD and VFP extension register bank for use as input to  
// instruction pseudocode, to avoid read-after-write for Advanced SIMD and VFP operations.
```

```
array bits(64) _Dclone[0..31];
```

```
// S[] - non-assignment form  
// =====
```

```
bits(32) S[integer n]  
  assert n >= 0 && n <= 31;  
  if (n MOD 2) == 0 then  
    result = D[n DIV 2]<31:0>;  
  else  
    result = D[n DIV 2]<63:32>;  
  return result;
```

```
// S[] - assignment form  
// =====
```

```
S[integer n] = bits(32) value  
  assert n >= 0 && n <= 31;  
  if (n MOD 2) == 0 then  
    D[n DIV 2]<31:0> = value;  
  else  
    D[n DIV 2]<63:32> = value;  
  return;
```

```
// D[] - non-assignment form  
// =====
```

```
bits(64) D[integer n]  
  assert n >= 0 && n <= 31;  
  if n >= 16 && VFPSmallRegisterBank() then UNDEFINED;  
  return _D[n];
```

```
// D[] - assignment form  
// =====
```

```
D[integer n] = bits(64) value  
  assert n >= 0 && n <= 31;  
  if n >= 16 && VFPSmallRegisterBank() then UNDEFINED;  
  _D[n] = value;  
  return;
```

```
// Q[] - non-assignment form  
// =====
```

```
bits(128) Q[integer n]  
  assert n >= 0 && n <= 15;  
  return D[2*n+1]:D[2*n];
```

```
// Q[] - assignment form
// =====

Q[integer n] = bits(128) value
    assert n >= 0 && n <= 15;
    D[2*n] = value<63:0>;
    D[2*n+1] = value<127:64>;
    return;
```

The `Din[]` function returns a Doubleword register from the `_Dclone[]` copy of the Advanced SIMD and Floating-point register bank, and the `Qin[]` function returns a Quadword register from that register bank.

————— **Note** —————

The `CheckAdvancedSIMDEnabled()` function copies the `_D[]` register bank to `_Dclone[]`, see [Pseudocode details of enabling the Advanced SIMD and Floating-point Extensions on page B1-1234](#).

```
// Din[] - non-assignment form
// =====

bits(64) Din[integer n]
    assert n >= 0 && n <= 31;
    if n >= 16 && VFPSmallRegisterBank() then UNDEFINED;
    return _Dclone[n];

// Qin[] - non-assignment form
// =====

bits(128) Qin[integer n]
    assert n >= 0 && n <= 15;
    return Din[2*n+1]:Din[2*n];
```

### A2.6.3 Data types supported by the Advanced SIMD Extension

In an implementation that includes the Advanced SIMD Extension, the Advanced SIMD instructions can operate on integer and floating-point data, and the extension defines a set of data types to represent the different data formats. [Table A2-6](#) shows the available formats. Each instruction description specifies the data types that the instruction supports.

**Table A2-6 Advanced SIMD data types**

Data type specifier	Meaning
.<size>	Any element of <size> bits
.F<size>	Floating-point number of <size> bits
.I<size>	Signed or unsigned integer of <size> bits
.P<size>	Polynomial over {0, 1} of degree less than <size>
.S<size>	Signed integer of <size> bits
.U<size>	Unsigned integer of <size> bits

[Polynomial arithmetic over {0, 1} on page A2-93](#) describes the polynomial data type.

The `.F16` data type is the half-precision data type selected by the `FPSCR.AHP` bit. It is supported only if an implementation includes the Half-precision extension.

The `.F32` data type is the ARM standard single-precision floating-point data type, see [Advanced SIMD and Floating-point single-precision format on page A2-64](#).

The instruction definitions use a data type specifier to define the data types appropriate to the operation. Figure A2-2 shows the hierarchy of Advanced SIMD data types.

.8	.i8	.S8
		.U8
	.P8	
	-	
.16	.i16	.S16
		.U16
	.P16 †	
	.F16 ‡	
.32	.i32	.S32
		.U32
	-	
	.F32	
.64	.i64	.S64
		.U64
	-	
	-	

† Output format only. See VMULL instruction description.

‡ Supported only if the implementation includes the Half-precision Extension.

**Figure A2-2 Advanced SIMD data type hierarchy**

For example, a multiply instruction must distinguish between integer and floating-point data types.

An integer multiply instruction that generates a double-width (long) result must specify the input data types as signed or unsigned. However, some integer multiply instructions use modulo arithmetic, and therefore do not have to distinguish between signed and unsigned inputs.

#### A2.6.4 Advanced SIMD vectors

In an implementation that includes the Advanced SIMD Extension, a register can hold one or more packed elements, all of the same size and type. The combination of a register and a data type describes a vector of elements. The vector is considered to be an array of elements of the data type specified in the instruction. The number of elements in the vector is implied by the size of the data elements and the size of the register.

Vector indices are in the range 0 to (number of elements – 1). An index of 0 refers to the least significant end of the vector. Figure A2-3 on page A2-61 shows examples of Advanced SIMD vectors:



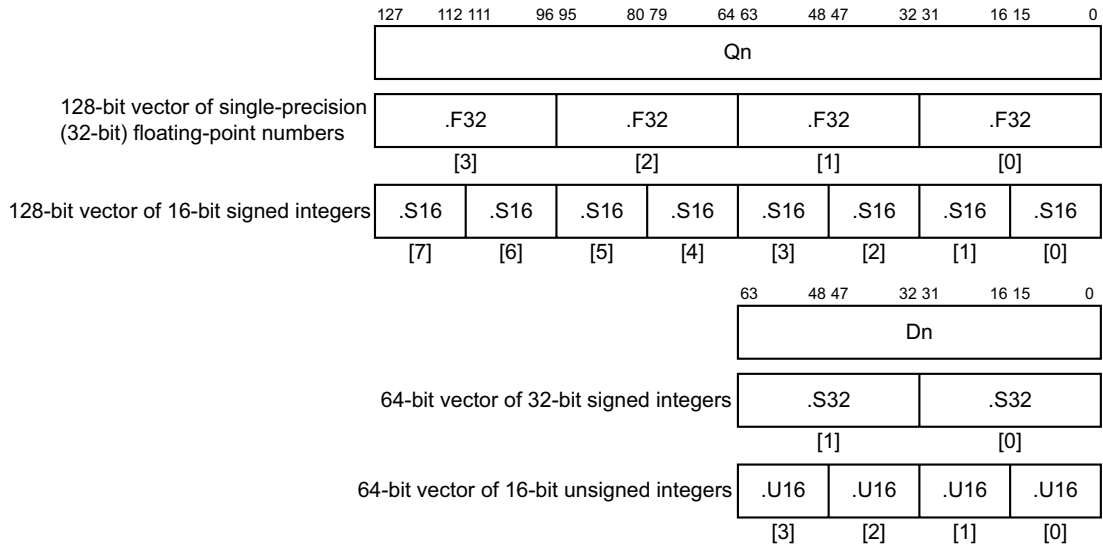

Figure A2-3 Examples of Advanced SIMD vectors

### Pseudocode details of Advanced SIMD vectors

The pseudocode function `Elem[]` accesses the element of a specified index and size in a vector:

```
// Elem[] - non-assignment form
// =====

bits(size) Elem[bits(N) vector, integer e, integer size]
    assert e >= 0 && (e+1)*size <= N;
    return vector<(e+1)*size-1:e*size>;
// Elem[] - assignment form
// =====

Elem[bits(N) vector, integer e, integer size] = bits(size) value
    assert e >= 0 && (e+1)*size <= N;
    vector<(e+1)*size-1:e*size> = value;
    return;
```

## A2.6.5 Advanced SIMD and Floating-point system registers

The Advanced SIMD and Floating-point (VFP) Extensions have a shared register space for system registers. Only one register in this space is accessible at the Application level, see either:

- [FPSCR, Floating-point Status and Control Register, VMSA on page B4-1569](#)
- [FPSCR, Floating-point Status and Control Register, PMSA on page B6-1845](#).

### ———— Note ————

In this chapter, short links to the [FPSCR](#) are to the description in [Chapter B4 System Control Registers in a VMSA implementation](#). The [FPSCR](#) description in [Chapter B6 System Control Registers in a PMSA implementation](#) is identical to this description.

Writes to the [FPSCR](#) can have side-effects on various aspects of processor operation. All of these side-effects are synchronous to the [FPSCR](#) write. This means they are guaranteed not to be visible to earlier instructions in the execution stream, and they are guaranteed to be visible to later instructions in the execution stream.

See [Advanced SIMD and Floating-point Extension system registers on page B1-1235](#) for the system level view of the registers.

## A2.6.6 VFPv3U and VFPv4U

The VFPv3 and VFPv4 versions of the Floating-point Extension do not support the exception trap enable bits in the [FPSCR](#). With these versions of the Floating-point Extension, all floating-point exceptions are untrapped.

The VFPv3U variant of the VFPv3 extension, and the VFPv4U variant of the VFPv4 extension, implement exception trap enable bits in the [FPSCR](#), and provide exception handling as described in [Floating-point support code on page B1-1236](#). There is a separate trap enable bit for each of the six floating-point exceptions described in [Floating-point exceptions on page A2-70](#). Except for support for this trapping mechanism:

- the VFPv3U architecture is identical to VFPv3
- the VFPv4U architecture is identical to VFPv4.

Trapped exception handling never causes the corresponding cumulative exception bit of the [FPSCR](#) to be set to 1. If this behavior is desired, the trap handler routine must use a read, modify, write sequence on the [FPSCR](#) to set the cumulative exception bit.

Both VFPv3U and VFPv4U can be implemented with either thirty-two or sixteen doubleword registers. That is:

- VFPv3U can be implemented as VFPv3U-D32, or as VFPv3U-D16
- VFPv4U can be implemented as VFPv4U-D32, or as VFPv4U-D16.

VFPv3U-D16 and VFPv4U-D16 are backwards compatible with VFPv2.

## A2.7 Floating-point data types and arithmetic

The Floating-point (VFP) Extension supports single-precision (32-bit) and double-precision (64-bit) floating-point data types and arithmetic as defined by the IEEE 754 floating-point standard. It also supports the half-precision (16-bit) floating-point data type for data storage only, by supporting conversions between single-precision and half-precision data types.

*ARM standard floating-point arithmetic* means IEEE 754 floating-point arithmetic with the following restrictions:

- denormalized numbers are flushed to zero, see [Flush-to-zero on page A2-68](#)
- only default NaNs are supported, see [NaN handling and the Default NaN on page A2-69](#)
- the Round to Nearest rounding mode selected, by setting `FPSCR.RMode` to `0b00`
- untrapped exception handling selected for all floating-point exceptions, by setting `FPSCR[15, 12:8]` to `0b000000`.

In ARMv7 implementations, trapped floating-point exception handling is supported in the VFPv3U and VFPv4U variants of the Floating-point Extension, see [VFPv3U and VFPv4U on page A2-62](#). In implementations of previous architecture versions, it is supported in VFPv2.

The Advanced SIMD Extension supports only single-precision ARM standard floating-point arithmetic.

### ———— **Note** —————

Implementations of the Floating-point Extension require *support code* to be installed in the system if trapped floating-point exception handling is required. See [Floating-point support code on page B1-1236](#).

Some implementations might also require support code to support other aspects of their floating-point arithmetic. However, with the ARMv7 architecture, ARM deprecates using support code in this way.

It is IMPLEMENTATION DEFINED which aspects of Floating-point Extension floating-point arithmetic are supported in a system without support code installed.

Aspects of floating-point arithmetic that are implemented in support code are likely to run much more slowly than those that are executed in hardware.

ARM recommends that:

- To maximize the chance of getting high floating-point performance, software developers use ARM standard floating-point arithmetic.
- Software developers check whether their systems have support code installed, and if not, observe the IMPLEMENTATION DEFINED restrictions on what operations their Floating-point Extension implementation can handle without support code.
- Floating-point Extension implementation developers implement at least ARM standard floating-point arithmetic in hardware, so that it can be executed without any need for support code.

### A2.7.1 ARM standard floating-point input and output values

ARM standard floating-point arithmetic supports the following input formats defined by the IEEE 754 floating-point standard:

- Zeros.
- Normalized numbers.
- Denormalized numbers are flushed to 0 before floating-point operations, see [Flush-to-zero on page A2-68](#).
- NaNs.
- Infinities.

ARM standard floating-point arithmetic supports the Round to Nearest rounding mode defined by the IEEE 754 standard.

ARM standard floating-point arithmetic supports the following output result formats defined by the IEEE 754 standard:

- Zeros.
- Normalized numbers.
- Results that are less than the minimum normalized number are flushed to zero, see [Flush-to-zero on page A2-68](#).
- NaNs produced in floating-point operations are always the default NaN, see [NaN handling and the Default NaN on page A2-69](#).
- Infinities.

## A2.7.2 Advanced SIMD and Floating-point single-precision format

The single-precision floating-point format used by the Advanced SIMD and Floating-point Extensions is as defined by the IEEE 754 standard.

This description includes ARM-specific details that are left open by the standard. It is only intended as an introduction to the formats and to the values they can contain. For full details, especially of the handling of infinities, NaNs and signed zeros, see the IEEE 754 standard.

A single-precision value is a 32-bit word with the format:

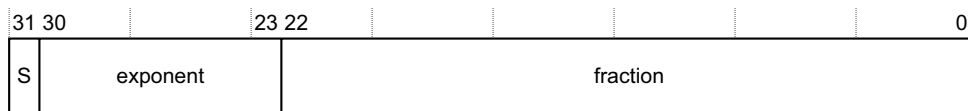

The interpretation of the format depends on the value of the exponent field, bits[30:23]:

### **0 < exponent < 0xFF**

The value is a *normalized number* and is equal to:

$$(-1)^S \times 2^{(\text{exponent} - 127)} \times (1.\text{fraction})$$

The minimum positive normalized number is  $2^{-126}$ , or approximately  $1.175 \times 10^{-38}$ .

The maximum positive normalized number is  $(2 - 2^{-23}) \times 2^{127}$ , or approximately  $3.403 \times 10^{38}$ .

### **exponent == 0**

The value is either a zero or a *denormalized number*, depending on the fraction bits:

#### **fraction == 0**

The value is a zero. There are two distinct zeros:

**+0**      When S==0.

**-0**      When S==1.

These usually behave identically. In particular, the result is *equal* if +0 and -0 are compared as floating-point numbers. However, they yield different results in some circumstances. For example, the sign of the infinity produced as the result of dividing by zero depends on the sign of the zero. The two zeros can be distinguished from each other by performing an integer comparison of the two words.

#### **fraction != 0**

The value is a denormalized number and is equal to:

$$(-1)^S \times 2^{-126} \times (0.\text{fraction})$$

The minimum positive denormalized number is  $2^{-149}$ , or approximately  $1.401 \times 10^{-45}$ .

Denormalized numbers are always flushed to zero in the Advanced SIMD Extension. They are optionally flushed to zero in the Floating-point Extension. For details see [Flush-to-zero on page A2-68](#).

**exponent == 0xFF**

The value is either an *infinity* or a *Not a Number* (NaN), depending on the fraction bits:

**fraction == 0**

The value is an infinity. There are two distinct infinities:

**+infinity** When S==0. This represents all positive numbers that are too big to be represented accurately as a normalized number.

**-infinity** When S==1. This represents all negative numbers with an absolute value that is too big to be represented accurately as a normalized number.

**fraction != 0**

The value is a NaN, and is either a *quiet NaN* or a *signaling NaN*.

In the Floating-point Extension, the two types of NaN are distinguished on the basis of their most significant fraction bit, bit[22]:

**bit[22] == 0**

The NaN is a signaling NaN. The sign bit can take any value, and the remaining fraction bits can take any value except all zeros.

**bit[22] == 1**

The NaN is a quiet NaN. The sign bit and remaining fraction bits can take any value.

For details of the *default NaN* see [NaN handling and the Default NaN on page A2-69](#).

———— **Note** —————

NaNs with different sign or fraction bits are distinct NaNs, but this does not mean software can use floating-point comparison instructions to distinguish them. This is because the IEEE 754 standard specifies that a NaN compares as *unordered* with everything, including itself.

### A2.7.3 Floating-point double-precision format

The double-precision floating-point format used by the Floating-point Extension is as defined by the IEEE 754 standard.

This description includes Floating-point Extension-specific details that are left open by the standard. It is only intended as an introduction to the formats and to the values they can contain. For full details, especially of the handling of infinities, NaNs and signed zeros, see the IEEE 754 standard.

A double-precision value is a 64-bit doubleword, with the format:

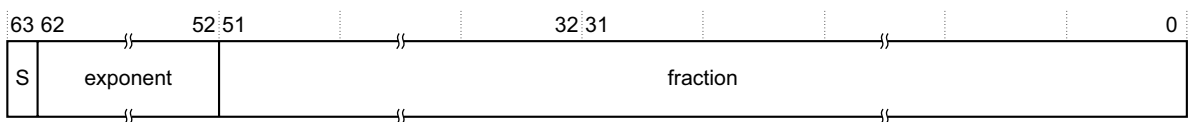

Double-precision values represent numbers, infinities and NaNs in a similar way to single-precision values, with the interpretation of the format depending on the value of the exponent:

**0 < exponent < 0x7FF**

The value is a normalized number and is equal to:

$$(-1)^S \times 2^{(\text{exponent}-1023)} \times (1.\text{fraction})$$

The minimum positive normalized number is  $2^{-1022}$ , or approximately  $2.225 \times 10^{-308}$ .

The maximum positive normalized number is  $(2 - 2^{-52}) \times 2^{1023}$ , or approximately  $1.798 \times 10^{308}$ .

**exponent == 0**

The value is either a zero or a denormalized number, depending on the fraction bits:

**fraction == 0**

The value is a zero. There are two distinct zeros that behave analogously to the two single-precision zeros:

- +0 when S==0
- 0 when S==1.

**fraction != 0**

The value is a denormalized number and is equal to:

$$(-1)^S \times 2^{-1022} \times (0.\text{fraction})$$

The minimum positive denormalized number is  $2^{-1074}$ , or approximately  $4.941 \times 10^{-324}$ .

Optionally, denormalized numbers are flushed to zero in the Floating-point Extension. For details see [Flush-to-zero on page A2-68](#).

**exponent == 0x7FF**

The value is either an infinity or a NaN, depending on the fraction bits:

**fraction == 0**

the value is an infinity. As for single-precision, there are two infinities:

- +infinity When S==0.
- infinity When S==1.

**fraction != 0**

The value is a NaN, and is either a *quiet NaN* or a *signaling NaN*.

In the Floating-point Extension, the two types of NaN are distinguished on the basis of their most significant fraction bit, bit[19] of the most significant word:

**bit[19] == 0**

The NaN is a signaling NaN. The sign bit can take any value, and the remaining fraction bits can take any value except all zeros.

**bit[19] == 1**

The NaN is a quiet NaN. The sign bit and the remaining fraction bits can take any value.

For details of the *default NaN* see [NaN handling and the Default NaN on page A2-69](#).

———— **Note** —————

NaNs with different sign or fraction bits are distinct NaNs, but this does not mean software can use floating-point comparison instructions to distinguish them. This is because the IEEE 754 standard specifies that a NaN compares as *unordered* with everything, including itself.

## A2.7.4 Advanced SIMD and Floating-point half-precision formats

The Half-precision Extension to the Advanced SIMD and Floating-point Extensions uses two half-precision floating-point formats:

- IEEE half-precision, as described in the IEEE 754-2008 standard
- Alternative half-precision.

The description of IEEE half-precision includes ARM-specific details that are left open by the standard, and is only an introduction to the formats and to the values they can contain. For more information, especially on the handling of infinities, NaNs and signed zeros, see the IEEE 754 standard.

For both half-precision floating-point formats, the layout of the 16-bit number is the same. The format is:

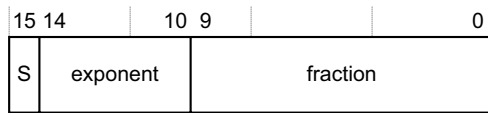

The interpretation of the format depends on the value of the exponent field, bits[14:10] and on which half-precision format is being used.

**0 < exponent < 0x1F**

The value is a normalized number and is equal to:

$$(-1)^S \times 2^{(\text{exponent}-15)} \times (1.\text{fraction})$$

The minimum positive normalized number is  $2^{-14}$ , or approximately  $6.104 \times 10^{-5}$ .

The maximum positive normalized number is  $(2 - 2^{-10}) \times 2^{15}$ , or 65504.

Larger normalized numbers can be expressed using the alternative format when the exponent == 0x1F.

**exponent == 0**

The value is either a zero or a denormalized number, depending on the fraction bits:

**fraction == 0**

The value is a zero. There are two distinct zeros:

- +0** when S==0
- 0** when S==1.

**fraction != 0**

The value is a denormalized number and is equal to:

$$(-1)^S \times 2^{-14} \times (0.\text{fraction})$$

The minimum positive denormalized number is  $2^{-24}$ , or approximately  $5.960 \times 10^{-8}$ .

**exponent == 0x1F**

The value depends on which half-precision format is being used:

**IEEE half-precision**

The value is either an infinity or a Not a Number (NaN), depending on the fraction bits:

**fraction == 0**

The value is an infinity. There are two distinct infinities:

- +infinity** When S==0. This represents all positive numbers that are too big to be represented accurately as a normalized number.
- infinity** When S==1. This represents all negative numbers with an absolute value that is too big to be represented accurately as a normalized number.

**fraction != 0**

The value is a NaN, and is either a quiet NaN or a signaling NaN. The two types of NaN are distinguished by their most significant fraction bit, bit[9]:

**bit[9] == 0** The NaN is a signaling NaN. The sign bit can take any value, and the remaining fraction bits can take any value except all zeros.

**bit[9] == 1** The NaN is a quiet NaN. The sign bit and remaining fraction bits can take any value.

**Alternative half-precision**

The value is a normalized number and is equal to:

$$-1^S \times 2^{16} \times (1.\text{fraction})$$

The maximum positive normalized number is  $(2-2^{-10}) \times 2^{16}$  or 131008.

## A2.7.5 Flush-to-zero

The performance of floating-point implementations can be significantly reduced when performing calculations involving denormalized numbers and Underflow exceptions. In particular this occurs for implementations that only handle normalized numbers and zeros in hardware, and invoke support code to handle any other types of value. For an algorithm where a significant number of the operands and intermediate results are denormalized numbers, this can result in a considerable loss of performance.

In many of these algorithms, this performance can be recovered, without significantly affecting the accuracy of the final result, by replacing the denormalized operands and intermediate results with zeros. To permit this optimization, Floating-point Extension implementations have a special processing mode called *Flush-to-zero* mode. Advanced SIMD implementations always use Flush-to-zero mode.

Behavior in Flush-to-zero mode differs from normal IEEE 754 arithmetic in the following ways:

- All inputs to floating-point operations that are double-precision denormalized numbers or single-precision denormalized numbers are treated as though they were zero. This causes an Input Denormal exception, but does not cause an Inexact exception. The Input Denormal exception occurs only in Flush-to-zero mode.

———— **Note** —————

[Combinations of exceptions on page A2-71](#) defines the floating-point operations.

The **FPSCR** contains a cumulative exception bit **FPSCR.IDC** and trap enable bit **FPSCR.IDE** corresponding to the Input Denormal exception.

The occurrence of all exceptions except Input Denormal is determined using the input values after flush-to-zero processing has occurred.

- The result of a floating-point operation is flushed to zero if the result of the operation before rounding satisfies the condition:

$0 < \text{Abs}(\text{result}) < \text{MinNorm}$ , where:

- **MinNorm** is  $2^{-126}$  for single-precision
- **MinNorm** is  $2^{-1022}$  for double-precision.

This causes the **FPSCR.UFC** bit to be set to 1, and prevents any Inexact exception from occurring for the operation.

Underflow exceptions occur only when a result is flushed to zero.

In a VFPv2, VFPv3U, or VFPv4U implementation Underflow exceptions that occur in Flush-to-zero mode are always treated as untrapped, even when the Underflow trap enable bit, **FPSCR.UFE**, is set to 1.

- An Inexact exception does not occur if the result is flushed to zero, even though the final result of zero is not equivalent to the value that would be produced if the operation were performed with unbounded precision and exponent range.

When an input or a result is flushed to zero the value of the sign bit of the zero is determined as follows:

- In VFPv4, VFPv4U, VFPv3, or VFPv3U, it is preserved. That is, the sign bit of the zero matches the sign bit of the input or result that is being flushed to zero.
- In VFPv2, it is IMPLEMENTATION DEFINED whether it is preserved or always positive. The same choice must be made for all cases of flushing an input or result to zero.

Flush-to-zero mode has no effect on half-precision numbers that are inputs to floating-point operations, or results from floating-point operations.



———— **Note** —————

Flush-to-zero mode is incompatible with the IEEE 754 standard, and must not be used when IEEE 754 compatibility is a requirement. Flush-to-zero mode must be used with care. Although it can improve performance on some algorithms, there are significant limitations on its use. These are application dependent:

- On many algorithms, it has no noticeable effect, because the algorithm does not normally use denormalized numbers.
- On other algorithms, it can cause exceptions to occur or seriously reduce the accuracy of the results of the algorithm.

## A2.7.6 NaN handling and the Default NaN

The IEEE 754 standard specifies that:

- an operation that produces an Invalid Operation floating-point exception generates a quiet NaN as its result if that exception is untrapped
- an operation involving a quiet NaN operand, but not a signaling NaN operand, returns an input NaN as its result.

The Floating-point Extension behavior when Default NaN mode is disabled adheres to this, with the following additions:

- If an untrapped Invalid Operation floating-point exception is produced, the quiet NaN result is derived from:
  - the first signaling NaN operand, if the exception was produced because at least one of the operands is a signaling NaN
  - otherwise, the default NaN
- If an untrapped Invalid Operation floating-point exception is not produced, but at least one of the operands is a quiet NaN, the result is derived from the first quiet NaN operand.

Depending on the operation, the exact value of a derived quiet NaN result may differ in both sign and number of fraction bits from its source. For a quiet NaN result derived from signaling NaN operand, the most-significant fraction bit is set to 1.

———— **Note** —————

- In these descriptions, *first operand* relates to the left-to-right ordering of the arguments to the pseudocode function that describes the operation.
- The IEEE 754 standard specifies that the sign bit of a NaN has no significance.

The Floating-point Extension behavior when Default NaN mode is enabled, and the Advanced SIMD behavior in all circumstances, is that the Default NaN is the result of all floating-point operations that either:

- generate untrapped Invalid Operation floating-point exceptions
- have one or more quiet NaN inputs, but no signaling NaN inputs.

[Table A2-7 on page A2-70](#) shows the format of the default NaN for ARM floating-point processors.

Default NaN mode is selected for the Floating-point Extension by setting the [FPSCR.DN](#) bit to 1.

Other aspects of the functionality of the Invalid Operation exception are not affected by Default NaN mode. These are that:

- If untrapped, it causes the [FPSCR.IOC](#) bit be set to 1.
- If trapped, it causes a user trap handler to be invoked. This is only possible in VFPv2, VFPv3U, and VFPv4U.

**Table A2-7 Default NaN encoding**

	Half-precision, IEEE Format	Single-precision	Double-precision
Sign bit	0	0 <sup>a</sup>	0 <sup>a</sup>
Exponent	0x1F	0xFF	0x7FF
Fraction	Bit[9] == 1, bits[8:0] == 0	bit[22] == 1, bits[21:0] == 0	bit[51] == 1, bits[50:0] == 0

a. In VFPv2, the sign bit of the Default NaN is UNKNOWN.

### A2.7.7 Floating-point exceptions

The Advanced SIMD and Floating-point Extensions record the following floating-point exceptions in the **FPSCR** cumulative bits:

**FPSCR.IOC** Invalid Operation. The bit is set to 1 if the result of an operation has no mathematical value or cannot be represented. Cases include, for example:

- $(\text{infinity}) \times 0$
- $(+\text{infinity}) + (-\text{infinity})$ .

These tests are made after flush-to-zero processing. For example, if flush-to-zero mode is selected, multiplying a denormalized number and an infinity is treated as  $(0 \times \text{infinity})$ , and causes an Invalid Operation floating-point exception.

IOC is also set on any floating-point operation with one or more signaling NaNs as operands, except for negation and absolute value, as described in *Floating-point negation and absolute value on page A2-75*.

**FPSCR.DZC** Division by Zero. The bit is set to 1 if a divide operation has a zero divisor and a dividend that is not zero, an infinity or a NaN. These tests are made after flush-to-zero processing, so if flush-to-zero processing is selected, a denormalized dividend is treated as zero and prevents Division by Zero from occurring, and a denormalized divisor is treated as zero and causes Division by Zero to occur if the dividend is a normalized number.

For the reciprocal and reciprocal square root estimate functions the dividend is assumed to be +1.0. This means that a zero or denormalized operand to these functions sets the DZC bit.

**FPSCR.OFC** Overflow. The bit is set to 1 if the absolute value of the result of an operation, produced after rounding, is greater than the maximum positive normalized number for the destination precision.

**FPSCR.UFC** Underflow. The bit is set to 1 if the absolute value of the result of an operation, produced before rounding, is less than the minimum positive normalized number for the destination precision, and the rounded result is inexact.

The criteria for the Underflow exception to occur are different in Flush-to-zero mode. For details, see *Flush-to-zero on page A2-68*.

**FPSCR.IXC** Inexact. The bit is set to 1 if the result of an operation is not equivalent to the value that would be produced if the operation were performed with unbounded precision and exponent range.

The criteria for the Inexact exception to occur are different in Flush-to-zero mode. For details, see *Flush-to-zero on page A2-68*.

**FPSCR.IDC** Input Denormal. The bit is set to 1 if a denormalized input operand is replaced in the computation by a zero, as described in *Flush-to-zero on page A2-68*.

With the Advanced SIMD Extension and the VFPv3 or VFPv4 versions of the Floating-point Extension these are non-trapping exceptions and the data-processing instructions do not generate any trapped exceptions.

With the VFPv2, VFPv3U, and VFPv4U versions of the Floating-point Extension:

- These exceptions can be trapped, by setting trap enable bits in the FPSCR, see [VFPv3U and VFPv4U on page A2-62](#). The way in which trapped floating-point exceptions are delivered to user software is IMPLEMENTATION DEFINED. However, ARM recommends use of the VFP subarchitecture defined in [Appendix F Common VFP Subarchitecture Specification](#).
- The definition of the Underflow exception is different in the trapped and cumulative exception cases. In the trapped case, meaning for VFPv2, VFPv3U, or VFPv4U, the definition is:
  - the trapped Underflow exception occurs if the absolute value of the result of an operation, produced before rounding, is less than the minimum positive normalized number for the destination precision, regardless of whether the rounded result is inexact.
- As with cumulative exceptions, higher priority trapped exceptions can prevent lower priority exceptions from occurring, as described in [Combinations of exceptions](#).

Table A2-8 shows the results of untrapped floating-point exceptions:

**Table A2-8 Results of untrapped floating-point exceptions**

Exception type	Default result for positive sign	Default result for negative sign
IOC, Invalid Operation	Quiet NaN	Quiet NaN
DZC, Division by Zero	+infinity	-infinity
OFC, Overflow	RN, RP: +infinity RM, RZ: +MaxNorm	RN, RM: -infinity RP, RZ: -MaxNorm
UFC, Underflow	Normal rounded result	Normal rounded result
IXC, Inexact	Normal rounded result	Normal rounded result
IDC, Input Denormal	Normal rounded result	Normal rounded result

In [Table A2-8](#):

- MaxNorm** The maximum normalized number of the destination precision.
- RM** Round towards Minus Infinity mode, as defined in the IEEE 754 standard.
- RN** Round to Nearest mode, as defined in the IEEE 754 standard.
- RP** Round towards Plus Infinity mode, as defined in the IEEE 754 standard.
- RZ** Round towards Zero mode, as defined in the IEEE 754 standard.

- For Invalid Operation exceptions, for details of which quiet NaN is produced as the default result see [NaN handling and the Default NaN on page A2-69](#).
- For Division by Zero exceptions, the sign bit of the default result is determined normally for a division. This means it is the exclusive OR of the sign bits of the two operands.
- For Overflow exceptions, the sign bit of the default result is determined normally for the overflowing operation.

### Combinations of exceptions

The following pseudocode functions perform *floating-point operations*:

```
FixedToFP()
FPAdd()
FPCompare()
FPCompareEQ()
FPCompareGE()
FPCompareGT()
FPDiv()
```

FPDoubleToSingle()  
FPHalfToSingle()  
FPMax()  
FPMin()  
FPMul()  
FPMulAdd()  
FPRecipEstimate()  
FPRecipStep()  
FPRSqrtEstimate()  
FPRSqrtStep()  
FPSingleToDouble()  
FPSingleToHalf()  
FPSqrt()  
FPSub()  
FPToFixed()

All of these operations can generate floating-point exceptions.

———— **Note** —————

FPAbs() and FPNeg() are not classified as *floating-point operations* because:

- they cannot generate floating-point exceptions
- the floating-point operation behavior described in the following sections does not apply to them:
  - [Flush-to-zero on page A2-68](#)
  - [NaN handling and the Default NaN on page A2-69](#).

More than one exception can occur on the same operation. The only combinations of exceptions that can occur are:

- Overflow with Inexact
- Underflow with Inexact
- Input Denormal with other exceptions.

When none of the exceptions caused by an operation are trapped, any exception that occurs causes the associated cumulative bit in the **FPSCR** to be set.

When one or more exceptions caused by an operation are trapped, the behavior of the instruction depends on the priority of the exceptions. The Inexact exception is treated as lowest priority, and Input Denormal as highest priority:

- If the higher priority exception is trapped, its trap handler is called. It is IMPLEMENTATION DEFINED whether the parameters to the trap handler include information about the lower priority exception. Apart from this, the lower priority exception is ignored in this case.
- If the higher priority exception is untrapped, its cumulative bit is set to 1 and its default result is evaluated. Then the lower priority exception is handled normally, using this default result.

Some floating-point instructions specify more than one floating-point operation, as indicated by the pseudocode descriptions of the instruction. In such cases, an exception on one operation is treated as higher priority than an exception on another operation if the occurrence of the second exception depends on the result of the first operation. Otherwise, it is UNPREDICTABLE which exception is treated as higher priority.

For example, a **VMLA.F32** instruction specifies a floating-point multiplication followed by a floating-point addition. The addition can generate Overflow, Underflow and Inexact exceptions, all of which depend on both operands to the addition and so are treated as lower priority than any exception on the multiplication. The same applies to Invalid Operation exceptions on the addition caused by adding opposite-signed infinities. The addition can also generate an Input Denormal exception, caused by the addend being a denormalized number while in Flush-to-zero mode. It is UNPREDICTABLE which of an Input Denormal exception on the addition and an exception on the multiplication is treated as higher priority, because the occurrence of the Input Denormal exception does not depend on the result of the multiplication. The same applies to an Invalid Operation exception on the addition caused by the addend being a signaling NaN.

---

**Note**

- The VFMA instruction performs a vector addition and a vector multiplication as a single operation. The VFMS instruction performs a vector subtraction and a vector multiplication as a single operation.
  - Like other details of Floating-point instruction execution, these rules about exception handling apply to the overall results produced by an instruction when the system uses a combination of hardware and support code to implement it. See [Floating-point support code on page B1-1236](#) for more information.  
These principles also apply to the multiple floating-point operations generated by Floating-point instructions in the deprecated VFP vector mode of operation. For details of this mode of operation see [Appendix K VFP Vector Operation Support](#).
- 

## A2.7.8 Pseudocode details of floating-point operations

The following subsections contain pseudocode definitions of the floating-point functionality supported by the ARMv7 architecture:

- [Generation of specific floating-point values](#)
- [Floating-point negation and absolute value on page A2-75](#)
- [Floating-point value unpacking on page A2-75](#)
- [Floating-point exception and NaN handling on page A2-76](#)
- [Floating-point rounding on page A2-78](#)
- [Selection of ARM standard floating-point arithmetic on page A2-79](#)
- [Floating-point comparisons on page A2-80](#)
- [Floating-point maximum and minimum on page A2-81](#)
- [Floating-point addition and subtraction on page A2-82](#)
- [Floating-point multiplication and division on page A2-83](#)
- [Floating-point fused multiply-add on page A2-84](#)
- [Floating-point reciprocal estimate and step on page A2-85](#)
- [Floating-point square root on page A2-87](#)
- [Floating-point reciprocal square root estimate and step on page A2-87](#)
- [Floating-point conversions on page A2-90](#)

### Generation of specific floating-point values

The following pseudocode functions generate specific floating-point values. The sign argument of FPInfinity(), FPMaxNormal(), and FPZero() is '0' for the positive version and '1' for the negative version.

```
// FPZero()
// =====

bits(N) FPZero(bit sign, integer N)
    assert N IN {16,32,64};
    if N == 16 then
        return sign : '00000 0000000000';
    elsif N == 32 then
        return sign : '00000000 0000000000000000000000';
    else
        return sign : '0000000000 00000000000000000000000000000000000000000000000000000000000000000000000000';
// FPTwo()
// =====

bits(N) FPTwo(integer N)
    assert N IN {32,64};
    if N == 32 then
        return '0 10000000 00000000000000000000000000';
    else
        return '0 1000000000 00000000000000000000000000000000000000000000000000000000000000000000000000';
```

```

// FPThree()
// =====

bits(N) FPThree(integer N)
  assert N IN {32,64};
  if N == 32 then
    return '0 10000000 1000000000000000000000';
  else
    return '0 1000000000 100000000000000000000000000000000000000000000000';

// FPMaxNormal()
// =====

bits(N) FPMaxNormal(bit sign, integer N)
  assert N IN {16,32,64};
  if N == 16 then
    return sign : '11110 1111111111';
  elsif N == 32 then
    return sign : '11111110 11111111111111111111';
  else
    return sign : '1111111110 1111111111111111111111111111111111111111111111';

// FPInfinity()
// =====

bits(N) FPIfinity(bit sign, integer N)
  assert N IN {16,32,64};
  if N == 16 then
    return sign : '11111 0000000000';
  elsif N == 32 then
    return sign : '11111111 0000000000000000000000';
  else
    return sign : '1111111111 000000000000000000000000000000000000000000000000';

// FPDefaultNaN()
// =====

bits(N) FPDefaultNaN(integer N)
  assert N IN {16,32,64};
  if N == 16 then
    return '0 11111 1000000000';
  elsif N == 32 then
    return '0 11111111 1000000000000000000000';
  else
    return '0 1111111111 100000000000000000000000000000000000000000000000';

```

**Note**

This definition of `FPDefaultNaN()` applies to VFPv4, VFPv4U, VFPv3, and VFPv3U implementations. For VFPv2, the sign bit of the result is a single-bit UNKNOWN value, instead of 0.

## Floating-point negation and absolute value

The floating-point negation and absolute value operations only affect the sign bit. They do not treat NaN operands specially, nor denormalized number operands when flush-to-zero is selected.

```
// FPNeg()
// =====

bits(N) FPNeg(bits(N) operand)
    assert N IN {32,64};
    return NOT(operand<N-1>) : operand<N-2:0>;

// FPAbs()
// =====

bits(N) FPAbs(bits(N) operand)
    assert N IN {32,64};
    return '0' : operand<N-2:0>;
```

## Floating-point value unpacking

The FPUunpack() function determines the type and numerical value of a floating-point number. It also does flush-to-zero processing on input operands.

```
enumeration FPType {FPType_Nonzero, FPType_Zero, FPType_Infinity, FPType_QNaN, FPType_SNaN};
// FPUunpack()
// =====
//
// Unpack a floating-point number into its type, sign bit and the real number
// that it represents. The real number result has the correct sign for numbers
// and infinities, is very large in magnitude for infinities, and is 0.0 for
// NaNs. (These values are chosen to simplify the description of comparisons
// and conversions.)
//
// The 'fpscr_val' argument supplies FPSCR control bits. Status information is
// updated directly in the FPSCR where appropriate.

(FPType, bit, real) FPUunpack(bits(N) fpval, bits(32) fpscr_val)
    assert N IN {16,32,64};

    if N == 16 then
        sign = fpval<15>;
        exp = fpval<14:10>;
        frac = fpval<9:0>;
        if IsZero(exp) then
            // Produce zero if value is zero
            if IsZero(frac) then
                type = FPType_Zero; value = 0.0;
            else
                type = FPType_Nonzero; value = 2-14 * (UInt(frac) * 2-10);
        elsif IsOnes(exp) && fpscr_val<26> == '0' then // Infinity or NaN in IEEE format
            if IsZero(frac) then
                type = FPType_Infinity; value = 21000000;
            else
                type = if frac<9> == '1' then FPType_QNaN else FPType_SNaN;
                value = 0.0;
        else
            type = FPType_Nonzero; value = 2UInt(exp)-15 * (1.0 + UInt(frac) * 2-10);

    elsif N == 32 then

        sign = fpval<31>;
        exp = fpval<30:23>;
        frac = fpval<22:0>;
        if IsZero(exp) then
            // Produce zero if value is zero or flush-to-zero is selected.
```

```

    if IsZero(frac) || fpscr_val<24> == '1' then
        type = FPType_Zero; value = 0.0;
        if !IsZero(frac) then // Denormalized input flushed to zero
            FPProcessException(FPExc_InputDenorm, fpscr_val);
    else
        type = FPType_Nonzero; value = 2-126 * (UInt(frac) * 2-23);
elseif IsOnes(exp) then
    if IsZero(frac) then
        type = FPType_Infinity; value = 21000000;
    else
        type = if frac<22> == '1' then FPType_QNaN else FPType_SNaN;
        value = 0.0;
else
    type = FPType_Nonzero; value = 2(UInt(exp)-127) * (1.0 + UInt(frac) * 2-23);

else // N == 64

    sign = fpval<63>;
    exp = fpval<62:52>;
    frac = fpval<51:0>;
    if IsZero(exp) then
        // Produce zero if value is zero or flush-to-zero is selected.
        if IsZero(frac) || fpscr_val<24> == '1' then
            type = FPType_Zero; value = 0.0;
            if !IsZero(frac) then // Denormalized input flushed to zero
                FPProcessException(FPExc_InputDenorm, fpscr_val);
        else
            type = FPType_Nonzero; value = 2-1022 * (UInt(frac) * 2-52);
    elseif IsOnes(exp) then
        if IsZero(frac) then
            type = FPType_Infinity; value = 21000000;
        else
            type = if frac<51> == '1' then FPType_QNaN else FPType_SNaN;
            value = 0.0;
    else
        type = FPType_Nonzero; value = 2(UInt(exp)-1023) * (1.0 + UInt(frac) * 2-52);

    if sign == '1' then value = -value;
    return (type, sign, value);

```

## Floating-point exception and NaN handling

The FPProcessException() procedure checks whether a floating-point exception is trapped, and handles it accordingly:

```

enumeration FPExc {FPExc_InvalidOp, FPExc_DivideByZero, FPExc_Overflow,
                  FPExc_Underflow, FPExc_Inexact, FPExc_InputDenorm};
// FPProcessException()
// =====
//
// The 'fpscr_val' argument supplies FPSCR control bits. Status information is
// updated directly in the FPSCR where appropriate.

FPProcessException(FPExc exception, bits(32) fpscr_val)
// Get appropriate FPSCR bit numbers
case exception of
    when FPExc_InvalidOp     enable = 8;  cumul = 0;
    when FPExc_DivideByZero enable = 9;  cumul = 1;
    when FPExc_Overflow      enable = 10; cumul = 2;
    when FPExc_Underflow     enable = 11; cumul = 3;
    when FPExc_Inexact       enable = 12; cumul = 4;
    when FPExc_InputDenorm   enable = 15; cumul = 7;
if fpscr_val<enable> then
    IMPLEMENTATION_DEFINED floating-point trap handling;
else
    FPSCR<cumul> = '1';

```



```
return;
```

The `FPPProcessNaN()` function processes a NaN operand, producing the correct result value and generating an Invalid Operation exception if necessary:

```
// FPPProcessNaN()
// =====
//
// The 'fpscr_val' argument supplies FPSCR control bits. Status information is
// updated directly in the FPSCR where appropriate.

bits(N) FPPProcessNaN(FPType type, bits(N) operand, bits(32) fpscr_val)
    assert N IN {32,64};
    topfrac = if N == 32 then 22 else 51;
    result = operand;
    if type == FPType_SNaN then
        result<topfrac> = '1';
        FPPProcessException(FPExc_InvalidOp, fpscr_val);
    if fpscr_val<25> == '1' then // DefaultNaN requested
        result = FPDefaultNaN(N);
    return result;
```

The `FPPProcessNaNs()` function performs the standard NaN processing for a two-operand operation:

```
// FPPProcessNaNs()
// =====
//
// The boolean part of the return value says whether a NaN has been found and
// processed. The bits(N) part is only relevant if it has and supplies the
// result of the operation.
//
// The 'fpscr_val' argument supplies FPSCR control bits. Status information is
// updated directly in the FPSCR where appropriate.

(boolean, bits(N)) FPPProcessNaNs(FPType type1, FPType type2,
                                bits(N) op1, bits(N) op2,
                                bits(32) fpscr_val)

    assert N IN {32,64};
    if type1 == FPType_SNaN then
        done = TRUE; result = FPPProcessNaN(type1, op1, fpscr_val);
    elsif type2 == FPType_SNaN then
        done = TRUE; result = FPPProcessNaN(type2, op2, fpscr_val);
    elsif type1 == FPType_QNaN then
        done = TRUE; result = FPPProcessNaN(type1, op1, fpscr_val);
    elsif type2 == FPType_QNaN then
        done = TRUE; result = FPPProcessNaN(type2, op2, fpscr_val);
    else
        done = FALSE; result = Zeros(N); // 'Don't care' result
    return (done, result);
```

The `FPPProcessNaNs3()` function performs the standard NaN processing for a three-operand operation:

```
// FPPProcessNaNs3()
// =====
//
// The boolean part of the return value says whether a NaN has been found and
// processed. The bits(N) part is only relevant if it has and supplies the
// result of the operation.
//
// The 'fpscr_val' argument supplies FPSCR control bits. Status information is
// updated directly in the FPSCR where appropriate.

(boolean, bits(N)) FPPProcessNaNs3(FPType type1, FPType type2, FPType type3,
                                   bits(N) op1, bits(N) op2, bits(N) op3,
                                   bits(32) fpscr_val)

    assert N IN {32,64};
    if type1 == FPType_SNaN then
        done = TRUE; result = FPPProcessNaN(type1, op1, fpscr_val);
    elsif type2 == FPType_SNaN then
```

```
    done = TRUE; result = FPProcessNaN(type2, op2, fpscr_val);
elseif type3 == FPType_SNaN then
    done = TRUE; result = FPProcessNaN(type3, op3, fpscr_val);
elseif type1 == FPType_QNaN then
    done = TRUE; result = FPProcessNaN(type1, op1, fpscr_val);
elseif type2 == FPType_QNaN then
    done = TRUE; result = FPProcessNaN(type2, op2, fpscr_val);
elseif type3 == FPType_QNaN then
    done = TRUE; result = FPProcessNaN(type3, op3, fpscr_val);
else
    done = FALSE; result = Zeros(N); // 'Don't care' result
return (done, result);
```

## Floating-point rounding

The `FPRound()` function rounds and encodes a floating-point result value to a specified destination format. This includes processing Overflow, Underflow and Inexact floating-point exceptions and performing flush-to-zero processing on result values.

```
// FPRound()
// =====
//
// The 'fpscr_val' argument supplies FPSCR control bits. Status information is
// updated directly in the FPSCR where appropriate.

bits(N) FPRound(real result, integer N, bits(32) fpscr_val)
    assert N IN {16,32,64};
    assert result != 0.0;

    // Obtain format parameters - minimum exponent, numbers of exponent and fraction bits.
    if N == 16 then
        minimum_exp = -14; E = 5; F = 10;
    elseif N == 32 then
        minimum_exp = -126; E = 8; F = 23;
    else // N == 64
        minimum_exp = -1022; E = 11; F = 52;

    // Split value into sign, unrounded mantissa and exponent.
    if result < 0.0 then
        sign = '1'; mantissa = -result;
    else
        sign = '0'; mantissa = result;
    exponent = 0;
    while mantissa < 1.0 do
        mantissa = mantissa * 2.0; exponent = exponent - 1;
    while mantissa >= 2.0 do
        mantissa = mantissa / 2.0; exponent = exponent + 1;

    // Deal with flush-to-zero.
    if fpscr_val<24> == '1' && N != 16 && exponent < minimum_exp then
        result = FPZero(sign, N);
        FPSCR.UFC = '1'; // Flush-to-zero never generates a trapped exception
    else

        // Start creating the exponent value for the result. Start by biasing the actual exponent
        // so that the minimum exponent becomes 1, lower values 0 (indicating possible underflow).
        biased_exp = Max(exponent - minimum_exp + 1, 0);
        if biased_exp == 0 then mantissa = mantissa / 2^(minimum_exp - exponent);

        // Get the unrounded mantissa as an integer, and the "units in last place" rounding error.
        int_mant = RoundDown(mantissa * 2^F); // < 2^F if biased_exp == 0, >= 2^F if not
        error = mantissa * 2^F - int_mant;

        // Underflow occurs if exponent is too small before rounding, and result is inexact or
        // the Underflow exception is trapped.
        if biased_exp == 0 && (error != 0.0 || fpscr_val<11> == '1') then
            FPProcessException(FPExc_Underflow, fpscr_val);
```

```

// Round result according to rounding mode.
case fpscr_val<23:22> of
  when '00' // Round to Nearest (rounding to even if exactly halfway)
    round_up = (error > 0.5 || (error == 0.5 && int_mant<0> == '1'));
    overflow_to_inf = TRUE;
  when '01' // Round towards Plus Infinity
    round_up = (error != 0.0 && sign == '0');
    overflow_to_inf = (sign == '0');
  when '10' // Round towards Minus Infinity
    round_up = (error != 0.0 && sign == '1');
    overflow_to_inf = (sign == '1');
  when '11' // Round towards Zero
    round_up = FALSE;
    overflow_to_inf = FALSE;
if round_up then
  int_mant = int_mant + 1;
  if int_mant == 2^F then // Rounded up from denormalized to normalized
    biased_exp = 1;
  if int_mant == 2^(F+1) then // Rounded up to next exponent
    biased_exp = biased_exp + 1; int_mant = int_mant DIV 2;

// Deal with overflow and generate result.
if N != 16 || fpscr_val<26> == '0' then // Single, double or IEEE half precision
  if biased_exp >= 2^E - 1 then
    result = if overflow_to_inf then FPInfinity(sign, N) else FPMaxNormal(sign, N);
    FPPProcessException(FPExc_Overflow, fpscr_val);
    error = 1.0; // Ensure that an Inexact exception occurs
  else
    result = sign : biased_exp<E-1:0> : int_mant<F-1:0>;
else // Alternative half precision
  if biased_exp >= 2^E then
    result = sign : Ones(15);
    FPPProcessException(FPExc_InvalidOp, fpscr_val);
    error = 0.0; // Ensure that an Inexact exception does not occur
  else
    result = sign : biased_exp<E-1:0> : int_mant<F-1:0>;

// Deal with Inexact exception.
if error != 0.0 then
  FPPProcessException(FPExc_Inexact, fpscr_val);

return result;

```

## Selection of ARM standard floating-point arithmetic

The StandardFPSCRValue() function returns the FPSCR value that selects ARM standard floating-point arithmetic. Most of the arithmetic functions have a Boolean fpscr\_controlled argument that is TRUE for Floating-point operations and FALSE for Advanced SIMD operations, and that selects between using the real FPSCR value and this value.

```

// StandardFPSCRValue()
// =====

bits(32) StandardFPSCRValue()
  return '00000' : FPSCR<26> : '110000000000000000000000';

```

## Floating-point comparisons

The FPCompare() function compares two floating-point numbers, producing a {N, Z, C, V} condition flags result as shown in [Table A2-9](#):

**Table A2-9 Effect of a Floating-point comparison on the condition flags**

Comparison result	N	Z	C	V
Equal	0	1	1	0
Less than	1	0	0	0
Greater than	0	0	1	0
Unordered	0	0	1	1

This result defines the operation of the VCMPI instruction in the Floating-point Extension. The VCMPI instruction writes these flag values in the FPSCR. After using a VMRS instruction to transfer them to the APSR, they can control conditional execution as shown in [Table A8-1 on page A8-288](#).

```
// FPCompare()
// =====

(bit, bit, bit, bit) FPCompare(bits(N) op1, bits(N) op2, boolean quiet_nan_exc,
                               boolean fpscr_controlled)
{
    assert N IN {32,64};
    fpscr_val = if fpscr_controlled then FPSCR else StandardFPSCRValue();
    (type1,sign1,value1) = FPUunpack(op1, fpscr_val);
    (type2,sign2,value2) = FPUunpack(op2, fpscr_val);
    if type1==FType_SNaN || type1==FType_QNaN || type2==FType_SNaN || type2==FType_QNaN then
        result = ('0','0','1','1');
        if type1==FType_SNaN || type2==FType_SNaN || quiet_nan_exc then
            FPPProcessException(FPExc_InvalidOp, fpscr_val);
    else
        // All non-NaN cases can be evaluated on the values produced by FPUunpack()
        if value1 == value2 then
            result = ('0','1','1','0');
        elsif value1 < value2 then
            result = ('1','0','0','0');
        else // value1 > value2
            result = ('0','0','1','0');
    return result;
}
```

The FPCompareEQ(), FPCompareGE() and FPCompareGT() functions describe the operation of Advanced SIMD instructions that perform floating-point comparisons.

```
// FPCompareEQ()
// =====

boolean FPCompareEQ(bits(32) op1, bits(32) op2, boolean fpscr_controlled)
{
    fpscr_val = if fpscr_controlled then FPSCR else StandardFPSCRValue();
    (type1,sign1,value1) = FPUunpack(op1, fpscr_val);
    (type2,sign2,value2) = FPUunpack(op2, fpscr_val);
    if type1==FType_SNaN || type1==FType_QNaN || type2==FType_SNaN || type2==FType_QNaN then
        result = FALSE;
        if type1==FType_SNaN || type2==FType_SNaN then
            FPPProcessException(FPExc_InvalidOp, fpscr_val);
    else
        // All non-NaN cases can be evaluated on the values produced by FPUunpack()
        result = (value1 == value2);
    return result;
}
```

```
// FPCompareGE()
// =====

boolean FPCompareGE(bits(32) op1, bits(32) op2, boolean fpscr_controlled)
    fpscr_val = if fpscr_controlled then FPSCR else StandardFPSCRValue();
    (type1,sign1,value1) = FPUunpack(op1, fpscr_val);
    (type2,sign2,value2) = FPUunpack(op2, fpscr_val);
    if type1==FPTYPE_SNaN || type1==FPTYPE_QNaN || type2==FPTYPE_SNaN || type2==FPTYPE_QNaN then
        result = FALSE;
        FPProcessException(FPExc_InvalidOp, fpscr_val);
    else
        // All non-NaN cases can be evaluated on the values produced by FPUunpack()
        result = (value1 >= value2);
    return result;

// FPCompareGT()
// =====

boolean FPCompareGT(bits(32) op1, bits(32) op2, boolean fpscr_controlled)
    fpscr_val = if fpscr_controlled then FPSCR else StandardFPSCRValue();
    (type1,sign1,value1) = FPUunpack(op1, fpscr_val);
    (type2,sign2,value2) = FPUunpack(op2, fpscr_val);
    if type1==FPTYPE_SNaN || type1==FPTYPE_QNaN || type2==FPTYPE_SNaN || type2==FPTYPE_QNaN then
        result = FALSE;
        FPProcessException(FPExc_InvalidOp, fpscr_val);
    else
        // All non-NaN cases can be evaluated on the values produced by FPUunpack()
        result = (value1 > value2);
    return result;
```

## Floating-point maximum and minimum

```
// FPMax()
// =====

bits(N) FPMax(bits(N) op1, bits(N) op2, boolean fpscr_controlled)
    assert N IN {32,64};
    fpscr_val = if fpscr_controlled then FPSCR else StandardFPSCRValue();
    (type1,sign1,value1) = FPUunpack(op1, fpscr_val);
    (type2,sign2,value2) = FPUunpack(op2, fpscr_val);
    (done,result) = FPProcessNaNs(type1, type2, op1, op2, fpscr_val);
    if !done then
        if value1 > value2 then
            (type,sign,value) = (type1,sign1,value1);
        else
            (type,sign,value) = (type2,sign2,value2);
        if type == FPTYPE_Infinity then
            result = FPinfinity(sign, N);
        elsif type == FPTYPE_Zero then
            sign = sign1 AND sign2; // Use most positive sign
            result = FPZero(sign, N);
        else
            result = FPRound(value, N, fpscr_val);
    return result;

// FPMin()
// =====

bits(N) FPMin(bits(N) op1, bits(N) op2, boolean fpscr_controlled)
    assert N IN {32,64};
    fpscr_val = if fpscr_controlled then FPSCR else StandardFPSCRValue();
    (type1,sign1,value1) = FPUunpack(op1, fpscr_val);
    (type2,sign2,value2) = FPUunpack(op2, fpscr_val);
    (done,result) = FPProcessNaNs(type1, type2, op1, op2, fpscr_val);
    if !done then
        if value1 < value2 then
```

```

        (type,sign,value) = (type1,sign1,value1);
    else
        (type,sign,value) = (type2,sign2,value2);
    if type == FPType_Infinity then
        result = FPInfinity(sign, N);
    elsif type == FPType_Zero then
        sign = sign1 OR sign2; // Use most negative sign
        result = FPZero(sign, N);
    else
        result = FPRound(value, N, fpscr_val);
    return result;

```

## Floating-point addition and subtraction

```

// FAdd()
// =====

bits(N) FAdd(bits(N) op1, bits(N) op2, boolean fpscr_controlled)
    assert N IN {32,64};
    fpscr_val = if fpscr_controlled then FPSCR else StandardFPSCRValue();
    (type1,sign1,value1) = FPUunpack(op1, fpscr_val);
    (type2,sign2,value2) = FPUunpack(op2, fpscr_val);
    (done,result) = FPProcessNaNs(type1, type2, op1, op2, fpscr_val);
    if !done then
        inf1 = (type1 == FPType_Infinity);  inf2 = (type2 == FPType_Infinity);
        zero1 = (type1 == FPType_Zero);      zero2 = (type2 == FPType_Zero);
        if inf1 && inf2 && sign1 == NOT(sign2) then
            result = FPDefaultNaN(N);
            FPProcessException(FPExc_InvalidOp, fpscr_val);
        elsif (inf1 && sign1 == '0') || (inf2 && sign2 == '0') then
            result = FPInfinity('0', N);
        elsif (inf1 && sign1 == '1') || (inf2 && sign2 == '1') then
            result = FPInfinity('1', N);
        elsif zero1 && zero2 && sign1 == sign2 then
            result = FPZero(sign1, N);
        else
            result_value = value1 + value2;
            if result_value == 0.0 then // Sign of exact zero result depends on rounding mode
                result_sign = if fpscr_val<23:22> == '10' then '1' else '0';
                result = FPZero(result_sign, N);
            else
                result = FPRound(result_value, N, fpscr_val);
        return result;

// FSub()
// =====

bits(N) FSub(bits(N) op1, bits(N) op2, boolean fpscr_controlled)
    assert N IN {32,64};
    fpscr_val = if fpscr_controlled then FPSCR else StandardFPSCRValue();
    (type1,sign1,value1) = FPUunpack(op1, fpscr_val);
    (type2,sign2,value2) = FPUunpack(op2, fpscr_val);
    (done,result) = FPProcessNaNs(type1, type2, op1, op2, fpscr_val);
    if !done then
        inf1 = (type1 == FPType_Infinity);  inf2 = (type2 == FPType_Infinity);
        zero1 = (type1 == FPType_Zero);      zero2 = (type2 == FPType_Zero);
        if inf1 && inf2 && sign1 == sign2 then
            result = FPDefaultNaN(N);
            FPProcessException(FPExc_InvalidOp, fpscr_val);
        elsif (inf1 && sign1 == '0') || (inf2 && sign2 == '1') then
            result = FPInfinity('0', N);
        elsif (inf1 && sign1 == '1') || (inf2 && sign2 == '0') then
            result = FPInfinity('1', N);
        elsif zero1 && zero2 && sign1 == NOT(sign2) then
            result = FPZero(sign1, N);
        else
            result_value = value1 - value2;

```

```

if result_value == 0.0 then // Sign of exact zero result depends on rounding mode
    result_sign = if fpscr_val<23:22> == '10' then '1' else '0';
    result = FPZero(result_sign, N);
else
    result = FPRound(result_value, N, fpscr_val);
return result;

```

## Floating-point multiplication and division

```

// FPMul()
// =====

bits(N) FPMul(bits(N) op1, bits(N) op2, boolean fpscr_controlled)
assert N IN {32,64};
fpscr_val = if fpscr_controlled then FPSCR else StandardFPSCRValue();
(type1,sign1,value1) = FPUntpack(op1, fpscr_val);
(type2,sign2,value2) = FPUntpack(op2, fpscr_val);
(done,result) = FPProcessNaNs(type1, type2, op1, op2, fpscr_val);
if !done then
    inf1 = (type1 == FPType_Infinity); inf2 = (type2 == FPType_Infinity);
    zero1 = (type1 == FPType_Zero); zero2 = (type2 == FPType_Zero);
    if (inf1 && zero2) || (zero1 && inf2) then
        result = FPDefaultNaN(N);
        FPProcessException(FPExc_InvalidOp, fpscr_val);
    elsif inf1 || inf2 then
        result_sign = if sign1 == sign2 then '0' else '1';
        result = FPIInfinity(result_sign, N);
    elsif zero1 || zero2 then
        result_sign = if sign1 == sign2 then '0' else '1';
        result = FPZero(result_sign, N);
    else
        result = FPRound(value1*value2, N, fpscr_val);
return result;
// FPDiv()
// =====

bits(N) FPDiv(bits(N) op1, bits(N) op2, boolean fpscr_controlled)
assert N IN {32,64};
fpscr_val = if fpscr_controlled then FPSCR else StandardFPSCRValue();
(type1,sign1,value1) = FPUntpack(op1, fpscr_val);
(type2,sign2,value2) = FPUntpack(op2, fpscr_val);
(done,result) = FPProcessNaNs(type1, type2, op1, op2, fpscr_val);
if !done then
    inf1 = (type1 == FPType_Infinity); inf2 = (type2 == FPType_Infinity);
    zero1 = (type1 == FPType_Zero); zero2 = (type2 == FPType_Zero);
    if (inf1 && inf2) || (zero1 && zero2) then
        result = FPDefaultNaN(N);
        FPProcessException(FPExc_InvalidOp, fpscr_val);
    elsif inf1 || zero2 then
        result_sign = if sign1 == sign2 then '0' else '1';
        result = FPIInfinity(result_sign, N);
        if !inf1 then FPProcessException(FPExc_DivideByZero);
    elsif zero1 || inf2 then
        result_sign = if sign1 == sign2 then '0' else '1';
        result = FPZero(result_sign, N);
    else
        result = FPRound(value1/value2, N, fpscr_val);
return result;

```

## Floating-point fused multiply-add

```
// FPMulAdd()
// =====
//
// Calculates addend + op1*op2 with a single rounding.

bits(N) FPMulAdd(bits(N) addend, bits(N) op1, bits(N) op2,
                 boolean fpscr_controlled)
    assert N IN {32,64};
    fpscr_val = if fpscr_controlled then FPSCR else StandardFPSCRValue();
    (typeA,signA,valueA) = FPUunpack(addend, fpscr_val);
    (type1,sign1,value1) = FPUunpack(op1, fpscr_val);
    (type2,sign2,value2) = FPUunpack(op2, fpscr_val);
    inf1 = (type1 == FPType_Infinity); zero1 = (type1 == FPType_Zero);
    inf2 = (type2 == FPType_Infinity); zero2 = (type2 == FPType_Zero);
    (done,result) = FPProcessNaNs3(typeA, type1, type2, opA, op1, op2, fpscr_val);

    if typeA == FPType_QNaN && ((inf1 && zero2) || (zero1 && inf2)) then
        result = FPDefaultNaN(N);
        FPProcessException(FPExc_InvalidOp, fpscr_val);

    if !done then
        infA = (typeA == FPType_Infinity); zeroA = (typeA == FPType_Zero);

        // Determine sign and type product will have if it does not cause an Invalid
        // Operation.
        signP = if sign1 == sign2 then '0' else '1';
        infP = inf1 || inf2;
        zeroP = zero1 || zero2;

        // Non SNaN-generated Invalid Operation cases are multiplies of zero by infinity and
        // additions of opposite-signed infinities.
        if (inf1 && zero2) || (zero1 && inf2) || (infA && infP && signA == NOT(signP)) then
            result = FPDefaultNaN(N);
            FPProcessException(FPExc_InvalidOp, fpscr_val);

        // Other cases involving infinities produce an infinity of the same sign.
        elsif (infA && signA == '0') || (infP && signP == '0') then
            result = FPInfinity('0', N);
        elsif (infA && signA == '1') || (infP && signP == '1') then
            result = FPInfinity('1', N);

        // Cases where the result is exactly zero and its sign is not determined by the
        // rounding mode are additions of same-signed zeros.
        elsif zeroA && zeroP && signA == signP then
            result = FPZero(signA, N);

        // Otherwise calculate numerical result and round it.
        else
            result_value = valueA + (value1 * value2);
            if result_value == 0.0 then // Sign of exact zero result depends on rounding mode
                result_sign = if fpscr_val<23:22> == '10' then '1' else '0';
                result = FPZero(result_sign, N);
            else
                result = FPRound(result_value, N, fpscr_val);

    return result;
```



## Floating-point reciprocal estimate and step

The Advanced SIMD Extension includes instructions that support Newton-Raphson calculation of the reciprocal of a number.

The VRECP instruction produces the initial estimate of the reciprocal. It uses the following pseudocode functions:

```
// FPrecipEstimate()
// =====

bits(32) FPrecipEstimate(bits(32) operand)

    (type,sign,value) = FPUnpack(operand, StandardFPSCRValue());
    if type == FPType_SNaN || type == FPType_QNaN then
        result = FProcessNaN(type, operand, StandardFPSCRValue());
    elseif type == FPType_Infinity then
        result = FPZero(sign, 32);
    elseif type == FPType_Zero then
        result = FPInfinity(sign, 32);
        FProcessException(FPExc_DivideByZero, StandardFPSCRValue());
    elseif Abs(value) >= 2^126 then // Result underflows to zero of correct sign
        result = FPZero(sign, 32);
        FProcessException(FPExc_Underflow, StandardFPSCRValue());
    else
        // Operand must be normalized, since denormalized numbers are flushed to zero. Scale to a
        // double-precision value in the range 0.5 <= x < 1.0, and calculate result exponent.
        // Scaled value is positive, with:
        // exponent = 1022 = double-precision representation of 2^(-1)
        // fraction = original fraction extended with zeros.
        scaled = '0 0111111110' : operand<22:0> : Zeros(29);
        result_exp = 253 - UInt(operand<30:23>); // In range 253-252 = 1 to 253-1 = 252

        // Call C function to get reciprocal estimate of scaled value.
        estimate = recip_estimate(scaled);

        // Result is double-precision and a multiple of 1/256 in the range 1 to 511/256. Convert
        // to scaled single-precision result with the original sign bit, the copied high-order
        // fraction bits, and the exponent calculated above.
        result = sign : result_exp<7:0> : estimate<51:29>;

    return result;

// UnsignedRecipEstimate()
// =====

bits(32) UnsignedRecipEstimate(bits(32) operand)

    if operand<31> == '0' then // Operands <= 0x7FFFFFFF produce 0xFFFFFFFF
        result = Ones(32);
    else
        // Generate double-precision value = operand * 2^(-32). This has zero sign bit, with:
        // exponent = 1022 = double-precision representation of 2^(-1)
        // fraction taken from operand, excluding its most significant bit.
        dp_operand = '0 0111111110' : operand<30:0> : Zeros(21);

        // Call C function to get reciprocal estimate of scaled value.
        estimate = recip_estimate(dp_operand);

        // Result is double-precision and a multiple of 1/256 in the range 1 to 511/256.
        // Multiply by 2^31 and convert to an unsigned integer - this just involves
        // concatenating the implicit units bit with the top 31 fraction bits.
        result = '1' : estimate<51:21>;

    return result;
```

where recip\_estimate() is defined by the following C function:

```
double recip_estimate(double a)
{
    int q, s;
    double r;
    q = (int)(a * 512.0);          /* a in units of 1/512 rounded down */
    r = 1.0 / (((double)q + 0.5) / 512.0); /* reciprocal r */
    s = (int)(256.0 * r + 0.5);   /* r in units of 1/256 rounded to nearest */
    return (double)s / 256.0;
}
```

Table A2-10 shows the results where input values are out of range.

**Table A2-10 VRECPE results for out of range inputs**

Number type	Input Vm[i]	Result Vd[i]
Integer	$\leq 0x7FFFFFFF$	0xFFFFFFFF
Floating-point	NaN	Default NaN
Floating-point	$\neq 0$ or denormalized number	$\pm$ infinity <sup>a</sup>
Floating-point	$\pm$ infinity	$\pm 0$
Floating-point	Absolute value $\geq 2^{126}$	$\pm 0$

a. FPSCR.DZC is set to 1

The Newton-Raphson iteration:

$$x_{n+1} = x_n(2 - dx_n)$$

converges to  $(1/d)$  if  $x_0$  is the result of VRECPE applied to  $d$ .

The VRECPS instruction performs a  $(2 - op1 \times op2)$  calculation and can be used with a multiplication to perform a step of this iteration. The functionality of this instruction is defined by the following pseudocode function:

```
// FPrecipStep()
// =====
bits(32) FPrecipStep(bits(32) op1, bits(32) op2)
    (type1,sign1,value1) = FPUunpack(op1, StandardFPSCRValue());
    (type2,sign2,value2) = FPUunpack(op2, StandardFPSCRValue());
    (done,result) = FPProcessNaNs(type1, type2, op1, op2, StandardFPSCRValue());
    if !done then
        inf1 = (type1 == FPType_Infinity);  inf2 = (type2 == FPType_Infinity);
        zero1 = (type1 == FPType_Zero);     zero2 = (type2 == FPType_Zero);
        if (inf1 && zero2) || (zero1 && inf2) then
            product = FPZero('0', 32);
        else
            product = FPMul(op1, op2, FALSE);
            result = FPSub(FPTwo(32), product, FALSE);
    return result;
```

Table A2-11 shows the results where input values are out of range.

**Table A2-11 VRECPS results for out of range inputs**

Input Vn[i]	Input Vm[i]	Result Vd[i]
Any NaN	-	Default NaN
-	Any NaN	Default NaN
±0.0 or denormalized number	±infinity	2.0
±infinity	±0.0 or denormalized number	2.0

### Floating-point square root

```
// FPSqrt()
// =====

bits(N) FPSqrt(bits(N) operand, boolean fpscr_controlled)
    assert N IN {32,64};
    fpscr_val = if fpscr_controlled then FPSCR else StandardFPSCRValue();
    (type,sign,value) = FPUunpack(operand, fpscr_val);
    if type == FPType_SNaN || type == FPType_QNaN then
        result = FPProcessNaN(type, operand, fpscr_val);
    elseif type == FPType_Zero then
        result = FPZero(sign, N);
    elseif type == FPType_Infinity && sign == '0' then
        result = FPInfinity(sign, N);
    elseif sign == '1' then
        result = FPDefaultNaN(N);
        FPProcessException(FPExc_InvalidOp, fpscr_val);
    else
        result = FPRound(Sqrt(value), N, fpscr_val);
    return result;
```

### Floating-point reciprocal square root estimate and step

The Advanced SIMD Extension includes instructions that support Newton-Raphson calculation of the reciprocal of the square root of a number.

The VRSQRTE instruction produces the initial estimate of the reciprocal of the square root. It uses the following pseudocode functions:

```
// FPRsqrtEstimate()
// =====

bits(32) FPRsqrtEstimate(bits(32) operand)

    (type,sign,value) = FPUunpack(operand, StandardFPSCRValue());
    if type == FPType_SNaN || type == FPType_QNaN then
        result = FPProcessNaN(type, operand, StandardFPSCRValue());
    elseif type == FPType_Zero then
        result = FPInfinity(sign, 32);
        FPProcessException(FPExc_DivideByZero, StandardFPSCRValue());
    elseif sign == '1' then
        result = FPDefaultNaN(32);
        FPProcessException(FPExc_InvalidOp, StandardFPSCRValue());
    elseif type == FPType_Infinity then
        result = FPZero('0', 32);
    else
        // Operand must be normalized, since denormalized numbers are flushed to zero. Scale to a
        // double-precision value in the range 0.25 <= x < 1.0, with the evenness or oddness of
        // the exponent unchanged, and calculate result exponent.
        // Scaled value has positive sign bit, with:
```

```

//    exponent = 1022 or 1021 = double-precision representation of 2^(-1) or 2^(-2)
//    fraction = original fraction extended with zeros.
if operand<23> == '0' then
    scaled = '0 0111111110' : operand<22:0> : Zeros(29);
else
    scaled = '0 0111111101' : operand<22:0> : Zeros(29);
result_exp = (380 - UInt(operand<30:23>)) DIV 2;

// Call C function to get reciprocal estimate of scaled value.
estimate = recip_sqrt_estimate(scaled);

// Result is double-precision and a multiple of 1/256 in the range 1 to 511/256. Convert
// to scaled single-precision result with positive sign bit and high-order fraction bits,
// and exponent calculated above.
result = '0' : result_exp<7:0> : estimate<51:29>;

return result;

// UnsignedRSqrtEstimate()
// =====
bits(32) UnsignedRSqrtEstimate(bits(32) operand)

if operand<31:30> == '00' then // Operands <= 0x3FFFFFFF produce 0xFFFFFFFF
    result = Ones(32);
else
    // Generate double-precision value = operand * 2^(-32). This has zero sign bit, with:
    //    exponent = 1022 or 1021 = double-precision representation of 2^(-1) or 2^(-2)
    //    fraction taken from operand, excluding its most significant one or two bits.
    if operand<31> == '1' then
        dp_operand = '0 0111111110' : operand<30:0> : Zeros(21);
    else // operand<31:30> == '01'
        dp_operand = '0 0111111101' : operand<29:0> : Zeros(22);

    // Call C function to get reciprocal estimate of scaled value.
    estimate = recip_sqrt_estimate(dp_operand);

    // Result is double-precision and a multiple of 1/256 in the range 1 to 511/256.
    // Multiply by 2^31 and convert to an unsigned integer - this just involves
    // concatenating the implicit units bit with the top 31 fraction bits.
    result = '1' : estimate<51:21>;

return result;

```

where recip\_sqrt\_estimate() is defined by the following C function:

```

double recip_sqrt_estimate(double a)
{
    int q0, q1, s;
    double r;
    if (a < 0.5) /* range 0.25 <= a < 0.5 */
    {
        q0 = (int)(a * 512.0); /* a in units of 1/512 rounded down */
        r = 1.0 / sqrt(((double)q0 + 0.5) / 512.0); /* reciprocal root r */
    }
    else /* range 0.5 <= a < 1.0 */
    {
        q1 = (int)(a * 256.0); /* a in units of 1/256 rounded down */
        r = 1.0 / sqrt(((double)q1 + 0.5) / 256.0); /* reciprocal root r */
    }
    s = (int)(256.0 * r + 0.5); /* r in units of 1/256 rounded to nearest */
    return (double)s / 256.0;
}

```

Table A2-12 shows the results where input values are out of range.

**Table A2-12 VRSQRTE results for out of range inputs**

Number type	Input Vm[i]	Result Vd[i]
Integer	$\leq 0x3FFFFFFF$	0xFFFFFFFF
Floating-point	NaN, -(normalized number), -infinity	Default NaN
Floating-point	-0 or -(denormalized number)	-infinity <sup>a</sup>
Floating-point	+0 or +(denormalized number)	+infinity <sup>a</sup>
Floating-point	+infinity	+0

a. FPSCR.DZC is set to 1.

The Newton-Raphson iteration:

$$x_{n+1} = x_n(3 - dx_n^2)/2$$

converges to  $(1/\sqrt{d})$  if  $x_0$  is the result of VRSQRTE applied to  $d$ .

The VRSQRTS instruction performs a  $(3 - op1 \times op2)/2$  calculation and can be used with two multiplications to perform a step of this iteration. The FPRSqrtStep() pseudocode function defines the functionality of this instruction:

```
// FPRSqrtStep()
// =====
bits(32) FPRSqrtStep(bits(32) op1, bits(32) op2)
    (type1,sign1,value1) = FPUntpack(op1, StandardFPSCRValue());
    (type2,sign2,value2) = FPUntpack(op2, StandardFPSCRValue());
    (done,result) = FPProcessNaNs(type1, type2, op1, op2, StandardFPSCRValue());
    if !done then
        inf1 = (type1 == FPType_Infinity);  inf2 = (type2 == FPType_Infinity);
        zero1 = (type1 == FPType_Zero);      zero2 = (type2 == FPType_Zero);
        if (inf1 && zero2) || (zero1 && inf2) then
            product = FPZero('0', 32);
        else
            product = FPMul(op1, op2, FALSE);
            result = FPHalvedSub(FPThree(32), product, FALSE);
    return result;
```

Table A2-13 shows the results where input values are out of range.

**Table A2-13 VRSQRTS results for out of range inputs**

Input Vn[i]	Input Vm[i]	Result Vd[i]
Any NaN	-	Default NaN
-	Any NaN	Default NaN
$\pm 0.0$ or denormalized number	$\pm$ infinity	1.5
$\pm$ infinity	$\pm 0.0$ or denormalized number	1.5

FPRsqrtStep() calls the FPHalvedSub() pseudocode function:

```
// FPHalvedSub()
// =====

bits(N) FPHalvedSub(bits(N) op1, bits(N) op2, boolean fpscr_controlled)
assert N IN {32,64};
fpscr_val = if fpscr_controlled then FPSCR else StandardFPSCRValue();
(type1,sign1,value1) = FPUunpack(op1, fpscr_val);
(type2,sign2,value2) = FPUunpack(op2, fpscr_val);
(done,result) = FPProcessNaNs(type1, type2, op1, op2, fpscr_val);
if !done then
    inf1 = (type1 == FPType_Infinity);  inf2 = (type2 == FPType_Infinity);
    zero1 = (type1 == FPType_Zero);     zero2 = (type2 == FPType_Zero);
    if inf1 && inf2 && sign1 == sign2 then
        result = FPDefaultNaN(N);
        FPProcessException(FPExc_InvalidOp, fpscr_val);
    elseif (inf1 && sign1 == '0') || (inf2 && sign2 == '1') then
        result = FPInfinity('0', N);
    elseif (inf1 && sign1 == '1') || (inf2 && sign2 == '0') then
        result = FPInfinity('1', N);
    elseif zero1 && zero2 && sign1 == NOT(sign2) then
        result = FPZero(sign1, N);
    else
        result_value = (value1 - value2) / 2.0;
        if result_value == 0.0 then // Sign of exact zero result depends on rounding mode
            result_sign = if fpscr_val<23:22> == '10' then '1' else '0';
            result = FPZero(result_sign, N);
        else
            result = FPRound(result_value, N, fpscr_val);
return result;
```

## Floating-point conversions

The following functions perform conversions between half-precision and single-precision floating-point numbers.

```
// FPHalfToSingle()
// =====

bits(32) FPHalfToSingle(bits(16) operand, boolean fpscr_controlled)
fpscr_val = if fpscr_controlled then FPSCR else StandardFPSCRValue();
(type,sign,value) = FPUunpack(operand, fpscr_val);
if type == FPType_SNaN || type == FPType_QNaN then
    if fpscr_val<25> == '1' then // DN bit set
        result = FPDefaultNaN(32);
    else
        result = sign : '1111111 1' : operand<8:0> : Zeros(13);
    if type == FPType_SNaN then
        FPProcessException(FPExc_InvalidOp, fpscr_val);
elseif type == FPType_Infinity then
    result = FPInfinity(sign, 32);
elseif type == FPType_Zero then
    result = FPZero(sign, 32);
else
    result = FPRound(value, 32, fpscr_val); // Rounding will be exact
return result;

// FPSingleToHalf()
// =====

bits(16) FPSingleToHalf(bits(32) operand, boolean fpscr_controlled)
fpscr_val = if fpscr_controlled then FPSCR else StandardFPSCRValue();
(type,sign,value) = FPUunpack(operand, fpscr_val);
if type == FPType_SNaN || type == FPType_QNaN then
    if fpscr_val<26> == '1' then // AH bit set
        result = FPZero(sign, 16);
    elseif fpscr_val<25> == '1' then // DN bit set
```

```

        result = FPDefaultNaN(16);
    else
        result = sign : '11111 1' : operand<21:13>;
        if type == FPType_SNaN || fpscr_val<26> == '1' then
            FPProcessException(FPExc_InvalidOp, fpscr_val);
    elseif type == FPType_Infinity then
        if fpscr_val<26> == '1' then // AH bit set
            result = sign : Ones(15);
            FPProcessException(FPExc_InvalidOp, fpscr_val);
        else
            result = FPInfinity(sign, 16);
    elseif type == FPType_Zero then
        result = FPZero(sign, 16);
    else
        result = FPRound(value, 16, fpscr_val);
    return result;

```

The following functions perform conversions between single-precision and double-precision floating-point numbers.

```

// FPSingleToDouble()
// =====

bits(64) FPSingleToDouble(bits(32) operand, boolean fpscr_controlled)
    fpscr_val = if fpscr_controlled then FPSCR else StandardFPSCRValue();
    (type,sign,value) = FPUunpack(operand, fpscr_val);
    if type == FPType_SNaN || type == FPType_QNaN then
        if fpscr_val<25> == '1' then // DN bit set
            result = FPDefaultNaN(64);
        else
            result = sign : '1111111111 1' : operand<21:0> : Zeros(29);
            if type == FPType_SNaN then
                FPProcessException(FPExc_InvalidOp, fpscr_val);
    elseif type == FPType_Infinity then
        result = FPInfinity(sign, 64);
    elseif type == FPType_Zero then
        result = FPZero(sign, 64);
    else
        result = FPRound(value, 64, fpscr_val); // Rounding will be exact
    return result;

// FPDoubleToSingle()
// =====

bits(32) FPDoubleToSingle(bits(64) operand, boolean fpscr_controlled)
    fpscr_val = if fpscr_controlled then FPSCR else StandardFPSCRValue();
    (type,sign,value) = FPUunpack(operand, fpscr_val);
    if type == FPType_SNaN || type == FPType_QNaN then
        if fpscr_val<25> == '1' then // DN bit set
            result = FPDefaultNaN(32);
        else
            result = sign : '1111111 1' : operand<50:29>;
            if type == FPType_SNaN then
                FPProcessException(FPExc_InvalidOp, fpscr_val);
    elseif type == FPType_Infinity then
        result = FPInfinity(sign, 32);
    elseif type == FPType_Zero then
        result = FPZero(sign, 32);
    else
        result = FPRound(value, 32, fpscr_val);
    return result;

```

The following functions perform conversions between floating-point numbers and integers or fixed-point numbers:

```
// FPToFixed()
// =====

bits(M) FPToFixed(bits(N) operand, integer M, integer fraction_bits, boolean unsigned,
                  boolean round_towards_zero, boolean fpscr_controlled)
    assert N IN {32,64};
    fpscr_val = if fpscr_controlled then FPSCR else StandardFPSCRValue();
    if round_towards_zero then fpscr_val<23:22> = '11';
    (type,sign,value) = FPUunpack(operand, fpscr_val);

    // For NaNs and infinities, FPUunpack() has produced a value that will round to the
    // required result of the conversion. Also, the value produced for infinities will
    // cause the conversion to overflow and signal an Invalid Operation floating-point
    // exception as required. NaNs must also generate such a floating-point exception.
    if type == FPType_SNaN || type == FPType_QNaN then
        FPProcessException(FPExc_InvalidOp, fpscr_val);

    // Scale value by specified number of fraction bits, then start rounding to an integer
    // and determine the rounding error.
    value = value * 2^fraction_bits;
    int_result = RoundDown(value);
    error = value - int_result;

    // Apply the specified rounding mode.
    case fpscr_val<23:22> of
        when '00' // Round to Nearest (rounding to even if exactly halfway)
            round_up = (error > 0.5 || (error == 0.5 && int_result<0> == '1'));
        when '01' // Round towards Plus Infinity
            round_up = (error != 0.0);
        when '10' // Round towards Minus Infinity
            round_up = FALSE;
        when '11' // Round towards Zero
            round_up = (error != 0.0 && int_result < 0);
    if round_up then int_result = int_result + 1;

    // Bitstring result is the integer result saturated to the destination size, with
    // saturation indicating overflow of the conversion (signaled as an Invalid
    // Operation floating-point exception).
    (result, overflow) = SatQ(int_result, M, unsigned);
    if overflow then
        FPProcessException(FPExc_InvalidOp, fpscr_val);
    elsif error != 0 then
        FPProcessException(FPExc_Inexact, fpscr_val);

    return result;

// FixedToFP()
// =====

bits(N) FixedToFP(bits(M) operand, integer N, integer fraction_bits, boolean unsigned,
                  boolean round_to_nearest, boolean fpscr_controlled)
    assert N IN {32,64};
    fpscr_val = if fpscr_controlled then FPSCR else StandardFPSCRValue();
    if round_to_nearest then fpscr_val<23:22> = '00';
    int_operand = if unsigned then UInt(operand) else SInt(operand);
    real_operand = int_operand / 2^fraction_bits;
    if real_operand == 0.0 then
        result = FPZero('0', N);
    else
        result = FPRound(real_operand, N, fpscr_val);
    return result;
```



## A2.8 Polynomial arithmetic over {0, 1}

Some Advanced SIMD instructions can operate on polynomials over {0, 1}, see [Data types supported by the Advanced SIMD Extension on page A2-59](#). The polynomial data type represents a polynomial in  $x$  of the form  $b_{n-1}x^{n-1} + \dots + b_1x + b_0$  where  $b_k$  is bit[k] of the value.

The coefficients 0 and 1 are manipulated using the rules of Boolean arithmetic:

- $0 + 0 = 1 + 1 = 0$
- $0 + 1 = 1 + 0 = 1$
- $0 \times 0 = 0 \times 1 = 1 \times 0 = 0$
- $1 \times 1 = 1$ .

That is:

- adding two polynomials over {0, 1} is the same as a bitwise exclusive OR
- multiplying two polynomials over {0, 1} is the same as integer multiplication except that partial products are exclusive-ORed instead of being added.

———— **Note** —————

The instructions that can perform polynomials arithmetic over {0, 1} are VMUL and VMULL, see [VMUL, VMULL \(integer and polynomial\) on page A8-958](#).

### A2.8.1 Pseudocode details of polynomial multiplication

In pseudocode, polynomial addition is described by the EOR operation on bitstrings.

Polynomial multiplication is described by the PolynomialMult() function:

```
// PolynomialMult()
// =====
bits(M+N) PolynomialMult(bits(M) op1, bits(N) op2)
    result = Zeros(M+N);
    extended_op2 = Zeros(M) : op2;
    for i=0 to M-1
        if op1<i> == '1' then
            result = result EOR LSL(extended_op2, i);
    return result;
```

## A2.9 Coprocessor support

The ARM architecture supports coprocessors, to extend the functionality of an ARM processor. The coprocessor instructions summarized in [Coprocessor instructions on page A4-180](#) provide access to sixteen coprocessors, described as CP0 to CP15. The following coprocessors are reserved by ARM for specific purposes:

- Coprocessor 15 (CP15) provides system control functionality. This includes architecture and feature identification, as well as control, status information and configuration support.  
For a VMSA implementation, the following sections give a general description of CP15:
  - [About the system control registers for VMSA on page B3-1444](#)
  - [Organization of the CP15 registers in a VMSA implementation on page B3-1469](#)
  - [Functional grouping of VMSAv7 system control registers on page B3-1491](#).For a PMSA implementation, the following sections give a general description of CP15:
  - [About the system control registers for PMSA on page B5-1772](#)
  - [Organization of the CP15 registers in a PMSA implementation on page B5-1785](#)
  - [Functional grouping of PMSAv7 system control registers on page B5-1797](#).CP15 also provides performance monitor registers, see [Chapter C12 The Performance Monitors Extension](#).
- Coprocessor 14 (CP14) supports:
  - debug, see [Chapter C6 Debug Register Interfaces](#)
  - the Thumb Execution Environment, see [Thumb Execution Environment on page A2-95](#)
  - direct Java bytecode execution, see [Jazelle direct bytecode execution support on page A2-97](#).
- Coprocessors 10 and 11 (CP10 and CP11) together support floating-point and vector operations, and the control and configuration of the Floating-point and Advanced SIMD architecture extensions.
- Coprocessors 8, 9, 12, and 13 are reserved for future use by ARM. Any coprocessor access instruction attempting to access one of these coprocessors is UNDEFINED.

---

**Note**

In an implementation that includes either or both of the Advanced SIMD Extension and the Floating-point (VFP) Extension, to permit execution of any floating-point or Advanced SIMD instructions, software must enable access to both CP10 and CP11, see [Enabling Advanced SIMD and floating-point support on page B1-1228](#).

---

The following sections give information more information about permitted accesses to coprocessors CP14 and CP15:

- [UNPREDICTABLE and UNDEFINED behavior for CP14 and CP15 accesses on page B3-1446](#), for a VMSA implementation
- [UNPREDICTABLE and UNDEFINED behavior for CP14 and CP15 accesses on page B5-1774](#), for a PMSA implementation.

Most CP14 and CP15 functions cannot be accessed by software executing at PL0. This manual clearly identifies those functions that can be accessed at PL0.

Software executing at PL1 can enable the unprivileged execution of all load, store, branch and data operation instructions associated with floating-point, Advanced SIMD and execution environment support.

Coprocessors 0 to 7 can provide vendor-specific features.

## A2.10 Thumb Execution Environment

*Thumb Execution Environment* (ThumbEE) is a variant of the Thumb instruction set designed as a target for dynamically generated code. This is code that is compiled on the device, from a portable bytecode or other intermediate or native representation, either shortly before or during execution. ThumbEE provides support for *Just-In-Time* (JIT), *Dynamic Adaptive Compilation* (DAC), and *Ahead-Of-Time* (AOT) compilers, but cannot interwork freely with the ARM and Thumb instruction sets.

From the publication of issue C.a of this manual, ARM deprecates any use of the ThumbEE instruction set.

ThumbEE is particularly suited to languages that feature managed pointers and array types. The processor executes ThumbEE instructions when it is in the ThumbEE instruction set state. For information about instruction set states see [Instruction set state register, ISETSTATE on page A2-50](#).

ThumbEE is both the name of the instruction set and the name of the extension that provides support for that instruction set. The ThumbEE Extension is:

- required in implementations of the ARMv7-A profile
- optional in implementations of the ARMv7-R profile.

See [Thumb Execution Environment on page B1-1239](#) for system level information about ThumbEE.

### A2.10.1 ThumbEE instructions

In ThumbEE state, the processor executes almost the same instruction set as in Thumb state. However some instructions behave differently, some are removed, and some ThumbEE instructions are added.

The key differences are:

- additional instructions to change instruction set in both Thumb state and ThumbEE state
- new ThumbEE instructions to branch to handlers
- null pointer checking on load/store instructions executed in ThumbEE state
- an additional instruction in ThumbEE state to check array bounds
- some other modifications to load, store, and control flow instructions.

For more information about the ThumbEE instructions see [Chapter A9 The ThumbEE Instruction Set](#).

### A2.10.2 ThumbEE configuration

ThumbEE introduces two new CP14 registers, that [Table A2-14](#) shows. These are 32-bit registers:

**Table A2-14 ThumbEE register summary**

Name, VMSA <sup>a</sup>	Name, PMSA <sup>a</sup>	CRn	opc1	CRm	opc2	Width	Type	Description
<a href="#">TEECR</a>	<a href="#">TEECR</a>	c0	6	c0	0	32-bit	RW	ThumbEE Configuration Register
<a href="#">TEEHBR</a>	<a href="#">TEEHBR</a>	c1	6	c0	0	32-bit	RW	ThumbEE Handler Base Register

a. VMSA and PMSA definitions of the register fields are identical. These columns link to the descriptions in [Chapter B4](#) and in [Chapter B6](#).

ThumbEE is an unprivileged, user-level facility, and there are no special provisions for using it securely. For more information, see [ThumbEE and the Security Extensions and Virtualization Extensions on page B1-1239](#).

## Use of HandlerBase

ThumbEE handlers are entered by reference to a HandlerBase address, defined by the [TEEHBR](#). In addition to the handlers for IndexCheck and NullCheck, there are 256 handlers, Handler\_00 to Handler\_FF, at 32-byte offsets from HandlerBase. [Table A2-15](#) shows the arrangement of handlers relative to the value of HandlerBase:

**Table A2-15 Access to ThumbEE handlers**

Offset from HandlerBase	Name	Value stored
-0x0008	IndexCheck	Branch to IndexCheck handler
-0x0004	NullCheck	Branch to NullCheck handler
0x0000	Handler_00	Implementation of Handler_00
0x0020	Handler_01	Implementation of Handler_01
...	...	...
0x1FC0	Handler_FE	Implementation of Handler_FE
0x1FE0	Handler_FF	Implementation of Handler_FF

The IndexCheck occurs when a CHKA instruction detects an index out of range. For more information, see [CHKA on page A9-1124](#).

The NullCheck occurs when any memory access instruction is executed with a value of 0 in the base register. For more information, see [Null checking on page A9-1113](#).

———— **Note** —————

*Checks* are similar to conditional branches, with the added property that they clear the IT bits when taken.

The other handlers are called using explicit handler call instructions:

- HB and HBL can call any handler, that is, can call Handler\_00-Handler\_FF
- HBLP and HBP can call only Handler\_00-Handler\_31.

For more information see the following instruction descriptions:

- [HB, HBL on page A9-1125](#)
- [HBLP on page A9-1126](#)
- [HBP on page A9-1127](#).

## A2.11 Jazelle direct bytecode execution support

From ARMv5TEJ, the architecture requires every system to include an implementation of the Jazelle extension. The Jazelle extension provides architectural support for hardware acceleration of bytecode execution by a *Java Virtual Machine* (JVM).

In the simplest implementations of the Jazelle extension, the processor does not accelerate the execution of any bytecodes, and the JVM uses software routines to execute all bytecodes. Such an implementation is called a *trivial implementation* of the Jazelle extension, and has minimal additional cost compared with not implementing the Jazelle extension at all. An implementation that provides hardware acceleration of bytecode execution is a non-trivial Jazelle implementation.

The Virtualization Extensions require that the Jazelle implementation is the trivial Jazelle implementation.

These requirements for the Jazelle extension mean a JVM can be written to both:

- function correctly on all processors that include a Jazelle extension implementation
- automatically take advantage of the accelerated bytecode execution provided by a processor that includes a non-trivial implementation.

A non-trivial implementation of the Jazelle extension implements a subset of the bytecodes in hardware, choosing bytecodes that:

- can have simple hardware implementations
- account for a large percentage of bytecode execution time.

The required features of a non-trivial implementation are:

- provision of the Jazelle state
- a new instruction, BXJ, to enter Jazelle state
- system support that enables an operating system to regulate the use of the Jazelle extension hardware
- system support that enables a JVM to configure the Jazelle extension hardware to its specific needs.

The required features of a trivial implementation are:

- Normally, the Jazelle instruction set state is never entered. In some implementations, an incorrect exception return can cause entry to the Jazelle instruction set state. If this happens, the next instruction executed is treated as UNDEFINED. For more information, see [Unimplemented instruction sets on page B1-1155](#).
- The BXJ instruction behaves as a BX instruction.
- Configuration support that maintains the interface to the Jazelle extension is permanently disabled.

For more information about trivial implementations see [Trivial implementation of the Jazelle extension on page B1-1244](#).

A JVM that has been written to take advantage automatically of hardware-accelerated bytecode execution is called an *Enabled JVM* (EJVM).

### A2.11.1 Subarchitectures

A processor implementation that includes the Jazelle extension expects the ARM core register values and other resources of the ARM processor to conform to an interface standard defined by the Jazelle implementation when Jazelle state is entered and exited. For example, a specific ARM core register might be reserved for use as the pointer to the current bytecode.

For an EJVM, and any associated debug support, to function correctly, it must be written to comply with the interface standard defined by the acceleration hardware at Jazelle state execution entry and exit points.

An implementation of the Jazelle extension might define other configuration registers in addition to the architecturally defined ones.

The interface standard and any additional configuration registers used for communication with the Jazelle extension are known collectively as the *subarchitecture* of the implementation. They are not described in this manual. Only EJVM implementations and debug or similar software can depend on the subarchitecture. All other software must rely only on the architectural definition of the Jazelle extension given in this manual. A particular subarchitecture is identified by reading the [JIDR](#).

### A2.11.2 Jazelle state

While the processor is in Jazelle state, it executes bytecode programs. A bytecode program is defined as an executable object that comprises one or more `class` files, or is derived from and functionally equivalent to one or more `class` files. See *The Java Virtual Machine Specification* for the definition of `class` files.

While the processor is in Jazelle state, the PC identifies the next JVM bytecode to be executed. A JVM bytecode is a bytecode defined in *The Java Virtual Machine Specification*, or a functionally equivalent transformed version of a bytecode defined in that specification.

For the Jazelle extension, the functionality of *Native methods*, as described in *The Java Virtual Machine Specification*, must be specified using only instructions from the ARM, Thumb, and ThumbEE instruction sets.

An implementation of the Jazelle extension must not be documented or promoted as performing any task while it is in Jazelle state other than the acceleration of bytecode programs in accordance with this section and the descriptions in the *The Java Virtual Machine Specification*.

### A2.11.3 Jazelle state entry instruction, BXJ

ARMv7 includes an ARM instruction similar to BX. The BXJ instruction has a single register operand that specifies a target instruction set state, ARM state or Thumb state, and branch target address for use if entry to Jazelle state is not available. For more information, see [BXJ on page A8-354](#).

Correct entry into Jazelle state involves the EJVM executing the BXJ instruction at a time when both:

- the Jazelle extension Control and Configuration registers are initialized correctly, see [Application level configuration and control of the Jazelle extension on page A2-99](#)
- application level registers and any additional configuration registers are initialized as required by the subarchitecture of the implementation.

#### Executing BXJ with Jazelle extension enabled

Executing a BXJ instruction when the `JMCR.JE` bit is 1 causes the Jazelle hardware to do one of the following:

- enter Jazelle state and start executing bytecodes directly from a `SUBARCHITECTURE DEFINED` address
- branch to a `SUBARCHITECTURE DEFINED` handler.

Which of these occurs is `SUBARCHITECTURE DEFINED`.

The Jazelle subarchitecture can use Application level registers, but not System level registers, to transfer information between the Jazelle extension and the EJVM. There are `SUBARCHITECTURE DEFINED` restrictions on what Application level registers must contain when a BXJ instruction is executed, and Application level registers have `SUBARCHITECTURE DEFINED` values when Jazelle state execution ends and ARM or Thumb state execution resumes.

Jazelle subarchitectures and implementations must not use any unallocated bits in Application level registers such as the [CPSR](#) or [FPSCR](#). All such bits are reserved for future expansion of the ARM architecture.

#### Executing BXJ with Jazelle extension disabled

If a BXJ instruction is executed when the `JMCR.JE` bit is 0, it is executed identically to a BX instruction with the same register operand.

This means that BXJ instructions can be executed freely when the **JMCR.JE** bit is 0. In particular, if an EJVM determines that it is executing on a processor whose Jazelle extension implementation is trivial or uses an incompatible subarchitecture, it can set JE to 0 and execute correctly. In this case it executes without the benefit of any Jazelle hardware acceleration that might be present.

#### A2.11.4 Application level configuration and control of the Jazelle extension

The Jazelle extension registers are implemented as CP14 registers. [Table A2-16](#) summarizes the architecturally-defined Jazelle registers. Additional SUBARCHITECTURE DEFINED configuration registers might be provided.

**Table A2-16 Jazelle architecturally-defined registers summary**

Name, VMSA <sup>a</sup>	Name, PMSA <sup>a</sup>	CRn	opc1	CRm	opc2	Width	Type <sup>b</sup>	Description
<a href="#">JIDR</a>	<a href="#">JIDR</a>	c0	7	c0	0	32-bit	RO	Jazelle ID Register
<a href="#">JOSCR</a>	<a href="#">JOSCR</a>	c1	7	c0	0	32-bit	RW	Jazelle OS Control Register
<a href="#">JMCR</a>	<a href="#">JMCR</a>	c2	7	c0	0	32-bit	RW	Jazelle Main Configuration Register

- VMSA and PMSA definitions of the register fields are identical. These columns link to the descriptions in [Chapter B4](#) and [Chapter B6](#).
- Type, for a non-trivial Jazelle implementation. [Trivial implementation of the Jazelle extension on page B1-1244](#) describes the register requirements for a trivial Jazelle implementation.

An EJVM can read the [JIDR](#) to determine the architecture and subarchitecture under which it is running, and:

- the [JMCR](#) gives application level control of Jazelle operation
- the [JOSCR](#) gives OS level control of Jazelle operation

The following rules apply to all Jazelle extension control and configuration registers, including any SUBARCHITECTURE DEFINED registers:

- Registers are accessed by CP14 MRC and MCR instructions with <opc1> set to 7.
- The values contained in configuration registers are changed only by the execution of MCR instructions. In particular, they are never changed by Jazelle state execution of bytecodes.
- The access policy for each architecturally-defined register is fully defined in the register description. The access policy of other configuration registers is SUBARCHITECTURE DEFINED.

When execution is unprivileged, MRC and MCR accesses that are restricted to execution at PL1 or higher are UNDEFINED.

For more information see [Access to Jazelle registers on page A2-100](#).

- In an implementation that includes the Security Extensions, the registers are Common registers, meaning they are common to the Secure and Non-secure security states. For more information, see [Classification of system control registers on page B3-1451](#).
- When a configuration register is readable, reading the register:
  - returns the last value written to it
  - has no side-effects.

When a configuration register is not readable, attempting to read it returns an UNKNOWN value.

- When a configuration register can be written, the effect of writing to it must be idempotent. That is, the overall effect of writing the same value more than once must not differ from the effect of writing it once.

Changes to these CP14 registers have the same synchronization requirements as changes to the CP15 registers. These are described in:

- [Synchronization of changes to system control registers on page B3-1461](#) for a VMSA implementation
- [Synchronization of changes to system control registers on page B5-1777](#) for a PMSA implementation.

For more information, see [Jazelle state configuration and control on page B1-1242](#).

## A2.11.5 Access to Jazelle registers

For a non-trivial Jazelle implementation, [Table A2-17](#) shows the access permissions for the Jazelle registers, and how unprivileged access to the registers depends on the value of the `JOSCR`.

**Table A2-17 Access to Jazelle registers in a non-trivial Jazelle implementation**

Jazelle register		Unprivileged access		Access at PL1
VMSA	PMSA	JOSCR.CD is 0	JOSCR.CD is 1	
JOSCR	JOSCR	Read and write access UNDEFINED	Read and write access UNDEFINED	Read and write access permitted
JIDR	JIDR	Read access permitted	Read access UNDEFINED	Read access permitted
		Write access UNDEFINED	Write access UNDEFINED	Write access UNPREDICTABLE
JMCR	JMCR	Read access UNDEFINED	Read and write access UNDEFINED	Read and write access permitted
		Write access permitted		
SUBARCHITECTURE DEFINED configuration registers		Read access UNDEFINED	Read and write access UNDEFINED	Read access SUBARCHITECTURE DEFINED
		Write access permitted		Write access permitted

*Trivial implementation of the Jazelle extension on page B1-1244* describes the required behavior of Jazelle register accesses for a trivial Jazelle implementation.

## A2.11.6 EJVM operation

The following subsections summarize how an EJVM must operate, to meet the requirements of the architecture:

- [Initialization](#)
- [Bytecode execution](#)
- [Jazelle exception conditions on page A2-101](#)
- [Other considerations on page A2-101](#).

### Initialization

During initialization, the EJVM must first check which subarchitecture is present, by checking the Implementer and Subarchitecture codes in the value read from the `JIDR`.

If the EJVM is incompatible with the subarchitecture, it must do one of the following:

- write to the `JMCR` with `JE` set to 0
- if unaccelerated bytecode execution is unacceptable, generate an error.

If the EJVM is compatible with the subarchitecture, it must write its required configuration to the `JMCR` and any `SUBARCHITECTURE DEFINED` configuration registers.

### Bytecode execution

The EJVM must contain a handler for each bytecode.

The EJVM initiates bytecode execution by executing a `BJX` instruction with:

- the register operand specifying the target address of the bytecode handler for the first bytecode of the program
- the Application level registers set up in accordance with the `SUBARCHITECTURE DEFINED` interface standard.

The bytecode handler:

- performs the data-processing operations required by the bytecode indicated



- determines the address of the next bytecode to be executed
- determines the address of the handler for that bytecode
- performs a BXJ to that handler address with the registers again set up to the SUBARCHITECTURE DEFINED interface standard.

### Jazelle exception conditions

During bytecode execution, the EJVM might encounter SUBARCHITECTURE DEFINED Jazelle exception conditions that must be resolved by a software handler. For example, in the case of a *configuration invalid* handler, the handler rewrites the desired configuration to the JMCR and to any SUBARCHITECTURE DEFINED configuration registers.

On entry to a Jazelle exception condition handler the contents of the Application level registers are SUBARCHITECTURE DEFINED. This interface to the Jazelle exception condition handler might differ from the interface standard for the bytecode handler, in order to supply information about the Jazelle exception condition.

The Jazelle exception condition handler:

- resolves the Jazelle exception condition
- determines the address of the next bytecode to be executed
- determines the address of the handler for that bytecode
- performs a BXJ to that handler address with the registers again set up to the SUBARCHITECTURE DEFINED interface standard.

### Other considerations

To ensure application execution and correct interaction with an operating system, an EJVM must only perform operations that are permitted in unprivileged operation. In particular, for register accesses they must only:

- read the JIDR,
- write to the JMCR, and other configuration registers.

An EJVM must not attempt to access the JOSCR.

## A2.12 Exceptions, debug events and checks

ARMv7 uses the following terms to describe various types of exceptional condition:

**Exceptions** In the ARM architecture, an *exception* causes entry into a processor mode that executes software at PL1 or PL2, and execution of a software handler for the exception.

———— **Note** —————

The terms *floating-point exception* and *Jazelle exception condition* do not use this meaning of *exception*. These terms are described later in this list.

Exceptions include:

- reset
- interrupts
- memory system aborts
- undefined instructions
- supervisor calls (SVCs), Secure Monitor calls (SMCs), and hypervisor calls (HVCs).

Most details of exception handling are not visible to application level software, and are described in [Exception handling on page B1-1164](#). Aspects that are visible to application level software are:

- The SVC instruction causes a Supervisor Call exception. This provides a mechanism for unprivileged software to make a call to the operating system, or other system component that is accessible only at PL1.
- In an implementation that includes the Security Extensions, the SMC instruction causes a Secure Monitor Call exception, but only if software execution is at PL1 or higher. Unprivileged software can only cause a Secure Monitor Call exception by methods defined by the operating system, or by another component of the software system that executes at PL1 or higher.
- In an implementation that includes the Virtualization Extensions, the HVC instruction causes a Hypervisor Call exception, but only if software execution is at PL1 or higher. Unprivileged software can only cause a Hypervisor Call exception by methods defined by the hypervisor, or by another component of the software system that executes at PL1 or higher.
- The WFI instruction provides a hint that nothing needs to be done until the processor takes an interrupt or similar exception, see [Wait For Interrupt on page B1-1202](#). This permits the processor to enter a low-power state until that happens.
- The WFE instruction provides a hint that nothing needs to be done until either an SEV instruction generates an *event*, or the processor takes an interrupt or similar exception, see [Wait For Event and Send Event on page B1-1199](#). This permits the processor to enter a low-power state until one of these happens.

### Floating-point exceptions

These relate to exceptional conditions encountered during floating-point arithmetic, such as division by zero or overflow. For more information see:

- [Floating-point exceptions on page A2-70](#)
- [FPSCR, Floating-point Status and Control Register, VMSA on page B4-1569](#), or [FPSCR, Floating-point Status and Control Register, PMSA on page B6-1845](#)
- ANSI/IEEE Std. 754, *IEEE Standard for Binary Floating-Point Arithmetic*.

### Jazelle exception conditions

These are conditions that cause Jazelle hardware acceleration to exit into a software handler, as described in [Jazelle exception conditions on page A2-101](#).

**Debug events** These are conditions that cause a debug system to take action. Most aspects of debug events are not visible to application level software, and are described in [Chapter C3 Debug Events](#). Aspects that are visible to application level software include:

- The BKPT instruction causes a BKPT instruction debug event to occur, see [BKPT instruction debug events on page C3-2038](#).
- The DBG instruction provides a hint to the debug system.

**Checks** These are provided in the ThumbEE Extension. A check causes an unconditional branch to a specific handler entry point. The base address of the ThumbEE check handlers is held in the [TEEHBR](#).



# Chapter A3

## Application Level Memory Model

This chapter gives an application level view of the memory model. It contains the following sections:

- *Address space* on page A3-106
- *Alignment support* on page A3-108
- *Endian support* on page A3-110
- *Synchronization and semaphores* on page A3-114
- *Memory types and attributes and the memory order model* on page A3-125
- *Access rights* on page A3-141
- *Virtual and physical addressing* on page A3-144
- *Memory access order* on page A3-145
- *Caches and memory hierarchy* on page A3-155.

---

**Note**

In this chapter, system register names usually link to the description of the register in [Chapter B4 System Control Registers in a VMSA implementation](#), for example SCTLR. If the register is included in a PMSA implementation, then it is also described in [Chapter B6 System Control Registers in a PMSA implementation](#).

---

## A3.1 Address space

The ARM architecture Application level memory model uses a single, flat address space of  $2^{32}$  8-bit bytes, covering 4GBytes. Byte addresses are treated as unsigned numbers, running from 0 to  $2^{32} - 1$ . The address space is also regarded as:

- $2^{30}$  32-bit words:
  - the address of each word is word-aligned, meaning that the address is divisible by 4 and the least significant bits of the address are `0b00`
  - the word at word-aligned address *A* consists of the four bytes with addresses *A*, *A*+1, *A*+2 and *A*+3.
- $2^{31}$  16-bit halfwords:
  - the address of each halfword is halfword-aligned, meaning that the address is divisible by 2 and the least significant bit of the address is 0
  - the halfword at halfword-aligned address *A* consists of the two bytes with addresses *A* and *A*+1.

In some situations the ARM architecture supports accesses to halfwords and words that are not aligned to the appropriate access size, see [Alignment support on page A3-108](#).

Normally, address calculations are performed using ordinary integer instructions. This means that the address wraps around if the calculation overflows or underflows the address space. Another way of describing this is that any address calculation is reduced modulo  $2^{32}$ .

### A3.1.1 Address space overflow or underflow

Address space overflow occurs when the memory address increments beyond the top byte of the address space at `0xFFFFFFFF`. When this happens, the address wraps round, so that, for example, incrementing `0xFFFFFFFF` by 2 gives a result of `0x00000001`.

Address space underflow occurs when the memory address decrements below the first byte of the address space at `0x00000000`. When this happens, the address wraps round, so that, for example, decrementing `0x00000002` by 4 gives a result of `0xFFFFFFFFE`.

When a processor performs normal sequential execution of instructions, after each instruction it finds the address of the next instruction by calculating:

$$(\text{address\_of\_current\_instruction}) + (\text{size\_of\_executed\_instruction})$$

This calculation can result in address space overflow.

#### ———— **Note** —————

The size of the executed instruction depends on the current instruction set, and can depend on the instruction executed.

Any multi-byte memory access that depends on address space overflow or underflow is UNPREDICTABLE. This applies to both data and instruction accesses.

The following rules define the accesses that are UNPREDICTABLE:

1. If the processor executes an instruction for which the instruction address, size, and alignment mean it contains the bytes `0xFFFFFFFF` and `0x00000000`, the result is UNPREDICTABLE.

Examples of this UNPREDICTABLE behavior include:

- relying on sequential execution of the instruction at `0x00000000` after any of:
  - executing a 4-byte instruction at `0xFFFFFFFFC`
  - executing a 2-byte instruction at `0xFFFFFFFFE`
  - executing a 1-byte instruction at `0xFFFFFFFFF`.

- attempting to execute an instruction that spans the top of memory, for example:
    - a 4-byte instruction at 0xFFFFFFFF
    - a 2-byte instruction at 0xFFFFFFFF.
2. If the processor executes a load or store instruction for which the computed address, total access size, and alignment mean it accesses the bytes 0xFFFFFFFF and 0x00000000, the result is UNPREDICTABLE.
- Examples of this UNPREDICTABLE behavior include:
- attempting to perform an unaligned load or store operation that spans the top of memory, for example:
    - a word load or store from or to address 0xFFFFFFFF
    - a halfword load or store from or to address 0xFFFFFFFF
  - attempting to perform a multiple load or store operation that spans the top of memory, for example:
    - a two-word load or store from or to addresses 0xFFFFF0 and 0x00000000
    - an Advanced SIMD multiple-element load or store that includes bytes 0xFFFFFFFF and 0x00000000.

This UNPREDICTABLE behavior only applies to instructions that are executed, including those that fail their condition code check. Most ARM implementations fetch instructions ahead of the currently-executing instruction. If this *prefetching* overflows the top of the address space, it does not cause UNPREDICTABLE behavior unless the prefetched instruction with an overflowed address is executed.

———— **Note** —————

In some cases, instructions that operate on multiple words can decrement the memory address by 4 after each word access. If this calculation underflows the address space, the result is UNPREDICTABLE.

---

## A3.2 Alignment support

Instructions in the ARM architecture are aligned as follows:

- ARM instructions are word-aligned
- Thumb and ThumbEE instructions are halfword-aligned
- Java bytecodes are byte-aligned.

In the ARMv7 architecture, some load and store instructions support unaligned data accesses, as described in [Unaligned data access](#).

For more information about the alignment support in previous versions of the ARM architecture, see [Alignment on page AppxL-2504](#).

### A3.2.1 Unaligned data access

An ARMv7 implementation must support unaligned data accesses by some load and store instructions, as [Table A3-1](#) shows. Software can set the [SCTLR.A](#) bit to control whether a misaligned access by one of these instructions causes an Alignment fault Data Abort exception.

**Table A3-1 Alignment requirements of load/store instructions**

Instructions	Alignment check	Result if check fails when:	
		SCTLR.A is 0	SCTLR.A is 1
LDRB, LDREXB, LDRBT, LDRSB, LDRSBT, STRB, STREXB, STRBT, SWPB, TBB	None	-	-
LDRH, LDRHT, LDRSH, LDRSHT, STRH, STRHT, TBH	Halfword	Unaligned access	Alignment fault
LDREXH, STREXH	Halfword	Alignment fault	Alignment fault
LDR, LDRT, STR, STRT PUSH, encodings T3 and A2 only POP, encodings T3 and A2 only	Word	Unaligned access	Alignment fault
LDREX, STREX	Word	Alignment fault	Alignment fault
LDREXD, STREXD	Doubleword	Alignment fault	Alignment fault
All forms of LDM and STM, LDRD, RFE, SRS, STRD, SWP PUSH, except for encodings T3 and A2 POP, except for encodings T3 and A2	Word	Alignment fault	Alignment fault
LDC, LDC2, STC, STC2	Word	Alignment fault	Alignment fault
VLDM, VLDR, VPOP, VPUSH, VSTM, VSTR	Word	Alignment fault	Alignment fault
VLD1, VLD2, VLD3, VLD4, VST1, VST2, VST3, VST4, all with standard alignment <sup>a</sup>	Element size	Unaligned access	Alignment fault
VLD1, VLD2, VLD3, VLD4, VST1, VST2, VST3, VST4, all with :<align> specified <sup>a, b</sup>	As specified by :<align>	Alignment fault	Alignment fault

a. These element and structure load/store instructions are only in the Advanced SIMD Extension to the ARMv7 ARM and Thumb instruction sets. ARMv7 does not support the pre-ARMv6 alignment model, so software cannot use that model with these instructions.

b. Previous versions of this document used @<align> to specify alignment. Both forms are supported, see [Advanced SIMD addressing mode on page A7-277](#) for more information.



### A3.2.2 Cases where unaligned accesses are UNPREDICTABLE

The following cases cause the resulting unaligned accesses to be UNPREDICTABLE, and overrule any permitted load or store behavior shown in [Table A3-1 on page A3-108](#):

- Any load instruction that is not faulted by the alignment restrictions shown in [Table A3-1 on page A3-108](#) and that loads the PC has UNPREDICTABLE behavior if the address it loads from is not word-aligned.
- In an implementation that does not include the Virtualization Extensions, any unaligned access that is not faulted by the alignment restrictions shown in [Table A3-1 on page A3-108](#) and that accesses memory with the Strongly-ordered or Device memory attribute has UNPREDICTABLE behavior.

———— **Note** —————

- In an implementation that includes the Virtualization Extensions, such an unaligned access to Device or Strongly-ordered memory generates an Alignment fault, see [Alignment faults on page B3-1402](#).
- [Memory types and attributes and the memory order model on page A3-125](#) describes the Strongly-ordered and Device memory attributes.

### A3.2.3 Unaligned data access restrictions in ARMv7 and ARMv6

ARMv7 and ARMv6 have the following restrictions on unaligned data accesses:

- Accesses are not guaranteed to be single-copy atomic except at the byte access level, see [Atomicity in the ARM architecture on page A3-127](#). An access can be synthesized out of a series of aligned operations in a shared memory system without guaranteeing locked transaction cycles.
- Unaligned accesses typically take a number of additional cycles to complete compared to a naturally aligned transfer. The real-time implications must be analyzed carefully and key data structures might need to have their alignment adjusted for optimum performance.
- An operation that performs an unaligned access can abort on any memory access that it makes, and can abort on more than one access. This means that an unaligned access that occurs across a page boundary can generate an abort on either side of the boundary, or on both sides of the boundary.

Shared memory schemes must not rely on seeing single-copy atomic updates of unaligned data of loads and stores for data items larger than byte wide. For more information, see [Atomicity in the ARM architecture on page A3-127](#).

Unaligned access operations must not be used for accessing memory-mapped registers in a Device or Strongly-ordered memory region.

### A3.3 Endian support

The rules in [Address space on page A3-106](#) require that for a word-aligned address  $A$ :

- the doubleword at address  $A$  comprises the bytes at addresses  $A$ ,  $A+1$ ,  $A+2$ ,  $A+3$ ,  $A+4$ ,  $A+5$ ,  $A+6$ , and  $A+7$
- the word:
  - at address  $A$  comprises the bytes at addresses  $A$ ,  $A+1$ ,  $A+2$  and  $A+3$
  - at address  $A+4$  comprises the bytes at addresses  $A+4$ ,  $A+5$ ,  $A+6$  and  $A+7$
- the halfword:
  - at address  $A$  comprises the bytes at addresses  $A$  and  $A+1$
  - at address  $A+2$  comprises the bytes at addresses  $A+2$  and  $A+3$
  - at address  $A+4$  comprises the bytes at addresses  $A+4$  and  $A+5$
  - at address  $A+6$  comprises the bytes at addresses  $A+6$  and  $A+7$
- this means that:
  - the doubleword at address  $A$  comprises the words at addresses  $A$  and  $A+4$
  - the word at address  $A$  comprises the halfwords at addresses  $A$  and  $A+2$
  - the word at address  $A+4$  comprises the halfwords at addresses  $A+4$  and  $A+6$ .

However, this does not specify completely the mappings between words, halfwords, and bytes.

A memory system uses one of the two following mapping schemes. This choice is called the endianness of the memory system.

In a *little-endian* memory system:

- the byte, halfword, or word at an address is the least significant byte, halfword, or word in the doubleword at that address
- the byte or halfword at an address is the least significant byte or halfword in the word at that address
- the byte at an address is the least significant byte in the halfword at that address.

In a *big-endian* memory system:

- the byte, halfword, or word at an address is the most significant byte, halfword or word in the doubleword at that address
- the byte or halfword at an address is the most significant byte or halfword in the word at that address
- the byte at an address is the most significant byte in the halfword at that address.

For an address  $A$ , [Figure A3-1 on page A3-111](#) shows, for big-endian and little-endian memory systems, the relationship between:

- the doubleword at address  $A$
- the words at addresses  $A$  and  $A+4$
- the halfwords at addresses  $A$ ,  $A+2$ ,  $A+4$ , and  $A+6$
- the bytes at addresses  $A$ ,  $A+1$ ,  $A+2$ ,  $A+3$ ,  $A+4$ ,  $A+5$ ,  $A+6$ , and  $A+7$ .

Big-endian memory system

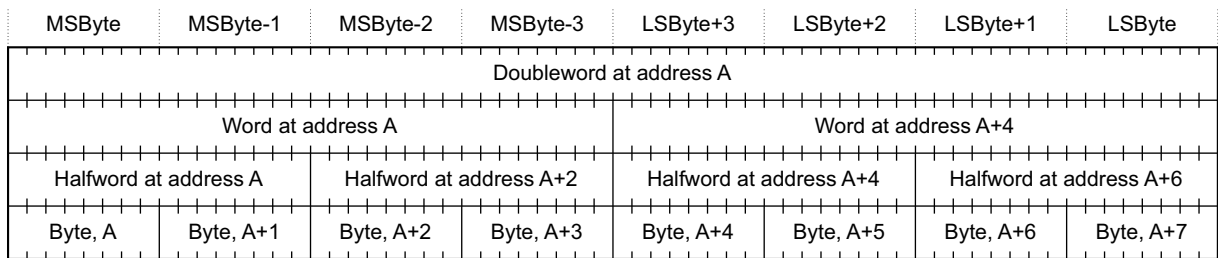

Little-endian memory system

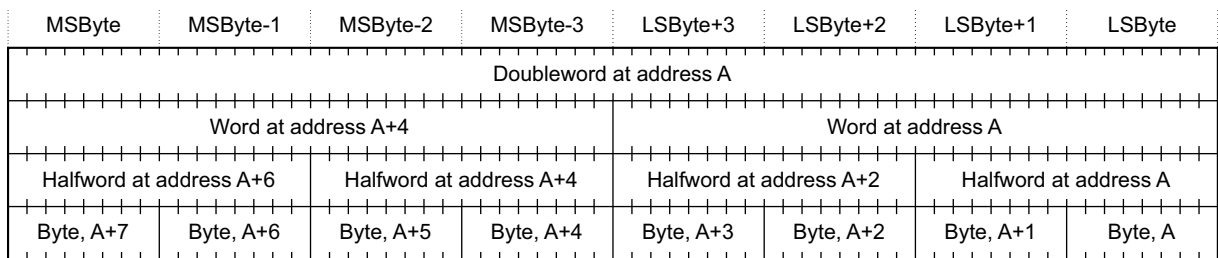

In this figure, *Byte, A+1* is an abbreviation for *Byte at address A+1*

**Figure A3-1 Endianness relationships**

The big-endian and little-endian mapping schemes determine the order in which the bytes of a doubleword, word or halfword are interpreted. For example, a load of a word from address 0x1000 always results in an access to the bytes at memory locations 0x1000, 0x1001, 0x1002, and 0x1003. The endianness mapping scheme determines the significance of these four bytes.

### A3.3.1 Instruction endianness

In ARMv7-A, the mapping of instruction memory is always little-endian. In ARMv7-R, instruction endianness can be controlled at the system level, see *Instruction endianness static configuration, ARMv7-R only* on page A3-112.

———— **Note** ————

For information about data memory endianness control, see *Endianness mapping register, ENDIANSTATE* on page A2-53.

Before ARMv7, the ARM architecture included legacy support for an alternative big-endian memory model, described as BE-32 and controlled by SCTLR.B bit, bit[7] of the register, see *Endian configuration and control* on page AppxL-2516. ARMv7 does not support BE-32 operation, and bit SCTLR[7] is RAZ/SBZP.

Where legacy object code for ARM processors contains instructions with a big-endian byte order, the removal of support for BE-32 operation requires the instructions in the object files to have their bytes reversed for the code to be executed on an ARMv7 processor. This means that:

- each Thumb instruction, whether a 32-bit Thumb instruction or a 16-bit Thumb instruction, must have the byte order of each halfword of instruction reversed
- each ARM instruction must have the byte order of each word of instruction reversed.

For most situations, this can be handled in the link stage of a tool-flow, provided the object files include sufficient information to permit this to happen. In practice, this is the situation for all applications with the ARMv7-A profile.

For applications of the ARMv7-R profile, there are some legacy code situations where the arrangement of the bytes in the object files cannot be adjusted by the linker. For these object files to be used by an ARMv7-R processor the byte order of the instructions must be reversed by the processor at runtime. Therefore, the ARMv7-R profile permits configuration of the instruction endianness.

### Instruction endianness static configuration, ARMv7-R only

To provide support for legacy big-endian object code, the ARMv7-R profile supports optional byte order reversal hardware as a static option from reset. The ARMv7-R profile includes a read-only bit in the CP15 Control Register, [SCTLR.IE](#), bit[31], that indicates the instruction endianness configuration.

#### A3.3.2 Element size and endianness

The effect of the endianness mapping on data transfers depends on the size of the data element or elements transferred by the load/store instructions. [Table A3-2](#) lists the element sizes of all the load/store instructions, for all instruction sets.

**Table A3-2 Element size of load/store instructions**

Instructions	Element size
LDRB, LDREXB, LDRBT, LDRSB, LDRSBT, STRB, STREXB, STRBT, SWPB, TBB	Byte
LDRH, LDREXH, LDRHT, LDRSH, LDRSHT, STRH, STREXH, STRHT, TBH	Halfword
LDR, LDRT, LDREX, STR, STRT, STREX	Word
LDRD, LDREXD, STRD, STREXD	Word
All forms of LDM, PUSH, POP, RFE, SRS, all forms of STM, SWP	Word
LDC, LDC2, STC, STC2	Word
Forms of VLDM, VLDR, VPOP, VPUSH, VSTM, VSTR that transfer 32-bit Si registers	Word
Forms of VLDM, VLDR, VPOP, VPUSH, VSTM, VSTR that transfer 64-bit Di registers	Doubleword
VLD1, VLD2, VLD3, VLD4, VST1, VST2, VST3, VST4	Element size of the Advanced SIMD access

#### A3.3.3 Instructions to reverse bytes in an ARM core register

An application or device driver might have to interface to memory-mapped peripheral registers or shared memory structures that are not the same endianness as the internal data structures. Similarly, the endianness of the operating system might not match that of the peripheral registers or shared memory. In these cases, the processor requires an efficient method to transform explicitly the endianness of the data.

In ARMv7, in the ARM and Thumb instruction sets, the following instructions provide this functionality:

- REV Reverse word (four bytes) register, for transforming big-endian and little-endian 32-bit representations, see [REV](#) on page A8-562.
- REVSH Reverse halfword and sign-extend, for transforming signed 16-bit representations, see [REVSH](#) on page A8-566.
- REV16 Reverse packed halfwords in a register for transforming big-endian and little-endian 16-bit representations, see [REV16](#) on page A8-564.

#### A3.3.4 Endianness in Advanced SIMD

Advanced SIMD element load/store instructions transfer vectors of elements between memory and the Advanced SIMD register bank. An instruction specifies both the length of the transfer and the size of the data elements being transferred. This information is used by the processor to load and store data correctly in both big-endian and little-endian systems.

Consider, for example, the instruction:

```
VLD1.16 {D0}, [R1]
```

This loads a 64-bit register with four 16-bit values. The four elements appear in the register in array order, with the lowest indexed element fetched from the lowest address. The order of bytes in the elements depends on the endianness configuration, as shown in Figure A3-2. Therefore, the order of the elements in the registers is the same regardless of the endianness configuration.

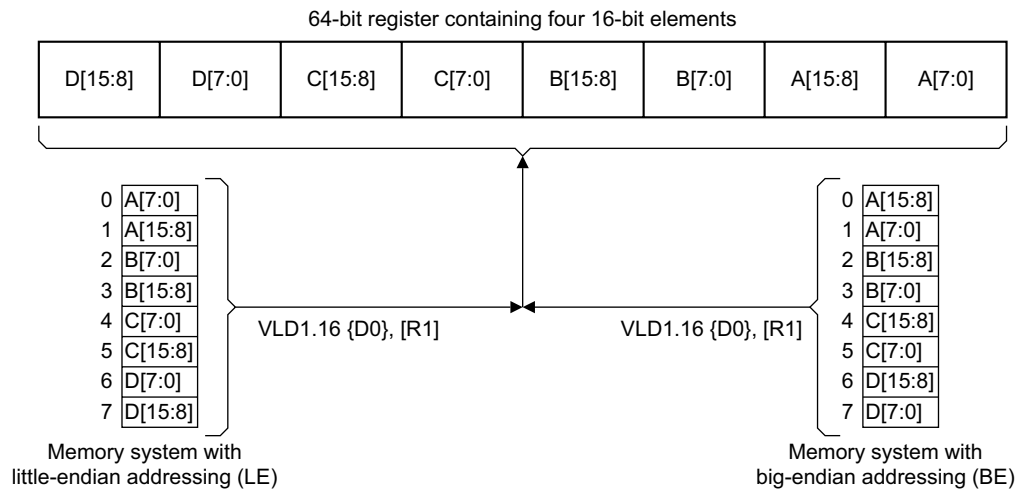

**Figure A3-2 Advanced SIMD byte order example**

For information about the alignment of Advanced SIMD instructions see [Unaligned data access on page A3-108](#).

## A3.4 Synchronization and semaphores

In architecture versions before ARMv6, support for the synchronization of shared memory depends on the SWP and SWPB instructions. These are read-locked-write operations that swap register contents with memory, and are described in *SWP, SWPB* on page A8-722. These instructions support basic busy/free semaphore mechanisms, but do not support mechanisms that require calculation to be performed on the semaphore between the read and write phases.

From ARMv6, ARM deprecates any use of SWP or SWPB, and the ARMv7 Virtualization Extensions make these instructions OPTIONAL and deprecated.

---

### Note

- ARM strongly recommends that all software uses the synchronization primitives described in this section, rather than SWP or SWPB.
- If an implementation does not support the SWP and SWPB instructions, the ID\_ISAR0.Swap\_instrs and ID\_ISAR4.SWP\_frac fields are zero, see *About the Instruction Set Attribute registers* on page B7-1950.

---

ARMv6 introduced a new mechanism to support more comprehensive non-blocking synchronization of shared memory, using *synchronization primitives* that scale for multiprocessor system designs. ARMv7 extends support for this mechanism, and provides the following synchronization primitives in the ARM and Thumb instruction sets:

- Load-Exclusives:
  - LDREX, see *LDREX* on page A8-432
  - LDREXB, see *LDREXB* on page A8-434
  - LDREXD, see *LDREXD* on page A8-436
  - LDREXH, see *LDREXH* on page A8-438
- Store-Exclusives:
  - STREX, see *STREX* on page A8-690
  - STREXB, see *STREXB* on page A8-692
  - STREXD, see *STREXD* on page A8-694
  - STREXH, see *STREXH* on page A8-696
- Clear-Exclusive, CLREX, see *CLREX* on page A8-360.

---

### Note

This section describes the operation of a Load-Exclusive/Store-Exclusive pair of synchronization primitives using, as examples, the LDREX and STREX instructions. The same description applies to any other pair of synchronization primitives:

- LDREXB used with STREXB
- LDREXD used with STREXD
- LDREXH used with STREXH.

Software must use a Load-Exclusive instruction only with the corresponding Store-Exclusive instruction.

---

The model for the use of a Load-Exclusive/Store-Exclusive instruction pair, accessing a non-aborting memory address x is:

- The Load-Exclusive instruction reads a value from memory address x.
- The corresponding Store-Exclusive instruction succeeds in writing back to memory address x only if no other observer, process, or thread has performed a more recent store to address x. The Store-Exclusive operation returns a status bit that indicates whether the memory write succeeded.

A Load-Exclusive instruction tags a small block of memory for exclusive access. The size of the tagged block is IMPLEMENTATION DEFINED, see *Tagging and the size of the tagged memory block* on page A3-121. A Store-Exclusive instruction to the same address clears the tag.

———— **Note** —————

In this section, the term processor includes any observer that can generate a Load-Exclusive or a Store-Exclusive.

---

### A3.4.1 Exclusive access instructions and Non-shareable memory regions

For memory regions that do not have the *Shareable* attribute, the exclusive access instructions rely on a *local monitor* that tags any address from which the processor executes a Load-Exclusive. Any non-aborted attempt by the same processor to use a Store-Exclusive to modify any address is guaranteed to clear the tag.

A Load-Exclusive performs a load from memory, and:

- the executing processor tags the physical memory address for exclusive access
- the local monitor of the executing processor transitions to the Exclusive Access state.

A Store-Exclusive performs a conditional store to memory, that depends on the state of the local monitor:

#### If the local monitor is in the Exclusive Access state

- If the address of the Store-Exclusive is the same as the address that has been tagged in the monitor by an earlier Load-Exclusive, then the store occurs, otherwise it is IMPLEMENTATION DEFINED whether the store occurs.
- A status value is returned to a register:
  - if the store took place the status value is 0
  - otherwise, the status value is 1.
- The local monitor of the executing processor transitions to the Open Access state.

#### If the local monitor is in the Open Access state

- no store takes place
- a status value of 1 is returned to a register.
- the local monitor remains in the Open Access state.

The Store-Exclusive instruction defines the register to which the status value is returned.

When a processor writes using any instruction other than a Store-Exclusive:

- if the write is to a physical address that is not covered by its local monitor the write does not affect the state of the local monitor
- if the write is to a physical address that is covered by its local monitor it is IMPLEMENTATION DEFINED whether the write affects the state of the local monitor.

If the local monitor is in the Exclusive Access state and the processor performs a Store-Exclusive to any address other than the last one from which it performed a Load-Exclusive, it is IMPLEMENTATION DEFINED whether the store updates memory, but in all cases the local monitor is reset to the Open Access state. This mechanism:

- is used on a context switch, see [Context switch support on page A3-122](#)
- must be treated as a software programming error in all other cases.

———— **Note** —————

It is IMPLEMENTATION DEFINED whether a store to a tagged physical address causes a tag in the local monitor to be cleared if that store is by an observer other than the one that caused the physical address to be tagged.

---

[Figure A3-3 on page A3-116](#) shows the state machine for the local monitor. [Table A3-3 on page A3-116](#) shows the effect of each of the operations shown in the figure.

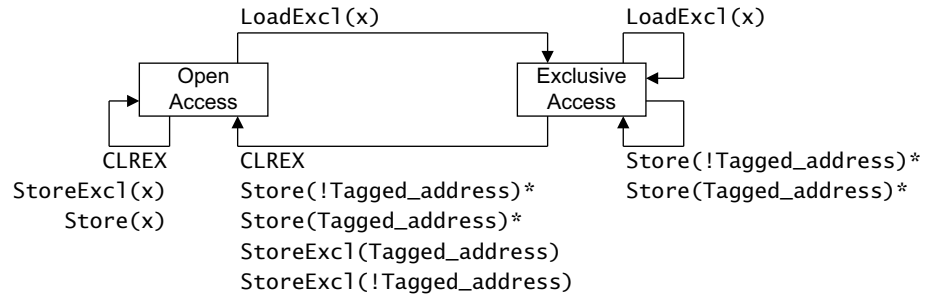

Operations marked \* are possible alternative IMPLEMENTATION DEFINED options.  
In the diagram: LoadExc1 represents any Load-Exclusive instruction  
StoreExc1 represents any Store-Exclusive instruction  
Store represents any other store instruction.

Any LoadExc1 operation updates the tagged address to the most significant bits of the address x used for the operation.

**Figure A3-3 Local monitor state machine diagram**

For more information about tagging see [Tagging and the size of the tagged memory block](#) on page A3-121.

———— **Note** ————

For the local monitor state machine, as shown in [Figure A3-3](#):

- The IMPLEMENTATION DEFINED options for the local monitor are consistent with the local monitor being constructed so that it does not hold any physical address, but instead treats any access as matching the address of the previous LoadExc1.
- A local monitor implementation can be unaware of Load-Exclusive and Store-Exclusive operations from other processors.
- The architecture does not require a load instruction by another processor, that is not a Load-Exclusive instruction, to have any effect on the local monitor.
- It is IMPLEMENTATION DEFINED whether the transition from Exclusive Access to Open Access state occurs when the Store or StoreExc1 is from another observer.

[Table A3-3](#) shows the effect of the operations shown in [Figure A3-3](#).

**Table A3-3 Effect of Exclusive instructions and write operations on the local monitor**

Initial state	Operation <sup>a</sup>	Effect	Final state
Open Access	CLREX	No effect	Open Access
	StoreExc1(x)	Does not update memory, returns status 1	Open Access
	LoadExc1(x)	Loads value from memory, tags address x	Exclusive Access
	Store(x)	Updates memory, no effect on monitor	Open Access
Exclusive Access	CLREX	Clears tagged address	Open Access
	StoreExc1(t)	Updates memory, returns status 0	Open Access
	StoreExc1(!t)	Updates memory, returns status 0 <sup>b</sup>	Open Access
		Does not update memory, returns status 1 <sup>b</sup>	
	LoadExc1(x)	Loads value from memory, changes tag to address x	Exclusive Access



**Table A3-3 Effect of Exclusive instructions and write operations on the local monitor (continued)**

Initial state	Operation <sup>a</sup>	Effect	Final state
Exclusive Access	Store(!t)	Updates memory	Exclusive Access <sup>b</sup>
			Open Access <sup>b</sup>
	Store(t)	Updates memory	Exclusive Access <sup>b</sup>
			Open Access <sup>b</sup>

- a. In the table:  
LoadExc1 represents any Load-Exclusive instruction  
StoreExc1 represents any Store-Exclusive instruction  
Store represents any store operation other than a Store-Exclusive operation.  
t is the tagged address, bits[31:a] of the address of the last Load-Exclusive instruction. For more information, see [Tagging and the size of the tagged memory block on page A3-121](#).
- b. IMPLEMENTATION DEFINED alternative actions.

**Note**

Normal memory that is Inner Non-cacheable, Outer Non-cacheable is inherently coherent between different processors, and it is IMPLEMENTATION DEFINED whether such memory, if it does not have the Shareable attribute, is treated as Non-shareable or as Shareable.

**Changes to the local monitor state resulting from speculative execution**

The architecture permits a local monitor to transition to the Open Access state as a result of speculation, or from some other cause. This is in addition to the transitions to Open Access state caused by the architectural execution of an operation shown in [Table A3-3 on page A3-116](#).

An implementation must ensure that:

- the local monitor cannot be seen to transition to the Exclusive Access state except as a result of the architectural execution of one of the operations shown in [Table A3-3 on page A3-116](#)
- any transition of the local monitor to the Open Access state not caused by the architectural execution of an operation shown in [Table A3-3 on page A3-116](#) must not indefinitely delay forward progress of execution.

**A3.4.2 Exclusive access instructions and Shareable memory regions**

For memory regions that have the *Shareable* attribute, exclusive access instructions rely on:

- A *local monitor* for each processor in the system, that tags any address from which the processor executes a Load-Exclusive. The local monitor operates as described in [Exclusive access instructions and Non-shareable memory regions on page A3-115](#), except that for Shareable memory any Store-Exclusive is then subject to checking by the global monitor if it is described in that section as doing at least one of:

- updating memory
- returning a status value of 0.

The local monitor can ignore accesses from other processors in the system.

- A *global monitor* that tags a physical address as exclusive access for a particular processor. This tag is used later to determine whether a Store-Exclusive to that address that has not been failed by the local monitor can occur. Any successful write to the tagged address by any other observer in the shareability domain of the memory location is guaranteed to clear the tag. For each processor in the system, the global monitor:

- can hold at least one tagged address
- maintains a state machine for each tagged address it can hold.

---

**Note**

---

For each processor, the architecture only requires global monitor support for a single tagged address. Any situation that might benefit from the use of multiple tagged addresses on a single processor is UNPREDICTABLE, see *Load-Exclusive and Store-Exclusive usage restrictions* on page A3-122.

---

In addition, in an implementation that includes the Large Physical Address Extension, when the implementation is using the Short-descriptor translation table format, it is IMPLEMENTATION DEFINED whether Load-Exclusive and Store-Exclusive accesses to Non-shareable regions with the Normal, Inner Non-cacheable, Outer Non-cacheable attribute use the global monitor in addition to the local monitor.

---

**Note**

---

The global monitor can either reside in a processor block or exist as a secondary monitor at the memory interfaces. The IMPLEMENTATION DEFINED aspects of the monitors mean that the global monitor and local monitor can be combined into a single unit, provided that unit performs the global monitor and local monitor functions defined in this manual.

---

For Shareable regions of memory, in some implementations and for some memory types, the properties of the global monitor can be met only by functionality outside the processor. Some system implementations might not implement this functionality for all regions of memory, In particular, this can apply to:

- any type of memory in the system implementation that does not support hardware cache coherency
- Non-cacheable memory, or memory treated as Non-cacheable, in an implementation that does support hardware cache coherency.

In such a system, it is defined by the system:

- whether the global monitor is implemented
- if the global monitor is implemented, which address ranges or memory types it monitors.

The behavior of Load Exclusive and Store Exclusive instructions when accessing a memory address not monitored by the global monitor is UNPREDICTABLE.

---

**Note**

---

An implementation can combine the functionality of the global and local monitors into a single unit.

---

### Operation of the global monitor

A Load-Exclusive from Shareable memory performs a load from memory, and causes the physical address of the access to be tagged as exclusive access for the requesting processor. This access also causes the exclusive access tag to be removed from any other physical address that has been tagged by the requesting processor.

The global monitor only supports a single outstanding exclusive access to Shareable memory per processor. A Load-Exclusive by one processor has no effect on the global monitor state for any other processor.

Store-Exclusive performs a conditional store to memory:

- The store is guaranteed to succeed only if the physical address accessed is tagged as exclusive access for the requesting processor and both the local monitor and the global monitor state machines for the requesting processor are in the Exclusive Access state. In this case:
  - a status value of 0 is returned to a register to acknowledge the successful store
  - the final state of the global monitor state machine for the requesting processor is IMPLEMENTATION DEFINED
  - if the address accessed is tagged for exclusive access in the global monitor state machine for any other processor then that state machine transitions to Open Access state.

- If no address is tagged as exclusive access for the requesting processor, the store does not succeed:
  - a status value of 1 is returned to a register to indicate that the store failed
  - the global monitor is not affected and remains in Open Access state for the requesting processor.
- If a different physical address is tagged as exclusive access for the requesting processor, it is IMPLEMENTATION DEFINED whether the store succeeds or not:
  - if the store succeeds a status value of 0 is returned to a register, otherwise a value of 1 is returned
  - if the global monitor state machine for the processor was in the Exclusive Access state before the Store-Exclusive it is IMPLEMENTATION DEFINED whether that state machine transitions to the Open Access state.

The Store-Exclusive instruction defines the register to which the status value is returned.

In a shared memory system, the global monitor implements a separate state machine for each processor in the system. The state machine for accesses to Shareable memory by processor (n) can respond to all the Shareable memory accesses visible to it. This means it responds to:

- accesses generated by the associated processor (n)
- accesses generated by the other observers in the shareability domain of the memory location (!n).

In a shared memory system, the global monitor implements a separate state machine for each observer that can generate a Load-Exclusive or a Store-Exclusive in the system.

Figure A3-4 shows the state machine for processor(n) in a global monitor. Table A3-4 on page A3-120 shows the effect of each of the operations shown in the figure.

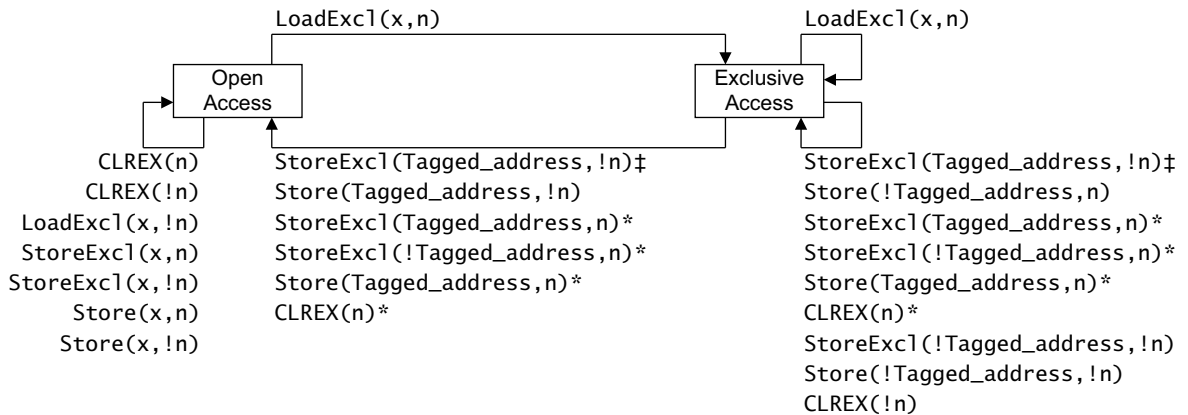

‡StoreExc1(Tagged\_Address,!n) clears the monitor only if the StoreExc1 updates memory

Operations marked \* are possible alternative IMPLEMENTATION DEFINED options.

In the diagram: LoadExc1 represents any Load-Exclusive instruction

StoreExc1 represents any Store-Exclusive instruction

Store represents any other store instruction.

Any LoadExc1 operation updates the tagged address to the most significant bits of the address x used for the operation.

**Figure A3-4 Global monitor state machine diagram for processor(n) in a multiprocessor system**

For more information about tagging see *Tagging and the size of the tagged memory block* on page A3-121.

———— **Note** —————

For the global monitor state machine, as shown in [Figure A3-4 on page A3-119](#):

- The architecture does not require a load instruction by another processor, that is not a Load-Exclusive instruction, to have any effect on the global monitor.
- Whether a Store-Exclusive successfully updates memory or not depends on whether the address accessed matches the tagged Shareable memory address for the processor issuing the Store-Exclusive instruction. For this reason, [Figure A3-4 on page A3-119](#) and [Table A3-4](#) only show how the (!n) entries cause state transitions of the state machine for processor(n).
- An Load-Exclusive can only update the tagged Shareable memory address for the processor issuing the Load-Exclusive instruction.
- The effect of the CLREX instruction on the global monitor is IMPLEMENTATION DEFINED.
- It is IMPLEMENTATION DEFINED:
  - whether a modification to a non-shareable memory location can cause a global monitor to transition from Exclusive Access to Open Access state
  - whether a Load-Exclusive to a non-shareable memory location can cause a global monitor to transition from Open Access to Exclusive Access state.

[Table A3-4](#) shows the effect of the operations shown in [Figure A3-4 on page A3-119](#).

**Table A3-4 Effect of load/store operations on global monitor for processor(n)**

Initial state	Operation <sup>a</sup>	Effect	Final state	
Exclusive Access	LoadExcl(x, n)	Loads value from memory, tags address x	Exclusive Access	
	CLREX(n)	None. Effect on the final state is IMPLEMENTATION DEFINED.	Exclusive Access <sup>d</sup>	
			Open Access <sup>d</sup>	
	CLREX(!n)	None	Exclusive Access	
	StoreExcl(t, !n)		Updates memory, returns status 0 <sup>b</sup>	Open Access
			Does not update memory, returns status 1 <sup>b</sup>	Exclusive Access
	StoreExcl(t, n)		Updates memory, returns status 0 <sup>c</sup>	Open Access
				Exclusive Access
	StoreExcl(!t, n)		Updates memory, returns status 0 <sup>d</sup>	Open Access
			Does not update memory, returns status 1 <sup>d</sup>	Exclusive Access
	StoreExcl(!t, !n)	Depends on state machine and tag address for processor issuing STREX	Exclusive Access	
	Store(t, n)	Updates memory		Exclusive Access <sup>d</sup>
				Open Access <sup>d</sup>
	Store(t, !n)	Updates memory	Open Access	
Store(!t, n), Store(!t, !n)	Updates memory, no effect on monitor	Exclusive Access		

**Table A3-4 Effect of load/store operations on global monitor for processor(n) (continued)**

Initial state	Operation <sup>a</sup>	Effect	Final state
Open Access	CLREX(n), CLREX(!n)	None	Open Access
	StoreExc1(x, n)	Does not update memory, returns status 1	Open Access
	LoadExc1(x, !n)	Loads value from memory, no effect on tag address for processor(n)	Open Access
	StoreExc1(x, !n)	Depends on state machine and tag address for processor issuing STREX <sup>b</sup>	Open Access
	Store(x, n), Store(x, !n)	Updates memory, no effect on monitor	Open Access
	LoadExc1(x, n)	Loads value from memory, tags address x	Exclusive Access

- a. In the table:  
LoadExc1 represents any Load-Exclusive instruction  
StoreExc1 represents any Store-Exclusive instruction  
Store represents any store operation other than a Store-Exclusive operation.  
t is the tagged address for processor(n), bits[31:a] of the address of the last Load-Exclusive instruction issued by processor(n), see [Tagging and the size of the tagged memory block](#).
- b. The result of a STREX(x, !n) or a STREX(t, !n) operation depends on the state machine and tagged address for the processor issuing the STREX instruction. This table shows how each possible outcome affects the state machine for processor(n).
- c. After a successful STREX to the tagged address, the state of the state machine is IMPLEMENTATION DEFINED. However, this state has no effect on the subsequent operation of the global monitor.
- d. Effect is IMPLEMENTATION DEFINED. The table shows all permitted implementations.

### A3.4.3 Tagging and the size of the tagged memory block

As stated in the footnotes to [Table A3-3 on page A3-116](#) and [Table A3-4 on page A3-120](#), when a Load-Exclusive instruction is executed, the resulting tag address ignores the least significant bits of the memory address.

$$\text{Tagged\_address} = \text{Memory\_address}[31:a]$$

The value of a in this assignment is IMPLEMENTATION DEFINED, between a minimum value of 3 and a maximum value of 11. For example, in an implementation where a is 4, a successful LDREX of address 0x000341B4 gives a tag value of bits[31:4] of the address, giving 0x000341B. This means that the four words of memory from 0x000341B0 to 0x000341BF are tagged for exclusive access.

The size of the tagged memory block is called the *Exclusives Reservation Granule*. The Exclusives Reservation Granule is IMPLEMENTATION DEFINED in the range 2-512 words:

- 2 words in an implementation where a is 3
- 512 words in an implementation where a is 11.

In some implementations the CTR identifies the Exclusives Reservation Granule, see either:

- [CTR, Cache Type Register, VMSA on page B4-1556](#)
- [CTR, Cache Type Register, PMSA on page B6-1833](#).

#### A3.4.4 Context switch support

After a context switch, software must ensure that the local monitor is in the Open Access state. This requires it to either:

- execute a CLREX instruction
- execute a dummy STREX to a memory address allocated for this purpose.

———— **Note** ————

- Using a dummy STREX for this purpose is backwards-compatible with the ARMv6 implementation of the exclusive operations. The CLREX instruction is introduced in ARMv6K.
- Context switching is not an application level operation. However, this information is included here to complete the description of the exclusive operations.

The STREX or CLREX instruction that follows a context switch might cause a subsequent Store-Exclusive to fail, requiring a Load-Exclusive ... Store-Exclusive sequence to be repeated. To minimize the possibility of this happening, ARM recommends that the Store-Exclusive instruction is kept as close as possible to the associated Load-Exclusive instruction, see [Load-Exclusive and Store-Exclusive usage restrictions](#).

#### A3.4.5 Load-Exclusive and Store-Exclusive usage restrictions

The Load-Exclusive and Store-Exclusive instructions are intended to work together, as a pair, for example a LDREX/STREX pair or a LDREXB/STREXB pair. To support different implementations of these functions, software must follow the notes and restrictions given here.

These notes describe use of an LDREX/STREX pair, but apply equally to any other Load-Exclusive/Store-Exclusive pair:

- The exclusives support a single outstanding exclusive access for each processor thread that is executed. The architecture makes use of this by not requiring an address or size check as part of the `IsExclusiveLocal()` function. If the target virtual address of an STREX is different from the virtual address of the preceding LDREX in the same thread of execution, behavior can be UNPREDICTABLE. As a result, an LDREX/STREX pair can only be relied upon to eventually succeed if they are executed with the same address. Where a context switch or exception might change the thread of execution, a CLREX instruction or a dummy STREX instruction must be executed to avoid unwanted effects, as described in [Context switch support](#). Using an STREX in this way is the only occasion where software can program an STREX with a different address from the previously executed LDREX.
- If two STREX instructions are executed without an intervening LDREX the second STREX returns a status value of 1. This means that:
  - ARM recommends that, in a given thread of execution, every STREX has a preceding LDREX associated with it
  - it is not necessary for every LDREX to have a subsequent STREX.
- An implementation of the Load-Exclusive and Store-Exclusive instructions can require that, in any thread of execution, the transaction size of a Store-Exclusive is the same as the transaction size of the preceding Load-Exclusive executed in that thread. If the transaction size of a Store-Exclusive is different from the preceding Load-Exclusive in the same thread of execution, behavior can be UNPREDICTABLE. As a result, software can rely on an LDREX/STREX pair to eventually succeed only if they have the same size. Where a context switch or exception might change the thread of execution, the software must execute a CLREX instruction, or a dummy STREX instruction, to avoid unwanted effects, as described in [Context switch support](#). Using an STREX in this way is the only occasion where software can use a Store-Exclusive instruction with a different transaction size from the previously executed Load-Exclusive instruction.
- An implementation might clear an exclusive monitor between the LDREX and the STREX, without any application-related cause. For example, this might happen because of cache evictions. Software written for such an implementation must, in any single thread of execution, avoid having any explicit memory accesses or cache maintenance operations between the LDREX instruction and the associated STREX instruction.

- In some implementations, an access to Strongly-ordered or Device memory might clear the exclusive monitor. Therefore, software must not place a load or a store to Strongly-ordered or Device memory between an LDREX and an STREX in a single thread of execution.
- Implementations can benefit from keeping the LDREX and STREX operations close together in a single thread of execution. This minimizes the likelihood of the exclusive monitor state being cleared between the LDREX instruction and the STREX instruction. Therefore, for best performance, ARM strongly recommends a limit of 128 bytes between LDREX and STREX instructions in a single thread of execution.
- The architecture sets an upper limit of 2048 bytes on the size of a region that can be marked as exclusive. Software can read the implemented size of the Exclusives reservation granule from the CTR.ERG field, see:
  - *CTR, Cache Type Register; VMSA on page B4-1556* for a VMSA implementation.
  - *CTR, Cache Type Register; PMSA on page B6-1833* for a PMSA implementation.In a heavily contended system, having multiple objects that are in the same exclusive reservation granule accessed by exclusive accesses can lead to starvation of a process accessing that granule. Therefore, in such systems, ARM recommends that objects that are accessed by exclusive accesses are separated by the size of the Exclusive Reservation Granule.
- It is IMPLEMENTATION DEFINED whether LDREX and STREX operations can be performed to a memory region with the Device or Strongly-ordered memory attribute. Unless the implementation documentation explicitly states that LDREX and STREX operations to a memory region with the Device or Strongly-ordered attribute are permitted, the effect of such operations is UNPREDICTABLE.
- After taking a Data Abort exception, the state of the exclusive monitors is UNKNOWN. Therefore ARM strongly recommends that the abort handling software performs a CLREX instruction, or a dummy STREX instruction, to clear the monitor state.
- If the memory attributes for the memory being accessed by an LDREX/STREX pair are changed between the LDREX and the STREX, behavior is UNPREDICTABLE.
- The effect of a data or unified cache invalidate instruction on a local or global exclusive monitor that is in the Exclusive Access state is UNPREDICTABLE. The operation might clear the monitor, or it might leave it in the Exclusive Access state. For address-based invalidation this also applies to the monitors of other processors in the same shareability domain as the processor executing the cache invalidation instruction, as determined by the shareability domain of the address being invalidated.

———— **Note** —————

ARM strongly recommends that implementations ensure that the use of such maintenance operations by a processor in the Non-secure state cannot cause a denial of service on a processor in the Secure state.

———— **Note** —————

In the event of repeatedly-contending load-exclusive/store-exclusive sequences from multiple processors, an implementation must ensure that forward progress is made by at least one processor.

## A3.4.6 Semaphores

The Swap (SWP) and Swap Byte (SWPB) instructions must be used with care to ensure that expected behavior is observed. Two examples are as follows:

1. A system with multiple bus masters that uses Swap instructions to implement semaphores that control interactions between different bus masters.  
  
In this case, the semaphores must be placed in an uncached region of memory, where any buffering of writes occurs at a point common to all bus masters using the mechanism. The Swap instruction then causes a locked read-write bus transaction.
2. A system with multiple threads running on a uniprocessor that uses Swap instructions to implement semaphores that control interaction of the threads.

In this case, the semaphores can be placed in a cached region of memory, and a locked read-write bus transaction might or might not occur. The Swap and Swap Byte instructions are likely to have better performance on such a system than they do on a system with multiple bus masters, such as that described in example 1.

———— **Note** ————

From ARMv6, ARM deprecates use of the Swap and Swap Byte instructions, and strongly recommends that all new software uses the Load-Exclusive and Store-Exclusive synchronization primitives described in [Synchronization and semaphores](#) on page A3-114, for example LDREX and STREX.

### A3.4.7 Synchronization primitives and the memory order model

The synchronization primitives follow the memory order model of the memory type accessed by the instructions. For this reason:

- Portable software for claiming a spin-lock must include a *Data Memory Barrier* (DMB) operation, performed by a DMB instruction, between claiming the spin-lock and making any access that makes use of the spin-lock.
- Portable software for releasing a spin-lock must include a DMB instruction before writing to clear the spin-lock.

This requirement applies to software using:

- the Load-Exclusive/Store-Exclusive instruction pairs, for example LDREX/STREX
- the deprecated synchronization primitives, SWP/SWPB.

### A3.4.8 Use of WFE and SEV instructions by spin-locks

ARMv7 and ARMv6K provide Wait For Event and Send Event instructions, WFE and SEV, that can assist with reducing power consumption and bus contention caused by processors repeatedly attempting to obtain a spin-lock. These instructions can be used at the application level, but a complete understanding of what they do depends on system level understanding of exceptions. They are described in [Wait For Event and Send Event](#) on page B1-1199.



## A3.5 Memory types and attributes and the memory order model

ARMv6 defined a set of memory attributes with the characteristics required to support the memory and devices in the system memory map. In ARMv7 this set of attributes is extended by the addition of the Outer Shareable attribute for Normal memory and, in an implementation that does not include the Large Physical Address Extension, for Device memory.

———— **Note** —————

Whether an ARMv7 implementation distinguishes between Inner Shareable and Outer Shareable memory is IMPLEMENTATION DEFINED.

The ordering of accesses for regions of memory, referred to as the memory order model, is defined by the memory attributes. This model is described in the following sections:

- [Memory types](#)
- [Summary of ARMv7 memory attributes on page A3-126](#)
- [Atomicity in the ARM architecture on page A3-127](#)
- [Concurrent modification and execution of instructions on page A3-129](#)
- [Normal memory on page A3-131](#)
- [Device and Strongly-ordered memory on page A3-135](#)
- [Memory access restrictions on page A3-137](#)
- [The effect of the Security Extensions on page A3-140.](#)

### A3.5.1 Memory types

For each memory region, the most significant memory attribute specifies the memory type. There are three mutually exclusive memory types:

- Normal
- Device
- Strongly-ordered.

Normal and Device memory regions have additional attributes.

Usually, memory used for programs and for data storage is suitable for access using the Normal memory attribute. Examples of memory technologies for which the Normal memory attribute is appropriate are:

- programmed Flash ROM

———— **Note** —————

During programming, Flash memory can be ordered more strictly than Normal memory.

- ROM
- SRAM
- DRAM and DDR memory.

System peripherals (I/O) generally conform to different access rules. Examples of I/O accesses are:

- FIFOs where consecutive accesses:
  - add queued values on write accesses
  - remove queued values on read accesses.
- interrupt controller registers where an access can be used as an interrupt acknowledge, changing the state of the controller itself
- memory controller configuration registers that are used for setting up the timing and correctness of areas of Normal memory
- memory-mapped peripherals, where accessing a memory location can cause side-effects in the system.

In ARMv7, the Strongly-ordered or Device memory attribute provides suitable access control for such peripherals. To ensure correct system behavior, the access rules for Device and Strongly-ordered memory are more restrictive than those for Normal memory, so that:

- Neither read nor write accesses can be performed speculatively.

———— **Note** ————

However, translation table walks can be made speculatively to memory marked as Device or Strongly-ordered, see [Device and Strongly-ordered memory on page A3-135](#).

- Read and write accesses cannot be repeated, for example, on return from an exception.
- The number, order and sizes of the accesses are maintained.

For more information, see [Device and Strongly-ordered memory on page A3-135](#).

### A3.5.2 Summary of ARMv7 memory attributes

Table A3-5 summarizes the memory attributes. For more information about these attributes see:

- [Normal memory on page A3-131](#) and [Shareable attribute for Device memory regions on page A3-136](#), for the *shareability* attribute
- [Write-Through Cacheable, Write-Back Cacheable and Non-cacheable Normal memory on page A3-133](#), for *cacheability* and *cache allocation hint* attributes.

———— **Note** ————

The cacheability and cache allocation hint attributes apply only to Normal memory. Device and Strongly-ordered memory regions are Non-cacheable.

In this table:

- Shareability** Applies only to Normal memory, and to Device memory in an implementation that does not include the Large Physical Address Extensions. In an implementation that includes the Large Physical Address Extensions, Device memory is always Outer Shareable.
- When it is possible to assign a shareability attribute to Device memory, ARM deprecates assigning any attribute other than Shareable or Outer Shareable, see [Shareable attribute for Device memory regions on page A3-136](#)
- Whether an ARMv7 implementation distinguishes between Inner Shareable and Outer Shareable memory is IMPLEMENTATION DEFINED.
- Cacheability** Applies only to Normal memory, and can be defined independently for Inner and Outer cache regions. Some cacheability attributes can be complemented by a *cache allocation hint*. This is an indication to the memory system of whether allocating a value to a cache is likely to improve performance. For more information see [Cacheability and cache allocation hint attributes on page B2-1264](#).
- An implementation might not make any distinction between memory regions with attributes that differ only in their cache allocation hint.

**Table A3-5 Memory attribute summary**

Memory type	Implementation includes LPAE <sup>a</sup> ?	Shareability	Cacheability
Strongly- ordered	-	-	-

**Table A3-5 Memory attribute summary (continued)**

Memory type	Implementation includes LPAE <sup>a</sup> ?	Shareability	Cacheability
Device	Yes	Outer Shareable	-
	No	Outer Shareable	
		Inner Shareable	
		Non-shareable	
Normal	-	Outer Shareable	One of:
		Inner Shareable	• Non-cacheable
		Non-shareable	• Write-Through Cacheable • Write-Back Cacheable.

a. LPAE means the Large Physical Address Extension.

[Memory model and memory ordering on page AppxO-2593](#) compares these attributes with the memory attributes in architecture versions before ARMv6.

### A3.5.3 Atomicity in the ARM architecture

*Atomicity* is a feature of memory accesses, described as *atomic* accesses. The ARM architecture description refers to two types of atomicity, defined in:

- [Single-copy atomicity](#)
- [Multi-copy atomicity on page A3-129](#).

#### Single-copy atomicity

A read or write operation is *single-copy atomic* if the following conditions are both true:

- After any number of write operations to a memory location, the value of the memory location is the value written by one of the write operations. It is impossible for part of the value of the memory location to come from one write operation and another part of the value to come from a different write operation.
- When a read operation and a write operation are made to the same memory location, the value obtained by the read operation is one of:
  - the value of the memory location before the write operation
  - the value of the memory location after the write operation.

It is never the case that the value of the read operation is partly the value of the memory location before the write operation and partly the value of the memory location after the write operation.

In ARMv7, the single-copy atomic processor accesses are:

- all byte accesses
- all halfword accesses to halfword-aligned locations
- all word accesses to word-aligned locations
- memory accesses caused by LDREXD and STREXD instructions to doubleword-aligned locations.

LDM, LDC, LDC2, LDRD, STM, STC, STC2, STRD, PUSH, POP, RFE, SRS, VLDM, VLDR, VSTM, and VSTR instructions are executed as a sequence of word-aligned word accesses. Each 32-bit word access is guaranteed to be single-copy atomic. The architecture does not require subsequences of two or more word accesses from the sequence to be single-copy atomic.

In an implementation that includes the Large Physical Address Extension, LDRD and STRD accesses to 64-bit aligned locations are 64-bit single-copy atomic as seen by translation table walks and accesses to translation tables.

———— **Note** —————

The Large Physical Address Extension adds this requirement to avoid the need for complex measures to avoid atomicity issues when changing translation table entries, without creating a requirement that all locations in the memory system are 64-bit single-copy atomic. This addition means:

- The system designer must ensure that all writable memory locations that might be used to hold translations, such as bulk SDRAM, can be accessed with 64-bit single-copy atomicity.
- Software must ensure that translation tables are not held in memory locations that cannot meet this atomicity requirement, such as peripherals that are typically accessed using a narrow bus.

This requirement places no burden on read-only memory locations for which reads have no side effects, since it is impossible to detect the size of memory accesses to such locations.

Advanced SIMD element and structure loads and stores are executed as a sequence of accesses of the element or structure size. The architecture requires the element accesses to be single-copy atomic if and only if both:

- the element size is 32 bits, or smaller
- the elements are naturally aligned.

Accesses to 64-bit elements or structures that are at least word-aligned are executed as a sequence of 32-bit accesses, each of which is single-copy atomic. The architecture does not require subsequences of two or more 32-bit accesses from the sequence to be single-copy atomic.

When a store that, by the rules given in this section, would be single-copy atomic is made to a memory location at a time when there is at least one store to the same memory location that has not completed and that would be single-copy atomic at a different size, then the architecture does not give any assurance of atomicity between accesses to the bytes of that location.

When an access is not single-copy atomic, it is executed as a sequence of smaller accesses, each of which is single-copy atomic, at least at the byte level.

———— **Note** —————

In this section, the terms *before the write operation* and *after the write operation* mean before or after the write operation has had its effect on the coherence order of the bytes of the memory location accessed by the write operation.

If, according to these rules, an instruction is executed as a sequence of accesses, some exceptions can be taken during that sequence. Such an exception causes execution of the instruction to be abandoned. These exceptions are:

- Synchronous Data Abort exceptions.
- The following, if low interrupt latency configuration is selected and the accesses are to Normal memory:
  - IRQ interrupts
  - FIQ interrupts
  - asynchronous aborts.

For more information about this configuration, see [Low interrupt latency configuration on page B1-1197](#).

If any of these exceptions are returned from using their preferred return address, the instruction that generated the sequence of accesses is re-executed and so any access that had been performed before the exception was taken is repeated.

———— **Note** —————

The exception behavior for these multiple access instructions means they are not suitable for use for writes to memory for the purpose of software synchronization.

For implicit accesses:

- Cache linefills and evictions have no effect on the single-copy atomicity of explicit transactions or instruction fetches.
- Instruction fetches are single-copy atomic:
  - at 32-bit granularity in ARM state
  - at 16-bit granularity in Thumb and ThumbEE states
  - at 8-bit granularity in Jazelle state.

*Concurrent modification and execution of instructions* describes additional constraints on the behavior of instruction fetches.

- Translation table walks are performed using accesses that are single-copy atomic:
  - at 32-bit granularity when using Short-descriptor format translation tables
  - at 64-bit granularity when using Long-descriptor format translation tables.

### Multi-copy atomicity

In a multiprocessing system, writes to a memory location are *multi-copy atomic* if the following conditions are both true:

- All writes to the same location are *serialized*, meaning they are observed in the same order by all observers, although some observers might not observe all of the writes.
- A read of a location does not return the value of a write until all observers observe that write.

Writes to Normal memory are not multi-copy atomic.

All writes to Device and Strongly-ordered memory that are single-copy atomic are also multi-copy atomic.

All write accesses to the same location are serialized. Write accesses to Normal memory can be repeated up to the point that another write to the same address is observed.

For Normal memory, serialization of writes does not prohibit the merging of writes.

## A3.5.4 Concurrent modification and execution of instructions

The ARMv7 architecture limits the set of instructions that can be executed by one thread of execution as they are being modified by another thread of execution without requiring explicit synchronization.

Except for the instructions identified in this section, the effect of the concurrent modification and execution of an instruction is UNPREDICTABLE.

For the following instructions only, the architecture guarantees that, after modification of the instruction, behavior is consistent with execution of either:

- The instruction originally fetched.
- A fetch of the new instruction. That is, a fetch of the instruction that results from the modification.

The instructions to which this guarantee applies are:

### In the Thumb instruction set

The 16-bit encodings of the B, NOP, BKPT, and SVC instructions.

In addition:

- The most-significant halfword of a BL instruction can be concurrently modified to the most significant halfword of another BL instruction.  
The most-significant halfword of a BLX instruction can be concurrently modified to the most significant halfword of another BLX instruction.  
These cases mean that the most significant bits of the immediate value can be modified.
- The most-significant halfword of a BL or BLX instruction can be concurrently modified to a 16-bit B, BKPT, or SVC instruction.

- The least-significant halfword of a BL instruction can be concurrently modified to the least significant halfword of another BL instruction.  
The least-significant halfword of a BLX instruction can be concurrently modified to the least significant halfword of another BLX instruction.  
These cases mean that the least significant bits of the immediate value can be modified.
- The least-significant halfword of a 32-bit B immediate instruction:
  - with a condition field can be concurrently modified to the least significant halfword of another 32-bit B immediate instruction with a condition field
  - without a condition field can be concurrently modified to the least significant halfword of another 32-bit B immediate instruction without a condition field.These cases mean that the least significant bits of the immediate value can be modified.
- A 16-bit B, BKPT, or SVC instruction can be concurrently modified to the most-significant halfword of a BL instruction.

———— **Note** —————

In the Thumb instruction set:

- the only encodings of BKPT and SVC are 16-bit
- the only encoding of BL is 32-bit.

**In the ARM instruction set**

The B, BL, NOP, BKPT, SVC, HVC, and SMC instructions.

For all other instructions, to avoid UNPREDICTABLE behavior, instruction modifications must be explicitly synchronized before they are executed. The required synchronization is as follows:

1. To ensure that the modified instructions are observable, the thread of execution that is modifying the instructions must issue the following sequence of instructions and operations:  
DCCMVAU [instruction location] ; Clean data cache by MVA to point of unification  
DSB ; Ensure visibility of the data cleaned from the cache  
ICIMVAU [instruction location] ; Invalidate instruction cache by MVA to PoU  
BPIMVAU [instruction location] ; Invalidate branch predictor by MVA to PoU  
DSB ; Ensure completion of the invalidations
2. Once the modified instructions are observable, the thread of execution that is executing the modified instructions must issue the following instructions or operations to ensure execution of the modified instructions:  
ISB ; Synchronize fetched instruction stream

———— **Note** —————

Issue C.a of this manual first describes this behavior, but the description applies to all ARMv7 implementations.

In addition, for both instruction sets, if one thread of execution changes a conditional branch instruction to another conditional branch instruction, and the change affects both the condition field and the branch target, execution of the changed instruction by another thread of execution before the change is synchronized can lead to either:

- the old condition being associated with the new target address
- the new condition being associated with the old target address.

These possibilities apply regardless of whether the condition, either before or after the change to the branch instruction, is the always condition.

## A3.5.5 Normal memory

Accesses to normal memory region are idempotent, meaning that they exhibit the following properties:

- read accesses can be repeated with no side-effects
- repeated read accesses return the last value written to the resource being read
- read accesses can fetch additional memory locations with no side-effects
- write accesses can be repeated with no side-effects in the following cases:
  - if the contents of the location accessed are unchanged between the repeated writes
  - as the result of an exception, as described in this section
- unaligned accesses can be supported
- accesses can be merged before accessing the target memory system.

Normal memory can be read/write or read-only, and a Normal memory region is defined as being either Shareable or Non-shareable. For Shareable Normal memory, whether a VMSA implementation distinguishes between Inner Shareable and Outer Shareable is IMPLEMENTATION DEFINED. A PMSA implementation makes no distinction between Inner Shareable and Outer Shareable regions.

The Normal memory type attribute applies to most memory used in a system.

Accesses to Normal Memory have a weakly consistent model of memory ordering. See a standard text describing memory ordering issues for a description of weakly consistent memory models, for example chapter 2 of *Memory Consistency Models for Shared Memory-Multiprocessors*. In general, for Normal memory, barrier operations are required where the order of memory accesses observed by other observers must be controlled. This requirement applies regardless of the cacheability and shareability attributes of the Normal memory region.

The ordering requirements of accesses described in [Ordering requirements for memory accesses on page A3-148](#) apply to all explicit accesses.

An instruction that generates a sequence of accesses as described in [Atomicity in the ARM architecture on page A3-127](#) might be abandoned as a result of an exception being taken during the sequence of accesses. On return from the exception the instruction is restarted, and therefore one or more of the memory locations might be accessed multiple times. This can result in repeated write accesses to a location that has been changed between the write accesses.

The architecture permits speculative accesses to memory locations marked as Normal if the access permissions and domain permit an access to the locations.

A Normal memory region has shareability attributes that define the data coherency properties of the region. These attributes do not affect the coherency requirements of:

- Instruction fetches, see [Instruction coherency issues on page A3-157](#).
- Translation table walks for VMSA implementations of:
  - ARMv7-A without the Multiprocessing extensions
  - versions of the architecture before ARMv7.

For more information, see [TLB maintenance operations and the memory order model on page B3-1383](#).

### Non-shareable Normal memory

For a Normal memory region, the Non-shareable attribute identifies Normal memory that is likely to be accessed only by a single processor.

A region of Normal memory with the Non-shareable attribute does not have any requirement to make data accesses by different observers coherent, unless the memory is Non-cacheable. If other observers share the memory system, software must use cache maintenance operations if the presence of caches might lead to coherency issues when communicating between the observers. This cache maintenance requirement is in addition to the barrier operations that are required to ensure memory ordering.

For Non-shareable Normal memory, it is IMPLEMENTATION DEFINED whether the Load-Exclusive and Store-Exclusive synchronization primitives take account of the possibility of accesses by more than one observer.

## Shareable, Inner Shareable, and Outer Shareable Normal memory

For Normal memory, the Shareable and Outer Shareable memory attributes describe Normal memory that is expected to be accessed by multiple processors or other system masters:

- In a VMSA implementation, Normal memory that has the Shareable attribute but not the Outer Shareable attribute assigned is described as having the Inner Shareable attribute.
- In a PMSA implementation, no distinction is made between Inner Shareable and Outer Shareable Normal memory.

A region of Normal memory with the Shareable attribute is one for which data accesses to memory by different observers within the same shareability domain are coherent.

The Outer Shareable attribute is introduced in ARMv7, and can be applied only to a Normal memory region in a VMSA implementation that has the Shareable attribute assigned. It creates three levels of shareability for a Normal memory region:

<b>Non-shareable</b>	A Normal memory region that does not have the Shareable attribute assigned.
<b>Inner Shareable</b>	A Normal memory region that has the Shareable attribute assigned, but not the Outer Shareable attribute.
<b>Outer Shareable</b>	A Normal memory region that has both the Shareable and the Outer Shareable attributes assigned.

These attributes can define sets of observers for which the shareability attributes make the data or unified caches transparent for data accesses. The sets of observers that are affected by the shareability attributes are described as *shareability domains*. The details of the use of these attributes are system-specific. [Example A3-1](#) shows how they might be used:

### Example A3-1 Use of shareability attributes

---

In a VMSA implementation, a particular subsystem with two clusters of processors has the requirement that:

- in each cluster, the data or unified caches of the processors in the cluster are transparent for all data accesses with the Inner Shareable attribute
- however, between the two clusters, the caches:
  - are not transparent for data accesses that have only the Inner Shareable attribute
  - are transparent for data accesses that have the Outer Shareable attribute.

In this system, each cluster is in a different shareability domain for the Inner Shareable attribute, but all components of the subsystem are in the same shareability domain for the Outer Shareable attribute.

A system might implement two such subsystems. If the data or unified caches of one subsystem are not transparent to the accesses from the other subsystem, this system has two Outer Shareable shareability domains.

---

However, for a Normal memory region that is Non-cacheable, as described in [Write-Through Cacheable, Write-Back Cacheable and Non-cacheable Normal memory](#) on page A3-133, the only significance of the Shareability attribute is the behavior of Load-Exclusive and Store-Exclusive instructions. For more information about this behavior see [Synchronization and semaphores](#) on page A3-114.

Having two levels of shareability attribute means system designers can reduce the performance and power overhead for shared memory regions that do not need to be part of the Outer Shareable shareability domain.

In a VMSA implementation, for Shareable Normal memory, whether there is a distinction between Inner Shareable and Outer Shareable is IMPLEMENTATION DEFINED.

For Shareable Normal memory, the Load-Exclusive and Store-Exclusive synchronization primitives take account of the possibility of accesses by more than one observer in the same Shareability domain.



---

**Note**

- System designers can use the Shareable concept to specify the locations in Normal memory that must have coherency requirements. However, to facilitate porting of software, software developers must not assume that specifying a memory region as Non-shareable permits software to make assumptions about the incoherency of memory locations between different processors in a shared memory system. Such assumptions are not portable between different multiprocessing implementations that make use of the Shareable concept. Any multiprocessing implementation might implement caches that, inherently, are shared between different processing elements.
  - This architecture is written with an expectation that all processors using the same operating system or hypervisor are in the same Inner Shareable shareability domain.
- 

### Write-Through Cacheable, Write-Back Cacheable and Non-cacheable Normal memory

In addition to being Outer Shareable, Inner Shareable or Non-shareable, each region of Normal memory is assigned a cacheability attribute that is one of:

- Write-Through Cacheable
- Write-Back Cacheable
- Non-cacheable.

Also, for cacheable Normal memory regions:

- a region might be assigned a cache allocation hint
- in an ARMv7-A implementation that includes the Large Physical Address Extension, it is IMPLEMENTATION DEFINED whether the Write-Through Cacheable and Write-Back Cacheable attributes can have an additional attribute of Transient or Non-transient, see [Transient cacheability attribute, Large Physical Address Extension on page A3-134](#).

A memory location can be marked as having different cacheability attributes, for example when using aliases in a virtual to physical address mapping:

- if the attributes differ only in the cache allocation hint this does not affect the behavior of accesses to that location
- for other cases see [Mismatched memory attributes on page A3-138](#).

The cacheability attributes provide a mechanism of coherency control with observers that lie outside the shareability domain of a region of memory. In some cases, the use of Write-Through Cacheable or Non-cacheable regions of memory might provide a better mechanism for controlling coherency than the use of hardware coherency mechanisms or the use of cache maintenance routines. To this end, the architecture requires the following properties for Non-cacheable or Write-Through Cacheable memory:

- a completed write to a memory location that is Non-cacheable or Write-Through Cacheable for a level of cache made by an observer accessing the memory system inside the level of cache is visible to all observers accessing the memory system outside the level of cache without the need of explicit cache maintenance
- a completed write to a memory location that is Non-cacheable for a level of cache made by an observer accessing the memory system outside the level of cache is visible to all observers accessing the memory system inside the level of cache without the need of explicit cache maintenance.

---

**Note**

Implementations can use the cache allocation hints to indicate a probable performance benefit of caching. For example, a programmer might know that a piece of memory is not going to be accessed again and would be better treated as Non-cacheable. The distinction between memory regions with attributes that differ only in the cache allocation hints exists only as a hint for performance.

---

The ARM architecture provides independent cacheability attributes for Normal memory for two conceptual levels of cache, the *inner* and the *outer* cache. The relationship between these conceptual levels of cache and the implemented physical levels of cache is IMPLEMENTATION DEFINED, and can differ from the boundaries between the Inner and Outer Shareability domains. However:

- inner refers to the innermost caches, and always includes the lowest level of cache
- no cache controlled by the Inner cacheability attributes can lie outside a cache controlled by the Outer cacheability attributes
- an implementation might not have any outer cache.

Example A3-2, Example A3-3, and Example A3-4 describe the possible ways of implementing a system with three levels of cache, *level 1* (L1) to *level 3* (L3).

---

**Note**

- L1 cache is the level closest to the processor, see [Memory hierarchy on page A3-155](#).
  - When managing coherency, system designs must consider both the inner and outer cacheability attributes, as well as the shareability attributes. This is because hardware might have to manage the coherency of caches at one conceptual level, even when another conceptual level has the Non-cacheable attribute.
- 

---

**Example A3-2 Implementation with two inner and one outer cache levels**

---

Implement the three levels of cache in the system, L1 to L3, with:

- the Inner cacheability attribute applied to L1 and L2 cache
  - the Outer cacheability attribute applied to L3 cache.
- 

---

**Example A3-3 Implementation with three inner and no outer cache levels**

---

Implement the three levels of cache in the system, L1 to L3, with the Inner cacheability attribute applied to L1, L2, and L3 cache. Do not use the Outer cacheability attribute.

---

---

**Example A3-4 Implementation with one inner and two outer cache levels**

---

Implement the three levels of cache in the system, L1 to L3, with:

- the Inner cacheability attribute applied to L1 cache
  - the Outer cacheability attribute applied to L2 and L3 cache.
- 

***Transient cacheability attribute, Large Physical Address Extension***

For an ARMv7-A implementation that includes the Large Physical Address Extension, it is IMPLEMENTATION DEFINED whether a Transient attribute is supported for cacheable Normal memory regions. If an implementation supports this attribute, the set of possible cacheability attributes for a Normal memory region becomes:

- Write-Through Cacheable, Non-transient
- Write-Back Cacheable, Non-transient
- Write-Through Cacheable, Transient
- Write-Back Cacheable, Transient
- Non-cacheable.

The cacheability attribute can be defined independently for the inner and outer levels of caching.

The transient attribute indicates that the benefit of caching is for a relatively short period, and that therefore it might be better to restrict allocation, to avoid possibly casting-out other, less transient, entries.

———— **Note** —————

The architecture does not specify what is meant by a *relatively short period*.

The description of the MAIR<sub>n</sub> registers includes the assignment of the Transient attribute in an implementation that supports this option.

### A3.5.6 Device and Strongly-ordered memory

The Device and Strongly-ordered memory type attributes define memory locations where an access to the location can cause side-effects, or where the value returned for a load can vary depending on the number of loads performed. In ARMv7, Device and Strongly-ordered memory differ only in their shareability options, as this section describes.

———— **Note** —————

See [Ordering of instructions that change the CPSR interrupt masks on page AppxL-2506](#) for additional requirements that apply to accesses to Strongly-ordered memory in ARMv6.

Examples of memory regions normally marked as being Device or Strongly-ordered memory are Memory-mapped peripherals and I/O locations.

For explicit accesses from the processor to memory marked as Device or Strongly-ordered:

- all accesses occur at their program size
- the number of accesses is the number specified by the program.

An implementation must not perform more accesses to a Device or Strongly-ordered memory location than are specified by a simple sequential execution of the program, except as a result of an exception. This section describes this permitted effect of an exception.

The architecture does not permit speculative data accesses to memory marked as Device or Strongly-ordered. However, it does not prohibit speculative translation table walks to Device or Strongly-ordered memory.

———— **Note** —————

- For an implementation that includes the Virtualization Extensions, for accesses from an application running in Non-secure state, a speculative translation table walk to Device or Strongly-ordered memory might result from the second stage of address translation defined by a hypervisor. For more information, see [Overlaying the memory type attribute on page B3-1376](#).
- For information about restrictions on speculative instruction fetching see:
  - [Execute-never restrictions on instruction fetching on page B3-1359](#) for a VMSA implementation
  - [The XN \(Execute-never\) attribute and instruction fetching on page B5-1759](#) for a PMSA implementation.

The architecture permits an Advanced SIMD element or structure load instruction to access bytes in Device or Strongly-ordered memory that are not explicitly accessed by the instruction, provided the bytes accessed are in a 16-byte window, aligned to 16-bytes, that contains at least one byte that is explicitly accessed by the instruction.

Address locations marked as Device or Strongly-ordered are never held in a cache.

Address locations marked as Strongly-ordered, and on an implementation that includes the Large Physical Address Extension, address locations marked as Device, are always treated as Shareable. For more information about the effect of the Large Physical Address Extension on the shareability of these locations see [Device and Strongly-ordered memory shareability, Large Physical Address Extension on page A3-137](#).

On an implementation that does not include the Large Physical Address Extension, the shareability of an address location marked as Device is configurable, as described in [Shareable attribute for Device memory regions on page A3-136](#).

All explicit accesses to Device or Strongly-ordered memory must comply with the ordering requirements of accesses described in [Ordering requirements for memory accesses on page A3-148](#). On an implementation that does not include the Large Physical Address Extension, the requirements for Device memory depend on the shareability of the Device memory locations.

An instruction that generates a sequence of accesses as described in [Atomicity in the ARM architecture on page A3-127](#) might be abandoned as a result of an exception being taken during the sequence of accesses. On return from the exception the instruction is restarted, and therefore one or more of the memory locations might be accessed multiple times. This can result in repeated write accesses to a location that has been changed between the write accesses.

———— **Note** —————

Software must not use an instruction that generates a sequence of accesses to access Device or Strongly-ordered memory if the instruction might generate a synchronous Data Abort exception on any access other than the first one.

The only architecturally-required difference between Device and Strongly-ordered memory is that:

- a write to Strongly-ordered memory can complete only when it reaches the peripheral or memory component accessed by the write
- a write to Device memory is permitted to complete before it reaches the peripheral or memory component accessed by the write.

———— **Note** —————

In addition, as described in [Shareable attribute for Device memory regions](#), in an implementation that does not include the Large Physical Address Extension, Device memory has Shareability attributes, the interpretation of which is IMPLEMENTATION DEFINED, and might mean a Device memory region is not shareable.

The architecture does not permit unaligned accesses to Strongly-ordered or Device memory. [Memory access restrictions on page A3-137](#) summarizes the behavior of such accesses.

### Shareable attribute for Device memory regions

In an implementation that does not include the Large Physical Address Extension, Device memory regions can be given the Shareable attribute. When a Device memory region is given the Shareable attribute it can also be given the Outer Shareable attribute. This means that a region of Device memory can be described as one of:

- Outer Shareable Device memory
- Inner Shareable Device memory
- Non-shareable Device memory.

Some implementations make no distinction between Outer Shareable Device memory and Inner Shareable Device memory, and refer to both memory types as Shareable Device memory.

Some implementations make no distinction between Shareable Device memory and Non-shareable Device memory, and refer to both memory types as Shareable Device memory.

For Device memory regions, the significance of shareability is IMPLEMENTATION DEFINED. However, an example of a system supporting Shareable and Non-shareable Device memory is an implementation that supports both:

- a local bus for its private peripherals
- system peripherals implemented on the main shared system bus.

Such a system might have more predictable access times for local peripherals such as watchdog timers or interrupt controllers. In particular, a specific address in a Non-shareable Device memory region might access a different physical peripheral for each processor.

ARM deprecates the marking of Device memory with a shareability attribute other than Outer Shareable or Shareable. This means ARM strongly recommends that Device memory is never assigned a shareability attribute of Non-shareable or Inner Shareable.

## Device and Strongly-ordered memory shareability, Large Physical Address Extension

In an implementation that includes the Large Physical Address Extension, the Long-descriptor translation table format does not distinguish between Shareable and Non-shareable Device memory.

In an implementation that includes the Large Physical Address Extension and is using the Short-descriptor translation table format:

- An address-based cache maintenance operation for an addresses in a region with the Strongly-ordered or Device memory type applies to all processors in the same Outer Shareable domain, regardless of any shareability attributes applied to the region.
- Device memory transactions to a single peripheral must not be reordered, regardless of any shareability attributes that are applied to the corresponding Device memory region.  
Any single peripheral has an IMPLEMENTATION DEFINED size of not less than 1KB.

### A3.5.7 Memory access restrictions

The following restrictions apply to memory accesses:

- For accesses to any two bytes,  $p$  and  $q$ , that are generated by the same instruction:
  - The bytes  $p$  and  $q$  must have the same memory type and shareability attributes, otherwise the results are UNPREDICTABLE. For example, an LDC, LDM, LDRD, STC, STM, STRD, or unaligned load or store that spans a boundary between Normal and Device memory is UNPREDICTABLE.
  - Except for possible differences in the cache allocation hints, ARM deprecates having different cacheability attributes for the bytes  $p$  and  $q$ .
- [Unaligned data access on page A3-108](#) identifies the instructions that can make an unaligned memory access, and the required configuration setting. If such an access is to Device or Strongly-ordered memory then:
  - if the implementation does not include the Large Physical Address Extension, the effect is UNPREDICTABLE
  - if the implementation includes the Large Physical Address Extension, the access generates an Alignment fault.
- An instruction that causes multiple accesses to Device or Strongly-ordered memory must not cross a 4KB address boundary, otherwise the effect is UNPREDICTABLE. For this reason, it is important that an access to a volatile memory device is not made using a single instruction that crosses a 4KB address boundary.  
ARM expects this restriction to impose constraints on the placing of volatile memory devices in the memory map of a system, rather than expecting a compiler to be aware of the alignment of memory accesses.
- For any instruction that generates accesses to Device or Strongly-ordered memory, implementations must not change the sequence of accesses specified by the pseudocode of the instruction. This includes not changing:
  - how many accesses there are
  - the time order of the accesses at any particular memory-mapped peripheral
  - the data size and other properties of each access.

In addition, processor implementations expect any attached memory system to be able to identify the memory type of accesses, and to obey similar restrictions with regard to the number, time order, data sizes and other properties of the accesses.

Exceptions to this rule are:

- An implementation of a processor can break this rule, provided that the original number, time order, and other details of the accesses can be reconstructed from the information it supplies to the memory system. In addition, the implementation must place a requirement on attached memory systems to do this reconstruction when the accesses are to Device or Strongly-ordered memory.

For example, an implementation with a 64-bit bus might pair the word loads generated by an LDM into 64-bit accesses. This is because the instruction semantics ensure that the 64-bit access is always a word load from the lower address followed by a word load from the higher address. However the implementation must permit the memory systems to unpack the two word loads when the access is to Device or Strongly-ordered memory.

- An Advanced SIMD element or structure load instruction can access bytes in Device or Strongly-ordered memory that are not explicitly accessed by the instruction, provided the bytes accessed are within a 16-byte window, aligned to 16-bytes, that contains at least one byte that is explicitly accessed by the instruction.
- There is no requirement for the memory system to be able to identify the size of the elements accessed by an Advanced SIMD element or structure load/store instruction.
- In a PMSA implementation, and in a VMSA implementation when any associated MMU is enabled, any multi-access instruction that loads or stores the PC must access only Normal memory. If the instruction accesses Device or Strongly-ordered memory the result is UNPREDICTABLE.
- Any instruction fetch must access only Normal memory. If it accesses Device or Strongly-ordered memory, the result is UNPREDICTABLE.
- If a single physical memory location has more than one set of attributes assigned to it, ARM strongly recommends that software ensures that the sets of attributes are identical. For more information see [Mismatched memory attributes](#).

An example of where multiple sets of attributes might be assigned to the same physical memory location is the use of aliases in a virtual to physical address mapping.

### Mismatched memory attributes

A physical memory location is accessed with *mismatched attributes* if all accesses to the location do not use a common definition of all of the following attributes of that location:

- memory type, Strongly-ordered, Device, or Normal
- shareability
- cacheability, for both the inner and outer levels of cache, but excluding any cache allocation hints.

The following rules apply when a physical memory location is accessed with mismatched attributes:

1. When a memory location is accessed with mismatched attributes the only software visible effects are one or more of the following:
  - Uniprocessor semantics for reads and writes to that memory location might be lost. This means:
    - a read of the memory location by a thread of execution might not return the value most recently written to that memory location by that thread of execution
    - multiple writes to the memory location by a thread of execution, that use different memory attributes, might not be ordered in program order.
  - There might be a loss of coherency when multiple threads of execution attempt to access a memory location.
  - There might be a loss of properties derived from the memory type, see rule 2.
  - If multiple threads of execution attempt to use Load-Exclusive or Store-Exclusive instructions to access a location with different memory attributes, the exclusive monitor state becomes UNKNOWN.
2. The loss of properties associated with mismatched memory type attributes refers only to the following properties of Strongly-ordered or Device memory, that are additional to the properties of Normal memory:
  - prohibition of speculative accesses
  - preservation of the size of accesses
  - preservation of the order of accesses
  - the guarantee that the write acknowledgement comes from the endpoint of the access.

If the only memory type mismatch is between Strongly-ordered and Device memory, then the only property that can be lost is:

- the guarantee that the write acknowledgement comes from the endpoint of the access.
3. If all aliases of a memory location that permit write access to the location assign the same shareability and cacheability attributes to that location, and all these aliases use a definition of the shareability attribute that includes all the threads of execution that can access the location, then any thread of execution that reads the memory location using these shareability and cacheability attributes accesses it coherently, to the extent required by that common definition of the memory attributes.
  4. The possible loss of properties caused by mismatched attributes for a memory location are defined more precisely if all of the mismatched attributes define the memory location as one of:
    - Strongly-ordered memory
    - Device memory
    - Normal Inner Non-cacheable, Outer Non-cacheable memory.

In these cases, the only possible software-visible effects of the mismatched attributes are one or more of:

- possible loss of properties derived from the memory type when multiple threads of execution attempt to access the memory location.
  - possible re-ordering of memory transactions to the memory location that use different memory attributes, potentially leading to a loss of coherency or uniprocessor semantics. Any possible loss of coherency or uniprocessor semantics can be avoided by inserting DMB barrier instructions between accesses to the same memory location that might use different attributes.
5. If the mismatched attributes for a memory location all assign the same shareability attribute to the location, any loss of coherency within a shareability domain can be avoided. To do so, software must use the techniques that are required for the software management of the coherency of cacheable locations between threads of execution in different shareability domains. This means:
    - If any thread of execution might have written to the location with the write-back attribute, before writing to the location not using the write-back attribute, a thread of execution must invalidate, or clean, the location from the caches. This avoids the possibility of overwriting the location with stale data.
    - After writing to the location with the write-back attribute, a thread of execution must clean the location from the caches, to make the write visible to external memory.
    - Before reading the location with a cacheable attribute, a thread of execution must invalidate the location from the caches, to ensure that any value held in the caches reflects the last value made visible in external memory.

In all cases:

- location refers to any byte within the current coherency granule
- a clean and invalidate operation can be used instead of a clean operation, or instead of an invalidate operation
- to ensure coherency, all cache maintenance and memory transactions must be completed, or ordered by the use of barrier operations.

---

**Note**

---

With software management of coherency, race conditions can cause loss of data. A race condition occurs when different threads of execution write simultaneously to bytes that are in the same location, and the (invalidate or clean), write, clean sequence of one thread overlaps the equivalent sequence of another thread.

---

6. If the mismatched attributes for a location mean that multiple cacheable accesses to the location might be made with different shareability attributes, then coherency is guaranteed only if each thread of execution that accesses the location with a cacheable attribute performs a clean and invalidate of the location.

---

**Note**

---

The Note in rule 5, about possible race conditions, also applies to this rule.

---

In addition, if multiple threads attempt to use Load-Exclusive or Store-Exclusive instructions to access a location with different memory attributes associated with it, the exclusive monitor state becomes UNKNOWN.

ARM strongly recommends that software does not use mismatched attributes for aliases of the same location. An implementation might not optimize the performance of a system that uses mismatched aliases.

### **A3.5.8 The effect of the Security Extensions**

The Security Extensions can be included as part of an ARMv7-A implementation, with a VMSA. They provide two distinct 4GByte virtual memory spaces:

- a Secure virtual memory space
- a Non-secure virtual memory space.

The Secure virtual memory space is accessed by memory accesses in the Secure state, and the Non-secure virtual memory space is accessed by memory accesses in the Non-secure state.

By providing different virtual memory spaces, the Security Extensions permit memory accesses made from the Non-secure state to be distinguished from those made from the Secure state.



## A3.6 Access rights

ARMv7 defines additional memory region attributes, that define access permissions that can:

- Restrict data accesses, based on the privilege level of the access. See *Privilege level access controls for data accesses* on page A3-142.
- Restrict instruction fetches, based on the privilege level of the process or thread making the fetch. See *Privilege level access controls for instruction accesses* on page A3-142.
- On a system that implements the Security Extensions, restrict accesses so that only memory accesses with the Secure memory attribute are permitted. See *Memory region security status* on page A3-143.

These attributes are defined:

- In a VMSA implementation, in the MMU, see *Memory access control* on page B3-1356, *Memory region attributes* on page B3-1366, and *The effects of disabling MMUs on VMSA behavior* on page B3-1314.
- In a PMSA implementation, in the MPU, see *Memory access control* on page B5-1759 and *Memory region attributes* on page B5-1760.

### A3.6.1 Processor privilege levels, execution privilege, and access privilege

As introduced in *About the Application level programmers' model* on page A2-38, within a security state, the ARMv7 architecture defines different levels of *execution privilege*:

- in Secure state, the privilege levels are PL1 and PL0
- in Non-secure state, the privilege levels are PL2, PL1, and PL0.

PL0 indicates unprivileged execution in the current security state.

The current processor mode determines the execution privilege level, and therefore the execution privilege level can be described as the *processor privilege* level.

Every memory access has an *access privilege*, that is either unprivileged or privileged.

The characteristics of the privilege levels are:

**PL0** The privilege level of application software, that executes in User mode. Therefore, software executed in User mode is described as unprivileged software. This software cannot access some features of the architecture. In particular, it cannot change many of the configuration settings. Software executing at PL0 makes only unprivileged memory accesses.

**PL1** Software execution in all modes other than User mode and Hyp mode is at PL1. Normally, operating system software executes at PL1. Software executing at PL1 can access all features of the architecture, and can change the configuration settings for those features, except for some features added by the Virtualization Extensions that are only accessible at PL2.

———— **Note** —————

In many implementation models, system software is unaware of the PL2 level of privilege, and of whether the implementation includes the Virtualization Extensions.

The *PL1 modes* refers to all the modes other than User mode and Hyp mode.

Software executing at PL1 makes privileged memory accesses by default, but can also make unprivileged accesses.

**PL2** Software executing in Hyp mode executes at PL2. Software executing at PL2 can perform all of the operations accessible at PL1, and can access some additional functionality.

Hyp mode is normally used by a hypervisor, that controls, and can switch between, Guest OSs, that execute at PL1.

Hyp mode is implemented only as part of the Virtualization Extensions, and only in Non-secure state. This means that:

- implementations that do not include the Virtualization Extensions have only two privilege levels, PL0 and PL1
- execution in Secure state has only two privilege levels, PL0 and PL1.

In an implementation that includes the Security Extensions, the execution privilege levels are defined independently in each security state, and there is no relationship between the Secure and Non-secure privilege levels.

———— **Note** ————

The fact that Non-secure Hyp mode executes at PL2 does not indicate that it is more privileged than the Secure PL1 modes. Secure PL1 modes can change the configuration and control settings for Non-secure operation in all modes, but Non-secure modes can never change the configuration and control settings for Secure operation.

Memory access permissions can be assigned:

- at PL1, for accesses made at PL1 and at PL0
- in Non-secure state, at PL2, independently for:
  - Non-secure accesses made at PL2
  - Non-secure accesses made at PL1, and at PL0.

### A3.6.2 Privilege level access controls for data accesses

The memory access permissions assigned at PL1 can define that a memory region is:

- Not accessible to any accesses.
- Accessible only to accesses at PL1.
- Accessible to accesses at any level of privilege.

In Non-secure state, separate memory access permissions can be assigned at PL2 for:

- Accesses made at PL1 and PL0.
- Accesses made at PL2.

The access privilege level is defined separately for explicit read and explicit write accesses. However, a system that specifies the memory attributes is not required to support all combinations of memory attributes for read and write accesses.

A privileged memory access is an access made during execution at PL1 or higher, as a result of a load or store operation other than LDRT, STRT, LDRBT, STRBT, LDRHT, STRHT, LDRSHT, or LDRSBT.

An unprivileged memory access is an access made as a result of load or store operation performed in one of these cases:

- When the processor is at PL0.
- When the processor is at PL1, and the access is made as a result of a LDRT, STRT, LDRBT, STRBT, LDRHT, STRHT, LDRSHT, or LDRSBT instruction.

A Data Abort exception is generated if the processor attempts a data access that the access rights do not permit. For example, a Data Abort exception is generated if the processor is at PL0 and attempts to access a memory region that is marked as only accessible to privileged memory accesses.

### A3.6.3 Privilege level access controls for instruction accesses

Memory attributes access permissions assigned at PL1 can define that a memory region is:

- Not accessible for execution.
- Not accessible for execution at PL1 Only implementations that include the Large Physical Address Extension support this attribute.

- Accessible for execution only at PL1.
- Accessible for execution at any level of privilege.

In Non-secure state, in an implementation that includes the Virtualization Extensions, separate memory access permissions can be assigned at PL2 for:

- Accesses made at PL1 and PL0.
- Accesses made at PL2.

To define the instruction access rights to a memory region, the memory attributes describe, separately, for the region:

- Its read access rights. These are equivalent to the read access rights described in [Privilege level access controls for data accesses on page A3-142](#).
- Whether software can be executed from the region. This is indicated by whether or not an *Execute-never* (XN) attribute is assigned to the region.
- For an implementation that includes the Large Physical Address Extension, whether software can be executed at PL1 from the region. This is indicated by whether or not a *Privileged execute-never* (PXN) attribute is assigned to the region.

This means there is a linkage between the memory attributes that define the accessibility of a region to data accesses, and those that define whether instructions can be executed from the region. For example, a region that is accessible for execution only at PL1 or higher:

- Has the memory attribute indicating that it is accessible only to read accesses at PL1 or higher.
- Does not have the *Execute-never* attribute
- If the implementation includes the Large Physical Address Extension, does not have the *Privileged execute-never* attribute.

Any attempt to execute an instruction from a memory location with an applicable *execute-never* attribute generates a memory fault.

#### A3.6.4 Memory region security status

If an implementation includes the Security Extensions, an additional memory attribute determines whether the memory region is Secure or Non-secure. Such an implementation checks this attribute, to ensure that a region of memory that the system designates as Secure is not accessed by memory accesses with the Non-secure memory attribute. For more information, see [Memory region attributes on page B3-1366](#).

## A3.7 Virtual and physical addressing

ARMv7 provides three alternative architectural profiles, ARMv7-A, ARMv7-R and ARMv7-M. Each of the profiles specifies a different memory system. This manual describes two of these profiles:

### ARMv7-A profile

The ARMv7-A memory system incorporates a *Memory Management Unit* (MMU), controlled by CP15 registers. The memory system supports virtual addressing, with the MMU performing virtual to physical address translation, in hardware, as part of program execution.

An ARMv7-A processor that implements the Virtualization Extensions provides two stages of address translation for processes running at the Application level:

- The operating system defines the mappings from virtual addresses to *intermediate physical addresses* (IPAs). When it does this, it believes it is mapping virtual addresses to physical addresses.
- The hypervisor defines the mappings from IPAs to physical addresses. These translations are invisible to the operating system.

For more information see [About address translation on page B3-1311](#).

### ARMv7-R profile

The ARMv7-R memory system incorporates a *Memory Protection Unit* (MPU), controlled by CP15 registers. The MPU does not support virtual addressing.

At the Application level, the difference between the ARMv7-A and ARMv7-R memory systems is transparent. Regardless of which profile is implemented, an application accesses the memory map described in [Address space on page A3-106](#), and the implemented memory system makes the features described in this chapter available to the application.

For a system level description of the ARMv7-A and ARMv7-R memory models see:

- [Chapter B2 Common Memory System Architecture Features](#)
- [Chapter B3 Virtual Memory System Architecture \(VMSA\)](#)
- [Chapter B5 Protected Memory System Architecture \(PMSA\)](#).

---

#### Note

This manual does not describe the ARMv7-M profile. For details of this profile see the *ARMv7-M Architecture Reference Manual*.

---

## A3.8 Memory access order

ARMv7 provides a set of three memory types, Normal, Device, and Strongly-ordered, with well-defined memory access properties.

The ARMv7 application level view of the memory attributes is described in:

- [Memory types and attributes and the memory order model on page A3-125](#)
- [Access rights on page A3-141](#).

When considering memory access ordering, an important feature of the ARMv7 memory model is the *Shareable* memory attribute, that indicates whether a region of memory appears coherent for data accesses made by multiple observers.

The key issues with the memory order model depend on the target audience:

- For software programmers, considering the model at the Application level, the key factor is that for accesses to Normal memory barriers are required in some situations where the order of accesses observed by other observers must be controlled.
- For silicon implementers, considering the model at the system level, the Strongly-ordered and Device memory attributes place certain restrictions on the system designer in terms of what can be built and when to indicate completion of an access.

———— **Note** —————

Implementations remain free to choose the mechanisms required to implement the functionality of the memory model.

---

More information about the memory order model is given in the following subsections:

- [Reads and writes](#)
- [Ordering requirements for memory accesses on page A3-148](#)
- [Memory barriers on page A3-150](#).

Additional attributes and behaviors relate to the memory system architecture. These features are defined in the system level section of this manual:

- Virtual memory systems based on an MMU, described in [Chapter B3 Virtual Memory System Architecture \(VMSA\)](#).
- Protected memory systems based on an MPU, described in [Chapter B5 Protected Memory System Architecture \(PMSA\)](#).
- Caches, described in [Caches and branch predictors on page B2-1266](#).

———— **Note** —————

In these system level descriptions, some attributes are described in relation to an MMU. In general, these descriptions can also be applied to an MPU based system.

---

### A3.8.1 Reads and writes

Each memory access is either a read or a write. *Explicit* memory accesses are the memory accesses required by the function of an instruction. The following can cause memory accesses that are not explicit:

- instruction fetches
- cache loads and write-backs
- translation table walks.

Except where otherwise stated, the memory ordering requirements only apply to explicit memory accesses.

## Reads

Reads are defined as memory operations that have the semantics of a load.

The memory accesses of the following instructions are reads:

- LDR, LDRB, LDRH, LDRSB, and LDRSH.
- LDRT, LDRBT, LDRHT, LDRSBT, and LDRSHT.
- LDREX, LDREXB, LDREXD, and LDREXH.
- LDM, LDRD, POP, and RFE.
- LDC, LDC2, VLDM, VLDR, VLD1, VLD2, VLD3, VLD4, and VPOP.
- The return of status values by STREX, STREXB, STREXD, and STREXH.
- SWP and SWPB. These instructions are available only in the ARM instruction set.
- TBB and TBH. These instructions are available only in the Thumb instruction set.

Hardware-accelerated opcode execution by the Jazelle extension can cause a number of reads to occur, according to the state of the operand stack and the implementation of the Jazelle hardware acceleration.

## Writes

Writes are defined as memory operations that have the semantics of a store.

The memory accesses of the following instructions are Writes:

- STR, STRB, and STRH.
- STRT, STRBT, and STRHT.
- STREX, STREXB, STREXD, and STREXH.
- STM, STRD, PUSH, and SRS.
- STC, STC2, VPUSH, VSTM, VSTR, VST1, VST2, VST3, and VST4.
- SWP and SWPB. These instructions are available only in the ARM instruction set.

Hardware-accelerated opcode execution by the Jazelle extension can cause a number of writes to occur, according to the state of the operand stack and the implementation of the Jazelle hardware acceleration.

## Synchronization primitives

Synchronization primitives must ensure correct operation of system semaphores in the memory order model. The synchronization primitive instructions are defined as those instructions that are executed to ensure memory synchronization. They are the following instructions:

- LDREX, STREX, LDREXB, STREXB, LDREXD, STREXD, LDREXH, STREXH.
- SWP, SWPB. From ARMv6, ARM deprecates the use of these instructions.

## Observability and completion

An *observer* is an agent in the system that can access memory. For a processor, the following mechanisms must be treated as independent observers:

- the mechanism that performs reads or writes to memory
- a mechanism that causes an instruction cache to be filled from memory or that fetches instructions to be executed directly from memory
- a mechanism that performs translation table walks.

The set of observers that can observe a memory access is defined by the system.

In the definitions in this subsection, *subsequent* means whichever of the following is appropriate to the context:

- after the point in time where the location is observed by that observer
- after the point in time where the location is globally observed.

For all memory:

- a write to a location in memory is said to be *observed* by an observer when:
  - a subsequent read of the location by the same observer will return the value written by the observed write, or written by a write to that location by any observer that is sequenced in the [Coherence order](#) of the location after the observed write
  - a subsequent write of the location by the same observer will be sequenced in the [Coherence order](#) of the location after the observed write
- a write to a location in memory is said to be *globally observed* for a shareability domain when:
  - a subsequent read of the location by any observer in that shareability domain will return the value written by the globally observed write, or written by a write to that location by any observer that is sequenced in the [Coherence order](#) of the location after the globally observed write
  - a subsequent write of the location by any observer in that shareability domain will be sequenced in the [Coherence order](#) of the location after the globally observed write
- a read of a location in memory is said to be observed by an observer when a subsequent write to the location by the same observer will have no effect on the value returned by the read
- a read of a location in memory is said to be globally observed for a shareability domain when a subsequent write to the location by any observer in that shareability domain will have no effect on the value returned by the read.

Additionally, for Strongly-ordered memory:

- A read or write of a memory-mapped location in a peripheral that exhibits side-effects is said to be observed, and globally observed, only when the read or write:
  - meets the general conditions listed
  - can begin to affect the state of the memory-mapped peripheral
  - can trigger all associated side-effects, whether they affect other peripheral devices, processors, or memory.

———— **Note** —————

This definition is consistent with the memory access having reached the peripheral.

For all memory, the completion rules are defined as:

- A read or write is complete for a shareability domain when all of the following are true:
  - the read or write is globally observed for that shareability domain
  - any translation table walks associated with the read or write are complete for that shareability domain.
- A translation table walk is complete for a shareability domain when the memory accesses associated with the translation table walk are globally observed for that shareability domain, and the TLB is updated.
- A cache, branch predictor, or TLB maintenance operation is complete for a shareability domain when the effects of the operation are globally observed for that shareability domain, and any translation table walks that arise from the operation are complete for that shareability domain.

The completion of any cache, branch predictor or TLB maintenance operation includes its completion on all processors that are affected by both the operation and the DSB operation that is required to guarantee visibility of the maintenance operation.

### **Completion of side-effects of accesses to Strongly-ordered and Device memory**

The completion of a memory access to Strongly-ordered or Device memory is not guaranteed to be sufficient to determine that the side-effects of the memory access are visible to all observers. The mechanism that ensures the visibility of side-effects of a memory access is IMPLEMENTATION DEFINED.

### A3.8.2 Ordering requirements for memory accesses

ARMv7 and ARMv6 define access restrictions in the permitted ordering of memory accesses. These restrictions depend on the memory attributes of the accesses involved.

Two terms used in describing the memory access ordering requirements are:

#### Address dependency

An address dependency exists when the value returned by a read access is used for the computation of the virtual address of a subsequent read or write access. An address dependency exists even if the value read by the first read access does not change the virtual address of the second read or write access. This might be the case if the value returned is masked off before it is used, or if it has no effect on the predicted address value for the second access.

#### Control dependency

A control dependency exists when the data value returned by a read access determines the condition flags, and the values of the flags are used in the condition code checking that determines the address of a subsequent read access. This address determination might be through conditional execution, or through the evaluation of a branch.

Figure A3-5 shows the memory ordering between two explicit accesses A1 and A2, where A1 occurs before A2 in program order. In the figure, an access refers to a read or a write access to the specified memory type. For example, *Normal access* refers to a read or write access to Normal memory. The symbols used in the figure are as follows:

- < Accesses must arrive at any particular memory-mapped peripheral or block of memory in program order, that is, A1 must arrive before A2. There are no ordering restrictions about when accesses arrive at different peripherals or blocks of memory, provided that accesses follow the general ordering rules given in this section.
- Accesses can arrive at any memory-mapped peripheral or block of memory in any order, provided that the accesses follow the general ordering rules given in this section.

The size of a memory mapped peripheral, or a block of memory, is IMPLEMENTATION DEFINED, but is not smaller than 1KByte.

———— **Note** ————

This implies that the maximum memory-mapped peripheral size for which the architecture guarantees order for all implementations is 1KB.

A1 \ A2	Normal access	Device access ‡	Strongly-ordered access ‡
Normal access	-	-	-
Device access	-	<	<
Strongly-ordered access	-	<	<

‡ The ordering requirements for Device and Strongly-ordered accesses are identical.

**Figure A3-5 Memory ordering restrictions**

There are no ordering requirements for implicit accesses to any type of memory.

The following additional restrictions apply to the ordering of all memory accesses:

- For all accesses from a single observer, the requirements of uniprocessor semantics must be maintained, for example:
  - respecting dependencies between instructions in a single processor
  - coherency.



- If there is an address dependency then the two memory accesses are observed in program order by any observer in the common shareability domain of the two accesses.  
This ordering restriction does not apply if there is only a control dependency between the two read accesses. If there is both an address dependency and a control dependency between two read accesses the ordering requirements of the address dependency apply.
- If the value returned by a read access is used as data written by a subsequent write access, then the two memory accesses are observed in program order by any observer in the common shareability domain of the two accesses.
- It is impossible for an observer in the shareability domain of a memory location to observe an access by a store instruction that has not been architecturally executed.
- It is impossible for an observer in the shareability domain of a memory location to observe two reads to the same memory location performed by the same observer in an order that would not occur in a sequential execution of a program.
- For an implementation that does not include the Multiprocessing Extensions, it is IMPLEMENTATION DEFINED whether all writes complete in a finite period of time, or whether some writes require the execution of a DSB instruction to guarantee their completion.
- For an implementation that includes the Multiprocessing Extensions, all writes complete in a finite period of time.

———— **Note** —————

This applies for all writes, including repeated writes to the same location.

---

### Program order for instruction execution

The program order of instruction execution is the order of the instructions in a simple sequential execution of the program.

Explicit memory accesses in an execution can be either:

**Strictly Ordered**

Denoted by  $<$ . Must occur strictly in order.

**Ordered**

Denoted by  $<=$ . Can occur either in order or simultaneously.

Load/store multiple instructions, such as LDM, LDRD, STM, and STRD, generate multiple word accesses, each of which is a separate access for the purpose of determining ordering.

The rules for determining program order for two accesses A1 and A2 are:

If A1 and A2 are generated by two different instructions:

- $A1 < A2$  if the instruction that generates A1 occurs before the instruction that generates A2 in program order
- $A2 < A1$  if the instruction that generates A2 occurs before the instruction that generates A1 in program order.

If A1 and A2 are generated by the same instruction:

- If A1 and A2 are the load and store generated by a SWP or SWPB instruction:
  - $A1 < A2$  if A1 is the load and A2 is the store
  - $A2 < A1$  if A2 is the load and A1 is the store.

- In these descriptions:
    - an *LDM-class* instruction is any form of LDM, LDMDA, LDMDB, or LDMIB, or a POP instruction that operates on more than one register
    - an *LDC-class* instruction is an LDC, VLDM, VLDR, or VPOP instruction
    - an *STM-class* instruction is any form of STM, STMDA, STMDB, or STMIB, or a PUSH instruction that operates on more than one register
    - an *STC-class* instruction is an STC, VSTM, VSTR, or VPUSH instruction.
- If A1 and A2 are two word loads generated by an LDC-class or LDM-class instruction, or two word stores generated by an STC-class or STM-class instruction, excluding LDM-class and STM-class instructions with a register list that includes the PC:
- A1 <= A2 if the address of A1 is less than the address of A2
  - A2 <= A1 if the address of A2 is less than the address of A1.
- If A1 and A2 are two word loads generated by an LDM-class instruction with a register list that includes the PC or two word stores generated by an STM-class instruction with a register list that includes the PC, the program order of the memory accesses is not defined.
- If A1 and A2 are two word loads generated by an LDRD instruction or two word stores generated by an STRD instruction, the program order of the memory accesses is not defined.
  - If A1 and A2 are load or store accesses generated by Advanced SIMD element or structure load/store instructions, the program order of the memory accesses is not defined.
  - For any instruction or operation not explicitly mentioned in this section, if the single-copy atomicity rules described in [Single-copy atomicity on page A3-127](#) mean the operation becomes a sequence of accesses, then the time-ordering of those accesses is not defined.

### A3.8.3 Memory barriers

*Memory barrier* is the general term applied to an instruction, or sequence of instructions, that forces synchronization events by a processor with respect to retiring load/store instructions. The ARM architecture defines a number of memory barriers that provide a range of functionality, including:

- ordering of load/store instructions
- completion of load/store instructions
- context synchronization.

ARMv7 and ARMv6 require three explicit memory barriers to support the memory order model described in this chapter. In ARMv7 the memory barriers are provided as instructions that are available in the ARM and Thumb instruction sets, and in ARMv6 the memory barriers are performed by CP15 register writes. The three memory barriers are:

- Data Memory Barrier, see [Data Memory Barrier \(DMB\) on page A3-151](#)
- Data Synchronization Barrier, see [Data Synchronization Barrier \(DSB\) on page A3-152](#)
- Instruction Synchronization Barrier, see [Instruction Synchronization Barrier \(ISB\) on page A3-152](#).

———— **Note** —————

Depending on the required synchronization, a program might use memory barriers on their own, or it might use them in conjunction with cache and memory management maintenance operations that are only available when software execution is at PL1 or higher.

The DMB and DSB memory barriers affect reads and writes to the memory system generated by load/store instructions and data or unified cache maintenance operations being executed by the processor. Instruction fetches or accesses caused by a hardware translation table access are not explicit accesses.

## Data Memory Barrier (DMB)

The DMB instruction is a data memory barrier. The processor that executes the DMB instruction is referred to as the executing processor, Pe. The DMB instruction takes the *required shareability domain* and *required access types* as arguments, see [Shareability and access limitations on the data barrier operations](#) on page A3-152. If the required shareability is *Full system* then the operation applies to all observers within the system.

A DMB creates two groups of memory accesses, Group A and Group B:

**Group A** Contains:

- All explicit memory accesses of the required access types from observers in the same required shareability domain as Pe that are observed by Pe before the DMB instruction. These accesses include any accesses of the required access types performed by Pe.
- All loads of required access types from an observer Px in the same required shareability domain as Pe that have been observed by any given different observer, Py, in the same required shareability domain as Pe before Py has performed a memory access that is a member of Group A.

**Group B** Contains:

- All explicit memory accesses of the required access types by Pe that occur in program order after the DMB instruction.
- All explicit memory accesses of the required access types by any given observer Px in the same required shareability domain as Pe that can only occur after a load by Px has returned the result of a store that is a member of Group B.

Any observer with the same required shareability domain as Pe observes all members of Group A before it observes any member of Group B to the extent that those group members are required to be observed, as determined by the shareability and cacheability of the memory locations accessed by the group members.

Where members of Group A and members of Group B access the same memory-mapped peripheral or block of memory, of arbitrary system-defined size, then members of Group A that are accessing Strongly-ordered, Device, or Normal Non-cacheable memory arrive at that peripheral or block of memory before members of Group B that are accessing Strongly-ordered, Device, or Normal Non-cacheable memory.

### ———— Note —————

- Where the members of Group A and Group B that must be ordered are from the same processor, a DMB NSH is sufficient for this guarantee.
- A memory access might be in neither Group A nor Group B. The DMB does not affect the order of observation of such a memory access.
- The second part of the definition of Group A is recursive. Ultimately, membership of Group A derives from the observation by Py of a load before Py performs an access that is a member of Group A as a result of the first part of the definition of Group A.
- The second part of the definition of Group B is recursive. Ultimately, membership of Group B derives from the observation by any observer of an access by Pe that is a member of Group B as a result of the first part of the definition of Group B.

DMB only affects memory accesses and data and unified cache maintenance operations, see [Cache and branch predictor maintenance operations](#) on page B2-1277. It has no effect on the ordering of any other instructions executing on the processor.

For details of the DMB instruction in the Thumb and ARM instruction sets see [DMB](#) on page A8-378.

## Data Synchronization Barrier (DSB)

The DSB instruction is a special memory barrier, that synchronizes the execution stream with memory accesses. The DSB instruction takes the *required shareability domain* and *required access types* as arguments, see [Shareability and access limitations on the data barrier operations](#). If the required shareability is *Full system* then the operation applies to all observers within the system.

A DSB behaves as a DMB with the same arguments, and also has the additional properties defined here.

A DSB completes when:

- all explicit memory accesses that are observed by Pe before the DSB is executed, are of the required access types, and are from observers in the same required shareability domain as Pe, are complete for the set of observers in the required shareability domain
- all cache and branch predictor maintenance operations issued by Pe before the DSB are complete for the required shareability domain.
- if the required accesses types of the DSB is reads and writes, all TLB maintenance operations issued by Pe before the DSB are complete for the required shareability domain.

In addition, no instruction that appears in program order after the DSB instruction can execute until the DSB completes.

For details of the DSB instruction in the Thumb and ARM instruction sets see [DSB on page A8-380](#).

### ———— Note —————

Historically, this operation was referred to as *Drain Write Buffer* or *Data Write Barrier* (DWB). From ARMv6, these names and the use of DWB were deprecated in favor of the new *Data Synchronization Barrier* name and DSB abbreviation. DSB better reflects the functionality provided from ARMv6, because DSB is architecturally defined to include all cache, TLB and branch prediction maintenance operations as well as explicit memory operations.

## Instruction Synchronization Barrier (ISB)

An ISB instruction flushes the pipeline in the processor, so that all instructions that come after the ISB instruction in program order are fetched from cache or memory only after the ISB instruction has completed. Using an ISB ensures that the effects of context-changing operations executed before the ISB are visible to the instructions fetched after the ISB instruction. Examples of context-changing operations that require the insertion of an ISB instruction to ensure the effects of the operation are visible to instructions fetched after the ISB instruction are:

- completed cache, TLB, and branch predictor maintenance operations
- changes to system control registers.

Any context-changing operations appearing in program order after the ISB instruction only take effect after the ISB has been executed.

For more information about the ISB instruction in the Thumb and ARM instruction sets, see [ISB on page A8-389](#).

## Shareability and access limitations on the data barrier operations

The DMB and DSB instructions can each take an optional limitation argument that specifies:

- the shareability domain over which the instruction must operate, as one of:
  - full system
  - Outer Shareable
  - Inner Shareable
  - Non-shareable
- the accesses for which the instruction operates, as one of:
  - read and write accesses
  - write accesses only.

By default, each instruction operates for read and write accesses, over the full system, and whether an implementation supports any other options is IMPLEMENTATION DEFINED. See the instruction descriptions for more information about these arguments.

———— **Note** ————

ISB also supports an optional limitation argument, but supports only one value for that argument, that corresponds to full system operation.

In an implementation that includes the Virtualization Extensions, and supports shareability limitations on the data barrier operations, the **HCR.BSU** field can upgrade the required shareability of the operation for an instruction that is executed in a Non-secure PL1 or PL0 mode. [Table A3-6](#) shows the encoding of this field:

**Table A3-6 HCR.BSU encoding**

<b>HCR.BSU</b>	<b>Minimum shareability of instruction</b>
00	No effect, shareability is as specified by the instruction
01	Inner Shareable
10	Outer Shareable
11	Full system

For an instruction executed in a Non-secure PL1 or PL0 mode, [Table A3-7](#) shows how **HCR.BSU** upgrades the shareability specified by the argument of the DMB or DSB instruction:

**Table A3-7 Upgrading the shareability of data barrier operations**

<b>Shareability from DMB or DSB argument</b>	<b>HCR.BSU</b>	<b>Resultant shareability</b>
Full system	Any	Full system
Outer Shareable	00, 01, or 10	Outer Shareable
	11, Full system	Full system
Inner Shareable	00 or 01	Inner Shareable
	10, Outer Shareable	Outer Shareable
	11, Full system	Full system
Non-shareable	00, No effect	Non-shareable
	01, Inner Shareable	Inner Shareable
	10, Outer Shareable	Outer Shareable
	11, Full system	Full system

### Pseudocode details of memory barriers

The following types define the required shareability domains and required access types used as arguments for DMB and DSB instructions:

```
enumeration MBReqDomain {MBReqDomain_FullSystem,  
                        MBReqDomain_OuterShareable,  
                        MBReqDomain_InnerShareable,  
                        MBReqDomain_Nonshareable};  
  
enumeration MBReqTypes {MBReqTypes_All, MBReqTypes_Writes};
```

The following procedures perform the memory barriers:

```
DataMemoryBarrier(MBReqDomain domain, MBReqTypes types)  
  
DataSynchronizationBarrier(MBReqDomain domain, MBReqTypes types)  
  
InstructionSynchronizationBarrier()
```

## A3.9 Caches and memory hierarchy

The implementation of a memory system depends heavily on the microarchitecture and therefore the details of the system are IMPLEMENTATION DEFINED. ARMv7 defines the application level interface to the memory system, and supports a hierarchical memory system with multiple levels of cache. This section provides an application level view of this system. It contains the subsections:

- [Introduction to caches](#)
- [Memory hierarchy](#)
- [Implication of caches for the application programmer on page A3-156](#)
- [Preloading caches on page A3-157.](#)

### A3.9.1 Introduction to caches

A cache is a block of high-speed memory that contains a number of entries, each consisting of:

- main memory address information, commonly called a *tag*
- the associated data.

Caches increase the average speed of a memory access. Cache operation takes account of two principles of locality:

#### Spatial locality

An access to one location is likely to be followed by accesses to adjacent locations. Examples of this principle are:

- sequential instruction execution
- accessing a data structure.

#### Temporal locality

An access to an area of memory is likely to be repeated in a short time period. An example of this principle is the execution of a software loop.

To minimize the quantity of control information stored, the spatial locality property groups several locations together under the same tag. This logical block is commonly called a cache line. When data is loaded into a cache, access times for subsequent loads and stores are reduced, resulting in overall performance benefits. An access to information already in a cache is called a cache hit, and other accesses are called cache misses.

Normally, caches are self-managing, with the updates occurring automatically. Whenever the processor wants to access a cacheable location, the cache is checked. If the access is a cache hit, the access occurs in the cache, otherwise a location is allocated and the cache line loaded from memory. Different cache topologies and access policies are possible, however, they must comply with the memory coherency model of the underlying architecture.

Caches introduce a number of potential problems, mainly because of:

- memory accesses occurring at times other than when the programmer would otherwise expect them
- there being multiple physical locations where a data item can be held.

### A3.9.2 Memory hierarchy

Memory close to a processor has very low latency, but is limited in size and expensive to implement. Further from the processor it is easier to implement larger blocks of memory but these have increased latency. To optimize overall performance, an ARMv7 memory system can include multiple levels of cache in a hierarchical memory system. [Figure A3-6 on page A3-156](#) shows such a system, in an ARMv7-A implementation of a VMSA, supporting virtual addressing.

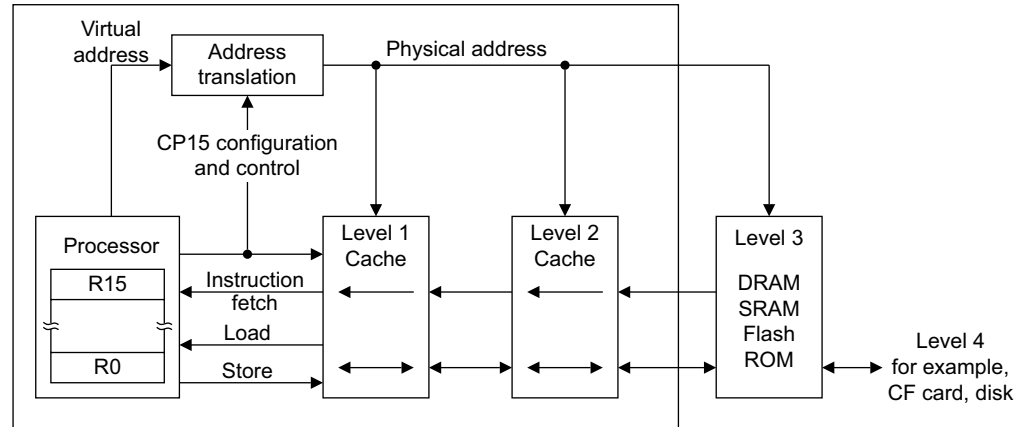

Figure A3-6 Multiple levels of cache in a memory hierarchy

———— **Note** ————

In this manual, in a hierarchical memory system, Level 1 refers to the level closest to the processor, as shown in [Figure A3-6](#).

### A3.9.3 Implication of caches for the application programmer

In normal operation, the caches are largely invisible to the application programmer. However they can become visible when there is a breakdown in the coherency of the caches. Such a breakdown can occur:

- when memory locations are updated by other agents in the system
- when memory updates made from the application software must be made visible to other agents in the system.

For example:

- In a system with a DMA controller that reads memory locations that are held in the data cache of a processor, a breakdown of coherency occurs when the processor has written new data in the data cache, but the DMA controller reads the old data held in memory.
- In a Harvard architecture of caches, where there are separate instruction and data caches, a breakdown of coherency occurs when new instruction data has been written into the data cache, but the instruction cache still contains the old instruction data.

#### Data coherency issues

Software can ensure the data coherency of caches in the following ways:

- By not using the caches in situations where coherency issues can arise. This can be achieved by:
  - using Non-cacheable or, in some cases, Write-Through Cacheable memory
  - not enabling caches in the system.
- By using cache maintenance operations to manage the coherency issues in software, see [About ARMv7 cache and branch predictor maintenance functionality on page B2-1273](#). Many of these operations are only available to system software.
- By using hardware coherency mechanisms to ensure the coherency of data accesses to memory for cacheable locations by observers within the different shareability domains, see [Non-shareable Normal memory on page A3-131](#) and [Shareable, Inner Shareable, and Outer Shareable Normal memory on page A3-132](#).



The performance of these hardware coherency mechanisms is highly implementation-specific. In some implementations the mechanism suppresses the ability to cache shareable locations. In other implementations, cache coherency hardware can hold data in caches while managing coherency between observers within the shareability domains.

### Instruction coherency issues

How far ahead of the current point of execution instructions are fetched from is IMPLEMENTATION DEFINED. Such prefetching can be either a fixed or a dynamically varying number of instructions, and can follow any or all possible future execution paths. For all types of memory:

- the processor might have fetched the instructions from memory at any time since the last context synchronization operation on that processor
- any instructions fetched in this way might be executed multiple times, if this is required by the execution of the program, without being refetched from memory

———— **Note** —————

See [Context synchronization operation](#) for the definition of this term.

In addition, the ARM architecture does not require the hardware to ensure coherency between instruction caches and memory, even for regions of memory with Shareable attributes. This means that for cacheable regions of memory, an instruction cache can hold instructions that were fetched from memory before the context synchronization operation.

If software requires coherency between instruction execution and memory, it must manage this coherency using the ISB and DSB memory barriers and cache maintenance operations, see [Ordering of cache and branch predictor maintenance operations on page B2-1289](#). Many of these operations are only available to system software.

### A3.9.4 Preloading caches

The ARM architecture provides memory system hints PLD (Preload Data), PLDW (Preload Data with intent to write), and PLI (Preload Instruction) to permit software to communicate the expected use of memory locations to the hardware. The memory system can respond by taking actions that are expected to speed up the memory accesses if and when they do occur. The effect of these memory system hints is IMPLEMENTATION DEFINED. Typically, implementations use this information to bring the data or instruction locations into caches that have faster access times than normal memory.

The Preload instructions are hints, and so implementations can treat them as NOPs without affecting the functional behavior of the device. The instructions do not generate synchronous Data Abort exceptions, but the memory system operations might, under exceptional circumstances, generate asynchronous aborts. For more information, see [Data Abort exception on page B1-1214](#).

For more information about the operation of these instructions see [Behavior of Preload Data \(PLD, PLDW\) and Preload Instruction \(PLI\) with caches on page B2-1269](#).

Hardware implementations can provide other implementation-specific mechanisms to fetch memory locations in the cache. These must comply with the general cache behavior described in [Cache behavior on page B2-1267](#).



# Chapter A4

## The Instruction Sets

This chapter describes the ARM and Thumb instruction sets. It contains the following sections:

- *About the instruction sets* on page A4-160
- *Unified Assembler Language* on page A4-162
- *Branch instructions* on page A4-164
- *Data-processing instructions* on page A4-165
- *Status register access instructions* on page A4-174
- *Load/store instructions* on page A4-175
- *Load/store multiple instructions* on page A4-177
- *Miscellaneous instructions* on page A4-178
- *Exception-generating and exception-handling instructions* on page A4-179
- *Coprocessor instructions* on page A4-180
- *Advanced SIMD and Floating-point load/store instructions* on page A4-181
- *Advanced SIMD and Floating-point register transfer instructions* on page A4-183
- *Advanced SIMD data-processing instructions* on page A4-184
- *Floating-point data-processing instructions* on page A4-191.

## A4.1 About the instruction sets

ARMv7 contains two main instruction sets, the ARM and Thumb instruction sets. Much of the functionality available is identical in the two instruction sets. This chapter describes the functionality available in the instruction sets, and the *Unified Assembler Language* (UAL) that can be assembled to either instruction set.

The two instruction sets differ in how instructions are encoded:

- Thumb instructions are either 16-bit or 32-bit, and are aligned on a two-byte boundary. 16-bit and 32-bit instructions can be intermixed freely. Many common operations are most efficiently executed using 16-bit instructions. However:
  - Most 16-bit instructions can only access the first eight of the ARM core registers, R0-R7. These are called the *low registers*. A small number of 16-bit instructions can also access the high registers, R8-R15.
  - Many operations that would require two or more 16-bit instructions can be more efficiently executed with a single 32-bit instruction.
  - All 32-bit instructions can access all of the ARM core registers, R0-R15.
- ARM instructions are always 32-bit, and are aligned on a four-byte boundary.

The ARM and Thumb instruction sets can *interwork* freely, that is, different procedures can be compiled or assembled to different instruction sets, and still be able to call each other efficiently.

ThumbEE is a variant of the Thumb instruction set that is designed as a target for dynamically generated code. However, it cannot interwork freely with the ARM and Thumb instruction sets.

In an implementation that includes a non-trivial Jazelle extension, the processor can execute some Java bytecodes in hardware. For more information see [Jazelle direct bytecode execution support on page A2-97](#). The processor executes Java bytecodes when it is in Jazelle state. However, this execution is outside the scope of this manual.

See:

- [Chapter A5 ARM Instruction Set Encoding](#) for encoding details of the ARM instruction set
- [Chapter A6 Thumb Instruction Set Encoding](#) for encoding details of the Thumb instruction set
- [Chapter A8 Instruction Details](#) for detailed descriptions of the instructions
- [Chapter A9 The ThumbEE Instruction Set](#) for encoding details of the ThumbEE instruction set.

### A4.1.1 Changing between Thumb state and ARM state

A processor in ARM state executes ARM instructions, and a processor in Thumb state executes Thumb instructions. A processor in Thumb state can enter ARM state by executing any of the following instructions: BX, BLX, or an LDR or LDM that loads the PC.

A processor in ARM state can enter Thumb state by executing any of the same instructions.

In ARMv7, a processor in ARM state can also enter Thumb state by executing an ADC, ADD, AND, ASR, BIC, EOR, LSL, LSR, MOV, MVN, ORR, ROR, RRX, RSB, RSC, SBC, or SUB instruction that has the PC as destination register and does not set the condition flags.

#### ———— **Note** ————

This permits calls and returns between ARM code written for ARMv4 processors and Thumb code running on ARMv7 processors to function correctly. ARM recommends that new software uses BX or BLX instructions instead. In particular, ARM recommends that software uses BX LR to return from a procedure, not MOV PC, LR.

The target instruction set is either encoded directly in the instruction (for the immediate offset version of BLX), or is held as bit[0] of an *interworking address*. For details, see the description of the `BXWri tePC()` function in [Pseudocode details of operations on ARM core registers on page A2-47](#).

Exception entries and returns can also change between ARM and Thumb states. For details see [Exception handling on page B1-1164](#).

## A4.1.2 Conditional execution

In the ARM and Thumb instruction sets, most instructions can be *conditionally executed*.

In the ARM instruction set, conditional execution means that an instruction only has its normal effect on the programmers' model operation, memory and coprocessors if the N, Z, C and V condition flags in the APSR satisfy a condition specified by the *cond* field in the instruction encoding. If the flags do not satisfy this condition, the instruction acts as a NOP, that is, execution advances to the next instruction as normal, including any relevant checks for exceptions being taken, but has no other effect.

In the Thumb instruction set, different mechanisms control conditional execution:

- For the following Thumb encodings, conditional execution is controlled in a similar way to the ARM instructions:
  - A 16-bit conditional branch instruction encoding, with a branch range of  $-256$  to  $+254$  bytes. Before ARMv6T2, this was the only mechanism for conditional execution in Thumb code.
  - A 32-bit conditional branch instruction encoding, with a branch range of approximately  $\pm 1\text{MB}$ .For more information about these encodings see [B on page A8-334](#).
- The CBZ and CBNZ instructions, Compare and Branch on Zero and Compare and Branch on Nonzero, are 16-bit conditional instructions with a branch range of  $+4$  to  $+130$  bytes. For details see [CBNZ, CBZ on page A8-356](#).
- The 16-bit If-Then instruction makes up to four following instructions conditional, and can make most other Thumb instructions conditional. For details see [IT on page A8-390](#). The instructions that are made conditional by an IT instruction are called its *IT block*. For any IT block, either:
  - all instructions have the same condition
  - some instructions have one condition, and the other instructions have the inverse condition.

ARM deprecates the conditional execution of any instruction encoding provided by the Advanced SIMD Extension that is not also provided by the Floating-point (VFP) Extension, and strongly recommends that any such instruction that can be conditionally executed is specified with the *<c>* field omitted or set to AL. For more information, see [Conditional execution on page A8-288](#).

For more information about conditional execution see [Conditional execution on page A8-288](#).

## A4.1.3 Writing to the PC

[Writing to the PC on page A2-46](#) gives an overview of instructions that write to the PC, including the required behavior of these writes. This information is also given in the appropriate sections of this chapter.

## A4.1.4 Permanently UNDEFINED encodings

All versions of the ARM architecture define some encodings as permanently UNDEFINED. That is, permanently UNDEFINED encodings are defined in the ARM instruction set encodings, and in the 16-bit and 32-bit Thumb encodings. From issue C.a of this manual, ARM defines an assembler mnemonic for the unconditional forms of these instructions, see [UDF on page A8-758](#).

## A4.2 Unified Assembler Language

This document uses the ARM *Unified Assembler Language* (UAL). This assembly language syntax provides a canonical form for all ARM and Thumb instructions.

UAL describes the syntax for the mnemonic and the operands of each instruction. In addition, it assumes that instructions and data items can be given labels. It does not specify the syntax to be used for labels, nor what assembler directives and options are available. See your assembler documentation for these details.

Most earlier ARM assembly language mnemonics are still supported as synonyms, as described in the instruction details.

### ———— Note —————

Most earlier Thumb assembly language mnemonics are *not* supported. For more information, see [Appendix H Legacy Instruction Mnemonics](#).

UAL includes *instruction selection* rules that specify which instruction encoding is selected when more than one can provide the required functionality. For example, both 16-bit and 32-bit encodings exist for an ADD R0, R1, R2 instruction. The most common instruction selection rule is that when both a 16-bit encoding and a 32-bit encoding are available, the 16-bit encoding is selected, to optimize code density.

Syntax options exist to override the normal instruction selection rules and ensure that a particular encoding is selected. These are useful when disassembling code, to ensure that subsequent assembly produces the original code, and in some other situations.

### A4.2.1 Conditional instructions

For maximum portability of UAL assembly language between the ARM and Thumb instruction sets, ARM recommends that:

- IT instructions are written before conditional instructions in the correct way for the Thumb instruction set.
- When assembling to the ARM instruction set, assemblers check that any IT instructions are correct, but do not generate any code for them.

Although other Thumb instructions are unconditional, all instructions that are made conditional by an IT instruction must be written with a condition. These conditions must match the conditions imposed by the IT instruction. For example, an ITTEEQ instruction imposes the EQ condition on the first two following instructions, and the NE condition on the next two. Those four instructions must be written with EQ, EQ, NE and NE conditions respectively.

Some instructions cannot be made conditional by an IT instruction. Some instructions can be conditional if they are the last instruction in the IT block, but not otherwise.

The branch instruction encodings that include a condition code field cannot be made conditional by an IT instruction. If the assembler syntax indicates a conditional branch that correctly matches a preceding IT instruction, it is assembled using a branch instruction encoding that does not include a condition code field.

### A4.2.2 Use of labels in UAL instruction syntax

The UAL syntax for some instructions includes the label of an instruction or a literal data item that is at a fixed offset from the instruction being specified. The assembler must:

1. Calculate the PC or `Align(PC, 4)` value of the instruction. The PC value of an instruction is its address plus 4 for a Thumb instruction, or plus 8 for an ARM instruction. The `Align(PC, 4)` value of an instruction is its PC value ANDed with `0xFFFFF0` to force it to be word-aligned. There is no difference between the PC and `Align(PC, 4)` values for an ARM instruction, but there can be for a Thumb instruction.
2. Calculate the offset from the PC or `Align(PC, 4)` value of the instruction to the address of the labelled instruction or literal data item.
3. Assemble a *PC-relative* encoding of the instruction, that is, one that reads its PC or `Align(PC, 4)` value and adds the calculated offset to form the required address.

———— **Note** ————

For instructions that can encode a subtraction operation, if the instruction cannot encode the calculated offset but can encode minus the calculated offset, the instruction encoding specifies a subtraction of minus the calculated offset.

The syntax of the following instructions includes a label:

- B, BL, and BLX (immediate). The assembler syntax for these instructions always specifies the label of the instruction that they branch to. Their encodings specify a sign-extended immediate offset that is added to the PC value of the instruction to form the target address of the branch.
- CBZ and CBZ. The assembler syntax for these instructions always specifies the label of the instruction that they branch to. Their encodings specify a zero-extended immediate offset that is added to the PC value of the instruction to form the target address of the branch. They do not support backward branches.
- LDC, LDC2, LDR, LDRB, LDRD, LDRH, LDRSB, LDRSH, PLD, PLDW, PLI, and VLDR. The normal assembler syntax of these load instructions can specify the label of a literal data item that is to be loaded. The encodings of these instructions specify a zero-extended immediate offset that is either added to or subtracted from the `Align(PC, 4)` value of the instruction to form the address of the data item. A few such encodings perform a fixed addition or a fixed subtraction and must only be used when that operation is required, but most contain a bit that specifies whether the offset is to be added or subtracted.

When the assembler calculates an offset of 0 for the normal syntax of these instructions, it must assemble an encoding that adds 0 to the `Align(PC, 4)` value of the instruction. Encodings that subtract 0 from the `Align(PC, 4)` value cannot be specified by the normal syntax.

There is an alternative syntax for these instructions that specifies the addition or subtraction and the immediate offset explicitly. In this syntax, the label is replaced by `[PC, #+/-<imm>]`, where:

- +/- Is + or omitted to specify that the immediate offset is to be added to the `Align(PC, 4)` value, or - if it is to be subtracted.
- <imm> Is the immediate offset.

This alternative syntax makes it possible to assemble the encodings that subtract 0 from the `Align(PC, 4)` value, and to disassemble them to a syntax that can be re-assembled correctly.

- ADR. The normal assembler syntax for this instruction can specify the label of an instruction or literal data item whose address is to be calculated. Its encoding specifies a zero-extended immediate offset that is either added to or subtracted from the `Align(PC, 4)` value of the instruction to form the address of the data item, and some opcode bits that determine whether it is an addition or subtraction.

When the assembler calculates an offset of 0 for the normal syntax of this instruction, it must assemble the encoding that adds 0 to the `Align(PC, 4)` value of the instruction. The encoding that subtracts 0 from the `Align(PC, 4)` value cannot be specified by the normal syntax.

There is an alternative syntax for this instruction that specifies the addition or subtraction and the immediate value explicitly, by writing them as additions `ADD <Rd>, PC, #<imm>` or subtractions `SUB <Rd>, PC, #<imm>`. This alternative syntax makes it possible to assemble the encoding that subtracts 0 from the `Align(PC, 4)` value, and to disassemble it to a syntax that can be re-assembled correctly.

———— **Note** ————

ARM recommends that where possible, software avoids using:

- The alternative syntax for the ADR, LDC, LDC2, LDR, LDRB, LDRD, LDRH, LDRSB, LDRSH, PLD, PLI, PLDW, and VLDR instructions.
- The encodings of these instructions that subtract 0 from the `Align(PC, 4)` value.

## A4.3 Branch instructions

Table A4-1 summarizes the branch instructions in the ARM and Thumb instruction sets. In addition to providing for changes in the flow of execution, some branch instructions can change instruction set.

**Table A4-1 Branch instructions**

Instruction	See	Range, Thumb	Range, ARM
Branch to target address	<a href="#">B on page A8-334</a>	±16MB	±32MB
Compare and Branch on Nonzero, Compare and Branch on Zero	<a href="#">CBNZ, CBZ on page A8-356</a>	0-126 bytes	a
Call a subroutine	<a href="#">BL, BLX (immediate) on page A8-348</a>	±16MB	±32MB
Call a subroutine, change instruction set <sup>b</sup>	<a href="#">BL, BLX (immediate) on page A8-348</a>	±16MB	±32MB
Call a subroutine, optionally change instruction set	<a href="#">BLX (register) on page A8-350</a>	Any	Any
Branch to target address, change instruction set	<a href="#">BX on page A8-352</a>	Any	Any
Change to Jazelle state	<a href="#">BXJ on page A8-354</a>	-	-
Table Branch (byte offsets)	<a href="#">TBB, TBH on page A8-736</a>	0-510 bytes	a
Table Branch (halfword offsets)		0-131070 bytes	

- a. These instructions do not exist in the ARM instruction set.  
b. The range is determined by the instruction set of the BLX instruction, not of the instruction it branches to.

Branches to loaded and calculated addresses can be performed by LDR, LDM and data-processing instructions. For details see [Load/store instructions on page A4-175](#), [Load/store multiple instructions on page A4-177](#), [Standard data-processing instructions on page A4-165](#), and [Shift instructions on page A4-167](#).

In addition to the branch instructions shown in Table A4-1:

- In the ARM instruction set, a data-processing instruction that targets the PC behaves as a branch instruction. For more information, see [Data-processing instructions on page A4-165](#).
- In the ARM and Thumb instruction sets, a load instruction that targets the PC behaves as a branch instruction. For more information, see [Load/store instructions on page A4-175](#).



## A4.4 Data-processing instructions

Core data-processing instructions belong to one of the following groups:

- [Standard data-processing instructions](#).  
These instructions perform basic data-processing operations, and share a common format with some variations.
- [Shift instructions on page A4-167](#).
- [Multiply instructions on page A4-167](#).
- [Saturating instructions on page A4-169](#).
- [Saturating addition and subtraction instructions on page A4-169](#).
- [Packing and unpacking instructions on page A4-170](#).
- [Parallel addition and subtraction instructions on page A4-171](#).
- [Divide instructions on page A4-172](#).
- [Miscellaneous data-processing instructions on page A4-173](#).

For extension data-processing instructions, see [Advanced SIMD data-processing instructions on page A4-184](#) and [Floating-point data-processing instructions on page A4-191](#).

### A4.4.1 Standard data-processing instructions

These instructions generally have a destination register Rd, a first operand register Rn, and a second operand. The second operand can be another register Rm, or an immediate constant.

If the second operand is an immediate constant, it can be:

- Encoded directly in the instruction.
- A *modified immediate constant* that uses 12 bits of the instruction to encode a range of constants. Thumb and ARM instructions have slightly different ranges of modified immediate constants. For more information, see [Modified immediate constants in Thumb instructions on page A6-232](#) and [Modified immediate constants in ARM instructions on page A5-200](#).

If the second operand is another register, it can optionally be shifted in any of the following ways:

LSL	Logical Shift Left by 1-31 bits.
LSR	Logical Shift Right by 1-32 bits.
ASR	Arithmetic Shift Right by 1-32 bits.
ROR	Rotate Right by 1-31 bits.
RRX	Rotate Right with Extend. For details see <a href="#">Shift and rotate operations on page A2-41</a> .

In Thumb code, the amount to shift by is always a constant encoded in the instruction. In ARM code, the amount to shift by is either a constant encoded in the instruction, or the value of a register, Rs.

For instructions other than CMN, CMP, TEQ, and TST, the result of the data-processing operation is placed in the destination register. In the ARM instruction set, the destination register can be the PC, causing the result to be treated as a branch address. In the Thumb instruction set, this is only permitted for some 16-bit forms of the ADD and MOV instructions.

These instructions can optionally set the condition flags, according to the result of the operation. If they do not set the flags, existing flag settings from a previous instruction are preserved.

[Table A4-2 on page A4-166](#) summarizes the main data-processing instructions in the Thumb and ARM instruction sets. Generally, each of these instructions is described in three sections in [Chapter A8 Instruction Details](#), one section for each of the following:

- INSTRUCTION (immediate) where the second operand is a modified immediate constant.
- INSTRUCTION (register) where the second operand is a register, or a register shifted by a constant.
- INSTRUCTION (register-shifted register) where the second operand is a register shifted by a value obtained from another register. These are only available in the ARM instruction set.

**Table A4-2 Standard data-processing instructions**

Instruction	Mnemonic	Notes
Add with Carry	ADC	-
Add	ADD	Thumb instruction set permits use of a modified immediate constant or a zero-extended 12-bit immediate constant.
Form PC-relative Address	ADR	First operand is the PC. Second operand is an immediate constant. Thumb instruction set uses a zero-extended 12-bit immediate constant. Operation is an addition or a subtraction.
Bitwise AND	AND	-
Bitwise Bit Clear	BIC	-
Compare Negative	CMN	Sets flags. Like ADD but with no destination register.
Compare	CMP	Sets flags. Like SUB but with no destination register.
Bitwise Exclusive OR	EOR	-
Copy operand to destination	MOV	Has only one operand, with the same options as the second operand in most of these instructions. If the operand is a shifted register, the instruction is an LSL, LSR, ASR, or ROR instruction instead. For details see <a href="#">Shift instructions on page A4-167</a> . The ARM and Thumb instruction sets permit use of a modified immediate constant or a zero-extended 16-bit immediate constant.
Bitwise NOT	MVN	Has only one operand, with the same options as the second operand in most of these instructions.
Bitwise OR NOT	ORN	Not available in the ARM instruction set.
Bitwise OR	ORR	-
Reverse Subtract	RSB	Subtracts first operand from second operand. This permits subtraction from constants and shifted registers.
Reverse Subtract with Carry	RSC	Not available in the Thumb instruction set.
Subtract with Carry	SBC	-
Subtract	SUB	Thumb instruction set permits use of a modified immediate constant or a zero-extended 12-bit immediate constant.
Test Equivalence	TEQ	Sets flags. Like EOR but with no destination register.
Test	TST	Sets flags. Like AND but with no destination register.

## A4.4.2 Shift instructions

Table A4-3 lists the shift instructions in the ARM and Thumb instruction sets.

**Table A4-3 Shift instructions**

Instruction	See
Arithmetic Shift Right	<i>ASR (immediate)</i> on page A8-330
Arithmetic Shift Right	<i>ASR (register)</i> on page A8-332
Logical Shift Left	<i>LSL (immediate)</i> on page A8-468
Logical Shift Left	<i>LSL (register)</i> on page A8-470
Logical Shift Right	<i>LSR (immediate)</i> on page A8-472
Logical Shift Right	<i>LSR (register)</i> on page A8-474
Rotate Right	<i>ROR (immediate)</i> on page A8-568
Rotate Right	<i>ROR (register)</i> on page A8-570
Rotate Right with Extend	<i>RRX</i> on page A8-572

In the ARM instruction set only, the destination register of these instructions can be the PC, causing the result to be treated as an address to branch to.

## A4.4.3 Multiply instructions

These instructions can operate on signed or unsigned quantities. In some types of operation, the results are same whether the operands are signed or unsigned.

- [Table A4-4](#) summarizes the multiply instructions where there is no distinction between signed and unsigned quantities.  
The least significant 32 bits of the result are used. More significant bits are discarded.
- [Table A4-5 on page A4-168](#) summarizes the signed multiply instructions.
- [Table A4-6 on page A4-168](#) summarizes the unsigned multiply instructions.

**Table A4-4 General multiply instructions**

Instruction	See	Operation (number of bits)
Multiply Accumulate	<i>MLA</i> on page A8-480	$32 = 32 + 32 \times 32$
Multiply and Subtract	<i>MLS</i> on page A8-482	$32 = 32 - 32 \times 32$
Multiply	<i>MUL</i> on page A8-502	$32 = 32 \times 32$

**Table A4-5 Signed multiply instructions**

<b>Instruction</b>	<b>See</b>	<b>Operation (number of bits)</b>
Signed Multiply Accumulate (halfwords)	<i>SMLABB, SMLABT, SMLATB, SMLATT</i> on page A8-620	$32 = 32 + 16 \times 16$
Signed Multiply Accumulate Dual	<i>SMLAD</i> on page A8-622	$32 = 32 + 16 \times 16 + 16 \times 16$
Signed Multiply Accumulate Long	<i>SMLAL</i> on page A8-624	$64 = 64 + 32 \times 32$
Signed Multiply Accumulate Long (halfwords)	<i>SMLALBB, SMLALBT, SMLALTB, SMLALTT</i> on page A8-626	$64 = 64 + 16 \times 16$
Signed Multiply Accumulate Long Dual	<i>SMLALD</i> on page A8-628	$64 = 64 + 16 \times 16 + 16 \times 16$
Signed Multiply Accumulate (word by halfword)	<i>SMLAWB, SMLAWT</i> on page A8-630	$32 = 32 + 32 \times 16^a$
Signed Multiply Subtract Dual	<i>SMLSDD</i> on page A8-632	$32 = 32 + 16 \times 16 - 16 \times 16$
Signed Multiply Subtract Long Dual	<i>SMLSDD</i> on page A8-634	$64 = 64 + 16 \times 16 - 16 \times 16$
Signed Most Significant Word Multiply Accumulate	<i>SMMLA</i> on page A8-636	$32 = 32 + 32 \times 32^b$
Signed Most Significant Word Multiply Subtract	<i>SMMLS</i> on page A8-638	$32 = 32 - 32 \times 32^b$
Signed Most Significant Word Multiply	<i>SMMUL</i> on page A8-640	$32 = 32 \times 32^b$
Signed Dual Multiply Add	<i>SMUAD</i> on page A8-642	$32 = 16 \times 16 + 16 \times 16$
Signed Multiply (halfwords)	<i>SMULBB, SMULBT, SMULTB, SMULTT</i> on page A8-644	$32 = 16 \times 16$
Signed Multiply Long	<i>SMULL</i> on page A8-646	$64 = 32 \times 32$
Signed Multiply (word by halfword)	<i>SMULWB, SMULWT</i> on page A8-648	$32 = 32 \times 16^a$
Signed Dual Multiply Subtract	<i>SMUSD</i> on page A8-650	$32 = 16 \times 16 - 16 \times 16$

a. The most significant 32 bits of the 48-bit product are used. Less significant bits are discarded.

b. The most significant 32 bits of the 64-bit product are used. Less significant bits are discarded.

**Table A4-6 Unsigned multiply instructions**

<b>Instruction</b>	<b>See</b>	<b>Operation (number of bits)</b>
Unsigned Multiply Accumulate Accumulate Long	<i>UMAAL</i> on page A8-774	$64 = 32 + 32 + 32 \times 32$
Unsigned Multiply Accumulate Long	<i>UMLAL</i> on page A8-776	$64 = 64 + 32 \times 32$
Unsigned Multiply Long	<i>UMULL</i> on page A8-778	$64 = 32 \times 32$

#### A4.4.4 Saturating instructions

Table A4-7 lists the saturating instructions in the ARM and Thumb instruction sets. For more information, see [Pseudocode details of saturation on page A2-44](#).

**Table A4-7 Saturating instructions**

Instruction	See	Operation
Signed Saturate	<a href="#">SSAT on page A8-652</a>	Saturates optionally shifted 32-bit value to selected range
Signed Saturate 16	<a href="#">SSAT16 on page A8-654</a>	Saturates two 16-bit values to selected range
Unsigned Saturate	<a href="#">USAT on page A8-796</a>	Saturates optionally shifted 32-bit value to selected range
Unsigned Saturate 16	<a href="#">USAT16 on page A8-798</a>	Saturates two 16-bit values to selected range

#### A4.4.5 Saturating addition and subtraction instructions

Table A4-8 lists the saturating addition and subtraction instructions in the ARM and Thumb instruction sets. For more information, see [Pseudocode details of saturation on page A2-44](#).

**Table A4-8 Saturating addition and subtraction instructions**

Instruction	See	Operation
Saturating Add	<a href="#">QADD on page A8-540</a>	Add, saturating result to the 32-bit signed integer range
Saturating Subtract	<a href="#">QSUB on page A8-554</a>	Subtract, saturating result to the 32-bit signed integer range
Saturating Double and Add	<a href="#">QDADD on page A8-548</a>	Doubles one value and adds a second value, saturating the doubling and the addition to the 32-bit signed integer range
Saturating Double and Subtract	<a href="#">QDSUB on page A8-550</a>	Doubles one value and subtracts the result from a second value, saturating the doubling and the subtraction to the 32-bit signed integer range

## A4.4.6 Packing and unpacking instructions

Table A4-9 lists the packing and unpacking instructions in the ARM and Thumb instruction sets. These are all available from ARMv6T2 in the Thumb instruction set, and from ARMv6 onwards in the ARM instruction set.

**Table A4-9 Packing and unpacking instructions**

Instruction	See	Operation
Pack Halfword	<a href="#">PKH on page A8-522</a>	Combine halfwords
Signed Extend and Add Byte	<a href="#">SXTAB on page A8-724</a>	Extend 8 bits to 32 and add
Signed Extend and Add Byte 16	<a href="#">SXTAB16 on page A8-726</a>	Dual extend 8 bits to 16 and add
Signed Extend and Add Halfword	<a href="#">SXTAH on page A8-728</a>	Extend 16 bits to 32 and add
Signed Extend Byte	<a href="#">SXTB on page A8-730</a>	Extend 8 bits to 32
Signed Extend Byte 16	<a href="#">SXTB16 on page A8-732</a>	Dual extend 8 bits to 16
Signed Extend Halfword	<a href="#">SXTH on page A8-734</a>	Extend 16 bits to 32
Unsigned Extend and Add Byte	<a href="#">UXTAB on page A8-806</a>	Extend 8 bits to 32 and add
Unsigned Extend and Add Byte 16	<a href="#">UXTAB16 on page A8-808</a>	Dual extend 8 bits to 16 and add
Unsigned Extend and Add Halfword	<a href="#">UXTAH on page A8-810</a>	Extend 16 bits to 32 and add
Unsigned Extend Byte	<a href="#">UXTB on page A8-812</a>	Extend 8 bits to 32
Unsigned Extend Byte 16	<a href="#">UXTB16 on page A8-814</a>	Dual extend 8 bits to 16
Unsigned Extend Halfword	<a href="#">UXTH on page A8-816</a>	Extend 16 bits to 32

### A4.4.7 Parallel addition and subtraction instructions

These instructions perform additions and subtractions on the values of two registers and write the result to a destination register, treating the register values as sets of two halfwords or four bytes. That is, they perform SIMD additions or subtractions on the registers. They are available in ARMv6 and above.

These instructions consist of a prefix followed by a main instruction mnemonic. The prefixes are as follows:

S	Signed arithmetic modulo $2^8$ or $2^{16}$ .
Q	Signed saturating arithmetic.
SH	Signed arithmetic, halving the results.
U	Unsigned arithmetic modulo $2^8$ or $2^{16}$ .
UQ	Unsigned saturating arithmetic.
UH	Unsigned arithmetic, halving the results.

The main instruction mnemonics are as follows:

ADD16	Adds the top halfwords of two operands to form the top halfword of the result, and the bottom halfwords of the same two operands to form the bottom halfword of the result.
ASX	Exchanges halfwords of the second operand, and then adds top halfwords and subtracts bottom halfwords.
SAX	Exchanges halfwords of the second operand, and then subtracts top halfwords and adds bottom halfwords.
SUB16	Subtracts each halfword of the second operand from the corresponding halfword of the first operand to form the corresponding halfword of the result.
ADD8	Adds each byte of the second operand to the corresponding byte of the first operand to form the corresponding byte of the result.
SUB8	Subtracts each byte of the second operand from the corresponding byte of the first operand to form the corresponding byte of the result.

The instruction set permits all 36 combinations of prefix and main instruction operand, as [Table A4-10](#) shows.

See also [Advanced SIMD parallel addition and subtraction on page A4-185](#).

**Table A4-10 Parallel addition and subtraction instructions**

Main instruction	Signed	Saturating	Signed halving	Unsigned	Unsigned saturating	Unsigned halving
ADD16, add, two halfwords	SADD16	QADD16	SHADD16	UADD16	UQADD16	UHADD16
ASX, add and subtract with exchange	SASX	QASX	SHASX	UASX	UQASX	UHASX
SAX, subtract and add with exchange	SSAX	QSAX	SHSAX	USAX	UQSAX	UHSAX
SUB16, subtract, two halfwords	SSUB16	QSUB16	SHSUB16	USUB16	UQSUB16	UHSUB16
ADD8, add, four words	SADD8	QADD8	SHADD8	UADD8	UQADD8	UHADD8
SUB8, subtract, four words	SSUB8	QSUB8	SHSUB8	USUB8	UQSUB8	UHSUB8

## A4.4.8 Divide instructions

The ARMv7-R profile introduces support for signed and unsigned integer divide instructions, implemented in hardware, in the Thumb instruction set. For more information see [ARMv7 implementation requirements and options for the divide instructions](#).

For descriptions of the instructions see:

- [SDIV](#) on page A8-600
- [UDIV](#) on page A8-760.

---

**Note**

- The Virtualization Extensions introduce the requirement for an ARMv7-A implementation to include SDIV and UDIV.
- The ARMv7-M profile also includes the SDIV and UDIV instructions.

---

In the ARMv7-R profile, the **SCTLR.DZ** bit enables divide by zero fault detection:

**SCTLR.DZ** == 0 Divide-by-zero returns a zero result.

**SCTLR.DZ** == 1 SDIV and UDIV generate an Undefined Instruction exception on a divide-by-zero.

The **SCTLR.DZ** bit is cleared to zero on reset.

In an ARMv7-A profile implementation that supports the SDIV and UDIV instructions, divide-by-zero always returns a zero result.

### ARMv7 implementation requirements and options for the divide instructions

Any implementation of the ARMv7-R profile must include the SDIV and UDIV instructions in the Thumb instruction set.

Any implementation of the Virtualization Extensions must include the SDIV and UDIV instructions in the Thumb and ARM instruction sets.

In the ARMv7-R profile, the implementation of SDIV and UDIV in the ARM instruction set is OPTIONAL.

In an ARMv7-A implementation that does not include the Virtualization Extensions, the implementation of SDIV and UDIV in both instruction sets is OPTIONAL, but the architecture permits an ARMv7-A implementation to not implement SDIV and UDIV.

---

**Note**

Previous issues of this document have stated that a VMSAv7 implementation might implement SDIV and UDIV in the Thumb instruction set but not in the ARM instruction set. ARM strongly recommends against this implementation option.

---

The **ID\_ISAR0.Divide\_instrs** field indicates the level of support for these instructions, see [ID\\_ISAR0, Instruction Set Attribute Register 0, VMSA](#) on page B4-1607 or [ID\\_ISAR0, Instruction Set Attribute Register 0, PMSA](#) on page B6-1854:

- a field value of 0b0001 indicates they are implemented in the Thumb instruction set
- a field value of 0b0010 indicates they are implemented in both the Thumb and ARM instruction sets.



#### A4.4.9 Miscellaneous data-processing instructions

Table A4-11 lists the miscellaneous data-processing instructions in the ARM and Thumb instruction sets. Immediate values in these instructions are simple binary numbers.

**Table A4-11 Miscellaneous data-processing instructions**

<b>Instruction</b>	<b>See</b>	<b>Notes</b>
Bit Field Clear	<a href="#">BFC on page A8-336</a>	-
Bit Field Insert	<a href="#">BFI on page A8-338</a>	-
Count Leading Zeros	<a href="#">CLZ on page A8-362</a>	-
Move Top	<a href="#">MOVT on page A8-491</a>	Moves 16-bit immediate value to top halfword. Bottom halfword unchanged.
Reverse Bits	<a href="#">RBIT on page A8-560</a>	-
Byte-Reverse Word	<a href="#">REV on page A8-562</a>	-
Byte-Reverse Packed Halfword	<a href="#">REV16 on page A8-564</a>	-
Byte-Reverse Signed Halfword	<a href="#">REVSH on page A8-566</a>	-
Signed Bit Field Extract	<a href="#">SBFX on page A8-598</a>	-
Select Bytes using GE flags	<a href="#">SEL on page A8-602</a>	-
Unsigned Bit Field Extract	<a href="#">UBFX on page A8-756</a>	-
Unsigned Sum of Absolute Differences	<a href="#">USAD8 on page A8-792</a>	-
Unsigned Sum of Absolute Differences and Accumulate	<a href="#">USADA8 on page A8-794</a>	-

## A4.5 Status register access instructions

The MRS and MSR instructions move the contents of the *Application Program Status Register* (APSR) to or from an ARM core register, see:

- [MRS on page A8-496](#)
- [MSR \(immediate\) on page A8-498](#)
- [MSR \(register\) on page A8-500](#).

[The Application Program Status Register \(APSR\) on page A2-49](#) described the APSR.

The condition flags in the APSR are normally set by executing data-processing instructions, and normally control the execution of conditional instructions. However, software can set the condition flags explicitly using the MSR instruction, and can read the current state of the condition flags explicitly using the MRS instruction.

At system level, software can also:

- use these instructions to access the [SPSR](#) of the current mode
- use the CPS instruction to change the [CPSR.M](#) field and the [CPSR](#). {A, I, F} interrupt mask bits.

For details of the system level use of status register access instructions CPS, MRS, and MSR, see:

- [CPS \(Thumb\) on page B9-1976](#)
- [CPS \(ARM\) on page B9-1978](#)
- [MRS on page B9-1988](#)
- [MSR \(immediate\) on page B9-1994](#)
- [MSR \(register\) on page B9-1996](#).

### A4.5.1 Banked register access instructions

In a processor that implements the Virtualization Extensions, in all modes except User mode, the MRS (Banked register) and MSR (Banked register) instructions move the contents of a Banked ARM core register, the [SPSR](#), or the [ELR\\_hyp](#), to or from an ARM core register. For instruction descriptions see:

- [MRS \(Banked register\) on page B9-1990](#)
- [MSR \(Banked register\) on page B9-1992](#).

———— **Note** —————

These are system level instructions.

---

## A4.6 Load/store instructions

Table A4-12 summarizes the ARM core register load/store instructions in the ARM and Thumb instruction sets. See also:

- [Load/store multiple instructions on page A4-177](#)
- [Advanced SIMD and Floating-point load/store instructions on page A4-181](#).

Load/store instructions have several options for addressing memory. For more information, see [Addressing modes on page A4-176](#).

**Table A4-12 Load/store instructions**

Data type	Load	Store	Load unprivileged	Store unprivileged	Load-Exclusive	Store-Exclusive
32-bit word	LDR	STR	LDRT	STRT	LDREX	STREX
16-bit halfword	-	STRH	-	STRHT	-	STREXH
16-bit unsigned halfword	LDRH	-	LDRHT	-	LDREXH	-
16-bit signed halfword	LDRSH	-	LDRSHT	-	-	-
8-bit byte	-	STRB	-	STRBT	-	STREXB
8-bit unsigned byte	LDRB	-	LDRBT	-	LDREXB	-
8-bit signed byte	LDRSB	-	LDRSBT	-	-	-
Two 32-bit words	LDRD	STRD	-	-	-	-
64-bit doubleword	-	-	-	-	LDREXD	STREXD

### A4.6.1 Loads to the PC

The LDR instruction can load a value into the PC. The value loaded is treated as an interworking address, as described by the `LoadWritePC()` pseudocode function in [Pseudocode details of operations on ARM core registers on page A2-47](#).

### A4.6.2 Halfword and byte loads and stores

Halfword and byte stores store the least significant halfword or byte from the register, to 16 or 8 bits of memory respectively. There is no distinction between signed and unsigned stores.

Halfword and byte loads load 16 or 8 bits from memory into the least significant halfword or byte of a register. Unsigned loads zero-extend the loaded value to 32 bits, and signed loads sign-extend the value to 32 bits.

### A4.6.3 Load unprivileged and Store unprivileged

When executing at PL0, a Load unprivileged or Store unprivileged instruction operates in exactly the same way as the corresponding ordinary load or store instruction. For example, an LDRT instruction executes in exactly the same way as the equivalent LDR instruction. When executed at PL1, Load unprivileged and Store unprivileged instructions behave as they would if they were executed at PL0. For example, an LDRT instruction executes in exactly the way that the equivalent LDR instruction would execute at PL0. In particular, the instructions make unprivileged memory accesses.

The Load unprivileged and Store unprivileged instructions are UNPREDICTABLE if executed at PL2.

For more information, see [Privilege level access controls for data accesses on page A3-142](#).

#### A4.6.4 Exclusive loads and stores

Exclusive loads and stores provide shared memory synchronization. For more information, see [Synchronization and semaphores](#) on page A3-114.

#### A4.6.5 Addressing modes

The address for a load or store is formed from two parts: a value from a base register, and an offset.

The base register can be any one of the ARM core registers R0-R12, SP, or LR.

For loads, the base register can be the PC. This permits PC-relative addressing for position-independent code. Instructions marked (literal) in their title in [Chapter A8 Instruction Details](#) are PC-relative loads.

The offset takes one of three formats:

- |                        |  |
|------------------------|--|
| <b>Immediate</b>       | The offset is an unsigned number that can be added to or subtracted from the base register value. Immediate offset addressing is useful for accessing data elements that are a fixed distance from the start of the data object, such as structure fields, stack offsets and input/output registers. |
| <b>Register</b>        | The offset is a value from an ARM core register. This register cannot be the PC. The value can be added to, or subtracted from, the base register value. Register offsets are useful for accessing arrays or blocks of data.   |
| <b>Scaled register</b> | The offset is an ARM core register, other than the PC, shifted by an immediate value, then added to or subtracted from the base register. This means an array index can be scaled by the size of each array element.   |

The offset and base register can be used in three different ways to form the memory address. The addressing modes are described as follows:

- |                     |  |
|---------------------|--|
| <b>Offset</b>       | The offset is added to or subtracted from the base register to form the memory address.  |
| <b>Pre-indexed</b>  | The offset is added to or subtracted from the base register to form the memory address. The base register is then updated with this new address, to permit automatic indexing through an array or memory block.                                      |
| <b>Post-indexed</b> | The value of the base register alone is used as the memory address. The offset is then added to or subtracted from the base register. The result is stored back in the base register, to permit automatic indexing through an array or memory block. |

———— **Note** —————

Not every variant is available for every instruction, and the range of permitted immediate values and the options for scaled registers vary from instruction to instruction. See [Chapter A8 Instruction Details](#) for full details for each instruction.

## A4.7 Load/store multiple instructions

Load Multiple instructions load a subset, or possibly all, of the ARM core registers from memory.

Store Multiple instructions store a subset, or possibly all, of the ARM core registers to memory.

The memory locations are consecutive word-aligned words. The addresses used are obtained from a base register, and can be either above or below the value in the base register. The base register can optionally be updated by the total size of the data transferred.

[Table A4-13](#) summarizes the load/store multiple instructions in the ARM and Thumb instruction sets.

**Table A4-13 Load/store multiple instructions**

Instruction	See
Load Multiple, Increment After or Full Descending	<a href="#">LDM/LDMIA/LDMFD (Thumb) on page A8-396</a>
Load Multiple, Decrement After or Full Ascending <sup>a</sup>	<a href="#">LDMDA/LDMFA on page A8-400</a>
Load Multiple, Decrement Before or Empty Ascending	<a href="#">LDMDB/LDMEA on page A8-402</a>
Load Multiple, Increment Before or Empty Descending <sup>a</sup>	<a href="#">LDMIB/LDMED on page A8-404</a>
Pop multiple registers off the stack <sup>b</sup>	<a href="#">POP (Thumb) on page A8-534</a>
Push multiple registers onto the stack <sup>c</sup>	<a href="#">PUSH on page A8-538</a>
Store Multiple, Increment After or Empty Ascending	<a href="#">STM (STMIA, STMEA) on page A8-664</a>
Store Multiple, Decrement After or Empty Descending <sup>a</sup>	<a href="#">STMDA (STMED) on page A8-666</a>
Store Multiple, Decrement Before or Full Descending	<a href="#">STMDB (STMFD) on page A8-668</a>
Store Multiple, Increment Before or Full Ascending <sup>a</sup>	<a href="#">STMIB (STMFA) on page A8-670</a>

a. Not available in the Thumb instruction set.

b. This instruction is equivalent to an LDM instruction with the SP as base register, and base register updating.

c. This instruction is equivalent to an STMDB instruction with the SP as base register, and base register updating.

When executing at PL1, variants of the LDM and STM instructions load and store User mode registers. Another system level variant of the LDM instruction performs an exception return. For details of these variants, see [Chapter B9 System Instructions](#).

### A4.7.1 Loads to the PC

The LDM, LDMDA, LDMDB, LDMIB, and POP instructions can load a value into the PC. The value loaded is treated as an interworking address, as described by the LoadWritePC() pseudocode function in [Pseudocode details of operations on ARM core registers on page A2-47](#).

## A4.8 Miscellaneous instructions

Table A4-14 summarizes the miscellaneous instructions in the ARM and Thumb instruction sets.

**Table A4-14 Miscellaneous instructions**

<b>Instruction</b>	<b>See</b>
Clear-Exclusive	<i>CLREX</i> on page A8-360
Debug Hint	<i>DBG</i> on page A8-377
Data Memory Barrier	<i>DMB</i> on page A8-378
Data Synchronization Barrier	<i>DSB</i> on page A8-380
Instruction Synchronization Barrier	<i>ISB</i> on page A8-389
If-Then	<i>IT</i> on page A8-390
No Operation	<i>NOP</i> on page A8-510
Preload Data	<i>PLD, PLDW (immediate)</i> on page A8-524 <i>PLD (literal)</i> on page A8-526 <i>PLD, PLDW (register)</i> on page A8-528
Preload Instruction	<i>PLI (immediate, literal)</i> on page A8-530 <i>PLI (register)</i> on page A8-532
Set Endianness	<i>SETEND</i> on page A8-604
Send Event	<i>SEV</i> on page A8-606
Swap, Swap Byte. Deprecated. <sup>a</sup>	<i>SWP, SWPB</i> on page A8-722
Wait For Event	<i>WFE</i> on page A8-1104
Wait For Interrupt	<i>WFI</i> on page A8-1106
Yield	<i>YIELD</i> on page A8-1108

a. Use Load/Store-Exclusive instructions instead, see *Load/store instructions* on page A4-175.

### A4.8.1 The Yield instruction

In a *Symmetric Multi-Threading* (SMT) design, a thread can use the YIELD instruction to give a hint to the processor that it is running on. The YIELD hint indicates that whatever the thread is currently doing is of low importance, and so could yield. For example, the thread might be sitting in a spin-lock. A similar use might be in modifying the arbitration priority of the snoop bus in a multiprocessor (MP) system. Defining such an instruction permits binary compatibility between SMT and SMP systems.

ARMv7 defines a YIELD instruction as a specific NOP (No Operation) hint instruction.

The YIELD instruction has no effect in a single-threaded system, but developers of such systems can use the instruction to flag its intended use on migration to a multiprocessor or multithreading system. Operating systems can use YIELD in places where a yield hint is wanted, knowing that it will be treated as a NOP if there is no implementation benefit.

## A4.9 Exception-generating and exception-handling instructions

The following instructions are intended specifically to cause a synchronous processor exception to occur:

- The SVC instruction generates a Supervisor Call exception. For more information, see [Supervisor Call \(SVC\) exception on page B1-1209](#).
- The Breakpoint instruction BKPT provides software breakpoints. For more information, see [About debug events on page C3-2036](#).
- In a processor that implements the Security Extensions, when executing at PL1 or higher, the SMC instruction generates a Secure Monitor Call exception. For more information, see [Secure Monitor Call \(SMC\) exception on page B1-1210](#).
- In a processor that implements the Virtualization Extensions, in software executing in a Non-secure PL1 mode, the HVC instruction generates a Hypervisor Call exception. For more information, see [Hypervisor Call \(HVC\) exception on page B1-1211](#).

For an exception taken to a PL1 mode:

- The system level variants of the SUBS and LDM instructions perform a return from an exception.

———— **Note** —————

The variants of SUBS include MOV<sub>S</sub>. See the references to SUBS PC, LR in [Table A4-15](#) for more information.

- From ARMv6, the SRS instruction can be used near the start of the handler, to store return information. The RFE instruction can then perform a return from the exception using the stored return information.

In a processor that implements the Virtualization Extensions, the ERET instruction performs a return from an exception taken to Hyp mode.

For more information, see [Exception return on page B1-1193](#).

[Table A4-15](#) summarizes the instructions, in the ARM and Thumb instruction sets, for generating or handling an exception. Except for BKPT and SVC, these are system level instructions.

**Table A4-15 Exception-generating and exception-handling instructions**

Instruction	See
Supervisor Call	<a href="#">SVC (previously SWI) on page A8-720</a>
Breakpoint	<a href="#">BKPT on page A8-346</a>
Secure Monitor Call	<a href="#">SMC (previously SMI) on page B9-2000</a>
Return From Exception	<a href="#">RFE on page B9-1998</a>
Subtract (exception return)	<a href="#">SUBS PC, LR (Thumb) on page B9-2008</a> <a href="#">SUBS PC, LR and related instructions (ARM) on page B9-2010</a>
Hypervisor Call	<a href="#">HVC on page B9-1982</a>
Exception Return	<a href="#">ERET on page B9-1980</a>
Load Multiple (exception return)	<a href="#">LDM (exception return) on page B9-1984</a>
Store Return State	<a href="#">SRS (Thumb) on page B9-2002</a> <a href="#">SRS (ARM) on page B9-2004</a>

## A4.10 Coprocessor instructions

There are three types of instruction for communicating with coprocessors. These permit the processor to:

- Initiate a coprocessor data-processing operation. For details see [CDP, CDP2 on page A8-358](#).
- Transfer ARM core registers to and from coprocessor registers. For details, see:
  - [MCR, MCR2 on page A8-476](#)
  - [MCRR, MCRR2 on page A8-478](#)
  - [MRC, MRC2 on page A8-492](#)
  - [MRRC, MRRC2 on page A8-494](#).
- Load or store the values of coprocessor registers. For details, see:
  - [LDC, LDC2 \(immediate\) on page A8-392](#)
  - [LDC, LDC2 \(literal\) on page A8-394](#)
  - [STC, STC2 on page A8-662](#).

The instruction set distinguishes up to 16 coprocessors with a 4-bit field in each coprocessor instruction, so each coprocessor is assigned a particular number.

———— **Note** —————

One coprocessor can use more than one of the 16 numbers if a large coprocessor instruction set is required.

Coprocessors 10 and 11 are used, together, for Floating-point Extension and some Advanced SIMD Extension functionality. There are different instructions for accessing these coprocessors, of similar types to the instructions for the other coprocessors, that is, to:

- Initiate a coprocessor data-processing operation. For details see [Floating-point data-processing instructions on page A4-191](#).
- Transfer ARM core registers to and from coprocessor registers. For details, see [Advanced SIMD and Floating-point register transfer instructions on page A4-183](#).
- Load or store the values of coprocessor registers. For details, see [Advanced SIMD and Floating-point load/store instructions on page A4-181](#).

Coprocessors execute the same instruction stream as the processor, ignoring non-coprocessor instructions and coprocessor instructions for other coprocessors. Coprocessor instructions that cannot be executed by any coprocessor hardware cause an Undefined Instruction exception.

Coprocessors 8, 9, 12, and 13 are reserved for future use by ARM. Any coprocessor access instruction attempting to access one of these coprocessors is UNDEFINED.

For more information about specific coprocessors see [Coprocessor support on page A2-94](#).



## A4.11 Advanced SIMD and Floating-point load/store instructions

Table A4-16 summarizes the extension register load/store instructions in the Advanced SIMD and Floating-point (VFP) instruction sets.

Advanced SIMD also provides instructions for loading and storing multiple elements, or structures of elements, see *Element and structure load/store instructions*.

**Table A4-16 Extension register load/store instructions**

Instruction	See	Operation
Vector Load Multiple	<a href="#">VLDM on page A8-922</a>	Load 1-16 consecutive 64-bit registers, Advanced SIMD and Floating-point Load 1-16 consecutive 32-bit registers, Floating-point only
Vector Load Register	<a href="#">VLDR on page A8-924</a>	Load one 64-bit register, Advanced SIMD and Floating-point Load one 32-bit register, Floating-point only
Vector Store Multiple	<a href="#">VSTM on page A8-1080</a>	Store 1-16 consecutive 64-bit registers, Advanced SIMD and Floating-point Store 1-16 consecutive 32-bit registers, Floating-point only
Vector Store Register	<a href="#">VSTR on page A8-1082</a>	Store one 64-bit register, Advanced SIMD and Floating-point Store one 32-bit register, Floating-point only

### A4.11.1 Element and structure load/store instructions

Table A4-17 shows the element and structure load/store instructions available in the Advanced SIMD instruction set. Loading and storing structures of more than one element automatically de-interleaves or interleaves the elements, see [Figure A4-1 on page A4-182](#) for an example of de-interleaving. Interleaving is the inverse process.

**Table A4-17 Element and structure load/store instructions**

Instruction	See
Load single element	
Multiple elements	<a href="#">VLD1 (multiple single elements) on page A8-898</a>
To one lane	<a href="#">VLD1 (single element to one lane) on page A8-900</a>
To all lanes	<a href="#">VLD1 (single element to all lanes) on page A8-902</a>
Load 2-element structure	
Multiple structures	<a href="#">VLD2 (multiple 2-element structures) on page A8-904</a>
To one lane	<a href="#">VLD2 (single 2-element structure to one lane) on page A8-906</a>
To all lanes	<a href="#">VLD2 (single 2-element structure to all lanes) on page A8-908</a>
Load 3-element structure	
Multiple structures	<a href="#">VLD3 (multiple 3-element structures) on page A8-910</a>
To one lane	<a href="#">VLD3 (single 3-element structure to one lane) on page A8-912</a>
To all lanes	<a href="#">VLD3 (single 3-element structure to all lanes) on page A8-914</a>

**Table A4-17 Element and structure load/store instructions (continued)**

Instruction	See
Load 4-element structure	
Multiple structures	<i>VLD4 (multiple 4-element structures)</i> on page A8-916
To one lane	<i>VLD4 (single 4-element structure to one lane)</i> on page A8-918
To all lanes	<i>VLD4 (single 4-element structure to all lanes)</i> on page A8-920
Store single element	
Multiple elements	<i>VST1 (multiple single elements)</i> on page A8-1064
From one lane	<i>VST1 (single element from one lane)</i> on page A8-1066
Store 2-element structure	
Multiple structures	<i>VST2 (multiple 2-element structures)</i> on page A8-1068
From one lane	<i>VST2 (single 2-element structure from one lane)</i> on page A8-1070
Store 3-element structure	
Multiple structures	<i>VST3 (multiple 3-element structures)</i> on page A8-1072
From one lane	<i>VST3 (single 3-element structure from one lane)</i> on page A8-1074
Store 4-element structure	
Multiple structures	<i>VST4 (multiple 4-element structures)</i> on page A8-1076
From one lane	<i>VST4 (single 4-element structure from one lane)</i> on page A8-1078

Figure A4-1 shows the de-interleaving of a VLD3.16 (multiple 3-element structures) instruction:

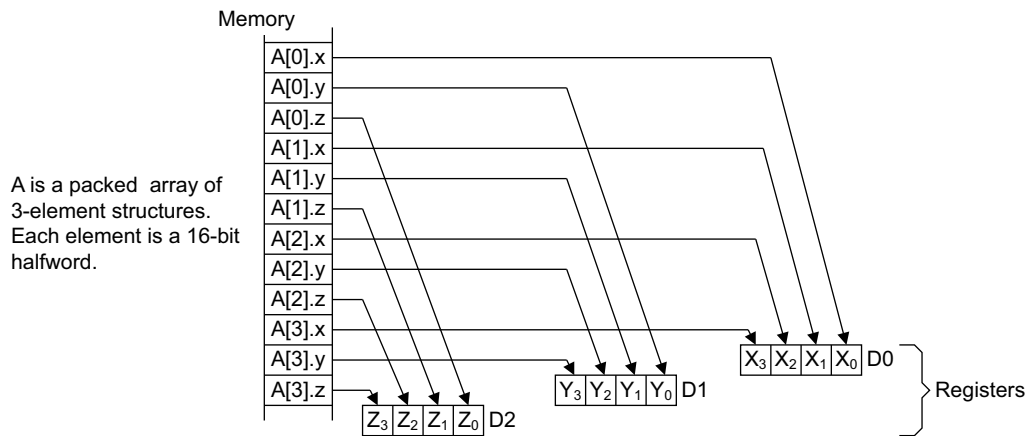

**Figure A4-1 De-interleaving an array of 3-element structures**

Figure A4-1 shows the VLD3.16 instruction operating to three 64-bit registers that comprise four 16-bit elements:

- Different instructions in this group would produce similar figures, but operate on different numbers of registers. For example, VLD4 and VST4 instructions operate on four registers.
- Different element sizes would produce similar figures but with 8-bit or 32-bit elements.
- These instructions operate only on doubleword (64-bit) registers.

## A4.12 Advanced SIMD and Floating-point register transfer instructions

Table A4-18 summarizes the extension register transfer instructions in the Advanced SIMD and Floating-point (VFP) instruction sets. These instructions transfer data from ARM core registers to extension registers, or from extension registers to ARM core registers.

Advanced SIMD vectors, and single-precision and double-precision Floating-point registers, are all views of the same extension register set. For details see *Advanced SIMD and Floating-point Extension registers* on page A2-56.

**Table A4-18 Extension register transfer instructions**

Instruction	See
Copy element from ARM core register to every element of Advanced SIMD vector	<i>VDUP (ARM core register)</i> on page A8-886
Copy byte, halfword, or word from ARM core register to extension register	<i>VMOV (ARM core register to scalar)</i> on page A8-940
Copy byte, halfword, or word from extension register to ARM core register	<i>VMOV (scalar to ARM core register)</i> on page A8-942
Copy from single-precision Floating-point register to ARM core register, or from ARM core register to single-precision Floating-point register	<i>VMOV (between ARM core register and single-precision register)</i> on page A8-944
Copy two words from ARM core registers to consecutive single-precision Floating-point registers, or from consecutive single-precision Floating-point registers to ARM core registers	<i>VMOV (between two ARM core registers and two single-precision registers)</i> on page A8-946
Copy two words from ARM core registers to doubleword extension register, or from doubleword extension register to ARM core registers	<i>VMOV (between two ARM core registers and a doubleword extension register)</i> on page A8-948
Copy from Advanced SIMD and Floating-point Extension System Register to ARM core register	<i>VMRS</i> on page A8-954 <i>VMRS</i> on page B9-2012 (system level view)
Copy from ARM core register to Advanced SIMD and Floating-point Extension System Register	<i>VMSR</i> on page A8-956 <i>VMSR</i> on page B9-2014 (system level view)

## A4.13 Advanced SIMD data-processing instructions

Advanced SIMD data-processing instructions process registers containing vectors of elements of the same type packed together, enabling the same operation to be performed on multiple items in parallel.

Instructions operate on vectors held in 64-bit or 128-bit registers. [Figure A4-2](#) shows an operation on two 64-bit operand vectors, generating a 64-bit vector result.

———— **Note** —————

[Figure A4-2](#) and other similar figures show 64-bit vectors that consist of four 16-bit elements, and 128-bit vectors that consist of four 32-bit elements. Other element sizes produce similar figures, but with one, two, eight, or sixteen operations performed in parallel instead of four.

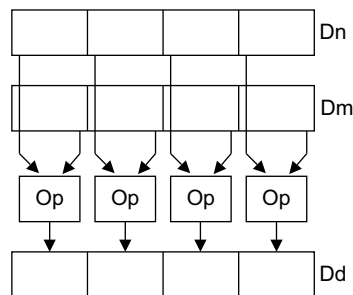

**Figure A4-2** Advanced SIMD instruction operating on 64-bit registers

Many Advanced SIMD instructions have variants that produce vectors of elements double the size of the inputs. In this case, the number of elements in the result vector is the same as the number of elements in the operand vectors, but each element, and the whole vector, is double the size.

[Figure A4-3](#) shows an example of an Advanced SIMD instruction operating on 64-bit registers, and generating a 128-bit result.

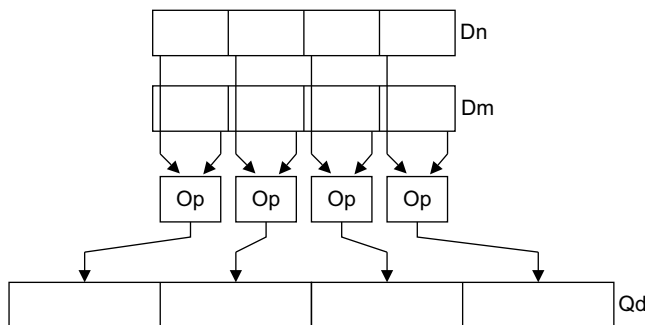

**Figure A4-3** Advanced SIMD instruction producing wider result

There are also Advanced SIMD instructions that have variants that produce vectors containing elements half the size of the inputs. [Figure A4-4 on page A4-185](#) shows an example of an Advanced SIMD instruction operating on one 128-bit register, and generating a 64-bit result.

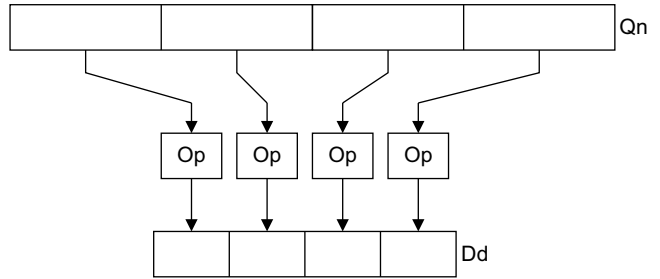

**Figure A4-4 Advanced SIMD instruction producing narrower result**

Some Advanced SIMD instructions do not conform to these standard patterns. Their operation patterns are described in the individual instruction descriptions.

Advanced SIMD instructions that perform floating-point arithmetic use the ARM standard floating-point arithmetic defined in *Floating-point data types and arithmetic* on page A2-63.

### A4.13.1 Advanced SIMD parallel addition and subtraction

Table A4-19 shows the Advanced SIMD parallel add and subtract instructions.

**Table A4-19 Advanced SIMD parallel add and subtract instructions**

Instruction	See
Vector Add	<a href="#">VADD (integer) on page A8-828</a> <a href="#">VADD (floating-point) on page A8-830</a>
Vector Add and Narrow, returning High Half	<a href="#">VADDHN on page A8-832</a>
Vector Add Long, Vector Add Wide	<a href="#">VADDL, VADDW on page A8-834</a>
Vector Halving Add, Vector Halving Subtract	<a href="#">VHADD, VHSUB on page A8-896</a>
Vector Pairwise Add and Accumulate Long	<a href="#">VPADAL on page A8-978</a>
Vector Pairwise Add	<a href="#">VPADD (integer) on page A8-980</a> <a href="#">VPADD (floating-point) on page A8-982</a>
Vector Pairwise Add Long	<a href="#">VPADDL on page A8-984</a>
Vector Rounding Add and Narrow, returning High Half	<a href="#">VRADDHN on page A8-1022</a>
Vector Rounding Halving Add	<a href="#">VRHADD on page A8-1030</a>
Vector Rounding Subtract and Narrow, returning High Half	<a href="#">VRSUBHN on page A8-1044</a>
Vector Saturating Add	<a href="#">VQADD on page A8-996</a>
Vector Saturating Subtract	<a href="#">VQSUB on page A8-1020</a>
Vector Subtract	<a href="#">VSUB (integer) on page A8-1084</a> <a href="#">VSUB (floating-point) on page A8-1086</a>
Vector Subtract and Narrow, returning High Half	<a href="#">VSUBHN on page A8-1088</a>
Vector Subtract Long, Vector Subtract Wide	<a href="#">VSUBL, VSUBW on page A8-1090</a>

### A4.13.2 Bitwise Advanced SIMD data-processing instructions

Table A4-20 shows bitwise Advanced SIMD data-processing instructions. These operate on the doubleword (64-bit) or quadword (128-bit) extension registers, and there is no division into vector elements.

**Table A4-20 Bitwise Advanced SIMD data-processing instructions**

Instruction	See
Vector Bitwise AND	<i>VAND (register)</i> on page A8-836
Vector Bitwise Bit Clear (AND complement)	<i>VBIC (immediate)</i> on page A8-838 <i>VBIC (register)</i> on page A8-840
Vector Bitwise Exclusive OR	<i>VEOR</i> on page A8-888
Vector Bitwise Insert if False	<i>VBIF, VBIT, VBSL</i> on page A8-842
Vector Bitwise Insert if True	
Vector Bitwise Move	<i>VMOV (immediate)</i> on page A8-936 <i>VMOV (register)</i> on page A8-938
Vector Bitwise NOT	<i>VMVN (immediate)</i> on page A8-964 <i>VMVN (register)</i> on page A8-966
Vector Bitwise OR	<i>VORR (immediate)</i> on page A8-974 <i>VORR (register)</i> on page A8-976
Vector Bitwise OR NOT	<i>VORN (register)</i> on page A8-972
Vector Bitwise Select	<i>VBIF, VBIT, VBSL</i> on page A8-842

### A4.13.3 Advanced SIMD comparison instructions

Table A4-21 shows Advanced SIMD comparison instructions.

**Table A4-21 Advanced SIMD comparison instructions**

Instruction	See
Vector Absolute Compare	<i>VACGE, VACGT, VACLE, VACL</i> T on page A8-826
Vector Compare Equal	<i>VCEQ (register)</i> on page A8-844
Vector Compare Equal to Zero	<i>VCEQ (immediate #0)</i> on page A8-846
Vector Compare Greater Than or Equal	<i>VCGE (register)</i> on page A8-848
Vector Compare Greater Than or Equal to Zero	<i>VCGE (immediate #0)</i> on page A8-850
Vector Compare Greater Than	<i>VCGT (register)</i> on page A8-852
Vector Compare Greater Than Zero	<i>VCGT (immediate #0)</i> on page A8-854
Vector Compare Less Than or Equal to Zero	<i>VCLE (immediate #0)</i> on page A8-856
Vector Compare Less Than Zero	<i>VCLT (immediate #0)</i> on page A8-860
Vector Test Bits	<i>VTST</i> on page A8-1098

### A4.13.4 Advanced SIMD shift instructions

Table A4-22 lists the shift instructions in the Advanced SIMD instruction set.

**Table A4-22 Advanced SIMD shift instructions**

<b>Instruction</b>	<b>See</b>
Vector Saturating Rounding Shift Left	<i>VQRSHL</i> on page A8-1010
Vector Saturating Rounding Shift Right and Narrow	<i>VQRSHRN</i> , <i>VQRSHRUN</i> on page A8-1012
Vector Saturating Shift Left	<i>VQSHL (register)</i> on page A8-1014 <i>VQSHL</i> , <i>VQSHLU (immediate)</i> on page A8-1016
Vector Saturating Shift Right and Narrow	<i>VQSHRN</i> , <i>VQSHRUN</i> on page A8-1018
Vector Rounding Shift Left	<i>VRSHL</i> on page A8-1032
Vector Rounding Shift Right	<i>VRSHR</i> on page A8-1034
Vector Rounding Shift Right and Accumulate	<i>VRSRA</i> on page A8-1042
Vector Rounding Shift Right and Narrow	<i>VRSHRN</i> on page A8-1036
Vector Shift Left	<i>VSHL (immediate)</i> on page A8-1046 <i>VSHL (register)</i> on page A8-1048
Vector Shift Left Long	<i>VSHLL</i> on page A8-1050
Vector Shift Right	<i>VSHR</i> on page A8-1052
Vector Shift Right and Narrow	<i>VSHRN</i> on page A8-1054
Vector Shift Left and Insert	<i>VSLI</i> on page A8-1056
Vector Shift Right and Accumulate	<i>VSRA</i> on page A8-1060
Vector Shift Right and Insert	<i>VSRI</i> on page A8-1062

### A4.13.5 Advanced SIMD multiply instructions

Table A4-23 summarizes the Advanced SIMD multiply instructions.

**Table A4-23 Advanced SIMD multiply instructions**

Instruction	See
Vector Multiply Accumulate	
Vector Multiply Accumulate Long	<i>VMLA, VMLAL, VMLS, VMLSL (integer)</i> on page A8-930
Vector Multiply Subtract	<i>VMLA, VMLS (floating-point)</i> on page A8-932
Vector Multiply Subtract Long	<i>VMLA, VMLAL, VMLS, VMLSL (by scalar)</i> on page A8-934
Vector Multiply	<i>VMUL, VMULL (integer and polynomial)</i> on page A8-958
Vector Multiply Long	<i>VMUL (floating-point)</i> on page A8-960 <i>VMUL, VMULL (by scalar)</i> on page A8-962
Vector Fused Multiply Accumulate	<i>VFMA, VFMS</i> on page A8-892
Vector Fused Multiply Subtract	
Vector Saturating Doubling Multiply Accumulate Long	<i>VQDMLAL, VQDMLSL</i> on page A8-998
Vector Saturating Doubling Multiply Subtract Long	
Vector Saturating Doubling Multiply Returning High Half	<i>VQDMULH</i> on page A8-1000
Vector Saturating Rounding Doubling Multiply Returning High Half	<i>VQRDMULH</i> on page A8-1008
Vector Saturating Doubling Multiply Long	<i>VQDMULL</i> on page A8-1002

Advanced SIMD multiply instructions can operate on vectors of:

- 8-bit, 16-bit, or 32-bit unsigned integers.
- 8-bit, 16-bit, or 32-bit signed integers.
- 8-bit polynomials over {0, 1}. *VMUL* and *VMULL* are the only instructions that operate on polynomials. *VMULL* produces a 16-bit polynomial over {0, 1}.
- Single-precision (32-bit) floating-point numbers.

They can also act on one vector and one scalar.

Long instructions have doubleword (64-bit) operands, and produce quadword (128-bit) results. Other Advanced SIMD multiply instructions can have either doubleword or quadword operands, and produce results of the same size.

Floating-point multiply instructions can operate on:

- single-precision (32-bit) floating-point numbers
- double-precision (64-bit) floating-point numbers.

Some Floating-point Extension implementations do not support double-precision numbers.



## A4.13.6 Miscellaneous Advanced SIMD data-processing instructions

Table A4-24 shows miscellaneous Advanced SIMD data-processing instructions.

**Table A4-24 Miscellaneous Advanced SIMD data-processing instructions**

<b>Instruction</b>	<b>See</b>
Vector Absolute Difference and Accumulate	<i>VABA, VABAL</i> on page A8-818
Vector Absolute Difference	<i>VABD, VABDL (integer)</i> on page A8-820 <i>VABD (floating-point)</i> on page A8-822
Vector Absolute	<i>VABS</i> on page A8-824
Vector Convert between floating-point and fixed point	<i>VCVT (between floating-point and fixed-point, Advanced SIMD)</i> on page A8-872
Vector Convert between floating-point and integer	<i>VCVT (between floating-point and integer, Advanced SIMD)</i> on page A8-868
Vector Convert between half-precision and single-precision	<i>VCVT (between half-precision and single-precision, Advanced SIMD)</i> on page A8-878
Vector Count Leading Sign Bits	<i>VCLS</i> on page A8-858
Vector Count Leading Zeros	<i>VCLZ</i> on page A8-862
Vector Count Set Bits	<i>VCNT</i> on page A8-866
Vector Duplicate scalar	<i>VDUP (scalar)</i> on page A8-884
Vector Extract	<i>VEXT</i> on page A8-890
Vector Move and Narrow	<i>VMOVN</i> on page A8-952
Vector Move Long	<i>VMOVL</i> on page A8-950
Vector Maximum, Minimum	<i>VMAX, VMIN (integer)</i> on page A8-926 <i>VMAX, VMIN (floating-point)</i> on page A8-928
Vector Negate	<i>VNEG</i> on page A8-968
Vector Pairwise Maximum, Minimum	<i>VPMAX, VPMIN (integer)</i> on page A8-986 <i>VPMAX, VPMIN (floating-point)</i> on page A8-988
Vector Reciprocal Estimate	<i>VRECPE</i> on page A8-1024
Vector Reciprocal Step	<i>VRECPS</i> on page A8-1026
Vector Reciprocal Square Root Estimate	<i>VRSQRTE</i> on page A8-1038
Vector Reciprocal Square Root Step	<i>VRSQRTS</i> on page A8-1040
Vector Reverse	<i>VREV16, VREV32, VREV64</i> on page A8-1028
Vector Saturating Absolute	<i>VQABS</i> on page A8-994
Vector Saturating Move and Narrow	<i>VQMOVN, VQMOVUN</i> on page A8-1004
Vector Saturating Negate	<i>VQNEG</i> on page A8-1006
Vector Swap	<i>VSWP</i> on page A8-1092
Vector Table Lookup	<i>VTBL, VTBX</i> on page A8-1094

**Table A4-24 Miscellaneous Advanced SIMD data-processing instructions (continued)**

<b>Instruction</b>	<b>See</b>
Vector Transpose	<a href="#">VTRN on page A8-1096</a>
Vector Unzip	<a href="#">VUZP on page A8-1100</a>
Vector Zip	<a href="#">VZIP on page A8-1102</a>

## A4.14 Floating-point data-processing instructions

Table A4-25 summarizes the data-processing instructions in the Floating-point (VFP) instruction set.

For details of the floating-point arithmetic used by Floating-point instructions, see *Floating-point data types and arithmetic* on page A2-63.

**Table A4-25 Floating-point data-processing instructions**

<b>Instruction</b>	<b>See</b>
Absolute value	<i>VABS</i> on page A8-824
Add	<i>VADD (floating-point)</i> on page A8-830
Compare, optionally with exceptions enabled	<i>VCMP, VCMPE</i> on page A8-864
Convert between floating-point and integer	<i>VCVT, VCVTR (between floating-point and integer; Floating-point)</i> on page A8-870
Convert between floating-point and fixed-point	<i>VCVT (between floating-point and fixed-point, Floating-point)</i> on page A8-874
Convert between double-precision and single-precision	<i>VCVT (between double-precision and single-precision)</i> on page A8-876
Convert between half-precision and single-precision	<i>VCVTB, VCVTT</i> on page A8-880
Divide	<i>VDIV</i> on page A8-882
Multiply Accumulate	<i>VMLA, VMLS (floating-point)</i> on page A8-932
Multiply Subtract	
Fused Multiply Accumulate	<i>VFMA, VFMS</i> on page A8-892
Fused Multiply Subtract	
Move immediate value to extension register	<i>VMOV (immediate)</i> on page A8-936
Copy from one extension register to another	<i>VMOV (register)</i> on page A8-938
Multiply	<i>VMUL (floating-point)</i> on page A8-960
Negate, by inverting the sign bit	<i>VNEG</i> on page A8-968
Multiply Accumulate and Negate	<i>VNMLA, VNMLS, VNMUL</i> on page A8-970
Multiply Subtract and Negate	
Multiply and Negate	
Fused Negate Multiply Accumulate	<i>VFNMA, VFNMS</i> on page A8-894
Fused Negate Multiply Subtract	
Square Root	<i>VSQRT</i> on page A8-1058
Subtract	<i>VSUB (floating-point)</i> on page A8-1086



# Chapter A5

## ARM Instruction Set Encoding

This chapter describes the encoding of the ARM instruction set. It contains the following sections:

- *ARM instruction set encoding* on page A5-194
- *Data-processing and miscellaneous instructions* on page A5-196
- *Load/store word and unsigned byte* on page A5-208
- *Media instructions* on page A5-209
- *Branch, branch with link, and block data transfer* on page A5-214
- *Coprocessor instructions, and Supervisor Call* on page A5-215
- *Unconditional instructions* on page A5-216.

---

### Note

---

- Architecture variant information in this chapter describes the architecture variant or extension in which the instruction encoding was introduced into the ARM instruction set. *All* means that the instruction encoding was introduced in ARMv4 or earlier, and so is in all variants of the ARM instruction set covered by this manual.
  - In the decode tables in this chapter, an entry of - for a field value means the value of the field does not affect the decoding.
-

## A5.1 ARM instruction set encoding

The ARM instruction stream is a sequence of word-aligned words. Each ARM instruction is a single 32-bit word in that stream. The encoding of an ARM instruction is:

31	30	29	28	27	26	25	24	23	22	21	20	19	18	17	16	15	14	13	12	11	10	9	8	7	6	5	4	3	2	1	0
cond				op1																			op								

Table A5-1 shows the major subdivisions of the ARM instruction set, determined by bits[31:25, 4].

Most ARM instructions can be conditional, with a condition determined by bits[31:28] of the instruction, the cond field. For more information see *The condition code field*. This applies to all instructions except those with the cond field equal to 0b1111.

**Table A5-1 ARM instruction encoding**

cond	op1	op	Instruction classes
not 1111	00x	-	<i>Data-processing and miscellaneous instructions on page A5-196.</i>
	010	-	<i>Load/store word and unsigned byte on page A5-208.</i>
	011	0	<i>Load/store word and unsigned byte on page A5-208.</i>
		1	<i>Media instructions on page A5-209.</i>
	10x	-	<i>Branch, branch with link, and block data transfer on page A5-214.</i>
	11x	-	<i>Coprocessor instructions, and Supervisor Call on page A5-215.</i> Includes Floating-point instructions and Advanced SIMD data transfers, see <i>Chapter A7 Advanced SIMD and Floating-point Instruction Encoding</i> .
1111	-	-	If the cond field is 0b1111, the instruction can only be executed unconditionally, see <i>Unconditional instructions on page A5-216</i> . Includes Advanced SIMD instructions, see <i>Chapter A7 Advanced SIMD and Floating-point Instruction Encoding</i> .

### A5.1.1 The condition code field

Every conditional instruction contains a 4-bit condition code field, the cond field, in bits 31 to 28:

31	30	29	28	27	26	25	24	23	22	21	20	19	18	17	16	15	14	13	12	11	10	9	8	7	6	5	4	3	2	1	0
cond																															

This field contains one of the values 0b0000-0b1110, as shown in *Table A8-1 on page A8-288*. Most instruction mnemonics can be extended with the letters defined in the *mnemonic extension* column of this table.

If the *always* (AL) condition is specified, the instruction is executed irrespective of the value of the condition flags. The absence of a condition code on an instruction mnemonic implies the AL condition code.

## A5.1.2 UNDEFINED and UNPREDICTABLE instruction set space

An attempt to execute an unallocated instruction results in either:

- Unpredictable behavior. The instruction is described as UNPREDICTABLE.
- An Undefined Instruction exception. The instruction is described as UNDEFINED.

An instruction is UNDEFINED if it is declared as UNDEFINED in an instruction description, or in this chapter.

An instruction is UNPREDICTABLE if:

- it is declared as UNPREDICTABLE in an instruction description or in this chapter
- the pseudocode for that encoding does not indicate that a different special case applies, and a bit marked (0) or (1) in the encoding diagram of an instruction is not 0 or 1 respectively.

For more information about UNDEFINED and UNPREDICTABLE instruction behavior, see [Undefined Instruction exception on page B1-1205](#).

Unless otherwise specified:

- ARM instructions introduced in an architecture variant are UNDEFINED in earlier architecture variants.
- ARM instructions introduced in one or more architecture extensions are UNDEFINED in an implementation that does not include any of those extensions.

## A5.1.3 The PC and the use of 0b1111 as a register specifier

In ARM instructions, the use of 0b1111 as a register specifier specifies the PC.

Many instructions are UNPREDICTABLE if they use 0b1111 as a register specifier. This is specified by pseudocode in the instruction description.

———— **Note** —————

In ARMv7, ARM deprecates use of the PC as the base register in any store instruction.

## A5.1.4 The SP and the use of 0b1101 as a register specifier

In ARM instructions, the use of 0b1101 as a register specifier specifies the SP.

ARM deprecates using SP for any purpose other than as a stack pointer.

## A5.2 Data-processing and miscellaneous instructions

The encoding of ARM data-processing instructions, and some miscellaneous, instructions is:

31	30	29	28	27	26	25	24	23	22	21	20	19	18	17	16	15	14	13	12	11	10	9	8	7	6	5	4	3	2	1	0
cond				0	0	op		op1										op2													

Table A5-2 shows the allocation of encodings in this space.

**Table A5-2 Data-processing and miscellaneous instructions**

op	op1	op2	Instruction or instruction class	Variant
0	not 10xx0	xxx0	<i>Data-processing (register) on page A5-197</i>	-
		0xx1	<i>Data-processing (register-shifted register) on page A5-198</i>	-
	10xx0	0xxx	<i>Miscellaneous instructions on page A5-207</i>	-
		1xx0	<i>Halfword multiply and multiply accumulate on page A5-203</i>	-
	0xxxx	1001	<i>Multiply and multiply accumulate on page A5-202</i>	-
	1xxxx	1001	<i>Synchronization primitives on page A5-205</i>	-
	not 0xx1x	1011	<i>Extra load/store instructions on page A5-203</i>	-
		11x1	<i>Extra load/store instructions on page A5-203</i>	-
	0xx1x	1011	<i>Extra load/store instructions, unprivileged on page A5-204</i>	-
		11x1	<i>Extra load/store instructions on page A5-203</i>	-
1	not 10xx0	-	<i>Data-processing (immediate) on page A5-199</i>	-
	10000	-	16-bit immediate load, <i>MOV (immediate) on page A8-484</i>	v6T2
	10100	-	High halfword 16-bit immediate load, <i>MOVT on page A8-491</i>	v6T2
	10x10	-	<i>MSR (immediate), and hints on page A5-206</i>	-



## A5.2.1 Data-processing (register)

The encoding of ARM data-processing (register) instructions is:

31	30	29	28	27	26	25	24	23	22	21	20	19	18	17	16	15	14	13	12	11	10	9	8	7	6	5	4	3	2	1	0
cond				0	0	0	op									imm5			op2		0										

Table A5-3 shows the allocation of encodings in this space. These encodings are in all architecture variants.

**Table A5-3 Data-processing (register) instructions**

op	op2	imm5	Instruction	See
0000x	-	-	Bitwise AND	<i>AND (register)</i> on page A8-326
0001x	-	-	Bitwise Exclusive OR	<i>EOR (register)</i> on page A8-384
0010x	-	-	Subtract	<i>SUB (register)</i> on page A8-712
0011x	-	-	Reverse Subtract	<i>RSB (register)</i> on page A8-576
0100x	-	-	Add	<i>ADD (register, ARM)</i> on page A8-312
0101x	-	-	Add with Carry	<i>ADC (register)</i> on page A8-302
0110x	-	-	Subtract with Carry	<i>SBC (register)</i> on page A8-594
0111x	-	-	Reverse Subtract with Carry	<i>RSC (register)</i> on page A8-582
10xx0	-	-	See <i>Data-processing and miscellaneous instructions</i> on page A5-196	
10001	-	-	Test	<i>TST (register)</i> on page A8-746
10011	-	-	Test Equivalence	<i>TEQ (register)</i> on page A8-740
10101	-	-	Compare	<i>CMP (register)</i> on page A8-372
10111	-	-	Compare Negative	<i>CMN (register)</i> on page A8-366
1100x	-	-	Bitwise OR	<i>ORR (register)</i> on page A8-518
1101x	00	00000	Move	<i>MOV (register, ARM)</i> on page A8-488
		not 00000	Logical Shift Left	<i>LSL (immediate)</i> on page A8-468
	01	-	Logical Shift Right	<i>LSR (immediate)</i> on page A8-472
	10	-	Arithmetic Shift Right	<i>ASR (immediate)</i> on page A8-330
	11	00000	Rotate Right with Extend	<i>RRX</i> on page A8-572
		not 00000	Rotate Right	<i>ROR (immediate)</i> on page A8-568
1110x	-	-	Bitwise Bit Clear	<i>BIC (register)</i> on page A8-342
1111x	-	-	Bitwise NOT	<i>MVN (register)</i> on page A8-506

## A5.2.2 Data-processing (register-shifted register)

The encoding of ARM data-processing (register-shifted register) instructions is:

31	30	29	28	27	26	25	24	23	22	21	20	19	18	17	16	15	14	13	12	11	10	9	8	7	6	5	4	3	2	1	0
cond				0	0	0	op1										0	op2		1											

Table A5-4 shows the allocation of encodings in this space. These encodings are in all architecture variants.

**Table A5-4 Data-processing (register-shifted register) instructions**

op1	op2	Instruction	See
0000x	-	Bitwise AND	<i>AND (register-shifted register)</i> on page A8-328
0001x	-	Bitwise Exclusive OR	<i>EOR (register-shifted register)</i> on page A8-386
0010x	-	Subtract	<i>SUB (register-shifted register)</i> on page A8-714
0011x	-	Reverse Subtract	<i>RSB (register-shifted register)</i> on page A8-578
0100x	-	Add	<i>ADD (register-shifted register)</i> on page A8-314
0101x	-	Add with Carry	<i>ADC (register-shifted register)</i> on page A8-304
0110x	-	Subtract with Carry	<i>SBC (register-shifted register)</i> on page A8-596
0111x	-	Reverse Subtract with Carry	<i>RSC (register-shifted register)</i> on page A8-584
10xx0	-	See <i>Data-processing and miscellaneous instructions</i> on page A5-196	
10001	-	Test	<i>TST (register-shifted register)</i> on page A8-748
10011	-	Test Equivalence	<i>TEQ (register-shifted register)</i> on page A8-742
10101	-	Compare	<i>CMP (register-shifted register)</i> on page A8-374
10111	-	Compare Negative	<i>CMN (register-shifted register)</i> on page A8-368
1100x	-	Bitwise OR	<i>ORR (register-shifted register)</i> on page A8-520
1101x	00	Logical Shift Left	<i>LSL (register)</i> on page A8-470
	01	Logical Shift Right	<i>LSR (register)</i> on page A8-474
	10	Arithmetic Shift Right	<i>ASR (register)</i> on page A8-332
	11	Rotate Right	<i>ROR (register)</i> on page A8-570
1110x	-	Bitwise Bit Clear	<i>BIC (register-shifted register)</i> on page A8-344
1111x	-	Bitwise NOT	<i>MVN (register-shifted register)</i> on page A8-508

### A5.2.3 Data-processing (immediate)

The encoding of ARM data-processing (immediate) instructions is:

31	30	29	28	27	26	25	24	23	22	21	20	19	18	17	16	15	14	13	12	11	10	9	8	7	6	5	4	3	2	1	0
cond				0	0	1	op				Rn																				

Table A5-5 shows the allocation of encodings in this space. These encodings are in all architecture variants.

**Table A5-5 Data-processing (immediate) instructions**

op	Rn	Instruction	See
0000x	-	Bitwise AND	<i>AND (immediate)</i> on page A8-324
0001x	-	Bitwise Exclusive OR	<i>EOR (immediate)</i> on page A8-382
0010x	not 1111	Subtract	<i>SUB (immediate, ARM)</i> on page A8-710
	1111	Form PC-relative address	<i>ADR</i> on page A8-322
0011x	-	Reverse Subtract	<i>RSB (immediate)</i> on page A8-574
0100x	not 1111	Add	<i>ADD (immediate, ARM)</i> on page A8-308
	1111	Form PC-relative address	<i>ADR</i> on page A8-322
0101x	-	Add with Carry	<i>ADC (immediate)</i> on page A8-300
0110x	-	Subtract with Carry	<i>SBC (immediate)</i> on page A8-592
0111x	-	Reverse Subtract with Carry	<i>RSC (immediate)</i> on page A8-580
10xx0	-	See <i>Data-processing and miscellaneous instructions</i> on page A5-196	
10001	-	Test	<i>TST (immediate)</i> on page A8-744
10011	-	Test Equivalence	<i>TEQ (immediate)</i> on page A8-738
10101	-	Compare	<i>CMP (immediate)</i> on page A8-370
10111	-	Compare Negative	<i>CMN (immediate)</i> on page A8-364
1100x	-	Bitwise OR	<i>ORR (immediate)</i> on page A8-516
1101x	-	Move	<i>MOV (immediate)</i> on page A8-484
1110x	-	Bitwise Bit Clear	<i>BIC (immediate)</i> on page A8-340
1111x	-	Bitwise NOT	<i>MVN (immediate)</i> on page A8-504

These instructions all have modified immediate constants, rather than a simple 12-bit binary number. This provides a more useful range of values. For details see *Modified immediate constants in ARM instructions* on page A5-200.

### A5.2.4 Modified immediate constants in ARM instructions

The encoding of a modified immediate constant in an ARM instruction is:

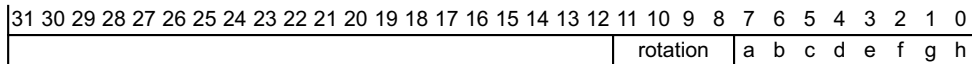

Table A5-6 shows the range of modified immediate constants available in ARM data-processing instructions, and their encoding in the a, b, c, d, e, f, g, and h bits and the rotation field in the instruction.

**Table A5-6 Encoding of modified immediates in ARM processing instructions**

rotation	<const> <sup>a</sup>
0000	00000000 00000000 00000000 abcdefgh
0001	gh000000 00000000 00000000 00abcdef
0010	efgh0000 00000000 00000000 000abcd
0011	cdefgh00 00000000 00000000 00000ab
0100	abcdefgh 00000000 00000000 00000000
.	.
.	. 8-bit values shifted to other even-numbered positions
.	.
1001	00000000 00abcdef gh000000 00000000
.	.
.	. 8-bit values shifted to other even-numbered positions
.	.
1110	00000000 00000000 000abcd efgh0000
1111	00000000 00000000 00000ab cdefgh00

a. This table shows the immediate constant value in binary form, to relate abcdefgh to the encoding diagram. In assembly syntax, the immediate value is specified in the usual way (a decimal number by default).

**Note**

The range of values available in ARM modified immediate constants is slightly different from the range of values available in 32-bit Thumb instructions. See *Modified immediate constants in Thumb instructions* on page A6-232.

#### Carry out

A logical instruction with the rotation field set to 0b0000 does not affect APSR.C. Otherwise, a logical flag-setting instruction sets APSR.C to the value of bit[31] of the modified immediate constant.

#### Constants with multiple encodings

Some constant values have multiple possible encodings. In this case, a UAL assembler must select the encoding with the lowest unsigned value of the rotation field. This is the encoding that appears first in Table A5-6. For example, the constant #3 must be encoded with (rotation, abcdefgh) == (0b0000, 0b00000011), not (0b0001, 0b00001100), (0b0010, 0b00110000), or (0b0011, 0b11000000).

In particular, this means that all constants in the range 0-255 are encoded with rotation == 0b0000, and permitted constants outside that range are encoded with rotation != 0b0000. A flag-setting logical instruction with a modified immediate constant therefore leaves APSR.C unchanged if the constant is in the range 0-255 and sets it to the most significant bit of the constant otherwise. This matches the behavior of Thumb modified immediate constants for all constants that are permitted in both the ARM and Thumb instruction sets.

An alternative syntax is available for a modified immediate constant that permits the programmer to specify the encoding directly. In this syntax, #<const> is instead written as #<byte>, #<rot>, where:

<byte> is the numeric value of abcdefgh, in the range 0-255

<rot> is twice the numeric value of rotation, an even number in the range 0-30.

This syntax permits all ARM data-processing instructions with modified immediate constants to be disassembled to assembler syntax that assembles to the original instruction.

This syntax also makes it possible to write variants of some flag-setting logical instructions that have different effects on APSR.C to those obtained with the normal #<const> syntax. For example, ANDS R1, R2, #12, #2 has the same behavior as ANDS R1, R2, #3 except that it sets APSR.C to 0 instead of leaving it unchanged. Such variants of flag-setting logical instructions do not have equivalents in the Thumb instruction set, and ARM deprecates their use.

### Operation of modified immediate constants, ARM instructions

```
// ARMEExpandImm()
// =====

bits(32) ARMEExpandImm(bits(12) imm12)

    // APSR.C argument to following function call does not affect the imm32 result.
    (imm32, -) = ARMEExpandImm_C(imm12, APSR.C);

    return imm32;
// ARMEExpandImm_C()
// =====

(bits(32), bit) ARMEExpandImm_C(bits(12) imm12, bit carry_in)

    unrotated_value = ZeroExtend(imm12<7:0>, 32);
    (imm32, carry_out) = Shift_C(unrotated_value, SRTYPE_ROR, 2*UInt(imm12<11:8>), carry_in);

    return (imm32, carry_out);
```

## A5.2.5 Multiply and multiply accumulate

The encoding of ARM multiply and multiply accumulate instructions is:

31	30	29	28	27	26	25	24	23	22	21	20	19	18	17	16	15	14	13	12	11	10	9	8	7	6	5	4	3	2	1	0
cond				0	0	0	0	op																1	0	0	1				

Table A5-7 shows the allocation of encodings in this space.

**Table A5-7 Multiply and multiply accumulate instructions**

op	Instruction	See	Variant
000x	Multiply	<a href="#">MUL on page A8-502</a>	All
001x	Multiply Accumulate	<a href="#">MLA on page A8-480</a>	All
0100	Unsigned Multiply Accumulate Accumulate Long	<a href="#">UMAAL on page A8-774</a>	v6
0101	UNDEFINED	-	-
0110	Multiply and Subtract	<a href="#">MLS on page A8-482</a>	v6T2
0111	UNDEFINED	-	-
100x	Unsigned Multiply Long	<a href="#">UMULL on page A8-778</a>	All
101x	Unsigned Multiply Accumulate Long	<a href="#">UMLAL on page A8-776</a>	All
110x	Signed Multiply Long	<a href="#">SMULL on page A8-646</a>	All
111x	Signed Multiply Accumulate Long	<a href="#">SMLAL on page A8-624</a>	All

## A5.2.6 Saturating addition and subtraction

The encoding of ARM saturating addition and subtraction instructions is:

31	30	29	28	27	26	25	24	23	22	21	20	19	18	17	16	15	14	13	12	11	10	9	8	7	6	5	4	3	2	1	0
cond				0	0	0	1	0	op				0													0	1	0	1		

Table A5-8 shows the allocation of encodings in this space. These encodings are all available in ARMv5TE and above, and are UNDEFINED in earlier variants of the architecture.

**Table A5-8 Saturating addition and subtraction instructions**

op	Instruction	See
00	Saturating Add	<a href="#">QADD on page A8-540</a>
01	Saturating Subtract	<a href="#">QSUB on page A8-554</a>
10	Saturating Double and Add	<a href="#">QDADD on page A8-548</a>
11	Saturating Double and Subtract	<a href="#">QDSUB on page A8-550</a>

## A5.2.7 Halfword multiply and multiply accumulate

The encoding of ARM halfword multiply and multiply accumulate instructions is:

31	30	29	28	27	26	25	24	23	22	21	20	19	18	17	16	15	14	13	12	11	10	9	8	7	6	5	4	3	2	1	0	
cond				0	0	0	1	0	op1				0													1	op		0			

Table A5-9 shows the allocation of encodings in this space.

These encodings are signed multiply (SMUL) and signed multiply accumulate (SMLA) instructions, operating on 16-bit values, or mixed 16-bit and 32-bit values. The results and accumulators are 32-bit or 64-bit.

These encodings are all available in ARMv5TE and above, and are UNDEFINED in earlier variants of the architecture.

**Table A5-9 Halfword multiply and multiply accumulate instructions**

op1	op	Instruction	See
00	-	Signed 16-bit multiply, 32-bit accumulate	<a href="#">SMLABB, SMLABT, SMLATB, SMLATT on page A8-620</a>
01	0	Signed 16-bit × 32-bit multiply, 32-bit accumulate	<a href="#">SMLAWB, SMLAWT on page A8-630</a>
	1	Signed 16-bit × 32-bit multiply, 32-bit result	<a href="#">SMULWB, SMULWT on page A8-648</a>
10	-	Signed 16-bit multiply, 64-bit accumulate	<a href="#">SMLALBB, SMLALBT, SMLALTB, SMLALTT on page A8-626</a>
11	-	Signed 16-bit multiply, 32-bit result	<a href="#">SMULBB, SMULBT, SMULTB, SMULTT on page A8-644</a>

## A5.2.8 Extra load/store instructions

The encoding of extra ARM load/store instructions is:

31	30	29	28	27	26	25	24	23	22	21	20	19	18	17	16	15	14	13	12	11	10	9	8	7	6	5	4	3	2	1	0		
cond				0	0	0	op1				Rn																1	op2		1			

If (op2 == 0b00) or (op1 == 0b0xx11) or (op1 == 0b0xx10 AND op2 == 0b0x) then see [Data-processing and miscellaneous instructions on page A5-196](#).

Otherwise, Table A5-10 shows the allocation of encodings in this space.

**Table A5-10 Extra load/store instructions**

op2	op1	Rn	Instruction	See	Variant
01	xx0x0	-	Store Halfword	<a href="#">STRH (register) on page A8-702</a>	All
	xx0x1	-	Load Halfword	<a href="#">LDRH (register) on page A8-446</a>	All
	xx1x0	-	Store Halfword	<a href="#">STRH (immediate, ARM) on page A8-700</a>	All
	xx1x1	not 1111	Load Halfword	<a href="#">LDRH (immediate, ARM) on page A8-442</a>	All
		1111	Load Halfword	<a href="#">LDRH (literal) on page A8-444</a>	All
10	xx0x0	-	Load Dual	<a href="#">LDRD (register) on page A8-430</a>	v5TE
	xx0x1	-	Load Signed Byte	<a href="#">LDRSB (register) on page A8-454</a>	All
	xx1x0	not 1111	Load Dual	<a href="#">LDRD (immediate) on page A8-426</a>	v5TE
		1111	Load Dual	<a href="#">LDRD (literal) on page A8-428</a>	v5TE
	xx1x1	not 1111	Load Signed Byte	<a href="#">LDRSB (immediate) on page A8-450</a>	All
		1111	Load Signed Byte	<a href="#">LDRSB (literal) on page A8-452</a>	All

**Table A5-10 Extra load/store instructions (continued)**

op2	op1	Rn	Instruction	See	Variant
11	xx0x0	-	Store Dual	<a href="#">STRD (register) on page A8-688</a>	All
	xx0x1	-	Load Signed Halfword	<a href="#">LDRSH (register) on page A8-462</a>	All
	xx1x0	-	Store Dual	<a href="#">STRD (immediate) on page A8-686</a>	All
	xx1x1	not 1111	Load Signed Halfword	<a href="#">LDRSH (immediate) on page A8-458</a>	All
		1111	Load Signed Halfword	<a href="#">LDRSH (literal) on page A8-460</a>	All

### A5.2.9 Extra load/store instructions, unprivileged

The encoding of unprivileged extra ARM load/store instructions is:

31	30	29	28	27	26	25	24	23	22	21	20	19	18	17	16	15	14	13	12	11	10	9	8	7	6	5	4	3	2	1	0
cond				0	0	0	0			1	op													1	op2	1					

If op2 == 0b00 then see [Data-processing and miscellaneous instructions on page A5-196](#).

If (op == 0b0 AND op2 == 0b1x) then see [Extra load/store instructions on page A5-203](#).

Otherwise, [Table A5-11](#) shows the allocation of encodings in this space.

**Table A5-11 Extra load/store instructions, unprivileged**

op2	op	Instruction	See	Variant
01	0	Store Halfword Unprivileged	<a href="#">STRHT on page A8-704</a>	v6T2
	1	Load Halfword Unprivileged	<a href="#">LDRHT on page A8-448</a>	v6T2
10	1	Load Signed Byte Unprivileged	<a href="#">LDRSBT on page A8-456</a>	v6T2
11	1	Load Signed Halfword Unprivileged	<a href="#">LDRSHT on page A8-464</a>	v6T2



## A5.2.10 Synchronization primitives

The encoding of ARM synchronization primitive instructions is:

31	30	29	28	27	26	25	24	23	22	21	20	19	18	17	16	15	14	13	12	11	10	9	8	7	6	5	4	3	2	1	0
cond				0	0	0	1	op												1				0	0	1					

Table A5-12 shows the allocation of encodings in this space.

Other encodings in this space are UNDEFINED.

**Table A5-12 Synchronization primitives**

op	Instruction	See	Variant
0x00	Swap Word, Swap Byte	<i>SWP, SWPB</i> on page A8-722 <sup>a</sup>	All
1000	Store Register Exclusive	<i>STREX</i> on page A8-690	v6
1001	Load Register Exclusive	<i>LDREX</i> on page A8-432	v6
1010	Store Register Exclusive Doubleword	<i>STREXD</i> on page A8-694	v6K
1011	Load Register Exclusive Doubleword	<i>LDREXD</i> on page A8-436	v6K
1100	Store Register Exclusive Byte	<i>STREXB</i> on page A8-692	v6K
1101	Load Register Exclusive Byte	<i>LDREXB</i> on page A8-434	v6K
1110	Store Register Exclusive Halfword	<i>STREXH</i> on page A8-696	v6K
1111	Load Register Exclusive Halfword	<i>LDREXH</i> on page A8-438	v6K

a. ARM deprecates the use of these instructions.

### A5.2.11 MSR (immediate), and hints

The encoding of ARM MSR (immediate) and hint instructions is:

31	30	29	28	27	26	25	24	23	22	21	20	19	18	17	16	15	14	13	12	11	10	9	8	7	6	5	4	3	2	1	0
cond				0	0	1	1	0	op	1	0	op1						op2													

Table A5-13 shows the allocation of encodings in this space. Encodings with op set to 0, op1 set to 0b000, and a value of op2 that is not shown in the table, are unallocated hints and behave as if op2 is set to 0b00000000. These unallocated hint encodings are reserved and software must not use them.

**Table A5-13 MSR (immediate), and hints**

op	op1	op2	Instruction	See	Variant
0	0000	00000000	No Operation hint	<a href="#">NOP on page A8-510</a>	v6K, v6T2
		00000001	Yield hint	<a href="#">YIELD on page A8-1108</a>	v6K
		00000010	Wait For Event hint	<a href="#">WFE on page A8-1104</a>	v6K
		00000011	Wait For Interrupt hint	<a href="#">WFI on page A8-1106</a>	v6K
		00000100	Send Event hint	<a href="#">SEV on page A8-606</a>	v6K
		1111xxxx	Debug hint	<a href="#">DBG on page A8-377</a>	v7
0100 1x00	-	-	Move to Special register, Application level	<a href="#">MSR (immediate) on page A8-498</a>	All
			Move to Special register, System level	<a href="#">MSR (immediate) on page B9-1994</a>	All
xx01 xx1x	-	-	Move to Special register, System level	<a href="#">MSR (immediate) on page B9-1994</a>	All
1	-	-	Move to Special register, System level	<a href="#">MSR (immediate) on page B9-1994</a>	All

## A5.2.12 Miscellaneous instructions

The encoding of some miscellaneous ARM instructions is:

31	30	29	28	27	26	25	24	23	22	21	20	19	18	17	16	15	14	13	12	11	10	9	8	7	6	5	4	3	2	1	0
cond			0	0	0	1	0	op		0	op1							B	0	op2											

Table A5-14 shows the allocation of encodings in this space. Other encodings in this space are UNDEFINED.

**Table A5-14 Miscellaneous instructions**

op2	B	op	op1	Instruction or instruction class	See	Variant
000	1	x0	xxxx	Move from Banked or Special register	<i>MRS (Banked register) on page B9-1990</i>	v7VE
		x1	xxxx	Move to Banked or Special register	<i>MSR (Banked register) on page B9-1992</i>	v7VE
0	0	x0	xxxx	Move from Special register	<i>MRS on page A8-496</i> <i>MRS on page B9-1988</i>	All
		01	xx00	Move to Special register, Application level	<i>MSR (register) on page A8-500</i>	All
			xx01 xx1x	Move to Special register, System level	<i>MSR (register) on page B9-1996</i>	All
		11	-	Move to Special register, System level	<i>MSR (register) on page B9-1996</i>	All
001	-	01	-	Branch and Exchange	<i>BX on page A8-352</i>	v4T
		11	-	Count Leading Zeros	<i>CLZ on page A8-362</i>	v5T
010	-	01	-	Branch and Exchange Jazelle	<i>BXJ on page A8-354</i>	v5TEJ
011	-	01	-	Branch with Link and Exchange	<i>BLX (register) on page A8-350</i>	v5T
101	-	-	-	Saturating addition and subtraction	<i>Saturating addition and subtraction on page A5-202</i>	-
110	-	11	-	Exception Return	<i>ERET on page B9-1980</i>	v7VE
111	-	01	-	Breakpoint	<i>BKPT on page A8-346</i>	v5T
		10	-	Hypervisor Call	<i>HVC on page B9-1982</i>	v7VE
		11	-	Secure Monitor Call	<i>SMC (previously SMI) on page B9-2000</i>	Security Extensions

### A5.3 Load/store word and unsigned byte

The encoding of ARM load/store word and unsigned byte instructions is:

31	30	29	28	27	26	25	24	23	22	21	20	19	18	17	16	15	14	13	12	11	10	9	8	7	6	5	4	3	2	1	0
cond				0	1	A	op1				Rn								B												

These instructions have either A == 0 or B == 0. For instructions with A == 1 and B == 1, see [Media instructions on page A5-209](#).

Otherwise, [Table A5-15](#) shows the allocation of encodings in this space. These encodings are in all architecture variants.

**Table A5-15 Single data transfer instructions**

A	op1	B	Rn	Instruction	See
0	xx0x0 not 0x010	-	-	Store Register	<a href="#">STR (immediate, ARM) on page A8-674</a>
1	xx0x0 not 0x010	0	-	Store Register	<a href="#">STR (register) on page A8-676</a>
0	0x010	-	-	Store Register Unprivileged	<a href="#">STRT on page A8-706</a>
1	0x010	0	-		
0	xx0x1 not 0x011	-	not 1111	Load Register (immediate)	<a href="#">LDR (immediate, ARM) on page A8-408</a>
			1111	Load Register (literal)	<a href="#">LDR (literal) on page A8-410</a>
1	xx0x1 not 0x011	0	-	Load Register	<a href="#">LDR (register, ARM) on page A8-414</a>
0	0x011	-	-	Load Register Unprivileged	<a href="#">LDRT on page A8-466</a>
1	0x011	0	-		
0	xx1x0 not 0x110	-	-	Store Register Byte (immediate)	<a href="#">STRB (immediate, ARM) on page A8-680</a>
1	xx1x0 not 0x110	0	-	Store Register Byte (register)	<a href="#">STRB (register) on page A8-682</a>
0	0x110	-	-	Store Register Byte Unprivileged	<a href="#">STRBT on page A8-684</a>
1	0x110	0	-		
0	xx1x1 not 0x111	-	not 1111	Load Register Byte (immediate)	<a href="#">LDRB (immediate, ARM) on page A8-418</a>
			1111	Load Register Byte (literal)	<a href="#">LDRB (literal) on page A8-420</a>
1	xx1x1 not 0x111	0	-	Load Register Byte (register)	<a href="#">LDRB (register) on page A8-422</a>
0	0x111	-	-	Load Register Byte Unprivileged	<a href="#">LDRBT on page A8-424</a>
1	0x111	0	-		

## A5.4 Media instructions

The encoding of ARM media instructions is:

31	30	29	28	27	26	25	24	23	22	21	20	19	18	17	16	15	14	13	12	11	10	9	8	7	6	5	4	3	2	1	0
cond				0	1	1	op1				Rd				op2				1	Rn											

Table A5-16 shows the allocation of encodings in this space.

Other encodings in this space are UNDEFINED.

**Table A5-16 Media instructions**

op1	op2	Rd	Rn	cond	Instructions	See	Variant
000xx	-	-	-	-	-	<i>Parallel addition and subtraction, signed on page A5-210</i>	
001xx	-	-	-	-	-	<i>Parallel addition and subtraction, unsigned on page A5-211</i>	
01xxx	-	-	-	-	-	<i>Packing, unpacking, saturation, and reversal on page A5-212</i>	
10xxx	-	-	-	-	-	<i>Signed multiply, signed and unsigned divide on page A5-213</i>	
11000	000	1111	-	-	Unsigned Sum of Absolute Differences	<i>USAD8 on page A8-792</i>	v6
	000	not 1111	-	-	Unsigned Sum of Absolute Differences and Accumulate	<i>USADA8 on page A8-794</i>	v6
1101x	x10	-	-	-	Signed Bit Field Extract	<i>SBFX on page A8-598</i>	v6T2
1110x	x00	-	1111	-	Bit Field Clear	<i>BFC on page A8-336</i>	v6T2
			not 1111	-	Bit Field Insert	<i>BFI on page A8-338</i>	v6T2
1111x	x10	-	-	-	Unsigned Bit Field Extract	<i>UBFX on page A8-756</i>	v6T2
11111	111	-	-	1110	Permanently UNDEFINED	<i>UDF on page A8-758</i>	All <sup>a</sup>
				not 1110		- <sup>a</sup>	All

a. Issue C.a of this manual first defines an assembler mnemonic for this encoding. This mnemonic applies only to the unconditional encoding, with cond set to 0b1110.

### A5.4.1 Parallel addition and subtraction, signed

The encoding of ARM signed parallel addition and subtraction instructions is:

31	30	29	28	27	26	25	24	23	22	21	20	19	18	17	16	15	14	13	12	11	10	9	8	7	6	5	4	3	2	1	0
cond				0	1	1	0	0	0	op1													op2	1							

Table A5-17 shows the allocation of encodings in this space. These encodings are all available in ARMv6 and above, and are UNDEFINED in earlier variants of the architecture.

Other encodings in this space are UNDEFINED.

**Table A5-17 Signed parallel addition and subtraction instructions**

op1	op2	Instruction	See
01	000	Add 16-bit	<a href="#">SADD16 on page A8-586</a>
	001	Add and Subtract with Exchange, 16-bit	<a href="#">SASX on page A8-590</a>
	010	Subtract and Add with Exchange, 16-bit	<a href="#">SSAX on page A8-656</a>
	011	Subtract 16-bit	<a href="#">SSUB16 on page A8-658</a>
	100	Add 8-bit	<a href="#">SADD8 on page A8-588</a>
	111	Subtract 8-bit	<a href="#">SSUB8 on page A8-660</a>
Saturating instructions			
10	000	Saturating Add 16-bit	<a href="#">QADD16 on page A8-542</a>
	001	Saturating Add and Subtract with Exchange, 16-bit	<a href="#">QASX on page A8-546</a>
	010	Saturating Subtract and Add with Exchange, 16-bit	<a href="#">QSAX on page A8-552</a>
	011	Saturating Subtract 16-bit	<a href="#">QSUB16 on page A8-556</a>
	100	Saturating Add 8-bit	<a href="#">QADD8 on page A8-544</a>
	111	Saturating Subtract 8-bit	<a href="#">QSUB8 on page A8-558</a>
Halving instructions			
11	000	Halving Add 16-bit	<a href="#">SHADD16 on page A8-608</a>
	001	Halving Add and Subtract with Exchange, 16-bit	<a href="#">SHASX on page A8-612</a>
	010	Halving Subtract and Add with Exchange, 16-bit	<a href="#">SHSAX on page A8-614</a>
	011	Halving Subtract 16-bit	<a href="#">SHSUB16 on page A8-616</a>
	100	Halving Add 8-bit	<a href="#">SHADD8 on page A8-610</a>
	111	Halving Subtract 8-bit	<a href="#">SHSUB8 on page A8-618</a>

## A5.4.2 Parallel addition and subtraction, unsigned

The encoding of ARM unsigned parallel addition and subtraction instructions is:

31	30	29	28	27	26	25	24	23	22	21	20	19	18	17	16	15	14	13	12	11	10	9	8	7	6	5	4	3	2	1	0
cond				0	1	1	0	0	1	op1								op2								1					

Table A5-18 shows the allocation of encodings in this space. These encodings are all available in ARMv6 and above, and are UNDEFINED in earlier variants of the architecture.

Other encodings in this space are UNDEFINED.

**Table A5-18 Unsigned parallel addition and subtractions instructions**

op1	op2	Instruction	See
01	000	Add 16-bit	<a href="#">UADD16 on page A8-750</a>
	001	Add and Subtract with Exchange, 16-bit	<a href="#">UASX on page A8-754</a>
	010	Subtract and Add with Exchange, 16-bit	<a href="#">USAX on page A8-800</a>
	011	Subtract 16-bit	<a href="#">USUB16 on page A8-802</a>
	100	Add 8-bit	<a href="#">UADD8 on page A8-752</a>
	111	Subtract 8-bit	<a href="#">USUB8 on page A8-804</a>
Saturating instructions			
10	000	Saturating Add 16-bit	<a href="#">UQADD16 on page A8-780</a>
	001	Saturating Add and Subtract with Exchange, 16-bit	<a href="#">UQASX on page A8-784</a>
	010	Saturating Subtract and Add with Exchange, 16-bit	<a href="#">UQSAX on page A8-786</a>
	011	Saturating Subtract 16-bit	<a href="#">UQSUB16 on page A8-788</a>
	100	Saturating Add 8-bit	<a href="#">UQADD8 on page A8-782</a>
	111	Saturating Subtract 8-bit	<a href="#">UQSUB8 on page A8-790</a>
Halving instructions			
11	000	Halving Add 16-bit	<a href="#">UHADD16 on page A8-762</a>
	001	Halving Add and Subtract with Exchange, 16-bit	<a href="#">UHASX on page A8-766</a>
	010	Halving Subtract and Add with Exchange, 16-bit	<a href="#">UHSAX on page A8-768</a>
	011	Halving Subtract 16-bit	<a href="#">UHSUB16 on page A8-770</a>
	100	Halving Add 8-bit	<a href="#">UHADD8 on page A8-764</a>
	111	Halving Subtract 8-bit	<a href="#">UHSUB8 on page A8-772</a>

### A5.4.3 Packing, unpacking, saturation, and reversal

The encoding of ARM packing, unpacking, saturation, and reversal instructions is:

31	30	29	28	27	26	25	24	23	22	21	20	19	18	17	16	15	14	13	12	11	10	9	8	7	6	5	4	3	2	1	0
cond				0	1	1	0	1	op1				A								op2		1								

Table A5-19 shows the allocation of encodings in this space.

Other encodings in this space are UNDEFINED.

**Table A5-19 Packing, unpacking, saturation, and reversal instructions**

op1	op2	A	Instructions	See	Variant
000	xx0	-	Pack Halfword	<a href="#">PKH on page A8-522</a>	v6
	011	not 1111	Signed Extend and Add Byte 16-bit	<a href="#">SXTAB16 on page A8-726</a>	v6
		1111	Signed Extend Byte 16-bit	<a href="#">SXTB16 on page A8-732</a>	v6
	101	-	Select Bytes	<a href="#">SEL on page A8-602</a>	v6
01x	xx0	-	Signed Saturate	<a href="#">SSAT on page A8-652</a>	v6
010	001	-	Signed Saturate, two 16-bit	<a href="#">SSAT16 on page A8-654</a>	v6
	011	not 1111	Signed Extend and Add Byte	<a href="#">SXTAB on page A8-724</a>	v6
		1111	Signed Extend Byte	<a href="#">SXTB on page A8-730</a>	v6
011	001	-	Byte-Reverse Word	<a href="#">REV on page A8-562</a>	v6
	011	not 1111	Signed Extend and Add Halfword	<a href="#">SXTAH on page A8-728</a>	v6
		1111	Signed Extend Halfword	<a href="#">SXTH on page A8-734</a>	v6
	101	-	Byte-Reverse Packed Halfword	<a href="#">REV16 on page A8-564</a>	v6
100	011	not 1111	Unsigned Extend and Add Byte 16-bit	<a href="#">UXTAB16 on page A8-808</a>	v6
		1111	Unsigned Extend Byte 16-bit	<a href="#">UXTB16 on page A8-814</a>	v6
11x	xx0	-	Unsigned Saturate	<a href="#">USAT on page A8-796</a>	v6
110	001	-	Unsigned Saturate, two 16-bit	<a href="#">USAT16 on page A8-798</a>	v6
	011	not 1111	Unsigned Extend and Add Byte	<a href="#">UXTAB on page A8-806</a>	v6
		1111	Unsigned Extend Byte	<a href="#">UXTB on page A8-812</a>	v6
111	001	-	Reverse Bits	<a href="#">RBIT on page A8-560</a>	v6T2
	011	not 1111	Unsigned Extend and Add Halfword	<a href="#">UXTAH on page A8-810</a>	v6
		1111	Unsigned Extend Halfword	<a href="#">UXTH on page A8-816</a>	v6
	101	-	Byte-Reverse Signed Halfword	<a href="#">REVSH on page A8-566</a>	v6



#### A5.4.4 Signed multiply, signed and unsigned divide

The encoding of ARM signed multiply and divide instructions is:

31	30	29	28	27	26	25	24	23	22	21	20	19	18	17	16	15	14	13	12	11	10	9	8	7	6	5	4	3	2	1	0
cond				0	1	1	1	0	op1				A				op2				1										

Table A5-20 shows the allocation of encodings in this space.

Other encodings in this space are UNDEFINED.

**Table A5-20 Signed multiply instructions**

op1	op2	A	Instruction	See	Variant
000	00x	not 1111	Signed Multiply Accumulate Dual	<a href="#">SMLAD on page A8-622</a>	v6
		1111	Signed Dual Multiply Add	<a href="#">SMUAD on page A8-642</a>	v6
	01x	not 1111	Signed Multiply Subtract Dual	<a href="#">SMLSD on page A8-632</a>	v6
		1111	Signed Dual Multiply Subtract	<a href="#">SMUSD on page A8-650</a>	v6
001	000	-	Signed Divide	<a href="#">SDIV on page A8-600</a>	v7 <sup>a</sup>
011	000	-	Unsigned Divide	<a href="#">UDIV on page A8-760</a>	v7 <sup>a</sup>
100	00x	-	Signed Multiply Accumulate Long Dual	<a href="#">SMLALD on page A8-628</a>	v6
	01x	-	Signed Multiply Subtract Long Dual	<a href="#">SMLS LD on page A8-634</a>	v6
101	00x	not 1111	Signed Most Significant Word Multiply Accumulate	<a href="#">SMMLA on page A8-636</a>	v6
		1111	Signed Most Significant Word Multiply	<a href="#">SMMUL on page A8-640</a>	v6
	11x	-	Signed Most Significant Word Multiply Subtract	<a href="#">SMMLS on page A8-638</a>	v6

- a. Optional in some ARMv7 implementations, see [ARMv7 implementation requirements and options for the divide instructions on page A4-172](#).

## A5.5 Branch, branch with link, and block data transfer

The encoding of ARM branch, branch with link, and block data transfer instructions is:

31	30	29	28	27	26	25	24	23	22	21	20	19	18	17	16	15	14	13	12	11	10	9	8	7	6	5	4	3	2	1	0
cond			1	0	op				Rn				R																		

Table A5-21 shows the allocation of encodings in this space. These encodings are in all architecture variants.

**Table A5-21 Branch, branch with link, and block data transfer instructions**

op	R	Rn	Instructions	See
0000x0	-	-	Store Multiple Decrement After	<a href="#">STMDA (STMED) on page A8-666</a>
0000x1	-	-	Load Multiple Decrement After	<a href="#">LMDA/LDMFA on page A8-400</a>
0010x0	-	-	Store Multiple Increment After	<a href="#">STM (STMIA, STMEA) on page A8-664</a>
001001	-	-	Load Multiple Increment After	<a href="#">LDM/LDMIA/LDMFD (ARM) on page A8-398</a>
001011	-	not 1101	Load Multiple Increment After	<a href="#">LDM/LDMIA/LDMFD (ARM) on page A8-398</a>
		1101	Pop multiple registers	<a href="#">POP (ARM) on page A8-536</a>
010000	-	-	Store Multiple Decrement Before	<a href="#">STMDB (STMFD) on page A8-668</a>
010010	-	not 1101	Store Multiple Decrement Before	<a href="#">STMDB (STMFD) on page A8-668</a>
		1101	Push multiple registers	<a href="#">PUSH on page A8-538</a>
0100x1	-	-	Load Multiple Decrement Before	<a href="#">LDMDB/LDMEA on page A8-402</a>
0110x0	-	-	Store Multiple Increment Before	<a href="#">STMIB (STMFA) on page A8-670</a>
0110x1	-	-	Load Multiple Increment Before	<a href="#">LDMIB/LDMED on page A8-404</a>
0xx1x0	-	-	Store Multiple (user registers)	<a href="#">STM (User registers) on page B9-2006</a>
0xx1x1	0	-	Load Multiple (user registers)	<a href="#">LDM (User registers) on page B9-1986</a>
		1	Load Multiple (exception return)	<a href="#">LDM (exception return) on page B9-1984</a>
10xxxx	-	-	Branch	<a href="#">B on page A8-334</a>
11xxxx	-	-	Branch with Link	<a href="#">BL, BLX (immediate) on page A8-348</a>

## A5.6 Coprocessor instructions, and Supervisor Call

The encoding of ARM coprocessor instructions and the Supervisor Call instruction is:

31	30	29	28	27	26	25	24	23	22	21	20	19	18	17	16	15	14	13	12	11	10	9	8	7	6	5	4	3	2	1	0
cond			1	1	op1				Rn				coproc				op														

Table A5-22 shows the allocation of encodings in this space:

**Table A5-22 Coprocessor instructions, and Supervisor Call**

coproc	op1	op	Rn	Instructions	See	Variant
-	00000x	-	-	UNDEFINED	-	-
	11xxxx	-	-	Supervisor Call	<i>SVC (previously SWI) on page A8-720</i>	All
not 101x	0xxxx0 not 000x00	-	-	Store Coprocessor	<i>STC, STC2 on page A8-662</i>	All
	0xxxx1 not 000x01	-	not 1111	Load Coprocessor (immediate)	<i>LDC, LDC2 (immediate) on page A8-392</i>	All
			1111	Load Coprocessor (literal)	<i>LDC, LDC2 (literal) on page A8-394</i>	All
	000100	-	-	Move to Coprocessor from two ARM core registers	<i>MCRR, MCRR2 on page A8-478</i>	v5TE
	000101	-	-	Move to two ARM core registers from Coprocessor	<i>MRRC, MRRC2 on page A8-494</i>	v5TE
	10xxxx	0	-	Coprocessor data operations	<i>CDP, CDP2 on page A8-358</i>	All
	10xxx0	1	-	Move to Coprocessor from ARM core register	<i>MCR, MCR2 on page A8-476</i>	All
	10xxx1	1	-	Move to ARM core register from Coprocessor	<i>MRC, MRC2 on page A8-492</i>	All
101x	0xxxxx not 000x0x	-	-	Advanced SIMD, Floating-point	<i>Extension register load/store instructions on page A7-274</i>	
	00010x	-	-	Advanced SIMD, Floating-point	<i>64-bit transfers between ARM core and extension registers on page A7-279</i>	
	10xxxx	0	-	Floating-point data processing	<i>Floating-point data-processing instructions on page A7-272</i>	
	10xxxx	1	-	Advanced SIMD, Floating-point	<i>8, 16, and 32-bit transfer between ARM core and extension registers on page A7-278</i>	

For more information about specific coprocessors see *Coprocessor support on page A2-94*.

## A5.7 Unconditional instructions

The encoding of ARM unconditional instructions is:

31	30	29	28	27	26	25	24	23	22	21	20	19	18	17	16	15	14	13	12	11	10	9	8	7	6	5	4	3	2	1	0
1	1	1	1	op1								Rn								op											

Table A5-23 shows the allocation of encodings in this space.

Other encodings in this space are UNDEFINED in ARMv5 and above.

All encodings in this space are UNPREDICTABLE in ARMv4 and ARMv4T.

**Table A5-23 Unconditional instructions**

op1	op	Rn	Instruction	See	Variant
0xxxxxxx	-	-	-	<i>Memory hints, Advanced SIMD instructions, and miscellaneous instructions on page A5-217</i>	
100xx1x0	-	-	Store Return State	<i>SRS (ARM) on page B9-2004</i>	v6
100xx0x1	-	-	Return From Exception	<i>RFE on page B9-1998</i>	v6
101xxxxx	-	-	Branch with Link and Exchange	<i>BL, BLX (immediate) on page A8-348</i>	v5
110xxxx0 not 11000x00	-	-	Store Coprocessor	<i>STC, STC2 on page A8-662</i>	v5
110xxxx1 not 11000x01	-	not 1111	Load Coprocessor (immediate)	<i>LDC, LDC2 (immediate) on page A8-392</i>	v5
		1111	Load Coprocessor (literal)	<i>LDC, LDC2 (literal) on page A8-394</i>	v5
11000100	-	-	Move to Coprocessor from two ARM core registers	<i>MCRR, MCRR2 on page A8-478</i>	v6
11000101	-	-	Move to two ARM core registers from Coprocessor	<i>MRRC, MRRC2 on page A8-494</i>	v6
1110xxxx	0	-	Coprocessor data operations	<i>CDP, CDP2 on page A8-358</i>	v5
1110xxx0	1	-	Move to Coprocessor from ARM core register	<i>MCR, MCR2 on page A8-476</i>	v5
1110xxx1	1	-	Move to ARM core register from Coprocessor	<i>MRC, MRC2 on page A8-492</i>	v5

## A5.7.1 Memory hints, Advanced SIMD instructions, and miscellaneous instructions

The encoding of ARM memory hint and Advanced SIMD instructions, and some miscellaneous instruction is:

31	30	29	28	27	26	25	24	23	22	21	20	19	18	17	16	15	14	13	12	11	10	9	8	7	6	5	4	3	2	1	0
1	1	1	1	0	op1					Rn					op2																

Table A5-24 shows the allocation of encodings in this space.

Other encodings in this space are UNDEFINED in ARMv5 and above. All these encodings are UNPREDICTABLE in ARMv4 and ARMv4T.

**Table A5-24 Hints, and Advanced SIMD instructions**

op1	op2	Rn	Instruction	See	Variant
0010000	xx0x	xxx0	Change Processor State	<a href="#">CPS (ARM) on page B9-1978</a>	v6
0010000	0000	xxx1	Set Endianness	<a href="#">SETEND on page A8-604</a>	v6
01xxxxx	-	-	See <a href="#">Advanced SIMD data-processing instructions on page A7-261</a>		v7
100xxx0	-	-	See <a href="#">Advanced SIMD element or structure load/store instructions on page A7-275</a>		v7
100x001	-	-	Unallocated memory hint (treat as NOP)		MP Ext <sup>a</sup>
100x101	-	-	Preload Instruction	<a href="#">PLI (immediate, literal) on page A8-530</a>	v7
100xx11	-	-	UNPREDICTABLE	-	-
101x001	-	not 1111	Preload Data with intent to Write	<a href="#">PLD, PLDW (immediate) on page A8-524</a>	MP Ext <sup>a</sup>
		1111	UNPREDICTABLE	-	-
101x101	-	not 1111	Preload Data	<a href="#">PLD, PLDW (immediate) on page A8-524</a>	v5TE
		1111	Preload Data	<a href="#">PLD (literal) on page A8-526</a>	v5TE
1010011	-	-	UNPREDICTABLE	-	-
1010111	0000	-	UNPREDICTABLE	-	-
	0001	-	Clear-Exclusive	<a href="#">CLREX on page A8-360</a>	v6K
	001x	-	UNPREDICTABLE	-	-
	0100	-	Data Synchronization Barrier	<a href="#">DSB on page A8-380</a>	v6T2
	0101	-	Data Memory Barrier	<a href="#">DMB on page A8-378</a>	v7
	0110	-	Instruction Synchronization Barrier	<a href="#">ISB on page A8-389</a>	v6T2
	0111	-	UNPREDICTABLE	-	-
1xxx	-	-	UNPREDICTABLE	-	-
1011x11	-	-	UNPREDICTABLE	-	-
110x001	xxx0	-	Unallocated memory hint (treat as NOP)		MP Ext <sup>a</sup>
110x101	xxx0	-	Preload Instruction	<a href="#">PLI (register) on page A8-532</a>	v7
111x001	xxx0	-	Preload Data with intent to Write	<a href="#">PLD, PLDW (register) on page A8-528</a>	MP Ext <sup>a</sup>

**Table A5-24 Hints, and Advanced SIMD instructions (continued)**

<b>op1</b>	<b>op2</b>	<b>Rn</b>	<b>Instruction</b>	<b>See</b>	<b>Variant</b>
111x101	xxx0	-	Preload Data	<i>PLD, PLDW (register) on page A8-528</i>	v5TE
11xxx11	xxx0	-	UNPREDICTABLE	-	-
1111111	1111		Permanently UNDEFINED <sup>b</sup>	-	v5

- a. Multiprocessing Extensions.
- b. See [Table A5-16 on page A5-209](#) for the full range of encodings in this permanently UNDEFINED group.

# Chapter A6

## Thumb Instruction Set Encoding

This chapter introduces the Thumb instruction set and describes how it uses the ARM programmers' model. It contains the following sections:

- [Thumb instruction set encoding on page A6-220](#)
- [16-bit Thumb instruction encoding on page A6-223](#)
- [32-bit Thumb instruction encoding on page A6-230](#).

For details of the differences between the Thumb and ThumbEE instruction sets see [Chapter A9 The ThumbEE Instruction Set](#).

———— **Note** —————

- Architecture variant information in this chapter describes the architecture variant or extension in which the instruction encoding was introduced into the Thumb instruction set.
  - In the decode tables in this chapter, an entry of - for a field value means the value of the field does not affect the decoding.
-

## A6.1 Thumb instruction set encoding

The Thumb instruction stream is a sequence of halfword-aligned halfwords. Each Thumb instruction is either a single 16-bit halfword in that stream, or a 32-bit instruction consisting of two consecutive halfwords in that stream.

If the value of bits[15:11] of the halfword being decoded is one of the following, the halfword is the first halfword of a 32-bit instruction:

- 0b11101
- 0b11110
- 0b11111.

Otherwise, the halfword is a 16-bit instruction.

For details of the encoding of 16-bit Thumb instructions see [16-bit Thumb instruction encoding on page A6-223](#).

For details of the encoding of 32-bit Thumb instructions see [32-bit Thumb instruction encoding on page A6-230](#).

### A6.1.1 UNDEFINED and UNPREDICTABLE instruction set space

An attempt to execute an unallocated instruction results in either:

- Unpredictable behavior. The instruction is described as UNPREDICTABLE.
- An Undefined Instruction exception. The instruction is described as UNDEFINED.

An instruction is UNDEFINED if it is declared as UNDEFINED in an instruction description, or in this chapter.

An instruction is UNPREDICTABLE if:

- a bit marked (0) in the encoding diagram of an instruction is not 0, and the pseudocode for that encoding does not indicate that a different special case applies when that bit is not 0
- a bit marked (1) in the encoding diagram of an instruction is not 1, and the pseudocode for that encoding does not indicate that a different special case applies when that bit is not 1
- it is declared as UNPREDICTABLE in an instruction description or in this chapter.

For more information about UNDEFINED and UNPREDICTABLE instruction behavior, see [Undefined Instruction exception on page B1-1205](#).

Unless otherwise specified:

- Thumb instructions introduced in an architecture variant are either UNPREDICTABLE or UNDEFINED in earlier architecture variants.
- A Thumb instruction that is provided by one or more of the architecture extensions is either UNPREDICTABLE or UNDEFINED in an implementation that does not include any of those extensions.

In both cases, the instruction is UNPREDICTABLE if it is a 32-bit instruction in an architecture variant before ARMv6T2, and UNDEFINED otherwise.

### A6.1.2 Use of the PC, and use of 0b1111 as a register specifier

The use of 0b1111 as a register specifier is not normally permitted in Thumb instructions. When a value of 0b1111 is permitted, a variety of meanings is possible. For register reads, these meanings include:

- Read the PC value, that is, the address of the current instruction + 4. The base register of the table branch instructions TBB and TBH can be the PC. This means branch tables can be placed in memory immediately after the instruction.

———— **Note** —————

In ARMv7, ARM deprecates use of the PC as the base register in the STC instruction.



- Read the word-aligned PC value, that is, the address of the current instruction + 4, with bits[1:0] forced to zero. The base register of LDC, LDR, LDRB, LDRD (pre-indexed, no writeback), LDRH, LDRSB, and LDRSH instructions can be the word-aligned PC. This provides PC-relative data addressing. In addition, some encodings of the ADD and SUB instructions permit their source registers to be 0b1111 for the same purpose.
- Read zero. This is done in some cases when one instruction is a special case of another, more general instruction, but with one operand zero. In these cases, the instructions are listed on separate pages, with a special case in the pseudocode for the more general instruction cross-referencing the other page.

For register writes, these meanings include:

- The PC can be specified as the destination register of an LDR instruction. This is done by encoding Rt as 0b1111. The loaded value is treated as an address, and the effect of execution is a branch to that address. Bit[0] of the loaded value selects whether to execute ARM or Thumb instructions after the branch.
- Some other instructions write the PC in similar ways. An instruction can specify that the PC is written:
  - implicitly, for example, branch instructions
  - explicitly by a register specifier of 0b1111, for example 16-bit MOV (register) instructions
  - explicitly by using a register mask, for example LDM instructions.

The address to branch to can be:

- a loaded value, for example, RFE
- a register value, for example, BX
- the result of a calculation, for example, TBB or TBH.

The method of choosing the instruction set used after the branch can be:

- similar to the LDR case, for example, LDM or BX
- a fixed instruction set other than the one currently being used, for example, the immediate form of BLX
- unchanged, for example, branch instructions or 16-bit MOV (register) instructions
- set from the {J, T} bits of the [SPSR](#), for RFE and SUBS PC, LR, #imm8.

- Discard the result of a calculation. This is done in some cases when one instruction is a special case of another, more general instruction, but with the result discarded. In these cases, the instructions are listed on separate pages, with a special case in the pseudocode for the more general instruction cross-referencing the other page.
- If the destination register specifier of an LDRB, LDRH, LDRSB, or LDRSH instruction is 0b1111, the instruction is a memory hint instead of a load operation.
- If the destination register specifier of an MRC instruction is 0b1111, bits[31:28] of the value transferred from the coprocessor are written to the N, Z, C, and V condition flags in the APSR, and bits[27:0] are discarded.

### A6.1.3 Use of the SP, and use of 0b1101 as a register specifier

R13 is defined in the Thumb instruction set so that its use is primarily as a stack pointer, and R13 is normally identified as SP in Thumb instructions. In 32-bit Thumb instructions, if software uses R13 as a general-purpose register beyond the architecturally defined constraints described in this section, the results are UNPREDICTABLE.

The restrictions applicable to R13 are described in:

- [R13\[1:0\] definition](#)
- [32-bit Thumb instruction support for R13 on page A6-222](#).

See also [16-bit Thumb instruction support for R13 on page A6-222](#).

#### R13[1:0] definition

Bits[1:0] of R13 are SBZP. Writing a nonzero value to bits[1:0] causes UNPREDICTABLE behavior.

### 32-bit Thumb instruction support for R13

R13 instruction support is restricted to the following:

- R13 as the source or destination register of a MOV instruction. Only register to register transfers without shifts are supported, with no flag-setting:

```
MOV    SP, <Rm>
MOV    <Rn>, SP
```

- Using the following instructions to adjust R13 up or down by a multiple of 4:

```
ADD{W} SP, SP, #<imm>
SUB{W} SP, SP, #<imm>
ADD     SP, SP, <Rm>
ADD     SP, SP, <Rm>, LSL #<n>    ; For <n> = 1, 2, 3
SUB     SP, SP, <Rm>
SUB     SP, SP, <Rm>, LSL #<n>    ; For <n> = 1, 2, 3
```

- R13 as a base register <Rn> of any load/store instruction. This supports SP-based addressing for load, store, or memory hint instructions, with positive or negative offsets, with and without writeback.
- R13 as the first operand <Rn> in any ADD{S}, CMN, CMP, or SUB{S} instruction. The add and subtract instructions support SP-based address generation, with the address going into an ARM core register, R0-R12 or R14. CMN and CMP are useful for stack checking in some circumstances.
- R13 as the transferred register <Rt> in any LDR or STR instruction.

### 16-bit Thumb instruction support for R13

For 16-bit data-processing instructions that affect high registers, R13 can only be used as described in [32-bit Thumb instruction support for R13](#). ARM deprecates any other use. This affects the high register forms of CMP and ADD, where ARM deprecates the use of R13 as <Rm>.

## A6.2 16-bit Thumb instruction encoding

The encoding of a 16-bit Thumb instruction is:

15	14	13	12	11	10	9	8	7	6	5	4	3	2	1	0
Opcode															

Table A6-1 shows the allocation of 16-bit instruction encodings.

**Table A6-1 16-bit Thumb instruction encoding**

Opcode	Instruction or instruction class	Variant
00xxxx	<i>Shift (immediate), add, subtract, move, and compare</i> on page A6-224	-
010000	<i>Data-processing</i> on page A6-225	-
010001	<i>Special data instructions and branch and exchange</i> on page A6-226	-
01001x	Load from Literal Pool, see <i>LDR (literal)</i> on page A8-410	v4T
0101xx 011xxx 100xxx	<i>Load/store single data item</i> on page A6-227	-
10100x	Generate PC-relative address, see <i>ADR</i> on page A8-322	v4T
10101x	Generate SP-relative address, see <i>ADD (SP plus immediate)</i> on page A8-316	v4T
1011xx	<i>Miscellaneous 16-bit instructions</i> on page A6-228	-
11000x	Store multiple registers, see <i>STM (STMIA, STMEA)</i> on page A8-664 <sup>a</sup>	v4T
11001x	Load multiple registers, see <i>LDM/LDMIA/LDMFD (Thumb)</i> on page A8-396 <sup>a</sup>	v4T
1101xx	<i>Conditional branch, and Supervisor Call</i> on page A6-229	-
11100x	Unconditional Branch, see <i>B</i> on page A8-334	v4T

a. In ThumbEE, 16-bit load/store multiple instructions are not available. This encoding is used for special ThumbEE instructions. For details see [Chapter A9 The ThumbEE Instruction Set](#).

### A6.2.1 Shift (immediate), add, subtract, move, and compare

The encoding of 16-bit Thumb shift (immediate), add, subtract, move, and compare instructions is:

15	14	13	12	11	10	9	8	7	6	5	4	3	2	1	0
0	0	Opcode													

Table A6-2 shows the allocation of encodings in this space.

All these instructions are available since the Thumb instruction set was introduced in ARMv4T.

**Table A6-2 16-bit Thumb shift (immediate), add, subtract, move, and compare instructions**

Opcode	Instruction	See
000xx	Logical Shift Left <sup>a</sup>	<i>LSL (immediate)</i> on page A8-468
001xx	Logical Shift Right	<i>LSR (immediate)</i> on page A8-472
010xx	Arithmetic Shift Right	<i>ASR (immediate)</i> on page A8-330
01100	Add register	<i>ADD (register, Thumb)</i> on page A8-310
01101	Subtract register	<i>SUB (register)</i> on page A8-712
01110	Add 3-bit immediate	<i>ADD (immediate, Thumb)</i> on page A8-306
01111	Subtract 3-bit immediate	<i>SUB (immediate, Thumb)</i> on page A8-708
100xx	Move	<i>MOV (immediate)</i> on page A8-484
101xx	Compare	<i>CMP (immediate)</i> on page A8-370
110xx	Add 8-bit immediate	<i>ADD (immediate, Thumb)</i> on page A8-306
111xx	Subtract 8-bit immediate	<i>SUB (immediate, Thumb)</i> on page A8-708

a. When Opcode is 0b00000, and bits[8:6] are 0b000, this is an encoding for MOV, see *MOV (register, Thumb)* on page A8-486.

## A6.2.2 Data-processing

The encoding of 16-bit Thumb data-processing instructions is:

15	14	13	12	11	10	9	8	7	6	5	4	3	2	1	0
0	1	0	0	0	0	Opcode									

Table A6-3 shows the allocation of encodings in this space.

All these instructions are available since the Thumb instruction set was introduced in ARMv4T.

**Table A6-3 16-bit Thumb data-processing instructions**

Opcode	Instruction	See
0000	Bitwise AND	<i>AND (register)</i> on page A8-326
0001	Bitwise Exclusive OR	<i>EOR (register)</i> on page A8-384
0010	Logical Shift Left	<i>LSL (register)</i> on page A8-470
0011	Logical Shift Right	<i>LSR (register)</i> on page A8-474
0100	Arithmetic Shift Right	<i>ASR (register)</i> on page A8-332
0101	Add with Carry	<i>ADC (register)</i> on page A8-302
0110	Subtract with Carry	<i>SBC (register)</i> on page A8-594
0111	Rotate Right	<i>ROR (register)</i> on page A8-570
1000	Test	<i>TST (register)</i> on page A8-746
1001	Reverse Subtract from 0	<i>RSB (immediate)</i> on page A8-574
1010	Compare	<i>CMP (register)</i> on page A8-372
1011	Compare Negative	<i>CMN (register)</i> on page A8-366
1100	Bitwise OR	<i>ORR (register)</i> on page A8-518
1101	Multiply	<i>MUL</i> on page A8-502
1110	Bitwise Bit Clear	<i>BIC (register)</i> on page A8-342
1111	Bitwise NOT	<i>MVN (register)</i> on page A8-506

### A6.2.3 Special data instructions and branch and exchange

The encoding of 16-bit Thumb special data instructions and branch and exchange instructions is:

15	14	13	12	11	10	9	8	7	6	5	4	3	2	1	0
0	1	0	0	0	1	Opcode									

Table A6-4 shows the allocation of encodings in this space.

**Table A6-4 16-bit Thumb special data instructions and branch and exchange**

Opcode	Instruction	See	Variant
0000	Add Low Registers	<i>ADD (register, Thumb)</i> on page A8-310	v6T2 <sup>a</sup>
0001 001x	Add High Registers	<i>ADD (register, Thumb)</i> on page A8-310	v4T
01xx	Compare High Registers	<i>CMP (register)</i> on page A8-372	v4T
1000	Move Low Registers	<i>MOV (register, Thumb)</i> on page A8-486	v6 <sup>a</sup>
1001 101x	Move High Registers	<i>MOV (register, Thumb)</i> on page A8-486	v4T
110x	Branch and Exchange	<i>BX</i> on page A8-352	v4T
111x	Branch with Link and Exchange	<i>BLX (register)</i> on page A8-350	v5T <sup>a</sup>

a. UNPREDICTABLE in earlier variants.

## A6.2.4 Load/store single data item

The encoding of 16-bit Thumb instructions that load or store a single data item is:

15	14	13	12	11	10	9	8	7	6	5	4	3	2	1	0
opA				opB											

These instructions have one of the following values of opA:

- 0b0101
- 0b011x
- 0b100x.

Table A6-5 shows the allocation of encodings in this space.

All these instructions are available since the Thumb instruction set was introduced in ARMv4T.

**Table A6-5 16-bit Thumb Load/store single data item instructions**

opA	opB	Instruction	See
0101	000	Store Register	<i>STR (register)</i> on page A8-676
	001	Store Register Halfword	<i>STRH (register)</i> on page A8-702
	010	Store Register Byte	<i>STRB (register)</i> on page A8-682
	011	Load Register Signed Byte	<i>LDRSB (register)</i> on page A8-454
	100	Load Register	<i>LDR (register, Thumb)</i> on page A8-412
	101	Load Register Halfword	<i>LDRH (register)</i> on page A8-446
	110	Load Register Byte	<i>LDRB (register)</i> on page A8-422
	111	Load Register Signed Halfword	<i>LDRSH (register)</i> on page A8-462
0110	0xx	Store Register	<i>STR (immediate, Thumb)</i> on page A8-672
	1xx	Load Register	<i>LDR (immediate, Thumb)</i> on page A8-406
0111	0xx	Store Register Byte	<i>STRB (immediate, Thumb)</i> on page A8-678
	1xx	Load Register Byte	<i>LDRB (immediate, Thumb)</i> on page A8-416
1000	0xx	Store Register Halfword	<i>STRH (immediate, Thumb)</i> on page A8-698
	1xx	Load Register Halfword	<i>LDRH (immediate, Thumb)</i> on page A8-440
1001	0xx	Store Register SP relative	<i>STR (immediate, Thumb)</i> on page A8-672
	1xx	Load Register SP relative	<i>LDR (immediate, Thumb)</i> on page A8-406

## A6.2.5 Miscellaneous 16-bit instructions

The encoding of 16-bit Thumb miscellaneous instructions is:

15	14	13	12	11	10	9	8	7	6	5	4	3	2	1	0
1	0	1	1	Opcode											

Table A6-6 shows the allocation of encodings in this space. Other encodings in this space are UNDEFINED.

**Table A6-6 Miscellaneous 16-bit instructions**

Opcode	Instruction	See	Variant
0000xx	Add Immediate to SP	<i>ADD (SP plus immediate)</i> on page A8-316	v4T
00001xx	Subtract Immediate from SP	<i>SUB (SP minus immediate)</i> on page A8-716	v4T
0001xxx	Compare and Branch on Zero	<i>CBNZ, CBZ</i> on page A8-356	v6T2
001000x	Signed Extend Halfword	<i>SXTH</i> on page A8-734	v6
001001x	Signed Extend Byte	<i>SXTB</i> on page A8-730	v6
001010x	Unsigned Extend Halfword	<i>UXTH</i> on page A8-816	v6
001011x	Unsigned Extend Byte	<i>UXTB</i> on page A8-812	v6
0011xxx	Compare and Branch on Zero	<i>CBNZ, CBZ</i> on page A8-356	v6T2
010xxxx	Push Multiple Registers	<i>PUSH</i> on page A8-538	v4T
0110010	Set Endianness	<i>SETEND</i> on page A8-604	v6
0110011	Change Processor State	<i>CPS (Thumb)</i> on page B9-1976	v6
1001xxx	Compare and Branch on Nonzero	<i>CBNZ, CBZ</i> on page A8-356	v6T2
101000x	Byte-Reverse Word	<i>REV</i> on page A8-562	v6
101001x	Byte-Reverse Packed Halfword	<i>REV16</i> on page A8-564	v6
101011x	Byte-Reverse Signed Halfword	<i>REVSH</i> on page A8-566	v6
1011xxx	Compare and Branch on Nonzero	<i>CBNZ, CBZ</i> on page A8-356	v6T2
110xxxx	Pop Multiple Registers	<i>POP (Thumb)</i> on page A8-534	v4T
1110xxx	Breakpoint	<i>BKPT</i> on page A8-346	v5
1111xxx	If-Then, and hints	<i>If-Then, and hints</i> on page A6-229	-



### If-Then, and hints

The encoding of 16-bit Thumb If-Then and hint instructions is:

15	14	13	12	11	10	9	8	7	6	5	4	3	2	1	0
1	0	1	1	1	1	1	1	opA				opB			

Table A6-7 shows the allocation of encodings in this space.

Other encodings in this space are unallocated hints. They execute as NOPs, but software must not use them.

**Table A6-7 16-bit If-Then and hint instructions**

opA	opB	Instruction	See	Variant
-	not 0000	If-Then	<a href="#">IT on page A8-390</a>	v6T2
0000	0000	No Operation hint	<a href="#">NOP on page A8-510</a>	v6T2
0001	0000	Yield hint	<a href="#">YIELD on page A8-1108</a>	v7
0010	0000	Wait For Event hint	<a href="#">WFE on page A8-1104</a>	v7
0011	0000	Wait For Interrupt hint	<a href="#">WFI on page A8-1106</a>	v7
0100	0000	Send Event hint	<a href="#">SEV on page A8-606</a>	v7

### A6.2.6 Conditional branch, and Supervisor Call

The encoding of 16-bit Thumb conditional branch and Supervisor Call instructions is:

15	14	13	12	11	10	9	8	7	6	5	4	3	2	1	0
1	1	0	1	Opcode											

Table A6-8 shows the allocation of encodings in this space.

All these instructions are available since the Thumb instruction set was introduced in ARMv4T.

**Table A6-8 Conditional branch and Supervisor Call instructions**

Opcode	Instruction	See
not 111x	Conditional branch	<a href="#">B on page A8-334</a>
1110	Permanently UNDEFINED	<a href="#">UDF on page A8-758<sup>a</sup></a>
1111	Supervisor Call	<a href="#">SVC (previously SWI) on page A8-720</a>

a. Issue C.a of this manual first defines an assembler mnemonic for this encoding.

## A6.3 32-bit Thumb instruction encoding

The encoding of a 32-bit Thumb instruction is:

15	14	13	12	11	10	9	8	7	6	5	4	3	2	1	0	15	14	13	12	11	10	9	8	7	6	5	4	3	2	1	0
1	1	1	op1			op2						op																			

If op1 == 0b00, a 16-bit instruction is encoded, see [16-bit Thumb instruction encoding on page A6-223](#).

Otherwise, [Table A6-9](#) shows the allocation of encodings in this space.

**Table A6-9 32-bit Thumb instruction encoding**

op1	op2	op	Instruction class, see
01	00xx0xx	-	<a href="#">Load/store multiple on page A6-237</a>
	00xx1xx	-	<a href="#">Load/store dual, load/store exclusive, table branch on page A6-238</a>
	01xxxxx	-	<a href="#">Data-processing (shifted register) on page A6-243</a>
	1xxxxxx	-	<a href="#">Coprocessor, Advanced SIMD, and Floating-point instructions on page A6-251</a>
10	x0xxxxx	0	<a href="#">Data-processing (modified immediate) on page A6-231</a>
	x1xxxxx	0	<a href="#">Data-processing (plain binary immediate) on page A6-234</a>
	-	1	<a href="#">Branches and miscellaneous control on page A6-235</a>
11	000xxx0	-	<a href="#">Store single data item on page A6-242</a>
	00xx001	-	<a href="#">Load byte, memory hints on page A6-241</a>
	00xx011	-	<a href="#">Load halfword, memory hints on page A6-240</a>
	00xx101	-	<a href="#">Load word on page A6-239</a>
	00xx111	-	UNDEFINED
	001xxx0	-	<a href="#">Advanced SIMD element or structure load/store instructions on page A7-275</a>
	010xxxx	-	<a href="#">Data-processing (register) on page A6-245</a>
	0110xxx	-	<a href="#">Multiply, multiply accumulate, and absolute difference on page A6-249</a>
	0111xxx	-	<a href="#">Long multiply, long multiply accumulate, and divide on page A6-250</a>
	1xxxxxx	-	<a href="#">Coprocessor, Advanced SIMD, and Floating-point instructions on page A6-251</a>

### A6.3.1 Data-processing (modified immediate)

The encoding of the 32-bit Thumb data-processing (modified immediate) instructions is:

15	14	13	12	11	10	9	8	7	6	5	4	3	2	1	0	15	14	13	12	11	10	9	8	7	6	5	4	3	2	1	0
1	1	1	1	0	0	op	S	Rn	0							Rd															

Table A6-10 shows the allocation of encodings in this space. Other encodings in this space are UNDEFINED.

These encodings are all available in ARMv6T2 and above.

**Table A6-10 32-bit modified immediate data-processing instructions**

op	Rn	Rd:S	Instruction	See
0000	-	not 11111	Bitwise AND	<a href="#">AND (immediate) on page A8-324</a>
		11111	Test	<a href="#">TST (immediate) on page A8-744</a>
0001	-	-	Bitwise Bit Clear	<a href="#">BIC (immediate) on page A8-340</a>
0010	not 1111	-	Bitwise OR	<a href="#">ORR (immediate) on page A8-516</a>
		1111	Move	<a href="#">MOV (immediate) on page A8-484</a>
0011	not 1111	-	Bitwise OR NOT	<a href="#">ORN (immediate) on page A8-512</a>
		1111	Bitwise NOT	<a href="#">MVN (immediate) on page A8-504</a>
0100	-	not 11111	Bitwise Exclusive OR	<a href="#">EOR (immediate) on page A8-382</a>
		11111	Test Equivalence	<a href="#">TEQ (immediate) on page A8-738</a>
1000	-	not 11111	Add	<a href="#">ADD (immediate, Thumb) on page A8-306</a>
		11111	Compare Negative	<a href="#">CMN (immediate) on page A8-364</a>
1010	-	-	Add with Carry	<a href="#">ADC (immediate) on page A8-300</a>
1011	-	-	Subtract with Carry	<a href="#">SBC (immediate) on page A8-592</a>
1101	-	not 11111	Subtract	<a href="#">SUB (immediate, Thumb) on page A8-708</a>
		11111	Compare	<a href="#">CMP (immediate) on page A8-370</a>
1110	-	-	Reverse Subtract	<a href="#">RSB (immediate) on page A8-574</a>

These instructions all have modified immediate constants, rather than a simple 12-bit binary number. This provides a more useful range of values. For details see [Modified immediate constants in Thumb instructions on page A6-232](#).

### A6.3.2 Modified immediate constants in Thumb instructions

The encoding of a modified immediate constant in a 32-bit Thumb instruction is:

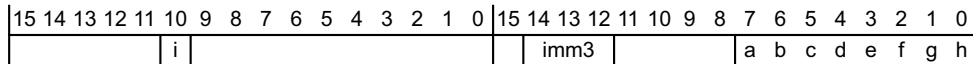

Table A6-11 shows the range of modified immediate constants available in Thumb data-processing instructions, and their encoding in the a, b, c, d, e, f, g, h, and i bits, and the imm3 field, in the instruction.

**Table A6-11 Encoding of modified immediates in Thumb data-processing instructions**

i:imm3:a	<const> <sup>a</sup>
0000x	00000000 00000000 00000000 abcdefgh
0001x	00000000 abcdefgh 00000000 abcdefgh <sup>b</sup>
0010x	abcdefgh 00000000 abcdefgh 00000000 <sup>b</sup>
0011x	abcdefgh abcdefgh abcdefgh abcdefgh <sup>b</sup>
01000	1bcdefgh 00000000 00000000 00000000
01001	01bcdefg h0000000 00000000 00000000 <sup>c</sup>
01010	001bcdef gh000000 00000000 00000000
01011	0001bcde fgh00000 00000000 00000000 <sup>c</sup>
.	.
.	. 8-bit values shifted to other positions
.	.
11101	00000000 00000000 000001bc defgh000 <sup>c</sup>
11110	00000000 00000000 0000001b cdefgh00
11111	00000000 00000000 00000001 bcdefgh0 <sup>c</sup>

- a. This table shows the immediate constant value in binary form, to relate abcdefgh to the encoding diagram. In assembly syntax, the immediate value is specified in the usual way (a decimal number by default).
- b. Not available in ARM instructions. UNPREDICTABLE if abcdefgh == 00000000.
- c. Not available in ARM instructions if h == 1.

———— **Note** ————

As the footnotes to Table A6-11 show, the range of values available in Thumb modified immediate constants is slightly different from the range of values available in ARM instructions. See *Modified immediate constants in ARM instructions* on page A5-200 for the ARM values.

#### Carry out

A logical instruction with i:imm3:a == '00xxx' does not affect the Carry flag. Otherwise, a logical flag-setting instruction sets the Carry flag to the value of bit[31] of the modified immediate constant.

## Operation of modified immediate constants, Thumb instructions

```
// ThumbExpandImm()
// =====

bits(32) ThumbExpandImm(bits(12) imm12)

    // APSR.C argument to following function call does not affect the imm32 result.
    (imm32, -) = ThumbExpandImm_C(imm12, APSR.C);

    return imm32;

// ThumbExpandImm_C()
// =====

(bits(32), bit) ThumbExpandImm_C(bits(12) imm12, bit carry_in)

    if imm12<11:10> == '00' then

        case imm12<9:8> of
            when '00'
                imm32 = ZeroExtend(imm12<7:0>, 32);
            when '01'
                if imm12<7:0> == '00000000' then UNPREDICTABLE;
                imm32 = '00000000' : imm12<7:0> : '00000000' : imm12<7:0>;
            when '10'
                if imm12<7:0> == '00000000' then UNPREDICTABLE;
                imm32 = imm12<7:0> : '00000000' : imm12<7:0> : '00000000';
            when '11'
                if imm12<7:0> == '00000000' then UNPREDICTABLE;
                imm32 = imm12<7:0> : imm12<7:0> : imm12<7:0> : imm12<7:0>;
        carry_out = carry_in;

    else

        unrotated_value = ZeroExtend('1':imm12<6:0>, 32);
        (imm32, carry_out) = ROR_C(unrotated_value, UInt(imm12<11:7>));

    return (imm32, carry_out);
```

### A6.3.3 Data-processing (plain binary immediate)

The encoding of the 32-bit Thumb data-processing (plain binary immediate) instructions is:

15	14	13	12	11	10	9	8	7	6	5	4	3	2	1	0	15	14	13	12	11	10	9	8	7	6	5	4	3	2	1	0
1	1	1	1	0	1	op					Rn					0															

Table A6-12 shows the allocation of encodings in this space. Other encodings in this space are UNDEFINED.

These encodings are all available in ARMv6T2 and above.

**Table A6-12 32-bit unmodified immediate data-processing instructions**

op	Rn	Instruction	See
00000	not 1111	Add Wide (12-bit)	<a href="#">ADD (immediate, Thumb) on page A8-306</a>
	1111	Form PC-relative Address	<a href="#">ADR on page A8-322</a>
00100	-	Move Wide (16-bit)	<a href="#">MOV (immediate) on page A8-484</a>
01010	not 1111	Subtract Wide (12-bit)	<a href="#">SUB (immediate, Thumb) on page A8-708</a>
	1111	Form PC-relative Address	<a href="#">ADR on page A8-322</a>
01100	-	Move Top (16-bit)	<a href="#">MOVT on page A8-491</a>
10000 10010 <sup>a</sup>	-	Signed Saturate	<a href="#">SSAT on page A8-652</a>
10010 <sup>b</sup>	-	Signed Saturate, two 16-bit	<a href="#">SSAT16 on page A8-654</a>
10100	-	Signed Bit Field Extract	<a href="#">SBFX on page A8-598</a>
10110	not 1111	Bit Field Insert	<a href="#">BFI on page A8-338</a>
	1111	Bit Field Clear	<a href="#">BFC on page A8-336</a>
11000 11010 <sup>a</sup>	-	Unsigned Saturate	<a href="#">USAT on page A8-796</a>
11010 <sup>b</sup>	-	Unsigned Saturate, two 16-bit	<a href="#">USAT16 on page A8-798</a>
11100	-	Unsigned Bit Field Extract	<a href="#">UBFX on page A8-756</a>

- a. In the second halfword of the instruction, bits[14:12, 7:6] != 0b00000.
- b. In the second halfword of the instruction, bits[14:12, 7:6] == 0b00000.

### A6.3.4 Branches and miscellaneous control

The encoding of the 32-bit Thumb branch instructions and miscellaneous control instructions is:

15	14	13	12	11	10	9	8	7	6	5	4	3	2	1	0	15	14	13	12	11	10	9	8	7	6	5	4	3	2	1	0
1	1	1	1	0	op								1	op1		op2		imm8													

Table A6-13 shows the allocation of encodings in this space. Other encodings in this space are UNDEFINED.

**Table A6-13 Branches and miscellaneous control instructions**

op1	imm8	op	op2	Instruction	See	Variant
0x0	-	not x111xxx	-	Conditional branch	<a href="#">B on page A8-334</a>	v6T2
	xx1xxxxx	011100x	-	Move to Banked or Special register	<a href="#">MSR (Banked register) on page B9-1992</a>	v7VE
	xx0xxxxx	0111000	xx00	Move to Special register, Application level	<a href="#">MSR (register) on page A8-500</a>	All
			xx01 xx1x	Move to Special register, System level	<a href="#">MSR (register) on page B9-1996</a>	All
		0111001	-	Move to Special register, System level	<a href="#">MSR (register) on page B9-1996</a>	All
-		0111010	-	-	<a href="#">Change Processor State, and hints on page A6-236</a>	
-		0111011	-	-	<a href="#">Miscellaneous control instructions on page A6-237</a>	
-		0111100	-	Branch and Exchange Jazelle	<a href="#">BXJ on page A8-354</a>	v6T2
	00000000	0111101	-	Exception Return	<a href="#">ERET on page B9-1980</a>	v6T2 <sup>a</sup>
	not 00000000	0111101	-	Exception Return	<a href="#">SUBS PC, LR (Thumb) on page B9-2008</a>	v6T2
	xx1xxxxx	011111x	-	Move from Banked or Special register	<a href="#">MRS (Banked register) on page B9-1990</a>	v7VE
	xx0xxxxx	0111110	-	Move from Special register, Application level	<a href="#">MRS on page A8-496</a>	v6T2
		0111111	-	Move from Special register, System level	<a href="#">MRS on page B9-1988</a>	v6T2
000	-	1111110	-	Hypervisor Call	<a href="#">HVC on page B9-1982</a>	v7VE
		1111111	-	Secure Monitor Call	<a href="#">SMC (previously SMI) on page B9-2000</a>	Security Extensions
0x1	-	-	-	Branch	<a href="#">B on page A8-334</a>	v6T2
010	-	1111111	-	Permanently UNDEFINED	<a href="#">UDF on page A8-758</a>	All <sup>b</sup>

**Table A6-13 Branches and miscellaneous control instructions (continued)**

op1	imm8	op	op2	Instruction	See	Variant
1x0	-	-	-	Branch with Link and Exchange	<a href="#">BL, BLX (immediate)</a> on page A8-348	v5T <sup>c</sup>
1x1	-	-	-	Branch with Link	<a href="#">BL, BLX (immediate)</a> on page A8-348	v4T

- v7VE, that is, ARMv7 with the Virtualization Extensions, first defines ERET as an assembler mnemonic for this encoding. From ARMv6T2 this is an encoding for [SUBS PC, LR \(Thumb\)](#) on page B9-2008 with an imm8 value of zero. The Virtualization Extensions do not change the behavior of the encoded instruction when it is executed at PL1.
- Issue C.a of this manual first defines an assembler mnemonic for this encoding.
- UNDEFINED in ARMv4T.

### Change Processor State, and hints

The encoding of 32-bit Thumb Change Processor State and hint instructions is:

15	14	13	12	11	10	9	8	7	6	5	4	3	2	1	0	15	14	13	12	11	10	9	8	7	6	5	4	3	2	1	0
1	1	1	1	0	0	1	1	1	0	1	0					1	0		0					op1					op2		

Table A6-14 shows the allocation of encodings in this space. Encodings with op1 set to 0b000 and a value of op2 that is not shown in the table are unallocated hints, and behave as if op2 is set to 0b00000000. These unallocated hint encodings are reserved and software must not use them.

**Table A6-14 Change Processor State, and hint instructions**

op1	op2	Instruction	See	Variant
not 000	-	Change Processor State	<a href="#">CPS (Thumb)</a> on page B9-1976	v6T2
000	00000000	No Operation hint	<a href="#">NOP</a> on page A8-510	v6T2
	00000001	Yield hint	<a href="#">YIELD</a> on page A8-1108	v7
	00000010	Wait For Event hint	<a href="#">WFE</a> on page A8-1104	v7
	00000011	Wait For Interrupt hint	<a href="#">WFI</a> on page A8-1106	v7
	00000100	Send Event hint	<a href="#">SEV</a> on page A8-606	v7
	1111xxxx	Debug hint	<a href="#">DBG</a> on page A8-377	v7



## Miscellaneous control instructions

The encoding of some 32-bit Thumb miscellaneous control instructions is:

15	14	13	12	11	10	9	8	7	6	5	4	3	2	1	0	15	14	13	12	11	10	9	8	7	6	5	4	3	2	1	0
1	1	1	1	0	0	1	1	1	0	1	1					1	0		0					op							

Table A6-15 shows the allocation of encodings in this space. Other encodings in this space are UNDEFINED in ARMv7. They are UNPREDICTABLE in ARMv6T2.

**Table A6-15 Miscellaneous control instructions**

op	Instruction	See	Variant
0000	Exit ThumbEE state <sup>a</sup>	<a href="#">ENTERX, LEAVEX on page A9-1116</a>	ThumbEE
0001	Enter ThumbEE state	<a href="#">ENTERX, LEAVEX on page A9-1116</a>	ThumbEE
0010	Clear-Exclusive	<a href="#">CLREX on page A8-360</a>	v7
0100	Data Synchronization Barrier	<a href="#">DSB on page A8-380</a>	v7
0101	Data Memory Barrier	<a href="#">DMB on page A8-378</a>	v7
0110	Instruction Synchronization Barrier	<a href="#">ISB on page A8-389</a>	v7

a. This instruction is a NOP in Thumb state.

### A6.3.5 Load/store multiple

The encoding of 32-bit Thumb load/store multiple instructions is:

15	14	13	12	11	10	9	8	7	6	5	4	3	2	1	0	15	14	13	12	11	10	9	8	7	6	5	4	3	2	1	0
1	1	1	0	1	0	0	op	0	W	L			Rn																		

Table A6-16 shows the allocation of encodings in this space.

These encodings are all available in ARMv6T2 and above.

**Table A6-16 Load/store multiple instructions**

op	L	W:Rn	Instruction	See
00	0	-	Store Return State	<a href="#">SRS (Thumb) on page B9-2002</a>
	1	-	Return From Exception	<a href="#">RFE on page B9-1998</a>
01	0	-	Store Multiple (Increment After, Empty Ascending)	<a href="#">STM (STMLA, STMEA) on page A8-664</a>
	1	not 11101	Load Multiple (Increment After, Full Descending)	<a href="#">LDM/LDMIA/LDMFD (Thumb) on page A8-396</a>
		11101	Pop Multiple Registers from the stack	<a href="#">POP (Thumb) on page A8-534</a>
10	0	not 11101	Store Multiple (Decrement Before, Full Descending)	<a href="#">STMDB (STMFD) on page A8-668</a>
		11101	Push Multiple Registers to the stack.	<a href="#">PUSH on page A8-538</a>
	1	-	Load Multiple (Decrement Before, Empty Ascending)	<a href="#">LDMDB/LDMEA on page A8-402</a>
11	0	-	Store Return State	<a href="#">SRS (Thumb) on page B9-2002</a>
	1	-	Return From Exception	<a href="#">RFE on page B9-1998</a>

### A6.3.6 Load/store dual, load/store exclusive, table branch

The encoding of 32-bit Thumb load/store dual, load/store exclusive and table branch instructions is:

15	14	13	12	11	10	9	8	7	6	5	4	3	2	1	0	15	14	13	12	11	10	9	8	7	6	5	4	3	2	1	0
1	1	1	0	1	0	0	op1	1	op2	Rn						op3															

Table A6-17 shows the allocation of encodings in this space. Other encodings in this space are UNDEFINED.

**Table A6-17 Load/store double or exclusive, table branch**

op1	op2	op3	Rn	Instruction	See	Variant
00	00	-	-	Store Register Exclusive	<a href="#">STREX on page A8-690</a>	v6T2
	01	-	-	Load Register Exclusive	<a href="#">LDREX on page A8-432</a>	v6T2
0x	10	-	-	Store Register Dual	<a href="#">STRD (immediate) on page A8-686</a>	v6T2
1x	x0	-	-			
0x	11	-	not 1111	Load Register Dual (immediate)	<a href="#">LDRD (immediate) on page A8-426</a>	v6T2
1x	x1	-	not 1111			
0x	11	-	1111	Load Register Dual (literal)	<a href="#">LDRD (literal) on page A8-428</a>	v6T2
1x	x1	-	1111			
01	00	0100	-	Store Register Exclusive Byte	<a href="#">STREXB on page A8-692</a>	v7
		0101	-	Store Register Exclusive Halfword	<a href="#">STREXH on page A8-696</a>	v7
		0111	-	Store Register Exclusive Doubleword	<a href="#">STREXD on page A8-694</a>	v7
	01	0000	-	Table Branch Byte	<a href="#">TBB, TBH on page A8-736</a>	v6T2
		0001	-	Table Branch Halfword	<a href="#">TBB, TBH on page A8-736</a>	v6T2
		0100	-	Load Register Exclusive Byte	<a href="#">LDREXB on page A8-434</a>	v7
		0101	-	Load Register Exclusive Halfword	<a href="#">LDREXH on page A8-438</a>	v7
		0111	-	Load Register Exclusive Doubleword	<a href="#">LDREXD on page A8-436</a>	v7

### A6.3.7 Load word

The encoding of 32-bit Thumb load word instructions is:

15	14	13	12	11	10	9	8	7	6	5	4	3	2	1	0	15	14	13	12	11	10	9	8	7	6	5	4	3	2	1	0
1	1	1	1	1	0	0	op1	1	0	1	Rn								op2												

Table A6-18 shows the allocation of encodings in this space. Other encodings in this space are UNDEFINED.

These encodings are all available in ARMv6T2 and above.

**Table A6-18 Load word**

op1	op2	Rn	Instruction	See
00	000000	not 1111	Load Register	<i>LDR (register, Thumb)</i> on page A8-412
00	1xx1xx	not 1111	Load Register	<i>LDR (immediate, Thumb)</i> on page A8-406
	1100xx	not 1111		
01	-	not 1111		
00	1110xx	not 1111	Load Register Unprivileged	<i>LDRT</i> on page A8-466
0x	-	1111	Load Register	<i>LDR (literal)</i> on page A8-410

### A6.3.8 Load halfword, memory hints

The encoding of 32-bit Thumb load halfword instructions and some memory hint instructions is:

15	14	13	12	11	10	9	8	7	6	5	4	3	2	1	0	15	14	13	12	11	10	9	8	7	6	5	4	3	2	1	0
1	1	1	1	1	0	0	op1	0	1	1		Rn		Rt		op2															

Table A6-19 shows the allocation of encodings in this space. Other encodings in this space are UNDEFINED.

Except where otherwise noted, these encodings are available in ARMv6T2 and above.

**Table A6-19 Load halfword, preload**

op1	op2	Rn	Rt	Instruction	See
0x	-	1111	not 1111	Load Register Halfword	<a href="#">LDRH (literal) on page A8-444</a>
			1111	Preload Data	<a href="#">PLD (literal) on page A8-526</a>
00	1xx1xx	not 1111	-	Load Register Halfword	<a href="#">LDRH (immediate, Thumb) on page A8-440</a>
	1100xx	not 1111	not 1111		
01	-	not 1111	not 1111		
00	000000	not 1111	not 1111	Load Register Halfword	<a href="#">LDRH (register) on page A8-446</a>
			-	Load Register Halfword Unprivileged	<a href="#">LDRHT on page A8-448</a>
	not 1111	1111	Preload Data with intent to Write <sup>a</sup>	<a href="#">PLD, PLDW (register) on page A8-528</a>	
		1111	Preload Data with intent to Write <sup>a</sup>	<a href="#">PLD, PLDW (immediate) on page A8-524</a>	
01	-	not 1111	1111		
10	1xx1xx	not 1111	-	Load Register Signed Halfword	<a href="#">LDRSH (immediate) on page A8-458</a>
	1100xx	not 1111	not 1111		
11	-	not 1111	not 1111		
1x	-	1111	not 1111	Load Register Signed Halfword	<a href="#">LDRSH (literal) on page A8-460</a>
10	000000	not 1111	not 1111	Load Register Signed Halfword	<a href="#">LDRSH (register) on page A8-462</a>
			-	Load Register Signed Halfword Unprivileged	<a href="#">LDRSHT on page A8-464</a>
10	000000	not 1111	1111	Unallocated memory hint (treat as NOP)	-
			not 1111	1111	
1x	-	1111	1111		
11	-	not 1111	1111	Unallocated memory hint (treat as NOP)	-

a. Available in ARMv7 with the Multiprocessing Extensions. In an ARMv7 implementation that does not include the Multiprocessing Extensions, and in ARMv6T2, these are unallocated memory hints, that are treated as NOPs.

### A6.3.9 Load byte, memory hints

The encoding of 32-bit Thumb load byte instructions and some memory hint instructions is:

15	14	13	12	11	10	9	8	7	6	5	4	3	2	1	0	15	14	13	12	11	10	9	8	7	6	5	4	3	2	1	0
1	1	1	1	1	0	0	op1	0	0	1		Rn		Rt		op2															

Table A6-20 shows the allocation of encodings in this space. Other encodings in this space are UNDEFINED.

These encodings are all available in ARMv6T2 and above.

**Table A6-20 Load byte, memory hints**

op1	op2	Rn	Rt	Instruction	See
00	000000	not 1111	not 1111	Load Register Byte	<a href="#">LDRB (register) on page A8-422</a>
			1111	Preload Data	<a href="#">PLD, PLDW (register) on page A8-528</a>
0x	-	1111	not 1111	Load Register Byte	<a href="#">LDRB (literal) on page A8-420</a>
			1111	Preload Data	<a href="#">PLD (literal) on page A8-526</a>
00	1xx1xx	not 1111	-	Load Register Byte	<a href="#">LDRB (immediate, Thumb) on page A8-416</a>
	1100xx	not 1111	not 1111	Load Register Byte	
			1111	Preload Data	<a href="#">PLD, PLDW (immediate) on page A8-524</a>
1110xx	not 1111	-	Load Register Byte Unprivileged	<a href="#">LDRBT on page A8-424</a>	
01	-	not 1111	not 1111	Load Register Byte	<a href="#">LDRB (immediate, Thumb) on page A8-416</a>
			1111	Preload Data	<a href="#">PLD, PLDW (immediate) on page A8-524</a>
10	000000	not 1111	not 1111	Load Register Signed Byte	<a href="#">LDRSB (register) on page A8-454</a>
			1111	Preload Instruction	<a href="#">PLI (register) on page A8-532</a>
1x	-	1111	not 1111	Load Register Signed Byte	<a href="#">LDRSB (literal) on page A8-452</a>
			1111	Preload Instruction	<a href="#">PLI (immediate, literal) on page A8-530</a>
10	1xx1xx	not 1111	-	Load Register Signed Byte	<a href="#">LDRSB (immediate) on page A8-450</a>
	1100xx	not 1111	not 1111	Load Register Signed Byte	<a href="#">LDRSB (immediate) on page A8-450</a>
			1111	Preload Instruction	<a href="#">PLI (immediate, literal) on page A8-530</a>
1110xx	not 1111	-	Load Register Signed Byte Unprivileged	<a href="#">LDRSBT on page A8-456</a>	
11	-	not 1111	not 1111	Load Register Signed Byte	<a href="#">LDRSB (immediate) on page A8-450</a>
			1111	Preload Instruction	<a href="#">PLI (immediate, literal) on page A8-530</a>

### A6.3.10 Store single data item

The encoding of 32-bit Thumb store single data item instructions is:

15	14	13	12	11	10	9	8	7	6	5	4	3	2	1	0	15	14	13	12	11	10	9	8	7	6	5	4	3	2	1	0
1	1	1	1	1	0	0	0	op1	0													op2									

Table A6-21 show the allocation of encodings in this space. Other encodings in this space are UNDEFINED.

These encodings are all available in ARMv6T2 and above.

**Table A6-21 Store single data item**

op1	op2	Instruction	See
000	1xx1xx 1100xx	Store Register Byte	<a href="#">STRB (immediate, Thumb) on page A8-678</a>
100	-		
000	000000 1110xx	Store Register Byte Store Register Byte Unprivileged	<a href="#">STRB (register) on page A8-682</a> <a href="#">STRBT on page A8-684</a>
001	1xx1xx 1100xx	Store Register Halfword	<a href="#">STRH (immediate, Thumb) on page A8-698</a>
101	-		
001	000000 1110xx	Store Register Halfword Store Register Halfword Unprivileged	<a href="#">STRH (register) on page A8-702</a> <a href="#">STRHT on page A8-704</a>
010	1xx1xx 1100xx	Store Register	<a href="#">STR (immediate, Thumb) on page A8-672</a>
110	-		
010	000000 1110xx	Store Register Store Register Unprivileged	<a href="#">STR (register) on page A8-676</a> <a href="#">STRT on page A8-706</a>

### A6.3.11 Data-processing (shifted register)

The encoding of 32-bit Thumb data-processing (shifted register) instructions is:

15	14	13	12	11	10	9	8	7	6	5	4	3	2	1	0	15	14	13	12	11	10	9	8	7	6	5	4	3	2	1	0
1	1	1	0	1	0	1		op		S		Rn									Rd										

Table A6-22 shows the allocation of encodings in this space. Other encodings in this space are UNDEFINED.

These encodings are all available in ARMv6T2 and above.

**Table A6-22 Data-processing (shifted register)**

op	Rn	Rd:S	Instruction	See
0000	-	not 11111	Bitwise AND	<a href="#">AND (register) on page A8-326</a>
		11111	Test	<a href="#">TST (register) on page A8-746</a>
0001	-	-	Bitwise Bit Clear	<a href="#">BIC (register) on page A8-342</a>
0010	not 1111	-	Bitwise OR	<a href="#">ORR (register) on page A8-518</a>
		1111	-	<a href="#">Move register and immediate shifts on page A6-244</a>
0011	not 1111	-	Bitwise OR NOT	<a href="#">ORN (register) on page A8-514</a>
		1111	-	<a href="#">MVN (register) on page A8-506</a>
0100	-	not 11111	Bitwise Exclusive OR	<a href="#">EOR (register) on page A8-384</a>
		11111	Test Equivalence	<a href="#">TEQ (register) on page A8-740</a>
0110	-	-	Pack Halfword	<a href="#">PKH on page A8-522</a>
1000	-	not 11111	Add	<a href="#">ADD (register; Thumb) on page A8-310</a>
		11111	Compare Negative	<a href="#">CMN (register) on page A8-366</a>
1010	-	-	Add with Carry	<a href="#">ADC (register) on page A8-302</a>
1011	-	-	Subtract with Carry	<a href="#">SBC (register) on page A8-594</a>
1101	-	not 11111	Subtract	<a href="#">SUB (register) on page A8-712</a>
		11111	Compare	<a href="#">CMP (register) on page A8-372</a>
1110	-	-	Reverse Subtract	<a href="#">RSB (register) on page A8-576</a>

### Move register and immediate shifts

The encoding of the 32-bit Thumb move register and immediate shift instructions is:

15	14	13	12	11	10	9	8	7	6	5	4	3	2	1	0	15	14	13	12	11	10	9	8	7	6	5	4	3	2	1	0														
1	1	1	0	1	0	1	0	0	1	0		1	1	1	1		imm3														imm2	type													

Table A6-23 shows the allocation of encodings in this space.

These encodings are all available in ARMv6T2 and above.

**Table A6-23 Move register and immediate shifts**

type	imm3:imm2	Instruction	See
00	00000	Move	<i>MOV (register, Thumb)</i> on page A8-486
	not 00000	Logical Shift Left	<i>LSL (immediate)</i> on page A8-468
01	-	Logical Shift Right	<i>LSR (immediate)</i> on page A8-472
10	-	Arithmetic Shift Right	<i>ASR (immediate)</i> on page A8-330
11	00000	Rotate Right with Extend	<i>RRX</i> on page A8-572
	not 00000	Rotate Right	<i>ROR (immediate)</i> on page A8-568



### A6.3.12 Data-processing (register)

The encoding of 32-bit Thumb data-processing (register) instructions is:

15	14	13	12	11	10	9	8	7	6	5	4	3	2	1	0	15	14	13	12	11	10	9	8	7	6	5	4	3	2	1	0
1	1	1	1	1	0	1	0	op1				Rn				1	1	1	1					op2							

If, in the second halfword of the instruction, bits[15:12] != 0b1111, the instruction is UNDEFINED.

Table A6-24 shows the allocation of encodings in this space. Other encodings in this space are UNDEFINED.

These encodings are all available in ARMv6T2 and above.

**Table A6-24 Data-processing (register)**

op1	op2	Rn	Instruction	See
000x	0000	-	Logical Shift Left	<i>LSL (register)</i> on page A8-470
001x	0000	-	Logical Shift Right	<i>LSR (register)</i> on page A8-474
010x	0000	-	Arithmetic Shift Right	<i>ASR (register)</i> on page A8-332
011x	0000	-	Rotate Right	<i>ROR (register)</i> on page A8-570
0000	1xxx	not 1111	Signed Extend and Add Halfword	<i>SXTAH</i> on page A8-728
		1111	Signed Extend Halfword	<i>SXTH</i> on page A8-734
0001	1xxx	not 1111	Unsigned Extend and Add Halfword	<i>UXTAH</i> on page A8-810
		1111	Unsigned Extend Halfword	<i>UXTH</i> on page A8-816
0010	1xxx	not 1111	Signed Extend and Add Byte 16-bit	<i>SXTAB16</i> on page A8-726
		1111	Signed Extend Byte 16-bit	<i>SXTB16</i> on page A8-732
0011	1xxx	not 1111	Unsigned Extend and Add Byte 16-bit	<i>UXTAB16</i> on page A8-808
		1111	Unsigned Extend Byte 16-bit	<i>UXTB16</i> on page A8-814
0100	1xxx	not 1111	Signed Extend and Add Byte	<i>SXTAB</i> on page A8-724
		1111	Signed Extend Byte	<i>SXTB</i> on page A8-730
0101	1xxx	not 1111	Unsigned Extend and Add Byte	<i>UXTAB</i> on page A8-806
		1111	Unsigned Extend Byte	<i>UXTB</i> on page A8-812
1xxx	00xx	-	-	<i>Parallel addition and subtraction, signed</i> on page A6-246
1xxx	01xx	-	-	<i>Parallel addition and subtraction, unsigned</i> on page A6-247
10xx	10xx	-	-	<i>Miscellaneous operations</i> on page A6-248

### A6.3.13 Parallel addition and subtraction, signed

The encoding of 32-bit Thumb signed parallel addition and subtraction instructions is:

15	14	13	12	11	10	9	8	7	6	5	4	3	2	1	0	15	14	13	12	11	10	9	8	7	6	5	4	3	2	1	0					
1	1	1	1	1	0	1	0	1	op1												1	1	1	1							0	0	op2			

If, in the second halfword of the instruction, bits[15:12] != 0b1111, the instruction is UNDEFINED.

Table A6-25 shows the allocation of encodings in this space. Other encodings in this space are UNDEFINED. These encodings are all available in ARMv6T2 and above.

**Table A6-25 Signed parallel addition and subtraction instructions**

op1	op2	Instruction	See
001	00	Add 16-bit	<a href="#">SADD16 on page A8-586</a>
010	00	Add and Subtract with Exchange, 16-bit	<a href="#">SASX on page A8-590</a>
110	00	Subtract and Add with Exchange, 16-bit	<a href="#">SSAX on page A8-656</a>
101	00	Subtract 16-bit	<a href="#">SSUB16 on page A8-658</a>
000	00	Add 8-bit	<a href="#">SADD8 on page A8-588</a>
100	00	Subtract 8-bit	<a href="#">SSUB8 on page A8-660</a>
Saturating instructions			
001	01	Saturating Add 16-bit	<a href="#">QADD16 on page A8-542</a>
010	01	Saturating Add and Subtract with Exchange, 16-bit	<a href="#">QASX on page A8-546</a>
110	01	Saturating Subtract and Add with Exchange, 16-bit	<a href="#">QSAX on page A8-552</a>
101	01	Saturating Subtract 16-bit	<a href="#">QSUB16 on page A8-556</a>
000	01	Saturating Add 8-bit	<a href="#">QADD8 on page A8-544</a>
100	01	Saturating Subtract 8-bit	<a href="#">QSUB8 on page A8-558</a>
Halving instructions			
001	10	Halving Add 16-bit	<a href="#">SHADD16 on page A8-608</a>
010	10	Halving Add and Subtract with Exchange, 16-bit	<a href="#">SHASX on page A8-612</a>
110	10	Halving Subtract and Add with Exchange, 16-bit	<a href="#">SHSAX on page A8-614</a>
101	10	Halving Subtract 16-bit	<a href="#">SHSUB16 on page A8-616</a>
000	10	Halving Add 8-bit	<a href="#">SHADD8 on page A8-610</a>
100	10	Halving Subtract 8-bit	<a href="#">SHSUB8 on page A8-618</a>

### A6.3.14 Parallel addition and subtraction, unsigned

The encoding of 32-bit Thumb unsigned parallel addition and subtraction instructions is:

15	14	13	12	11	10	9	8	7	6	5	4	3	2	1	0	15	14	13	12	11	10	9	8	7	6	5	4	3	2	1	0
1	1	1	1	1	0	1	0	1	op1						1	1	1	1	op2												

If, in the second halfword of the instruction, bits[15:12] != 0b1111, the instruction is UNDEFINED.

Table A6-26 shows the allocation of encodings in this space. Other encodings in this space are UNDEFINED. These encodings are all available in ARMv6T2 and above.

**Table A6-26 Unsigned parallel addition and subtraction instructions**

op1	op2	Instruction	See
001	00	Add 16-bit	<a href="#">UADD16 on page A8-750</a>
010	00	Add and Subtract with Exchange, 16-bit	<a href="#">UASX on page A8-754</a>
110	00	Subtract and Add with Exchange, 16-bit	<a href="#">USAX on page A8-800</a>
101	00	Subtract 16-bit	<a href="#">USUB16 on page A8-802</a>
000	00	Add 8-bit	<a href="#">UADD8 on page A8-752</a>
100	00	Subtract 8-bit	<a href="#">USUB8 on page A8-804</a>
Saturating instructions			
001	01	Saturating Add 16-bit	<a href="#">UQADD16 on page A8-780</a>
010	01	Saturating Add and Subtract with Exchange, 16-bit	<a href="#">UQASX on page A8-784</a>
110	01	Saturating Subtract and Add with Exchange, 16-bit	<a href="#">UQSAX on page A8-786</a>
101	01	Saturating Subtract 16-bit	<a href="#">UQSUB16 on page A8-788</a>
000	01	Saturating Add 8-bit	<a href="#">UQADD8 on page A8-782</a>
100	01	Saturating Subtract 8-bit	<a href="#">UQSUB8 on page A8-790</a>
Halving instructions			
001	10	Halving Add 16-bit	<a href="#">UHADD16 on page A8-762</a>
010	10	Halving Add and Subtract with Exchange, 16-bit	<a href="#">UHASX on page A8-766</a>
110	10	Halving Subtract and Add with Exchange, 16-bit	<a href="#">UHSAX on page A8-768</a>
101	10	Halving Subtract 16-bit	<a href="#">UHSUB16 on page A8-770</a>
000	10	Halving Add 8-bit	<a href="#">UHADD8 on page A8-764</a>
100	10	Halving Subtract 8-bit	<a href="#">UHSUB8 on page A8-772</a>

### A6.3.15 Miscellaneous operations

The encoding of some 32-bit Thumb miscellaneous instructions is:

15	14	13	12	11	10	9	8	7	6	5	4	3	2	1	0	15	14	13	12	11	10	9	8	7	6	5	4	3	2	1	0
1	1	1	1	1	0	1	0	1	0	op1						1	1	1	1					1	0	op2					

If, in the second halfword of the instruction, bits[15:12] != 0b1111, the instruction is UNDEFINED.

Table A6-27 shows the allocation of encodings in this space. Other encodings in this space are UNDEFINED. These encodings are all available in ARMv6T2 and above.

**Table A6-27 Miscellaneous operations**

op1	op2	Instruction	See
00	00	Saturating Add	<a href="#">QADD on page A8-540</a>
	01	Saturating Double and Add	<a href="#">QDADD on page A8-548</a>
	10	Saturating Subtract	<a href="#">QSUB on page A8-554</a>
	11	Saturating Double and Subtract	<a href="#">QDSUB on page A8-550</a>
01	00	Byte-Reverse Word	<a href="#">REV on page A8-562</a>
	01	Byte-Reverse Packed Halfword	<a href="#">REV16 on page A8-564</a>
	10	Reverse Bits	<a href="#">RBIT on page A8-560</a>
	11	Byte-Reverse Signed Halfword	<a href="#">REVSH on page A8-566</a>
10	00	Select Bytes	<a href="#">SEL on page A8-602</a>
11	00	Count Leading Zeros	<a href="#">CLZ on page A8-362</a>

### A6.3.16 Multiply, multiply accumulate, and absolute difference

The encoding of 32-bit Thumb multiply, multiply accumulate, and absolute difference instructions is:

15	14	13	12	11	10	9	8	7	6	5	4	3	2	1	0	15	14	13	12	11	10	9	8	7	6	5	4	3	2	1	0
1	1	1	1	1	0	1	1	0	op1						Ra						0 0		op2								

If, in the second halfword of the instruction, bits[7:6] != 0b00, the instruction is UNDEFINED.

Table A6-28 shows the allocation of encodings in this space. Other encodings in this space are UNDEFINED. These encodings are all available in ARMv6T2 and above.

**Table A6-28 Multiply, multiply accumulate, and absolute difference operations**

op1	op2	Ra	Instruction	See
000	00	not 1111	Multiply Accumulate	<a href="#">MLA on page A8-480</a>
		1111	Multiply	<a href="#">MUL on page A8-502</a>
	01	-	Multiply and Subtract	<a href="#">MLS on page A8-482</a>
001	-	not 1111	Signed Multiply Accumulate (Halfwords)	<a href="#">SMLABB, SMLABT, SMLATB, SMLATT on page A8-620</a>
		1111	Signed Multiply (Halfwords)	<a href="#">SMULBB, SMULBT, SMULTB, SMULTT on page A8-644</a>
010	0x	not 1111	Signed Multiply Accumulate Dual	<a href="#">SMLAD on page A8-622</a>
		1111	Signed Dual Multiply Add	<a href="#">SMUAD on page A8-642</a>
011	0x	not 1111	Signed Multiply Accumulate (Word by halfword)	<a href="#">SMLAWB, SMLAWT on page A8-630</a>
		1111	Signed Multiply (Word by halfword)	<a href="#">SMULWB, SMULWT on page A8-648</a>
100	0x	not 1111	Signed Multiply Subtract Dual	<a href="#">SMLSD on page A8-632</a>
		1111	Signed Dual Multiply Subtract	<a href="#">SMUSD on page A8-650</a>
101	0x	not 1111	Signed Most Significant Word Multiply Accumulate	<a href="#">SMMLA on page A8-636</a>
		1111	Signed Most Significant Word Multiply	<a href="#">SMMUL on page A8-640</a>
110	0x	-	Signed Most Significant Word Multiply Subtract	<a href="#">SMMLS on page A8-638</a>
111	00	not 1111	Unsigned Sum of Absolute Differences, Accumulate	<a href="#">USADA8 on page A8-794</a>
		1111	Unsigned Sum of Absolute Differences	<a href="#">USAD8 on page A8-792</a>

### A6.3.17 Long multiply, long multiply accumulate, and divide

The encoding of 32-bit Thumb long multiply, long multiply accumulate, and divide instructions is:

15	14	13	12	11	10	9	8	7	6	5	4	3	2	1	0	15	14	13	12	11	10	9	8	7	6	5	4	3	2	1	0
1	1	1	1	1	0	1	1	1	op1								op2														

Table A6-29 shows the allocation of encodings in this space. Other encodings in this space are UNDEFINED.

**Table A6-29 Multiply, multiply accumulate, and absolute difference operations**

op1	op2	Instruction	See	Variant
000	0000	Signed Multiply Long	<a href="#">SMULL on page A8-646</a>	v6T2
001	1111	Signed Divide	<a href="#">SDIV on page A8-600</a>	v7-R <sup>a</sup>
010	0000	Unsigned Multiply Long	<a href="#">UMULL on page A8-778</a>	v6T2
011	1111	Unsigned Divide	<a href="#">UDIV on page A8-760</a>	v7-R <sup>a</sup>
100	0000	Signed Multiply Accumulate Long	<a href="#">SMLAL on page A8-624</a>	v6T2
	10xx	Signed Multiply Accumulate Long (Halfwords)	<a href="#">SMLALBB, SMLALBT, SMLALTB, SMLALTT on page A8-626</a>	v6T2
	110x	Signed Multiply Accumulate Long Dual	<a href="#">SMLALD on page A8-628</a>	v6T2
101	110x	Signed Multiply Subtract Long Dual	<a href="#">SMLS LD on page A8-634</a>	v6T2
110	0000	Unsigned Multiply Accumulate Long	<a href="#">UMLAL on page A8-776</a>	v6T2
	0110	Unsigned Multiply Accumulate Accumulate Long	<a href="#">UMAAL on page A8-774</a>	v6T2

a. Optional in some ARMv7 implementations, see [ARMv7 implementation requirements and options for the divide instructions on page A4-172](#).

### A6.3.18 Coprocessor, Advanced SIMD, and Floating-point instructions

The encoding of 32-bit Thumb coprocessor instructions is:

15	14	13	12	11	10	9	8	7	6	5	4	3	2	1	0	15	14	13	12	11	10	9	8	7	6	5	4	3	2	1	0
1	1	1		1	1																										
																coproc				op											

Table A6-30 shows the allocation of encodings in this space. These encodings are all available in ARMv6T2 and above:

**Table A6-30 Coprocessor, Advanced SIMD, and Floating-point instructions**

coproc	op1	op	Rn	Instructions	See
-	00000x	-	-	UNDEFINED	-
	11xxxx	-	-	Advanced SIMD	<i>Advanced SIMD data-processing instructions on page A7-261</i>
not 101x	0xxxx0 not 000x0x	-	-	Store Coprocessor	<i>STC, STC2 on page A8-662</i>
	0xxxx1 not 000x0x	-	not 1111	Load Coprocessor (immediate)	<i>LDC, LDC2 (immediate) on page A8-392</i>
			1111	Load Coprocessor (literal)	<i>LDC, LDC2 (literal) on page A8-394</i>
	000100	-	-	Move to Coprocessor from two ARM core registers	<i>MCRR, MCRR2 on page A8-478</i>
	000101	-	-	Move to two ARM core registers from Coprocessor	<i>MRRC, MRRC2 on page A8-494</i>
	10xxxx	0	-	Coprocessor data operations	<i>CDP, CDP2 on page A8-358</i>
	10xxx0	1	-	Move to Coprocessor from ARM core register	<i>MCR, MCR2 on page A8-476</i>
	10xxx1	1	-	Move to ARM core register from Coprocessor	<i>MRC, MRC2 on page A8-492</i>
101x	0xxxxx not 000x0x	-	-	Advanced SIMD, Floating-point	<i>Extension register load/store instructions on page A7-274</i>
	00010x	-	-	Advanced SIMD, Floating-point	<i>64-bit transfers between ARM core and extension registers on page A7-279</i>
	10xxxx	0	-	Floating-point data processing	<i>Floating-point data-processing instructions on page A7-272</i>
	10xxxx	1	-	Advanced SIMD, Floating-point	<i>8, 16, and 32-bit transfer between ARM core and extension registers on page A7-278</i>

For more information about specific coprocessors see *Coprocessor support* on page A2-94.





# Chapter A7

## Advanced SIMD and Floating-point Instruction Encoding

This chapter gives an overview of the Advanced SIMD and Floating-point (VFP) instruction sets. It contains the following sections:

- [Overview on page A7-254](#)
- [Advanced SIMD and Floating-point instruction syntax on page A7-255](#)
- [Register encoding on page A7-259](#)
- [Advanced SIMD data-processing instructions on page A7-261](#)
- [Floating-point data-processing instructions on page A7-272](#)
- [Extension register load/store instructions on page A7-274](#)
- [Advanced SIMD element or structure load/store instructions on page A7-275](#)
- [8, 16, and 32-bit transfer between ARM core and extension registers on page A7-278](#)
- [64-bit transfers between ARM core and extension registers on page A7-279.](#)

---

### Note

- The Advanced SIMD architecture extension, its associated implementations, and supporting software, are commonly referred to as NEON™ technology.
  - In the decode tables in this chapter, an entry of - for a field value means the value of the field does not affect the decoding.
-

## A7.1 Overview

All Advanced SIMD and Floating-point instructions are available in both ARM state and Thumb state.

### A7.1.1 Advanced SIMD

The following sections describe the classes of instruction in the Advanced SIMD Extension:

- [Advanced SIMD data-processing instructions on page A7-261](#)
- [Advanced SIMD element or structure load/store instructions on page A7-275](#)
- [Extension register load/store instructions on page A7-274](#)
- [8, 16, and 32-bit transfer between ARM core and extension registers on page A7-278](#)
- [64-bit transfers between ARM core and extension registers on page A7-279.](#)

### A7.1.2 Floating-point

The following sections describe the classes of instruction in the Floating-point Extension:

- [Extension register load/store instructions on page A7-274](#)
- [8, 16, and 32-bit transfer between ARM core and extension registers on page A7-278](#)
- [64-bit transfers between ARM core and extension registers on page A7-279](#)
- [Floating-point data-processing instructions on page A7-272.](#)

## A7.2 Advanced SIMD and Floating-point instruction syntax

Advanced SIMD and Floating-point (VFP) instructions use the general conventions of the ARM instruction set.

Advanced SIMD and Floating-point data-processing instructions use the following general format:

V{<modifier>}<operation>{<shape>}{<c>}{<q>}{. <dt>} {<dest>}, <src1>, <src2>

All Advanced SIMD and Floating-point instructions begin with a V. This distinguishes Advanced SIMD vector and Floating-point instructions from ARM scalar instructions.

The main operation is specified in the <operation> field. It is usually a three letter mnemonic the same as or similar to the corresponding scalar integer instruction.

The <c> and <q> fields are standard assembler syntax fields. For details see [Standard assembler syntax fields on page A8-287](#).

### A7.2.1 Advanced SIMD instruction modifiers

The <modifier> field provides additional variants of some instructions. [Table A7-1](#) provides definitions of the modifiers. Modifiers are not available for every instruction.

**Table A7-1 Advanced SIMD instruction modifiers**

<modifier>	Meaning
Q	The operation uses saturating arithmetic.
R	The operation performs rounding.
D	The operation doubles the result (before accumulation, if any).
H	The operation halves the result.

### A7.2.2 Advanced SIMD operand shapes

The <shape> field provides additional variants of some instructions. [Table A7-2](#) provides definitions of the shapes. Operand shapes are not available for every instruction.

**Table A7-2 Advanced SIMD operand shapes**

<shape>	Meaning	Typical register shape
(none)	The operands and result are all the same width.	Dd, Dn, Dm    Qd, Qn, Qm
L	Long operation - result is twice the width of both operands	Qd, Dn, Dm
N	Narrow operation - result is half the width of both operands	Dd, Qn, Qm
W	Wide operation - result and first operand are twice the width of the second operand	Qd, Qn, Dm

———— **Note** ————

- Some assemblers support a Q shape specifier, that requires all operands to be Q registers. An example of using this specifier is `VADDQ.S32 q0, q1, q2`. This is not standard UAL, and ARM recommends that programmers do not use a Q shape specifier.
- A disassembler must not generate any shape specifier not shown in [Table A7-2](#).

### A7.2.3 Data type specifiers

The <dt> field normally contains one data type specifier. Unless the assembler syntax description for the instruction indicates otherwise, this indicates the data type contained in:

- the second operand, if any
- the operand, if there is no second operand
- the result, if there are no operand registers.

The data types of the other operand and result are implied by the <dt> field combined with the instruction shape. For information about data type formats see [Data types supported by the Advanced SIMD Extension on page A2-59](#).

In the instruction syntax descriptions in [Chapter A8 Instruction Details](#), the <dt> field is usually specified as a single field. However, where more convenient, it is sometimes specified as a concatenation of two fields, <type><size>.

#### Syntax flexibility

There is some flexibility in the data type specifier syntax:

- Software can specify three data types, specifying the result and both operand data types. For example:  
VSUBW.I16.I16.S8 Q3, Q5, D0 instead of VSUBW.S8 Q3, Q5, D0
- Software can specify two data types, specifying the data types of the two operands. The data type of the result is implied by the instruction shape. For example:  
VSUBW.I16.S8 Q3, Q5, D0 instead of VSUBW.S8 Q3, Q5, D0
- Software can specify two data types, specifying the data types of the single operand and the result. For example:  
VMOVN.I16.I32 D0, Q1 instead of VMOVN.I32 D0, Q1
- Where an instruction requires a less specific data type, software can instead specify a more specific type, as shown in [Table A7-3](#).
- Where an instruction does not require a data type, software can provide one.
- The F32 data type can be abbreviated to F.
- The F64 data type can be abbreviated to D.

In all cases, if software provides additional information, the additional information must match the instruction shape. Disassembly does not regenerate this additional information.

**Table A7-3 Data type specification flexibility**

Specified data type	Permitted more specific data types				
	None	Any			
.I<size>	-	.S<size>	.U<size>	-	-
.8	.I8	.S8	.U8	.P8	-
.16	.I16	.S16	.U16	.P16	.F16
.32	.I32	.S32	.U32	-	.F32 or .F
.64	.I64	.S64	.U64	-	.F64 or .D

## A7.2.4 Register specifiers

The <dest>, <src1>, and <src2> fields contain register specifiers, or in some cases scalar specifiers or register lists. [Table A7-4](#) shows the register and scalar specifier formats that appear in the instruction descriptions.

If <dest> is omitted, it is the same as <src1>.

**Table A7-4 Advanced SIMD and Floating-point register specifier formats**

<b>&lt;specifier&gt;</b>	<b>Usual meaning <sup>a</sup></b>	<b>Used in</b>
<Qd>	A quadword destination register for the result vector.	Advanced SIMD
<Qn>	A quadword source register for the first operand vector.	Advanced SIMD
<Qm>	A quadword source register for the second operand vector.	Advanced SIMD
<Dd>	A doubleword destination register for the result vector.	Both
<Dn>	A doubleword source register for the first operand vector.	Both
<Dm>	A doubleword source register for the second operand vector.	Both
<Sd>	A singleword destination register for the result vector.	Floating-point
<Sn>	A singleword source register for the first operand vector.	Floating-point
<Sm>	A singleword source register for the second operand vector.	Floating-point
<Dd[x]>	A destination scalar for the result. Element x of vector <Dd>.	Advanced SIMD
<Dn[x]>	A source scalar for the first operand. Element x of vector <Dn>.	Both <sup>b</sup>
<Dm[x]>	A source scalar for the second operand. Element x of vector <Dm>.	Advanced SIMD
<Rt>	An ARM core register, used for a source or destination address.	Both
<Rt2>	An ARM core register, used for a source or destination address.	Both
<Rn>	An ARM core register, used as a load or store base address.	Both
<Rm>	An ARM core register, used as a post-indexed address source.	Both

a. In some instructions the roles of registers are different.

b. In the Floating-point Extension, <Dn[x]> is used only in *VMOV* (scalar to ARM core register), see *VMOV (scalar to ARM core register)* on page A8-942.

## A7.2.5 Register lists

A register list is a list of register specifiers separated by commas and enclosed in brackets { and }. There are restrictions on what registers can appear in a register list. These restrictions are described in the individual instruction descriptions. Table A7-5 shows some register list formats, with examples of actual register lists corresponding to those formats.

———— **Note** —————

Register lists must not wrap around the end of the register bank.

---

### Syntax flexibility

There is some flexibility in the register list syntax:

- Where a register list contains consecutive registers, they can be specified as a range, instead of listing every register, for example {D0-D3} instead of {D0, D1, D2, D3}.
- Where a register list contains an even number of consecutive doubleword registers starting with an even numbered register, it can be written as a list of quadword registers instead, for example {Q1, Q2} instead of {D2-D5}.
- Where a register list contains only one register, the enclosing braces can be omitted, for example VLD1.8 D0, [R0] instead of VLD1.8 {D0}, [R0].

**Table A7-5 Example register lists**

Format	Example	Alternative
{<Dd>}	{D3}	D3
{<Dd>, <Dd+1>, <Dd+2>}	{D3, D4, D5}	{D3-D5}
{<Dd[x]>, <Dd+2[x]>}	{D0[3], D2[3]}	-
{<Dd[ ]>}	{D7[ ]}	D7[ ]

## A7.3 Register encoding

An Advanced SIMD register is either:

- *quadword*, meaning it is 128 bits wide
- *doubleword*, meaning it is 64 bits wide.

Some instructions have options for either doubleword or quadword registers. This is normally encoded in Q, bit[6], as Q = 0 for doubleword operations, or Q = 1 for quadword operations.

A Floating-point register is either:

- *double-precision*, meaning it is 64 bits wide
- *single-precision*, meaning it is 32 bits wide.

This is encoded in the sz field, bit[8], as sz = 1 for double-precision operations, or sz = 0 for single-precision operations.

The Thumb instruction encoding of Advanced SIMD or Floating-point registers is:

15	14	13	12	11	10	9	8	7	6	5	4	3	2	1	0	15	14	13	12	11	10	9	8	7	6	5	4	3	2	1	0
										D	Vn					Vd					sz	N	Q	M	Vm						

The ARM instruction encoding of Advanced SIMD or Floating-point registers is:

31	30	29	28	27	26	25	24	23	22	21	20	19	18	17	16	15	14	13	12	11	10	9	8	7	6	5	4	3	2	1	0
										D	Vn					Vd					sz	N	Q	M	Vm						

Some instructions use only one or two registers, and use the unused register fields as additional opcode bits.

Table A7-6 shows the encodings for the registers.

**Table A7-6 Encoding of register numbers**

Register mnemonic	Usual usage	Register number encoded in <sup>a</sup>	Notes <sup>a</sup>	Used in
<Qd>	Destination (quadword)	D, Vd (bits[22, 15:13])	bit[12] == 0 <sup>b</sup>	Advanced SIMD
<Qn>	First operand (quadword)	N, Vn (bits[7, 19:17])	bit[16] == 0 <sup>b</sup>	Advanced SIMD
<Qm>	Second operand (quadword)	M, Vm (bits[5, 3:1])	bit[0] == 0 <sup>b</sup>	Advanced SIMD
<Dd>	Destination (doubleword)	D, Vd (bits[22, 15:12])	-	Both
<Dn>	First operand (doubleword)	N, Vn (bits[7, 19:16])	-	Both
<Dm>	Second operand (doubleword)	M, Vm (bits[5, 3:0])	-	Both
<Sd>	Destination (single-precision)	Vd, D (bits[15:12, 22])	-	Floating-point
<Sn>	First operand (single-precision)	Vn, N (bits[19:16, 7])	-	Floating-point
<Sm>	Second operand (single-precision)	Vm, M (bits[3:0, 5])	-	Floating-point

a. Bit numbers given for the ARM instruction encoding. See the figures in this section for the equivalent bits in the Thumb encoding.

b. If this bit is 1, the instruction is UNDEFINED.

### A7.3.1 Advanced SIMD scalars

Advanced SIMD scalars can be 8-bit, 16-bit, 32-bit, or 64-bit. Instructions other than multiply instructions can access any element in the register set. The instruction syntax refers to the scalars using an index into a doubleword vector. The descriptions of the individual instructions contain details of the encodings.

Table A7-7 shows the form of encoding for scalars used in multiply instructions. These instructions cannot access scalars in some registers. The descriptions of the individual instructions contain cross references to this section where appropriate.

32-bit Advanced SIMD scalars, when used as single-precision floating-point numbers, are equivalent to Floating-point single-precision registers. That is,  $D_m[x]$  in a 32-bit context ( $0 \leq m \leq 15, 0 \leq x \leq 1$ ) is equivalent to  $S[2m + x]$ .

**Table A7-7 Encoding of scalars in multiply instructions**

Scalar mnemonic	Usual usage	Scalar size	Register specifier	Index specifier	Accessible registers
< $D_m[x]$ >	Second operand	16-bit	$V_m[2:0]$	M, $V_m[3]$	D0-D7
		32-bit	$V_m[3:0]$	M	D0-D15



## A7.4 Advanced SIMD data-processing instructions

The Thumb encoding of Advanced SIMD data processing instructions is:

15	14	13	12	11	10	9	8	7	6	5	4	3	2	1	0	15	14	13	12	11	10	9	8	7	6	5	4	3	2	1	0
1	1	1	U	1	1	1	1	A								B				C											

The ARM encoding of Advanced SIMD data processing instructions is:

31	30	29	28	27	26	25	24	23	22	21	20	19	18	17	16	15	14	13	12	11	10	9	8	7	6	5	4	3	2	1	0
1	1	1	1	0	0	1	U	A												B				C							

Table A7-8 shows the encoding for Advanced SIMD data-processing instructions. Other encodings in this space are UNDEFINED.

In these instructions, the U bit is in a different location in ARM and Thumb instructions. This is bit[12] of the first halfword in the Thumb encoding, and bit[24] in the ARM encoding. Other variable bits are in identical locations in the two encodings, after adjusting for the fact that the ARM encoding is held in memory as a single word and the Thumb encoding is held as two consecutive halfwords.

The ARM instructions can only be executed unconditionally. The Thumb instructions can be executed conditionally by using the IT instruction. For details see *IT* on page A8-390.

**Table A7-8 Data-processing instructions**

U	A	B	C	See
-	0xxxx	-	-	<i>Three registers of the same length on page A7-262</i>
	1x000	-	0xx1	<i>One register and a modified immediate value on page A7-269</i>
	1x001	-	0xx1	<i>Two registers and a shift amount on page A7-266</i>
	1x01x	-	0xx1	
	1x1xx	-	0xx1	
	1xxxx	-	1xx1	
	1x0xx	-	x0x0	<i>Three registers of different lengths on page A7-264</i>
	1x10x	-	x0x0	
	1x0xx	-	x1x0	<i>Two registers and a scalar on page A7-265</i>
	1x10x	-	x1x0	
0	1x11x	-	xxx0	Vector Extract, <i>VEXT</i> on page A8-890
1	1x11x	0xxx	xxx0	<i>Two registers, miscellaneous on page A7-267</i>
		10xx	xxx0	Vector Table Lookup, <i>VTBL</i> , <i>VTBX</i> on page A8-1094
		1100	0xx0	Vector Duplicate, <i>VDUP (scalar)</i> on page A8-884

### A7.4.1 Three registers of the same length

The Thumb encoding of these instructions is:

15	14	13	12	11	10	9	8	7	6	5	4	3	2	1	0	15	14	13	12	11	10	9	8	7	6	5	4	3	2	1	0
1	1	1	U	1	1	1	1	0		C						A								B							

The ARM encoding of these instructions is:

31	30	29	28	27	26	25	24	23	22	21	20	19	18	17	16	15	14	13	12	11	10	9	8	7	6	5	4	3	2	1	0	
1	1	1	1	0	0	1	U	0		C														A					B			

Table A7-9 shows the allocation of encodings in this space. Other encodings in this space are UNDEFINED.

**Table A7-9 Three registers of the same length**

A	B	U	C	Instruction	See	Variant <sup>a</sup>
0000	0	-	-	Vector Halving Add	<i>VHADD, VHSUB</i> on page A8-896	ASIMD
	1	-	-	Vector Saturating Add	<i>VQADD</i> on page A8-996	ASIMD
0001	0	-	-	Vector Rounding Halving Add	<i>VRHADD</i> on page A8-1030	ASIMD
	1	0	00	Vector Bitwise AND	<i>VAND (register)</i> on page A8-836	ASIMD
			01	Vector Bitwise Bit Clear, AND complement	<i>VBIC (register)</i> on page A8-840	ASIMD
			10	Vector Bitwise OR, if source registers differ	<i>VORR (register)</i> on page A8-976	ASIMD
				Vector Move, if source registers identical	<i>VMOV (register)</i> on page A8-938	ASIMD
11	Vector Bitwise OR NOT	<i>VORN (register)</i> on page A8-972	ASIMD			
0001	1	1	00	Vector Bitwise Exclusive OR	<i>VEOR</i> on page A8-888	ASIMD
			01	Vector Bitwise Select	<i>VBIF, VBIT, VBSL</i> on page A8-842	ASIMD
			10	Vector Bitwise Insert if True	<i>VBIF, VBIT, VBSL</i> on page A8-842	ASIMD
			11	Vector Bitwise Insert if False	<i>VBIF, VBIT, VBSL</i> on page A8-842	ASIMD
0010	0	-	-	Vector Halving Subtract	<i>VHADD, VHSUB</i> on page A8-896	ASIMD
	1	-	-	Vector Saturating Subtract	<i>VQSUB</i> on page A8-1020	ASIMD
0011	0	-	-	Vector Compare Greater Than	<i>VCGT (register)</i> on page A8-852	ASIMD
	1	-	-	Vector Compare Greater Than or Equal	<i>VCGE (register)</i> on page A8-848	ASIMD
0100	0	-	-	Vector Shift Left	<i>VSHL (register)</i> on page A8-1048	ASIMD
	1	-	-	Vector Saturating Shift Left	<i>VQSHL (register)</i> on page A8-1014	ASIMD
0101	0	-	-	Vector Rounding Shift Left	<i>VRSHL</i> on page A8-1032	ASIMD
	1	-	-	Vector Saturating Rounding Shift Left	<i>VQRSHL</i> on page A8-1010	ASIMD
0110	-	-	-	Vector Maximum or Minimum	<i>VMAX, VMIN (integer)</i> on page A8-926	ASIMD
0111	0	-	-	Vector Absolute Difference	<i>VABD, VABDL (integer)</i> on page A8-820	ASIMD
	1	-	-	Vector Absolute Difference and Accumulate	<i>VABA, VABAL</i> on page A8-818	ASIMD

**Table A7-9 Three registers of the same length (continued)**

<b>A</b>	<b>B</b>	<b>U</b>	<b>C</b>	<b>Instruction</b>	<b>See</b>	<b>Variant<sup>a</sup></b>	
1000	0	0	-	Vector Add	<i>VADD (integer)</i> on page A8-828	ASIMD	
			1	-	Vector Subtract	<i>VSUB (integer)</i> on page A8-1084	ASIMD
	1	0	-	Vector Test Bits	<i>VTST</i> on page A8-1098	ASIMD	
			1	-	Vector Compare Equal	<i>VCEQ (register)</i> on page A8-844	ASIMD
1001	0	-	-	Vector Multiply Accumulate or Subtract	<i>VMLA, VMLAL, VMLS, VMLSL (integer)</i> on page A8-930	ASIMD	
			1	-	Vector Multiply	<i>VMUL, VMULL (integer and polynomial)</i> on page A8-958	ASIMD
1010	-	-	-	Vector Pairwise Maximum or Minimum	<i>VPMAX, VPMIN (integer)</i> on page A8-986	ASIMD	
1011	0	0	-	Vector Saturating Doubling Multiply Returning High Half	<i>VQDMULH</i> on page A8-1000	ASIMD	
			1	-	Vector Saturating Rounding Doubling Multiply Returning High Half	<i>VQRDMULH</i> on page A8-1008	ASIMD
	1	0	-	Vector Pairwise Add	<i>VPADD (integer)</i> on page A8-980	ASIMD	
1100	1	0	-	Vector Fused Multiply Accumulate or Subtract	<i>VFMA, VFMS</i> on page A8-892	ASIMDv2	
1101	0	0	0x	Vector Add	<i>VADD (floating-point)</i> on page A8-830	ASIMD	
			1x	Vector Subtract	<i>VSUB (floating-point)</i> on page A8-1086	ASIMD	
		1	0x	Vector Pairwise Add	<i>VPADD (floating-point)</i> on page A8-982	ASIMD	
			1x	Vector Absolute Difference	<i>VABD (floating-point)</i> on page A8-822	ASIMD	
	1	0	-	Vector Multiply Accumulate or Subtract	<i>VMLA, VMLS (floating-point)</i> on page A8-932	ASIMD	
			1	0x	Vector Multiply	<i>VMUL (floating-point)</i> on page A8-960	ASIMD
1110	0	0	0x	Vector Compare Equal	<i>VCEQ (register)</i> on page A8-844	ASIMD	
			1	0x	Vector Compare Greater Than or Equal	<i>VCGE (register)</i> on page A8-848	ASIMD
			1x	Vector Compare Greater Than	<i>VCGT (register)</i> on page A8-852	ASIMD	
	1	1	-	Vector Absolute Compare Greater or Less Than (or Equal)	<i>VACGE, VACGT, VACLE, VACLTL</i> on page A8-826	ASIMD	
1111	0	0	-	Vector Maximum or Minimum	<i>VMAX, VMIN (floating-point)</i> on page A8-928	ASIMD	
			1	-	Vector Pairwise Maximum or Minimum	<i>VPMAX, VPMIN (floating-point)</i> on page A8-988	ASIMD
	1	0	0x	Vector Reciprocal Step	<i>VRECPS</i> on page A8-1026	ASIMD	
		0	1x	Vector Reciprocal Square Root Step	<i>VRSQRTS</i> on page A8-1040	ASIMD	

a. In this column, ASIMD indicates Advanced SIMD, and ASIMDv2 indicates Advanced SIMDv2.

### A7.4.2 Three registers of different lengths

The Thumb encoding of these instructions is:

15	14	13	12	11	10	9	8	7	6	5	4	3	2	1	0	15	14	13	12	11	10	9	8	7	6	5	4	3	2	1	0
1	1	1	U	1	1	1	1	1			B											A		0	0						

The ARM encoding of these instructions is:

31	30	29	28	27	26	25	24	23	22	21	20	19	18	17	16	15	14	13	12	11	10	9	8	7	6	5	4	3	2	1	0
1	1	1	1	0	0	1	U	1			B											A		0	0						

If B == 0b11, see [Advanced SIMD data-processing instructions on page A7-261](#).

Otherwise, [Table A7-10](#) shows the allocation of encodings in this space. Other encodings in this space are UNDEFINED.

**Table A7-10 Data-processing instructions with three registers of different lengths**

A	U	Instruction	See
000x	-	Vector Add Long or Wide	<a href="#">VADDL, VADDW on page A8-834</a>
001x	-	Vector Subtract Long or Wide	<a href="#">VSUBL, VSUBW on page A8-1090</a>
0100	0	Vector Add and Narrow, returning High Half	<a href="#">VADDHN on page A8-832</a>
	1	Vector Rounding Add and Narrow, returning High Half	<a href="#">VRADDHN on page A8-1022</a>
0101	-	Vector Absolute Difference and Accumulate	<a href="#">VABA, VABAL on page A8-818</a>
0110	0	Vector Subtract and Narrow, returning High Half	<a href="#">VSUBHN on page A8-1088</a>
	1	Vector Rounding Subtract and Narrow, returning High Half	<a href="#">VRSUBHN on page A8-1044</a>
0111	-	Vector Absolute Difference	<a href="#">VABD, VABDL (integer) on page A8-820</a>
10x0	-	Vector Multiply Accumulate or Subtract	<a href="#">VMLA, VMLAL, VMLS, VMLSL (integer) on page A8-930</a>
10x1	0	Vector Saturating Doubling Multiply Accumulate or Subtract Long	<a href="#">VQDMLAL, VQDMLSL on page A8-998</a>
1100	-	Vector Multiply (integer)	<a href="#">VMUL, VMULL (integer and polynomial) on page A8-958</a>
1101	0	Vector Saturating Doubling Multiply Long	<a href="#">VQDMULL on page A8-1002</a>
1110	-	Vector Multiply (polynomial)	<a href="#">VMUL, VMULL (integer and polynomial) on page A8-958</a>

### A7.4.3 Two registers and a scalar

The Thumb encoding of these instructions is:

15	14	13	12	11	10	9	8	7	6	5	4	3	2	1	0	15	14	13	12	11	10	9	8	7	6	5	4	3	2	1	0
1	1	1	U	1	1	1	1	1			B											A		1		0					

The ARM encoding of these instructions is:

31	30	29	28	27	26	25	24	23	22	21	20	19	18	17	16	15	14	13	12	11	10	9	8	7	6	5	4	3	2	1	0
1	1	1	1	0	0	1	U	1			B												A		1		0				

If B == 0b11, see [Advanced SIMD data-processing instructions on page A7-261](#).

Otherwise, [Table A7-11](#) shows the allocation of encodings in this space. Other encodings in this space are UNDEFINED.

**Table A7-11 Data-processing instructions with two registers and a scalar**

A	U	Instruction	See
0x0x	-	Vector Multiply Accumulate or Subtract	<a href="#">VMLA, VMLAL, VMLS, VMLSL (by scalar) on page A8-934</a>
0x10	-	Vector Multiply Accumulate or Subtract Long	<a href="#">VMLA, VMLAL, VMLS, VMLSL (by scalar) on page A8-934</a>
0x11	0	Vector Saturating Doubling Multiply Accumulate or Subtract Long	<a href="#">VQDMLAL, VQDMLSL on page A8-998</a>
100x	-	Vector Multiply	<a href="#">VMUL, VMULL (by scalar) on page A8-962</a>
1010	-	Vector Multiply Long	<a href="#">VMUL, VMULL (by scalar) on page A8-962</a>
1011	0	Vector Saturating Doubling Multiply Long	<a href="#">VQDMULL on page A8-1002</a>
1100	-	Vector Saturating Doubling Multiply returning High Half	<a href="#">VQDMULH on page A8-1000</a>
1101	-	Vector Saturating Rounding Doubling Multiply returning High Half	<a href="#">VQRDMULH on page A8-1008</a>

### A7.4.4 Two registers and a shift amount

The Thumb encoding of these instructions is:

15	14	13	12	11	10	9	8	7	6	5	4	3	2	1	0	15	14	13	12	11	10	9	8	7	6	5	4	3	2	1	0
1	1	1	U	1	1	1	1	1			imm3					A	L	B													

The ARM encoding of these instructions is:

31	30	29	28	27	26	25	24	23	22	21	20	19	18	17	16	15	14	13	12	11	10	9	8	7	6	5	4	3	2	1	0
1	1	1	1	0	0	1	U	1			imm3													A	L	B					

If [L, imm3] == 0b0000, see *One register and a modified immediate value on page A7-269*.

Otherwise, [Table A7-12](#) shows the allocation of encodings in this space. Other encodings in this space are UNDEFINED.

**Table A7-12 Data-processing instructions with two registers and a shift amount**

A	U	B	L	Instruction	See
0000	-	-	-	Vector Shift Right	<a href="#">VSHR on page A8-1052</a>
0001	-	-	-	Vector Shift Right and Accumulate	<a href="#">VSRA on page A8-1060</a>
0010	-	-	-	Vector Rounding Shift Right	<a href="#">VRSHR on page A8-1034</a>
0011	-	-	-	Vector Rounding Shift Right and Accumulate	<a href="#">VRSRA on page A8-1042</a>
0100	1	-	-	Vector Shift Right and Insert	<a href="#">VSRI on page A8-1062</a>
0101	0	-	-	Vector Shift Left	<a href="#">VSHL (immediate) on page A8-1046</a>
	1	-	-	Vector Shift Left and Insert	<a href="#">VSLI on page A8-1056</a>
011x	-	-	-	Vector Saturating Shift Left	<a href="#">VQSHL, VQSHLU (immediate) on page A8-1016</a>
1000	0	0	0	Vector Shift Right Narrow	<a href="#">VSHRN on page A8-1054</a>
	1	0		Vector Rounding Shift Right Narrow	<a href="#">VRSHRN on page A8-1036</a>
	1	0	0	Vector Saturating Shift Right, Unsigned Narrow	<a href="#">VQSHRN, VQSHRUN on page A8-1018</a>
1001		0	0	Vector Saturating Shift Right, Narrow	<a href="#">VQSHRN, VQSHRUN on page A8-1018</a>
		1	0	Vector Saturating Shift Right, Rounded Narrow	<a href="#">VQRSHRN, VQRSHRUN on page A8-1012</a>
1010	-	0	0	Vector Shift Left Long	<a href="#">VSHLL on page A8-1050</a>
				Vector Move Long	<a href="#">VMOVL on page A8-950</a>
111x	-	-	0	Vector Convert	<a href="#">VCVT (between floating-point and fixed-point, Advanced SIMD) on page A8-872</a>

## A7.4.5 Two registers, miscellaneous

The Thumb encoding of these instructions is:

15	14	13	12	11	10	9	8	7	6	5	4	3	2	1	0	15	14	13	12	11	10	9	8	7	6	5	4	3	2	1	0
1	1	1	1	1	1	1	1	1		1	1			A		0				B		0									

The ARM encoding of these instructions is:

31	30	29	28	27	26	25	24	23	22	21	20	19	18	17	16	15	14	13	12	11	10	9	8	7	6	5	4	3	2	1	0
1	1	1	1	0	0	1	1	1		1	1			A		0						B		0							

The allocation of encodings in this space is shown in [Table A7-13](#). Other encodings in this space are UNDEFINED.

**Table A7-13 Instructions with two registers, miscellaneous**

A	B	Instruction	See
00	0000x	Vector Reverse in doublewords	<a href="#">VREV16</a> , <a href="#">VREV32</a> , <a href="#">VREV64</a> on page A8-1028
	0001x	Vector Reverse in words	<a href="#">VREV16</a> , <a href="#">VREV32</a> , <a href="#">VREV64</a> on page A8-1028
	0010x	Vector Reverse in halfwords	<a href="#">VREV16</a> , <a href="#">VREV32</a> , <a href="#">VREV64</a> on page A8-1028
	010xx	Vector Pairwise Add Long	<a href="#">VPADDL</a> on page A8-984
	1000x	Vector Count Leading Sign Bits	<a href="#">VCLS</a> on page A8-858
	1001x	Vector Count Leading Zeros	<a href="#">VCLZ</a> on page A8-862
	1010x	Vector Count	<a href="#">VCNT</a> on page A8-866
	1011x	Vector Bitwise NOT	<a href="#">VMVN (register)</a> on page A8-966
	110xx	Vector Pairwise Add and Accumulate Long	<a href="#">VPADAL</a> on page A8-978
00	1110x	Vector Saturating Absolute	<a href="#">VQABS</a> on page A8-994
	1111x	Vector Saturating Negate	<a href="#">VQNEG</a> on page A8-1006
01	x000x	Vector Compare Greater Than Zero	<a href="#">VCGT (immediate #0)</a> on page A8-854
	x001x	Vector Compare Greater Than or Equal to Zero	<a href="#">VCGE (immediate #0)</a> on page A8-850
	x010x	Vector Compare Equal to zero	<a href="#">VCEQ (immediate #0)</a> on page A8-846
	x011x	Vector Compare Less Than or Equal to Zero	<a href="#">VCLE (immediate #0)</a> on page A8-856
	x100x	Vector Compare Less Than Zero	<a href="#">VCLT (immediate #0)</a> on page A8-860
	x110x	Vector Absolute	<a href="#">VABS</a> on page A8-824
	x111x	Vector Negate	<a href="#">VNEG</a> on page A8-968

**Table A7-13 Instructions with two registers, miscellaneous (continued)**

<b>A</b>	<b>B</b>	<b>Instruction</b>	<b>See</b>
10	0000x	Vector Swap	<i>VSWP</i> on page A8-1092
	0001x	Vector Transpose	<i>VTRN</i> on page A8-1096
	0010x	Vector Unzip	<i>VUZP</i> on page A8-1100
	0011x	Vector Zip	<i>VZIP</i> on page A8-1102
	01000	Vector Move and Narrow	<i>VMOVN</i> on page A8-952
	01001	Vector Saturating Move and Unsigned Narrow	<i>VQMOVN, VQMOVUN</i> on page A8-1004
	0101x	Vector Saturating Move and Narrow	<i>VQMOVN, VQMOVUN</i> on page A8-1004
	01100	Vector Shift Left Long (maximum shift)	<i>VSHLL</i> on page A8-1050
	11x00	Vector Convert	<i>VCVT</i> (between half-precision and single-precision, Advanced SIMD) on page A8-878
11	10x0x	Vector Reciprocal Estimate	<i>VRECPE</i> on page A8-1024
	10x1x	Vector Reciprocal Square Root Estimate	<i>VRSQRTE</i> on page A8-1038
	11xxx	Vector Convert	<i>VCVT</i> (between floating-point and integer, Advanced SIMD) on page A8-868



## A7.4.6 One register and a modified immediate value

The Thumb encoding of these instructions is:

15	14	13	12	11	10	9	8	7	6	5	4	3	2	1	0	15	14	13	12	11	10	9	8	7	6	5	4	3	2	1	0
1	1	1	a	1	1	1	1	1		0	0	0	b	c	d																
																cmode				0		op	1	e f g h							

The ARM encoding of these instructions is:

31	30	29	28	27	26	25	24	23	22	21	20	19	18	17	16	15	14	13	12	11	10	9	8	7	6	5	4	3	2	1	0		
1	1	1	1	0	0	1	a	1		0	0	0	b	c	d																		
																cmode				0		op	1	e f g h									

Table A7-14 shows the allocation of encodings in this space.

**Table A7-14 Data-processing instructions with one register and a modified immediate value**

op	cmode	Instruction	See
0	0xx0	Vector Move	<i>VMOV (immediate)</i> on page A8-936
	0xx1	Vector Bitwise OR	<i>VORR (immediate)</i> on page A8-974
	10x0	Vector Move	<i>VMOV (immediate)</i> on page A8-936
	10x1	Vector Bitwise OR	<i>VORR (immediate)</i> on page A8-974
	11xx	Vector Move	<i>VMOV (immediate)</i> on page A8-936
1	0xx0	Vector Bitwise NOT	<i>VMVN (immediate)</i> on page A8-964
	0xx1	Vector Bit Clear	<i>VBIC (immediate)</i> on page A8-838
	10x0	Vector Bitwise NOT	<i>VMVN (immediate)</i> on page A8-964
	10x1	Vector Bit Clear	<i>VBIC (immediate)</i> on page A8-838
	110x	Vector Bitwise NOT	<i>VMVN (immediate)</i> on page A8-964
	1110	Vector Move	<i>VMOV (immediate)</i> on page A8-936
	1111	UNDEFINED	-

Table A7-15 shows the modified immediate constants available with these instructions, and how they are encoded.

**Table A7-15 Modified immediate values for Advanced SIMD instructions**

op	cmode	Constant <sup>a</sup>	<dt> <sup>b</sup>	Notes
-	000x	00000000 00000000 00000000 abcdefgh 00000000 00000000 00000000 abcdefgh	I32	c
	001x	00000000 00000000 abcdefgh 00000000 00000000 00000000 abcdefgh 00000000	I32	c, d
	010x	00000000 abcdefgh 00000000 00000000 00000000 abcdefgh 00000000 00000000	I32	c, d
	011x	abcdefgh 00000000 00000000 00000000 abcdefgh 00000000 00000000 00000000	I32	c, d
	100x	00000000 abcdefgh 00000000 abcdefgh 00000000 abcdefgh 00000000 abcdefgh	I16	c
	101x	abcdefgh 00000000 abcdefgh 00000000 abcdefgh 00000000 abcdefgh 00000000	I16	c, d
	1100	00000000 00000000 abcdefgh 11111111 00000000 00000000 abcdefgh 11111111	I32	d, e
	1101	00000000 abcdefgh 11111111 11111111 00000000 abcdefgh 11111111 11111111	I32	d, e

**Table A7-15 Modified immediate values for Advanced SIMD instructions (continued)**

op	cmode	Constant <sup>a</sup>	<dt> <sup>b</sup>	Notes
0	1110	abcdefgh abcdefgh abcdefgh abcdefgh abcdefgh abcdefgh abcdefgh abcdefgh	I8	f
	1111	aBbbbbbc defgh000 00000000 00000000 aBbbbbbc defgh000 00000000 00000000	F32	f, g
1	1110	aaaaaaaa bbbbbbbb cccccccc dddddddd eeeeeeee ffffffff gggggggg hhhhhhhh	I64	f
	1111	UNDEFINED	-	-

- a. In this table, the immediate value is shown in binary form, to relate abcdefgh to the encoding diagram. In assembler syntax, the constant is specified by a data type and a value of that type. That value is specified in the normal way (a decimal number by default) and is replicated enough times to fill the 64-bit immediate. For example, a data type of I32 and a value of 10 specify the 64-bit constant 0x0000000A0000000A.
- b. This specifies the data type used when the instruction is disassembled. On assembly, the data type must be matched in the table if possible. Other data types are permitted as pseudo-instructions when a program is assembled, provided the 64-bit constant specified by the data type and value is available for the instruction. If a constant is available in more than one way, the first entry in this table that can produce it is used. For example, VMOV.I64 D0, #0x8000000080000000 does not specify a 64-bit constant that is available from the I64 line of the table, but does specify one that is available from the fourth I32 line or the F32 line. It is assembled to the first of these, and therefore is disassembled as VMOV.I32 D0, #0x80000000.
- c. This constant is available for the VBIC, VMOV, VMVN, and VORR instructions.
- d. UNPREDICTABLE if abcdefgh == 00000000.
- e. This constant is available for the VMOV and VMVN instructions only.
- f. This constant is available for the VMOV instruction only.
- g. In this entry, B = NOT(b). The bit pattern represents the floating-point number  $(-1)^S \times 2^{\text{exp}} \times \text{mantissa}$ , where  $S = \text{UInt}(a)$ ,  $\text{exp} = \text{UInt}(\text{NOT}(b):c:d) - 3$  and  $\text{mantissa} = (16 + \text{UInt}(e:f:g:h)) / 16$ .

## Advanced SIMD expand immediate pseudocode

```
// AdvSIMDEExpandImm()
// =====

bits(64) AdvSIMDEExpandImm(bit op, bits(4) cmode, bits(8) imm8)

case cmode<3:1> of
  when '000'
    testimm8 = FALSE; imm64 = Replicate(Zeros(24):imm8, 2);
  when '001'
    testimm8 = TRUE; imm64 = Replicate(Zeros(16):imm8:Zeros(8), 2);
  when '010'
    testimm8 = TRUE; imm64 = Replicate(Zeros(8):imm8:Zeros(16), 2);
  when '011'
    testimm8 = TRUE; imm64 = Replicate(imm8:Zeros(24), 2);
  when '100'
    testimm8 = FALSE; imm64 = Replicate(Zeros(8):imm8, 4);
  when '101'
    testimm8 = TRUE; imm64 = Replicate(imm8:Zeros(8), 4);
  when '110'
    testimm8 = TRUE;
    if cmode<0> == '0' then
      imm64 = Replicate(Zeros(16):imm8:Ones(8), 2);
    else
      imm64 = Replicate(Zeros(8):imm8:Ones(16), 2);
  when '111'
    testimm8 = FALSE;
    if cmode<0> == '0' && op == '0' then
      imm64 = Replicate(imm8, 8);
    if cmode<0> == '0' && op == '1' then
      imm8a = Replicate(imm8<7>, 8); imm8b = Replicate(imm8<6>, 8);
      imm8c = Replicate(imm8<5>, 8); imm8d = Replicate(imm8<4>, 8);
      imm8e = Replicate(imm8<3>, 8); imm8f = Replicate(imm8<2>, 8);
      imm8g = Replicate(imm8<1>, 8); imm8h = Replicate(imm8<0>, 8);
      imm64 = imm8a:imm8b:imm8c:imm8d:imm8e:imm8f:imm8g:imm8h;
    if cmode<0> == '1' && op == '0' then
      imm32 = imm8<7>:NOT(imm8<6>):Replicate(imm8<6>,5):imm8<5:0>:Zeros(19);
      imm64 = Replicate(imm32, 2);
    if cmode<0> == '1' && op == '1' then
      UNDEFINED;

if testimm8 && imm8 == '00000000' then
  UNPREDICTABLE;

return imm64;
```

## A7.5 Floating-point data-processing instructions

The Thumb encoding of Floating-point (VFP) data processing instructions is:

15	14	13	12	11	10	9	8	7	6	5	4	3	2	1	0	15	14	13	12	11	10	9	8	7	6	5	4	3	2	1	0
1	1	1	T	1	1	1	0	opc1	opc2			1 0 1			opc3	0	opc4														

The ARM encoding of Floating-point (VFP) data processing instructions is:

31	30	29	28	27	26	25	24	23	22	21	20	19	18	17	16	15	14	13	12	11	10	9	8	7	6	5	4	3	2	1	0
cond			1	1	1	0	opc1	opc2			1 0 1			opc3	0	opc4															

If T == 1 in the Thumb encoding or cond == 0b1111 in the ARM encoding, the instruction is UNDEFINED.

Otherwise:

- [Table A7-16](#) shows the encodings for three-register Floating-point data-processing instructions. Other encodings in this space are UNDEFINED.
- [Table A7-17](#) applies only if [Table A7-16](#) indicates that it does. It shows the encodings for Floating-point data-processing instructions with two registers or a register and an immediate. Other encodings in this space are UNDEFINED.
- [Table A7-18 on page A7-273](#) shows the immediate constants available in the VMOV (immediate) instruction.

These instructions are CDP instructions for coprocessors 10 and 11.

**Table A7-16 Three-register Floating-point data-processing instructions**

opc1	opc3	Instruction	See	Variant
0x00	-	Vector Multiply Accumulate or Subtract	<a href="#">VMLA, VMLS (floating-point) on page A8-932</a>	VFPv2
0x01	-	Vector Negate Multiply Accumulate or Subtract	<a href="#">VNMLA, VNMLS, VNMUL on page A8-970</a>	VFPv2
0x10	x1			
	x0	Vector Multiply	<a href="#">VMUL (floating-point) on page A8-960</a>	VFPv2
0x11	x0	Vector Add	<a href="#">VADD (floating-point) on page A8-830</a>	VFPv2
	x1	Vector Subtract	<a href="#">VSUB (floating-point) on page A8-1086</a>	VFPv2
1x00	x0	Vector Divide	<a href="#">VDIV on page A8-882</a>	
1x01	-	Vector Fused Negate Multiply Accumulate or Subtract	<a href="#">VFNMA, VFNMS on page A8-894</a>	VFPv4
1x10	-	Vector Fused Multiply Accumulate or Subtract	<a href="#">VFMA, VFMS on page A8-892</a>	VFPv4
1x11	-	Other Floating-point data-processing instructions	<a href="#">Table A7-17</a>	-

**Table A7-17 Other Floating-point data-processing instructions**

opc2	opc3	Instruction	See	Variant
-	x0	Vector Move	<a href="#">VMOV (immediate) on page A8-936</a>	VFPv3
0000	01	Vector Move	<a href="#">VMOV (register) on page A8-938</a>	VFPv2
	11	Vector Absolute	<a href="#">VABS on page A8-824</a>	VFPv2
0001	01	Vector Negate	<a href="#">VNEG on page A8-968</a>	VFPv2
	11	Vector Square Root	<a href="#">VSQRT on page A8-1058</a>	VFPv2

**Table A7-17 Other Floating-point data-processing instructions (continued)**

opc2	opc3	Instruction	See	Variant
001x	x1	Vector Convert	<i>VCVTB, VCVTT</i> on page A8-880	VFPv3HP <sup>a</sup>
010x	x1	Vector Compare	<i>VCMP, VCMPE</i> on page A8-864	VFPv2
0111	11	Vector Convert	<i>VCVT</i> (between double-precision and single-precision) on page A8-876	VFPv2
1000	x1	Vector Convert	<i>VCVT, VCVTR</i> (between floating-point and integer, Floating-point) on page A8-870	VFPv2
101x	x1	Vector Convert	<i>VCVT</i> (between floating-point and fixed-point, Floating-point) on page A8-874	VFPv3
110x	x1	Vector Convert	<i>VCVT, VCVTR</i> (between floating-point and integer, Floating-point) on page A8-870	VFPv2
111x	x1	Vector Convert	<i>VCVT</i> (between floating-point and fixed-point, Floating-point) on page A8-874	VFPv3

a. VFPv3 Half-precision Extension.

**Table A7-18 Floating-point modified immediate constants**

Data type	opc2	opc4	Constant <sup>a</sup>
F32	abcd	efgh	aBbbbbc defgh000 00000000 00000000
F64	abcd	efgh	aBbbbbbb bbcdefgh 00000000 00000000 00000000 00000000 00000000 00000000

a. In this column, B = NOT(b). The bit pattern represents the floating-point number  $(-1)^S \times 2^{\text{exp}} \times \text{mantissa}$ , where  $S = \text{UInt}(a)$ ,  $\text{exp} = \text{UInt}(\text{NOT}(b):c:d)-3$  and  $\text{mantissa} = (16+\text{UInt}(e:f:g:h))/16$ .

### A7.5.1 Operation of modified immediate constants, Floating-point

The VFPEExpandImm() pseudocode function describes the operation of an immediate constant in a floating-point instruction.

```
// VFPEExpandImm()
// =====

bits(N) VFPEExpandImm(bits(8) imm8, integer N)
    assert N IN {32,64};
    if N == 32 then
        return imm8<7>:NOT(imm8<6>):Replicate(imm8<6>,5):imm8<5:0>:Zeros(19);
    else
        return imm8<7>:NOT(imm8<6>):Replicate(imm8<6>,8):imm8<5:0>:Zeros(48);
```

## A7.6 Extension register load/store instructions

The Thumb encoding of Advanced SIMD and Floating-point (VFP) Extension register load and store instructions is:

15	14	13	12	11	10	9	8	7	6	5	4	3	2	1	0	15	14	13	12	11	10	9	8	7	6	5	4	3	2	1	0
1	1	1	T	1	1	0	Opcode				Rn				1 0 1																

The ARM encoding of Advanced SIMD and Floating-point (VFP) Extension register load and store instructions is:

31	30	29	28	27	26	25	24	23	22	21	20	19	18	17	16	15	14	13	12	11	10	9	8	7	6	5	4	3	2	1	0
cond			1	1	0	Opcode				Rn				1 0 1																	

If T == 1 in the Thumb encoding or cond == 0b1111 in the ARM encoding, the instruction is UNDEFINED.

Otherwise, the allocation of encodings in this space is shown in Table A7-19. Other encodings in this space are UNDEFINED.

These instructions are LDC and STC instructions for coprocessors 10 and 11.

**Table A7-19 Extension register load/store instructions**

Opcode	Rn	Instruction	See
0010x	-	-	<i>64-bit transfers between ARM core and extension registers on page A7-279</i>
01x00	-	Vector Store Multiple (Increment After, no writeback)	<i>VSTM on page A8-1080</i>
01x10	-	Vector Store Multiple (Increment After, writeback)	<i>VSTM on page A8-1080</i>
1xx00	-	Vector Store Register	<i>VSTR on page A8-1082</i>
10x10	not 1101	Vector Store Multiple (Decrement Before, writeback)	<i>VSTM on page A8-1080</i>
	1101	Vector Push Registers	<i>VPUSH on page A8-992</i>
01x01	-	Vector Load Multiple (Increment After, no writeback)	<i>VLDM on page A8-922</i>
01x11	not 1101	Vector Load Multiple (Increment After, writeback)	<i>VLDM on page A8-922</i>
	1101	Vector Pop Registers	<i>VPOP on page A8-990</i>
1xx01	-	Vector Load Register	<i>VLDR on page A8-924</i>
10x11	-	Vector Load Multiple (Decrement Before, writeback)	<i>VLDM on page A8-922</i>

## A7.7 Advanced SIMD element or structure load/store instructions

The Thumb encoding of Advanced SIMD element load and store instructions is:

15	14	13	12	11	10	9	8	7	6	5	4	3	2	1	0	15	14	13	12	11	10	9	8	7	6	5	4	3	2	1	0									
1	1	1	1	1	0	0	1	A		L	0																						B							

The ARM encoding of Advanced SIMD element load and store instructions is:

31	30	29	28	27	26	25	24	23	22	21	20	19	18	17	16	15	14	13	12	11	10	9	8	7	6	5	4	3	2	1	0																												
1	1	1	1	0	1	0	0	A		L	0																																					B											

The allocation of encodings in this space is shown in:

- [Table A7-20](#) if L == 0. These are the encodings for store instructions.
- [Table A7-21 on page A7-276](#) if L == 1. These are the encodings for load instructions.

Other encodings in this space are UNDEFINED.

The variable bits are in identical locations in the two encodings, after adjusting for the fact that the ARM encoding is held in memory as a single word and the Thumb encoding is held as two consecutive halfwords.

The ARM instructions can only be executed unconditionally. The Thumb instructions can be executed conditionally by using the IT instruction. For details see [IT on page A8-390](#).

**Table A7-20 Element and structure store instructions (L == 0)**

A	B	Instruction	See
0	0010	Vector Store	<a href="#">VST1 (multiple single elements) on page A8-1064</a>
	011x		
	1010		
	0011	Vector Store	<a href="#">VST2 (multiple 2-element structures) on page A8-1068</a>
	100x		
	010x	Vector Store	<a href="#">VST3 (multiple 3-element structures) on page A8-1072</a>
	000x	Vector Store	<a href="#">VST4 (multiple 4-element structures) on page A8-1076</a>
1	0x00	Vector Store	<a href="#">VST1 (single element from one lane) on page A8-1066</a>
	1000		
	0x01	Vector Store	<a href="#">VST2 (single 2-element structure from one lane) on page A8-1070</a>
	1001		
	0x10	Vector Store	<a href="#">VST3 (single 3-element structure from one lane) on page A8-1074</a>
	1010		
	0x11	Vector Store	<a href="#">VST4 (single 4-element structure from one lane) on page A8-1078</a>
	1011		

**Table A7-21 Element and structure load instructions (L == 1)**

<b>A</b>	<b>B</b>	<b>Instruction</b>	<b>See</b>
0	0010	Vector Load	<i>VLD1 (multiple single elements)</i> on page A8-898
	011x		
	1010		
	0011	Vector Load	<i>VLD2 (multiple 2-element structures)</i> on page A8-904
	100x		
	010x	Vector Load	<i>VLD3 (multiple 3-element structures)</i> on page A8-910
	000x	Vector Load	<i>VLD4 (multiple 4-element structures)</i> on page A8-916
1	0x00	Vector Load	<i>VLD1 (single element to one lane)</i> on page A8-900
	1000		
	1100	Vector Load	<i>VLD1 (single element to all lanes)</i> on page A8-902
	0x01	Vector Load	<i>VLD2 (single 2-element structure to one lane)</i> on page A8-906
	1001		
	1101	Vector Load	<i>VLD2 (single 2-element structure to all lanes)</i> on page A8-908
	0x10	Vector Load	<i>VLD3 (single 3-element structure to one lane)</i> on page A8-912
	1010		
1110	Vector Load	<i>VLD3 (single 3-element structure to all lanes)</i> on page A8-914	
0x11	Vector Load	<i>VLD4 (single 4-element structure to one lane)</i> on page A8-918	
1011			
1111	Vector Load	<i>VLD4 (single 4-element structure to all lanes)</i> on page A8-920	



## A7.7.1 Advanced SIMD addressing mode

All the element and structure load/store instructions use this addressing mode. There is a choice of three formats:

- [<Rn>{:<align>}]      The address is contained in ARM core register Rn.  
Rn is not updated by this instruction.  
Encoded as Rm = 0b1111.  
If Rn is encoded as 0b1111, the instruction is UNPREDICTABLE.
- [<Rn>{:<align>}]!      The address is contained in ARM core register Rn.  
Rn is updated by this instruction:  $Rn = Rn + transfer\_size$   
Encoded as Rm = 0b1101.  
  
transfer\_size is the number of bytes transferred by the instruction. This means that, after the instruction is executed, Rn points to the address in memory immediately following the last address loaded from or stored to.  
If Rn is encoded as 0b1111, the instruction is UNPREDICTABLE.  
This addressing mode can also be written as:  
[<Rn>{:<align>}], #<transfer\_size>  
However, disassembly produces the [<Rn>{:<align>}]! form.
- [<Rn>{:<align>}], <Rm>  
The address is contained in ARM core register <Rn>.  
Rn is updated by this instruction:  $Rn = Rn + Rm$   
Encoded as Rm = Rm. Rm must not be encoded as 0b1111 or 0b1101, the PC or the SP.  
If Rn is encoded as 0b1111, the instruction is UNPREDICTABLE.

In all cases, <align> specifies an alignment. Details are given in the individual instruction descriptions.

Previous versions of the document used the @ character for alignment. So, for example, the first format in this section was shown as [<Rn>{@<align>}]. Both @ and : are supported. However, to ensure portability of code to assemblers that treat @ as a comment character, : is preferred.

## A7.8 8, 16, and 32-bit transfer between ARM core and extension registers

The Thumb encoding of Advanced SIMD and Floating-point 8-bit, 16-bit, and 32-bit register data transfer instructions is:

15	14	13	12	11	10	9	8	7	6	5	4	3	2	1	0	15	14	13	12	11	10	9	8	7	6	5	4	3	2	1	0
1	1	1	T	1	1	1	0	A	L							1	0	1	C			B	1								

The ARM encoding of Advanced SIMD and Floating-point 8-bit, 16-bit, and 32-bit register data transfer instructions is:

31	30	29	28	27	26	25	24	23	22	21	20	19	18	17	16	15	14	13	12	11	10	9	8	7	6	5	4	3	2	1	0	
cond				1	1	1	0	A	L													1	0	1	C			B	1			

If T == 1 in the Thumb encoding or cond == 0b1111 in the ARM encoding, the instruction is UNDEFINED.

Otherwise, the allocation of encodings in this space is shown in Table A7-22. Other encodings in this space are UNDEFINED.

These instructions are MRC and MCR instructions for coprocessors 10 and 11.

**Table A7-22 8-bit, 16-bit and 32-bit data transfer instructions**

L	C	A	B	Instruction	See
0	0	000	-	Vector Move	<i>VMOV</i> (between ARM core register and single-precision register) on page A8-944
		111	-	Move to Floating-point Special register from ARM core register	<i>VMSR</i> on page A8-956 <i>VMSR</i> on page B9-2014, System level view
0	1	0xx	-	Vector Move	<i>VMOV</i> (ARM core register to scalar) on page A8-940
		1xx	0x	Vector Duplicate	<i>VDUP</i> (ARM core register) on page A8-886
1	0	000	-	Vector Move	<i>VMOV</i> (between ARM core register and single-precision register) on page A8-944
		111	-	Move to ARM core register from Floating-point Special register	<i>VMRS</i> on page A8-954 <i>VMRS</i> on page B9-2012, System level view
1	xxx	-	-	Vector Move	<i>VMOV</i> (scalar to ARM core register) on page A8-942

## A7.9 64-bit transfers between ARM core and extension registers

The Thumb encoding of Advanced SIMD and Floating-point 64-bit register data transfer instructions is:

15	14	13	12	11	10	9	8	7	6	5	4	3	2	1	0	15	14	13	12	11	10	9	8	7	6	5	4	3	2	1	0
1	1	1	T	1	1	0	0	0	1	0						1	0	1	C		op										

The ARM encoding of Advanced SIMD and Floating-point 64-bit register data transfer instructions is:

31	30	29	28	27	26	25	24	23	22	21	20	19	18	17	16	15	14	13	12	11	10	9	8	7	6	5	4	3	2	1	0																																																																		
																																cond	1	1	0	0	0	1	0																										1	0	1	C		op																											

If T == 1 in the Thumb encoding or cond == 0b1111 in the ARM encoding, the instruction is UNDEFINED.

Otherwise, the allocation of encodings in this space is shown in [Table A7-23](#). Other encodings in this space are UNDEFINED.

These instructions are MRRC and MCRR instructions for coprocessors 10 and 11.

**Table A7-23 64-bit data transfer instructions**

C	op	Instruction
0	00x1	<i>VMOV</i> (between two ARM core registers and two single-precision registers) on page A8-946
1	00x1	<i>VMOV</i> (between two ARM core registers and a doubleword extension register) on page A8-948



# Chapter A8

## Instruction Details

This chapter describes each instruction. It contains the following sections:

- *Format of instruction descriptions* on page A8-282
- *Standard assembler syntax fields* on page A8-287
- *Conditional execution* on page A8-288
- *Shifts applied to a register* on page A8-291
- *Memory accesses* on page A8-294
- *Encoding of lists of ARM core registers* on page A8-295
- *Additional pseudocode support for instruction descriptions* on page A8-296
- *Alphabetical list of instructions* on page A8-300.

———— **Note** —————

The *Floating-point Extension* was previously described as the *VFP Extension*, and:

- Different versions of this extension, and the instructions they introduce, are identified using the abbreviation VFP, for example VFPv3.
  - The deprecated vector features of the Floating-point Extension are identified as VFP vectors.
-

## A8.1 Format of instruction descriptions

The instruction descriptions in [Alphabetical list of instructions on page A8-300](#) normally use the following format:

- instruction section title
- introduction to the instruction
- instruction encoding(s) with architecture information
- assembler syntax
- pseudocode describing how the instruction operates
- exception information
- notes (where applicable).

Each of these items is described in more detail in the following subsections.

A few instruction descriptions describe alternative mnemonics for other instructions and use an abbreviated and modified version of this format.

### A8.1.1 Instruction section title

The instruction section title gives the base mnemonic for the instructions described in the section. When one mnemonic has multiple forms described in separate instruction sections, this is followed by a short description of the form in parentheses. The most common use of this is to distinguish between forms of an instruction in which one of the operands is an immediate value and forms in which it is a register.

Another use of parenthesized text is to indicate the former mnemonic in some cases where a mnemonic has been replaced entirely by another mnemonic in the new assembler syntax.

### A8.1.2 Introduction to the instruction

The instruction section title is followed by text that briefly describes the main features of the instruction. This description is not necessarily complete and is not definitive. If there is any conflict between it and the more detailed information that follows, the latter takes priority.

### A8.1.3 Instruction encodings

This is a list of one or more instruction encodings. Each instruction encoding is labelled as:

- T1, T2, T3 ... for the first, second, third and any additional Thumb encodings
- A1, A2, A3 ... for the first, second, third and any additional ARM encodings
- E1, E2, E3 ... for the first, second, third and any additional ThumbEE encodings that are not also Thumb encodings.

Where Thumb and ARM encodings are very closely related, the two encodings are described together, for example as encoding T1/A1.

Each instruction encoding description consists of:

- Information about which architecture variants include the particular encoding of the instruction. This is presented in one of two ways:
  - For instruction encodings that are in the main instruction set architecture, as a list of the architecture variants that include the encoding. See [Architecture versions, profiles, and variants on page A1-30](#) for a summary of these variants.
  - For instruction encodings that are in the architecture extensions, as a list of the architecture extensions that include the encoding. See [Architecture extensions on page A1-32](#) for a summary of the architecture extensions and the architecture variants that they can extend.

In architecture variant lists:

- ARMv7 means ARMv7-A and ARMv7-R profiles. The architecture variant information in this manual does not cover the ARMv7-M profile.
  - \* is used as a wildcard. For example, ARMv5T\* means ARMv5T, ARMv5TE, and ARMv5TEJ.
- An assembly syntax that ensures that the assembler selects the encoding in preference to any other encoding. In some cases, multiple syntaxes are given. The correct one to use is sometimes indicated by annotations to the syntax, such as *Inside IT block* and *Outside IT block*. In other cases, the correct one to use can be determined by looking at the assembler syntax description and using it to determine which syntax corresponds to the instruction being disassembled.

There is usually more than one syntax that ensures re-assembly to any particular encoding, and the exact set of syntaxes that do so usually depends on the register numbers, immediate constants and other operands to the instruction. For example, when assembling to the Thumb instruction set, the syntax `AND R0, R0, R8` ensures selection of a 32-bit encoding but `AND R0, R0, R1` selects a 16-bit encoding.

The assembly syntax documented for the encoding is chosen to be the simplest one that ensures selection of that encoding for all operand combinations supported by that encoding. This often means that it includes elements that are only necessary for a small subset of operand combinations. For example, the assembler syntax documented for the 32-bit Thumb AND (register) encoding includes the `.W` qualifier to ensure that the 32-bit encoding is selected even for the small proportion of operand combinations for which the 16-bit encoding is also available.

The assembly syntax given for an encoding is therefore a suitable one for a disassembler to disassemble that encoding to. However, disassemblers might wish to use simpler syntaxes when they are suitable for the operand combination, in order to produce more readable disassembled code.

- An encoding diagram, or a Thumb encoding diagram followed by an ARM encoding diagram when they are being described together. This is half-width for 16-bit Thumb encodings and full-width for 32-bit Thumb and ARM encodings. The 32-bit ARM encoding diagrams number the bits from 31 to 0, while the 32-bit Thumb encoding diagrams number the bits from 15 to 0 for each halfword, to distinguish them from ARM encodings and to act as a reminder that a 32-bit Thumb instruction consists of two consecutive halfwords rather than a word.

In particular, if instructions are stored using the standard little-endian instruction endianness, the encoding diagram for an ARM instruction at address `A` shows the bytes at addresses `A+3`, `A+2`, `A+1`, `A` from left to right, but the encoding diagram for a 32-bit Thumb instruction shows them in the order `A+1`, `A` for the first halfword, followed by `A+3`, `A+2` for the second halfword.

- Encoding-specific pseudocode. This is pseudocode that translates the encoding-specific instruction fields into inputs to the encoding-independent pseudocode in the later *Operation* subsection, and that picks out any special cases in the encoding. For a detailed description of the pseudocode used and of the relationship between the encoding diagram, the encoding-specific pseudocode and the encoding-independent pseudocode, see [Appendix P Pseudocode Definition](#).

#### A8.1.4 Assembler syntax

The *Assembler syntax* subsection describes the standard UAL syntax for the instruction.

Each syntax description consists of the following elements:

- One or more syntax prototype lines written in a typewriter font, using the conventions described in [Assembler syntax prototype line conventions on page A8-285](#). Each prototype line documents the mnemonic and (where appropriate) operand parts of a full line of assembler code. When there is more than one such line, each prototype line is annotated to indicate required results of the encoding-specific pseudocode.

For each instruction encoding belonging to a target instruction set, an assembler can use this information to determine whether it can use that encoding to encode the instruction requested by the UAL source. If multiple encodings can encode the instruction then:

- If both a 16-bit encoding and a 32-bit encoding can encode the instruction, the architecture *prefers* the 16-bit encoding. This means the assembler must use the 16-bit encoding rather than the 32-bit encoding.

Software can use the `.W` and `.N` qualifiers to specify the required encoding width, see [Standard assembler syntax fields on page A8-287](#).

- If multiple encodings of the same length can encode the instruction, the *Assembler syntax* subsection says which encoding is preferred, and how software can, instead, select the other encodings. Each encoding also documents UAL syntax that selects it in preference to any other encoding.

If no encodings of the target instruction set can encode the instruction requested by the UAL source, normally the assembler generates an error saying that the instruction is not available in that instruction set.

———— **Note** —————

Often, an instruction is available in one instruction set but not in another. The *Assembler syntax* subsection identifies many of these cases. For example, the ARM instructions with bits<31:28> == 0b1111 described in [Unconditional instructions on page A5-216](#) cannot have a condition code, but the equivalent Thumb instructions often can, and this usually appears in the *Assembler syntax* subsection as a statement that the ARM instruction cannot be conditional.

However, some such cases are too complex to describe in the available space, so the definitive test of whether an instruction is available in a given instruction set is whether there is an available encoding for it in that instruction set.

- The line *where*: followed by descriptions of all of the variable or optional fields of the prototype syntax line. Some syntax fields are standardized across all or most instructions. [Standard assembler syntax fields on page A8-287](#) describes these fields.

By default, syntax fields that specify registers, such as `<Rd>`, `<Rn>`, or `<Rt>`, can be any of R0-R12 or LR in Thumb instructions, and any of R0-R12, SP or LR in ARM instructions. These require that the encoding-specific pseudocode set the corresponding integer variable (such as `d`, `n`, or `t`) to the corresponding register number, using 0-12 for R0-R12, 13 for SP, or 14 for LR:

- Normally, software can do this by setting the corresponding field in the instruction, typically named `Rd`, `Rn`, `Rt`, to the binary encoding of that number.
- In the case of 16-bit Thumb encodings, the field is normally of length 3, and so the encoding is only available when the assembler syntax specifies one of R0-R7. Such encodings often use a register field name like `Rdn`. This indicates that the encoding is only available if `<Rd>` and `<Rn>` specify the same register, and that the register number of that register is encoded in the field if they do.

The description of a syntax field that specifies a register sometimes extends or restricts the permitted range of registers or documents other differences from the default rules for such fields. Examples of extensions are permitting the use of the SP in a Thumb instruction, or permitting the use of the PC, identified using register number 15.

- Where appropriate, text that briefly describes changes from the pre-UAL ARM assembler syntax. Where present, this usually consists of an alternative pre-UAL form of the assembler mnemonic. The pre-UAL ARM assembler syntax does not conflict with UAL. ARM recommends that it is supported, as an optional extension to UAL, so that pre-UAL ARM assembler source files can be assembled.

———— **Note** —————

The pre-UAL Thumb assembler syntax is incompatible with UAL and is not documented in the instruction sections. For details see [Appendix H Legacy Instruction Mnemonics](#).



## Assembler syntax prototype line conventions

The following conventions are used in assembler syntax prototype lines and their subfields:

< > Any item bracketed by < and > is a short description of a type of value to be supplied by the user in that position. A longer description of the item is normally supplied by subsequent text. Such items often correspond to a similarly named field in an encoding diagram for an instruction. When the correspondence only requires the binary encoding of an integer value or register number to be substituted into the instruction encoding, it is not described explicitly. For example, if the assembler syntax for an ARM instruction contains an item <Rn> and the instruction encoding diagram contains a 4-bit field named Rn, the number of the register specified in the assembler syntax is encoded in binary in the instruction field.

If the correspondence between the assembler syntax item and the instruction encoding is more complex than simple binary encoding of an integer or register number, the item description indicates how it is encoded. This is often done by specifying a required output from the encoding-specific pseudocode, such as `add = TRUE`. The assembler must only use encodings that produce that output.

{ } Any item bracketed by { and } is optional. A description of the item and of how its presence or absence is encoded in the instruction is normally supplied by subsequent text.

Many instructions have an optional destination register. Unless otherwise stated, if such a destination register is omitted, it is the same as the immediately following source register in the instruction syntax.

# In the assembler syntax, numeric constants are normally preceded by a #. Some UAL instruction syntax descriptions explicitly show this # as optional. Any UAL assembler:

- must treat the # as optional where an instruction syntax description shows it as optional
- can treat the # either as mandatory or as optional where an instruction syntax description does not show it as optional.

---

**Note**

---

ARM recommends that UAL assemblers treat all uses of # shown in this manual as optional.

---

**spaces** Single spaces are used for clarity, to separate items. When a space is obligatory in the assembler syntax, two or more consecutive spaces are used.

+/- This indicates an optional + or - sign. If neither is coded, + is assumed.

All other characters must be encoded precisely as they appear in the assembler syntax. Apart from { and }, the special characters described above do not appear in the basic forms of assembler instructions documented in this manual. The { and } characters need to be encoded in a few places as part of a variable item. When this happens, the long description of the variable item indicates how they must be used.

### A8.1.5 Pseudocode describing how the instruction operates

The *Operation* subsection contains encoding-independent pseudocode that describes the main operation of the instruction. For a detailed description of the pseudocode used and of the relationship between the encoding diagram, the encoding-specific pseudocode and the encoding-independent pseudocode, see [Appendix P Pseudocode Definition](#).

## A8.1.6 Exception information

The *Exceptions* subsection contains a list of the exceptional conditions that can be caused by execution of the instruction.

Processor exceptions are listed as follows:

- Resets and interrupts (both IRQs and FIQs) are not listed. They can occur before or after the execution of any instruction, and in some cases during the execution of an instruction, but they are not in general caused by the instruction concerned.
- Prefetch Abort exceptions are normally caused by a memory abort when an instruction is fetched, followed by an attempt to execute that instruction. This can happen for any instruction, but is caused by the aborted attempt to fetch the instruction rather than by the instruction itself, and so is not listed. A special case is the BKPT instruction, that is defined as causing a Prefetch Abort exception in some circumstances.
- Data Abort exceptions are listed for all instructions that perform data memory accesses.
- Undefined Instruction exceptions are listed when they are part of the effects of a defined instruction. For example, all coprocessor instructions are defined to produce the Undefined Instruction exception if not accepted by their coprocessor. Undefined Instruction exceptions caused by the execution of an undefined instruction are not listed, even when the undefined instruction is a special case of one or more of the encodings of the instruction. Such special cases are instead indicated in the encoding-specific pseudocode for the encoding.
- Supervisor Call and Secure Monitor Call exceptions are listed for the SVC and SMC instructions respectively. Supervisor Call exceptions and the SVC instruction were previously called Software Interrupt exceptions and the SWI instruction. Secure Monitor Call exceptions and the SMC instruction were previously called Secure Monitor interrupts and the SMI instruction.

Floating-point exceptions are listed for instructions that can produce them. [Floating-point exceptions on page A2-70](#) describes these exceptions. They do not normally result in processor exceptions.

## A8.1.7 Notes

Where appropriate, other notes about the instruction appear under additional subheadings.

———— **Note** —————

Information that was documented in notes in previous versions of the ARM Architecture Reference Manual and its supplements has often been moved elsewhere. For example, operand restrictions on the values of fields in an instruction encoding are now normally documented in the encoding-specific pseudocode for that encoding.

---

## A8.2 Standard assembler syntax fields

The following assembler syntax fields are standard across all or most instructions:

<c> Is an optional field. It specifies the condition under which the instruction is executed. See [Conditional execution on page A8-288](#) for the range of available conditions and their encoding. If <c> is omitted, it defaults to *always* (AL).

<q> Specifies optional assembler qualifiers on the instruction. The following qualifiers are defined:

.N Meaning narrow, specifies that the assembler must select a 16-bit encoding for the instruction. If this is not possible, an assembler error is produced.

.W Meaning wide, specifies that the assembler must select a 32-bit encoding for the instruction. If this is not possible, an assembler error is produced.

If neither .W nor .N is specified, the assembler can select either 16-bit or 32-bit encodings. If both are available, it must select a 16-bit encoding. In a few cases, more than one encoding of the same length can be available for an instruction. The rules for selecting between such encodings are instruction-specific and are part of the instruction description.

———— **Note** ————

When assembling to the ARM instruction set, the .N qualifier produces an assembler error and the .W qualifier has no effect.

---

## A8.3 Conditional execution

Most ARM instructions, and most Thumb instructions from ARMv6T2 onwards, can be executed conditionally, based on the values of the APSR condition flags. Before ARMv6T2, the only conditional Thumb instruction was the 16-bit conditional branch instruction. [Table A8-1](#) lists the available conditions.

**Table A8-1 Condition codes**

cond	Mnemonic extension	Meaning (integer)	Meaning (floating-point) <sup>a</sup>	Condition flags
0000	EQ	Equal	Equal	Z == 1
0001	NE	Not equal	Not equal, or unordered	Z == 0
0010	CS <sup>b</sup>	Carry set	Greater than, equal, or unordered	C == 1
0011	CC <sup>c</sup>	Carry clear	Less than	C == 0
0100	MI	Minus, negative	Less than	N == 1
0101	PL	Plus, positive or zero	Greater than, equal, or unordered	N == 0
0110	VS	Overflow	Unordered	V == 1
0111	VC	No overflow	Not unordered	V == 0
1000	HI	Unsigned higher	Greater than, or unordered	C == 1 and Z == 0
1001	LS	Unsigned lower or same	Less than or equal	C == 0 or Z == 1
1010	GE	Signed greater than or equal	Greater than or equal	N == V
1011	LT	Signed less than	Less than, or unordered	N != V
1100	GT	Signed greater than	Greater than	Z == 0 and N == V
1101	LE	Signed less than or equal	Less than, equal, or unordered	Z == 1 or N != V
1110	None (AL) <sup>d</sup>	Always (unconditional)	Always (unconditional)	Any

- a. Unordered means at least one NaN operand.
- b. HS (unsigned higher or same) is a synonym for CS.
- c. LO (unsigned lower) is a synonym for CC.
- d. AL is an optional mnemonic extension for always, except in IT instructions. For details see [IT on page A8-390](#).

In Thumb instructions, the condition, if it is not AL, is normally encoded in a preceding IT instruction. For more information see [Conditional instructions on page A4-162](#) and [IT on page A8-390](#). Some conditional branch instructions do not require a preceding IT instruction, because they include a condition code in their encoding.

In ARM instructions, bits[31:28] of the instruction contain the condition code, or contain 0b1111 for some ARM instructions that can only be executed unconditionally.

ARM deprecates the conditional execution of any instruction encoding provided by the Advanced SIMD Extension that is not also provided by the Floating-point (VFP) extension, and strongly recommends that:

- For ARM instructions, any such Advanced SIMD instruction that can be conditionally executed is executed with the <c> field omitted or set to AL.

———— **Note** —————

This applies only to VDUP, see [VDUP \(ARM core register\) on page A8-886](#). The other instructions do not permit conditional execution in ARM state.

- For Thumb instructions, such Advanced SIMD instructions are never included in an IT block. This means they must be specified with the <c> field omitted or set to AL.

This deprecation does not apply to Advanced SIMD instruction encodings that are also available as Floating-point instruction encodings. That is, it does not apply to the Advanced SIMD encodings of the instructions described in the following sections:

- [VLDM on page A8-922](#).
- [VLDR on page A8-924](#).
- [VMOV \(ARM core register to scalar\) on page A8-940](#).
- [VMOV \(between two ARM core registers and a doubleword extension register\) on page A8-948](#).
- [VMRS on page A8-954](#).
- [VMSR on page A8-956](#).
- [VPOP on page A8-990](#).
- [VPUSH on page A8-992](#).
- [VSTM on page A8-1080](#).
- [VSTR on page A8-1082](#).

See also [Conditional execution of undefined instructions on page B1-1208](#).

### A8.3.1 Pseudocode details of conditional execution

The CurrentCond() pseudocode function has prototype:

```
bits(4) CurrentCond()
```

This function returns a 4-bit condition specifier as follows:

- For ARM instructions, it returns bits[31:28] of the instruction.
- For the T1 and T3 encodings of the Branch instruction (see [B on page A8-334](#)), it returns the 4-bit cond field of the encoding.
- For all other Thumb and ThumbEE instructions:
  - if ITSTATE.IT<3:0> != '0000' it returns ITSTATE.IT<7:4>
  - if ITSTATE.IT<7:0> == '00000000' it returns '1110'
  - otherwise, execution of the instruction is UNPREDICTABLE.

For more information, see [IT block state register, ITSTATE on page A2-51](#).

The ConditionPassed() function uses this condition specifier and the APSR condition flags to determine whether the instruction must be executed:

```
// ConditionPassed()
// =====

boolean ConditionPassed()
    cond = CurrentCond();

    // Evaluate base condition.
    case cond<3:1> of
        when '000' result = (APSR.Z == '1');           // EQ or NE
        when '001' result = (APSR.C == '1');           // CS or CC
        when '010' result = (APSR.N == '1');           // MI or PL
        when '011' result = (APSR.V == '1');           // VS or VC
        when '100' result = (APSR.C == '1') && (APSR.Z == '0'); // HI or LS
        when '101' result = (APSR.N == APSR.V);        // GE or LT
        when '110' result = (APSR.N == APSR.V) && (APSR.Z == '0'); // GT or LE
        when '111' result = TRUE;                       // AL

    // Condition flag values in the set '111x' indicate the instruction is always executed.
    // Otherwise, invert condition if necessary.
    if cond<0> == '1' && cond != '1111' then
        result = !result;
```

```
return result;
```

[Undefined Instruction exception on page B1-1205](#) describes the handling of conditional instructions that are UNDEFINED or UNPREDICTABLE. The pseudocode in the manual, as a sequential description of the instructions, has limitations in this respect. For more information, see [Limitations of the instruction pseudocode on page AppxP-2644](#).

## A8.4 Shifts applied to a register

ARM register offset load/store word and unsigned byte instructions can apply a wide range of different constant shifts to the offset register. Both Thumb and ARM data-processing instructions can apply the same range of different constant shifts to the second operand register. For details see *Constant shifts*.

ARM data-processing instructions can apply a register-controlled shift to the second operand register.

### A8.4.1 Constant shifts

These are the same in Thumb and ARM instructions, except that the input bits come from different positions.

<shift> is an optional shift to be applied to <Rm>. It can be any one of:

<b>(omitted)</b>	No shift.
LSL #<n>	Logical shift left <n> bits. $1 \leq \langle n \rangle \leq 31$ .
LSR #<n>	Logical shift right <n> bits. $1 \leq \langle n \rangle \leq 32$ .
ASR #<n>	Arithmetic shift right <n> bits. $1 \leq \langle n \rangle \leq 32$ .
ROR #<n>	Rotate right <n> bits. $1 \leq \langle n \rangle \leq 31$ .
RRX	Rotate right one bit, with extend. Bit[0] is written to shifter_carry_out, bits[31:1] are shifted right one bit, and the Carry flag is shifted into bit[31].

#### ————— Note —————

Assemblers can permit the use of some or all of ASR #0, LSL #0, LSR #0, and ROR #0 to specify that no shift is to be performed. This is not standard UAL, and the encoding selected for Thumb instructions might vary between UAL assemblers if it is used. To ensure disassembled code assembles to the original instructions, disassemblers must omit the shift specifier when the instruction specifies no shift.

Similarly, assemblers can permit the use of #0 in the immediate forms of ASR, LSL, LSR, and ROR instructions to specify that no shift is to be performed, that is, that a MOV (register) instruction is wanted. Again, this is not standard UAL, and the encoding selected for Thumb instructions might vary between UAL assemblers if it is used. To ensure disassembled code assembles to the original instructions, disassemblers must use the MOV (register) syntax when the instruction specifies no shift.

### Encoding

The assembler encodes <shift> into two type bits and five immediate bits, as follows:

<b>(omitted)</b>	type = 0b00, immediate = 0.
LSL #<n>	type = 0b00, immediate = <n>.
LSR #<n>	type = 0b01. If <n> < 32, immediate = <n>. If <n> == 32, immediate = 0.
ASR #<n>	type = 0b10. If <n> < 32, immediate = <n>. If <n> == 32, immediate = 0.
ROR #<n>	type = 0b11, immediate = <n>.
RRX	type = 0b11, immediate = 0.

## A8.4.2 Register controlled shifts

These are only available in ARM instructions.

<type> is the type of shift to apply to the value read from <Rm>. It must be one of:

ASR	Arithmetic shift right, encoded as type = 0b10.
LSL	Logical shift left, encoded as type = 0b00.
LSR	Logical shift right, encoded as type = 0b01.
ROR	Rotate right, encoded as type = 0b11.

The bottom byte of <Rs> contains the shift amount.

## A8.4.3 Pseudocode details of instruction-specified shifts and rotates

```
enumeration SRType {SRType_LSL, SRType_LSR, SRType_ASR, SRType_ROR, SRType_RRX};
```

```
// DecodeImmShift()  
// =====
```

```
(SRType, integer) DecodeImmShift(bits(2) type, bits(5) imm5)
```

```
case type of  
  when '00'  
    shift_t = SRType_LSL; shift_n = UInt(imm5);  
  when '01'  
    shift_t = SRType_LSR; shift_n = if imm5 == '00000' then 32 else UInt(imm5);  
  when '10'  
    shift_t = SRType_ASR; shift_n = if imm5 == '00000' then 32 else UInt(imm5);  
  when '11'  
    if imm5 == '00000' then  
      shift_t = SRType_RRX; shift_n = 1;  
    else  
      shift_t = SRType_ROR; shift_n = UInt(imm5);  
  
  return (shift_t, shift_n);
```

```
// DecodeRegShift()  
// =====
```

```
SRType DecodeRegShift(bits(2) type)
```

```
case type of  
  when '00' shift_t = SRType_LSL;  
  when '01' shift_t = SRType_LSR;  
  when '10' shift_t = SRType_ASR;  
  when '11' shift_t = SRType_ROR;  
  return shift_t;
```

```
// Shift()  
// =====
```

```
bits(N) Shift(bits(N) value, SRType type, integer amount, bit carry_in)  
(result, -) = Shift_C(value, type, amount, carry_in);  
return result;
```

```
// Shift_C()  
// =====
```

```
(bits(N), bit) Shift_C(bits(N) value, SRType type, integer amount, bit carry_in)  
assert !(type == SRType_RRX && amount != 1);  
  
if amount == 0 then  
  (result, carry_out) = (value, carry_in);  
else  
  case type of  
    when SRType_LSL  
      (result, carry_out) = LSL_C(value, amount);
```



```
when SRTYPE_LSR
    (result, carry_out) = LSR_C(value, amount);
when SRTYPE_ASR
    (result, carry_out) = ASR_C(value, amount);
when SRTYPE_ROR
    (result, carry_out) = ROR_C(value, amount);
when SRTYPE_RRX
    (result, carry_out) = RRX_C(value, carry_in);

return (result, carry_out);
```

## A8.5 Memory accesses

Commonly, the following addressing modes are permitted for memory access instructions:

### Offset addressing

The offset value is applied to an address obtained from the base register. The result is used as the address for the memory access. The value of the base register is unchanged.

The assembly language syntax for this mode is:

[<Rn>, <offset>]

### Pre-indexed addressing

The offset value is applied to an address obtained from the base register. The result is used as the address for the memory access, and written back into the base register.

The assembly language syntax for this mode is:

[<Rn>, <offset>]!

### Post-indexed addressing

The address obtained from the base register is used, unchanged, as the address for the memory access. The offset value is applied to the address, and written back into the base register.

The assembly language syntax for this mode is:

[<Rn>], <offset>

In each case, <Rn> is the base register. <offset> can be:

- an immediate constant, such as <imm8> or <imm12>
- an index register, <Rm>
- a shifted index register, such as <Rm>, LSL #<shift>.

For information about unaligned access, endianness, and exclusive access, see:

- [Alignment support on page A3-108](#)
- [Endian support on page A3-110](#)
- [Synchronization and semaphores on page A3-114](#).

## A8.6 Encoding of lists of ARM core registers

A number of instructions operate on lists of ARM core registers. For these instructions, the assembler syntax includes a <registers> field, that provides a list of the registers to be operated on, with list entries separated by commas.

The registers list is encoded in the instruction encoding. Most often, this is done using an 8-bit, 13-bit, or 16-bit `register_list` field. This section gives more information about these and other possible register list encodings.

In a `register_list` field, each bit corresponds to a single register, and if the <registers> field of the assembler instruction includes `Rt` then `register_list<t>` is set to 1, otherwise it is set to 0.

The full rules for the encoding of lists of ARM core registers are:

- Except for the cases listed here, 16-bit Thumb encodings use an 8-bit register list, and can access only registers R0-R7.

The exceptions to this rule are:

- The T1 encoding of `POP` uses an 8-bit register list, and an additional bit, `P`, that corresponds to the PC. This means it can access any of R0-R7 and the PC.
- The T1 encoding of `PUSH` uses an 8-bit register list, and an additional bit, `M`, that corresponds to the LR. This means it can access any of R0-R7 and the LR.

- 32-bit Thumb encodings of load operations use a 13-bit register list, and two additional bits, `M`, corresponding to the LR, and `P`, corresponding to the PC. This means these instructions can access any of R0-R12 and the LR and PC.
- 32-bit Thumb encodings of store operations use a 13-bit register list, and one additional bit, `M`, corresponding to the LR. This means these instructions can access any of R0-R12 and the LR.
- Except for the case listed here, ARM encodings use a 16-bit register list. This means these instructions can access any of R0-R12 and the SP, LR, and PC.

The exception to this rule is:

- The system instructions `LDM` (exception return) and `LDM` (User registers) use a 15-bit register list. This means these instructions can access any of R0-R12 and the SP and LR.

- The T3 and A2 encodings of `POP`, and the T3 and A2 encodings of `PUSH`, access a single register from the set of registers {R0-R12, LR, PC} and encode the register number in the `Rt` field.

---

———— **Note** —————

`POP` is a load operation, and `PUSH` is a store operation.

---

In every case, the encoding-specific pseudocode converts the register list into a 32-bit variable, `registers`, with a bit corresponding to each of the registers R0-R12, SP, LR, and PC.

---

———— **Note** —————

Some Floating-point and Advanced SIMD instructions operate on lists of Advanced SIMD and Floating-point extension registers. The assembler syntax of these instructions includes a <list> field that specifies the registers to be operated on, and the description of the instruction in [Alphabetical list of instructions on page A8-300](#) defines the use and encoding of this field.

---

## A8.7 Additional pseudocode support for instruction descriptions

Earlier sections of this chapter include pseudocode that describes features of the execution of ARM and Thumb instructions, see:

- [Pseudocode details of conditional execution on page A8-289](#)
- [Pseudocode details of instruction-specified shifts and rotates on page A8-292](#)

The following subsection gives additional pseudocode support functions for some of the instructions described in [Alphabetical list of instructions on page A8-300](#):

### A8.7.1 Pseudocode details of coprocessor operations

The Coproc\_Accepted() pseudocode function determines whether a coprocessor instruction is accepted for execution.

```
// Coproc_Accepted()
// =====
// Determines whether the coprocessor instruction is accepted.

boolean Coproc_Accepted(integer cp_num, bits(32) instr)

    // Not called for CP10 and CP11 coprocessors
    assert !(cp_num IN {10,11});

    if !(cp_num IN {14,15}) then
        // Check against NSACR/CPACR/HCPTR
        if HaveSecurityExt() then
            // Check Non-Secure Access Control Register for permission to use cp_num.
            if !IsSecure() && NSACR<cp_num> == '0' then UNDEFINED;

        // Check Coprocessor Access Control Register for permission to use cp_num.
        if !HaveVirtExt() || !CurrentModeIsHyp() then
            case CPACR<2*cp_num+1:2*cp_num> of
                when '00' UNDEFINED;
                when '01' if !CurrentModeIsNotUser() then UNDEFINED;
                // else CPACR permits access
                when '10' UNPREDICTABLE;
                when '11' // CPACR permits access

            if HaveSecurityExt() && HaveVirtExt() && !IsSecure() && HCPTR<cp_num> == '1' then
                HSRString = Zeros(25);
                HSRString<5> = '0';
                HSRString<3:0> = cp_num<3:0>;
                WriteHSR('000111', HSRString);
                if !CurrentModeIsHyp() then
                    TakeHypTrapException();
                else
                    UNDEFINED;

            return CPxInstrDecode(instr);

    elseif cp_num == 14 then
        // CP14 space
        // Unpack the basic classes based on Opc1
        if instr<27:24> == '1110' && instr<4> == '1' && instr<31:28> != '1111' then
            // MCR/MRC
            opc1 = UInt(instr<23:21>);
            two_reg = FALSE;
        elseif instr<27:20> == '1100100' && instr<31:28> != '1111' then
            // MRRC
            opc1 = UInt(instr<7:4>);
            if opc1 != 0 then UNDEFINED;
            two_reg = TRUE;
        elseif instr<27:25> == '110' && instr<31:28> != '1111' then
            // LDC/STC
            opc1 = 0; // only use of LDC/STC is for Debug
```

```

    if UInt(instr<15:12>) != 5 then UNDEFINED;
else
    UNDEFINED;

case opc1 of
// Does not consider possible traps of Debug and Trace registers from
// Non-secure modes to Hyp mode here.
when 0 return CP14DebugInstrDecode(instr);
when 1 return CP14TraceInstrDecode(instr);

    when 6
        // ThumbEE registers - fully decoded here
        if two_reg then UNDEFINED;
        if instr<7:5> != '000' || instr<3:1> != '000' ||
            instr<15:12> == '1111' then
            UNPREDICTABLE;
        else
            if instr<0> == '0' then
                if !CurrentModeIsNotUser() then UNDEFINED;
            if instr<1> == '1' then
                if !CurrentModeIsNotUser() && TEECR.XED == '1' then UNDEFINED;

                if HaveSecurityExt() && HaveVirtExt() && !IsSecure() &&
                    !CurrentModeIsHyp() && HSTR.TTEE == '1' then
                    HSRString = Zeros(25);
                    HSRString<19:17> = instr<7:5>;
                    HSRString<16:14> = instr<23:21>;
                    HSRString<13:10> = instr<19:16>;
                    HSRString<8:5> = instr<15:12>;
                    HSRString<4:1> = instr<3:0>;
                    HSRString<0> = instr<20>;
                    WriteHSR('000101', HSRString);
                    TakeHypTrapException();
                return TRUE;

            when 7 return CP14JazelleInstrDecode(instr);
        otherwise
            UNDEFINED;

elseif cp_num == 15 then
// Only MCR/MCRR/MRRC/MRC are supported in CP15
if instr<27:24> == '1110' && instr<4> == '1' && instr<31:28> != '1111' then
// MCR/MRC
    CrNum = UInt(instr<19:16>);
    two_reg = FALSE;
elseif instr<27:21> == '110010' && instr<31:28> != '1111' then
// MCRR/MRRC
    CrNum = UInt(instr<3:0>);
    two_reg = TRUE;
else
    UNDEFINED;
if CrNum == 4 then UNPREDICTABLE;

// Check for coarse-grained Hyp traps

// Check against HSTR for PL1 accesses
if HaveSecurityExt() && HaveVirtExt() && !IsSecure() && !CurrentModeIsHyp() &&
    CrNum != 14 && HSTR<CrNum> == '1' then
    if !CurrentModeIsNotUser() && InstrIsPL0Undefined(instr) then
        IMPLEMENTATION_CHOICE to be UNDEFINED;
    HSRString = Zeros(25);
    if two_reg then
        HSRString<19:16> = instr<7:4>;
        HSRString<13:10> = instr<19:16>;
        HSRString<8:5> = instr<15:12>;
        HSRString<4:1> = instr<3:0>;
        HSRString<0> = instr<20>;
        WriteHSR('000100', HSRString);

```

```

else
    HSRString<19:17> = instr<7:5>;
    HSRString<16:14> = instr<23:21>;
    HSRString<13:10> = instr<19:16>;
    HSRString<8:5> = instr<15:12>;
    HSRString<4:1> = instr<3:0>;
    HSRString<0> = instr<20>;
    WriteHSR('000011', HSRString);
    TakeHypTrapException();

// Check for TIDCP as a coarse-grain check for PL1 accesses
if HaveSecurityExt() && HaveVirtExt() && !IsSecure() && !CurrentModeIsHyp() &&
HCR.TIDCP == '1' && !two_reg then
    CrMnum = UInt(instr<3:0>);
    if (CrNnum == 9 && CrMnum IN {0,2,5,6,7,8}) ||
        (CrNnum == 10 && CrMnum IN {0,1,4,8}) ||
        (CrNnum == 11 && CrMnum IN {0,1,2,3,4,5,6,7,8,15}) then
        if !CurrentModeIsNotUser() && InstrIsPL0Undefined(instr) then
            IMPLEMENTATION_CHOICE to be UNDEFINED;
        HSRString = Zeros(25);
        HSRString<19:17> = instr<7:5>;
        HSRString<16:14> = instr<23:21>;
        HSRString<13:10> = instr<19:16>;
        HSRString<8:5> = instr<15:12>;
        HSRString<4:1> = instr<3:0>;
        HSRString<0> = instr<20>;
        WriteHSR('000011', HSRString);
        TakeHypTrapException();

    return CP15InstrDecode(instr);

```

The Coproc\_DoneLoading() pseudocode function determines, for an LDC instruction, whether enough words have been loaded:

```
boolean Coproc_DoneLoading(integer cp_num, bits(32) instr)
```

The Coproc\_DoneStoring() function determines for an STC instruction whether enough words have been stored:

```
boolean Coproc_DoneStoring(integer cp_num, bits(32) instr)
```

The Coproc\_GetOneWord() function obtains the word for an MRC instruction from the coprocessor:

```
bits(32) Coproc_GetOneWord(integer cp_num, bits(32) instr)
```

The Coproc\_GetTwoWords() function obtains the two words for an MRRC instruction from the coprocessor:

```
(bits(32), bits(32)) Coproc_GetTwoWords(integer cp_num, bits(32) instr)
```

#### ————— **Note** —————

The relative significance of the two words returned is IMPLEMENTATION DEFINED, but all uses within this manual present the two words in the order (most significant, least significant).

The Coproc\_GetWordToStore() function obtains the next word to store for an STC instruction from the coprocessor:

```
bits(32) Coproc_GetWordToStore(integer cp_num, bits(32) instr)
```

The Coproc\_InternalOperation() procedure instructs a coprocessor to perform the internal operation requested by a CDP instruction:

```
Coproc_InternalOperation(integer cp_num, bits(32) instr)
```

The Coproc\_SendLoadedWord() procedure sends a loaded word for an LDC instruction to the coprocessor:

```
Coproc_SendLoadedWord(bits(32) word, integer cp_num, bits(32) instr)
```

The Coproc\_SendOneWord() procedure sends the word for an MCR instruction to the coprocessor:

```
Coproc_SendOneWord(bits(32) word, integer cp_num, bits(32) instr)
```

The Coproc\_SendTwoWords() procedure sends the two words for an MCRR instruction to the coprocessor:

```
Coproc_SendTwoWords(bits(32) word2, bits(32) word1, integer cp_num, bits(32) instr)
```

———— **Note** —————

The relative significance of word2 and word1 is IMPLEMENTATION DEFINED, but all uses within this manual treat word2 as more significant than word1.

The CPxInstrDecode() pseudocode function decodes an accepted access to a coprocessor other than CP10, CP11, CP14, or CP15:

```
boolean CPxInstrDecode(bits(32) instr)
```

The CP14DebugInstrDecode() pseudocode function decodes an accepted access to a CP14 debug register:

```
boolean CP14DebugInstrDecode(bits(32) instr)
```

The CP14JazelleInstrDecode() pseudocode function decodes an accepted access to a CP14 Jazelle register:

```
boolean CP14JazelleInstrDecode(bits(32) instr)
```

The CP14TraceInstrDecode() pseudocode function decodes an accepted access to a CP14 Trace register:

```
boolean CP14TraceInstrDecode(bits(32) instr)
```

The CP15InstrDecode() pseudocode function decodes an accepted access to a CP15 register:

```
boolean CP15InstrDecode(bits(32) instr)
```

## A8.7.2 Calling the supervisor

The CallSupervisor() pseudocode function generates a Supervisor Call exception, after setting up the HSR if the exception must be taken to Hyp mode. Valid execution of the SVC instruction calls this function.

```
// CallSupervisor()
// =====
//
// Calls the Supervisor, with appropriate trapping etc

CallSupervisor(bits(16) immediate)

    if CurrentModeIsHyp() ||
        (HaveVirtExt() && !IsSecure() && !CurrentModeIsNotUser() && HCR.TGE == '1') then
        // will be taken to Hyp mode so must set HSR
        HSRString = Zeros(25);
        HSRString<15:0> = if CurrentCond() == '1110' then immediate else bits(16) UNKNOWN;
        WriteHSR('010001', HSRString);

    // This will go to Hyp mode if necessary
    TakeSVCException();
```

## A8.8 Alphabetical list of instructions

This section lists every instruction. For details of the format used see [Format of instruction descriptions on page A8-282](#).

This section is formatted so that a full description of an instruction uses a double page.

### A8.8.1 ADC (immediate)

Add with Carry (immediate) adds an immediate value and the Carry flag value to a register value, and writes the result to the destination register. It can optionally update the condition flags based on the result.

**Encoding T1** ARMv6T2, ARMv7

ADC{S}<c> <Rd>, <Rn>, #<const>

15	14	13	12	11	10	9	8	7	6	5	4	3	2	1	0	15	14	13	12	11	10	9	8	7	6	5	4	3	2	1	0
1	1	1	1	0	i	0	1	0	1	0	S		Rn		0	imm3		Rd												imm8	

d = UInt(Rd); n = UInt(Rn); setflags = (S == '1'); imm32 = ThumbExpandImm(i:imm3:imm8);  
if d IN {13,15} || n IN {13,15} then UNPREDICTABLE;

**Encoding A1** ARMv4\*, ARMv5T\*, ARMv6\*, ARMv7

ADC{S}<c> <Rd>, <Rn>, #<const>

31	30	29	28	27	26	25	24	23	22	21	20	19	18	17	16	15	14	13	12	11	10	9	8	7	6	5	4	3	2	1	0
cond		0	0	1	0	1	0	1	S		Rn		Rd	imm12																	

if Rd == '1111' && S == '1' then SEE SUBS PC, LR and related instructions;  
d = UInt(Rd); n = UInt(Rn); setflags = (S == '1'); imm32 = ARMEExpandImm(imm12);



## Assembler syntax

ADC{S}{<c>}{<q>} {<Rd>}, <Rn>, #<const>

where:

S If S is present, the instruction updates the flags. Otherwise, the flags are not updated.

<c>, <q> See *Standard assembler syntax fields* on page A8-287.

<Rd> The destination register. If S is specified and <Rd> is the PC, see *SUBS PC, LR (Thumb)* on page B9-2008 or *SUBS PC, LR and related instructions (ARM)* on page B9-2010.

In ARM instructions, if S is not specified and <Rd> is the PC, the instruction is a branch to the address calculated by the operation. This is an interworking branch, see *Pseudocode details of operations on ARM core registers* on page A2-47.

———— **Note** —————

Before ARMv7, this was a simple branch.

<Rn> The first operand register. The PC can be used in ARM instructions.

<const> The immediate value to be added to the value obtained from <Rn>. See *Modified immediate constants in Thumb instructions* on page A6-232 or *Modified immediate constants in ARM instructions* on page A5-200 for the range of values.

The pre-UAL syntax ADC<c>S is equivalent to ADCS<c>.

## Operation

```
if ConditionPassed() then
    EncodingSpecificOperations();
    (result, carry, overflow) = AddWithCarry(R[n], imm32, APSR.C);
    if d == 15 then // Can only occur for ARM encoding
        ALUWritePC(result); // setflags is always FALSE here
    else
        R[d] = result;
        if setflags then
            APSR.N = result<31>;
            APSR.Z = IsZeroBit(result);
            APSR.C = carry;
            APSR.V = overflow;
```

## Exceptions

None.

## A8.8.2 ADC (register)

Add with Carry (register) adds a register value, the Carry flag value, and an optionally-shifted register value, and writes the result to the destination register. It can optionally update the condition flags based on the result.

**Encoding T1** ARMv4T, ARMv5T\*, ARMv6\*, ARMv7  
ADC <Rdn>, <Rm> Outside IT block.  
ADC<c> <Rdn>, <Rm> Inside IT block.

15	14	13	12	11	10	9	8	7	6	5	4	3	2	1	0
0	1	0	0	0	0	0	1	0	1	Rm	Rdn				

```
d = UInt(Rdn); n = UInt(Rdn); m = UInt(Rm); setflags = !InITBlock();
(shift_t, shift_n) = (SRTYPE_LSL, 0);
```

**Encoding T2** ARMv6T2, ARMv7  
ADC{S}<c>.W <Rd>, <Rn>, <Rm>{, <shift>}

15	14	13	12	11	10	9	8	7	6	5	4	3	2	1	0	15	14	13	12	11	10	9	8	7	6	5	4	3	2	1	0
1	1	1	0	1	0	1	1	0	1	0	S	Rn				(0)	imm3			Rd			imm2		type	Rm					

```
d = UInt(Rd); n = UInt(Rn); m = UInt(Rm); setflags = (S == '1');
(shift_t, shift_n) = DecodeImmShift(type, imm3:imm2);
if d IN {13,15} || n IN {13,15} || m IN {13,15} then UNPREDICTABLE;
```

**Encoding A1** ARMv4\*, ARMv5T\*, ARMv6\*, ARMv7  
ADC{S}<c> <Rd>, <Rn>, <Rm>{, <shift>}

31	30	29	28	27	26	25	24	23	22	21	20	19	18	17	16	15	14	13	12	11	10	9	8	7	6	5	4	3	2	1	0
cond			0	0	0	0	1	0	1	S	Rn				Rd			imm5			type	0	Rm								

```
if Rd == '1111' && S == '1' then SEE SUBS PC, LR and related instructions;
d = UInt(Rd); n = UInt(Rn); m = UInt(Rm); setflags = (S == '1');
(shift_t, shift_n) = DecodeImmShift(type, imm5);
```

## Assembler syntax

ADC{S}{<c>}{<q>} {<Rd>}, <Rn>, <Rm> {, <shift>}

where:

- S                    If S is present, the instruction updates the flags. Otherwise, the flags are not updated.
- <c>, <q>            See *Standard assembler syntax fields* on page A8-287.
- <Rd>                The destination register. If S is specified and <Rd> is the PC, see *SUBS PC, LR (Thumb)* on page B9-2008 or *SUBS PC, LR and related instructions (ARM)* on page B9-2010.  
In ARM instructions, if S is not specified and <Rd> is the PC, the instruction is a branch to the address calculated by the operation. This is an interworking branch, see *Pseudocode details of operations on ARM core registers* on page A2-47.
- **Note** ————
- Before ARMv7, this was a simple branch.
- 
- <Rn>                The first operand register. The PC can be used in ARM instructions.
- <Rm>                The optionally shifted second operand register. The PC can be used in ARM instructions.
- <shift>             The shift to apply to the value read from <Rm>. If present, encoding T1 is not permitted. If absent, no shift is applied and any encoding is permitted. *Shifts applied to a register* on page A8-291 describes the shifts and how they are encoded.

In Thumb assembly:

- outside an IT block, if ADCS <Rd>, <Rn>, <Rd> has <Rd> and <Rn> both in the range R0-R7, it is assembled using encoding T1 as though ADCS <Rd>, <Rn> had been written.
- inside an IT block, if ADC<c> <Rd>, <Rn>, <Rd> has <Rd> and <Rn> both in the range R0-R7, it is assembled using encoding T1 as though ADC<c> <Rd>, <Rn> had been written.

To prevent either of these happening, use the .W qualifier.

The pre-UAL syntax ADC<c>S is equivalent to ADCS<c>.

## Operation

```
if ConditionPassed() then
    EncodingSpecificOperations();
    shifted = Shift(R[m], shift_t, shift_n, APSR.C);
    (result, carry, overflow) = AddWithCarry(R[n], shifted, APSR.C);
    if d == 15 then // Can only occur for ARM encoding
        ALUWritePC(result); // setflags is always FALSE here
    else
        R[d] = result;
        if setflags then
            APSR.N = result<31>;
            APSR.Z = IsZeroBit(result);
            APSR.C = carry;
            APSR.V = overflow;
```

## Exceptions

None.

### A8.8.3 ADC (register-shifted register)

Add with Carry (register-shifted register) adds a register value, the Carry flag value, and a register-shifted register value. It writes the result to the destination register, and can optionally update the condition flags based on the result.

**Encoding A1** ARMv4\*, ARMv5T\*, ARMv6\*, ARMv7

ADC{S}<c> <Rd>, <Rn>, <Rm>, <type> <Rs>

31	30	29	28	27	26	25	24	23	22	21	20	19	18	17	16	15	14	13	12	11	10	9	8	7	6	5	4	3	2	1	0
cond				0	0	0	0	1	0	1	S	Rn				Rd				Rs				0	type		1	Rm			

```
d = UInt(Rd); n = UInt(Rn); m = UInt(Rm); s = UInt(Rs);
setflags = (S == '1'); shift_t = DecodeRegShift(type);
if d == 15 || n == 15 || m == 15 || s == 15 then UNPREDICTABLE;
```

## Assembler syntax

ADC{S}{<c>}{<q>} {<Rd>}, <Rn>, <Rm>, <type> <Rs>

where:

S If S is present, the instruction updates the flags. Otherwise, the flags are not updated.

<c>, <q> See *Standard assembler syntax fields on page A8-287*.

<Rd> The destination register.

<Rn> The first operand register.

<Rm> The register that is shifted and used as the second operand.

<type> The type of shift to apply to the value read from <Rm>. It must be one of:

ASR Arithmetic shift right, encoded as type = 0b10.

LSL Logical shift left, encoded as type = 0b00.

LSR Logical shift right, encoded as type = 0b01.

ROR Rotate right, encoded as type = 0b11.

<Rs> The register whose bottom byte contains the amount to shift by.

The pre-UAL syntax ADC<c>S is equivalent to ADCS<c>.

## Operation

```
if ConditionPassed() then
    EncodingSpecificOperations();
    shift_n = UInt(R[s]<7:0>);
    shifted = Shift(R[m], shift_t, shift_n, APSR.C);
    (result, carry, overflow) = AddWithCarry(R[n], shifted, APSR.C);
    R[d] = result;
    if setflags then
        APSR.N = result<31>;
        APSR.Z = IsZeroBit(result);
        APSR.C = carry;
        APSR.V = overflow;
```

## Exceptions

None.

### A8.8.4 ADD (immediate, Thumb)

This instruction adds an immediate value to a register value, and writes the result to the destination register. It can optionally update the condition flags based on the result.

**Encoding T1** ARMv4T, ARMv5T\*, ARMv6\*, ARMv7  
ADDS <Rd>, <Rn>, #<imm3> Outside IT block.  
ADD<c> <Rd>, <Rn>, #<imm3> Inside IT block.

15	14	13	12	11	10	9	8	7	6	5	4	3	2	1	0
0	0	0	1	1	1	0	imm3			Rn			Rd		

d = UInt(Rd); n = UInt(Rn); setflags = !InITBlock(); imm32 = ZeroExtend(imm3, 32);

**Encoding T2** ARMv4T, ARMv5T\*, ARMv6\*, ARMv7  
ADDS <Rdn>, #<imm8> Outside IT block.  
ADD<c> <Rdn>, #<imm8> Inside IT block.

15	14	13	12	11	10	9	8	7	6	5	4	3	2	1	0
0	0	1	1	0	Rdn			imm8							

d = UInt(Rdn); n = UInt(Rdn); setflags = !InITBlock(); imm32 = ZeroExtend(imm8, 32);

**Encoding T3** ARMv6T2, ARMv7  
ADD{S}<c>.W <Rd>, <Rn>, #<const>

15	14	13	12	11	10	9	8	7	6	5	4	3	2	1	0	15	14	13	12	11	10	9	8	7	6	5	4	3	2	1	0
1	1	1	1	0	i	0	1	0	0	0	S	Rn			0	imm3			Rd			imm8									

if Rd == '1111' && S == '1' then SEE CMN (immediate);  
if Rn == '1101' then SEE ADD (SP plus immediate);  
d = UInt(Rd); n = UInt(Rn); setflags = (S == '1'); imm32 = ThumbExpandImm(i:imm3:imm8);  
if d == 13 || (d == 15 && S == '0') || n == 15 then UNPREDICTABLE;

**Encoding T4** ARMv6T2, ARMv7  
ADDW<c> <Rd>, <Rn>, #<imm12>

15	14	13	12	11	10	9	8	7	6	5	4	3	2	1	0	15	14	13	12	11	10	9	8	7	6	5	4	3	2	1	0
1	1	1	1	0	i	1	0	0	0	0	0	Rn			0	imm3			Rd			imm8									

if Rn == '1111' then SEE ADR;  
if Rn == '1101' then SEE ADD (SP plus immediate);  
d = UInt(Rd); n = UInt(Rn); setflags = FALSE; imm32 = ZeroExtend(i:imm3:imm8, 32);  
if d IN {13,15} then UNPREDICTABLE;

## Assembler syntax

ADD{S}{<c>}{<q>} {<Rd>}, {<Rn>, #<const>}	All encodings permitted
ADDW{<c>}{<q>} {<Rd>}, {<Rn>, #<const>}	Only encoding T4 permitted

where:

S	If S is present, the instruction updates the flags. Otherwise, the flags are not updated.
<c>, <q>	See <i>Standard assembler syntax fields</i> on page A8-287.
<Rd>	The destination register.
<Rn>	The first operand register. If <Rn> is SP, see <i>ADD (SP plus immediate)</i> on page A8-316. If <Rn> is PC, see <i>ADR</i> on page A8-322.
<const>	The immediate value to be added to the value obtained from <Rn>. The range of values is 0-7 for encoding T1, 0-255 for encoding T2 and 0-4095 for encoding T4. See <i>Modified immediate constants in Thumb instructions</i> on page A6-232 for the range of values for encoding T3.

When multiple encodings of the same length are available for an instruction, encoding T3 is preferred to encoding T4 (if encoding T4 is required, use the ADDW syntax). Encoding T1 is preferred to encoding T2 if <Rd> is specified and encoding T2 is preferred to encoding T1 if <Rd> is omitted.

The pre-UAL syntax ADD<c>S is equivalent to ADDS<c>.

## Operation

```
if ConditionPassed() then
    EncodingSpecificOperations();
    (result, carry, overflow) = AddWithCarry(R[n], imm32, '0');
    R[d] = result;
    if setflags then
        APSR.N = result<31>;
        APSR.Z = IsZeroBit(result);
        APSR.C = carry;
        APSR.V = overflow;
```

## Exceptions

None.

### A8.8.5 ADD (immediate, ARM)

This instruction adds an immediate value to a register value, and writes the result to the destination register. It can optionally update the condition flags based on the result.

**Encoding A1** ARMv4\*, ARMv5T\*, ARMv6\*, ARMv7

ADD{S}<c> <Rd>, <Rn>, #<const>

31	30	29	28	27	26	25	24	23	22	21	20	19	18	17	16	15	14	13	12	11	10	9	8	7	6	5	4	3	2	1	0
cond			0	0	1	0	1	0	0	S	Rn				Rd				imm12												

```

if Rn == '1111' && S == '0' then SEE ADR;
if Rn == '1101' then SEE ADD (SP plus immediate);
if Rd == '1111' && S == '1' then SEE SUBS PC, LR and related instructions;
d = UInt(Rd); n = UInt(Rn); setflags = (S == '1'); imm32 = ARMEExpandImm(imm12);

```



## Assembler syntax

ADD{S}{<c>}{<q>} {<Rd>}, {<Rn>, #<const>

where:

- S If S is present, the instruction updates the flags. Otherwise, the flags are not updated.
- <c>, <q> See *Standard assembler syntax fields* on page A8-287.
- <Rd> The destination register. If S is specified and <Rd> is the PC, see *SUBS PC, LR (Thumb)* on page B9-2008 or *SUBS PC, LR and related instructions (ARM)* on page B9-2010.  
If S is not specified and <Rd> is the PC, the instruction is a branch to the address calculated by the operation. This is an interworking branch, see *Pseudocode details of operations on ARM core registers* on page A2-47.

———— **Note** —————

Before ARMv7, this was a simple branch.

- <Rn> The first operand register. If the SP is specified for <Rn>, see *ADD (SP plus immediate)* on page A8-316. If the PC is specified for <Rn>, see *ADR* on page A8-322.
- <const> The immediate value to be added to the value obtained from <Rn>. See *Modified immediate constants in ARM instructions* on page A5-200 for the range of values.

The pre-UAL syntax ADD<c>S is equivalent to ADDS<c>.

## Operation

```

if ConditionPassed() then
    EncodingSpecificOperations();
    (result, carry, overflow) = AddWithCarry(R[n], imm32, '0');
    if d == 15 then
        ALUWritePC(result); // setflags is always FALSE here
    else
        R[d] = result;
        if setflags then
            APSR.N = result<31>;
            APSR.Z = IsZeroBit(result);
            APSR.C = carry;
            APSR.V = overflow;

```

## Exceptions

None.

### A8.8.6 ADD (register, Thumb)

This instruction adds a register value and an optionally-shifted register value, and writes the result to the destination register. It can optionally update the condition flags based on the result.

**Encoding T1** ARMv4T, ARMv5T\*, ARMv6\*, ARMv7  
ADD{S} <Rd>, <Rn>, <Rm> Outside IT block.  
ADD{C} <Rd>, <Rn>, <Rm> Inside IT block.

15	14	13	12	11	10	9	8	7	6	5	4	3	2	1	0
0	0	0	1	1	0	0	Rm			Rn			Rd		

d = UInt(Rd); n = UInt(Rn); m = UInt(Rm); setflags = !InITBlock();  
(shift\_t, shift\_n) = (SRTYPE\_LSL, 0);

**Encoding T2** ARMv6T2, ARMv7 if <Rdn> and <Rm> are both from R0-R7  
ARMv4T, ARMv5T\*, ARMv6\*, ARMv7 otherwise  
ADD{C} <Rdn>, <Rm> If <Rdn> is the PC, must be outside or last in IT block.

15	14	13	12	11	10	9	8	7	6	5	4	3	2	1	0
0	1	0	0	0	1	0	0	Rm			Rdn				

DN ←

if (DN:Rdn) == '1101' || Rm == '1101' then SEE ADD (SP plus register);  
d = UInt(DN:Rdn); n = d; m = UInt(Rm); setflags = FALSE; (shift\_t, shift\_n) = (SRTYPE\_LSL, 0);  
if n == 15 && m == 15 then UNPREDICTABLE;  
if d == 15 && InITBlock() && !LastInITBlock() then UNPREDICTABLE;

**Encoding T3** ARMv6T2, ARMv7  
ADD{S}{C}.W <Rd>, <Rn>, <Rm>{, <shift>}

15	14	13	12	11	10	9	8	7	6	5	4	3	2	1	0	15	14	13	12	11	10	9	8	7	6	5	4	3	2	1	0
1	1	1	0	1	0	1	1	0	0	0	S	Rn			(0)	imm3	Rd			imm2	type	Rm									

if Rd == '1111' && S == '1' then SEE CMN (register);  
if Rn == '1101' then SEE ADD (SP plus register);  
d = UInt(Rd); n = UInt(Rn); m = UInt(Rm); setflags = (S == '1');  
(shift\_t, shift\_n) = DecodeImmShift(type, imm3:imm2);  
if d == 13 || (d == 15 && S == '0') || n == 15 || m IN {13,15} then UNPREDICTABLE;

## Assembler syntax

ADD{S}{<C>}{<q>} {<Rd>}, <Rn>, <Rm> {, <shift>}

where:

- S            If S is present, the instruction updates the flags. Otherwise, the flags are not updated.
- <C>, <q>     See [Standard assembler syntax fields on page A8-287](#).
- <Rd>        The destination register. If S is specified and <Rd> is the PC, see [CMN \(register\) on page A8-366](#). If omitted, <Rd> is the same as <Rn> and encoding T2 is preferred to encoding T1 inside an IT block. If <Rd> is present, encoding T1 is preferred to encoding T2.  
  
If <Rd> is the PC and S is not specified, encoding T2 is used and the instruction is a branch to the address calculated by the operation. This is a simple branch, see [Pseudocode details of operations on ARM core registers on page A2-47](#).
- <Rn>        The first operand register. The PC can be used in encoding T2. If <Rn> is SP, see [ADD \(SP plus register, Thumb\) on page A8-318](#).
- <Rm>        The register that is optionally shifted and used as the second operand. The PC can be used in encoding T2
- <shift>     The shift to apply to the value read from <Rm>. If present, only encoding T3 is permitted. If omitted, no shift is applied and any encoding is permitted. [Shifts applied to a register on page A8-291](#) describes the shifts and how they are encoded.

Inside an IT block, if ADD<C> <Rd>, <Rn>, <Rd> cannot be assembled using encoding T1, it is assembled using encoding T2 as though ADD<C> <Rd>, <Rn> had been written. To prevent this happening, use the .W qualifier.

The pre-UAL syntax ADD<C>S is equivalent to ADDS<C>.

## Operation

```
if ConditionPassed() then
    EncodingSpecificOperations();
    shifted = Shift(R[m], shift_t, shift_n, APSR.C);
    (result, carry, overflow) = AddWithCarry(R[n], shifted, '0');
    if d == 15 then
        ALUWritePC(result); // setflags is always FALSE here
    else
        R[d] = result;
        if setflags then
            APSR.N = result<31>;
            APSR.Z = IsZeroBit(result);
            APSR.C = carry;
            APSR.V = overflow;
```

## Exceptions

None.

### A8.8.7 ADD (register, ARM)

This instruction adds a register value and an optionally-shifted register value, and writes the result to the destination register. It can optionally update the condition flags based on the result.

**Encoding A1** ARMv4\*, ARMv5T\*, ARMv6\*, ARMv7  
ADD{S}<c> <Rd>, <Rn>, <Rm>{, <shift>}

31	30	29	28	27	26	25	24	23	22	21	20	19	18	17	16	15	14	13	12	11	10	9	8	7	6	5	4	3	2	1	0
cond				0	0	0	0	1	0	0	S	Rn				Rd				imm5				type	0	Rm					

```
if Rd == '1111' && S == '1' then SEE SUBS PC, LR and related instructions;
if Rn == '1101' then SEE ADD (SP plus register);
d = UInt(Rd); n = UInt(Rn); m = UInt(Rm); setflags = (S == '1');
(shift_t, shift_n) = DecodeImmShift(type, imm5);
```

## Assembler syntax

ADD{S}{<c>}{<q>} {<Rd>}, <Rn>, <Rm> {, <shift>}

where:

- S            If S is present, the instruction updates the flags. Otherwise, the flags are not updated.
- <c>, <q>     See *Standard assembler syntax fields* on page A8-287.
- <Rd>        The destination register. If S is specified and <Rd> is the PC, see *SUBS PC, LR and related instructions (ARM)* on page B9-2010. If omitted, <Rd> is the same as <Rn>.
- If <Rd> is the PC and S is not specified, the instruction is a branch to the address calculated by the operation. This is an interworking branch, see *Pseudocode details of operations on ARM core registers* on page A2-47.
- **Note** —————
- Before ARMv7, this was a simple branch.
- 
- <Rn>        The first operand register. The PC can be used. If <Rn> is SP, see *ADD (SP plus register, Thumb)* on page A8-318.
- <Rm>        The register that is optionally shifted and used as the second operand. The PC can be used.
- <shift>     The shift to apply to the value read from <Rm>. If present, only encoding T3 or A1 is permitted. If omitted, no shift is applied and any encoding is permitted. *Shifts applied to a register* on page A8-291 describes the shifts and how they are encoded.

The pre-UAL syntax ADD<c>S is equivalent to ADDS<c>.

## Operation

```

if ConditionPassed() then
    EncodingSpecificOperations();
    shifted = Shift(R[m], shift_t, shift_n, APSR.C);
    (result, carry, overflow) = AddWithCarry(R[n], shifted, '0');
    if d == 15 then
        ALUWritePC(result); // setflags is always FALSE here
    else
        R[d] = result;
        if setflags then
            APSR.N = result<31>;
            APSR.Z = IsZeroBit(result);
            APSR.C = carry;
            APSR.V = overflow;

```

## Exceptions

None.

### A8.8.8 ADD (register-shifted register)

Add (register-shifted register) adds a register value and a register-shifted register value. It writes the result to the destination register, and can optionally update the condition flags based on the result.

**Encoding A1** ARMv4\*, ARMv5T\*, ARMv6\*, ARMv7

ADD{S}<c> <Rd>, <Rn>, <Rm>, <type> <Rs>

31	30	29	28	27	26	25	24	23	22	21	20	19	18	17	16	15	14	13	12	11	10	9	8	7	6	5	4	3	2	1	0
cond				0	0	0	0	1	0	0	S	Rn				Rd				Rs				0	type		1	Rm			

```
d = UInt(Rd); n = UInt(Rn); m = UInt(Rm); s = UInt(Rs);
setflags = (S == '1'); shift_t = DecodeRegShift(type);
if d == 15 || n == 15 || m == 15 || s == 15 then UNPREDICTABLE;
```

## Assembler syntax

ADD{S}{<c>}{<q>} {<Rd>}, <Rn>, <Rm>, <type> <Rs>

where:

S If S is present, the instruction updates the flags. Otherwise, the flags are not updated.

<c>, <q> See [Standard assembler syntax fields on page A8-287](#).

<Rd> The destination register.

<Rn> The first operand register.

<Rm> The register that is shifted and used as the second operand.

<type> The type of shift to apply to the value read from <Rm>. It must be one of:

ASR Arithmetic shift right, encoded as type = 0b10.

LSL Logical shift left, encoded as type = 0b00.

LSR Logical shift right, encoded as type = 0b01.

ROR Rotate right, encoded as type = 0b11.

<Rs> The register whose bottom byte contains the amount to shift by.

The pre-UAL syntax ADD<c>S is equivalent to ADDS<c>.

## Operation

```
if ConditionPassed() then
    EncodingSpecificOperations();
    shift_n = UInt(R[s]<7:0>);
    shifted = Shift(R[m], shift_t, shift_n, APSR.C);
    (result, carry, overflow) = AddWithCarry(R[n], shifted, '0');
    R[d] = result;
    if setflags then
        APSR.N = result<31>;
        APSR.Z = IsZeroBit(result);
        APSR.C = carry;
        APSR.V = overflow;
```

## Exceptions

None.

### A8.8.9 ADD (SP plus immediate)

This instruction adds an immediate value to the SP value, and writes the result to the destination register.

#### Encoding T1 ARMv4T, ARMv5T\*, ARMv6\*, ARMv7

ADD<c> <Rd>, SP, #<imm>

15	14	13	12	11	10	9	8	7	6	5	4	3	2	1	0
1	0	1	0	1			Rd	imm8							

d = UInt(Rd); setflags = FALSE; imm32 = ZeroExtend(imm8:'00', 32);

#### Encoding T2 ARMv4T, ARMv5T\*, ARMv6\*, ARMv7

ADD<c> SP, SP, #<imm>

15	14	13	12	11	10	9	8	7	6	5	4	3	2	1	0
1	0	1	1	0	0	0	0	0		imm7					

d = 13; setflags = FALSE; imm32 = ZeroExtend(imm7:'00', 32);

#### Encoding T3 ARMv6T2, ARMv7

ADD{S}<c>.W <Rd>, SP, #<const>

15	14	13	12	11	10	9	8	7	6	5	4	3	2	1	0	15	14	13	12	11	10	9	8	7	6	5	4	3	2	1	0
1	1	1	1	0	i	0	1	0	0	0	S	1	1	0	1	0	imm3		Rd	imm8											

if Rd == '1111' && S == '1' then SEE CMN (immediate);  
d = UInt(Rd); setflags = (S == '1'); imm32 = ThumbExpandImm(i:imm3:imm8);  
if d == 15 && S == '0' then UNPREDICTABLE;

#### Encoding T4 ARMv6T2, ARMv7

ADDW<c> <Rd>, SP, #<imm12>

15	14	13	12	11	10	9	8	7	6	5	4	3	2	1	0	15	14	13	12	11	10	9	8	7	6	5	4	3	2	1	0
1	1	1	1	0	i	1	0	0	0	0	0	1	1	0	1	0	imm3		Rd	imm8											

d = UInt(Rd); setflags = FALSE; imm32 = ZeroExtend(i:imm3:imm8, 32);  
if d == 15 then UNPREDICTABLE;

#### Encoding A1 ARMv4\*, ARMv5T\*, ARMv6\*, ARMv7

ADD{S}<c> <Rd>, SP, #<const>

31	30	29	28	27	26	25	24	23	22	21	20	19	18	17	16	15	14	13	12	11	10	9	8	7	6	5	4	3	2	1	0
cond		0	0	1	0	1	0	0	S	1	1	0	1		Rd	imm12															

if Rd == '1111' && S == '1' then SEE SUBS PC, LR and related instructions;  
d = UInt(Rd); setflags = (S == '1'); imm32 = ARMEExpandImm(imm12);



## Assembler syntax

ADD{S}{<c>}{<q>} {<Rd>}, SP, #<const>                    All encodings permitted  
ADDW{<c>}{<q>} {<Rd>}, SP, #<const>                    Only encoding T4 is permitted

where:

S                    If S is present, the instruction updates the flags. Otherwise, the flags are not updated.

<c>, <q>            See [Standard assembler syntax fields on page A8-287](#).

<Rd>                The destination register. If S is specified and <Rd> is the PC, see [SUBS PC, LR \(Thumb\) on page B9-2008](#) or [SUBS PC, LR and related instructions \(ARM\) on page B9-2010](#). If omitted, <Rd> is SP.

In ARM instructions, if S is not specified and <Rd> is the PC, the instruction is a branch to the address calculated by the operation. This is an interworking branch, see [Pseudocode details of operations on ARM core registers on page A2-47](#).

————— **Note** —————

Before ARMv7, this was a simple branch.

<const>            The immediate value to be added to the value obtained from SP. Values are multiples of 4 in the range 0-1020 for encoding T1, multiples of 4 in the range 0-508 for encoding T2 and any value in the range 0-4095 for encoding T4. See [Modified immediate constants in Thumb instructions on page A6-232](#) or [Modified immediate constants in ARM instructions on page A5-200](#) for the range of values for encodings T3 and A1.

When both 32-bit encodings are available for an instruction, encoding T3 is preferred to encoding T4.

————— **Note** —————

If encoding T4 is required, use the ADDW syntax.

The pre-UAL syntax ADD<c>S is equivalent to ADDS<c>.

## Operation

```
if ConditionPassed() then
    EncodingSpecificOperations();
    (result, carry, overflow) = AddWithCarry(SP, imm32, '0');
    if d == 15 then                    // Can only occur for ARM encoding
        ALUWritePC(result); // setflags is always FALSE here
    else
        R[d] = result;
        if setflags then
            APSR.N = result<31>;
            APSR.Z = IsZeroBit(result);
            APSR.C = carry;
            APSR.V = overflow;
```

## Exceptions

None.

### A8.8.10 ADD (SP plus register, Thumb)

This instruction adds an optionally-shifted register value to the SP value, and writes the result to the destination register.

#### Encoding T1 ARMv4T, ARMv5T\*, ARMv6\*, ARMv7

ADD<c> <Rdm>, SP, <Rdm>

15	14	13	12	11	10	9	8	7	6	5	4	3	2	1	0
0	1	0	0	0	1	0	0	1	1	0	1	Rdm			

DM—┘

```
d = UInt(DM:Rdm); m = UInt(DM:Rdm); setflags = FALSE;
if d == 15 && InITBlock() && !LastInITBlock() then UNPREDICTABLE;
(shift_t, shift_n) = (SRTYPE_LSL, 0);
```

#### Encoding T2 ARMv4T, ARMv5T\*, ARMv6\*, ARMv7

ADD<c> SP, <Rm>

15	14	13	12	11	10	9	8	7	6	5	4	3	2	1	0
0	1	0	0	0	1	0	0	1	Rm			1	0	1	

```
if Rm == '1101' then SEE encoding T1;
d = 13; m = UInt(Rm); setflags = FALSE;
(shift_t, shift_n) = (SRTYPE_LSL, 0);
```

#### Encoding T3 ARMv6T2, ARMv7

ADD{S}<c>.W <Rd>, SP, <Rm>{, <shift>}

15	14	13	12	11	10	9	8	7	6	5	4	3	2	1	0	15	14	13	12	11	10	9	8	7	6	5	4	3	2	1	0
1	1	1	0	1	0	1	1	0	0	0	S	1	1	0	1	(0)	imm3			Rd	imm2	type	Rm								

```
if Rd == '1111' && S == '1' then SEE CMN (register);
d = UInt(Rd); m = UInt(Rm); setflags = (S == '1');
(shift_t, shift_n) = DecodeImmShift(type, imm3:imm2);
if d == 13 && (shift_t != SRTYPE_LSL || shift_n > 3) then UNPREDICTABLE;
if (d == 15 && S == '0') || m IN {13,15} then UNPREDICTABLE;
```

## Assembler syntax

ADD{S}{<c>}{<q>} {<Rd>}, SP, <Rm>{, <shift>}

where:

- S If S is present, the instruction updates the flags. Otherwise, the flags are not updated.
- <c>, <q> See [Standard assembler syntax fields on page A8-287](#).
- <Rd> The destination register. If S is specified and <Rd> is the PC, see [CMN \(register\) on page A8-366](#). This register can be SP. If omitted, <Rd> is SP. This register can be the PC, but if it is, encoding T3 is not permitted. ARM deprecates using the PC.  
If <Rd> is the PC and S is not specified, encoding T1 is used and the instruction is a branch to the address calculated by the operation. This is a simple branch, see [Pseudocode details of operations on ARM core registers on page A2-47](#).
- <Rm> The register that is optionally shifted and used as the second operand. This register can be the PC, but if it is, encoding T3 is not permitted. ARM deprecates using the PC. This register can be the SP, but:  
  - ARM deprecates using the SP
  - only encoding T1 is available and so the instruction can only be ADD SP, SP, SP.
- <shift> The shift to apply to the value read from <Rm>. If omitted, no shift is applied and any encoding is permitted. If present, only encoding T3 is permitted. [Shifts applied to a register on page A8-291](#) describes the shifts and how they are encoded.  
If <Rd> is SP or omitted, <shift> is only permitted to be omitted, LSL #1, LSL #2, or LSL #3.

The pre-UAL syntax ADD<c>S is equivalent to ADDS<c>.

## Operation

```
if ConditionPassed() then
    EncodingSpecificOperations();
    shifted = Shift(R[m], shift_t, shift_n, APSR.C);
    (result, carry, overflow) = AddWithCarry(SP, shifted, '0');
    if d == 15 then
        ALUWritePC(result); // setflags is always FALSE here
    else
        R[d] = result;
        if setflags then
            APSR.N = result<31>;
            APSR.Z = IsZeroBit(result);
            APSR.C = carry;
            APSR.V = overflow;
```

## Exceptions

None.

### A8.8.11 ADD (SP plus register, ARM)

This instruction adds an optionally-shifted register value to the SP value, and writes the result to the destination register.

**Encoding A1** ARMv4\*, ARMv5T\*, ARMv6\*, ARMv7  
ADD{S}<c> <Rd>, SP, <Rm>{, <shift>}

31	30	29	28	27	26	25	24	23	22	21	20	19	18	17	16	15	14	13	12	11	10	9	8	7	6	5	4	3	2	1	0
cond				0	0	0	0	1	0	0	S	1	1	0	1	Rd				imm5				type	0	Rm					

if Rd == '1111' && S == '1' then SEE SUBS PC, LR and related instructions;  
d = UInt(Rd); m = UInt(Rm); setflags = (S == '1');  
(shift\_t, shift\_n) = DecodeImmShift(type, imm5);

## Assembler syntax

ADD{S}{<c>}{<q>} {<Rd>}, SP, <Rm>{, <shift>}

where:

- S            If S is present, the instruction updates the flags. Otherwise, the flags are not updated.
- <c>, <q>     See *Standard assembler syntax fields* on page A8-287.
- <Rd>        The destination register. If S is specified and <Rd> is the PC, see *SUBS PC, LR and related instructions (ARM)* on page B9-2010. This register can be SP. If omitted, <Rd> is SP. This register can be the PC, but ARM deprecates using the PC.
- If S is not specified and <Rd> is the PC, the instruction is a branch to the address calculated by the operation. This is an interworking branch, see *Pseudocode details of operations on ARM core registers* on page A2-47.
- **Note** —————
- Before ARMv7, this was a simple branch.
- 
- <Rm>        The register that is optionally shifted and used as the second operand. This register can be the PC, but ARM deprecates using the PC. This register can be the SP, but ARM deprecates using the SP.
- <shift>     The shift to apply to the value read from <Rm>. If omitted, no shift is applied and any encoding is permitted. *Shifts applied to a register* on page A8-291 describes the shifts and how they are encoded.

The pre-UAL syntax ADD<c>S is equivalent to ADDS<c>.

## Operation

```

if ConditionPassed() then
    EncodingSpecificOperations();
    shifted = Shift(R[m], shift_t, shift_n, APSR.C);
    (result, carry, overflow) = AddWithCarry(SP, shifted, '0');
    if d == 15 then
        ALUWritePC(result); // setflags is always FALSE here
    else
        R[d] = result;
        if setflags then
            APSR.N = result<31>;
            APSR.Z = IsZeroBit(result);
            APSR.C = carry;
            APSR.V = overflow;

```

## Exceptions

None.

## A8.8.12 ADR

This instruction adds an immediate value to the PC value to form a PC-relative address, and writes the result to the destination register.

### Encoding T1 ARMv4T, ARMv5T\*, ARMv6\*, ARMv7

ADR<c> <Rd>, <label>

15	14	13	12	11	10	9	8	7	6	5	4	3	2	1	0	
1	0	1	0	0	Rd				imm8							

d = UInt(Rd); imm32 = ZeroExtend(imm8:'00', 32); add = TRUE;

### Encoding T2 ARMv6T2, ARMv7

ADR<c>.W <Rd>, <label>

<label> before current instruction

SUB <Rd>, PC, #0

Special case for subtraction of zero

15	14	13	12	11	10	9	8	7	6	5	4	3	2	1	0	15	14	13	12	11	10	9	8	7	6	5	4	3	2	1	0
1	1	1	1	0	i	1	0	1	0	1	0	1	0	1	1	1	0	imm3	Rd				imm8								

d = UInt(Rd); imm32 = ZeroExtend(i:imm3:imm8, 32); add = FALSE;  
if d IN {13,15} then UNPREDICTABLE;

### Encoding T3 ARMv6T2, ARMv7

ADR<c>.W <Rd>, <label>

<label> after current instruction

15	14	13	12	11	10	9	8	7	6	5	4	3	2	1	0	15	14	13	12	11	10	9	8	7	6	5	4	3	2	1	0
1	1	1	1	0	i	1	0	0	0	0	0	1	1	1	1	0	imm3	Rd				imm8									

d = UInt(Rd); imm32 = ZeroExtend(i:imm3:imm8, 32); add = TRUE;  
if d IN {13,15} then UNPREDICTABLE;

### Encoding A1 ARMv4\*, ARMv5T\*, ARMv6\*, ARMv7

ADR<c> <Rd>, <label>

<label> after current instruction

31	30	29	28	27	26	25	24	23	22	21	20	19	18	17	16	15	14	13	12	11	10	9	8	7	6	5	4	3	2	1	0
cond		0	0	1	0	1	0	0	0	1	1	1	1	Rd				imm12													

d = UInt(Rd); imm32 = ARMEExpandImm(imm12); add = TRUE;

### Encoding A2 ARMv4\*, ARMv5T\*, ARMv6\*, ARMv7

ADR<c> <Rd>, <label>

<label> before current instruction

SUB <Rd>, PC, #0

Special case for subtraction of zero

31	30	29	28	27	26	25	24	23	22	21	20	19	18	17	16	15	14	13	12	11	10	9	8	7	6	5	4	3	2	1	0
cond		0	0	1	0	0	1	0	0	1	1	1	1	Rd				imm12													

d = UInt(Rd); imm32 = ARMEExpandImm(imm12); add = FALSE;

## Assembler syntax

ADR{<c>}{<q>} <Rd>, <label>	Normal syntax
ADD{<c>}{<q>} <Rd>, PC, #<const>	Alternative for encodings T1, T3, A1
SUB{<c>}{<q>} <Rd>, PC, #<const>	Alternative for encoding T2, A2

where:

<c>, <q> See [Standard assembler syntax fields on page A8-287](#).

<Rd> The destination register. In ARM instructions, if <Rd> is the PC, the instruction is a branch to the address calculated by the operation. This is an interworking branch, see [Pseudocode details of operations on ARM core registers on page A2-47](#).

### ————— Note —————

Before ARMv7, this was a simple branch.

<label> The label of an instruction or literal data item whose address is to be loaded into <Rd>. The assembler calculates the required value of the offset from the `Align(PC, 4)` value of the ADR instruction to this label.

If the offset is zero or positive, encodings T1, T3, and A1 are permitted, with `imm32` equal to the offset.

If the offset is negative, encodings T2 and A2 are permitted, with `imm32` equal to the size of the offset. That is, the use of encoding T2 or A2 indicates that the required offset is minus the value of `imm32`.

Permitted values of the size of the offset are:

**Encoding T1** Multiples of 4 in the range 0 to 1020.

**Encodings T2, T3** Any value in the range 0 to 4095.

**Encodings A1, A2** Any of the constants described in [Modified immediate constants in ARM instructions on page A5-200](#).

The alternative syntax permits the addition or subtraction of the offset and the immediate offset to be specified separately, including permitting a subtraction of 0 that cannot be specified using the normal syntax. For more information, see [Use of labels in UAL instruction syntax on page A4-162](#).

## Operation

```

if ConditionPassed() then
    EncodingSpecificOperations();
    result = if add then (Align(PC,4) + imm32) else (Align(PC,4) - imm32);
    if d == 15 then // Can only occur for ARM encodings
        ALUWritePC(result);
    else
        R[d] = result;

```

## Exceptions

None.

### A8.8.13 AND (immediate)

This instruction performs a bitwise AND of a register value and an immediate value, and writes the result to the destination register.

#### Encoding T1 ARMv6T2, ARMv7

AND{S}<c> <Rd>, <Rn>, #<const>

15	14	13	12	11	10	9	8	7	6	5	4	3	2	1	0	15	14	13	12	11	10	9	8	7	6	5	4	3	2	1	0
1	1	1	1	0	i	0	0	0	0	0	S	Rn				0	imm3			Rd			imm8								

if Rd == '1111' && S == '1' then SEE TST (immediate);  
d = UInt(Rd); n = UInt(Rn); setflags = (S == '1');  
(imm32, carry) = ThumbExpandImm\_C(i:imm3:imm8, APSR.C);  
if d == 13 || (d == 15 && S == '0') || n IN {13,15} then UNPREDICTABLE;

#### Encoding A1 ARMv4\*, ARMv5T\*, ARMv6\*, ARMv7

AND{S}<c> <Rd>, <Rn>, #<const>

31	30	29	28	27	26	25	24	23	22	21	20	19	18	17	16	15	14	13	12	11	10	9	8	7	6	5	4	3	2	1	0
cond		0	0	1	0	0	0	0	S	Rn				Rd			imm12														

if Rd == '1111' && S == '1' then SEE SUBS PC, LR and related instructions;  
d = UInt(Rd); n = UInt(Rn); setflags = (S == '1');  
(imm32, carry) = ARMEExpandImm\_C(imm12, APSR.C);



## Assembler syntax

AND{S}{<c>}{<q>} {<Rd>}, <Rn>, #<const>

where:

- S            If S is present, the instruction updates the flags. Otherwise, the flags are not updated.
- <c>, <q>     See *Standard assembler syntax fields* on page A8-287.
- <Rd>        The destination register. If S is specified and <Rd> is the PC, see *SUBS PC, LR (Thumb)* on page B9-2008 or *SUBS PC, LR and related instructions (ARM)* on page B9-2010.  
In ARM instructions, if S is not specified and <Rd> is the PC, the instruction is a branch to the address calculated by the operation. This is an interworking branch, see *Pseudocode details of operations on ARM core registers* on page A2-47.
- **Note** —————  
Before ARMv7, this was a simple branch.
- <Rn>        The first operand register. The PC can be used in ARM instructions.
- <const>     The immediate value to be ANDed with the value obtained from <Rn>. See *Modified immediate constants in Thumb instructions* on page A6-232 or *Modified immediate constants in ARM instructions* on page A5-200 for the range of values.

The pre-UAL syntax AND<c>S is equivalent to ANDS<c>.

## Operation

```
if ConditionPassed() then
    EncodingSpecificOperations();
    result = R[n] AND imm32;
    if d == 15 then           // Can only occur for ARM encoding
        ALUWritePC(result); // setflags is always FALSE here
    else
        R[d] = result;
        if setflags then
            APSR.N = result<31>;
            APSR.Z = IsZeroBit(result);
            APSR.C = carry;
            // APSR.V unchanged
```

## Exceptions

None.

### A8.8.14 AND (register)

This instruction performs a bitwise AND of a register value and an optionally-shifted register value, and writes the result to the destination register. It can optionally update the condition flags based on the result.

#### Encoding T1 ARMv4T, ARMv5T\*, ARMv6\*, ARMv7

ANDS <Rdn>, <Rm> Outside IT block.  
AND<c> <Rdn>, <Rm> Inside IT block.

15	14	13	12	11	10	9	8	7	6	5	4	3	2	1	0
0	1	0	0	0	0	0	0	0	0	Rm	Rdn				

d = UInt(Rdn); n = UInt(Rdn); m = UInt(Rm); setflags = !InITBlock();  
(shift\_t, shift\_n) = (SRTYPE\_LSL, 0);

#### Encoding T2 ARMv6T2, ARMv7

AND{S}<c>.W <Rd>, <Rn>, <Rm>{, <shift>}

15	14	13	12	11	10	9	8	7	6	5	4	3	2	1	0	15	14	13	12	11	10	9	8	7	6	5	4	3	2	1	0
1	1	1	0	1	0	1	0	0	0	0	S	Rn				(0)	imm3	Rd	imm2	type	Rm										

if Rd == '1111' && S == '1' then SEE TST (register);  
d = UInt(Rd); n = UInt(Rn); m = UInt(Rm); setflags = (S == '1');  
(shift\_t, shift\_n) = DecodeImmShift(type, imm3:imm2);  
if d == 13 || (d == 15 && S == '0') || n IN {13,15} || m IN {13,15} then UNPREDICTABLE;

#### Encoding A1 ARMv4\*, ARMv5T\*, ARMv6\*, ARMv7

AND{S}<c> <Rd>, <Rn>, <Rm>{, <shift>}

31	30	29	28	27	26	25	24	23	22	21	20	19	18	17	16	15	14	13	12	11	10	9	8	7	6	5	4	3	2	1	0
cond			0	0	0	0	0	0	0	S	Rn				Rd				imm5	type	0	Rm									

if Rd == '1111' && S == '1' then SEE SUBS PC, LR and related instructions;  
d = UInt(Rd); n = UInt(Rn); m = UInt(Rm); setflags = (S == '1');  
(shift\_t, shift\_n) = DecodeImmShift(type, imm5);

## Assembler syntax

AND{S}{<c>}{<q>} {<Rd>}, <Rn>, <Rm> {, <shift>}

where:

- S                    If S is present, the instruction updates the flags. Otherwise, the flags are not updated.
- <c>, <q>            See *Standard assembler syntax fields* on page A8-287.
- <Rd>                The destination register. If S is specified and <Rd> is the PC, see *SUBS PC, LR (Thumb)* on page B9-2008 or *SUBS PC, LR and related instructions (ARM)* on page B9-2010.  
In ARM instructions, if S is not specified and <Rd> is the PC, the instruction is a branch to the address calculated by the operation. This is an interworking branch, see *Pseudocode details of operations on ARM core registers* on page A2-47.
- **Note** —————  
Before ARMv7, this was a simple branch.
- <Rn>                The first operand register. The PC can be used in ARM instructions.
- <Rm>                The register that is optionally shifted and used as the second operand. The PC can be used in ARM instructions.
- <shift>             The shift to apply to the value read from <Rm>. If present, encoding T1 is not permitted. If absent, no shift is applied and all encodings are permitted. *Shifts applied to a register* on page A8-291 describes the shifts and how they are encoded.

In Thumb assembly:

- outside an IT block, if ANDS <Rd>, <Rn>, <Rd> has <Rd> and <Rn> both in the range R0-R7, it is assembled using encoding T1 as though ANDS <Rd>, <Rn> had been written
- inside an IT block, if AND<c> <Rd>, <Rn>, <Rd> has <Rd> and <Rn> both in the range R0-R7, it is assembled using encoding T1 as though AND<c> <Rd>, <Rn> had been written.

To prevent either of these happening, use the .W qualifier.

The pre-UAL syntax AND<c>S is equivalent to ANDS<c>.

## Operation

```
if ConditionPassed() then
    EncodingSpecificOperations();
    (shifted, carry) = Shift_C(R[m], shift_t, shift_n, APSR.C);
    result = R[n] AND shifted;
    if d == 15 then // Can only occur for ARM encoding
        ALUWritePC(result); // setflags is always FALSE here
    else
        R[d] = result;
        if setflags then
            APSR.N = result<31>;
            APSR.Z = IsZeroBit(result);
            APSR.C = carry;
            // APSR.V unchanged
```

## Exceptions

None.

### A8.8.15 AND (register-shifted register)

This instruction performs a bitwise AND of a register value and a register-shifted register value. It writes the result to the destination register, and can optionally update the condition flags based on the result.

**Encoding A1** ARMv4\*, ARMv5T\*, ARMv6\*, ARMv7

AND{S}<c> <Rd>, <Rn>, <Rm>, <type> <Rs>

31	30	29	28	27	26	25	24	23	22	21	20	19	18	17	16	15	14	13	12	11	10	9	8	7	6	5	4	3	2	1	0
cond				0	0	0	0	0	0	0	S	Rn				Rd				Rs				0	type		1	Rm			

```
d = UInt(Rd); n = UInt(Rn); m = UInt(Rm); s = UInt(Rs);
setflags = (S == '1'); shift_t = DecodeRegShift(type);
if d == 15 || n == 15 || m == 15 || s == 15 then UNPREDICTABLE;
```

## Assembler syntax

AND{S}{<c>}{<q>} {<Rd>}, <Rn>, <Rm>, <type> <Rs>

where:

S If S is present, the instruction updates the flags. Otherwise, the flags are not updated.

<c>, <q> See *Standard assembler syntax fields on page A8-287*.

<Rd> The destination register.

<Rn> The first operand register.

<Rm> The register that is shifted and used as the second operand.

<type> The type of shift to apply to the value read from <Rm>. It must be one of:

ASR Arithmetic shift right, encoded as type = 0b10.

LSL Logical shift left, encoded as type = 0b00.

LSR Logical shift right, encoded as type = 0b01.

ROR Rotate right, encoded as type = 0b11.

<Rs> The register whose bottom byte contains the amount to shift by.

The pre-UAL syntax AND<c>S is equivalent to ANDS<c>.

## Operation

```
if ConditionPassed() then
    EncodingSpecificOperations();
    shift_n = UInt(R[s]<7:0>);
    (shifted, carry) = Shift_C(R[m], shift_t, shift_n, APSR.C);
    result = R[n] AND shifted;
    R[d] = result;
    if setflags then
        APSR.N = result<31>;
        APSR.Z = IsZeroBit(result);
        APSR.C = carry;
        // APSR.V unchanged
```

## Exceptions

None.

### A8.8.16 ASR (immediate)

Arithmetic Shift Right (immediate) shifts a register value right by an immediate number of bits, shifting in copies of its sign bit, and writes the result to the destination register. It can optionally update the condition flags based on the result.

#### Encoding T1 ARMv4T, ARMv5T\*, ARMv6\*, ARMv7

ASRS <Rd>, <Rm>, #<imm> Outside IT block.  
ASR<c> <Rd>, <Rm>, #<imm> Inside IT block.

15	14	13	12	11	10	9	8	7	6	5	4	3	2	1	0
0	0	0	1	0	imm5					Rm			Rd		

```
d = UInt(Rd); m = UInt(Rm); setflags = !InITBlock();
(-, shift_n) = DecodeImmShift('10', imm5);
```

#### Encoding T2 ARMv6T2, ARMv7

ASR{S}<c>.W <Rd>, <Rm>, #<imm>

15	14	13	12	11	10	9	8	7	6	5	4	3	2	1	0	15	14	13	12	11	10	9	8	7	6	5	4	3	2	1	0
1	1	1	0	1	0	1	0	0	1	0	S	1	1	1	1	(0)	imm3			Rd			imm2		1	0	Rm				

```
d = UInt(Rd); m = UInt(Rm); setflags = (S == '1');
(-, shift_n) = DecodeImmShift('10', imm3:imm2);
if d IN {13,15} || m IN {13,15} then UNPREDICTABLE;
```

#### Encoding A1 ARMv4\*, ARMv5T\*, ARMv6\*, ARMv7

ASR{S}<c> <Rd>, <Rm>, #<imm>

31	30	29	28	27	26	25	24	23	22	21	20	19	18	17	16	15	14	13	12	11	10	9	8	7	6	5	4	3	2	1	0
cond			0	0	0	1	1	0	1	S	(0)	(0)	(0)	(0)	Rd			imm5					1	0	0	Rm					

```
if Rd == '1111' && S == '1' then SEE SUBS PC, LR and related instructions;
d = UInt(Rd); m = UInt(Rm); setflags = (S == '1');
(-, shift_n) = DecodeImmShift('10', imm5);
```

## Assembler syntax

ASR{S}{<c>}{<q>} {<Rd>}, <Rm>, #<imm>

where:

S If S is present, the instruction updates the flags. Otherwise, the flags are not updated.

<c>, <q> See [Standard assembler syntax fields on page A8-287](#).

<Rd> The destination register.

In ARM instructions, if S is not specified and <Rd> is the PC, the instruction is a branch to the address calculated by the operation. This is an interworking branch, see [Pseudocode details of operations on ARM core registers on page A2-47](#).

### Note

Before ARMv7, this was a simple branch.

<Rm> The first operand register. The PC can be used in ARM instructions.

<imm> The shift amount, in the range 1 to 32. See [Shifts applied to a register on page A8-291](#).

## Operation

```
if ConditionPassed() then
    EncodingSpecificOperations();
    (result, carry) = Shift_C(R[m], SRTYPE_ASR, shift_n, APSR.C);
    if d == 15 then // Can only occur for ARM encoding
        ALUWritePC(result); // setflags is always FALSE here
    else
        R[d] = result;
        if setflags then
            APSR.N = result<31>;
            APSR.Z = IsZeroBit(result);
            APSR.C = carry;
            // APSR.V unchanged
```

## Exceptions

None.

### A8.8.17 ASR (register)

Arithmetic Shift Right (register) shifts a register value right by a variable number of bits, shifting in copies of its sign bit, and writes the result to the destination register. The variable number of bits is read from the bottom byte of a register. It can optionally update the condition flags based on the result.

**Encoding T1** ARMv4T, ARMv5T\*, ARMv6\*, ARMv7

ASRS <Rdn>, <Rm> Outside IT block.  
ASR<c> <Rdn>, <Rm> Inside IT block.

15	14	13	12	11	10	9	8	7	6	5	4	3	2	1	0
0	1	0	0	0	0	0	1	0	0	Rm					Rdn

d = UInt(Rdn); n = UInt(Rdn); m = UInt(Rm); setFlags = !InITBlock();

**Encoding T2** ARMv6T2, ARMv7

ASR{S}<c>.W <Rd>, <Rn>, <Rm>

15	14	13	12	11	10	9	8	7	6	5	4	3	2	1	0	15	14	13	12	11	10	9	8	7	6	5	4	3	2	1	0
1	1	1	1	1	0	1	0	0	1	0	S			Rn		1	1	1	1		Rd		0	0	0	0		Rm			

d = UInt(Rd); n = UInt(Rn); m = UInt(Rm); setFlags = (S == '1');  
if d IN {13,15} || n IN {13,15} || m IN {13,15} then UNPREDICTABLE;

**Encoding A1** ARMv4\*, ARMv5T\*, ARMv6\*, ARMv7

ASR{S}<c> <Rd>, <Rn>, <Rm>

31	30	29	28	27	26	25	24	23	22	21	20	19	18	17	16	15	14	13	12	11	10	9	8	7	6	5	4	3	2	1	0
cond		0	0	0	1	1	0	1	(S)	(0)	(0)	(0)	(0)		Rd		Rm		0	1	0	1							Rn		

d = UInt(Rd); n = UInt(Rn); m = UInt(Rm); setFlags = (S == '1');  
if d == 15 || n == 15 || m == 15 then UNPREDICTABLE;



## Assembler syntax

ASR{S}{<c>}{<q>} {<Rd>}, <Rn>, <Rm>

where:

S            If S is present, the instruction updates the flags. Otherwise, the flags are not updated.

<c>, <q>     See *Standard assembler syntax fields* on page A8-287.

<Rd>        The destination register.

<Rn>        The first operand register.

<Rm>        The register whose bottom byte contains the amount to shift by.

## Operation

```
if ConditionPassed() then
    EncodingSpecificOperations();
    shift_n = UInt(R[m]<7:0>);
    (result, carry) = Shift_C(R[n], SRTYPE_ASR, shift_n, APSR.C);
    R[d] = result;
    if setflags then
        APSR.N = result<31>;
        APSR.Z = IsZeroBit(result);
        APSR.C = carry;
        // APSR.V unchanged
```

## Exceptions

None.

## A8.8.18 B

Branch causes a branch to a target address.

### Encoding T1 ARMv4T, ARMv5T\*, ARMv6\*, ARMv7

B<c> <label> Not permitted in IT block.

15	14	13	12	11	10	9	8	7	6	5	4	3	2	1	0
1	1	0	1	cond				imm8							

```
if cond == '1110' then UNDEFINED;
if cond == '1111' then SEE SVC;
imm32 = SignExtend(imm8:'0', 32);
if InITBlock() then UNPREDICTABLE;
```

### Encoding T2 ARMv4T, ARMv5T\*, ARMv6\*, ARMv7

B<c> <label> Outside or last in IT block

15	14	13	12	11	10	9	8	7	6	5	4	3	2	1	0
1	1	1	0	0	imm11										

```
imm32 = SignExtend(imm11:'0', 32);
if InITBlock() && !LastInITBlock() then UNPREDICTABLE;
```

### Encoding T3 ARMv6T2, ARMv7

B<c>.W <label> Not permitted in IT block.

15	14	13	12	11	10	9	8	7	6	5	4	3	2	1	0	15	14	13	12	11	10	9	8	7	6	5	4	3	2	1	0
1	1	1	1	0	S	cond				imm6				1	0	J1	0	J2	imm11												

```
if cond<3:1> == '111' then SEE "Related encodings";
imm32 = SignExtend(S:J2:J1:imm6:imm11:'0', 32);
if InITBlock() then UNPREDICTABLE;
```

### Encoding T4 ARMv6T2, ARMv7

B<c>.W <label> Outside or last in IT block

15	14	13	12	11	10	9	8	7	6	5	4	3	2	1	0	15	14	13	12	11	10	9	8	7	6	5	4	3	2	1	0
1	1	1	1	0	S	imm10								1	0	J1	1	J2	imm11												

```
I1 = NOT(J1 EOR S); I2 = NOT(J2 EOR S); imm32 = SignExtend(S:I1:I2:imm10:imm11:'0', 32);
if InITBlock() && !LastInITBlock() then UNPREDICTABLE;
```

### Encoding A1 ARMv4\*, ARMv5T\*, ARMv6\*, ARMv7

B<c> <label>

31	30	29	28	27	26	25	24	23	22	21	20	19	18	17	16	15	14	13	12	11	10	9	8	7	6	5	4	3	2	1	0					
cond				1	0	1	0	imm24																												

```
imm32 = SignExtend(imm24:'00', 32);
```

**Related encodings** See [Branches and miscellaneous control](#) on page A6-235.

## Assembler syntax

B{<c>}{<q>} <label>

where:

<c>, <q> See *Standard assembler syntax fields* on page A8-287.

### Note

Encodings T1 and T3 are conditional in their own right, and do not require an IT instruction to make them conditional.

For encodings T1 and T3, <c> must not be AL or omitted. The 4-bit encoding of the condition is placed in the instruction and not in a preceding IT instruction, and the instruction must not be in an IT block. As a result, encodings T1 and T2 are never both available to the assembler, nor are encodings T3 and T4.

<label> The label of the instruction that is to be branched to. The assembler calculates the required value of the offset from the PC value of the B instruction to this label, then selects an encoding that sets imm32 to that offset.

Permitted offsets are:

<b>Encoding T1</b>	Even numbers in the range –256 to 254
<b>Encoding T2</b>	Even numbers in the range –2048 to 2046
<b>Encoding T3</b>	Even numbers in the range –1048576 to 1048574
<b>Encoding T4</b>	Even numbers in the range –16777216 to 16777214
<b>Encoding A1</b>	Multiples of 4 in the range –33554432 to 33554428.

## Operation

```
if ConditionPassed() then
    EncodingSpecificOperations();
    BranchWritePC(PC + imm32);
```

## Exceptions

None.

### A8.8.19 BFC

Bit Field Clear clears any number of adjacent bits at any position in a register, without affecting the other bits in the register.

#### Encoding T1 ARMv6T2, ARMv7

BFC<c> <Rd>, #<lsb>, #<width>

15	14	13	12	11	10	9	8	7	6	5	4	3	2	1	0	15	14	13	12	11	10	9	8	7	6	5	4	3	2	1	0
1	1	1	1	0	(0)	1	1	0	1	1	0	1	1	1	1	0	imm3	Rd	imm2	(0)	msb										

d = UInt(Rd); msbit = UInt(msb); lsbit = UInt(imm3:imm2);  
if d IN {13,15} then UNPREDICTABLE;

#### Encoding A1 ARMv6T2, ARMv7

BFC<c> <Rd>, #<lsb>, #<width>

31	30	29	28	27	26	25	24	23	22	21	20	19	18	17	16	15	14	13	12	11	10	9	8	7	6	5	4	3	2	1	0
cond		0	1	1	1	1	1	0	msb				Rd				lsb				0	0	1	1 1 1 1							

d = UInt(Rd); msbit = UInt(msb); lsbit = UInt(lsb);  
if d == 15 then UNPREDICTABLE;

## Assembler syntax

BFC{<c>}{<q>} <Rd>, #<lsb>, #<width>

where:

- <c>, <q> See [Standard assembler syntax fields on page A8-287](#).
- <Rd> The destination register.
- <lsb> The least significant bit that is to be cleared, in the range 0 to 31. This determines the required value of `lsbit`.
- <width> The number of bits to be cleared, in the range 1 to 32-<lsb>. The required value of `msbit` is `<lsb>+<width>-1`.

## Operation

```
if ConditionPassed() then
    EncodingSpecificOperations();
    if msbit >= lsbit then
        R[d]<msbit:lsbit> = Replicate('0', msbit-lsbit+1);
        // Other bits of R[d] are unchanged
    else
        UNPREDICTABLE;
```

## Exceptions

None.

## A8.8.20 BFI

Bit Field Insert copies any number of low order bits from a register into the same number of adjacent bits at any position in the destination register.

### Encoding T1 ARMv6T2, ARMv7

BFI<c> <Rd>, <Rn>, #<lsb>, #<width>

15	14	13	12	11	10	9	8	7	6	5	4	3	2	1	0	15	14	13	12	11	10	9	8	7	6	5	4	3	2	1	0
1	1	1	1	0	(0)	1	1	0	1	1	0	Rn			0	imm3			Rd			imm2			(0)	msb					

if Rn == '1111' then SEE BFC;  
d = UInt(Rd); n = UInt(Rn); msbit = UInt(msb); lsbbit = UInt(imm3:imm2);  
if d IN {13,15} || n == 13 then UNPREDICTABLE;

### Encoding A1 ARMv6T2, ARMv7

BFI<c> <Rd>, <Rn>, #<lsb>, #<width>

31	30	29	28	27	26	25	24	23	22	21	20	19	18	17	16	15	14	13	12	11	10	9	8	7	6	5	4	3	2	1	0
cond		0	1	1	1	1	1	0	msb			Rd			lsb			0	0	1	Rn										

if Rn == '1111' then SEE BFC;  
d = UInt(Rd); n = UInt(Rn); msbit = UInt(msb); lsbbit = UInt(lsb);  
if d == 15 then UNPREDICTABLE;

## Assembler syntax

BFI{<c>}{<q>} <Rd>, <Rn>, #<lsb>, #<width>

where:

- <c>, <q> See *Standard assembler syntax fields* on page A8-287.
- <Rd> The destination register.
- <Rn> The source register.
- <lsb> The least significant destination bit, in the range 0 to 31. This determines the required value of `lsbit`.
- <width> The number of bits to be copied, in the range 1 to 32-`<lsb>`. The required value of `msbit` is `<lsb>+<width>-1`.

## Operation

```
if ConditionPassed() then
    EncodingSpecificOperations();
    if msbit >= lsbit then
        R[d]<msbit:lsbit> = R[n]<(msbit-lsbit):0>;
        // Other bits of R[d] are unchanged
    else
        UNPREDICTABLE;
```

## Exceptions

None.

### A8.8.21 BIC (immediate)

Bitwise Bit Clear (immediate) performs a bitwise AND of a register value and the complement of an immediate value, and writes the result to the destination register. It can optionally update the condition flags based on the result.

#### Encoding T1 ARMv6T2, ARMv7

BIC{S}<c> <Rd>, <Rn>, #<const>

15	14	13	12	11	10	9	8	7	6	5	4	3	2	1	0	15	14	13	12	11	10	9	8	7	6	5	4	3	2	1	0
1	1	1	1	0	i	0	0	0	0	1	S	Rn				0	imm3			Rd			imm8								

```
d = UInt(Rd); n = UInt(Rn); setflags = (S == '1');
(imm32, carry) = ThumbExpandImm_C(i:imm3:imm8, APSR.C);
if d IN {13,15} || n IN {13,15} then UNPREDICTABLE;
```

#### Encoding A1 ARMv4\*, ARMv5T\*, ARMv6\*, ARMv7

BIC{S}<c> <Rd>, <Rn>, #<const>

31	30	29	28	27	26	25	24	23	22	21	20	19	18	17	16	15	14	13	12	11	10	9	8	7	6	5	4	3	2	1	0
cond		0	0	1	1	1	1	0	S	Rn				Rd				imm12													

```
if Rd == '1111' && S == '1' then SEE SUBS PC, LR and related instructions;
d = UInt(Rd); n = UInt(Rn); setflags = (S == '1');
(imm32, carry) = ARMEExpandImm_C(imm12, APSR.C);
```



## Assembler syntax

BIC{S}{<c>}{<q>} {<Rd>}, <Rn>, #<const>

where:

- S            If S is present, the instruction updates the flags. Otherwise, the flags are not updated.
- <c>, <q>     See *Standard assembler syntax fields* on page A8-287.
- <Rd>        The destination register. If S is specified and <Rd> is the PC, see *SUBS PC, LR (Thumb)* on page B9-2008 or *SUBS PC, LR and related instructions (ARM)* on page B9-2010.  
In ARM instructions, if S is not specified and <Rd> is the PC, the instruction is a branch to the address calculated by the operation. This is an interworking branch, see *Pseudocode details of operations on ARM core registers* on page A2-47.
- **Note** —————
- Before ARMv7, this was a simple branch.
- 
- <Rn>        The register that contains the operand. The PC can be used in ARM instructions.
- <const>     The immediate value to be bitwise inverted and ANDed with the value obtained from <Rn>. See *Modified immediate constants in Thumb instructions* on page A6-232 or *Modified immediate constants in ARM instructions* on page A5-200 for the range of values.

The pre-UAL syntax BIC<c>S is equivalent to BICS<c>.

## Operation

```

if ConditionPassed() then
    EncodingSpecificOperations();
    result = R[n] AND NOT(imm32);
    if d == 15 then           // Can only occur for ARM encoding
        ALUWritePC(result); // setflags is always FALSE here
    else
        R[d] = result;
        if setflags then
            APSR.N = result<31>;
            APSR.Z = IsZeroBit(result);
            APSR.C = carry;
            // APSR.V unchanged
    
```

## Exceptions

None.

## A8.8.22 BIC (register)

Bitwise Bit Clear (register) performs a bitwise AND of a register value and the complement of an optionally-shifted register value, and writes the result to the destination register. It can optionally update the condition flags based on the result.

### Encoding T1 ARMv4T, ARMv5T\*, ARMv6\*, ARMv7

BICS <Rdn>, <Rm> Outside IT block.  
BIC<c> <Rdn>, <Rm> Inside IT block.

15	14	13	12	11	10	9	8	7	6	5	4	3	2	1	0
0	1	0	0	0	0	1	1	1	0	Rm	Rdn				

```
d = UInt(Rdn); n = UInt(Rdn); m = UInt(Rm); setflags = !InITBlock();
(shift_t, shift_n) = (SRTYPE_LSL, 0);
```

### Encoding T2 ARMv6T2, ARMv7

BIC{S}<c>.W <Rd>, <Rn>, <Rm>{, <shift>}

15	14	13	12	11	10	9	8	7	6	5	4	3	2	1	0	15	14	13	12	11	10	9	8	7	6	5	4	3	2	1	0
1	1	1	0	1	0	1	0	0	0	1	S	Rn				(0)	imm3			Rd		imm2	type	Rm							

```
d = UInt(Rd); n = UInt(Rn); m = UInt(Rm); setflags = (S == '1');
(shift_t, shift_n) = DecodeImmShift(type, imm3:imm2);
if d IN {13,15} || n IN {13,15} || m IN {13,15} then UNPREDICTABLE;
```

### Encoding A1 ARMv4\*, ARMv5T\*, ARMv6\*, ARMv7

BIC{S}<c> <Rd>, <Rn>, <Rm>{, <shift>}

31	30	29	28	27	26	25	24	23	22	21	20	19	18	17	16	15	14	13	12	11	10	9	8	7	6	5	4	3	2	1	0
cond			0	0	0	1	1	1	0	S	Rn				Rd				imm5			type	0	Rm							

```
if Rd == '1111' && S == '1' then SEE SUBS PC, LR and related instructions;
d = UInt(Rd); n = UInt(Rn); m = UInt(Rm); setflags = (S == '1');
(shift_t, shift_n) = DecodeImmShift(type, imm5);
```

## Assembler syntax

BIC{S}{<c>}{<q>} {<Rd>}, <Rn>, <Rm> {, <shift>}

where:

- S            If S is present, the instruction updates the flags. Otherwise, the flags are not updated.
- <c>, <q>      See *Standard assembler syntax fields* on page A8-287.
- <Rd>         The destination register. If S is specified and <Rd> is the PC, see *SUBS PC, LR (Thumb)* on page B9-2008 or *SUBS PC, LR and related instructions (ARM)* on page B9-2010.  
In ARM instructions, if S is not specified and <Rd> is the PC, the instruction is a branch to the address calculated by the operation. This is an interworking branch, see *Pseudocode details of operations on ARM core registers* on page A2-47.
- **Note** —————
- Before ARMv7, this was a simple branch.
- 
- <Rn>         The first operand register. The PC can be used in ARM instructions.
- <Rm>         The register that is optionally shifted and used as the second operand. The PC can be used in ARM instructions.
- <shift>      The shift to apply to the value read from <Rm>. If present, encoding T1 is not permitted. If absent, no shift is applied and all encodings are permitted. *Shifts applied to a register* on page A8-291 describes the shifts and how they are encoded.

The pre-UAL syntax BIC<c>S is equivalent to BICS<c>.

## Operation

```

if ConditionPassed() then
    EncodingSpecificOperations();
    (shifted, carry) = Shift_C(R[m], shift_t, shift_n, APSR.C);
    result = R[n] AND NOT(shifted);
    if d == 15 then           // Can only occur for ARM encoding
        ALUWritePC(result); // setflags is always FALSE here
    else
        R[d] = result;
        if setflags then
            APSR.N = result<31>;
            APSR.Z = IsZeroBit(result);
            APSR.C = carry;
            // APSR.V unchanged

```

## Exceptions

None.

### A8.8.23 BIC (register-shifted register)

Bitwise Bit Clear (register-shifted register) performs a bitwise AND of a register value and the complement of a register-shifted register value. It writes the result to the destination register, and can optionally update the condition flags based on the result.

**Encoding A1** ARMv4\*, ARMv5T\*, ARMv6\*, ARMv7

BIC{S}<C> <Rd>, <Rn>, <Rm>, <type> <Rs>

31	30	29	28	27	26	25	24	23	22	21	20	19	18	17	16	15	14	13	12	11	10	9	8	7	6	5	4	3	2	1	0
cond				0	0	0	1	1	1	0	S	Rn				Rd				Rs				0	type		1	Rm			

```
d = UInt(Rd); n = UInt(Rn); m = UInt(Rm); s = UInt(Rs);
setflags = (S == '1'); shift_t = DecodeRegShift(type);
if d == 15 || n == 15 || m == 15 || s == 15 then UNPREDICTABLE;
```

## Assembler syntax

BIC{S}{<c>}{<q>} {<Rd>}, <Rn>, <Rm>, <type> <Rs>

where:

S If S is present, the instruction updates the flags. Otherwise, the flags are not updated.

<c>, <q> See [Standard assembler syntax fields on page A8-287](#).

<Rd> The destination register.

<Rn> The first operand register.

<Rm> The register that is shifted and used as the second operand.

<type> The type of shift to apply to the value read from <Rm>. It must be one of:

ASR Arithmetic shift right, encoded as type = 0b10.

LSL Logical shift left, encoded as type = 0b00.

LSR Logical shift right, encoded as type = 0b01.

ROR Rotate right, encoded as type = 0b11.

<Rs> The register whose bottom byte contains the amount to shift by.

The pre-UAL syntax BIC<c>S is equivalent to BICS<c>.

## Operation

```
if ConditionPassed() then
    EncodingSpecificOperations();
    shift_n = UInt(R[s]<7:0>);
    (shifted, carry) = Shift_C(R[m], shift_t, shift_n, APSR.C);
    result = R[n] AND NOT(shifted);
    R[d] = result;
    if setflags then
        APSR.N = result<31>;
        APSR.Z = IsZeroBit(result);
        APSR.C = carry;
        // APSR.V unchanged
```

## Exceptions

None.

### A8.8.24 BKPT

Breakpoint causes a software breakpoint to occur.

Breakpoint is always unconditional, even when inside an IT block.

**Encoding T1** ARMv5T\*, ARMv6\*, ARMv7

BKPT #<imm8>

15	14	13	12	11	10	9	8	7	6	5	4	3	2	1	0
1	0	1	1	1	1	1	0	imm8							

imm32 = ZeroExtend(imm8, 32);  
// imm32 is for assembly/disassembly only and is ignored by hardware.

**Encoding A1** ARMv5T\*, ARMv6\*, ARMv7

BKPT #<imm16>

31	30	29	28	27	26	25	24	23	22	21	20	19	18	17	16	15	14	13	12	11	10	9	8	7	6	5	4	3	2	1	0
cond				0	0	0	1	0	0	1	0	imm12												0	1	1	1	imm4			

imm32 = ZeroExtend(imm12:imm4, 32);  
// imm32 is for assembly/disassembly only and is ignored by hardware.  
if cond != '1110' then UNPREDICTABLE; // BKPT must be encoded with AL condition

## Assembler syntax

BKPT{<q>} {#}<imm>

where:

<q> See *Standard assembler syntax fields on page A8-287*. A BKPT instruction must be unconditional.

<imm> Specifies a value that is stored in the instruction, in the range 0-255 for a Thumb instruction or 0-65535 for an ARM instruction. This value is ignored by the processor, but can be used by a debugger to store more information about the breakpoint.

## Operation

EncodingSpecificOperations();  
BKPTInstrDebugEvent();

## Exceptions

Prefetch Abort.

### A8.8.25 BL, BLX (immediate)

Branch with Link calls a subroutine at a PC-relative address.

Branch with Link and Exchange Instruction Sets (immediate) calls a subroutine at a PC-relative address, and changes instruction set from ARM to Thumb, or from Thumb to ARM.

**Encoding T1** ARMv4T, ARMv5T\*, ARMv6\*, ARMv7 if J1 == J2 == 1  
ARMv6T2, ARMv7 otherwise

BL<c> <label> Outside or last in IT block

15	14	13	12	11	10	9	8	7	6	5	4	3	2	1	0	15	14	13	12	11	10	9	8	7	6	5	4	3	2	1	0
1	1	1	1	0	S	imm10						1	1	J1	1	J2	imm11														

I1 = NOT(J1 EOR S); I2 = NOT(J2 EOR S); imm32 = SignExtend(S:I1:I2:imm10:imm11:'0', 32);  
targetInstrSet = CurrentInstrSet();  
if InITBlock() && !LastInITBlock() then UNPREDICTABLE;

**Encoding T2** ARMv5T\*, ARMv6\*, ARMv7 if J1 == J2 == 1  
ARMv6T2, ARMv7 otherwise

BLX<c> <label> Outside or last in IT block

15	14	13	12	11	10	9	8	7	6	5	4	3	2	1	0	15	14	13	12	11	10	9	8	7	6	5	4	3	2	1	0
1	1	1	1	0	S	imm10H						1	1	J1	0	J2	imm10L						H								

if CurrentInstrSet() == InstrSet\_ThumbEE || H == '1' then UNDEFINED;  
I1 = NOT(J1 EOR S); I2 = NOT(J2 EOR S); imm32 = SignExtend(S:I1:I2:imm10H:imm10L:'00', 32);  
targetInstrSet = InstrSet\_ARM;  
if InITBlock() && !LastInITBlock() then UNPREDICTABLE;

**Encoding A1** ARMv4\*, ARMv5T\*, ARMv6\*, ARMv7

BL<c> <label>

31	30	29	28	27	26	25	24	23	22	21	20	19	18	17	16	15	14	13	12	11	10	9	8	7	6	5	4	3	2	1	0
cond				1	0	1	1	imm24																							

imm32 = SignExtend(imm24:'00', 32); targetInstrSet = InstrSet\_ARM;

**Encoding A2** ARMv5T\*, ARMv6\*, ARMv7

BLX <label>

31	30	29	28	27	26	25	24	23	22	21	20	19	18	17	16	15	14	13	12	11	10	9	8	7	6	5	4	3	2	1	0
1	1	1	1	1	0	1	H	imm24																							

imm32 = SignExtend(imm24:H:'0', 32); targetInstrSet = InstrSet\_Thumb;



## Assembler syntax

BL{X}{<c>}{<q>} <label>

where:

<c>, <q>	See <i>Standard assembler syntax fields on page A8-287</i> . An ARM BLX (immediate) instruction must be unconditional.								
X	If present, specifies a change of instruction set (from ARM to Thumb or from Thumb to ARM). If X is omitted, the processor remains in the same state. For ThumbEE instructions, specifying X is not permitted.								
<label>	The label of the instruction that is to be branched to.  BL uses encoding T1 or A1. The assembler calculates the required value of the offset from the PC value of the BL instruction to this label, then selects an encoding with imm32 set to that offset.  BLX uses encoding T2 or A2. The assembler calculates the required value of the offset from the Align(PC, 4) value of the BLX instruction to this label, then selects an encoding with imm32 set to that offset.  Permitted offsets are:  <table> <tr> <td><b>Encoding T1</b></td> <td>Even numbers in the range –16777216 to 16777214.</td> </tr> <tr> <td><b>Encoding T2</b></td> <td>Multiples of 4 in the range –16777216 to 16777212.</td> </tr> <tr> <td><b>Encoding A1</b></td> <td>Multiples of 4 in the range –33554432 to 33554428.</td> </tr> <tr> <td><b>Encoding A2</b></td> <td>Even numbers in the range –33554432 to 33554430.</td> </tr> </table>	<b>Encoding T1</b>	Even numbers in the range –16777216 to 16777214.	<b>Encoding T2</b>	Multiples of 4 in the range –16777216 to 16777212.	<b>Encoding A1</b>	Multiples of 4 in the range –33554432 to 33554428.	<b>Encoding A2</b>	Even numbers in the range –33554432 to 33554430.
<b>Encoding T1</b>	Even numbers in the range –16777216 to 16777214.								
<b>Encoding T2</b>	Multiples of 4 in the range –16777216 to 16777212.								
<b>Encoding A1</b>	Multiples of 4 in the range –33554432 to 33554428.								
<b>Encoding A2</b>	Even numbers in the range –33554432 to 33554430.								

## Operation

```

if ConditionPassed() then
    EncodingSpecificOperations();
    if CurrentInstrSet() == InstrSet_ARM then
        LR = PC - 4;
    else
        LR = PC<31:1> : '1';
    if targetInstrSet == InstrSet_ARM then
        targetAddress = Align(PC,4) + imm32;
    else
        targetAddress = PC + imm32;
    SelectInstrSet(targetInstrSet);
    BranchWritePC(targetAddress);

```

## Exceptions

None.

## Branch range before ARMv6T2

Before ARMv6T2, J1 and J2 in encodings T1 and T2 were both 1, resulting in a smaller branch range. The instructions could be executed as two separate 16-bit instructions, as described in *BL and BLX (immediate) instructions, before ARMv6T2 on page AppxL-2502*.

### A8.8.26 BLX (register)

Branch with Link and Exchange (register) calls a subroutine at an address and instruction set specified by a register.

**Encoding T1** ARMv5T\*, ARMv6\*, ARMv7

BLX<c> <Rm>

Outside or last in IT block

15	14	13	12	11	10	9	8	7	6	5	4	3	2	1	0
0	1	0	0	0	1	1	1	1	Rm				(0)	(0)	(0)

```
m = UInt(Rm);
if m == 15 then UNPREDICTABLE;
if InITBlock() && !LastInITBlock() then UNPREDICTABLE;
```

**Encoding A1** ARMv5T\*, ARMv6\*, ARMv7

BLX<c> <Rm>

31	30	29	28	27	26	25	24	23	22	21	20	19	18	17	16	15	14	13	12	11	10	9	8	7	6	5	4	3	2	1	0
cond		0	0	0	1	0	0	1	0	(1)	(1)	(1)	(1)	(1)	(1)	(1)	(1)	(1)	(1)	(1)	(1)	(1)	(1)	(1)	0	0	1	1	Rm		

```
m = UInt(Rm);
if m == 15 then UNPREDICTABLE;
```

## Assembler syntax

BLX{<c>}{<q>} <Rm>

where:

<c>, <q> See *Standard assembler syntax fields* on page A8-287.

<Rm> The register that contains the branch target address and instruction set selection bit. This register can be the SP in both ARM and Thumb instructions, but ARM deprecates this use of the SP.

## Operation

```
if ConditionPassed() then
    EncodingSpecificOperations();
    target = R[m];
    if CurrentInstrSet() == InstrSet_ARM then
        next_instr_addr = PC - 4;
        LR = next_instr_addr;
    else
        next_instr_addr = PC - 2;
        LR = next_instr_addr<31:1> : '1';
    BXWritePC(target);
```

## Exceptions

None.

**A8.8.27 BX**

Branch and Exchange causes a branch to an address and instruction set specified by a register.

**Encoding T1** ARMv4T, ARMv5T\*, ARMv6\*, ARMv7

BX<c> <Rm> Outside or last in IT block

15	14	13	12	11	10	9	8	7	6	5	4	3	2	1	0
0	1	0	0	0	1	1	1	0	Rm				(0)	(0)	(0)

m = UInt(Rm);  
if InITBlock() && !LastInITBlock() then UNPREDICTABLE;

**Encoding A1** ARMv4T, ARMv5T\*, ARMv6\*, ARMv7

BX<c> <Rm>

31	30	29	28	27	26	25	24	23	22	21	20	19	18	17	16	15	14	13	12	11	10	9	8	7	6	5	4	3	2	1	0
cond			0	0	0	1	0	0	1	0	(1)	(1)	(1)	(1)	(1)	(1)	(1)	(1)	(1)	(1)	(1)	(1)	(1)	(1)	0	0	0	1	Rm		

m = UInt(Rm);

## Assembler syntax

`BX{<c>}{<q>} <Rm>`

where:

<c>, <q> See *Standard assembler syntax fields* on page A8-287.

<Rm> The register that contains the branch target address and instruction set selection bit. The PC can be used. This register can be the SP in both ARM and Thumb instructions, but ARM deprecates this use of the SP.

### **Note**

If <Rm> is the PC in a Thumb instruction at a non word-aligned address, it results in UNPREDICTABLE behavior because the address passed to the `BXwritePC()` pseudocode function has bits<1:0> = '10'.

## Operation

```
if ConditionPassed() then
    EncodingSpecificOperations();
    BXwritePC(R[m]);
```

## Exceptions

None.

### A8.8.28 BXJ

Branch and Exchange Jazelle attempts to change to Jazelle state. If the attempt fails, it branches to an address and instruction set specified by a register as though it were a BX instruction.

In an implementation that includes the Virtualization Extensions, if **HSTR.TJDBX** is set to 1, execution of a BXJ instruction in a Non-secure mode other than Hyp mode generates a Hyp Trap exception. For more information see [Trapping accesses to Jazelle functionality on page B1-1255](#).

**Encoding T1** ARMv6T2, ARMv7

BXJ<c> <Rm> Outside or last in IT block

15	14	13	12	11	10	9	8	7	6	5	4	3	2	1	0	15	14	13	12	11	10	9	8	7	6	5	4	3	2	1	0
1	1	1	1	0	0	1	1	1	1	0	0	Rm				1	0	(0)	0	(1)	(1)	(1)	(1)	(0)	(0)	(0)	(0)	(0)	(0)	(0)	(0)

m = UInt(Rm);  
if m IN {13,15} then UNPREDICTABLE;  
if InITBlock() && !LastInITBlock() then UNPREDICTABLE;

**Encoding A1** ARMv5TEJ, ARMv6\*, ARMv7

BXJ<c> <Rm>

31	30	29	28	27	26	25	24	23	22	21	20	19	18	17	16	15	14	13	12	11	10	9	8	7	6	5	4	3	2	1	0	
cond				0	0	0	1	0	0	1	0	(1)	(1)	(1)	(1)	(1)	(1)	(1)	(1)	(1)	(1)	(1)	(1)	(1)	0	0	1	0	Rm			

m = UInt(Rm);  
if m == 15 then UNPREDICTABLE;

## Assembler syntax

`BXJ{<c>}{<q>} <Rm>`

where:

<c>, <q> See *Standard assembler syntax fields* on page A8-287.

<Rm> The register that specifies the branch target address and instruction set selection bit to be used if the attempt to switch to Jazelle state fails.

## Operation

```
if ConditionPassed() then
    EncodingSpecificOperations();
    if HaveVirtExt() && !IsSecure() && !CurrentModeIsHyp() && HSTR.TJDBX == '1' then
        HSRString = Zeros(25);
        HSRString<3:0> = m;
        WriteHSR('001010', HSRString);
        TakeHypTrapException();
    elsif JMCR.JE == '0' || CurrentInstrSet() == InstrSet_ThumbEE then
        BXWritePC(R[m]);
    else
        if JazelleAcceptsExecution() then
            SwitchToJazelleExecution();
        else
            SUBARCHITECTURE_DEFINED handler call;
```

## Exceptions

Hyp Trap.

### A8.8.29 CBNZ, CBZ

Compare and Branch on Nonzero and Compare and Branch on Zero compare the value in a register with zero, and conditionally branch forward a constant value. They do not affect the condition flags.

**Encoding T1** ARMv6T2, ARMv7

CB{N}Z <Rn>, <label>

Not permitted in IT block.

15	14	13	12	11	10	9	8	7	6	5	4	3	2	1	0
1	0	1	1	op	0	i	1	imm5					Rn		

```
n = UInt(Rn); imm32 = ZeroExtend(i:imm5:'0', 32); nonzero = (op == '1');  
if InITBlock() then UNPREDICTABLE;
```



## Assembler syntax

CB{N}Z{<q>} <Rn>, <label>

where:

- N            If specified, causes the branch to occur when the contents of <Rn> are nonzero (encoded as op = 1).  
              If omitted, causes the branch to occur when the contents of <Rn> are zero (encoded as op = 0).
- <q>           See [Standard assembler syntax fields on page A8-287](#). A CBZ or CBNZ instruction must be unconditional.
- <Rn>         The operand register.
- <label>      The label of the instruction that is to be branched to. The assembler calculates the required value of the offset from the PC value of the CBZ or CBNZ instruction to this label, then selects an encoding that sets imm32 to that offset. Permitted offsets are even numbers in the range 0 to 126.

## Operation

```
EncodingSpecificOperations();  
if nonzero ^ IsZero(R[n]) then  
    BranchWritePC(PC + imm32);
```

## Exceptions

None.

### A8.8.30 CDP, CDP2

Coprocessor Data Processing tells a coprocessor to perform an operation that is independent of ARM core registers and memory. If no coprocessor can execute the instruction, an Undefined Instruction exception is generated.

This is a generic coprocessor instruction. Some of the fields have no functionality defined by the architecture and are free for use by the coprocessor instruction set designer. These are the *opc1*, *opc2*, *CRd*, *CRn*, and *CRm* fields. However, coprocessors CP8-CP15 are reserved for use by ARM, and this manual defines the valid CDP and CDP2 instructions when *coproc* is in the range p8-p15. For more information see [Coprocessor support on page A2-94](#).

**Encoding T1/A1** ARMv6T2, ARMv7 for encoding T1  
ARMv4\*, ARMv5T\*, ARMv6\*, ARMv7 for encoding A1  
CDP<c> <coproc>, <opc1>, <CRd>, <CRn>, <CRm>, <opc2>

15	14	13	12	11	10	9	8	7	6	5	4	3	2	1	0	15	14	13	12	11	10	9	8	7	6	5	4	3	2	1	0
1	1	1	0	1	1	1	0	opc1				CRn				CRd		coproc		opc2		0	CRm								
31	30	29	28	27	26	25	24	23	22	21	20	19	18	17	16	15	14	13	12	11	10	9	8	7	6	5	4	3	2	1	0
cond				1 1 1 0				opc1				CRn				CRd		coproc		opc2		0	CRm								

if coproc IN "101x" then SEE "Floating-point instructions";  
cp = UInt(coproc);

**Encoding T2/A2** ARMv6T2, ARMv7 for encoding T2  
ARMv5T\*, ARMv6\*, ARMv7 for encoding A2  
CDP2<c> <coproc>, <opc1>, <CRd>, <CRn>, <CRm>, <opc2>

15	14	13	12	11	10	9	8	7	6	5	4	3	2	1	0	15	14	13	12	11	10	9	8	7	6	5	4	3	2	1	0
1	1	1	1	1	1	1	0	opc1				CRn				CRd		coproc		opc2		0	CRm								
31	30	29	28	27	26	25	24	23	22	21	20	19	18	17	16	15	14	13	12	11	10	9	8	7	6	5	4	3	2	1	0
1 1 1 1				1 1 1 0				opc1				CRn				CRd		coproc		opc2		0	CRm								

cp = UInt(coproc);

**Floating-point instructions** See [Floating-point data-processing instructions on page A7-272](#)

## Assembler syntax

CDP{2}{<c>}{<q>} <coproc>, {#}<opc1>, <CRd>, <CRn>, <CRm> {, {#}<opc2>}

where:

- 2 If specified, selects encoding T2/A2. If omitted, selects encoding T1/A1.
- <c>, <q> See [Standard assembler syntax fields on page A8-287](#). An ARM CDP2 instruction must be unconditional.
- <coproc> The name of the coprocessor, and causes the corresponding coprocessor number to be placed in the cp\_num field of the instruction. The generic coprocessor names are p0-p15.
- <opc1> Is a coprocessor-specific opcode, in the range 0 to 15.
- <CRd> The destination coprocessor register for the instruction.
- <CRn> The coprocessor register that contains the first operand.
- <CRm> The coprocessor register that contains the second operand.
- <opc2> Is a coprocessor-specific opcode in the range 0 to 7. If it is omitted, <opc2> is 0.

## Operation

```
if ConditionPassed() then
    EncodingSpecificOperations();
    if !Coprocc_Accepted(cp, ThisInstr()) then
        GenerateCoproccorException();
    else
        Coproc_InternalOperation(cp, ThisInstr());
```

## Exceptions

Undefined Instruction.

Uses of these instructions by specific coprocessors might generate other exceptions.

**A8.8.31 CHKA**

CHKA is a ThumbEE instruction, see [CHKA](#) on page A9-1124.

**A8.8.32 CLREX**

Clear-Exclusive clears the local record of the executing processor that an address has had a request for an exclusive access.

**Encoding T1** ARMv7

CLREX<c>

15	14	13	12	11	10	9	8	7	6	5	4	3	2	1	0	15	14	13	12	11	10	9	8	7	6	5	4	3	2	1	0
1	1	1	1	0	0	1	1	1	0	1	1	(1)	(1)	(1)	(1)	1	0	(0)	0	(1)	(1)	(1)	(1)	0	0	1	0	(1)	(1)	(1)	(1)

// No additional decoding required

**Encoding A1** ARMv6K, ARMv7

CLREX

31	30	29	28	27	26	25	24	23	22	21	20	19	18	17	16	15	14	13	12	11	10	9	8	7	6	5	4	3	2	1	0	
1	1	1	1	0	1	0	1	0	1	1	1	(1)	(1)	(1)	(1)	(1)	(1)	(1)	(1)	(1)	(0)	(0)	(0)	(0)	0	0	0	1	(1)	(1)	(1)	(1)

// No additional decoding required

## Assembler syntax

CLREX{<c>}{<q>}

where:

<c>, <q> See *Standard assembler syntax fields* on page A8-287. An ARM CLREX instruction must be unconditional.

## Operation

```
if ConditionPassed() then
    EncodingSpecificOperations();
    ClearExclusiveLocal(ProcessorID());
```

## Exceptions

None.

### A8.8.33 CLZ

Count Leading Zeros returns the number of binary zero bits before the first binary one bit in a value.

#### Encoding T1 ARMv6T2, ARMv7

CLZ<c> <Rd>, <Rm>

15	14	13	12	11	10	9	8	7	6	5	4	3	2	1	0	15	14	13	12	11	10	9	8	7	6	5	4	3	2	1	0
1	1	1	1	1	0	1	0	1	0	1	1	Rm			1	1	1	1	Rd			1	0	0	0	Rm					

```
if !Consistent(Rm) then UNPREDICTABLE;
d = UInt(Rd); m = UInt(Rm);
if d IN {13,15} || m IN {13,15} then UNPREDICTABLE;
```

#### Encoding A1 ARMv5T\*, ARMv6\*, ARMv7

CLZ<c> <Rd>, <Rm>

31	30	29	28	27	26	25	24	23	22	21	20	19	18	17	16	15	14	13	12	11	10	9	8	7	6	5	4	3	2	1	0
cond		0	0	0	1	0	1	1	0	(1)	(1)	(1)	(1)	Rd			(1)	(1)	(1)	(1)	0	0	0	1	Rm						

```
d = UInt(Rd); m = UInt(Rm);
if d == 15 || m == 15 then UNPREDICTABLE;
```

## Assembler syntax

CLZ{<c>}{<q>} <Rd>, <Rm>

where:

<c>, <q> See *Standard assembler syntax fields* on page A8-287.

<Rd> The destination register.

<Rm> The register that contains the operand. Its number must be encoded twice in encoding T1.

## Operation

```
if ConditionPassed() then
    EncodingSpecificOperations();
    result = CountLeadingZeroBits(R[m]);
    R[d] = result<31:0>;
```

## Exceptions

None.

### A8.8.34 CMN (immediate)

Compare Negative (immediate) adds a register value and an immediate value. It updates the condition flags based on the result, and discards the result.

#### Encoding T1 ARMv6T2, ARMv7

CMN<c> <Rn>, #<const>

15	14	13	12	11	10	9	8	7	6	5	4	3	2	1	0	15	14	13	12	11	10	9	8	7	6	5	4	3	2	1	0
1	1	1	1	0	i	0	1	0	0	0	1	Rn				0	imm3			1	1	1	1	imm8							

n = UInt(Rn); imm32 = ThumbExpandImm(i:imm3:imm8);  
if n == 15 then UNPREDICTABLE;

#### Encoding A1 ARMv4\*, ARMv5T\*, ARMv6\*, ARMv7

CMN<c> <Rn>, #<const>

31	30	29	28	27	26	25	24	23	22	21	20	19	18	17	16	15	14	13	12	11	10	9	8	7	6	5	4	3	2	1	0
cond		0	0	1	1	0	1	1	1	Rn				(0)	(0)	(0)	(0)	imm12													

n = UInt(Rn); imm32 = ARMEExpandImm(imm12);



## Assembler syntax

CMN{<c>}{<q>} <Rn>, #<const>

where:

<c>, <q> See *Standard assembler syntax fields* on page A8-287.

<Rn> The register that contains the operand. SP can be used in Thumb and ARM instructions. The PC can be used in ARM instructions.

<const> The immediate value to be added to the value obtained from <Rn>. See *Modified immediate constants in Thumb instructions* on page A6-232 or *Modified immediate constants in ARM instructions* on page A5-200 for the range of values.

## Operation

```
if ConditionPassed() then
    EncodingSpecificOperations();
    (result, carry, overflow) = AddWithCarry(R[n], imm32, '0');
    APSR.N = result<31>;
    APSR.Z = IsZeroBit(result);
    APSR.C = carry;
    APSR.V = overflow;
```

## Exceptions

None.

### A8.8.35 CMN (register)

Compare Negative (register) adds a register value and an optionally-shifted register value. It updates the condition flags based on the result, and discards the result.

#### Encoding T1 ARMv4T, ARMv5T\*, ARMv6\*, ARMv7

CMN<c> <Rn>, <Rm>

15	14	13	12	11	10	9	8	7	6	5	4	3	2	1	0
0	1	0	0	0	0	1	0	1	1	Rm					Rn

n = UInt(Rn); m = UInt(Rm);  
(shift\_t, shift\_n) = (SRTYPE\_LSL, 0);

#### Encoding T2 ARMv6T2, ARMv7

CMN<c>.W <Rn>, <Rm>{, <shift>}

15	14	13	12	11	10	9	8	7	6	5	4	3	2	1	0	15	14	13	12	11	10	9	8	7	6	5	4	3	2	1	0
1	1	1	0	1	0	1	1	0	0	0	1	Rn				(0)	imm3	1	1	1	1	imm2	type			Rm					

n = UInt(Rn); m = UInt(Rm);  
(shift\_t, shift\_n) = DecodeImmShift(type, imm3:imm2);  
if n == 15 || m IN {13,15} then UNPREDICTABLE;

#### Encoding A1 ARMv4\*, ARMv5T\*, ARMv6\*, ARMv7

CMN<c> <Rn>, <Rm>{, <shift>}

31	30	29	28	27	26	25	24	23	22	21	20	19	18	17	16	15	14	13	12	11	10	9	8	7	6	5	4	3	2	1	0
cond	0	0	0	1	0	1	1	1	Rn							(0)	(0)	(0)	(0)	imm5	type	0									Rm

n = UInt(Rn); m = UInt(Rm);  
(shift\_t, shift\_n) = DecodeImmShift(type, imm5);

## Assembler syntax

CMN{<c>}{<q>} <Rn>, <Rm> {, <shift>}

where:

- <c>, <q> See *Standard assembler syntax fields on page A8-287*.
- <Rn> The first operand register. SP can be used in Thumb instructions (encoding T2) and in ARM instructions. The PC can be used in ARM instructions.
- <Rm> The register that is optionally shifted and used as the second operand. The PC can be used in ARM instructions.
- <shift> The shift to apply to the value read from <Rm>. If present, encoding T1 is not permitted. If absent, no shift is applied and all encodings are permitted. *Shifts applied to a register on page A8-291* describes the shifts and how they are encoded.

## Operation

```
if ConditionPassed() then
    EncodingSpecificOperations();
    shifted = Shift(R[m], shift_t, shift_n, APSR.C);
    (result, carry, overflow) = AddWithCarry(R[n], shifted, '0');
    APSR.N = result<31>;
    APSR.Z = IsZeroBit(result);
    APSR.C = carry;
    APSR.V = overflow;
```

## Exceptions

None.

### A8.8.36 CMN (register-shifted register)

Compare Negative (register-shifted register) adds a register value and a register-shifted register value. It updates the condition flags based on the result, and discards the result.

**Encoding A1** ARMv4\*, ARMv5T\*, ARMv6\*, ARMv7

CMN<c> <Rn>, <Rm>, <type> <Rs>

31	30	29	28	27	26	25	24	23	22	21	20	19	18	17	16	15	14	13	12	11	10	9	8	7	6	5	4	3	2	1	0
cond				0	0	0	1	0	1	1	1	Rn				(0)	(0)	(0)	(0)	Rs				0	type		1	Rm			

```
n = UInt(Rn); m = UInt(Rm); s = UInt(Rs);
shift_t = DecodeRegShift(type);
if n == 15 || m == 15 || s == 15 then UNPREDICTABLE;
```

## Assembler syntax

CMN{<c>}{<q>} <Rn>, <Rm>, <type> <Rs>

where:

- <c>, <q> See [Standard assembler syntax fields on page A8-287](#).
- <Rn> The first operand register.
- <Rm> The register that is shifted and used as the second operand.
- <type> The type of shift to apply to the value read from <Rm>. It must be one of:
- |     |   |
|-----|---|
| ASR | Arithmetic shift right, encoded as type = 0b10. |
| LSL | Logical shift left, encoded as type = 0b00.     |
| LSR | Logical shift right, encoded as type = 0b01.    |
| ROR | Rotate right, encoded as type = 0b11.           |
- <Rs> The register whose bottom byte contains the amount to shift by.

## Operation

```
if ConditionPassed() then
    EncodingSpecificOperations();
    shift_n = UInt(R[s]<7:0>);
    shifted = Shift(R[m], shift_t, shift_n, APSR.C);
    (result, carry, overflow) = AddWithCarry(R[n], shifted, '0');
    APSR.N = result<31>;
    APSR.Z = IsZeroBit(result);
    APSR.C = carry;
    APSR.V = overflow;
```

## Exceptions

None.

### A8.8.37 CMP (immediate)

Compare (immediate) subtracts an immediate value from a register value. It updates the condition flags based on the result, and discards the result.

**Encoding T1** ARMv4T, ARMv5T\*, ARMv6\*, ARMv7

CMP<c> <Rn>, #<imm8>

15	14	13	12	11	10	9	8	7	6	5	4	3	2	1	0	
0	0	1	0	1	Rn				imm8							

n = UInt(Rn); imm32 = ZeroExtend(imm8, 32);

**Encoding T2** ARMv6T2, ARMv7

CMP<c>.W <Rn>, #<const>

15	14	13	12	11	10	9	8	7	6	5	4	3	2	1	0	15	14	13	12	11	10	9	8	7	6	5	4	3	2	1	0
1	1	1	1	0	i	0	1	1	0	1	1	Rn				0	imm3			1	1	1	1	imm8							

n = UInt(Rn); imm32 = ThumbExpandImm(i:imm3:imm8);  
if n == 15 then UNPREDICTABLE;

**Encoding A1** ARMv4\*, ARMv5T\*, ARMv6\*, ARMv7

CMP<c> <Rn>, #<const>

31	30	29	28	27	26	25	24	23	22	21	20	19	18	17	16	15	14	13	12	11	10	9	8	7	6	5	4	3	2	1	0
cond		0	0	1	1	0	1	0	1	Rn				(0)	(0)	(0)	(0)	imm12													

n = UInt(Rn); imm32 = ARMEExpandImm(imm12);

## Assembler syntax

CMP{<c>}{<q>} <Rn>, #<const>

where:

- <c>, <q> See *Standard assembler syntax fields* on page A8-287.
- <Rn> The first operand register. SP can be used in Thumb instructions (encoding T2) and in ARM instructions. The PC can be used in ARM instructions.
- <const> The immediate value to be compared with the value obtained from <Rn>. The range of values is 0-255 for encoding T1. See *Modified immediate constants in Thumb instructions* on page A6-232 or *Modified immediate constants in ARM instructions* on page A5-200 for the range of values for encoding T2 and A1.

## Operation

```
if ConditionPassed() then
    EncodingSpecificOperations();
    (result, carry, overflow) = AddWithCarry(R[n], NOT(imm32), '1');
    APSR.N = result<31>;
    APSR.Z = IsZeroBit(result);
    APSR.C = carry;
    APSR.V = overflow;
```

## Exceptions

None.

### A8.8.38 CMP (register)

Compare (register) subtracts an optionally-shifted register value from a register value. It updates the condition flags based on the result, and discards the result.

#### Encoding T1 ARMv4T, ARMv5T\*, ARMv6\*, ARMv7

CMP<c> <Rn>, <Rm> <Rn> and <Rm> both from R0-R7

15	14	13	12	11	10	9	8	7	6	5	4	3	2	1	0
0	1	0	0	0	0	1	0	1	0	Rm				Rn	

n = UInt(Rn); m = UInt(Rm);  
(shift\_t, shift\_n) = (SRTYPE\_LSL, 0);

#### Encoding T2 ARMv4T, ARMv5T\*, ARMv6\*, ARMv7

CMP<c> <Rn>, <Rm> <Rn> and <Rm> not both from R0-R7

15	14	13	12	11	10	9	8	7	6	5	4	3	2	1	0
0	1	0	0	0	1	0	1	N		Rm				Rn	

n = UInt(N:Rn); m = UInt(Rm);  
(shift\_t, shift\_n) = (SRTYPE\_LSL, 0);  
if n < 8 && m < 8 then UNPREDICTABLE;  
if n == 15 || m == 15 then UNPREDICTABLE;

#### Encoding T3 ARMv6T2, ARMv7

CMP<c>.W <Rn>, <Rm> {, <shift>}

15	14	13	12	11	10	9	8	7	6	5	4	3	2	1	0	15	14	13	12	11	10	9	8	7	6	5	4	3	2	1	0
1	1	1	0	1	0	1	1	1	0	1	1			Rn	(0)	imm3	1	1	1	1	imm2	type			Rm						

n = UInt(Rn); m = UInt(Rm);  
(shift\_t, shift\_n) = DecodeImmShift(type, imm3:imm2);  
if n == 15 || m IN {13,15} then UNPREDICTABLE;

#### Encoding A1 ARMv4\*, ARMv5T\*, ARMv6\*, ARMv7

CMP<c> <Rn>, <Rm>{, <shift>}

31	30	29	28	27	26	25	24	23	22	21	20	19	18	17	16	15	14	13	12	11	10	9	8	7	6	5	4	3	2	1	0
cond	0	0	0	1	0	1	0	1			Rn	(0)	(0)	(0)	(0)	imm5					type	0									Rm

n = UInt(Rn); m = UInt(Rm);  
(shift\_t, shift\_n) = DecodeImmShift(type, imm5);



## Assembler syntax

CMP{<c>}{<q>} <Rn>, <Rm> {, <shift>}

where:

- <c>, <q> See [Standard assembler syntax fields on page A8-287](#).
- <Rn> The first operand register. The SP can be used. The PC can be used in ARM instructions.
- <Rm> The register that is optionally shifted and used as the second operand. The PC can be used in ARM instructions. The SP can be used in both ARM and Thumb instructions, but:
- ARM deprecates the use of SP
  - when assembling for the Thumb instruction set, only encoding T2 is available.
- <shift> The shift to apply to the value read from <Rm>. If present, encodings T1 and T2 are not permitted. If absent, no shift is applied and all encodings are permitted. [Shifts applied to a register on page A8-291](#) describes the shifts and how they are encoded.

## Operation

```
if ConditionPassed() then
    EncodingSpecificOperations();
    shifted = Shift(R[m], shift_t, shift_n, APSR.C);
    (result, carry, overflow) = AddWithCarry(R[n], NOT(shifted), '1');
    APSR.N = result<31>;
    APSR.Z = IsZeroBit(result);
    APSR.C = carry;
    APSR.V = overflow;
```

## Exceptions

None.

### A8.8.39 CMP (register-shifted register)

Compare (register-shifted register) subtracts a register-shifted register value from a register value. It updates the condition flags based on the result, and discards the result.

**Encoding A1** ARMv4\*, ARMv5T\*, ARMv6\*, ARMv7

CMP<c> <Rn>, <Rm>, <type> <Rs>

31	30	29	28	27	26	25	24	23	22	21	20	19	18	17	16	15	14	13	12	11	10	9	8	7	6	5	4	3	2	1	0
cond				0	0	0	1	0	1	0	1	Rn				(0)	(0)	(0)	(0)	Rs				0	type		1	Rm			

```
n = UInt(Rn); m = UInt(Rm); s = UInt(Rs);
shift_t = DecodeRegShift(type);
if n == 15 || m == 15 || s == 15 then UNPREDICTABLE;
```

## Assembler syntax

CMP{<c>}{<q>} <Rn>, <Rm>, <type> <Rs>

where:

- <c>, <q> See [Standard assembler syntax fields on page A8-287](#).
- <Rn> The first operand register.
- <Rm> The register that is shifted and used as the second operand.
- <type> The type of shift to apply to the value read from <Rm>. It must be one of:
- |     |   |
|-----|---|
| ASR | Arithmetic shift right, encoded as type = 0b10. |
| LSL | Logical shift left, encoded as type = 0b00.     |
| LSR | Logical shift right, encoded as type = 0b01.    |
| ROR | Rotate right, encoded as type = 0b11.           |
- <Rs> The register whose bottom byte contains the amount to shift by.

## Operation

```
if ConditionPassed() then
    EncodingSpecificOperations();
    shift_n = UInt(R[s]<7:0>);
    shifted = Shift(R[m], shift_t, shift_n, APSR.C);
    (result, carry, overflow) = AddWithCarry(R[n], NOT(shifted), '1');
    APSR.N = result<31>;
    APSR.Z = IsZeroBit(result);
    APSR.C = carry;
    APSR.V = overflow;
```

## Exceptions

None.

#### **A8.8.40 CPS**

Change Processor State is a system instruction, see [CPS \(Thumb\) on page B9-1976](#) and [CPS \(ARM\) on page B9-1978](#).

#### **A8.8.41 CPY**

Copy is a pre-UAL synonym for MOV (register).

##### **Assembler syntax**

CPY <Rd>, <Rn>

This is equivalent to:

MOV <Rd>, <Rn>

##### **Exceptions**

None.

## A8.8.42 DBG

Debug Hint provides a hint to debug and related systems. See their documentation for what use (if any) they make of this instruction.

**Encoding T1** ARMv7 (executes as NOP in ARMv6T2)

DBG<c> #<option>

15	14	13	12	11	10	9	8	7	6	5	4	3	2	1	0	15	14	13	12	11	10	9	8	7	6	5	4	3	2	1	0
1	1	1	1	0	0	1	1	1	0	1	0	(1)	(1)	(1)	(1)	1	0	(0)	0	(0)	0	0	0	1	1	1	1	option			

// Any decoding of 'option' is specified by the debug system

**Encoding A1** ARMv7 (executes as NOP in ARMv6K and ARMv6T2)

DBG<c> #<option>

31	30	29	28	27	26	25	24	23	22	21	20	19	18	17	16	15	14	13	12	11	10	9	8	7	6	5	4	3	2	1	0
cond	0	0	1	1	0	0	1	0	0	0	0	0	(1)	(1)	(1)	(1)	(0)	(0)	(0)	(0)	1	1	1	1	option						

// Any decoding of 'option' is specified by the debug system

### Assembler syntax

DBG{<c>}{<q>} #<option>

where:

<c>, <q> See [Standard assembler syntax fields on page A8-287](#).

<option> Provides extra information about the hint, and is in the range 0 to 15.

### Operation

```
if ConditionPassed() then
    EncodingSpecificOperations();
    Hint_Debug(option);
```

### Exceptions

None.

### A8.8.43 DMB

Data Memory Barrier is a memory barrier that ensures the ordering of observations of memory accesses, see [Data Memory Barrier \(DMB\) on page A3-151](#).

#### Encoding T1 ARMv7

DMB<c> <option>

15	14	13	12	11	10	9	8	7	6	5	4	3	2	1	0	15	14	13	12	11	10	9	8	7	6	5	4	3	2	1	0
1	1	1	1	0	0	1	1	1	0	1	1	(1)	(1)	(1)	(1)	1	0	(0)	0	(1)	(1)	(1)	(1)	0	1	0	1	option			

// No additional decoding required

#### Encoding A1 ARMv7

DMB <option>

31	30	29	28	27	26	25	24	23	22	21	20	19	18	17	16	15	14	13	12	11	10	9	8	7	6	5	4	3	2	1	0
1	1	1	1	0	1	0	1	0	1	1	1	(1)	(1)	(1)	(1)	(1)	(1)	(1)	(1)	(1)	(0)	(0)	(0)	(0)	0	1	0	1	option		

// No additional decoding required

#### Assembler syntax

DMB{<c>}{<q>} {<option>}

where:

<c>, <q> See [Standard assembler syntax fields on page A8-287](#). An ARM DMB instruction must be unconditional.

- <option> Specifies an optional limitation on the DMB operation. Values are:
- SY Full system is the required shareability domain, reads and writes are the required access types. Can be omitted.  
This option is referred to as the full system DMB. Encoded as option = 0b1111.
  - ST Full system is the required shareability domain, writes are the required access type. SYST is a synonym for ST. Encoded as option = 0b1110.
  - ISH Inner Shareable is the required shareability domain, reads and writes are the required access types. Encoded as option = 0b1011.
  - ISHST Inner Shareable is the required shareability domain, writes are the required access type. Encoded as option = 0b1010.
  - NSH Non-shareable is the required shareability domain, reads and writes are the required access types. Encoded as option = 0b0111.
  - NSHST Non-shareable is the required shareability domain, writes are the required access type. Encoded as option = 0b0110.
  - OSH Outer Shareable is the required shareability domain, reads and writes are the required access types. Encoded as option = 0b0011.
  - OSHST Outer Shareable is the required shareability domain, writes are the required access type. Encoded as option = 0b0010.

All other encodings of option are reserved. It is IMPLEMENTATION DEFINED whether options other than SY are implemented. All unsupported and reserved options must execute as a full system DMB operation, but software must not rely on this behavior.

**Note**

The instruction supports the following alternative <option> values, but ARM recommends that software does not use these alternative values:

- SH as an alias for ISH
- SHST as an alias for ISHST
- UN as an alias for NSH
- UNST is an alias for NSHST.

**Operation**

```

if ConditionPassed() then
    EncodingSpecificOperations();
    case option of
        when '0010' domain = MBRReqDomain_OuterShareable; types = MBRReqTypes_Writes;
        when '0011' domain = MBRReqDomain_OuterShareable; types = MBRReqTypes_All;
        when '0110' domain = MBRReqDomain_Nonshareable; types = MBRReqTypes_Writes;
        when '0111' domain = MBRReqDomain_Nonshareable; types = MBRReqTypes_All;
        when '1010' domain = MBRReqDomain_InnerShareable; types = MBRReqTypes_Writes;
        when '1011' domain = MBRReqDomain_InnerShareable; types = MBRReqTypes_All;
        when '1110' domain = MBRReqDomain_FullSystem; types = MBRReqTypes_Writes;
        otherwise domain = MBRReqDomain_FullSystem; types = MBRReqTypes_All;
    if HaveVirtExt() && !IsSecure() && !CurrentModeIsHyp() then
        if HCR.BSU == '11' then
            domain = MBRReqDomain_FullSystem;
        if HCR.BSU == '10' && domain != MBRReqDomain_FullSystem then
            domain = MBRReqDomain_OuterShareable;
        if HCR.BSU == '01' && domain == MBRReqDomain_Nonshareable then
            domain = MBRReqDomain_InnerShareable;

    DataMemoryBarrier(domain, types);

```

**Exceptions**

None.

## A8.8.44 DSB

Data Synchronization Barrier is a memory barrier that ensures the completion of memory accesses, see [Data Synchronization Barrier \(DSB\) on page A3-152](#).

### Encoding T1 ARMv7

DSB<c> <option>

15	14	13	12	11	10	9	8	7	6	5	4	3	2	1	0	15	14	13	12	11	10	9	8	7	6	5	4	3	2	1	0
1	1	1	1	0	0	1	1	1	0	1	1	(1)	(1)	(1)	(1)	1	0	(0)	0	(1)	(1)	(1)	(1)	0	1	0	0	option			

// No additional decoding required

### Encoding A1 ARMv7

DSB <option>

31	30	29	28	27	26	25	24	23	22	21	20	19	18	17	16	15	14	13	12	11	10	9	8	7	6	5	4	3	2	1	0
1	1	1	1	0	1	0	1	0	1	1	1	(1)	(1)	(1)	(1)	(1)	(1)	(1)	(1)	(1)	(0)	(0)	(0)	(0)	0	1	0	0	option		

// No additional decoding required

### Assembler syntax

DSB{<c>}{<q>} {<option>}

where:

<c>, <q> See [Standard assembler syntax fields on page A8-287](#). An ARM DSB instruction must be unconditional.

<option> Specifies an optional limitation on the DSB operation. Values are:

- SY Full system is the required shareability domain, reads and writes are the required access types. Can be omitted.  
This option is referred to as the full system DSB. Encoded as option = 0b1111.
- ST Full system is the required shareability domain, writes are the required access type. SYST is a synonym for ST. Encoded as option = 0b1110.
- ISH Inner Shareable is the required shareability domain, reads and writes are the required access types. Encoded as option = 0b1011.
- ISHST Inner Shareable is the required shareability domain, writes are the required access type. Encoded as option = 0b1010.
- NSH Non-shareable is the required shareability domain, reads and writes are the required access types. Encoded as option = 0b0111.
- NSHST Non-shareable is the required shareability domain, writes are the required access type. Encoded as option = 0b0110.
- OSH Outer Shareable is the required shareability domain, reads and writes are the required access types. Encoded as option = 0b0011.
- OSHST Outer Shareable is the required shareability domain, writes are the required access type. Encoded as option = 0b0010.

All other encodings of option are reserved. It is IMPLEMENTATION DEFINED whether options other than SY are implemented. All unsupported and reserved options must execute as a full system DSB operation, but software must not rely on this behavior.



**Note**

The instruction supports the following alternative <option> values, but ARM recommends that software does not use these alternative values:

- SH as an alias for ISH
- SHST as an alias for ISHST
- UN as an alias for NSH
- UNST is an alias for NSHST.

**Operation**

```

if ConditionPassed() then
    EncodingSpecificOperations();
    case option of
        when '0010' domain = MBReqDomain_OuterShareable; types = MBReqTypes_Writes;
        when '0011' domain = MBReqDomain_OuterShareable; types = MBReqTypes_All;
        when '0110' domain = MBReqDomain_Nonshareable; types = MBReqTypes_Writes;
        when '0111' domain = MBReqDomain_Nonshareable; types = MBReqTypes_All;
        when '1010' domain = MBReqDomain_InnerShareable; types = MBReqTypes_Writes;
        when '1011' domain = MBReqDomain_InnerShareable; types = MBReqTypes_All;
        when '1110' domain = MBReqDomain_FullSystem; types = MBReqTypes_Writes;
        otherwise domain = MBReqDomain_FullSystem; types = MBReqTypes_All;

    if HaveVirtExt() && !IsSecure() && !CurrentModeIsHyp() then
        if HCR.BSU == '11' then
            domain = MBReqDomain_FullSystem;
        if HCR.BSU == '10' && domain != MBReqDomain_FullSystem then
            domain = MBReqDomain_OuterShareable;
        if HCR.BSU == '01' && domain == MBReqDomain_Nonshareable then
            domain = MBReqDomain_InnerShareable;

    DataSynchronizationBarrier(domain, types);

```

**Exceptions**

None.

### A8.8.45 ENTERX

ENTERX causes a change from Thumb state to ThumbEE state, or has no effect in ThumbEE state. For details see [ENTERX, LEAVEX](#) on page A9-1116.

### A8.8.46 EOR (immediate)

Bitwise Exclusive OR (immediate) performs a bitwise Exclusive OR of a register value and an immediate value, and writes the result to the destination register. It can optionally update the condition flags based on the result.

#### Encoding T1 ARMv6T2, ARMv7

EOR{S}<c> <Rd>, <Rn>, #<const>

15	14	13	12	11	10	9	8	7	6	5	4	3	2	1	0	15	14	13	12	11	10	9	8	7	6	5	4	3	2	1	0
1	1	1	1	0	i	0	0	1	0	0	S	Rn				0	imm3			Rd			imm8								

```
if Rd == '1111' && S == '1' then SEE TEQ (immediate);
d = UInt(Rd); n = UInt(Rn); setflags = (S == '1');
(imm32, carry) = ThumbExpandImm_C(i:imm3:imm8, APSR.C);
if d == 13 || (d == 15 && S == '0') || n IN {13,15} then UNPREDICTABLE;
```

#### Encoding A1 ARMv4\*, ARMv5T\*, ARMv6\*, ARMv7

EOR{S}<c> <Rd>, <Rn>, #<const>

31	30	29	28	27	26	25	24	23	22	21	20	19	18	17	16	15	14	13	12	11	10	9	8	7	6	5	4	3	2	1	0
cond		0	0	1	0	0	0	1	S	Rn				Rd				imm12													

```
if Rd == '1111' && S == '1' then SEE SUBS PC, LR and related instructions;
d = UInt(Rd); n = UInt(Rn); setflags = (S == '1');
(imm32, carry) = ARMEExpandImm_C(imm12, APSR.C);
```

## Assembler syntax

EOR{S}{<c>}{<q>} {<Rd>}, <Rn>, #<const>

where:

- S            If S is present, the instruction updates the flags. Otherwise, the flags are not updated.
- <c>, <q>     See *Standard assembler syntax fields* on page A8-287.
- <Rd>        The destination register. If S is specified and <Rd> is the PC, see *SUBS PC, LR (Thumb)* on page B9-2008 or *SUBS PC, LR and related instructions (ARM)* on page B9-2010.  
In ARM instructions, if S is not specified and <Rd> is the PC, the instruction is a branch to the address calculated by the operation. This is an interworking branch, see *Pseudocode details of operations on ARM core registers* on page A2-47.
- **Note** —————
- Before ARMv7, this was a simple branch.
- 
- <Rn>        The register that contains the operand. The PC can be used in ARM instructions.
- <const>     The immediate value to be exclusive ORed with the value obtained from <Rn>. See *Modified immediate constants in Thumb instructions* on page A6-232 or *Modified immediate constants in ARM instructions* on page A5-200 for the range of values.

The pre-UAL syntax EOR<c>S is equivalent to EORS<c>.

## Operation

```
if ConditionPassed() then
    EncodingSpecificOperations();
    result = R[n] EOR imm32;
    if d == 15 then           // Can only occur for ARM encoding
        ALUWritePC(result); // setflags is always FALSE here
    else
        R[d] = result;
        if setflags then
            APSR.N = result<31>;
            APSR.Z = IsZeroBit(result);
            APSR.C = carry;
            // APSR.V unchanged
```

## Exceptions

None.

### A8.8.47 EOR (register)

Bitwise Exclusive OR (register) performs a bitwise Exclusive OR of a register value and an optionally-shifted register value, and writes the result to the destination register. It can optionally update the condition flags based on the result.

**Encoding T1** ARMv4T, ARMv5T\*, ARMv6\*, ARMv7  
EORS <Rdn>, <Rm> Outside IT block.  
EOR<c> <Rdn>, <Rm> Inside IT block.

15	14	13	12	11	10	9	8	7	6	5	4	3	2	1	0
0	1	0	0	0	0	0	0	0	1	Rm					Rdn

d = UInt(Rdn); n = UInt(Rdn); m = UInt(Rm); setflags = !InITBlock();  
(shift\_t, shift\_n) = (SRTYPE\_LSL, 0);

**Encoding T2** ARMv6T2, ARMv7  
EOR{S}<c>.W <Rd>, <Rn>, <Rm>{, <shift>}

15	14	13	12	11	10	9	8	7	6	5	4	3	2	1	0	15	14	13	12	11	10	9	8	7	6	5	4	3	2	1	0
1	1	1	0	1	0	1	0	1	0	0	S	Rn	(0)	imm3		Rd	imm2	type									Rm				

if Rd == '1111' && S == '1' then SEE TEQ (register);  
d = UInt(Rd); n = UInt(Rn); m = UInt(Rm); setflags = (S == '1');  
(shift\_t, shift\_n) = DecodeImmShift(type, imm3:imm2);  
if d == 13 || (d == 15 && S == '0') || n IN {13,15} || m IN {13,15} then UNPREDICTABLE;

**Encoding A1** ARMv4\*, ARMv5T\*, ARMv6\*, ARMv7  
EOR{S}<c> <Rd>, <Rn>, <Rm>{, <shift>}

31	30	29	28	27	26	25	24	23	22	21	20	19	18	17	16	15	14	13	12	11	10	9	8	7	6	5	4	3	2	1	0
cond	0	0	0	0	0	0	1	S	Rn			Rd	imm5	type	0																Rm

if Rd == '1111' && S == '1' then SEE SUBS PC, LR and related instructions;  
d = UInt(Rd); n = UInt(Rn); m = UInt(Rm); setflags = (S == '1');  
(shift\_t, shift\_n) = DecodeImmShift(type, imm5);

## Assembler syntax

EOR{S}{<c>}{<q>} {<Rd>}, <Rn>, <Rm> {, <shift>}

where:

- S            If S is present, the instruction updates the flags. Otherwise, the flags are not updated.
- <c>, <q>      See *Standard assembler syntax fields* on page A8-287.
- <Rd>        The destination register. If S is specified and <Rd> is the PC, see *SUBS PC, LR (Thumb)* on page B9-2008 or *SUBS PC, LR and related instructions (ARM)* on page B9-2010.  
In ARM instructions, if S is not specified and <Rd> is the PC, the instruction is a branch to the address calculated by the operation. This is an interworking branch, see *Pseudocode details of operations on ARM core registers* on page A2-47.
- **Note** —————
- Before ARMv7, this was a simple branch.
- 
- <Rn>        The first operand register. The PC can be used in ARM instructions.
- <Rm>        The register that is optionally shifted and used as the second operand. The PC can be used in ARM instructions.
- <shift>      The shift to apply to the value read from <Rm>. If present, encoding T1 is not permitted. If absent, no shift is applied and all encodings are permitted. *Shifts applied to a register* on page A8-291 describes the shifts and how they are encoded.

In Thumb assembly:

- outside an IT block, if EORS <Rd>, <Rn>, <Rd> has <Rd> and <Rn> both in the range R0-R7, it is assembled using encoding T1 as though EORS <Rd>, <Rn> had been written
- inside an IT block, if EOR<c> <Rd>, <Rn>, <Rd> has <Rd> and <Rn> both in the range R0-R7, it is assembled using encoding T1 as though EOR<c> <Rd>, <Rn> had been written.

To prevent either of these happening, use the .W qualifier.

The pre-UAL syntax EOR<c>S is equivalent to EORS<c>.

## Operation

```
if ConditionPassed() then
    EncodingSpecificOperations();
    (shifted, carry) = Shift_C(R[m], shift_t, shift_n, APSR.C);
    result = R[n] EOR shifted;
    if d == 15 then // Can only occur for ARM encoding
        ALUWritePC(result); // setflags is always FALSE here
    else
        R[d] = result;
        if setflags then
            APSR.N = result<31>;
            APSR.Z = IsZeroBit(result);
            APSR.C = carry;
            // APSR.V unchanged
```

## Exceptions

None.

### A8.8.48 EOR (register-shifted register)

Bitwise Exclusive OR (register-shifted register) performs a bitwise Exclusive OR of a register value and a register-shifted register value. It writes the result to the destination register, and can optionally update the condition flags based on the result.

**Encoding A1** ARMv4\*, ARMv5T\*, ARMv6\*, ARMv7

EOR{S}<C> <Rd>, <Rn>, <Rm>, <type> <Rs>

31	30	29	28	27	26	25	24	23	22	21	20	19	18	17	16	15	14	13	12	11	10	9	8	7	6	5	4	3	2	1	0
cond				0	0	0	0	0	0	1	S	Rn				Rd				Rs				0	type		1	Rm			

```
d = UInt(Rd); n = UInt(Rn); m = UInt(Rm); s = UInt(Rs);
setflags = (S == '1'); shift_t = DecodeRegShift(type);
if d == 15 || n == 15 || m == 15 || s == 15 then UNPREDICTABLE;
```

## Assembler syntax

EOR{S}{<c>}{<q>} {<Rd>}, <Rn>, <Rm>, <type> <Rs>

where:

S If S is present, the instruction updates the flags. Otherwise, the flags are not updated.

<c>, <q> See *Standard assembler syntax fields* on page A8-287.

<Rd> The destination register.

<Rn> The first operand register.

<Rm> The register that is shifted and used as the second operand.

<type> The type of shift to apply to the value read from <Rm>. It must be one of:

ASR Arithmetic shift right, encoded as type = 0b10.

LSL Logical shift left, encoded as type = 0b00.

LSR Logical shift right, encoded as type = 0b01.

ROR Rotate right, encoded as type = 0b11.

<Rs> The register whose bottom byte contains the amount to shift by.

The pre-UAL syntax EOR<c>S is equivalent to EORS<c>.

## Operation

```
if ConditionPassed() then
    EncodingSpecificOperations();
    shift_n = UInt(R[s]<7:0>);
    (shifted, carry) = Shift_C(R[m], shift_t, shift_n, APSR.C);
    result = R[n] EOR shifted;
    R[d] = result;
    if setflags then
        APSR.N = result<31>;
        APSR.Z = IsZeroBit(result);
        APSR.C = carry;
        // APSR.V unchanged
```

## Exceptions

None.

#### A8.8.49 ERET

Exception Return is a system instruction, see [ERET](#) on page B9-1980.

#### A8.8.50 F\*, former Floating-point instruction mnemonics

Before the introduction of UAL, the Floating-point (VFP) instructions had mnemonics starting with F. In UAL, most of these mnemonics are renamed to start with V. [Other UAL mnemonic changes on page AppxH-2469](#) lists all of the Floating-point instruction mnemonic changes. UAL does not define new mnemonics for the FLDMX and FSTMX instructions, see [FLDMX](#), [FSTMX](#).

##### FLDMX, FSTMX

Encodings T1/A1 of the VLDM, VPOP, VPUSH, and VSTM instructions contain an imm8 field that is set to twice the number of doubleword registers to be transferred. ARM deprecates use of these encodings with an odd value in imm8, and there is no UAL syntax for them.

The pre-UAL mnemonics FLDMX and FSTMX result in the same instructions as FLDMD (VLDM.64 or VPOP.64) and FSTMD (VSTM.64 or VPUSH.64) respectively, except that imm8 is equal to twice the number of doubleword registers plus one:

- from ARMv6, ARM deprecates use of FLDMX and FSTMX, except for disassembly purposes, and for reassembly of disassembled code
- if an FLDMX or FSTMX instruction accesses any register in the range D16-D32, the instruction is UNPREDICTABLE.

#### A8.8.51 HB, HBL, HBLP, HBP

These are ThumbEE instructions, see [HB](#), [HBL](#) on page A9-1125, [HBLP](#) on page A9-1126, and [HBP](#) on page A9-1127.

#### A8.8.52 HVC

Hypervisor Call is a system instruction, see [HVC](#) on page B9-1982.



### A8.8.53 ISB

Instruction Synchronization Barrier flushes the pipeline in the processor, so that all instructions following the ISB are fetched from cache or memory, after the instruction has been completed. It ensures that the effects of context changing operations executed before the ISB instruction are visible to the instructions fetched after the ISB. Context changing operations include changing the *Address Space Identifier* (ASID), TLB maintenance operations, branch predictor maintenance operations, and all changes to the CP15 registers. In addition, any branches that appear in program order after the ISB instruction are written into the branch prediction logic with the context that is visible after the ISB instruction. This is needed to ensure correct execution of the instruction stream.

#### Encoding T1 ARMv7

ISB<c> <option>

15	14	13	12	11	10	9	8	7	6	5	4	3	2	1	0	15	14	13	12	11	10	9	8	7	6	5	4	3	2	1	0
1	1	1	1	0	0	1	1	1	0	1	1	(1)	(1)	(1)	(1)	1	0	(0)	0	(1)	(1)	(1)	(1)	0	1	1	0	option			

// No additional decoding required

#### Encoding A1 ARMv7

ISB <option>

31	30	29	28	27	26	25	24	23	22	21	20	19	18	17	16	15	14	13	12	11	10	9	8	7	6	5	4	3	2	1	0
1	1	1	1	0	1	0	1	0	1	1	1	(1)	(1)	(1)	(1)	(1)	(1)	(1)	(1)	(1)	(0)	(0)	(0)	(0)	0	1	1	0	option		

// No additional decoding required

#### Assembler syntax

ISB{<c>}{<q>} {<option>}

where:

- <c>, <q> See [Standard assembler syntax fields on page A8-287](#). An ARM ISB instruction must be unconditional.
- <option> Specifies an optional limitation on the ISB operation. Values are:
  - SY Full system ISB operation, encoded as option = 0b1111. Can be omitted.
All other encodings of option are reserved. The corresponding instructions execute as full system ISB operations, but must not be relied upon by software.

#### Operation

```
if ConditionPassed() then
    EncodingSpecificOperations();
    InstructionSynchronizationBarrier();
```

#### Exceptions

None.

## A8.8.54 IT

If-Then makes up to four following instructions (the *IT block*) conditional. The conditions for the instructions in the IT block are the same as, or the inverse of, the condition the IT instruction specifies for the first instruction in the block.

The IT instruction itself does not affect the condition flags, but the execution of the instructions in the IT block can change the condition flags.

16-bit instructions in the IT block, other than `CMP`, `CMN` and `TST`, do not set the condition flags. An IT instruction with the AL condition can be used to get this changed behavior without conditional execution.

The architecture permits exception return to an instruction in the IT block only if the restoration of the `CPSR` restores `ITSTATE` to a state consistent with the conditions specified by the IT instruction. Any other exception return to an instruction in an IT block is UNPREDICTABLE. Any branch to a target instruction in an IT block is not permitted, and if such a branch is made it is UNPREDICTABLE what condition is used when executing that target instruction and any subsequent instruction in the IT block.

See also [Conditional instructions on page A4-162](#) and [Conditional execution on page A8-288](#).

### Encoding T1 ARMv6T2, ARMv7

IT{<x>{<y>{<z>}}} <firstcond> Not permitted in IT block

15	14	13	12	11	10	9	8	7	6	5	4	3	2	1	0
1	0	1	1	1	1	1	1	firstcond				mask			

```
if mask == '0000' then SEE "Related encodings";
if firstcond == '1111' || (firstcond == '1110' && BitCount(mask) != 1) then UNPREDICTABLE;
if InITBlock() then UNPREDICTABLE;
```

**Related encodings** See [If-Then, and hints on page A6-229](#).

### Assembler syntax

IT{<x>{<y>{<z>}}}{<q>} <firstcond>

where:

- <x> The condition for the second instruction in the IT block.
- <y> The condition for the third instruction in the IT block.
- <z> The condition for the fourth instruction in the IT block.
- <q> See [Standard assembler syntax fields on page A8-287](#). An IT instruction must be unconditional.
- <firstcond> The condition for the first instruction in the IT block. See [Table A8-1 on page A8-288](#) for the range of conditions available, and the encodings.

Each of <x>, <y>, and <z> can be either:

- T Then. The condition for the instruction is <firstcond>.
- E Else. The condition for the instruction is the inverse of <firstcond>. The condition code is the same as <firstcond>, except that the least significant bit is inverted. E must not be specified if <firstcond> is AL.

[Table A8-2 on page A8-391](#) shows how the values of <x>, <y>, and <z> determine the value of the mask field.

**Table A8-2 Determination of mask field**

<x>	<y>	<z>	mask[3]	mask[2]	mask[1]	mask[0]
Omitted	Omitted	Omitted	1	0	0	0
T	Omitted	Omitted	firstcond[0]	1	0	0
E	Omitted	Omitted	NOT firstcond[0]	1	0	0
T	T	Omitted	firstcond[0]	firstcond[0]	1	0
E	T	Omitted	NOT firstcond[0]	firstcond[0]	1	0
T	E	Omitted	firstcond[0]	NOT firstcond[0]	1	0
E	E	Omitted	NOT firstcond[0]	NOT firstcond[0]	1	0
T	T	T	firstcond[0]	firstcond[0]	firstcond[0]	1
E	T	T	NOT firstcond[0]	firstcond[0]	firstcond[0]	1
T	E	T	firstcond[0]	NOT firstcond[0]	firstcond[0]	1
E	E	T	NOT firstcond[0]	NOT firstcond[0]	firstcond[0]	1
T	T	E	firstcond[0]	firstcond[0]	NOT firstcond[0]	1
E	T	E	NOT firstcond[0]	firstcond[0]	NOT firstcond[0]	1
T	E	E	firstcond[0]	NOT firstcond[0]	NOT firstcond[0]	1
E	E	E	NOT firstcond[0]	NOT firstcond[0]	NOT firstcond[0]	1

The conditions specified in an IT instruction must match those specified in the syntax of the instructions in its IT block. When assembling to ARM code, assemblers check IT instruction syntax for validity but do not generate assembled instructions for them. See [Conditional instructions on page A4-162](#).

### Operation

```
EncodingSpecificOperations();
ITSTATE.IT<7:0> = firstcond:mask;
```

### Exceptions

None.

### A8.8.55 LDC, LDC2 (immediate)

Load Coprocessor loads memory data from a sequence of consecutive memory addresses to a coprocessor. If no coprocessor can execute the instruction, an Undefined Instruction exception is generated.

This is a generic coprocessor instruction. Some of the fields have no functionality defined by the architecture and are free for use by the coprocessor instruction set designer. These are the D bit, the CRd field, and in the Unindexed addressing mode only, the imm8 field. However, coprocessors CP8-CP15 are reserved for use by ARM, and this manual defines the valid LDC and LDC2 instructions when coproc is in the range p8-p15. For more information see [Coprocessor support on page A2-94](#).

In an implementation that includes the Virtualization Extensions, the permitted LDC access to a system control register can be trapped to Hyp mode, meaning that an attempt to execute an LDC instruction in a Non-secure mode other than Hyp mode, that would be permitted in the absence of the Hyp trap controls, generates a Hyp Trap exception. For more information, see [Trapping general CPI4 accesses to debug registers on page B1-1260](#).

———— **Note** —————

For simplicity, the LDC pseudocode does not show this possible trap to Hyp mode.

**Encoding T1/A1** ARMv6T2, ARMv7 for encoding T1  
ARMv4\*, ARMv5T\*, ARMv6\*, ARMv7 for encoding A1

LDC{L}<C> <coproc>, <CRd>, [<Rn>, #+/-<imm>]{!}  
LDC{L}<C> <coproc>, <CRd>, [<Rn>], #+/-<imm>  
LDC{L}<C> <coproc>, <CRd>, [<Rn>], <option>

15	14	13	12	11	10	9	8	7	6	5	4	3	2	1	0	15	14	13	12	11	10	9	8	7	6	5	4	3	2	1	0
1	1	1	0	1	1	0	P	U	D	W	1		Rn			CRd															
31	30	29	28	27	26	25	24	23	22	21	20	19	18	17	16	15	14	13	12	11	10	9	8	7	6	5	4	3	2	1	0
																cond															

```

if Rn == '1111' then SEE LDC (literal);
if P == '0' && U == '0' && D == '0' && W == '0' then UNDEFINED;
if P == '0' && U == '0' && D == '1' && W == '0' then SEE MRRC, MRRC2;
if coproc IN "101x" then SEE "Advanced SIMD and Floating-point";
n = UInt(Rn); cp = UInt(coproc);
imm32 = ZeroExtend(imm8:'00', 32); index = (P == '1'); add = (U == '1'); wback = (W == '1');

```

**Encoding T2/A2** ARMv6T2, ARMv7 for encoding T2  
ARMv5T\*, ARMv6\*, ARMv7 for encoding A2

LDC2{L}<C> <coproc>, <CRd>, [<Rn>, #+/-<imm>]{!}  
LDC2{L}<C> <coproc>, <CRd>, [<Rn>], #+/-<imm>  
LDC2{L}<C> <coproc>, <CRd>, [<Rn>], <option>

15	14	13	12	11	10	9	8	7	6	5	4	3	2	1	0	15	14	13	12	11	10	9	8	7	6	5	4	3	2	1	0
1	1	1	1	1	1	0	P	U	D	W	1		Rn			CRd															
31	30	29	28	27	26	25	24	23	22	21	20	19	18	17	16	15	14	13	12	11	10	9	8	7	6	5	4	3	2	1	0
																1	1	1	1	1	1	0	P	U	D	W	1		Rn		

```

if Rn == '1111' then SEE LDC (literal);
if P == '0' && U == '0' && D == '0' && W == '0' then UNDEFINED;
if P == '0' && U == '0' && D == '1' && W == '0' then SEE MRRC, MRRC2;
if coproc IN "101x" then UNDEFINED;
n = UInt(Rn); cp = UInt(coproc);
imm32 = ZeroExtend(imm8:'00', 32); index = (P == '1'); add = (U == '1'); wback = (W == '1');

```

**Advanced SIMD and Floating-point** See [Extension register load/store instructions on page A7-274](#)

## Assembler syntax

LDC{2}{L}{<c>}{<q>} <coproc>, <CRd>, [<Rn>{, #+/-<imm>}] Offset. P = 1, W = 0.  
LDC{2}{L}{<c>}{<q>} <coproc>, <CRd>, [<Rn>, #+/-<imm>]! Pre-indexed. P = 1, W = 1.  
LDC{2}{L}{<c>}{<q>} <coproc>, <CRd>, [<Rn>], #+/-<imm> Post-indexed. P = 0, W = 1.  
LDC{2}{L}{<c>}{<q>} <coproc>, <CRd>, [<Rn>], <option> Unindexed. P = 0, W = 0, U = 1.

where:

2 If specified, selects encoding T2/A2. If omitted, selects encoding T1/A1.  
L If specified, selects the D == 1 form of the encoding. If omitted, selects the D == 0 form.  
<c>, <q> See *Standard assembler syntax fields on page A8-287*. An ARM LDC2 instruction must be unconditional.  
<coproc> The name of the coprocessor. The generic coprocessor names are p0-p15.  
<CRd> The coprocessor destination register.  
<Rn> The base register. The SP can be used. For PC use see *LDC, LDC2 (literal) on page A8-394*.  
+/- Is + or omitted if the immediate offset is to be added to the base register value (add == TRUE, encoded as U == 1), or – if it is to be subtracted (add == FALSE, encoded as U == 0). #0 and #-0 generate different instructions.  
<imm> The immediate offset used for forming the address. Values are multiples of 4 in the range 0-1020. For the offset addressing syntax, <imm> can be omitted, meaning an offset of +0.  
<option> A coprocessor option. An integer in the range 0-255 enclosed in { }. Encoded in imm8.

The pre-UAL syntax LDC<c>L is equivalent to LDCL<c>.

## Operation

```

if ConditionPassed() then
    EncodingSpecificOperations();
    if !Coprocc_Accepted(cp, ThisInstr()) then
        GenerateCoproccorException();
    else
        NullCheckIfThumbEE(n);
        offset_addr = if add then (R[n] + imm32) else (R[n] - imm32);
        address = if index then offset_addr else R[n];
        repeat
            Coproc_SendLoadedWord(MemA[address,4], cp, ThisInstr());
            address = address + 4;
        until Coproc_DoneLoading(cp, ThisInstr());
        if wback then R[n] = offset_addr;

```

## Exceptions

Undefined Instruction, Data Abort, Hyp Trap.

Uses of these instructions by specific coprocessors might generate other exceptions.

### A8.8.56 LDC, LDC2 (literal)

Load Coprocessor loads memory data from a sequence of consecutive memory addresses to a coprocessor. If no coprocessor can execute the instruction, an Undefined Instruction exception is generated.

This is a generic coprocessor instruction. Some of the fields have no functionality defined by the architecture and are free for use by the coprocessor instruction set designer. These are the D bit, the CRd field, and in the Unindexed addressing mode only, the imm8 field. However, coprocessors CP8-CP15 are reserved for use by ARM, and this manual defines the valid LDC and LDC2 instructions when coproc is in the range p8-p15. For more information see [Coprocesor support on page A2-94](#).

In an implementation that includes the Virtualization Extensions, the permitted LDC access to a system control register can be trapped to Hyp mode, meaning that an attempt to execute an LDC instruction in a Non-secure mode other than Hyp mode, that would be permitted in the absence of the Hyp trap controls, generates a Hyp Trap exception. For more information, see [Trapping general CPI4 accesses to debug registers on page B1-1260](#).

———— **Note** —————

For simplicity, the LDC pseudocode does not show this possible trap to Hyp mode.

**Encoding T1/A1** ARMv6T2, ARMv7 for encoding T1  
ARMv4\*, ARMv5T\*, ARMv6\*, ARMv7 for encoding A1

LDC{L}<C> <coproc>, <CRd>, <label>

LDC{L}<C> <coproc>, <CRd>, [PC, #-0] Special case

LDC{L}<C> <coproc>, <CRd>, [PC], <option>

15	14	13	12	11	10	9	8	7	6	5	4	3	2	1	0	15	14	13	12	11	10	9	8	7	6	5	4	3	2	1	0
1	1	1	0	1	1	0	P	U	D	W	1	1	1	1	1	CRd	coproc				imm8										

31	30	29	28	27	26	25	24	23	22	21	20	19	18	17	16	15	14	13	12	11	10	9	8	7	6	5	4	3	2	1	0
cond		1	1	0	P	U	D	W	1	1	1	1	1	1	1	CRd	coproc				imm8										

```

if P == '0' && U == '0' && D == '0' && W == '0' then UNDEFINED;
if P == '0' && U == '0' && D == '1' && W == '0' then SEE MRRC, MRRC2;
if coproc IN "101x" then SEE "Advanced SIMD and Floating-point";
index = (P == '1'); add = (U == '1'); cp = UInt(coproc); imm32 = ZeroExtend(imm8:'00', 32);
if W == '1' || (P == '0' && CurrentInstrSet() != InstrSet_ARM) then UNPREDICTABLE;

```

**Encoding T2/A2** ARMv6T2, ARMv7 for encoding T2  
ARMv5T\*, ARMv6\*, ARMv7 for encoding A2

LDC2{L}<C> <coproc>, <CRd>, <label>

LDC2{L}<C> <coproc>, <CRd>, [PC, #-0] Special case

LDC2{L}<C> <coproc>, <CRd>, [PC], <option>

15	14	13	12	11	10	9	8	7	6	5	4	3	2	1	0	15	14	13	12	11	10	9	8	7	6	5	4	3	2	1	0
1	1	1	1	1	1	0	P	U	D	W	1	1	1	1	1	CRd	coproc				imm8										

31	30	29	28	27	26	25	24	23	22	21	20	19	18	17	16	15	14	13	12	11	10	9	8	7	6	5	4	3	2	1	0
1	1	1	1	1	1	0	P	U	D	W	1	1	1	1	1	CRd	coproc				imm8										

```

if P == '0' && U == '0' && D == '0' && W == '0' then UNDEFINED;
if P == '0' && U == '0' && D == '1' && W == '0' then SEE MRRC, MRRC2;
if coproc IN "101x" then UNDEFINED;
index = (P == '1'); add = (U == '1'); cp = UInt(coproc); imm32 = ZeroExtend(imm8:'00', 32);
if W == '1' || (P == '0' && CurrentInstrSet() != InstrSet_ARM) then UNPREDICTABLE;

```

**Advanced SIMD and Floating-point** See [Extension register load/store instructions on page A7-274](#)

## Assembler syntax

LDC{2}{L}{<c>}{<q>}	<coproc>, <CRd>, <label>	Normal form with P = 1, W = 0
LDC{2}{L}{<c>}{<q>}	<coproc>, <CRd>, [PC, #+/-<imm>]	Alternative form with P = 1, W = 0
LDC{2}{L}{<c>}{<q>}	<coproc>, <CRd>, [PC], <option>	Unindexed form with P = 0, U = 1, W = 0, encoding A1/A2 only

where:

2	If specified, selects encoding T2/A2. If omitted, selects encoding T1/A1.
L	If specified, selects the D == 1 form of the encoding. If omitted, selects the D == 0 form.
<c>, <q>	See <a href="#">Standard assembler syntax fields on page A8-287</a> . An ARM LDC2 instruction must be unconditional.
<coproc>	The name of the coprocessor. The generic coprocessor names are p0-p15.
<CRd>	The coprocessor destination register.
<label>	The label of the literal data item that is to be loaded into <Rt>. The assembler calculates the required value of the offset from the Align(PC, 4) value of the instruction to this label. Permitted values of the offset are multiples of 4 in the range -1020 to 1020. If the offset is zero or positive, imm32 is equal to the offset and add == TRUE (encoded as U == 1). If the offset is negative, imm32 is equal to minus the offset and add == FALSE (encoded as U == 0).

The alternative syntax permits the addition or subtraction of the offset and the immediate offset to be specified separately, including permitting a subtraction of 0 that cannot be specified using the normal syntax. For more information, see [Use of labels in UAL instruction syntax on page A4-162](#).

The unindexed form is permitted for the ARM instruction set only. In it, <option> is a coprocessor option, written as an integer 0-255 enclosed in { } and encoded in imm8.

The pre-UAL syntax LDC<c>L is equivalent to LDCL<c>.

## Operation

```

if ConditionPassed() then
    EncodingSpecificOperations();
    if !Coprocc_Accepted(cp, ThisInstr()) then
        GenerateCoproccorException();
    else
        NullCheckIfThumbEE(15);
        offset_addr = if add then (Align(PC,4) + imm32) else (Align(PC,4) - imm32);
        address = if index then offset_addr else Align(PC,4);
        repeat
            Coproc_SendLoadedWord(MemA[address,4], cp, ThisInstr());
            address = address + 4;
        until Coproc_DoneLoading(cp, ThisInstr());

```

## Exceptions

Undefined Instruction, Data Abort, Hyp Trap.

Uses of these instructions by specific coprocessors might generate other exceptions.

### A8.8.57 LDM/LDMIA/LDMFD (Thumb)

Load Multiple Increment After (Load Multiple Full Descending) loads multiple registers from consecutive memory locations using an address from a base register. The consecutive memory locations start at this address, and the address just above the highest of those locations can optionally be written back to the base register. The registers loaded can include the PC, causing a branch to a loaded address. Related system instructions are *LDM (User registers)* on page B9-1986 and *LDM (exception return)* on page B9-1984.

**Encoding T1** ARMv4T, ARMv5T\*, ARMv6\*, ARMv7 (not in ThumbEE)

LDM<c> <Rn>!, <registers> <Rn> not included in <registers>

LDM<c> <Rn>, <registers> <Rn> included in <registers>

15	14	13	12	11	10	9	8	7	6	5	4	3	2	1	0
1	1	0	0	1	Rn					register_list					

```
if CurrentInstrSet() == InstrSet_ThumbEE then SEE "ThumbEE instructions";
n = UInt(Rn); registers = '0000000':register_list; wback = (registers<n> == '0');
if BitCount(registers) < 1 then UNPREDICTABLE;
```

**Encoding T2** ARMv6T2, ARMv7

LDM<c>.W <Rn>{!}, <registers>

15	14	13	12	11	10	9	8	7	6	5	4	3	2	1	0	15	14	13	12	11	10	9	8	7	6	5	4	3	2	1	0
1	1	1	0	1	0	0	0	1	0	W	1	Rn				P	M	(0)	register_list												

```
if W == '1' && Rn == '1101' then SEE POP (Thumb);
n = UInt(Rn); registers = P:M:'0':register_list; wback = (W == '1');
if n == 15 || BitCount(registers) < 2 || (P == '1' && M == '1') then UNPREDICTABLE;
if registers<15> == '1' && InITBlock() && !LastInITBlock() then UNPREDICTABLE;
if wback && registers<n> == '1' then UNPREDICTABLE;
```

**ThumbEE instructions** See *16-bit ThumbEE instructions* on page A9-1115.



## Assembler syntax

LDM{<c>}{<q>} <Rn>{!}, <registers>

where:

<c>, <q> See *Standard assembler syntax fields* on page A8-287.

<Rn> The base register. SP can be used. If it is the SP and ! is specified, the instruction is treated as described in *POP (Thumb)* on page A8-534.

! Causes the instruction to write a modified value back to <Rn>. Encoded as W = 1. If ! is omitted, the instruction does not change <Rn> in this way. Encoded as W = 0.

<registers> Is a list of one or more registers to be loaded, separated by commas and surrounded by { and }. The lowest-numbered register is loaded from the lowest memory address, through to the highest-numbered register from the highest memory address. See also *Encoding of lists of ARM core registers* on page A8-295.

Encoding T2 does not support a list containing only one register. If an LDMIA instruction with just one register <Rt> in the list is assembled to Thumb and encoding T1 is not available, it is assembled to the equivalent LDR{<c>}{<q>} <Rt>, [<Rn>]{, #4} instruction.

The SP cannot be in the list.

The PC can be in the list. If it is, the instruction branches to the address loaded to the PC. In ARMv5T and above, this is an interworking branch, see *Pseudocode details of operations on ARM core registers* on page A2-47. If the PC is in the list:

- the LR must not be in the list
- the instruction must be either outside any IT block, or the last instruction in an IT block.

If ! is specified, <registers> cannot include the base register.

LDMIA and LDMFD are pseudo-instructions for LDM. LDMFD refers to its use for popping data from Full Descending stacks.

The pre-UAL syntaxes LDM<c>IA and LDM<c>FD are equivalent to LDM<c>.

## Operation

```

if ConditionPassed() then
    EncodingSpecificOperations();  NullCheckIfThumbEE(n);
    address = R[n];
    for i = 0 to 14
        if registers<i> == '1' then
            R[i] = MemA[address,4];  address = address + 4;
    if registers<15> == '1' then
        LoadWritePC(MemA[address,4]);
    if wback && registers<n> == '0' then R[n] = R[n] + 4*BitCount(registers);
    if wback && registers<n> == '1' then R[n] = bits(32) UNKNOWN;

```

## Exceptions

Data Abort.

### A8.8.58 LDM/LDMIA/LDMFD (ARM)

Load Multiple Increment After (Load Multiple Full Descending) loads multiple registers from consecutive memory locations using an address from a base register. The consecutive memory locations start at this address, and the address just above the highest of those locations can optionally be written back to the base register. The registers loaded can include the PC, causing a branch to a loaded address. Related system instructions are *LDM (User registers)* on page B9-1986 and *LDM (exception return)* on page B9-1984.

**Encoding A1** ARMv4\*, ARMv5T\*, ARMv6\*, ARMv7

LDM<c> <Rn>{!}, <registers>

31	30	29	28	27	26	25	24	23	22	21	20	19	18	17	16	15	14	13	12	11	10	9	8	7	6	5	4	3	2	1	0
cond				1	0	0	0	1	0	W	1	Rn				register_list															

```

if W == '1' && Rn == '1101' && BitCount(register_list) > 1 then SEE POP (ARM);
n = UInt(Rn); registers = register_list; wback = (W == '1');
if n == 15 || BitCount(registers) < 1 then UNPREDICTABLE;
if wback && registers<n> == '1' && ArchVersion() >= 7 then UNPREDICTABLE;

```

## Assembler syntax

LDM{<c>}{<q>} <Rn>{!}, <registers>

where:

- <c>, <q> See [Standard assembler syntax fields on page A8-287](#).
- <Rn> The base register. SP can be used. If the SP is used, ! is specified, and there is more than one register in the <registers> list, the instruction is treated as described in [POP \(ARM\) on page A8-536](#).
- ! Causes the instruction to write a modified value back to <Rn>. Encoded as W = 1. If ! is omitted, the instruction does not change <Rn> in this way. Encoded as W = 0.
- <registers> Is a list of one or more registers to be loaded, separated by commas and surrounded by { and }. The lowest-numbered register is loaded from the lowest memory address, through to the highest-numbered register from the highest memory address. See also [Encoding of lists of ARM core registers on page A8-295](#).  
The SP can be in the list. However, ARM deprecates using these instructions with SP in the list.  
The PC can be in the list. If it is, the instruction branches to the address loaded to the PC. In ARMv5T and above, this is an interworking branch, see [Pseudocode details of operations on ARM core registers on page A2-47](#).  
ARM deprecates using these instructions with both the LR and the PC in the list.  
Instructions with the base register in the list and ! specified are only available before ARMv7, and ARM deprecates the use of such instructions. The value of the base register after such an instruction is UNKNOWN.

LDMIA and LDMFD are pseudo-instructions for LDM. LDMFD refers to its use for popping data from Full Descending stacks.

The pre-UAL syntaxes LDM<c>IA and LDM<c>FD are equivalent to LDM<c>.

## Operation

```

if ConditionPassed() then
    EncodingSpecificOperations();  NullCheckIfThumbEE(n);
    address = R[n];
    for i = 0 to 14
        if registers<i> == '1' then
            R[i] = MemA[address,4];  address = address + 4;
    if registers<15> == '1' then
        LoadWritePC(MemA[address,4]);
    if wback && registers<n> == '0' then R[n] = R[n] + 4*BitCount(registers);
    if wback && registers<n> == '1' then R[n] = bits(32) UNKNOWN;

```

## Exceptions

Data Abort.

### A8.8.59 LDMDA/LDMFA

Load Multiple Decrement After (Load Multiple Full Ascending) loads multiple registers from consecutive memory locations using an address from a base register. The consecutive memory locations end at this address, and the address just below the lowest of those locations can optionally be written back to the base register. The registers loaded can include the PC, causing a branch to a loaded address.

Related system instructions are [LDM \(User registers\) on page B9-1986](#) and [LDM \(exception return\) on page B9-1984](#).

**Encoding A1** ARMv4\*, ARMv5T\*, ARMv6\*, ARMv7  
LDMDA<c> <Rn>{!}, <registers>

31	30	29	28	27	26	25	24	23	22	21	20	19	18	17	16	15	14	13	12	11	10	9	8	7	6	5	4	3	2	1	0
cond		1	0	0	0	0	0	0	W	1	Rn		register_list																		

```
n = UInt(Rn); registers = register_list; wback = (W == '1');
if n == 15 || BitCount(registers) < 1 then UNPREDICTABLE;
if wback && registers<n> == '1' && ArchVersion() >= 7 then UNPREDICTABLE;
```

## Assembler syntax

LMDMA{<c>}{<q>} <Rn>{!}, <registers>

where:

- <c>, <q> See [Standard assembler syntax fields on page A8-287](#).
- <Rn> The base register. SP can be used.
- ! Causes the instruction to write a modified value back to <Rn>. Encoded as W = 1.  
If ! is omitted, the instruction does not change <Rn> in this way. Encoded as W = 0.
- <registers> Is a list of one or more registers to be loaded, separated by commas and surrounded by { and }. The lowest-numbered register is loaded from the lowest memory address, through to the highest-numbered register from the highest memory address. See also [Encoding of lists of ARM core registers on page A8-295](#).  
  
The SP can be in the list. However, instructions that include the SP in the list are deprecated.  
  
The PC can be in the list. If it is, the instruction branches to the address (data) loaded to the PC. In ARMv5T and above, this branch is an interworking branch, see [Pseudocode details of operations on ARM core registers on page A2-47](#).  
  
Instructions that include both the LR and the PC in the list are deprecated.  
  
Instructions with the base register in the list and ! specified are only available before ARMv7, and ARM deprecates the use of such instructions. The value of the base register after such an instruction is UNKNOWN.

LDMFA is a pseudo-instruction for LMDMA, referring to its use for popping data from Full Ascending stacks.

The pre-UAL syntaxes LDM<c>DA and LDM<c>FA are equivalent to LMDMA<c>.

## Operation

```

if ConditionPassed() then
    EncodingSpecificOperations();
    address = R[n] - 4*BitCount(registers) + 4;
    for i = 0 to 14
        if registers<i> == '1' then
            R[i] = MemA[address,4]; address = address + 4;
    if registers<15> == '1' then
        LoadWritePC(MemA[address,4]);
    if wback && registers<n> == '0' then R[n] = R[n] - 4*BitCount(registers);
    if wback && registers<n> == '1' then R[n] = bits(32) UNKNOWN;

```

## Exceptions

Data Abort.

### A8.8.60 LDMDB/LDMEA

Load Multiple Decrement Before (Load Multiple Empty Ascending) loads multiple registers from consecutive memory locations using an address from a base register. The consecutive memory locations end just below this address, and the address of the lowest of those locations can optionally be written back to the base register. The registers loaded can include the PC, causing a branch to a loaded address.

Related system instructions are [LDM \(User registers\) on page B9-1986](#) and [LDM \(exception return\) on page B9-1984](#).

#### Encoding T1 ARMv6T2, ARMv7

LDMDB<c> <Rn>{!}, <registers>

15	14	13	12	11	10	9	8	7	6	5	4	3	2	1	0	15	14	13	12	11	10	9	8	7	6	5	4	3	2	1	0
1	1	1	0	1	0	0	1	0	0	W	1			Rn		P	M	(0)	register_list												

```
n = UInt(Rn); registers = P:M:'0':register_list; wback = (W == '1');
if n == 15 || BitCount(registers) < 2 || (P == '1' && M == '1') then UNPREDICTABLE;
if registers<15> == '1' && InITBlock() && !LastInITBlock() then UNPREDICTABLE;
if wback && registers<n> == '1' then UNPREDICTABLE;
```

#### Encoding A1 ARMv4\*, ARMv5T\*, ARMv6\*, ARMv7

LDMDB<c> <Rn>{!}, <registers>

31	30	29	28	27	26	25	24	23	22	21	20	19	18	17	16	15	14	13	12	11	10	9	8	7	6	5	4	3	2	1	0
cond		1	0	0	1	0	0	W	1			Rn	register_list																		

```
n = UInt(Rn); registers = register_list; wback = (W == '1');
if n == 15 || BitCount(registers) < 1 then UNPREDICTABLE;
if wback && registers<n> == '1' && ArchVersion() >= 7 then UNPREDICTABLE;
```

## Assembler syntax

LDMDB{<c>}{<q>} <Rn>{!}, <registers>

where:

<c>, <q> See [Standard assembler syntax fields on page A8-287](#).

<Rn> The base register. The SP can be used.

! Causes the instruction to write a modified value back to <Rn>. Encoded as W = 1.  
If ! is omitted, the instruction does not change <Rn> in this way. Encoded as W = 0.

<registers> Is a list of one or more registers to be loaded, separated by commas and surrounded by { and }. The lowest-numbered register is loaded from the lowest memory address, through to the highest-numbered register from the highest memory address. See also [Encoding of lists of ARM core registers on page A8-295](#).

Encoding T1 does not support a list containing only one register. If an LDMDB instruction with just one register <Rt> in the list is assembled to Thumb, it is assembled to the equivalent LDR{<c>}{<q>} <Rt>, [<Rn>, #-4]{!} instruction.

The SP can be in the list in ARM instructions, but not in Thumb instructions. However, ARM instructions that include the SP in the list are deprecated.

The PC can be in the list. If it is, the instruction branches to the address loaded to the PC. In ARMv5T and above, this is an interworking branch, see [Pseudocode details of operations on ARM core registers on page A2-47](#). In Thumb instructions, if the PC is in the list:

- the LR must not be in the list
- the instruction must be either outside any IT block, or the last instruction in an IT block.

ARM instructions that include both the LR and the PC in the list are deprecated.

Instructions with the base register in the list and ! specified are only available in the ARM instruction set before ARMv7, and ARM deprecates the use of such instructions. The value of the base register after such an instruction is UNKNOWN.

LDMEA is a pseudo-instruction for LDMDB, referring to its use for popping data from Empty Ascending stacks.

The pre-UAL syntaxes LDM<c>DB and LDM<c>EA are equivalent to LDMDB<c>.

## Operation

```

if ConditionPassed() then
    EncodingSpecificOperations(); NullCheckIfThumbEE(n);
    address = R[n] - 4*BitCount(registers);
    for i = 0 to 14
        if registers<i> == '1' then
            R[i] = MemA[address,4]; address = address + 4;
    if registers<15> == '1' then
        LoadWritePC(MemA[address,4]);
    if wback && registers<n> == '0' then R[n] = R[n] - 4*BitCount(registers);
    if wback && registers<n> == '1' then R[n] = bits(32) UNKNOWN;

```

## Exceptions

Data Abort.

### A8.8.61 LDMIB/LDMED

Load Multiple Increment Before (Load Multiple Empty Descending) loads multiple registers from consecutive memory locations using an address from a base register. The consecutive memory locations start just above this address, and the address of the last of those locations can optionally be written back to the base register. The registers loaded can include the PC, causing a branch to a loaded address.

Related system instructions are [LDM \(User registers\) on page B9-1986](#) and [LDM \(exception return\) on page B9-1984](#).

**Encoding A1** ARMv4\*, ARMv5T\*, ARMv6\*, ARMv7  
LDMIB<c> <Rn>{!}, <registers>

31	30	29	28	27	26	25	24	23	22	21	20	19	18	17	16	15	14	13	12	11	10	9	8	7	6	5	4	3	2	1	0
cond		1	0	0	1	1	0	W	1	Rn		register_list																			

```
n = UInt(Rn); registers = register_list; wback = (W == '1');
if n == 15 || BitCount(registers) < 1 then UNPREDICTABLE;
if wback && registers<n> == '1' && ArchVersion() >= 7 then UNPREDICTABLE;
```



## Assembler syntax

LDMIB{<c>}{<q>} <Rn>{!}, <registers>

where:

- <c>, <q> See [Standard assembler syntax fields on page A8-287](#).
- <Rn> The base register. The SP can be used.
- ! Causes the instruction to write a modified value back to <Rn>. Encoded as W = 1.  
If ! is omitted, the instruction does not change <Rn> in this way. Encoded as W = 0.
- <registers> Is a list of one or more registers to be loaded, separated by commas and surrounded by { and }. The lowest-numbered register is loaded from the lowest memory address, through to the highest-numbered register from the highest memory address. See also [Encoding of lists of ARM core registers on page A8-295](#).  
  
The SP can be in the list. However, instructions that include the SP in the list are deprecated.  
  
The PC can be in the list. If it is, the instruction branches to the address (data) loaded to the PC. In ARMv5T and above, this branch is an interworking branch, see [Pseudocode details of operations on ARM core registers on page A2-47](#).  
  
Instructions that include both the LR and the PC in the list are deprecated.  
  
Instructions with the base register in the list and ! specified are only available before ARMv7, and ARM deprecates the use of such instructions. The value of the base register after such an instruction is UNKNOWN.

LDMED is a pseudo-instruction for LDMIB, referring to its use for popping data from Empty Descending stacks.

The pre-UAL syntaxes LDM<c>IB and LDM<c>ED are equivalent to LDMIB<c>.

## Operation

```

if ConditionPassed() then
    EncodingSpecificOperations();
    address = R[n] + 4;
    for i = 0 to 14
        if registers<i> == '1' then
            R[i] = MemA[address,4]; address = address + 4;
    if registers<15> == '1' then
        LoadWritePC(MemA[address,4]);
    if wback && registers<n> == '0' then R[n] = R[n] + 4*BitCount(registers);
    if wback && registers<n> == '1' then R[n] = bits(32) UNKNOWN;

```

## Exceptions

Data Abort.

## A8.8.62 LDR (immediate, Thumb)

Load Register (immediate) calculates an address from a base register value and an immediate offset, loads a word from memory, and writes it to a register. It can use offset, post-indexed, or pre-indexed addressing. For information about memory accesses see [Memory accesses on page A8-294](#).

**Encoding T1** ARMv4T, ARMv5T\*, ARMv6\*, ARMv7  
LDR<c> <Rt>, [<Rn>{, #<imm>}]

15	14	13	12	11	10	9	8	7	6	5	4	3	2	1	0
0	1	1	0	1	imm5				Rn			Rt			

t = UInt(Rt); n = UInt(Rn); imm32 = ZeroExtend(imm5:'00', 32);  
index = TRUE; add = TRUE; wback = FALSE;

**Encoding T2** ARMv4T, ARMv5T\*, ARMv6\*, ARMv7  
LDR<c> <Rt>, [SP{, #<imm>}]

15	14	13	12	11	10	9	8	7	6	5	4	3	2	1	0
1	0	0	1	1	Rt			imm8							

t = UInt(Rt); n = 13; imm32 = ZeroExtend(imm8:'00', 32);  
index = TRUE; add = TRUE; wback = FALSE;

**Encoding T3** ARMv6T2, ARMv7  
LDR<c>.W <Rt>, [<Rn>{, #<imm12>}]

15	14	13	12	11	10	9	8	7	6	5	4	3	2	1	0	15	14	13	12	11	10	9	8	7	6	5	4	3	2	1	0
1	1	1	1	1	0	0	0	1	1	0	1	Rn			Rt			imm12													

if Rn == '1111' then SEE LDR (literal);  
t = UInt(Rt); n = UInt(Rn); imm32 = ZeroExtend(imm12, 32); index = TRUE; add = TRUE;  
wback = FALSE; if t == 15 && InITBlock() && !LastInITBlock() then UNPREDICTABLE;

**Encoding T4** ARMv6T2, ARMv7  
LDR<c> <Rt>, [<Rn>, #-<imm8>]  
LDR<c> <Rt>, [<Rn>], #+/-<imm8>  
LDR<c> <Rt>, [<Rn>, #+/-<imm8>]!

15	14	13	12	11	10	9	8	7	6	5	4	3	2	1	0	15	14	13	12	11	10	9	8	7	6	5	4	3	2	1	0
1	1	1	1	1	0	0	0	0	1	0	1	Rn			Rt			1	P	U	W	imm8									

if Rn == '1111' then SEE LDR (literal);  
if P == '1' && U == '1' && W == '0' then SEE LDRT;  
if Rn == '1101' && P == '0' && U == '1' && W == '1' && imm8 == '00000100' then SEE POP;  
if P == '0' && W == '0' then UNDEFINED;  
t = UInt(Rt); n = UInt(Rn);  
imm32 = ZeroExtend(imm8, 32); index = (P == '1'); add = (U == '1'); wback = (W == '1');  
if (wback && n == t) || (t == 15 && InITBlock() && !LastInITBlock()) then UNPREDICTABLE;

## Assembler syntax

LDR{<c>}{<q>} <Rt>, [<Rn> {, #+/-<imm>}]	Offset: index==TRUE, wback==FALSE
LDR{<c>}{<q>} <Rt>, [<Rn>, #+/-<imm>]!	Pre-indexed: index==TRUE, wback==TRUE
LDR{<c>}{<q>} <Rt>, [<Rn>], #+/-<imm>	Post-indexed: index==FALSE, wback==TRUE

where:

<c>, <q>	See <a href="#">Standard assembler syntax fields on page A8-287</a> .
<Rt>	The destination register. The SP can be used. The PC can be used, provided the instruction is either outside an IT block or the last instruction of an IT block. If the PC is used, the instruction branches to the address (data) loaded to the PC. In ARMv5T and above, this branch is an interworking branch, see <a href="#">Pseudocode details of operations on ARM core registers on page A2-47</a> .
<Rn>	The base register. The SP can be used. For PC use see <a href="#">LDR (literal) on page A8-410</a> .
+/-	<b>+ or omitted</b> The immediate offset is to be added to the base register value (add == TRUE, encoded as U == 1 in encoding T4).  <b>-</b> The immediate offset is to be subtracted from the base register value. Encoding T4 must be used, with add == FALSE, encoded as U == 0.  #0 and #-0 generate different instructions.
<imm>	The immediate offset used for forming the address. For the offset addressing syntax, <imm> can be omitted, meaning an offset of 0. Values are: <b>Encoding T1</b> Multiples of 4 in the range 0-124. <b>Encoding T2</b> Multiples of 4 in the range 0-1020. <b>Encoding T3</b> Any value in the range 0-4095. <b>Encoding T4</b> Any value in the range 0-255.

## Operation

```

if ConditionPassed() then
    EncodingSpecificOperations(); NullCheckIfThumbEE(n);
    offset_addr = if add then (R[n] + imm32) else (R[n] - imm32);
    address = if index then offset_addr else R[n];
    data = MemU[address,4];
    if wback then R[n] = offset_addr;
    if t == 15 then
        if address<1:0> == '00' then LoadWritePC(data); else UNPREDICTABLE;
    elseif UnalignedSupport() || address<1:0> == '00' then
        R[t] = data;
    else R[t] = bits(32) UNKNOWN; // Can only apply before ARMv7

```

## Exceptions

Data Abort.

## ThumbEE instruction

ThumbEE has additional LDR (immediate) encodings, see [LDR \(immediate\) on page A9-1128](#).

### A8.8.63 LDR (immediate, ARM)

Load Register (immediate) calculates an address from a base register value and an immediate offset, loads a word from memory, and writes it to a register. It can use offset, post-indexed, or pre-indexed addressing. For information about memory accesses see [Memory accesses](#) on page A8-294.

**Encoding A1** ARMv4\*, ARMv5T\*, ARMv6\*, ARMv7

LDR<c> <Rt>, [<Rn>{, #+/-<imm12>}]

LDR<c> <Rt>, [<Rn>], #+/-<imm12>

LDR<c> <Rt>, [<Rn>, #+/-<imm12>]!

31	30	29	28	27	26	25	24	23	22	21	20	19	18	17	16	15	14	13	12	11	10	9	8	7	6	5	4	3	2	1	0
cond				0	1	0	P	U	0	W	1	Rn				Rt				imm12											

```

if Rn == '1111' then SEE LDR (literal);
if P == '0' && W == '1' then SEE LDRT;
if Rn == '1101' && P == '0' && U == '1' && W == '0' && imm12 == '00000000100' then SEE POP;
t = UInt(Rt); n = UInt(Rn); imm32 = ZeroExtend(imm12, 32);
index = (P == '1'); add = (U == '1'); wback = (P == '0') || (W == '1');
if wback && n == t then UNPREDICTABLE;

```

## Assembler syntax

LDR{<c>}{<q>} <Rt>, [<Rn> {, #+/-<imm>}]	Offset: index==TRUE, wback==FALSE
LDR{<c>}{<q>} <Rt>, [<Rn>, #+/-<imm>]!	Pre-indexed: index==TRUE, wback==TRUE
LDR{<c>}{<q>} <Rt>, [<Rn>], #+/-<imm>	Post-indexed: index==FALSE, wback==TRUE

where:

<c>, <q> See [Standard assembler syntax fields on page A8-287](#).

<Rt> The destination register. The SP or the PC can be used. If the PC is used, the instruction branches to the address (data) loaded to the PC. In ARMv5T and above, this branch is an interworking branch, see [Pseudocode details of operations on ARM core registers on page A2-47](#).

<Rn> The base register. The SP can be used. For PC use see [LDR \(literal\) on page A8-410](#).

+/- Is + or omitted if the immediate offset is to be added to the base register value (add == TRUE, encoded as U ==1), or – if it is to be subtracted (add == FALSE, encoded as U ==0). #0 and #-0 generate different instructions.

<imm> The immediate offset used for forming the address. For the offset addressing syntax, <imm> can be omitted, meaning an offset of 0. Any value in the range 0-4095 is permitted.

## Operation

```

if ConditionPassed() then
    EncodingSpecificOperations();
    offset_addr = if add then (R[n] + imm32) else (R[n] - imm32);
    address = if index then offset_addr else R[n];
    data = MemU[address,4];
    if wback then R[n] = offset_addr;
    if t == 15 then
        if address<1:0> == '00' then LoadWritePC(data); else UNPREDICTABLE;
    elsif UnalignedSupport() || address<1:0> == '00' then
        R[t] = data;
    else // Can only apply before ARMv7
        R[t] = ROR(data, 8*UInt(address<1:0>));

```

## Exceptions

Data Abort.

### A8.8.64 LDR (literal)

Load Register (literal) calculates an address from the PC value and an immediate offset, loads a word from memory, and writes it to a register. For information about memory accesses see [Memory accesses](#) on page A8-294.

**Encoding T1** ARMv4T, ARMv5T\*, ARMv6\*, ARMv7

LDR<c> <Rt>, <label>

15	14	13	12	11	10	9	8	7	6	5	4	3	2	1	0
0	1	0	0	1			Rt								imm8

t = UInt(Rt); imm32 = ZeroExtend(imm8:'00', 32); add = TRUE;

**Encoding T2** ARMv6T2, ARMv7

LDR<c>.W <Rt>, <label>

LDR<c>.W <Rt>, [PC, #-0]

Special case

15	14	13	12	11	10	9	8	7	6	5	4	3	2	1	0	15	14	13	12	11	10	9	8	7	6	5	4	3	2	1	0
1	1	1	1	1	0	0	0	U	1	0	1	1	1	1	1	Rt											imm12				

t = UInt(Rt); imm32 = ZeroExtend(imm12, 32); add = (U == '1');  
if t == 15 && InITBlock() && !LastInITBlock() then UNPREDICTABLE;

**Encoding A1** ARMv4\*, ARMv5T\*, ARMv6\*, ARMv7

LDR<c> <Rt>, <label>

LDR<c> <Rt>, [PC, #-0]

Special case

31	30	29	28	27	26	25	24	23	22	21	20	19	18	17	16	15	14	13	12	11	10	9	8	7	6	5	4	3	2	1	0
cond			0	1	0	(1)	U	0	(0)	1	1	1	1	1		Rt															imm12

t = UInt(Rt); imm32 = ZeroExtend(imm12, 32); add = (U == '1');

## Assembler syntax

LDR{<c>}{<q>} <Rt>, <label> Normal form  
LDR{<c>}{<q>} <Rt>, [PC, #+/-<imm>] Alternative form

where:

- <c>, <q> See [Standard assembler syntax fields on page A8-287](#).
- <Rt> The destination register. The SP can be used. The PC can be used, provided the instruction is either outside an IT block or the last instruction of an IT block. If the PC is used, the instruction branches to the address (data) loaded to the PC. In ARMv5T and above, this branch is an interworking branch, see [Pseudocode details of operations on ARM core registers on page A2-47](#).
- <label> The label of the literal data item that is to be loaded into <Rt>. The assembler calculates the required value of the offset from the Align(PC, 4) value of the instruction to this label. Permitted values of the offset are:
- Encoding T1** Multiples of four in the range 0 to 1020.  
**Encoding T2 or A1** Any value in the range -4095 to 4095.
- If the offset is zero or positive, imm32 is equal to the offset and add == TRUE, encoded as U == 1 in encoding T2.
- If the offset is negative, imm32 is equal to minus the offset and add == FALSE, encoded as U == 0. Negative offset is not available in encoding T1.

### Note

In examples in this manual, the syntax =<value> is used for the label of a memory word whose contents are constant and equal to <value>. The actual syntax for such a label is assembler-dependent.

The alternative syntax permits the addition or subtraction of the offset and the immediate offset to be specified separately, including permitting a subtraction of 0 that cannot be specified using the normal syntax. For more information, see [Use of labels in UAL instruction syntax on page A4-162](#).

## Operation

```
if ConditionPassed() then
    EncodingSpecificOperations();  NullCheckIfThumbEE(15);
    base = Align(PC,4);
    address = if add then (base + imm32) else (base - imm32);
    data = MemU[address,4];
    if t == 15 then
        if address<1:0> == '00' then LoadWritePC(data); else UNPREDICTABLE;
    elseif UnalignedSupport() || address<1:0> == '00' then
        R[t] = data;
    else // Can only apply before ARMv7
        if CurrentInstrSet() == InstrSet_ARM then
            R[t] = ROR(data, 8*UInt(address<1:0>));
        else
            R[t] = bits(32) UNKNOWN;
```

## Exceptions

Data Abort.

### A8.8.65 LDR (register, Thumb)

Load Register (register) calculates an address from a base register value and an offset register value, loads a word from memory, and writes it to a register. The offset register value can optionally be shifted. For information about memory accesses, see [Memory accesses](#) on page A8-294.

The Thumb form of LDR (register) does not support register writeback.

#### Encoding T1 ARMv4T, ARMv5T\*, ARMv6\*, ARMv7

LDR<c> <Rt>, [<Rn>, <Rm>]

15	14	13	12	11	10	9	8	7	6	5	4	3	2	1	0
0	1	0	1	1	0	0	Rm			Rn			Rt		

if CurrentInstrSet() == InstrSet\_ThumbEE then SEE "Modified operation in ThumbEE";  
t = UInt(Rt); n = UInt(Rn); m = UInt(Rm);  
(shift\_t, shift\_n) = (SRTYPE\_LSL, 0);

#### Encoding T2 ARMv6T2, ARMv7

LDR<c>.W <Rt>, [<Rn>, <Rm>{, LSL #<imm2>}]

15	14	13	12	11	10	9	8	7	6	5	4	3	2	1	0	15	14	13	12	11	10	9	8	7	6	5	4	3	2	1	0
1	1	1	1	1	0	0	0	0	1	0	1	Rn			Rt			0	0	0	0	0	0	imm2	Rm						

if Rn == '1111' then SEE LDR (literal);  
t = UInt(Rt); n = UInt(Rn); m = UInt(Rm);  
(shift\_t, shift\_n) = (SRTYPE\_LSL, UInt(imm2));  
if m IN {13,15} then UNPREDICTABLE;  
if t == 15 && InITBlock() && !LastInITBlock() then UNPREDICTABLE;

#### Modified operation in ThumbEE

See [LDR \(register\)](#) on page A9-1118



## Assembler syntax

LDR{<c>}{<q>} <Rt>, [<Rn>, {+}<Rm>{, <shift>}]    Offset addressing

where:

- <c>, <q>    See *Standard assembler syntax fields on page A8-287*.
- <Rt>    The destination register. The SP can be used. The PC can be used, provided the instruction is either outside an IT block or the last instruction of an IT block. If the PC is used, the instruction branches to the address (data) loaded to the PC. In ARMv5T and above, this branch is an interworking branch, see *Pseudocode details of operations on ARM core registers on page A2-47*.
- <Rn>    The base register. The SP can be used. In the Thumb instruction set, the PC cannot be used with this form of the LDR instruction.
- +    In Thumb instructions, the optionally shifted value of <Rm> is added to the base register value. Thumb instructions cannot subtract <Rm> from the base register value.
- <Rm>    The offset that is optionally shifted and applied to the value of <Rn> to form the address.
- <shift>    The shift to apply to the value read from <Rm>. If present, encoding T1 is not permitted. If absent, no shift is applied and all encodings are permitted. For encoding T2, <shift> can only be omitted, encoded as imm2 = 0b00, or LSL #<imm> with <imm> = 1, 2, or 3, and <imm> encoded in imm2.

## Operation

```

if ConditionPassed() then
    EncodingSpecificOperations(); NullCheckIfThumbEE(n);
    offset = Shift(R[m], shift_t, shift_n, APSR.C);
    offset_addr = (R[n] + offset);
    address = offset_addr;
    data = MemU[address,4];
    if t == 15 then
        if address<1:0> == '00' then
            LoadWritePC(data);
        else
            UNPREDICTABLE;
    elseif UnalignedSupport() || address<1:0> == '00' then
        R[t] = data;
    else // Can only apply before ARMv7
        R[t] = bits(32) UNKNOWN;

```

## Exceptions

Data Abort.

### A8.8.66 LDR (register, ARM)

Load Register (register) calculates an address from a base register value and an offset register value, loads a word from memory, and writes it to a register. The offset register value can optionally be shifted. For information about memory accesses, see [Memory accesses](#) on page A8-294.

#### Encoding A1 ARMv4\*, ARMv5T\*, ARMv6\*, ARMv7

LDR<c> <Rt>, [<Rn>, +/-<Rm>{, <shift>}]{!}

LDR<c> <Rt>, [<Rn>], +/-<Rm>{, <shift>}

31	30	29	28	27	26	25	24	23	22	21	20	19	18	17	16	15	14	13	12	11	10	9	8	7	6	5	4	3	2	1	0
cond		0	1	1	P	U	0	W	1	Rn				Rt				imm5			type	0	Rm								

```

if P == '0' && W == '1' then SEE LDRT;
t = UInt(Rt); n = UInt(Rn); m = UInt(Rm);
index = (P == '1'); add = (U == '1'); wback = (P == '0') || (W == '1');
(shift_t, shift_n) = DecodeImmShift(type, imm5);
if m == 15 then UNPREDICTABLE;
if wback && (n == 15 || n == t) then UNPREDICTABLE;
if ArchVersion() < 6 && wback && m == n then UNPREDICTABLE;

```

## Assembler syntax

LDR{<c>}{<q>} <Rt>, [<Rn>, {+/-}<Rm>{, <shift>}] Offset: index==TRUE, wback==FALSE  
LDR{<c>}{<q>} <Rt>, [<Rn>, {+/-}<Rm>{, <shift>}]! Pre-indexed: index==TRUE, wback==TRUE  
LDR{<c>}{<q>} <Rt>, [<Rn>], {+/-}<Rm>{, <shift>} Post-indexed: index==FALSE, wback==TRUE

where:

<c>, <q> See [Standard assembler syntax fields on page A8-287](#).

<Rt> The destination register. The SP can be used. The PC can be used. If the PC is used, the instruction branches to the address (data) loaded to the PC. In ARMv5T and above, this branch is an interworking branch, see [Pseudocode details of operations on ARM core registers on page A2-47](#).

<Rn> The base register. The SP can be used. The PC can be used for offset addressing only.

+/- If + or omitted, the optionally shifted value of <Rm> is added to the base register value (add == TRUE encoded as U == 1).  
If -, the optionally shifted value of <Rm> is subtracted from the base register value (add == FALSE encoded as U == 0).

<Rm> The offset that is optionally shifted and applied to the value of <Rn> to form the address.

<shift> The shift to apply to the value read from <Rm>. If absent, no shift is applied. Otherwise, see [Shifts applied to a register on page A8-291](#).

## Operation

```

if ConditionPassed() then
    EncodingSpecificOperations();
    offset = Shift(R[m], shift_t, shift_n, APSR.C);
    offset_addr = if add then (R[n] + offset) else (R[n] - offset);
    address = if index then offset_addr else R[n];
    data = MemU[address,4];
    if wback then R[n] = offset_addr;
    if t == 15 then
        if address<1:0> == '00' then
            LoadWritePC(data);
        else
            UNPREDICTABLE;
    elseif UnalignedSupport() || address<1:0> == '00' then
        R[t] = data;
    else // Can only apply before ARMv7
        R[t] = ROR(data, 8*UInt(address<1:0>));

```

## Exceptions

Data Abort.

### A8.8.67 LDRB (immediate, Thumb)

Load Register Byte (immediate) calculates an address from a base register value and an immediate offset, loads a byte from memory, zero-extends it to form a 32-bit word, and writes it to a register. It can use offset, post-indexed, or pre-indexed addressing. For information about memory accesses see [Memory accesses on page A8-294](#).

**Encoding T1** ARMv4T, ARMv5T\*, ARMv6\*, ARMv7  
LDRB<c> <Rt>, [<Rn>{, #<imm5>}]

15	14	13	12	11	10	9	8	7	6	5	4	3	2	1	0
0	1	1	1	1	imm5					Rn			Rt		

t = UInt(Rt); n = UInt(Rn); imm32 = ZeroExtend(imm5, 32);  
index = TRUE; add = TRUE; wback = FALSE;

**Encoding T2** ARMv6T2, ARMv7  
LDRB<c>.W <Rt>, [<Rn>{, #<imm12>}]

15	14	13	12	11	10	9	8	7	6	5	4	3	2	1	0	15	14	13	12	11	10	9	8	7	6	5	4	3	2	1	0
1	1	1	1	1	0	0	0	1	0	0	1	Rn			Rt			imm12													

if Rt == '1111' then SEE PLD;  
if Rn == '1111' then SEE LDRB (literal);  
t = UInt(Rt); n = UInt(Rn); imm32 = ZeroExtend(imm12, 32);  
index = TRUE; add = TRUE; wback = FALSE;  
if t == 13 then UNPREDICTABLE;

**Encoding T3** ARMv6T2, ARMv7  
LDRB<c> <Rt>, [<Rn>, #-<imm8>]  
LDRB<c> <Rt>, [<Rn>], #+/-<imm8>  
LDRB<c> <Rt>, [<Rn>, #+/-<imm8>!]

15	14	13	12	11	10	9	8	7	6	5	4	3	2	1	0	15	14	13	12	11	10	9	8	7	6	5	4	3	2	1	0
1	1	1	1	1	0	0	0	0	0	0	1	Rn			Rt			1	P	U	W	imm8									

if Rt == '1111' && P == '1' && U == '0' && W == '0' then SEE PLD, PLDW (immediate);  
if Rn == '1111' then SEE LDRB (literal);  
if P == '1' && U == '1' && W == '0' then SEE LDRBT;  
if P == '0' && W == '0' then UNDEFINED;  
t = UInt(Rt); n = UInt(Rn); imm32 = ZeroExtend(imm8, 32);  
index = (P == '1'); add = (U == '1'); wback = (W == '1');  
if t == 13 || (t == 15 && W == '1') || (wback && n == t) then UNPREDICTABLE;

## Assembler syntax

LDRB{<c>}{<q>} <Rt>, [<Rn> {, #+/-<imm>}]	Offset: index==TRUE, wback==FALSE
LDRB{<c>}{<q>} <Rt>, [<Rn>, #+/-<imm>]!	Pre-indexed: index==TRUE, wback==TRUE
LDRB{<c>}{<q>} <Rt>, [<Rn>], #+/-<imm>	Post-indexed: index==FALSE, wback==TRUE

where:

<c>, <q>	See <a href="#">Standard assembler syntax fields on page A8-287</a> .						
<Rt>	The destination register.						
<Rn>	The base register. The SP can be used. For PC use see <a href="#">LDRB (literal) on page A8-420</a> .						
+/-	Is + or omitted if the immediate offset is to be added to the base register value (add == TRUE, encoded as U == 1), or – if it is to be subtracted (add == FALSE, encoded as U == 0). #0 and #-0 generate different instructions.						
<imm>	The immediate offset used for forming the address. For the offset addressing syntax, <imm> can be omitted, meaning an offset of 0. Values are: <table> <tr> <td><b>Encoding T1</b></td> <td>any value in the range 0-31</td> </tr> <tr> <td><b>Encoding T2</b></td> <td>any value in the range 0-4095</td> </tr> <tr> <td><b>Encoding T3</b></td> <td>any value in the range 0-255.</td> </tr> </table>	<b>Encoding T1</b>	any value in the range 0-31	<b>Encoding T2</b>	any value in the range 0-4095	<b>Encoding T3</b>	any value in the range 0-255.
<b>Encoding T1</b>	any value in the range 0-31						
<b>Encoding T2</b>	any value in the range 0-4095						
<b>Encoding T3</b>	any value in the range 0-255.						

The pre-UAL syntax LDR<c>B is equivalent to LDRB<c>.

## Operation

```

if ConditionPassed() then
    EncodingSpecificOperations(); NullCheckIfThumbEE(n);
    offset_addr = if add then (R[n] + imm32) else (R[n] - imm32);
    address = if index then offset_addr else R[n];
    R[t] = ZeroExtend(MemU[address,1], 32);
    if wback then R[n] = offset_addr;

```

## Exceptions

Data Abort.

### A8.8.68 LDRB (immediate, ARM)

Load Register Byte (immediate) calculates an address from a base register value and an immediate offset, loads a byte from memory, zero-extends it to form a 32-bit word, and writes it to a register. It can use offset, post-indexed, or pre-indexed addressing. For information about memory accesses see [Memory accesses on page A8-294](#).

**Encoding A1** ARMv4\*, ARMv5T\*, ARMv6\*, ARMv7

LDRB<c> <Rt>, [<Rn>{, #+/-<imm12>}]

LDRB<c> <Rt>, [<Rn>], #+/-<imm12>

LDRB<c> <Rt>, [<Rn>, #+/-<imm12>]!

31	30	29	28	27	26	25	24	23	22	21	20	19	18	17	16	15	14	13	12	11	10	9	8	7	6	5	4	3	2	1	0
cond				0	1	0	P	U	1	W	1	Rn				Rt				imm12											

```

if Rn == '1111' then SEE LDRB (literal);
if P == '0' && W == '1' then SEE LDRBT;
t = UInt(Rt); n = UInt(Rn); imm32 = ZeroExtend(imm12, 32);
index = (P == '1'); add = (U == '1'); wback = (P == '0') || (W == '1');
if t == 15 || (wback && n == t) then UNPREDICTABLE;

```

## Assembler syntax

LDRB{<c>}{<q>} <Rt>, [<Rn> {, #+/-<imm>}]	Offset: index==TRUE, wback==FALSE
LDRB{<c>}{<q>} <Rt>, [<Rn>, #+/-<imm>]!	Pre-indexed: index==TRUE, wback==TRUE
LDRB{<c>}{<q>} <Rt>, [<Rn>], #+/-<imm>	Post-indexed: index==FALSE, wback==TRUE

where:

<c>, <q>	See <a href="#">Standard assembler syntax fields on page A8-287</a> .
<Rt>	The destination register.
<Rn>	The base register. The SP can be used. For PC use see <a href="#">LDRB (literal) on page A8-420</a> .
+/-	Is + or omitted if the immediate offset is to be added to the base register value (add == TRUE, encoded as U == 1), or – if it is to be subtracted (add == FALSE, encoded as U == 0). #0 and #-0 generate different instructions.
<imm>	The immediate offset used for forming the address. For the offset addressing syntax, <imm> can be omitted, meaning an offset of 0. Any value in the range 0-4095 is permitted.

The pre-UAL syntax LDR<c>B is equivalent to LDRB<c>.

## Operation

```

if ConditionPassed() then
    EncodingSpecificOperations();
    offset_addr = if add then (R[n] + imm32) else (R[n] - imm32);
    address = if index then offset_addr else R[n];
    R[t] = ZeroExtend(MemU[address,1], 32);
    if wback then R[n] = offset_addr;

```

## Exceptions

Data Abort.

### A8.8.69 LDRB (literal)

Load Register Byte (literal) calculates an address from the PC value and an immediate offset, loads a byte from memory, zero-extends it to form a 32-bit word, and writes it to a register. For information about memory accesses see [Memory accesses on page A8-294](#).

#### Encoding T1 ARMv6T2, ARMv7

LDRB<c> <Rt>, <label>

LDRB<c> <Rt>, [PC, #-0] Special case

15	14	13	12	11	10	9	8	7	6	5	4	3	2	1	0	15	14	13	12	11	10	9	8	7	6	5	4	3	2	1	0
1	1	1	1	1	0	0	0	U	0	0	1	1	1	1	1	Rt	imm12														

if Rt == '1111' then SEE PLD;  
t = UInt(Rt); imm32 = ZeroExtend(imm12, 32); add = (U == '1');  
if t == 13 then UNPREDICTABLE;

#### Encoding A1 ARMv4\*, ARMv5T\*, ARMv6\*, ARMv7

LDRB<c> <Rt>, <label>

LDRB<c> <Rt>, [PC, #-0] Special case

31	30	29	28	27	26	25	24	23	22	21	20	19	18	17	16	15	14	13	12	11	10	9	8	7	6	5	4	3	2	1	0
cond		0	1	0	(1)	U	1	(0)	1	1	1	1	1	1	Rt	imm12															

t = UInt(Rt); imm32 = ZeroExtend(imm12, 32); add = (U == '1');  
if t == 15 then UNPREDICTABLE;



## Assembler syntax

LDRB{<c>}{<q>} <Rt>, <label> Normal form  
LDRB{<c>}{<q>} <Rt>, [PC, #+/-<imm>] Alternative form

where:

<c>, <q> See [Standard assembler syntax fields on page A8-287](#).

<Rt> The destination register.

<label> The label of the literal data item that is to be loaded into <Rt>. The assembler calculates the required value of the offset from the `Align(PC, 4)` value of the instruction to this label. Permitted values of the offset are -4095 to 4095.

If the offset is zero or positive, `imm32` is equal to the offset and `add == TRUE`, encoded as `U == 1`.

If the offset is negative, `imm32` is equal to minus the offset and `add == FALSE`, encoded as `U == 0`.

The alternative syntax permits the addition or subtraction of the offset and the immediate offset to be specified separately, including permitting a subtraction of 0 that cannot be specified using the normal syntax. For more information, see [Use of labels in UAL instruction syntax on page A4-162](#).

The pre-UAL syntax `LDR<c>B` is equivalent to `LDRB<c>`.

## Operation

```
if ConditionPassed() then
    EncodingSpecificOperations(); NullCheckIfThumbEE(15);
    base = Align(PC,4);
    address = if add then (base + imm32) else (base - imm32);
    R[t] = ZeroExtend(MemU[address,1], 32);
```

## Exceptions

Data Abort.

## A8.8.70 LDRB (register)

Load Register Byte (register) calculates an address from a base register value and an offset register value, loads a byte from memory, zero-extends it to form a 32-bit word, and writes it to a register. The offset register value can optionally be shifted. For information about memory accesses see [Memory accesses on page A8-294](#).

### Encoding T1 ARMv4T, ARMv5T\*, ARMv6\*, ARMv7

LDRB<c> <Rt>, [<Rn>, <Rm>]

15	14	13	12	11	10	9	8	7	6	5	4	3	2	1	0
0	1	0	1	1	1	0	Rm			Rn			Rt		

t = UInt(Rt); n = UInt(Rn); m = UInt(Rm);  
index = TRUE; add = TRUE; wback = FALSE;  
(shift\_t, shift\_n) = (SRTYPE\_LSL, 0);

### Encoding T2 ARMv6T2, ARMv7

LDRB<c>.W <Rt>, [<Rn>, <Rm>{, LSL #<imm2>}]

15	14	13	12	11	10	9	8	7	6	5	4	3	2	1	0	15	14	13	12	11	10	9	8	7	6	5	4	3	2	1	0
1	1	1	1	1	0	0	0	0	0	0	1	Rn			Rt			0	0	0	0	0	0	imm2	Rm						

if Rt == '1111' then SEE PLD;  
if Rn == '1111' then SEE LDRB (literal);  
t = UInt(Rt); n = UInt(Rn); m = UInt(Rm);  
index = TRUE; add = TRUE; wback = FALSE;  
(shift\_t, shift\_n) = (SRTYPE\_LSL, UInt(imm2));  
if t == 13 || m IN {13,15} then UNPREDICTABLE;

### Encoding A1 ARMv4\*, ARMv5T\*, ARMv6\*, ARMv7

LDRB<c> <Rt>, [<Rn>, +/-<Rm>{, <shift>}{!}]

LDRB<c> <Rt>, [<Rn>, +/-<Rm>{, <shift>}]

31	30	29	28	27	26	25	24	23	22	21	20	19	18	17	16	15	14	13	12	11	10	9	8	7	6	5	4	3	2	1	0
cond		0	1	1	P	U	1	W	1	Rn			Rt			imm5			type	0	Rm										

if P == '0' && W == '1' then SEE LDRBT;  
t = UInt(Rt); n = UInt(Rn); m = UInt(Rm);  
index = (P == '1'); add = (U == '1'); wback = (P == '0') || (W == '1');  
(shift\_t, shift\_n) = DecodeImmShift(type, imm5);  
if t == 15 || m == 15 then UNPREDICTABLE;  
if wback && (n == 15 || n == t) then UNPREDICTABLE;  
if ArchVersion() < 6 && wback && m == n then UNPREDICTABLE;

## Assembler syntax

LDRB{<c>}{<q>} <Rt>, [<Rn>, +/-<Rm>{, <shift>}] Offset: index==TRUE, wback==FALSE  
LDRB{<c>}{<q>} <Rt>, [<Rn>, +/-<Rm>{, <shift>}]! Pre-indexed: index==TRUE, wback==TRUE  
LDRB{<c>}{<q>} <Rt>, [<Rn>], +/-<Rm>{, <shift>} Post-indexed: index==FALSE, wback==TRUE

where:

<c>, <q> See [Standard assembler syntax fields on page A8-287](#).

<Rt> The destination register.

<Rn> The base register. The SP can be used. In the ARM instruction set the PC can be used, for the offset addressing form of the instruction only. In the Thumb instruction set, the PC cannot be used with any of these forms of the LDRB instruction.

+/- Is + or omitted if the optionally shifted value of <Rm> is to be added to the base register value (add == TRUE, encoded as U == 1 in encoding A1), or – if it is to be subtracted (permitted in ARM instructions only, add == FALSE, encoded as U == 0).

<Rm> Contains the offset that is optionally shifted and applied to the value of <Rn> to form the address.

<shift> The shift to apply to the value read from <Rm>. If present, encoding T1 is not permitted. If absent, no shift is applied and all encodings are permitted. For encoding T2, <shift> can only be omitted, encoded as imm2 = 0b00, or LSL #<imm> with <imm> = 1, 2, or 3, and <imm> encoded in imm2. For encoding A1, see [Shifts applied to a register on page A8-291](#).

The pre-UAL syntax LDR<c>B is equivalent to LDRB<c>.

## Operation

```
if ConditionPassed() then
    EncodingSpecificOperations(); NullCheckIfThumbEE(n);
    offset = Shift(R[m], shift_t, shift_n, APSR.C);
    offset_addr = if add then (R[n] + offset) else (R[n] - offset);
    address = if index then offset_addr else R[n];
    R[t] = ZeroExtend(MemU[address,1],32);
    if wback then R[n] = offset_addr;
```

## Exceptions

Data Abort.

## A8.8.71 LDRBT

Load Register Byte Unprivileged loads a byte from memory, zero-extends it to form a 32-bit word, and writes it to a register. For information about memory accesses see [Memory accesses on page A8-294](#).

The memory access is restricted as if the processor were running in User mode. This makes no difference if the processor is actually running in User mode.

LDRBT is UNPREDICTABLE in Hyp mode.

The Thumb instruction uses an offset addressing mode, that calculates the address used for the memory access from a base register value and an immediate offset, and leaves the base register unchanged.

The ARM instruction uses a post-indexed addressing mode, that uses a base register value as the address for the memory access, and calculates a new address from a base register value and an offset and writes it back to the base register. The offset can be an immediate value or an optionally-shifted register value.

### Encoding T1 ARMv6T2, ARMv7

LDRBT<c> <Rt>, [<Rn>, #<imm8>]

15	14	13	12	11	10	9	8	7	6	5	4	3	2	1	0	15	14	13	12	11	10	9	8	7	6	5	4	3	2	1	0
1	1	1	1	1	0	0	0	0	0	0	1	Rn				Rt		1	1	1	0	imm8									

```
if Rn == '1111' then SEE LDRB (literal);
t = UInt(Rt); n = UInt(Rn); postindex = FALSE; add = TRUE;
register_form = FALSE; imm32 = ZeroExtend(imm8, 32);
if t IN {13,15} then UNPREDICTABLE;
```

### Encoding A1 ARMv4\*, ARMv5T\*, ARMv6\*, ARMv7

LDRBT<c> <Rt>, [<Rn>], #+/-<imm12>

31	30	29	28	27	26	25	24	23	22	21	20	19	18	17	16	15	14	13	12	11	10	9	8	7	6	5	4	3	2	1	0
cond		0	1	0	0	U	1	1	1	Rn			Rt		imm12																

```
t = UInt(Rt); n = UInt(Rn); postindex = TRUE; add = (U == '1');
register_form = FALSE; imm32 = ZeroExtend(imm12, 32);
if t == 15 || n == 15 || n == t then UNPREDICTABLE;
```

### Encoding A2 ARMv4\*, ARMv5T\*, ARMv6\*, ARMv7

LDRBT<c> <Rt>, [<Rn>],+/-<Rm>{, <shift>}

31	30	29	28	27	26	25	24	23	22	21	20	19	18	17	16	15	14	13	12	11	10	9	8	7	6	5	4	3	2	1	0
cond		0	1	1	0	U	1	1	1	Rn			Rt		imm5			type	0	Rm											

```
t = UInt(Rt); n = UInt(Rn); m = UInt(Rm); postindex = TRUE; add = (U == '1');
register_form = TRUE; (shift_t, shift_n) = DecodeImmShift(type, imm5);
if t == 15 || n == 15 || n == t || m == 15 then UNPREDICTABLE;
if ArchVersion() < 6 && m == n then UNPREDICTABLE;
```

## Assembler syntax

LDRBT{<c>}{<q>} <Rt>, [<Rn> {, #<imm>}]	Offset: Thumb only
LDRBT{<c>}{<q>} <Rt>, [<Rn>] {, #+/-<imm>}	Post-indexed: ARM only
LDRBT{<c>}{<q>} <Rt>, [<Rn>], +/-<Rm> {, <shift>}	Post-indexed: ARM only

where:

<c>, <q>	See <a href="#">Standard assembler syntax fields on page A8-287</a> .
<Rt>	The destination register.
<Rn>	The base register. The SP can be used.
+/-	Is + or omitted if <imm> or the optionally shifted value of <Rm> is to be added to the base register value (add == TRUE, encoded as U == 1 in encodings A1 and A2), or – if it is to be subtracted (permitted in ARM instructions only, add == FALSE, encoded as U == 0).
<imm>	The immediate offset applied to the value of <Rn>. Values are 0-255 for encoding T1, and 0-4095 for encoding A1. <imm> can be omitted, meaning an offset of 0.
<Rm>	Contains the offset that is optionally shifted and applied to the value of <Rn> to form the address.
<shift>	The shift to apply to the value read from <Rm>. If omitted, no shift is applied. <a href="#">Shifts applied to a register on page A8-291</a> describes the shifts and how they are encoded.

The pre-UAL syntax LDR<c>BT is equivalent to LDRBT<c>.

## Operation

```

if ConditionPassed() then
    if CurrentModeIsHyp() then UNPREDICTABLE;           // Hyp mode
    EncodingSpecificOperations(); NullCheckIfThumbEE(n);
    offset = if register_form then Shift(R[m], shift_t, shift_n, APSR.C) else imm32;
    offset_addr = if add then (R[n] + offset) else (R[n] - offset);
    address = if postindex then R[n] else offset_addr;
    R[t] = ZeroExtend(MemU_unpriv[address,1],32);
    if postindex then R[n] = offset_addr;

```

## Exceptions

Data Abort.

### A8.8.72 LDRD (immediate)

Load Register Dual (immediate) calculates an address from a base register value and an immediate offset, loads two words from memory, and writes them to two registers. It can use offset, post-indexed, or pre-indexed addressing. For information about memory accesses see [Memory accesses on page A8-294](#).

#### Encoding T1 ARMv6T2, ARMv7

LDRD<c> <Rt>, <Rt2>, [<Rn>{, #+/-<imm>}]

LDRD<c> <Rt>, <Rt2>, [<Rn>], #+/-<imm>

LDRD<c> <Rt>, <Rt2>, [<Rn>, #+/-<imm>]!

15	14	13	12	11	10	9	8	7	6	5	4	3	2	1	0	15	14	13	12	11	10	9	8	7	6	5	4	3	2	1	0
1	1	1	0	1	0	0	P	U	1	W	1	Rn				Rt				Rt2				imm8							

```

if P == '0' && W == '0' then SEE "ReLated encodings";
if Rn == '1111' then SEE LDRD (literal);
t = UInt(Rt); t2 = UInt(Rt2); n = UInt(Rn); imm32 = ZeroExtend(imm8:'00', 32);
index = (P == '1'); add = (U == '1'); wback = (W == '1');
if wback && (n == t || n == t2) then UNPREDICTABLE;
if t IN {13,15} || t2 IN {13,15} || t == t2 then UNPREDICTABLE;

```

#### Encoding A1 ARMv5TE\*, ARMv6\*, ARMv7

LDRD<c> <Rt>, <Rt2>, [<Rn>{, #+/-<imm8>}]

LDRD<c> <Rt>, <Rt2>, [<Rn>], #+/-<imm8>

LDRD<c> <Rt>, <Rt2>, [<Rn>, #+/-<imm8>]!

31	30	29	28	27	26	25	24	23	22	21	20	19	18	17	16	15	14	13	12	11	10	9	8	7	6	5	4	3	2	1	0
cond		0	0	0	P	U	1	W	0	Rn				Rt				imm4H				1	1	0	1	imm4L					

```

if Rn == '1111' then SEE LDRD (literal);
if Rt<0> == '1' then UNPREDICTABLE;
t = UInt(Rt); t2 = t+1; n = UInt(Rn); imm32 = ZeroExtend(imm4H:imm4L, 32);
index = (P == '1'); add = (U == '1'); wback = (P == '0') || (W == '1');
if P == '0' && W == '1' then UNPREDICTABLE;
if wback && (n == t || n == t2) then UNPREDICTABLE;
if t2 == 15 then UNPREDICTABLE;

```

**Related encodings** See [Load/store dual, load/store exclusive, table branch on page A6-238](#).

## Assembler syntax

LDRD{<c>}{<q>} <Rt>, <Rt2>, [<Rn> {, #+/-<imm>}] Offset: index==TRUE, wback==FALSE  
LDRD{<c>}{<q>} <Rt>, <Rt2>, [<Rn>, #+/-<imm>! Pre-indexed: index==TRUE, wback==TRUE  
LDRD{<c>}{<q>} <Rt>, <Rt2>, [<Rn>], #+/-<imm> Post-indexed: index==FALSE, wback==TRUE

where:

<c>, <q> See [Standard assembler syntax fields on page A8-287](#).

<Rt> The first destination register. For an ARM instruction, <Rt> must be even-numbered and not R14.

<Rt2> The second destination register. For an ARM instruction, <Rt2> must be <R(t+1)>.

<Rn> The base register. The SP can be used. For PC use see [LDRD \(literal\) on page A8-428](#).

+/- Is + or omitted if the immediate offset is to be added to the base register value (add == TRUE, encoded as U == 1), or – if it is to be subtracted (add == FALSE, encoded as U == 0). #0 and #-0 generate different instructions.

<imm> The immediate offset used for forming the address. For the offset addressing syntax, <imm> can be omitted, meaning an offset of 0. Values are:

<b>Encoding T1</b>	Multiples of 4 in the range 0-1020.
<b>Encoding A1</b>	Any value in the range 0-255.

The pre-UAL syntax LDR<c>D is equivalent to LDRD<c>.

## Operation

```

if ConditionPassed() then
    EncodingSpecificOperations(); NullCheckIfThumbEE(n);
    offset_addr = if add then (R[n] + imm32) else (R[n] - imm32);
    address = if index then offset_addr else R[n];
    if HaveLPAE() && address<2:0> == '000' then
        data = MemA[address,8];
        if BigEndian() then
            R[t] = data<63:32>;
            R[t2] = data<31:0>;
        else
            R[t] = data<31:0>;
            R[t2] = data<63:32>;
    else
        R[t] = MemA[address,4];
        R[t2] = MemA[address+4,4];
    if wback then R[n] = offset_addr;

```

## Exceptions

Data Abort.

### A8.8.73 LDRD (literal)

Load Register Dual (literal) calculates an address from the PC value and an immediate offset, loads two words from memory, and writes them to two registers. For information about memory accesses see [Memory accesses on page A8-294](#).

#### Encoding T1 ARMv6T2, ARMv7

LDRD<c> <Rt>, <Rt2>, <label>

LDRD<c> <Rt>, <Rt2>, [PC, #-0] Special case

15	14	13	12	11	10	9	8	7	6	5	4	3	2	1	0	15	14	13	12	11	10	9	8	7	6	5	4	3	2	1	0
1	1	1	0	1	0	0	P	U	1	W	1	1	1	1	1	Rt	Rt2	imm8													

```

if P == '0' && W == '0' then SEE "Related encodings";
t = UInt(Rt); t2 = UInt(Rt2);
imm32 = ZeroExtend(imm8:'00', 32); add = (U == '1');
if t IN {13,15} || t2 IN {13,15} || t == t2 then UNPREDICTABLE;
if W == '1' then UNPREDICTABLE;

```

#### Encoding A1 ARMv5TE\*, ARMv6\*, ARMv7

LDRD<c> <Rt>, <Rt2>, <label>

LDRD<c> <Rt>, <Rt2>, [PC, #-0] Special case

31	30	29	28	27	26	25	24	23	22	21	20	19	18	17	16	15	14	13	12	11	10	9	8	7	6	5	4	3	2	1	0
cond			0	0	0	(1)	U	1	(0)	0	1	1	1	1	Rt	imm4H	1	1	0	1	imm4L										

```

if Rt<0> == '1' then UNPREDICTABLE;
t = UInt(Rt); t2 = t+1; imm32 = ZeroExtend(imm4H:imm4L, 32); add = (U == '1');
if t2 == 15 then UNPREDICTABLE;

```

**Related encodings** See [Load/store dual, load/store exclusive, table branch on page A6-238](#).



## Assembler syntax

LDRD{<c>}{<q>} <Rt>, <Rt2>, <label> Normal form  
LDRD{<c>}{<q>} <Rt>, <Rt2>, [PC, #+/-<imm>] Alternative form

where:

- <c>, <q> See [Standard assembler syntax fields on page A8-287](#).
- <Rt> The first destination register. For an ARM instruction, <Rt> must be even-numbered and not R14.
- <Rt2> The second destination register. For an ARM instruction, <Rt2> must be <R(t+1)>.
- <label> The label of the literal data item that is to be loaded into <Rt>. The assembler calculates the required value of the offset from the `Align(PC, 4)` value of the instruction to this label. Permitted values of the offset are:
  - Encoding T1** Multiples of 4 in the range -1020 to 1020.
  - Encoding A1** Any value in the range -255 to 255.

If the offset is zero or positive, `imm32` is equal to the offset and `add == TRUE`, encoded as `U == 1`.  
If the offset is negative, `imm32` is equal to minus the offset and `add == FALSE`, encoded as `U == 0`.

The alternative syntax permits the addition or subtraction of the offset and the immediate offset to be specified separately, including permitting a subtraction of 0 that cannot be specified using the normal syntax. For more information, see [Use of labels in UAL instruction syntax on page A4-162](#).

The pre-UAL syntax `LDR<c>D` is equivalent to `LDRD<c>`.

## Operation

```

if ConditionPassed() then
    EncodingSpecificOperations(); NullCheckIfThumbEE(15);
    address = if add then (Align(PC,4) + imm32) else (Align(PC,4) - imm32);
    if HaveLPAE() && address<2:0> == '000' then
        data = MemA[Address,8];
        if BigEndian() then
            R[t] = data<63:32>;
            R[t2] = data<31:0>;
        else
            R[t] = data<31:0>;
            R[t2] = data<63:32>;
    else
        R[t] = MemA[address,4];
        R[t2] = MemA[address+4,4];

```

## Exceptions

Data Abort.

### A8.8.74 LDRD (register)

Load Register Dual (register) calculates an address from a base register value and a register offset, loads two words from memory, and writes them to two registers. It can use offset, post-indexed, or pre-indexed addressing. For information about memory accesses see [Memory accesses on page A8-294](#).

#### Encoding A1 ARMv5TE\*, ARMv6\*, ARMv7

LDRD<c> <Rt>, <Rt2>, [<Rn>, +/-<Rm>]{!}

LDRD<c> <Rt>, <Rt2>, [<Rn>], +/-<Rm>

31	30	29	28	27	26	25	24	23	22	21	20	19	18	17	16	15	14	13	12	11	10	9	8	7	6	5	4	3	2	1	0
cond			0	0	0	P	U	0	W	0	Rn					Rt			(0)	(0)	(0)	(0)	1	1	0	1	Rm				

```

if Rt<0> == '1' then UNPREDICTABLE;
t = UInt(Rt); t2 = t+1; n = UInt(Rn); m = UInt(Rm);
index = (P == '1'); add = (U == '1'); wback = (P == '0') || (W == '1');
if P == '0' && W == '1' then UNPREDICTABLE;
if t2 == 15 || m == 15 || m == t || m == t2 then UNPREDICTABLE;
if wback && (n == 15 || n == t || n == t2) then UNPREDICTABLE;
if ArchVersion() < 6 && wback && m == n then UNPREDICTABLE;

```

## Assembler syntax

LDRD{<c>}{<q>} <Rt>, <Rt2>, [<Rn>, +/-<Rm>]	Offset: index==TRUE, wback==FALSE
LDRD{<c>}{<q>} <Rt>, <Rt2>, [<Rn>, +/-<Rm>]!	Pre-indexed: index==TRUE, wback==TRUE
LDRD{<c>}{<q>} <Rt>, <Rt2>, [<Rn>], +/-<Rm>	Post-indexed: index==FALSE, wback==TRUE

where:

<c>, <q> See [Standard assembler syntax fields on page A8-287](#).

<Rt> The first destination register. This register must be even-numbered and not R14.

<Rt2> The second destination register. This register must be <R(t+1)>.

<Rn> The base register. The SP can be used. The PC can be used, for offset addressing only.

+/- Is + or omitted if the value of <Rm> is to be added to the base register value (add == TRUE, encoded as U == 1), or – if it is to be subtracted (add == FALSE, encoded as U == 0).

<Rm> Contains the offset that is applied to the value of <Rn> to form the address.

The pre-UAL syntax LDR<c>D is equivalent to LDRD<c>.

## Operation

```

if ConditionPassed() then
    EncodingSpecificOperations();
    offset_addr = if add then (R[n] + R[m]) else (R[n] - R[m]);
    address = if index then offset_addr else R[n];
    if HaveLPAE() && address<2:0> == '000' then
        data = MemA[address,8];
        if BigEndian() then
            R[t] = data<63:32>;
            R[t2] = data<31:0>;
        else
            R[t] = data<31:0>;
            R[t2] = data<63:32>;
    else
        R[t] = MemA[address,4];
        R[t2] = MemA[address+4,4];

    if wback then R[n] = offset_addr;

```

## Exceptions

Data Abort.

### A8.8.75 LDREX

Load Register Exclusive calculates an address from a base register value and an immediate offset, loads a word from memory, writes it to a register and:

- if the address has the Shared Memory attribute, marks the physical address as exclusive access for the executing processor in a global monitor
- causes the executing processor to indicate an active exclusive access in the local monitor.

For more information about support for shared memory see [Synchronization and semaphores on page A3-114](#). For information about memory accesses see [Memory accesses on page A8-294](#).

#### Encoding T1 ARMv6T2, ARMv7

LDREX<c> <Rt>, [<Rn>{, #<imm>}]

15	14	13	12	11	10	9	8	7	6	5	4	3	2	1	0	15	14	13	12	11	10	9	8	7	6	5	4	3	2	1	0
1	1	1	0	1	0	0	0	0	1	0	1	Rn				Rt				(1)(1)(1)(1)				imm8							

t = UInt(Rt); n = UInt(Rn); imm32 = ZeroExtend(imm8:'00', 32);  
if t IN {13,15} || n == 15 then UNPREDICTABLE;

#### Encoding A1 ARMv6\*, ARMv7

LDREX<c> <Rt>, [<Rn>]

31	30	29	28	27	26	25	24	23	22	21	20	19	18	17	16	15	14	13	12	11	10	9	8	7	6	5	4	3	2	1	0						
cond		0		0		0		1		1		0		0		1		Rn				Rt				(1)(1)(1)(1)				1 0 0 1				(1)(1)(1)(1)			

t = UInt(Rt); n = UInt(Rn); imm32 = Zeros(32); // Zero offset  
if t == 15 || n == 15 then UNPREDICTABLE;

## Assembler syntax

LDREX{<c>}{<q>} <Rt>, [<Rn> {, #<imm>}]

where:

<c>, <q> See *Standard assembler syntax fields* on page A8-287.

<Rt> The destination register.

<Rn> The base register. The SP can be used.

<imm> The immediate offset added to the value of <Rn> to form the address. <imm> can be omitted, meaning an offset of 0. Values are:

**Encoding T1** multiples of 4 in the range 0-1020

**Encoding A1** omitted or 0.

## Operation

```
if ConditionPassed() then
    EncodingSpecificOperations(); NullCheckIfThumbEE(n);
    address = R[n] + imm32;
    SetExclusiveMonitors(address,4);
    R[t] = MemA[address,4];
```

## Exceptions

Data Abort.

## A8.8.76 LDREXB

Load Register Exclusive Byte derives an address from a base register value, loads a byte from memory, zero-extends it to form a 32-bit word, writes it to a register and:

- if the address has the Shared Memory attribute, marks the physical address as exclusive access for the executing processor in a global monitor
- causes the executing processor to indicate an active exclusive access in the local monitor.

For more information about support for shared memory see [Synchronization and semaphores on page A3-114](#). For information about memory accesses see [Memory accesses on page A8-294](#).

### Encoding T1 ARMv7

LDREXB<c> <Rt>, [<Rn>]

15	14	13	12	11	10	9	8	7	6	5	4	3	2	1	0	15	14	13	12	11	10	9	8	7	6	5	4	3	2	1	0
1	1	1	0	1	0	0	0	1	1	0	1		Rn		Rt		(1)	(1)	(1)	(1)	0	1	0	0	(1)	(1)	(1)	(1)			

t = UInt(Rt); n = UInt(Rn);  
if t IN {13,15} || n == 15 then UNPREDICTABLE;

### Encoding A1 ARMv6K, ARMv7

LDREXB<c> <Rt>, [<Rn>]

31	30	29	28	27	26	25	24	23	22	21	20	19	18	17	16	15	14	13	12	11	10	9	8	7	6	5	4	3	2	1	0
cond	0	0	0	1	1	1	0	1		Rn		Rt		(1)	(1)	(1)	(1)	1	0	0	1	(1)	(1)	(1)	(1)						

t = UInt(Rt); n = UInt(Rn);  
if t == 15 || n == 15 then UNPREDICTABLE;

## Assembler syntax

LDREXB{<c>}{<q>} <Rt>, [<Rn>]

where:

<c>, <q> See *Standard assembler syntax fields* on page A8-287.

<Rt> The destination register.

<Rn> The base register. The SP can be used.

## Operation

```
if ConditionPassed() then
    EncodingSpecificOperations(); NullCheckIfThumbEE(n);
    address = R[n];
    SetExclusiveMonitors(address,1);
    R[t] = ZeroExtend(MemA[address,1], 32);
```

## Exceptions

Data Abort.

### A8.8.77 LDREXD

Load Register Exclusive Doubleword derives an address from a base register value, loads a 64-bit doubleword from memory, writes it to two registers and:

- if the address has the Shared Memory attribute, marks the physical address as exclusive access for the executing processor in a global monitor
- causes the executing processor to indicate an active exclusive access in the local monitor.

For more information about support for shared memory see [Synchronization and semaphores on page A3-114](#). For information about memory accesses see [Memory accesses on page A8-294](#).

#### Encoding T1 ARMv7

LDREXD<c> <Rt>, <Rt2>, [<Rn>]

15	14	13	12	11	10	9	8	7	6	5	4	3	2	1	0	15	14	13	12	11	10	9	8	7	6	5	4	3	2	1	0
1	1	1	0	1	0	0	0	1	1	0	1		Rn		Rt		Rt2		0	1	1	1	(1)	(1)	(1)	(1)	(1)	(1)			

t = UInt(Rt); t2 = UInt(Rt2); n = UInt(Rn);  
if t IN {13,15} || t2 IN {13,15} || t == t2 || n == 15 then UNPREDICTABLE;

#### Encoding A1 ARMv6K, ARMv7

LDREXD<c> <Rt>, <Rt2>, [<Rn>]

31	30	29	28	27	26	25	24	23	22	21	20	19	18	17	16	15	14	13	12	11	10	9	8	7	6	5	4	3	2	1	0
cond	0	0	0	1	1	0	1	1		Rn		Rt	(1)	(1)	(1)	(1)	1	0	0	1	(1)	(1)	(1)	(1)	(1)	(1)	(1)	(1)	(1)	(1)	

t = UInt(Rt); t2 = t+1; n = UInt(Rn);  
if Rt<0> == '1' || Rt == '1110' || n == 15 then UNPREDICTABLE;



## Assembler syntax

LDREXD{<c>}{<q>} <Rt>, <Rt2>, [<Rn>]

where:

- <c>, <q> See *Standard assembler syntax fields* on page A8-287.
- <Rt> The first destination register. For an ARM instruction, <Rt> must be even-numbered and not R14.
- <Rt2> The second destination register. For an ARM instruction, <Rt2> must be <R(t+1)>.
- <Rn> The base register. The SP can be used.

## Operation

```
if ConditionPassed() then
    EncodingSpecificOperations(); NullCheckIfThumbEE(n);
    address = R[n];
    SetExclusiveMonitors(address,8);
    value = MemA[address,8];
    // Extract words from 64-bit loaded value such that R[t] is
    // loaded from address and R[t2] from address+4.
    R[t] = if BigEndian() then value<63:32> else value<31:0>;
    R[t2] = if BigEndian() then value<31:0> else value<63:32>;
```

## Exceptions

Data Abort.

### A8.8.78 LDREXH

Load Register Exclusive Halfword derives an address from a base register value, loads a halfword from memory, zero-extends it to form a 32-bit word, writes it to a register and:

- if the address has the Shared Memory attribute, marks the physical address as exclusive access for the executing processor in a global monitor
- causes the executing processor to indicate an active exclusive access in the local monitor.

For more information about support for shared memory see [Synchronization and semaphores on page A3-114](#). For information about memory accesses see [Memory accesses on page A8-294](#).

#### Encoding T1 ARMv7

LDREXH<c> <Rt>, [<Rn>]

15	14	13	12	11	10	9	8	7	6	5	4	3	2	1	0	15	14	13	12	11	10	9	8	7	6	5	4	3	2	1	0
1	1	1	0	1	0	0	0	1	1	0	1		Rn		Rt	(1)	(1)	(1)	(1)	0	1	0	1	(1)	(1)	(1)	(1)				

t = UInt(Rt); n = UInt(Rn);  
if t IN {13,15} || n == 15 then UNPREDICTABLE;

#### Encoding A1 ARMv6K, ARMv7

LDREXH<c> <Rt>, [<Rn>]

31	30	29	28	27	26	25	24	23	22	21	20	19	18	17	16	15	14	13	12	11	10	9	8	7	6	5	4	3	2	1	0
cond	0	0	0	1	1	1	1	1		Rn		Rt	(1)	(1)	(1)	(1)	1	0	0	1	(1)	(1)	(1)	(1)							

t = UInt(Rt); n = UInt(Rn);  
if t == 15 || n == 15 then UNPREDICTABLE;

## Assembler syntax

LDREXH{<c>}{<q>} <Rt>, [<Rn>]

where:

<c>, <q> See *Standard assembler syntax fields* on page A8-287.

<Rt> The destination register.

<Rn> The base register. The SP can be used.

## Operation

```
if ConditionPassed() then
    EncodingSpecificOperations(); NullCheckIfThumbEE(n);
    address = R[n];
    SetExclusiveMonitors(address,2);
    R[t] = ZeroExtend(MemA[address,2], 32);
```

## Exceptions

Data Abort.

### A8.8.79 LDRH (immediate, Thumb)

Load Register Halfword (immediate) calculates an address from a base register value and an immediate offset, loads a halfword from memory, zero-extends it to form a 32-bit word, and writes it to a register. It can use offset, post-indexed, or pre-indexed addressing. For information about memory accesses see [Memory accesses on page A8-294](#).

**Encoding T1** ARMv4T, ARMv5T\*, ARMv6\*, ARMv7

LDRH<c> <Rt>, [<Rn>{, #<imm>}]

15	14	13	12	11	10	9	8	7	6	5	4	3	2	1	0
1	0	0	0	1	imm5				Rn			Rt			

t = UInt(Rt); n = UInt(Rn); imm32 = ZeroExtend(imm5:'0', 32);  
index = TRUE; add = TRUE; wback = FALSE;

**Encoding T2** ARMv6T2, ARMv7

LDRH<c>.W <Rt>, [<Rn>{, #<imm12>}]

15	14	13	12	11	10	9	8	7	6	5	4	3	2	1	0	15	14	13	12	11	10	9	8	7	6	5	4	3	2	1	0
1	1	1	1	1	0	0	0	1	0	1	1	Rn			Rt		imm12														

if Rt == '1111' then SEE PLD (immediate);  
if Rn == '1111' then SEE LDRH (literal);  
t = UInt(Rt); n = UInt(Rn); imm32 = ZeroExtend(imm12, 32);  
index = TRUE; add = TRUE; wback = FALSE;  
if t == 13 then UNPREDICTABLE;

**Encoding T3** ARMv6T2, ARMv7

LDRH<c> <Rt>, [<Rn>, #-<imm8>]

LDRH<c> <Rt>, [<Rn>], #+/-<imm8>

LDRH<c> <Rt>, [<Rn>, #+/-<imm8>]!

15	14	13	12	11	10	9	8	7	6	5	4	3	2	1	0	15	14	13	12	11	10	9	8	7	6	5	4	3	2	1	0
1	1	1	1	1	0	0	0	0	0	1	1	Rn			Rt		1	P	U	W	imm8										

if Rn == '1111' then SEE LDRH (literal);  
if P == '1' && U == '0' && W == '0' then SEE PLDW (immediate);  
if P == '1' && U == '1' && W == '0' then SEE LDRHT;  
if P == '0' && W == '0' then UNDEFINED;  
t = UInt(Rt); n = UInt(Rn); imm32 = ZeroExtend(imm8, 32);  
index = (P == '1'); add = (U == '1'); wback = (W == '1');  
if t == 13 || (t == 15 && W == '1') || (wback && n == t) then UNPREDICTABLE;

## Assembler syntax

LDRH{<c>}{<q>} <Rt>, [<Rn> {, #+/-<imm>}]	Offset: index==TRUE, wback==FALSE
LDRH{<c>}{<q>} <Rt>, [<Rn>, #+/-<imm>]!	Pre-indexed: index==TRUE, wback==TRUE
LDRH{<c>}{<q>} <Rt>, [<Rn>], #+/-<imm>	Post-indexed: index==FALSE, wback==TRUE

where:

<c>, <q>	See <a href="#">Standard assembler syntax fields on page A8-287</a> .						
<Rt>	The destination register.						
<Rn>	The base register. The SP can be used. For PC use see <a href="#">LDRH (literal) on page A8-444</a> .						
+/-	Is + or omitted to indicate that the immediate offset is added to the base register value (add == TRUE), or – to indicate that the offset is to be subtracted (add == FALSE). Different instructions are generated for #0 and #-0.						
<imm>	The immediate offset used for forming the address. For the offset addressing syntax, <imm> can be omitted, meaning an offset of 0. Values are: <table> <tr> <td><b>Encoding T1</b></td> <td>multiples of 2 in the range 0-62</td> </tr> <tr> <td><b>Encoding T2</b></td> <td>any value in the range 0-4095</td> </tr> <tr> <td><b>Encoding T3</b></td> <td>any value in the range 0-255.</td> </tr> </table>	<b>Encoding T1</b>	multiples of 2 in the range 0-62	<b>Encoding T2</b>	any value in the range 0-4095	<b>Encoding T3</b>	any value in the range 0-255.
<b>Encoding T1</b>	multiples of 2 in the range 0-62						
<b>Encoding T2</b>	any value in the range 0-4095						
<b>Encoding T3</b>	any value in the range 0-255.						

The pre-UAL syntax LDR<c>H is equivalent to LDRH<c>.

## Operation

```

if ConditionPassed() then
    EncodingSpecificOperations(); NullCheckIfThumbEE(n);
    offset_addr = if add then (R[n] + imm32) else (R[n] - imm32);
    address = if index then offset_addr else R[n];
    data = MemU[address,2];
    if wback then R[n] = offset_addr;
    if UnalignedSupport() || address<0> == '0' then
        R[t] = ZeroExtend(data, 32);
    else // Can only apply before ARMv7
        R[t] = bits(32) UNKNOWN;

```

## Exceptions

Data Abort.

### A8.8.80 LDRH (immediate, ARM)

Load Register Halfword (immediate) calculates an address from a base register value and an immediate offset, loads a halfword from memory, zero-extends it to form a 32-bit word, and writes it to a register. It can use offset, post-indexed, or pre-indexed addressing. For information about memory accesses see [Memory accesses on page A8-294](#).

**Encoding A1** ARMv4\*, ARMv5T\*, ARMv6\*, ARMv7

LDRH<c> <Rt>, [<Rn>{, #+/-<imm8>}]

LDRH<c> <Rt>, [<Rn>], #+/-<imm8>

LDRH<c> <Rt>, [<Rn>, #+/-<imm8>]!

31	30	29	28	27	26	25	24	23	22	21	20	19	18	17	16	15	14	13	12	11	10	9	8	7	6	5	4	3	2	1	0
cond				0	0	0	P	U	1	W	1	Rn				Rt				imm4H				1	0	1	1	imm4L			

```

if Rn == '1111' then SEE LDRH (literal);
if P == '0' && W == '1' then SEE LDRHT;
t = UInt(Rt); n = UInt(Rn); imm32 = ZeroExtend(imm4H:imm4L, 32);
index = (P == '1'); add = (U == '1'); wback = (P == '0') || (W == '1');
if t == 15 || (wback && n == t) then UNPREDICTABLE;

```

## Assembler syntax

LDRH{<c>}{<q>} <Rt>, [<Rn> {, #+/-<imm>}]	Offset: index==TRUE, wback==FALSE
LDRH{<c>}{<q>} <Rt>, [<Rn>, #+/-<imm>]!	Pre-indexed: index==TRUE, wback==TRUE
LDRH{<c>}{<q>} <Rt>, [<Rn>], #+/-<imm>	Post-indexed: index==FALSE, wback==TRUE

where:

<c>, <q>	See <a href="#">Standard assembler syntax fields on page A8-287</a> .
<Rt>	The destination register.
<Rn>	The base register. The SP can be used. For PC use see <a href="#">LDRH (literal) on page A8-444</a> .
+/-	Is + or omitted to indicate that the immediate offset is added to the base register value (add == TRUE), or – to indicate that the offset is to be subtracted (add == FALSE). Different instructions are generated for #0 and #-0.
<imm>	The immediate offset used for forming the address. For the offset addressing syntax, <imm> can be omitted, meaning an offset of 0. Any value in the range 0-255 is permitted.

The pre-UAL syntax LDR<c>H is equivalent to LDRH<c>.

## Operation

```

if ConditionPassed() then
    EncodingSpecificOperations();
    offset_addr = if add then (R[n] + imm32) else (R[n] - imm32);
    address = if index then offset_addr else R[n];
    data = MemU[address,2];
    if wback then R[n] = offset_addr;
    if UnalignedSupport() || address<0> == '0' then
        R[t] = ZeroExtend(data, 32);
    else // Can only apply before ARMv7
        R[t] = bits(32) UNKNOWN;

```

## Exceptions

Data Abort.

### A8.8.81 LDRH (literal)

Load Register Halfword (literal) calculates an address from the PC value and an immediate offset, loads a halfword from memory, zero-extends it to form a 32-bit word, and writes it to a register. For information about memory accesses see *Memory accesses* on page A8-294.

#### Encoding T1 ARMv6T2, ARMv7

LDRH<c> <Rt>, <label>

LDRH<c> <Rt>, [PC, #-0] Special case

15	14	13	12	11	10	9	8	7	6	5	4	3	2	1	0	15	14	13	12	11	10	9	8	7	6	5	4	3	2	1	0
1	1	1	1	1	0	0	0	U	0	1	1	1	1	1	1	Rt	imm12														

if Rt == '1111' then SEE PLD (literal);  
t = UInt(Rt); imm32 = ZeroExtend(imm12, 32); add = (U == '1');  
if t == 13 then UNPREDICTABLE;

#### Encoding A1 ARMv4\*, ARMv5T\*, ARMv6\*, ARMv7

LDRH<c> <Rt>, <label>

LDRH<c> <Rt>, [PC, #-0] Special case

31	30	29	28	27	26	25	24	23	22	21	20	19	18	17	16	15	14	13	12	11	10	9	8	7	6	5	4	3	2	1	0
cond		0	0	0	P	U	1	W	1	1	1	1	1	Rt	imm4H		1	0	1	1	imm4L										

t = UInt(Rt); imm32 = ZeroExtend(imm4H:imm4L, 32); add = (U == '1');  
if P == '0' && W == '1' the SEE LDRHT;  
if P == W then UNPREDICTABLE;  
if t == 15 then UNPREDICTABLE;



## Assembler syntax

LDRH{<c>}{<q>} <Rt>, <label> Normal form  
LDRH{<c>}{<q>} <Rt>, [PC, #+/-<imm>] Alternative form

where:

<c>, <q> See [Standard assembler syntax fields on page A8-287](#).

<Rt> The destination register.

<label> The label of the literal data item that is to be loaded into <Rt>. The assembler calculates the required value of the offset from the `Align(PC, 4)` value of the instruction to this label. Permitted values of the offset are:

**Encoding T1** any value in the range -4095 to 4095

**Encoding A1** any value in the range -255 to 255.

If the offset is zero or positive, `imm32` is equal to the offset and `add == TRUE`.

If the offset is negative, `imm32` is equal to minus the offset and `add == FALSE`.

The alternative syntax permits the addition or subtraction of the offset and the immediate offset to be specified separately, including permitting a subtraction of 0 that cannot be specified using the normal syntax. For more information, see [Use of labels in UAL instruction syntax on page A4-162](#).

The pre-UAL syntax `LDR<c>H` is equivalent to `LDRH<c>`.

## Operation

```
if ConditionPassed() then
    EncodingSpecificOperations();  NullCheckIfThumbEE(15);
    base = Align(PC,4);
    address = if add then (base + imm32) else (base - imm32);
    data = MemU[address,2];
    if UnalignedSupport() || address<0> == '0' then
        R[t] = ZeroExtend(data, 32);
    else // Can only apply before ARMv7
        R[t] = bits(32) UNKNOWN;
```

## Exceptions

Data Abort.

## A8.8.82 LDRH (register)

Load Register Halfword (register) calculates an address from a base register value and an offset register value, loads a halfword from memory, zero-extends it to form a 32-bit word, and writes it to a register. The offset register value can be shifted left by 0, 1, 2, or 3 bits. For information about memory accesses see [Memory accesses on page A8-294](#).

**Encoding T1** ARMv4T, ARMv5T\*, ARMv6\*, ARMv7

LDRH<c> <Rt>, [<Rn>, <Rm>]

15	14	13	12	11	10	9	8	7	6	5	4	3	2	1	0
0	1	0	1	1	0	1	Rm		Rn		Rt				

```
if CurrentInstrSet() == InstrSet_ThumbEE then SEE "Modified operation in ThumbEE";
t = UInt(Rt); n = UInt(Rn); m = UInt(Rm);
index = TRUE; add = TRUE; wback = FALSE;
(shift_t, shift_n) = (SRTYPE_LSL, 0);
```

**Encoding T2** ARMv6T2, ARMv7

LDRH<c>.W <Rt>, [<Rn>, <Rm>{, LSL #<imm2>}]

15	14	13	12	11	10	9	8	7	6	5	4	3	2	1	0	15	14	13	12	11	10	9	8	7	6	5	4	3	2	1	0
1	1	1	1	1	0	0	0	0	0	1	1	Rn		Rt		0	0	0	0	0	0	imm2	Rm								

```
if Rn == '1111' then SEE LDRH (literal);
if Rt == '1111' then SEE PLDW (register);
t = UInt(Rt); n = UInt(Rn); m = UInt(Rm);
index = TRUE; add = TRUE; wback = FALSE;
(shift_t, shift_n) = (SRTYPE_LSL, UInt(imm2));
if t == 13 || m IN {13,15} then UNPREDICTABLE;
```

**Encoding A1** ARMv4\*, ARMv5T\*, ARMv6\*, ARMv7

LDRH<c> <Rt>, [<Rn>, +/-<Rm>]{}]

LDRH<c> <Rt>, [<Rn>], +/-<Rm>

31	30	29	28	27	26	25	24	23	22	21	20	19	18	17	16	15	14	13	12	11	10	9	8	7	6	5	4	3	2	1	0
cond		0	0	0	P	U	0	W	1	Rn		Rt		(0)	(0)	(0)	(0)	1	0	1	1	Rm									

```
if P == '0' && W == '1' then SEE LDRHT;
t = UInt(Rt); n = UInt(Rn); m = UInt(Rm);
index = (P == '1'); add = (U == '1'); wback = (P == '0') || (W == '1');
(shift_t, shift_n) = (SRTYPE_LSL, 0);
if t == 15 || m == 15 then UNPREDICTABLE;
if wback && (n == 15 || n == t) then UNPREDICTABLE;
if ArchVersion() < 6 && wback && m == n then UNPREDICTABLE;
```

**Modified operation in ThumbEE** See [LDRH \(register\) on page A9-1119](#)

## Assembler syntax

LDRH{<c>}{<q>} <Rt>, [<Rn>, <Rm>{, LSL #<imm>}]	Offset: index==TRUE, wback==FALSE
LDRH{<c>}{<q>} <Rt>, [<Rn>, +/-<Rm>]	Offset: index==TRUE, wback==FALSE
LDRH{<c>}{<q>} <Rt>, [<Rn>, +/-<Rm>!]	Pre-indexed: index==TRUE, wback==TRUE
LDRH{<c>}{<q>} <Rt>, [<Rn>], +/-<Rm>	Post-indexed: index==FALSE, wback==TRUE

where:

<c>, <q>	See <a href="#">Standard assembler syntax fields on page A8-287</a> .
<Rt>	The destination register.
<Rn>	The base register. The SP can be used. In the ARM instruction set the PC can be used, for offset addressing forms of the instruction only. In the Thumb instruction set, the PC cannot be used for any of these forms of the LDRH instruction.
+/-	Is + or omitted if the optionally shifted value of <Rm> is to be added to the base register value (add == TRUE), or – if it is to be subtracted (permitted in ARM instructions only, add == FALSE).
<Rm>	Contains the offset that is optionally left shifted and added to the value of <Rn> to form the address.
<imm>	If present, the size of the left shift to apply to the value from <Rm>, in the range 1-3. Only encoding T2 is permitted, and <imm> is encoded in imm2. If absent, no shift is specified and all encodings are permitted. In encoding T2, imm2 is encoded as 0b00.

The pre-UAL syntax LDR<c>H is equivalent to LDRH<c>.

## Operation

```

if ConditionPassed() then
    EncodingSpecificOperations(); NullCheckIfThumbEE(n);
    offset = Shift(R[m], shift_t, shift_n, APSR.C);
    offset_addr = if add then (R[n] + offset) else (R[n] - offset);
    address = if index then offset_addr else R[n];
    data = MemU[address,2];
    if wback then R[n] = offset_addr;
    if UnalignedSupport() || address<0> == '0' then
        R[t] = ZeroExtend(data, 32);
    else // Can only apply before ARMv7
        R[t] = bits(32) UNKNOWN;

```

## Exceptions

Data Abort.

### A8.8.83 LDRHT

Load Register Halfword Unprivileged loads a halfword from memory, zero-extends it to form a 32-bit word, and writes it to a register. For information about memory accesses see [Memory accesses on page A8-294](#).

The memory access is restricted as if the processor were running in User mode. This makes no difference if the processor is actually running in User mode.

LDRHT is UNPREDICTABLE in Hyp mode.

The Thumb instruction uses an offset addressing mode, that calculates the address used for the memory access from a base register value and an immediate offset, and leaves the base register unchanged.

The ARM instruction uses a post-indexed addressing mode, that uses a base register value as the address for the memory access, and calculates a new address from a base register value and an offset and writes it back to the base register. The offset can be an immediate value or a register value.

#### Encoding T1 ARMv6T2, ARMv7

LDRHT<c> <Rt>, [<Rn>, #<imm8>]

15	14	13	12	11	10	9	8	7	6	5	4	3	2	1	0	15	14	13	12	11	10	9	8	7	6	5	4	3	2	1	0
1	1	1	1	1	0	0	0	0	0	1	1	Rn				Rt		1	1	1	0	imm8									

```
if Rn == '1111' then SEE LDRH (literal);
t = UInt(Rt); n = UInt(Rn); postindex = FALSE; add = TRUE;
register_form = FALSE; imm32 = ZeroExtend(imm8, 32);
if t IN {13,15} then UNPREDICTABLE;
```

#### Encoding A1 ARMv6T2, ARMv7

LDRHT<c> <Rt>, [<Rn>] {, #+/-<imm8>}

31	30	29	28	27	26	25	24	23	22	21	20	19	18	17	16	15	14	13	12	11	10	9	8	7	6	5	4	3	2	1	0
cond		0	0	0	0	U	1	1	1	Rn			Rt		imm4H		1	0	1	1	imm4L										

```
t = UInt(Rt); n = UInt(Rn); postindex = TRUE; add = (U == '1');
register_form = FALSE; imm32 = ZeroExtend(imm4H:imm4L, 32);
if t == 15 || n == 15 || n == t then UNPREDICTABLE;
```

#### Encoding A2 ARMv6T2, ARMv7

LDRHT<c> <Rt>, [<Rn>], +/-<Rm>

31	30	29	28	27	26	25	24	23	22	21	20	19	18	17	16	15	14	13	12	11	10	9	8	7	6	5	4	3	2	1	0
cond		0	0	0	0	U	0	1	1	Rn			Rt		(0)	(0)	(0)	(0)	1	0	1	1	Rm								

```
t = UInt(Rt); n = UInt(Rn); m = UInt(Rm); postindex = TRUE; add = (U == '1');
register_form = TRUE;
if t == 15 || n == 15 || n == t || m == 15 then UNPREDICTABLE;
```

## Assembler syntax

LDRHT{<c>}{<q>} <Rt>, [<Rn> {, #<imm>}]	Offset: Thumb only
LDRHT{<c>}{<q>} <Rt>, [<Rn>] {, #+/-<imm>}	Post-indexed: ARM only
LDRHT{<c>}{<q>} <Rt>, [<Rn>], +/-<Rm>	Post-indexed: ARM only

where:

<c>, <q>	See <i>Standard assembler syntax fields</i> on page A8-287.
<Rt>	The destination register.
<Rn>	The base register. The SP can be used.
+/-	Is + or omitted if <imm> or the optionally shifted value of <Rm> is to be added to the base register value. Encoded as add = TRUE. Is – if <imm> or the optionally shifted value of <Rm> is to be subtracted from the base register value. This is permitted in ARM instructions only, and is encoded as add = FALSE.
<imm>	The immediate offset applied to the value of <Rn>. Any value in the range 0-255 is permitted. <imm> can be omitted, meaning an offset of 0.
<Rm>	Contains the offset that is applied to the value of <Rn> to form the address.

## Operation

```

if ConditionPassed() then
    if CurrentModeIsHyp() then UNPREDICTABLE;           // Hyp mode
    EncodingSpecificOperations(); NullCheckIfThumbEE(n);
    offset = if register_form then R[m] else imm32;
    offset_addr = if add then (R[n] + offset) else (R[n] - offset);
    address = if postindex then R[n] else offset_addr;
    data = MemU_unpriv[address,2];
    if postindex then R[n] = offset_addr;
    if UnalignedSupport() || address<0> == '0' then
        R[t] = ZeroExtend(data, 32);
    else // Can only apply before ARMv7
        R[t] = bits(32) UNKNOWN;

```

## Exceptions

Data Abort.

### A8.8.84 LDRSB (immediate)

Load Register Signed Byte (immediate) calculates an address from a base register value and an immediate offset, loads a byte from memory, sign-extends it to form a 32-bit word, and writes it to a register. It can use offset, post-indexed, or pre-indexed addressing. For information about memory accesses see [Memory accesses on page A8-294](#).

#### Encoding T1 ARMv6T2, ARMv7

LDRSB<c> <Rt>, [<Rn>, #<imm12>]

15	14	13	12	11	10	9	8	7	6	5	4	3	2	1	0	15	14	13	12	11	10	9	8	7	6	5	4	3	2	1	0
1	1	1	1	1	0	0	1	1	0	0	1	Rn				Rt		imm12													

```
if Rt == '1111' then SEE PLI;
if Rn == '1111' then SEE LDRSB (literal);
t = UInt(Rt); n = UInt(Rn); imm32 = ZeroExtend(imm12, 32);
index = TRUE; add = TRUE; wback = FALSE;
if t == 13 then UNPREDICTABLE;
```

#### Encoding T2 ARMv6T2, ARMv7

LDRSB<c> <Rt>, [<Rn>, #-<imm8>]

LDRSB<c> <Rt>, [<Rn>], #+/-<imm8>

LDRSB<c> <Rt>, [<Rn>, #+/-<imm8>]!

15	14	13	12	11	10	9	8	7	6	5	4	3	2	1	0	15	14	13	12	11	10	9	8	7	6	5	4	3	2	1	0
1	1	1	1	1	0	0	1	0	0	0	1	Rn				Rt		1	P	U	W	imm8									

```
if Rt == '1111' && P == '1' && U == '0' && W == '0' then SEE PLI;
if Rn == '1111' then SEE LDRSB (literal);
if P == '1' && U == '1' && W == '0' then SEE LDRSBT;
if P == '0' && W == '0' then UNDEFINED;
t = UInt(Rt); n = UInt(Rn); imm32 = ZeroExtend(imm8, 32);
index = (P == '1'); add = (U == '1'); wback = (W == '1');
if t == 13 || (t == 15 && W == '1') || (wback && n == t) then UNPREDICTABLE;
```

#### Encoding A1 ARMv4\*, ARMv5T\*, ARMv6\*, ARMv7

LDRSB<c> <Rt>, [<Rn>{, #+/-<imm8>}]

LDRSB<c> <Rt>, [<Rn>], #+/-<imm8>

LDRSB<c> <Rt>, [<Rn>, #+/-<imm8>]!

31	30	29	28	27	26	25	24	23	22	21	20	19	18	17	16	15	14	13	12	11	10	9	8	7	6	5	4	3	2	1	0
cond		0	0	0	P	U	1	W	1	Rn				Rt		imm4H				1	1	0	1	imm4L							

```
if Rn == '1111' then SEE LDRSB (literal);
if P == '0' && W == '1' then SEE LDRSBT;
t = UInt(Rt); n = UInt(Rn); imm32 = ZeroExtend(imm4H:imm4L, 32);
index = (P == '1'); add = (U == '1'); wback = (P == '0') || (W == '1');
if t == 15 || (wback && n == t) then UNPREDICTABLE;
```

## Assembler syntax

LDRSB{<c>}{<q>} <Rt>, [<Rn> {, #+/-<imm>}]	Offset: index==TRUE, wback==FALSE
LDRSB{<c>}{<q>} <Rt>, [<Rn>, #+/-<imm>]!	Pre-indexed: index==TRUE, wback==TRUE
LDRSB{<c>}{<q>} <Rt>, [<Rn>], #+/-<imm>	Post-indexed: index==FALSE, wback==TRUE

where:

<c>, <q>	See <a href="#">Standard assembler syntax fields on page A8-287</a> .
<Rt>	The destination register.
<Rn>	The base register. The SP can be used. For PC use see <a href="#">LDRSB (literal) on page A8-452</a> .
+/-	Is + or omitted to indicate that the immediate offset is added to the base register value (add == TRUE), or – to indicate that the offset is to be subtracted (add == FALSE). Different instructions are generated for #0 and #-0.
<imm>	The immediate offset used for forming the address. For the offset addressing syntax, <imm> can be omitted, meaning an offset of 0. Values are: <b>Encoding T1</b> any value in the range 0-4095 <b>Encoding T2 or A1</b> any value in the range 0-255.

The pre-UAL syntax LDR<c>SB is equivalent to LDRSB<c>.

## Operation

```

if ConditionPassed() then
    EncodingSpecificOperations(); NullCheckIfThumbEE(n);
    offset_addr = if add then (R[n] + imm32) else (R[n] - imm32);
    address = if index then offset_addr else R[n];
    R[t] = SignExtend(MemU[address,1], 32);
    if wback then R[n] = offset_addr;

```

## Exceptions

Data Abort.

### A8.8.85 LDRSB (literal)

Load Register Signed Byte (literal) calculates an address from the PC value and an immediate offset, loads a byte from memory, sign-extends it to form a 32-bit word, and writes it to a register. For information about memory accesses see *Memory accesses* on page A8-294.

#### Encoding T1 ARMv6T2, ARMv7

LDRSB<c> <Rt>, <label>

LDRSB<c> <Rt>, [PC, #-0] Special case

15	14	13	12	11	10	9	8	7	6	5	4	3	2	1	0	15	14	13	12	11	10	9	8	7	6	5	4	3	2	1	0
1	1	1	1	1	0	0	1	U	0	0	1	1	1	1	1	Rt	imm12														

if Rt == '1111' then SEE PLI;  
t = UInt(Rt); imm32 = ZeroExtend(imm12, 32); add = (U == '1');  
if t == 13 then UNPREDICTABLE;

#### Encoding A1 ARMv4\*, ARMv5T\*, ARMv6\*, ARMv7

LDRSB<c> <Rt>, <label>

LDRSB<c> <Rt>, [PC, #-0] Special case

31	30	29	28	27	26	25	24	23	22	21	20	19	18	17	16	15	14	13	12	11	10	9	8	7	6	5	4	3	2	1	0
cond		0	0	0	(1)	U	1	(0)	1	1	1	1	1	1	Rt	imm4H	1	1	0	1	imm4L										

t = UInt(Rt); imm32 = ZeroExtend(imm4H:imm4L, 32); add = (U == '1');  
if t == 15 then UNPREDICTABLE;



## Assembler syntax

LDRSB{<c>}{<q>} <Rt>, <label> Normal form  
LDRSB{<c>}{<q>} <Rt>, [PC, #+/-<imm>] Alternative form

where:

<c>, <q> See [Standard assembler syntax fields on page A8-287](#).

<Rt> The destination register.

<label> The label of the literal data item that is to be loaded into <Rt>. The assembler calculates the required value of the offset from the `Align(PC, 4)` value of the instruction to this label. Permitted values of the offset are:

**Encoding T1** any value in the range -4095 to 4095

**Encoding A1** any value in the range -255 to 255.

If the offset is zero or positive, `imm32` is equal to the offset and `add == TRUE`.

If the offset is negative, `imm32` is equal to minus the offset and `add == FALSE`.

The alternative syntax permits the addition or subtraction of the offset and the immediate offset to be specified separately, including permitting a subtraction of 0 that cannot be specified using the normal syntax. For more information, see [Use of labels in UAL instruction syntax on page A4-162](#).

The pre-UAL syntax `LDR<c>SB` is equivalent to `LDRSB<c>`.

## Operation

```
if ConditionPassed() then
    EncodingSpecificOperations();  NullCheckIfThumbEE(15);
    base = Align(PC,4);
    address = if add then (base + imm32) else (base - imm32);
    R[t] = SignExtend(MemU[address,1], 32);
```

## Exceptions

Data Abort.

### A8.8.86 LDRSB (register)

Load Register Signed Byte (register) calculates an address from a base register value and an offset register value, loads a byte from memory, sign-extends it to form a 32-bit word, and writes it to a register. The offset register value can be shifted left by 0, 1, 2, or 3 bits. For information about memory accesses see [Memory accesses on page A8-294](#).

#### Encoding T1 ARMv4T, ARMv5T\*, ARMv6\*, ARMv7

LDRSB<c> <Rt>, [<Rn>, <Rm>]

15	14	13	12	11	10	9	8	7	6	5	4	3	2	1	0
0	1	0	1	0	1	1	Rm			Rn			Rt		

t = UInt(Rt); n = UInt(Rn); m = UInt(Rm);  
index = TRUE; add = TRUE; wback = FALSE;  
(shift\_t, shift\_n) = (SRTYPE\_LSL, 0);

#### Encoding T2 ARMv6T2, ARMv7

LDRSB<c>.W <Rt>, [<Rn>, <Rm>{, LSL #<imm2>}]

15	14	13	12	11	10	9	8	7	6	5	4	3	2	1	0	15	14	13	12	11	10	9	8	7	6	5	4	3	2	1	0
1	1	1	1	1	0	0	1	0	0	0	1	Rn			Rt			0	0	0	0	0	0	imm2	Rm						

if Rt == '1111' then SEE PLI;  
if Rn == '1111' then SEE LDRSB (literal);  
t = UInt(Rt); n = UInt(Rn); m = UInt(Rm);  
index = TRUE; add = TRUE; wback = FALSE;  
(shift\_t, shift\_n) = (SRTYPE\_LSL, UInt(imm2));  
if t == 13 || m IN {13,15} then UNPREDICTABLE;

#### Encoding A1 ARMv4\*, ARMv5T\*, ARMv6\*, ARMv7

LDRSB<c> <Rt>, [<Rn>, +/-<Rm>]{!}

LDRSB<c> <Rt>, [<Rn>], +/-<Rm>

31	30	29	28	27	26	25	24	23	22	21	20	19	18	17	16	15	14	13	12	11	10	9	8	7	6	5	4	3	2	1	0
cond		0	0	0	P	U	0	W	1	Rn			Rt			(0)	(0)	(0)	(0)	1	1	0	1	Rm							

if P == '0' && W == '1' then SEE LDRSBT;  
t = UInt(Rt); n = UInt(Rn); m = UInt(Rm);  
index = (P == '1'); add = (U == '1'); wback = (P == '0') || (W == '1');  
(shift\_t, shift\_n) = (SRTYPE\_LSL, 0);  
if t == 15 || m == 15 then UNPREDICTABLE;  
if wback && (n == 15 || n == t) then UNPREDICTABLE;  
if ArchVersion() < 6 && wback && m == n then UNPREDICTABLE;

## Assembler syntax

LDRSB{<c>}{<q>} <Rt>, [<Rn>, <Rm>{, LSL #<imm>}]	Offset: index==TRUE, wback==FALSE
LDRSB{<c>}{<q>} <Rt>, [<Rn>, +/-<Rm>]	Offset: index==TRUE, wback==FALSE
LDRSB{<c>}{<q>} <Rt>, [<Rn>, +/-<Rm>]!	Pre-indexed: index==TRUE, wback==TRUE
LDRSB{<c>}{<q>} <Rt>, [<Rn>], +/-<Rm>	Post-indexed: index==FALSE, wback==TRUE

where:

<c>, <q>	See <a href="#">Standard assembler syntax fields on page A8-287</a> .
<Rt>	The destination register.
<Rn>	The base register. The SP can be used. In the ARM instruction set the PC can be used, for the offset addressing forms of the instruction only. In the Thumb instruction set, the PC cannot be used for any of these forms of the LDRSB instruction.
+/-	Is + or omitted if the optionally shifted value of <Rm> is to be added to the base register value (add == TRUE), or – if it is to be subtracted (permitted in ARM instructions only, add == FALSE).
<Rm>	Contains the offset that is optionally left shifted and added to the value of <Rn> to form the address.
<imm>	If present, the size of the left shift to apply to the value from <Rm>, in the range 1-3. Only encoding T2 is permitted, and <imm> is encoded in imm2. If absent, no shift is specified and all encodings are permitted. In encoding T2, imm2 is encoded as 0b00.

The pre-UAL syntax LDR<c>SB is equivalent to LDRSB<c>.

## Operation

```

if ConditionPassed() then
    EncodingSpecificOperations(); NullCheckIfThumbEE(n);
    offset = Shift(R[m], shift_t, shift_n, APSR.C);
    offset_addr = if add then (R[n] + offset) else (R[n] - offset);
    address = if index then offset_addr else R[n];
    R[t] = SignExtend(MemU[address,1], 32);
    if wback then R[n] = offset_addr;

```

## Exceptions

Data Abort.

## A8.8.87 LDRSBT

Load Register Signed Byte Unprivileged loads a byte from memory, sign-extends it to form a 32-bit word, and writes it to a register. For information about memory accesses see [Memory accesses on page A8-294](#).

The memory access is restricted as if the processor were running in User mode. This makes no difference if the processor is actually running in User mode.

LDRSBT is UNPREDICTABLE in Hyp mode.

The Thumb instruction uses an offset addressing mode, that calculates the address used for the memory access from a base register value and an immediate offset, and leaves the base register unchanged.

The ARM instruction uses a post-indexed addressing mode, that uses a base register value as the address for the memory access, and calculates a new address from a base register value and an offset and writes it back to the base register. The offset can be an immediate value or a register value.

### Encoding T1 ARMv6T2, ARMv7

LDRSBT<c> <Rt>, [<Rn>, #<imm8>]

15	14	13	12	11	10	9	8	7	6	5	4	3	2	1	0	15	14	13	12	11	10	9	8	7	6	5	4	3	2	1	0
1	1	1	1	1	0	0	1	0	0	0	1	Rn				Rt		1	1	1	0	imm8									

```
if Rn == '1111' then SEE LDRSB (literal);
t = UInt(Rt); n = UInt(Rn); postindex = FALSE; add = TRUE;
register_form = FALSE; imm32 = ZeroExtend(imm8, 32);
if t IN {13,15} then UNPREDICTABLE;
```

### Encoding A1 ARMv6T2, ARMv7

LDRSBT<c> <Rt>, [<Rn>] {, #+/-<imm8>}

31	30	29	28	27	26	25	24	23	22	21	20	19	18	17	16	15	14	13	12	11	10	9	8	7	6	5	4	3	2	1	0
cond		0	0	0	0	U	1	1	1	Rn			Rt		imm4H		1	1	0	1	imm4L										

```
t = UInt(Rt); n = UInt(Rn); postindex = TRUE; add = (U == '1');
register_form = FALSE; imm32 = ZeroExtend(imm4H:imm4L, 32);
if t == 15 || n == 15 || n == t then UNPREDICTABLE;
```

### Encoding A2 ARMv6T2, ARMv7

LDRSBT<c> <Rt>, [<Rn>], +/-<Rm>

31	30	29	28	27	26	25	24	23	22	21	20	19	18	17	16	15	14	13	12	11	10	9	8	7	6	5	4	3	2	1	0
cond		0	0	0	0	U	0	1	1	Rn			Rt		(0)	(0)	(0)	(0)	1	1	0	1	Rm								

```
t = UInt(Rt); n = UInt(Rn); m = UInt(Rm); postindex = TRUE; add = (U == '1');
register_form = TRUE;
if t == 15 || n == 15 || n == t || m == 15 then UNPREDICTABLE;
```

## Assembler syntax

LDRSBT{<c>}{<q>} <Rt>, [<Rn> {, #<imm>}]	Offset: Thumb only
LDRSBT{<c>}{<q>} <Rt>, [<Rn>] {, #+/-<imm>}	Post-indexed: ARM only
LDRSBT{<c>}{<q>} <Rt>, [<Rn>], +/-<Rm>	Post-indexed: ARM only

where:

<c>, <q>	See <i>Standard assembler syntax fields</i> on page A8-287.
<Rt>	The destination register.
<Rn>	The base register. The SP can be used.
+/-	Is + or omitted if <imm> or the optionally shifted value of <Rm> is to be added to the base register value (add == TRUE), or – if it is to be subtracted (permitted in ARM instructions only, add == FALSE).
<imm>	The immediate offset applied to the value of <Rn>. Any value in the range 0-255 is permitted. <imm> can be omitted, meaning an offset of 0.
<Rm>	Contains the offset that is applied to the value of <Rn> to form the address.

## Operation

```

if ConditionPassed() then
    if CurrentModeIsHyp() then UNPREDICTABLE;           // Hyp mode
    EncodingSpecificOperations(); NullCheckIfThumbEE(n);
    offset = if register_form then R[m] else imm32;
    offset_addr = if add then (R[n] + offset) else (R[n] - offset);
    address = if postindex then R[n] else offset_addr;
    R[t] = SignExtend(MemU_unpriv[address,1], 32);
    if postindex then R[n] = offset_addr;

```

## Exceptions

Data Abort.

### A8.8.88 LDRSH (immediate)

Load Register Signed Halfword (immediate) calculates an address from a base register value and an immediate offset, loads a halfword from memory, sign-extends it to form a 32-bit word, and writes it to a register. It can use offset, post-indexed, or pre-indexed addressing. For information about memory accesses see [Memory accesses on page A8-294](#).

**Encoding T1** ARMv6T2, ARMv7

LDRSH<c> <Rt>, [<Rn>, #<imm12>]

15	14	13	12	11	10	9	8	7	6	5	4	3	2	1	0	15	14	13	12	11	10	9	8	7	6	5	4	3	2	1	0
1	1	1	1	1	0	0	1	1	0	1	1	Rn				Rt		imm12													

if Rn == '1111' then SEE LDRSH (literal);  
if Rt == '1111' then SEE "Related instructions";  
t = UInt(Rt); n = UInt(Rn); imm32 = ZeroExtend(imm12, 32);  
index = TRUE; add = TRUE; wback = FALSE;  
if t == 13 then UNPREDICTABLE;

**Encoding T2** ARMv6T2, ARMv7

LDRSH<c> <Rt>, [<Rn>, #-<imm8>]

LDRSH<c> <Rt>, [<Rn>], #+/-<imm8>

LDRSH<c> <Rt>, [<Rn>, #+/-<imm8>]!

15	14	13	12	11	10	9	8	7	6	5	4	3	2	1	0	15	14	13	12	11	10	9	8	7	6	5	4	3	2	1	0
1	1	1	1	1	0	0	1	0	0	1	1	Rn				Rt		1	P	U	W	imm8									

if Rn == '1111' then SEE LDRSH (literal);  
if Rt == '1111' && P == '1' && U == '0' && W == '0' then SEE "Related instructions";  
if P == '1' && U == '1' && W == '0' then SEE LDRSHT;  
if P == '0' && W == '0' then UNDEFINED;  
t = UInt(Rt); n = UInt(Rn); imm32 = ZeroExtend(imm8, 32);  
index = (P == '1'); add = (U == '1'); wback = (W == '1');  
if t == 13 || (t == 15 && W == '1') || (wback && n == t) then UNPREDICTABLE;

**Encoding A1** ARMv4\*, ARMv5T\*, ARMv6\*, ARMv7

LDRSH<c> <Rt>, [<Rn>{, #+/-<imm8>}]

LDRSH<c> <Rt>, [<Rn>], #+/-<imm8>

LDRSH<c> <Rt>, [<Rn>, #+/-<imm8>]!

31	30	29	28	27	26	25	24	23	22	21	20	19	18	17	16	15	14	13	12	11	10	9	8	7	6	5	4	3	2	1	0
cond		0	0	0	P	U	1	W	1	Rn				Rt		imm4H				1	1	1	1	imm4L							

if Rn == '1111' then SEE LDRSH (literal);  
if P == '0' && W == '1' then SEE LDRSHT;  
t = UInt(Rt); n = UInt(Rn); imm32 = ZeroExtend(imm4H:imm4L, 32);  
index = (P == '1'); add = (U == '1'); wback = (P == '0') || (W == '1');  
if t == 15 || (wback && n == t) then UNPREDICTABLE;

#### Related instructions

See [Load halfword, memory hints on page A6-240](#)

## Assembler syntax

LDRSH{<c>}{<q>} <Rt>, [<Rn> {, #+/-<imm>}]	Offset: index==TRUE, wback==FALSE
LDRSH{<c>}{<q>} <Rt>, [<Rn>, #+/-<imm>]!	Pre-indexed: index==TRUE, wback==TRUE
LDRSH{<c>}{<q>} <Rt>, [<Rn>], #+/-<imm>	Post-indexed: index==FALSE, wback==TRUE

where:

<c>, <q>	See <a href="#">Standard assembler syntax fields on page A8-287</a> .
<Rt>	The destination register.
<Rn>	The base register. The SP can be used. For PC use see <a href="#">LDRSH (literal) on page A8-460</a> .
+/-	Is + or omitted to indicate that the immediate offset is added to the base register value (add == TRUE), or – to indicate that the offset is to be subtracted (add == FALSE). Different instructions are generated for #0 and #-0.
<imm>	The immediate offset used for forming the address, Values are 0-4095 for encoding T1, and 0-255 for encoding T2 or A1. For the offset syntax, <imm> can be omitted, meaning an offset of 0.

The pre-UAL syntax LDR<c>SH is equivalent to LDRSH<c>.

## Operation

```

if ConditionPassed() then
    EncodingSpecificOperations(); NullCheckIfThumbEE(n);
    offset_addr = if add then (R[n] + imm32) else (R[n] - imm32);
    address = if index then offset_addr else R[n];
    data = MemU[address,2];
    if wback then R[n] = offset_addr;
    if UnalignedSupport() || address<0> = '0' then
        R[t] = SignExtend(data, 32);
    else // Can only apply before ARMv7
        R[t] = bits(32) UNKNOWN;

```

## Exceptions

Data Abort.

### A8.8.89 LDRSH (literal)

Load Register Signed Halfword (literal) calculates an address from the PC value and an immediate offset, loads a halfword from memory, sign-extends it to form a 32-bit word, and writes it to a register. For information about memory accesses see [Memory accesses on page A8-294](#).

#### Encoding T1 ARMv6T2, ARMv7

LDRSH<c> <Rt>, <label>

LDRSH<c> <Rt>, [PC, #-0] Special case

15	14	13	12	11	10	9	8	7	6	5	4	3	2	1	0	15	14	13	12	11	10	9	8	7	6	5	4	3	2	1	0
1	1	1	1	1	0	0	1	U	0	1	1	1	1	1	1	Rt	imm12														

if Rt == '1111' then SEE "Related instructions";  
t = UInt(Rt); imm32 = ZeroExtend(imm12, 32); add = (U == '1');  
if t == 13 then UNPREDICTABLE;

#### Encoding A1 ARMv4\*, ARMv5T\*, ARMv6\*, ARMv7

LDRSH<c> <Rt>, <label>

LDRSH<c> <Rt>, [PC, #-0] Special case

31	30	29	28	27	26	25	24	23	22	21	20	19	18	17	16	15	14	13	12	11	10	9	8	7	6	5	4	3	2	1	0
cond			0	0	0	(1)	U	1	(0)	1	1	1	1	1	1	Rt	imm4H			1	1	1	1	imm4L							

t = UInt(Rt); imm32 = ZeroExtend(imm4H:imm4L, 32); add = (U == '1');  
if t == 15 then UNPREDICTABLE;

**Related instructions** See [Load halfword, memory hints on page A6-240](#)



## Assembler syntax

LDRSH{<c>}{<q>} <Rt>, <label> Normal form  
LDRSH{<c>}{<q>} <Rt>, [PC, #+/-<imm>] Alternative form

where:

<c>, <q> See [Standard assembler syntax fields on page A8-287](#).

<Rt> The destination register.

<label> The label of the literal data item that is to be loaded into <Rt>. The assembler calculates the required value of the offset from the `Align(PC, 4)` value of the instruction to this label. Permitted values of the offset are:

**Encoding T1** any value in the range -4095 to 4095

**Encoding A1** any value in the range -255 to 255.

If the offset is zero or positive, `imm32` is equal to the offset and `add == TRUE`.

If the offset is negative, `imm32` is equal to minus the offset and `add == FALSE`.

The alternative syntax permits the addition or subtraction of the offset and the immediate offset to be specified separately, including permitting a subtraction of 0 that cannot be specified using the normal syntax. For more information, see [Use of labels in UAL instruction syntax on page A4-162](#).

The pre-UAL syntax `LDR<c>SH` is equivalent to `LDRSH<c>`.

## Operation

```
if ConditionPassed() then
    EncodingSpecificOperations();  NullCheckIfThumbEE(15);
    base = Align(PC,4);
    address = if add then (base + imm32) else (base - imm32);
    data = MemU[address,2];
    if UnalignedSupport() || address<0> = '0' then
        R[t] = SignExtend(data, 32);
    else // Can only apply before ARMv7
        R[t] = bits(32) UNKNOWN;
```

## Exceptions

Data Abort.

### A8.8.90 LDRSH (register)

Load Register Signed Halfword (register) calculates an address from a base register value and an offset register value, loads a halfword from memory, sign-extends it to form a 32-bit word, and writes it to a register. The offset register value can be shifted left by 0, 1, 2, or 3 bits. For information about memory accesses see [Memory accesses on page A8-294](#).

**Encoding T1** ARMv4T, ARMv5T\*, ARMv6\*, ARMv7

LDRSH<c> <Rt>, [<Rn>, <Rm>]

15	14	13	12	11	10	9	8	7	6	5	4	3	2	1	0
0	1	0	1	1	1	1	Rm			Rn					Rt

```
if CurrentInstrSet() == InstrSet_ThumbEE then SEE "Modified operation in ThumbEE";
t = UInt(Rt); n = UInt(Rn); m = UInt(Rm);
index = TRUE; add = TRUE; wback = FALSE;
(shift_t, shift_n) = (SRTYPE_LSL, 0);
```

**Encoding T2** ARMv6T2, ARMv7

LDRSH<c>.W <Rt>, [<Rn>, <Rm>{, LSL #<imm2>}]

15	14	13	12	11	10	9	8	7	6	5	4	3	2	1	0	15	14	13	12	11	10	9	8	7	6	5	4	3	2	1	0
1	1	1	1	1	0	0	1	0	0	1	1		Rn		Rt		0	0	0	0	0	0	imm2		Rm						

```
if Rn == '1111' then SEE LDRSH (literal);
if Rt == '1111' then SEE "Related instructions";
t = UInt(Rt); n = UInt(Rn); m = UInt(Rm);
index = TRUE; add = TRUE; wback = FALSE;
(shift_t, shift_n) = (SRTYPE_LSL, UInt(imm2));
if t == 13 || m IN {13,15} then UNPREDICTABLE;
```

**Encoding A1** ARMv4\*, ARMv5T\*, ARMv6\*, ARMv7

LDRSH<c> <Rt>, [<Rn>, +/-<Rm>]{!}

LDRSH<c> <Rt>, [<Rn>], +/-<Rm>

31	30	29	28	27	26	25	24	23	22	21	20	19	18	17	16	15	14	13	12	11	10	9	8	7	6	5	4	3	2	1	0
cond		0	0	0	P	U	0	W	1		Rn			Rt		(0)	(0)	(0)	(0)	1	1	1	1					Rm			

```
if P == '0' && W == '1' then SEE LDRSHT;
t = UInt(Rt); n = UInt(Rn); m = UInt(Rm);
index = (P == '1'); add = (U == '1'); wback = (P == '0') || (W == '1');
(shift_t, shift_n) = (SRTYPE_LSL, 0);
if t == 15 || m == 15 then UNPREDICTABLE;
if wback && (n == 15 || n == t) then UNPREDICTABLE;
if ArchVersion() < 6 && wback && m == n then UNPREDICTABLE;
```

**Related instructions**

See [Load halfword, memory hints on page A6-240](#)

**Modified operation in ThumbEE**

See [LDRSH \(register\) on page A9-1120](#)

## Assembler syntax

LDRSH{<c>}{<q>} <Rt>, [<Rn>, <Rm>{, LSL #<imm>}]	Offset: index==TRUE, wback==FALSE
LDRSH{<c>}{<q>} <Rt>, [<Rn>, +/-<Rm>]	Offset: index==TRUE, wback==FALSE
LDRSH{<c>}{<q>} <Rt>, [<Rn>, +/-<Rm>]!	Pre-indexed: index==TRUE, wback==TRUE
LDRSH{<c>}{<q>} <Rt>, [<Rn>], +/-<Rm>	Post-indexed: index==FALSE, wback==TRUE

where:

<c>, <q>	See <a href="#">Standard assembler syntax fields on page A8-287</a> .
<Rt>	The destination register.
<Rn>	The base register. The SP can be used. In the ARM instruction set the PC can be used, for the offset addressing forms of the instruction only. In the Thumb instruction set, the PC cannot be used for any of these forms of the LDRSH instruction.
+/-	Is + or omitted if the optionally shifted value of <Rm> is to be added to the base register value (add == TRUE), or – if it is to be subtracted (permitted in ARM instructions only, add == FALSE).
<Rm>	Contains the offset that is optionally left shifted and added to the value of <Rn> to form the address.
<imm>	If present, the size of the left shift to apply to the value from <Rm>, in the range 1-3. Only encoding T2 is permitted, and <imm> is encoded in imm2. If absent, no shift is specified and all encodings are permitted. In encoding T2, imm2 is encoded as 0b00.

The pre-UAL syntax LDR<c>SH is equivalent to LDRSH<c>.

## Operation

```

if ConditionPassed() then
    EncodingSpecificOperations(); NullCheckIfThumbEE(n);
    offset = Shift(R[m], shift_t, shift_n, APSR.C);
    offset_addr = if add then (R[n] + offset) else (R[n] - offset);
    address = if index then offset_addr else R[n];
    data = MemU[address,2];
    if wback then R[n] = offset_addr;
    if UnalignedSupport() || address<0> = '0' then
        R[t] = SignExtend(data, 32);
    else // Can only apply before ARMv7
        R[t] = bits(32) UNKNOWN;

```

## Exceptions

Data Abort.

## A8.8.91 LDRSHT

Load Register Signed Halfword Unprivileged loads a halfword from memory, sign-extends it to form a 32-bit word, and writes it to a register. For information about memory accesses see [Memory accesses on page A8-294](#).

The memory access is restricted as if the processor were running in User mode. This makes no difference if the processor is actually running in User mode.

LDRSHT is UNPREDICTABLE in Hyp mode.

The Thumb instruction uses an offset addressing mode, that calculates the address used for the memory access from a base register value and an immediate offset, and leaves the base register unchanged.

The ARM instruction uses a post-indexed addressing mode, that uses a base register value as the address for the memory access, and calculates a new address from a base register value and an offset and writes it back to the base register. The offset can be an immediate value or a register value.

### Encoding T1 ARMv6T2, ARMv7

LDRSHT<c> <Rt>, [<Rn>, #<imm8>]

15	14	13	12	11	10	9	8	7	6	5	4	3	2	1	0	15	14	13	12	11	10	9	8	7	6	5	4	3	2	1	0
1	1	1	1	1	0	0	1	0	0	1	1	Rn				Rt		1	1	1	0	imm8									

```
if Rn == '1111' then SEE LDRSH (literal);
t = UInt(Rt); n = UInt(Rn); postindex = FALSE; add = TRUE;
register_form = FALSE; imm32 = ZeroExtend(imm8, 32);
if t IN {13,15} then UNPREDICTABLE;
```

### Encoding A1 ARMv6T2, ARMv7

LDRSHT<c> <Rt>, [<Rn>] {, #+/-<imm8>}

31	30	29	28	27	26	25	24	23	22	21	20	19	18	17	16	15	14	13	12	11	10	9	8	7	6	5	4	3	2	1	0
cond		0	0	0	0	U	1	1	1	Rn				Rt		imm4H		1	1	1	1	imm4L									

```
t = UInt(Rt); n = UInt(Rn); postindex = TRUE; add = (U == '1');
register_form = FALSE; imm32 = ZeroExtend(imm4H:imm4L, 32);
if t == 15 || n == 15 || n == t then UNPREDICTABLE;
```

### Encoding A2 ARMv6T2, ARMv7

LDRSHT<c> <Rt>, [<Rn>], +/-<Rm>

31	30	29	28	27	26	25	24	23	22	21	20	19	18	17	16	15	14	13	12	11	10	9	8	7	6	5	4	3	2	1	0
cond		0	0	0	0	U	0	1	1	Rn				Rt		(0)	(0)	(0)	(0)	1	1	1	1	Rm							

```
t = UInt(Rt); n = UInt(Rn); m = UInt(Rm); postindex = TRUE; add = (U == '1');
register_form = TRUE;
if t == 15 || n == 15 || n == t || m == 15 then UNPREDICTABLE;
```

## Assembler syntax

LDRSHT{<c>}{<q>} <Rt>, [<Rn> {, #<imm>}] Offset: Thumb only  
LDRSHT{<c>}{<q>} <Rt>, [<Rn>] {, #+/-<imm>} Post-indexed: ARM only  
LDRSHT{<c>}{<q>} <Rt>, [<Rn>], +/-<Rm> Post-indexed: ARM only

where:

<c>, <q> See [Standard assembler syntax fields on page A8-287](#).  
<Rt> The destination register.  
<Rn> The base register. The SP can be used.  
+/- Is + or omitted if <imm> or the optionally shifted value of <Rm> is to be added to the base register value (add == TRUE), or – if it is to be subtracted (permitted in ARM instructions only, add == FALSE).  
<imm> The immediate offset applied to the value of <Rn>. Any value in the range 0-255 is permitted. <imm> can be omitted, meaning an offset of 0.  
<Rm> Contains the offset that is applied to the value of <Rn> to form the address.

## Operation

```
if ConditionPassed() then
    if CurrentModeIsHyp() then UNPREDICTABLE;           // Hyp mode
    EncodingSpecificOperations(); NullCheckIfThumbEE(n);
    offset = if register_form then R[m] else imm32;
    offset_addr = if add then (R[n] + offset) else (R[n] - offset);
    address = if postindex then R[n] else offset_addr;
    data = MemU_unpriv[address,2];
    if postindex then R[n] = offset_addr;
    if UnalignedSupport() || address<0> = '0' then
        R[t] = SignExtend(data, 32);
    else // Can only apply before ARMv7
        R[t] = bits(32) UNKNOWN;
```

## Exceptions

Data Abort.

## A8.8.92 LDRT

Load Register Unprivileged loads a word from memory, and writes it to a register. For information about memory accesses see *Memory accesses* on page A8-294.

The memory access is restricted as if the processor were running in User mode. This makes no difference if the processor is actually running in User mode.

LDRT is UNPREDICTABLE in Hyp mode.

The Thumb instruction uses an offset addressing mode, that calculates the address used for the memory access from a base register value and an immediate offset, and leaves the base register unchanged.

The ARM instruction uses a post-indexed addressing mode, that uses a base register value as the address for the memory access, and calculates a new address from a base register value and an offset and writes it back to the base register. The offset can be an immediate value or an optionally-shifted register value.

### Encoding T1 ARMv6T2, ARMv7

LDRT<c> <Rt>, [<Rn>, #<imm8>]

15	14	13	12	11	10	9	8	7	6	5	4	3	2	1	0	15	14	13	12	11	10	9	8	7	6	5	4	3	2	1	0
1	1	1	1	1	0	0	0	0	1	0	1	Rn				Rt		1	1	1	0	imm8									

```
if Rn == '1111' then SEE LDR (literal);
t = UInt(Rt); n = UInt(Rn); postindex = FALSE; add = TRUE;
register_form = FALSE; imm32 = ZeroExtend(imm8, 32);
if t IN {13,15} then UNPREDICTABLE;
```

### Encoding A1 ARMv4\*, ARMv5T\*, ARMv6\*, ARMv7

LDRT<c> <Rt>, [<Rn>] {, #+/-<imm12>}

31	30	29	28	27	26	25	24	23	22	21	20	19	18	17	16	15	14	13	12	11	10	9	8	7	6	5	4	3	2	1	0
cond		0	1	0	0	U	0	1	1	Rn				Rt		imm12															

```
t = UInt(Rt); n = UInt(Rn); postindex = TRUE; add = (U == '1');
register_form = FALSE; imm32 = ZeroExtend(imm12, 32);
if t == 15 || n == 15 || n == t then UNPREDICTABLE;
```

### Encoding A2 ARMv4\*, ARMv5T\*, ARMv6\*, ARMv7

LDRT<c> <Rt>, [<Rn>],+/-<Rm>{, <shift>}

31	30	29	28	27	26	25	24	23	22	21	20	19	18	17	16	15	14	13	12	11	10	9	8	7	6	5	4	3	2	1	0
cond		0	1	1	0	U	0	1	1	Rn				Rt		imm5			type	0	Rm										

```
t = UInt(Rt); n = UInt(Rn); m = UInt(Rm); postindex = TRUE; add = (U == '1');
register_form = TRUE; (shift_t, shift_n) = DecodeImmShift(type, imm5);
if t == 15 || n == 15 || n == t || m == 15 then UNPREDICTABLE;
if ArchVersion() < 6 && m == n then UNPREDICTABLE;
```

## Assembler syntax

LDRT{<c>}{<q>} <Rt>, [<Rn> {, #<imm>}]	Offset: Thumb only
LDRT{<c>}{<q>} <Rt>, [<Rn>] {, #+/-<imm>}	Post-indexed: ARM only
LDRT{<c>}{<q>} <Rt>, [<Rn>], +/-<Rm> {, <shift>}	Post-indexed: ARM only

where:

<c>, <q>	See <a href="#">Standard assembler syntax fields on page A8-287</a> .
<Rt>	The destination register.
<Rn>	The base register. The SP can be used.
+/-	Is + or omitted if <imm> or the optionally shifted value of <Rm> is to be added to the base register value (add == TRUE), or – if it is to be subtracted (permitted in ARM instructions only, add == FALSE).
<imm>	The immediate offset applied to the value of <Rn>. Values are 0-255 for encoding T1, and 0-4095 for encoding A1. <imm> can be omitted, meaning an offset of 0.
<Rm>	Contains the offset that is optionally shifted and applied to the value of <Rn> to form the address.
<shift>	The shift to apply to the value read from <Rm>. If omitted, no shift is applied. <a href="#">Shifts applied to a register on page A8-291</a> describes the shifts and how they are encoded.

The pre-UAL syntax LDR<c>T is equivalent to LDRT<c>.

## Operation

```

if ConditionPassed() then
    if CurrentModeIsHyp() then UNPREDICTABLE;           // Hyp mode
    EncodingSpecificOperations(); NullCheckIfThumbEE(n);
    offset = if register_form then Shift(R[m], shift_t, shift_n, APSR.C) else imm32;
    offset_addr = if add then (R[n] + offset) else (R[n] - offset);
    address = if postindex then R[n] else offset_addr;
    data = MemU_unpriv[address,4];
    if postindex then R[n] = offset_addr;
    if UnalignedSupport() || address<1:0> = '00' then
        R[t] = data;
    else // Can only apply before ARMv7
        if CurrentInstrSet() == InstrSet_ARM then
            R[t] = ROR(data, 8*UInt(address<1:0>));
        else
            R[t] = bits(32) UNKNOWN;

```

## Exceptions

Data Abort.

### A8.8.93 LEAVEX

LEAVEX causes a change from ThumbEE to Thumb state, or has no effect in Thumb state. For details see [ENTERX](#), [LEAVEX](#) on page A9-1116.

### A8.8.94 LSL (immediate)

Logical Shift Left (immediate) shifts a register value left by an immediate number of bits, shifting in zeros, and writes the result to the destination register. It can optionally update the condition flags based on the result.

**Encoding T1** ARMv4T, ARMv5T\*, ARMv6\*, ARMv7

LSLS <Rd>, <Rm>, #<imm5> Outside IT block.

LSL<c> <Rd>, <Rm>, #<imm5> Inside IT block.

15	14	13	12	11	10	9	8	7	6	5	4	3	2	1	0
0	0	0	0	0	imm5			Rm		Rd					

if imm5 == '00000' then SEE MOV (register);  
d = UInt(Rd); m = UInt(Rm); setflags = !InITBlock();  
(-, shift\_n) = DecodeImmShift('00', imm5);

**Encoding T2** ARMv6T2, ARMv7

LSL{S}<c>.W <Rd>, <Rm>, #<imm5>

15	14	13	12	11	10	9	8	7	6	5	4	3	2	1	0	15	14	13	12	11	10	9	8	7	6	5	4	3	2	1	0
1	1	1	0	1	0	1	0	0	1	0	S	1	1	1	1	(0)	imm3			Rd		imm2		0	0	Rm					

if (imm3:imm2) == '00000' then SEE MOV (register);  
d = UInt(Rd); m = UInt(Rm); setflags = (S == '1');  
(-, shift\_n) = DecodeImmShift('00', imm3:imm2);  
if d IN {13,15} || m IN {13,15} then UNPREDICTABLE;

**Encoding A1** ARMv4\*, ARMv5T\*, ARMv6\*, ARMv7

LSL{S}<c> <Rd>, <Rm>, #<imm5>

31	30	29	28	27	26	25	24	23	22	21	20	19	18	17	16	15	14	13	12	11	10	9	8	7	6	5	4	3	2	1	0
cond		0	0	0	1	1	0	1	S	(0)	(0)	(0)	(0)	Rd				imm5			0	0	0	Rm							

if Rd == '1111' && S == '1' then SEE SUBS PC, LR and related instructions;  
if imm5 == '00000' then SEE MOV (register);  
d = UInt(Rd); m = UInt(Rm); setflags = (S == '1');  
(-, shift\_n) = DecodeImmShift('00', imm5);



## Assembler syntax

LSL{S}{<c>}{<q>} {<Rd>}, <Rm>, #<imm5>

where:

S If S is present, the instruction updates the flags. Otherwise, the flags are not updated.

<c>, <q> See [Standard assembler syntax fields on page A8-287](#).

<Rd> The destination register.

In ARM instructions, if S is not specified and <Rd> is the PC, the instruction is a branch to the address calculated by the operation. This is an interworking branch, see [Pseudocode details of operations on ARM core registers on page A2-47](#).

### ———— Note ————

Before ARMv7, this was a simple branch.

<Rm> The first operand register. The PC can be used in ARM instructions.

<imm5> The shift amount, in the range 1 to 31. See [Shifts applied to a register on page A8-291](#).

## Operation

```
if ConditionPassed() then
    EncodingSpecificOperations();
    (result, carry) = Shift_C(R[m], SRTYPE_LSL, shift_n, APSR.C);
    if d == 15 then // Can only occur for ARM encoding
        ALUWritePC(result); // setflags is always FALSE here
    else
        R[d] = result;
        if setflags then
            APSR.N = result<31>;
            APSR.Z = IsZeroBit(result);
            APSR.C = carry;
            // APSR.V unchanged
```

## Exceptions

None.

### A8.8.95 LSL (register)

Logical Shift Left (register) shifts a register value left by a variable number of bits, shifting in zeros, and writes the result to the destination register. The variable number of bits is read from the bottom byte of a register. It can optionally update the condition flags based on the result.

**Encoding T1** ARMv4T, ARMv5T\*, ARMv6\*, ARMv7

LSLS <Rdn>, <Rm> Outside IT block.  
LSL<c> <Rdn>, <Rm> Inside IT block.

15	14	13	12	11	10	9	8	7	6	5	4	3	2	1	0
0	1	0	0	0	0	0	0	1	0	Rm	Rdn				

d = UInt(Rdn); n = UInt(Rdn); m = UInt(Rm); setFlags = !InITBlock();

**Encoding T2** ARMv6T2, ARMv7

LSL{S}<c>.W <Rd>, <Rn>, <Rm>

15	14	13	12	11	10	9	8	7	6	5	4	3	2	1	0	15	14	13	12	11	10	9	8	7	6	5	4	3	2	1	0
1	1	1	1	1	0	1	0	0	0	0	S	Rn				1	1	1	1	Rd	0	0	0	0	Rm						

d = UInt(Rd); n = UInt(Rn); m = UInt(Rm); setFlags = (S == '1');  
if d IN {13,15} || n IN {13,15} || m IN {13,15} then UNPREDICTABLE;

**Encoding A1** ARMv4\*, ARMv5T\*, ARMv6\*, ARMv7

LSL{S}<c> <Rd>, <Rn>, <Rm>

31	30	29	28	27	26	25	24	23	22	21	20	19	18	17	16	15	14	13	12	11	10	9	8	7	6	5	4	3	2	1	0
cond		0	0	0	1	1	0	1	S	(0)	(0)	(0)	(0)	Rd				Rm				0	0	0	1	Rn					

d = UInt(Rd); n = UInt(Rn); m = UInt(Rm); setFlags = (S == '1');  
if d == 15 || n == 15 || m == 15 then UNPREDICTABLE;

## Assembler syntax

LSL{S}{<C>}{<q>} {<Rd>}, <Rn>, <Rm>

where:

S            If S is present, the instruction updates the flags. Otherwise, the flags are not updated.

<C>, <q>    See *Standard assembler syntax fields* on page A8-287.

<Rd>        The destination register.

<Rn>        The first operand register.

<Rm>        The register whose bottom byte contains the amount to shift by.

## Operation

```
if ConditionPassed() then
    EncodingSpecificOperations();
    shift_n = UInt(R[m]<7:0>);
    (result, carry) = Shift_C(R[n], SRTYPE_LSL, shift_n, APSR.C);
    R[d] = result;
    if setflags then
        APSR.N = result<31>;
        APSR.Z = IsZeroBit(result);
        APSR.C = carry;
        // APSR.V unchanged
```

## Exceptions

None.

### A8.8.96 LSR (immediate)

Logical Shift Right (immediate) shifts a register value right by an immediate number of bits, shifting in zeros, and writes the result to the destination register. It can optionally update the condition flags based on the result.

#### Encoding T1 ARMv4T, ARMv5T\*, ARMv6\*, ARMv7

LSRS <Rd>, <Rm>, #<imm> Outside IT block.  
LSR<c> <Rd>, <Rm>, #<imm> Inside IT block.

15	14	13	12	11	10	9	8	7	6	5	4	3	2	1	0
0	0	0	0	1	imm5					Rm			Rd		

```
d = UInt(Rd); m = UInt(Rm); setflags = !InITBlock();
(-, shift_n) = DecodeImmShift('01', imm5);
```

#### Encoding T2 ARMv6T2, ARMv7

LSR{S}<c>.W <Rd>, <Rm>, #<imm>

15	14	13	12	11	10	9	8	7	6	5	4	3	2	1	0	15	14	13	12	11	10	9	8	7	6	5	4	3	2	1	0
1	1	1	0	1	0	1	0	0	1	0	S	1	1	1	1	(0)	imm3			Rd			imm2		0	1	Rm				

```
d = UInt(Rd); m = UInt(Rm); setflags = (S == '1');
(-, shift_n) = DecodeImmShift('01', imm3:imm2);
if d IN {13,15} || m IN {13,15} then UNPREDICTABLE;
```

#### Encoding A1 ARMv4\*, ARMv5T\*, ARMv6\*, ARMv7

LSR{S}<c> <Rd>, <Rm>, #<imm>

31	30	29	28	27	26	25	24	23	22	21	20	19	18	17	16	15	14	13	12	11	10	9	8	7	6	5	4	3	2	1	0
cond				0	0	0	1	1	0	1	S	(0)	(0)	(0)	(0)	Rd			imm5					0	1	0	Rm				

```
if Rd == '1111' && S == '1' then SEE SUBS PC, LR and related instructions;
d = UInt(Rd); m = UInt(Rm); setflags = (S == '1');
(-, shift_n) = DecodeImmShift('01', imm5);
```

## Assembler syntax

LSR{S}{<c>}{<q>} {<Rd>}, <Rm>, #<imm>

where:

S If S is present, the instruction updates the flags. Otherwise, the flags are not updated.

<c>, <q> See [Standard assembler syntax fields on page A8-287](#).

<Rd> The destination register.

In ARM instructions, if S is not specified and <Rd> is the PC, the instruction is a branch to the address calculated by the operation. This is an interworking branch, see [Pseudocode details of operations on ARM core registers on page A2-47](#).

### Note

Before ARMv7, this was a simple branch.

<Rm> The first operand register. The PC can be used in ARM instructions.

<imm> The shift amount, in the range 1 to 32. See [Shifts applied to a register on page A8-291](#).

## Operation

```
if ConditionPassed() then
    EncodingSpecificOperations();
    (result, carry) = Shift_C(R[m], SRTYPE_LSR, shift_n, APSR.C);
    if d == 15 then // Can only occur for ARM encoding
        ALUWritePC(result); // setflags is always FALSE here
    else
        R[d] = result;
        if setflags then
            APSR.N = result<31>;
            APSR.Z = IsZeroBit(result);
            APSR.C = carry;
            // APSR.V unchanged
```

## Exceptions

None.

## A8.8.97 LSR (register)

Logical Shift Right (register) shifts a register value right by a variable number of bits, shifting in zeros, and writes the result to the destination register. The variable number of bits is read from the bottom byte of a register. It can optionally update the condition flags based on the result.

**Encoding T1** ARMv4T, ARMv5T\*, ARMv6\*, ARMv7

LSRS <Rdn>, <Rm>

Outside IT block.

LSR<c> <Rdn>, <Rm>

Inside IT block.

15	14	13	12	11	10	9	8	7	6	5	4	3	2	1	0
0	1	0	0	0	0	0	0	1	1	Rm	Rdn				

d = UInt(Rdn); n = UInt(Rdn); m = UInt(Rm); setFlags = !InITBlock();

**Encoding T2** ARMv6T2, ARMv7

LSR{S}<c>.W <Rd>, <Rn>, <Rm>

15	14	13	12	11	10	9	8	7	6	5	4	3	2	1	0	15	14	13	12	11	10	9	8	7	6	5	4	3	2	1	0
1	1	1	1	1	0	1	0	0	0	1	S	Rn				1	1	1	1	Rd	0	0	0	0	Rm						

d = UInt(Rd); n = UInt(Rn); m = UInt(Rm); setFlags = (S == '1');  
if d IN {13,15} || n IN {13,15} || m IN {13,15} then UNPREDICTABLE;

**Encoding A1** ARMv4\*, ARMv5T\*, ARMv6\*, ARMv7

LSR{S}<c> <Rd>, <Rn>, <Rm>

31	30	29	28	27	26	25	24	23	22	21	20	19	18	17	16	15	14	13	12	11	10	9	8	7	6	5	4	3	2	1	0
cond		0	0	0	1	1	0	1	S	(0)	(0)	(0)	(0)	Rd				Rm				0	0	1	1	Rn					

d = UInt(Rd); n = UInt(Rn); m = UInt(Rm); setFlags = (S == '1');  
if d == 15 || n == 15 || m == 15 then UNPREDICTABLE;

## Assembler syntax

LSR{S}{<c>}{<q>} {<Rd>}, <Rn>, <Rm>

where:

S                    If S is present, the instruction updates the flags. Otherwise, the flags are not updated.

<c>, <q>            See *Standard assembler syntax fields* on page A8-287.

<Rd>                The destination register.

<Rn>                The first operand register.

<Rm>                The register whose bottom byte contains the amount to shift by.

## Operation

```
if ConditionPassed() then
    EncodingSpecificOperations();
    shift_n = UInt(R[m]<7:0>);
    (result, carry) = Shift_C(R[n], SRTYPE_LSR, shift_n, APSR.C);
    R[d] = result;
    if setflags then
        APSR.N = result<31>;
        APSR.Z = IsZeroBit(result);
        APSR.C = carry;
        // APSR.V unchanged
```

## Exceptions

None.

## A8.8.98 MCR, MCR2

Move to Coprocessor from ARM core register passes the value of an ARM core register to a coprocessor. If no coprocessor can execute the instruction, an Undefined Instruction exception is generated.

This is a generic coprocessor instruction. Some of the fields have no functionality defined by the architecture and are free for use by the coprocessor instruction set designer. These are the `opc1`, `opc2`, `CRn`, and `CRm` fields. However, coprocessors CP8-CP15 are reserved for use by ARM, and this manual defines the valid MCR and MCR2 instructions when `coproc` is in the range p8-p15. For more information see [Coprocessor support on page A2-94](#).

In an implementation that includes the Virtualization Extensions, MCR accesses to system control registers can be trapped to Hyp mode, meaning that an attempt to execute an MCR instruction in a Non-secure mode other than Hyp mode, that would be permitted in the absence of the Hyp trap controls, generates a Hyp Trap exception. For more information, see [Traps to the hypervisor on page B1-1247](#).

### ———— Note ————

Because of the range of possible traps to Hyp mode, the MCR pseudocode does not show these possible traps.

**Encoding T1/A1**      ARMv6T2, ARMv7 for encoding T1  
ARMv4\*, ARMv5T\*, ARMv6\*, ARMv7 for encoding A1  
MCR<c> <coproc>, <opc1>, <Rt>, <CRn>, <CRm>{, <opc2>}

15	14	13	12	11	10	9	8	7	6	5	4	3	2	1	0	15	14	13	12	11	10	9	8	7	6	5	4	3	2	1	0
1	1	1	0	1	1	1	0	opc1	0	CRn		Rt		coproc	opc2	1	CRm														

31	30	29	28	27	26	25	24	23	22	21	20	19	18	17	16	15	14	13	12	11	10	9	8	7	6	5	4	3	2	1	0
cond				1	1	1	0	opc1	0	CRn		Rt		coproc	opc2	1	CRm														

if coproc IN "101x" then SEE "Advanced SIMD and Floating-point";  
t = UInt(Rt); cp = UInt(coproc);  
if t == 15 || (t == 13 && (CurrentInstrSet() != InstrSet\_ARM)) then UNPREDICTABLE;

**Encoding T2/A2**      ARMv6T2, ARMv7 for encoding T2  
ARMv5T\*, ARMv6\*, ARMv7 for encoding A2  
MCR2<c> <coproc>, <opc1>, <Rt>, <CRn>, <CRm>{, <opc2>}

15	14	13	12	11	10	9	8	7	6	5	4	3	2	1	0	15	14	13	12	11	10	9	8	7	6	5	4	3	2	1	0
1	1	1	1	1	1	1	0	opc1	0	CRn		Rt		coproc	opc2	1	CRm														

31	30	29	28	27	26	25	24	23	22	21	20	19	18	17	16	15	14	13	12	11	10	9	8	7	6	5	4	3	2	1	0
1	1	1	1	1	1	1	0	opc1	0	CRn		Rt		coproc	opc2	1	CRm														

if coproc IN "101x" then UNDEFINED;  
t = UInt(Rt); cp = UInt(coproc);  
if t == 15 || (t == 13 && (CurrentInstrSet() != InstrSet\_ARM)) then UNPREDICTABLE;

**Advanced SIMD and Floating-point**      See [8](#), [16](#), and [32-bit transfer between ARM core and extension registers on page A7-278](#)



## Assembler syntax

MCR{2}{<c>}{<q>} <coproc>, {#}<opc1>, <Rt>, <CRn>, <CRm>{, {#}<opc2>}

where:

- 2 If specified, selects encoding T2/A2. If omitted, selects encoding T1/A1.
- <c>, <q> See [Standard assembler syntax fields on page A8-287](#). An ARM MCR2 instruction must be unconditional.
- <coproc> The name of the coprocessor. The generic coprocessor names are p0-p15.
- <opc1> Is a coprocessor-specific opcode in the range 0 to 7.
- <Rt> Is the ARM core register whose value is transferred to the coprocessor.
- <CRn> Is the destination coprocessor register.
- <CRm> Is an additional destination coprocessor register.
- <opc2> Is a coprocessor-specific opcode in the range 0-7. If omitted, <opc2> is assumed to be 0.

## Operation

```
if ConditionPassed() then
    EncodingSpecificOperations();
    if !Coprocc_Accepted(cp, ThisInstr()) then
        GenerateCoproccorException();
    else
        Coproc_SendOneWord(R[t], cp, ThisInstr());
```

## Exceptions

Undefined Instruction, Hyp Trap.

Uses of these instructions by specific coprocessors might generate other exceptions.

## A8.8.99 MCRR, MCRR2

Move to Coprocessor from two ARM core registers passes the values of two ARM core registers to a coprocessor. If no coprocessor can execute the instruction, an Undefined Instruction exception is generated.

This is a generic coprocessor instruction. Some of the fields have no functionality defined by the architecture and are free for use by the coprocessor instruction set designer. These are the `opc1` and `CRm` fields. However, coprocessors CP8-CP15 are reserved for use by ARM, and this manual defines the valid MCRR and MCRR2 instructions when coproc is in the range p8-p15. For more information see [Coprocessor support on page A2-94](#).

In an implementation that includes the Virtualization Extensions, MCRR accesses to system control registers can be trapped to Hyp mode, meaning that an attempt to execute an MCRR instruction in a Non-secure mode other than Hyp mode, that would be permitted in the absence of the Hyp trap controls, generates a Hyp Trap exception. For more information, see [Traps to the hypervisor on page B1-1247](#).

———— **Note** —————

Because of the range of possible traps to Hyp mode, the MCRR pseudocode does not show these possible traps.

**Encoding T1/A1**      ARMv6T2, ARMv7 for encoding T1  
ARMv5TE\*, ARMv6\*, ARMv7 for encoding A1

MCRR<c> <coproc>, <opc1>, <Rt>, <Rt2>, <CRm>

15	14	13	12	11	10	9	8	7	6	5	4	3	2	1	0	15	14	13	12	11	10	9	8	7	6	5	4	3	2	1	0
1	1	1	0	1	1	0	0	0	1	0	0	Rt2				Rt		coproc		opc1		CRm									

31	30	29	28	27	26	25	24	23	22	21	20	19	18	17	16	15	14	13	12	11	10	9	8	7	6	5	4	3	2	1	0
cond		1	1	0	0	0	1	0	0	Rt2				Rt		coproc		opc1		CRm											

```
if coproc IN "101x" then SEE "Advanced SIMD and Floating-point";
t = UInt(Rt); t2 = UInt(Rt2); cp = UInt(coproc);
if t == 15 || t2 == 15 then UNPREDICTABLE;
if (t == 13 || t2 == 13) && (CurrentInstrSet() != InstrSet_ARM) then UNPREDICTABLE;
```

**Encoding T2/A2**      ARMv6T2, ARMv7 for encoding T2  
ARMv6\*, ARMv7 for encoding A2

MCRR2<c> <coproc>, <opc1>, <Rt>, <Rt2>, <CRm>

15	14	13	12	11	10	9	8	7	6	5	4	3	2	1	0	15	14	13	12	11	10	9	8	7	6	5	4	3	2	1	0
1	1	1	1	1	1	0	0	0	1	0	0	Rt2				Rt		coproc		opc1		CRm									

31	30	29	28	27	26	25	24	23	22	21	20	19	18	17	16	15	14	13	12	11	10	9	8	7	6	5	4	3	2	1	0
1	1	1	1	1	1	0	0	0	1	0	0	Rt2				Rt		coproc		opc1		CRm									

```
if coproc IN "101x" then UNDEFINED;
t = UInt(Rt); t2 = UInt(Rt2); cp = UInt(coproc);
if t == 15 || t2 == 15 then UNPREDICTABLE;
if (t == 13 || t2 == 13) && (CurrentInstrSet() != InstrSet_ARM) then UNPREDICTABLE;
```

**Advanced SIMD and Floating-point**      See [64-bit transfers between ARM core and extension registers on page A7-279](#)

## Assembler syntax

MCRR{2}{<c>}{<q>} <coproc>, {#}<opc1>, <Rt>, <Rt2>, <CRm>

where:

- 2 If specified, selects encoding T2/A2. If omitted, selects encoding T1/A1.
- <c>, <q> See [Standard assembler syntax fields on page A8-287](#). An ARM MCRR2 instruction must be unconditional.
- <coproc> The name of the coprocessor.  
The generic coprocessor names are p0-p15.
- <opc1> Is a coprocessor-specific opcode in the range 0 to 15.
- <Rt> Is the first ARM core register whose value is transferred to the coprocessor.
- <Rt2> Is the second ARM core register whose value is transferred to the coprocessor.
- <CRm> Is the destination coprocessor register.

### ———— Note ————

The relative significance of Rt2 and Rt is IMPLEMENTATION DEFINED, but all uses within this manual treat Rt2 as more significant than Rt

## Operation

```
if ConditionPassed() then
    EncodingSpecificOperations();
    if !Cproc_Accepted(cp, ThisInstr()) then
        GenerateCoproprocessorException();
    else
        Cproc_SendTwoWords(R[t2], R[t], cp, ThisInstr());
```

## Exceptions

Undefined Instruction, Hyp Trap.

Uses of these instructions by specific coprocessors might generate other exceptions.

### A8.8.100 MLA

Multiply Accumulate multiplies two register values, and adds a third register value. The least significant 32 bits of the result are written to the destination register. These 32 bits do not depend on whether the source register values are considered to be signed values or unsigned values.

In an ARM instruction, the condition flags can optionally be updated based on the result. Use of this option adversely affects performance on many processor implementations.

#### Encoding T1 ARMv6T2, ARMv7

MLA<C> <Rd>, <Rn>, <Rm>, <Ra>

15	14	13	12	11	10	9	8	7	6	5	4	3	2	1	0	15	14	13	12	11	10	9	8	7	6	5	4	3	2	1	0
1	1	1	1	1	0	1	1	0	0	0	0	Rn				Ra				Rd				0	0	0	0	Rm			

```
if Ra == '1111' then SEE MUL;
d = UInt(Rd); n = UInt(Rn); m = UInt(Rm); a = UInt(Ra); setflags = FALSE;
if d IN {13,15} || n IN {13,15} || m IN {13,15} || a == 13 then UNPREDICTABLE;
```

#### Encoding A1 ARMv4\*, ARMv5T\*, ARMv6\*, ARMv7

MLA{S}<C> <Rd>, <Rn>, <Rm>, <Ra>

31	30	29	28	27	26	25	24	23	22	21	20	19	18	17	16	15	14	13	12	11	10	9	8	7	6	5	4	3	2	1	0
cond		0	0	0	0	0	0	1	S	Rd				Ra				Rm				1	0	0	1	Rn					

```
d = UInt(Rd); n = UInt(Rn); m = UInt(Rm); a = UInt(Ra); setflags = (S == '1');
if d == 15 || n == 15 || m == 15 || a == 15 then UNPREDICTABLE;
if ArchVersion() < 6 && d == n then UNPREDICTABLE;
```

## Assembler syntax

MLA{S}{<c>}{<q>} <Rd>, <Rn>, <Rm>, <Ra>

where:

S            If S is present, the instruction updates the flags. Otherwise, the flags are not updated.  
S can be specified only for the ARM instruction set.

<c>, <q>      See *Standard assembler syntax fields* on page A8-287.

<Rd>         The destination register.

<Rn>         The first operand register.

<Rm>         The second operand register.

<Ra>         The register containing the accumulate value.

The pre-UAL syntax MLA<c>S is equivalent to MLAS<c>.

## Operation

```
if ConditionPassed() then
    EncodingSpecificOperations();
    operand1 = SInt(R[n]); // operand1 = UInt(R[n]) produces the same final results
    operand2 = SInt(R[m]); // operand2 = UInt(R[m]) produces the same final results
    addend = SInt(R[a]); // addend = UInt(R[a]) produces the same final results
    result = operand1 * operand2 + addend;
    R[d] = result<31:0>;
    if setflags then
        APSR.N = result<31>;
        APSR.Z = IsZeroBit(result<31:0>);
        if ArchVersion() == 4 then
            APSR.C = bit UNKNOWN;
        // else APSR.C unchanged
        // APSR.V always unchanged
```

## Exceptions

None.

### A8.8.101 MLS

Multiply and Subtract multiplies two register values, and subtracts the product from a third register value. The least significant 32 bits of the result are written to the destination register. These 32 bits do not depend on whether the source register values are considered to be signed values or unsigned values.

#### Encoding T1 ARMv6T2, ARMv7

MLS<c> <Rd>, <Rn>, <Rm>, <Ra>

15	14	13	12	11	10	9	8	7	6	5	4	3	2	1	0	15	14	13	12	11	10	9	8	7	6	5	4	3	2	1	0
1	1	1	1	1	0	1	1	0	0	0	0	Rn				Ra		Rd		0			0	0	1	Rm					

d = UInt(Rd); n = UInt(Rn); m = UInt(Rm); a = UInt(Ra);  
if d IN {13,15} || n IN {13,15} || m IN {13,15} || a IN {13,15} then UNPREDICTABLE;

#### Encoding A1 ARMv6T2, ARMv7

MLS<c> <Rd>, <Rn>, <Rm>, <Ra>

31	30	29	28	27	26	25	24	23	22	21	20	19	18	17	16	15	14	13	12	11	10	9	8	7	6	5	4	3	2	1	0																		
cond		0				0				0				1				1				0				Rd				Ra		Rm		1			0			0			1			Rn			

d = UInt(Rd); n = UInt(Rn); m = UInt(Rm); a = UInt(Ra);  
if d == 15 || n == 15 || m == 15 || a == 15 then UNPREDICTABLE;

## Assembler syntax

MLS{<c>}{<q>} <Rd>, <Rn>, <Rm>, <Ra>

where:

<c>, <q> See *Standard assembler syntax fields* on page A8-287.

<Rd> The destination register.

<Rn> The first operand register.

<Rm> The second operand register.

<Ra> The register containing the accumulate value.

## Operation

```
if ConditionPassed() then
    EncodingSpecificOperations();
    operand1 = SInt(R[n]); // operand1 = UInt(R[n]) produces the same final results
    operand2 = SInt(R[m]); // operand2 = UInt(R[m]) produces the same final results
    addend = SInt(R[a]); // addend = UInt(R[a]) produces the same final results
    result = addend - operand1 * operand2;
    R[d] = result<31:0>;
```

## Exceptions

None.

### A8.8.102 MOV (immediate)

Move (immediate) writes an immediate value to the destination register. It can optionally update the condition flags based on the value.

**Encoding T1** ARMv4T, ARMv5T\*, ARMv6\*, ARMv7  
MOVS <Rd>, #<imm8> Outside IT block.  
MOV<c> <Rd>, #<imm8> Inside IT block.

15	14	13	12	11	10	9	8	7	6	5	4	3	2	1	0
0	0	1	0	0	Rd			imm8							

d = UInt(Rd); setflags = !InITBlock(); imm32 = ZeroExtend(imm8, 32); carry = APSR.C;

**Encoding T2** ARMv6T2, ARMv7  
MOV{S}<c>.W <Rd>, #<const>

15	14	13	12	11	10	9	8	7	6	5	4	3	2	1	0	15	14	13	12	11	10	9	8	7	6	5	4	3	2	1	0
1	1	1	1	0	i	0	0	0	1	0	S	1	1	1	1	0	imm3	Rd			imm8										

d = UInt(Rd); setflags = (S == '1'); (imm32, carry) = ThumbExpandImm\_C(i:imm3:imm8, APSR.C);  
if d IN {13,15} then UNPREDICTABLE;

**Encoding T3** ARMv6T2, ARMv7  
MOVW<c> <Rd>, #<imm16>

15	14	13	12	11	10	9	8	7	6	5	4	3	2	1	0	15	14	13	12	11	10	9	8	7	6	5	4	3	2	1	0
1	1	1	1	0	i	1	0	0	1	0	0	imm4			0	imm3	Rd			imm8											

d = UInt(Rd); setflags = FALSE; imm32 = ZeroExtend(imm4:i:imm3:imm8, 32);  
if d IN {13,15} then UNPREDICTABLE;

**Encoding A1** ARMv4\*, ARMv5T\*, ARMv6\*, ARMv7  
MOV{S}<c> <Rd>, #<const>

31	30	29	28	27	26	25	24	23	22	21	20	19	18	17	16	15	14	13	12	11	10	9	8	7	6	5	4	3	2	1	0
cond		0	0	1	1	1	0	1	S	(0)	(0)	(0)	(0)	Rd			imm12														

if Rd == '1111' && S == '1' then SEE SUBS PC, LR and related instructions;  
d = UInt(Rd); setflags = (S == '1'); (imm32, carry) = ARMEExpandImm\_C(imm12, APSR.C);

**Encoding A2** ARMv6T2, ARMv7  
MOVW<c> <Rd>, #<imm16>

31	30	29	28	27	26	25	24	23	22	21	20	19	18	17	16	15	14	13	12	11	10	9	8	7	6	5	4	3	2	1	0
cond		0	0	1	1	0	0	0	0	imm4			Rd			imm12															

d = UInt(Rd); setflags = FALSE; imm32 = ZeroExtend(imm4:imm12, 32);  
if d == 15 then UNPREDICTABLE;



## Assembler syntax

MOV{S}{<c>}{<q>} <Rd>, #<const> All encodings permitted  
MOVW{<c>}{<q>} <Rd>, #<const> Only encoding T3 or A2 permitted

where:

S If S is present, the instruction updates the flags. Otherwise, the flags are not updated.

<c>, <q> See [Standard assembler syntax fields on page A8-287](#).

<Rd> The destination register. If S is specified and <Rd> is the PC, see [SUBS PC, LR \(Thumb\) on page B9-2008](#) or [SUBS PC, LR and related instructions \(ARM\) on page B9-2010](#).

In ARM instructions, if S is not specified and <Rd> is the PC, encoding A2 is not permitted, and for encoding A1 the instruction is a branch to the address calculated by the operation. This is an interworking branch, see [Pseudocode details of operations on ARM core registers on page A2-47](#).

### ———— Note —————

Before ARMv7, this was a simple branch.

<const> The immediate value to be placed in <Rd>. The range of values is 0-255 for encoding T1 and 0-65535 for encoding T3 or A2. See [Modified immediate constants in Thumb instructions on page A6-232](#) or [Modified immediate constants in ARM instructions on page A5-200](#) for the range of values for encoding T2 or A1.

When both 32-bit encodings are available for an instruction, encoding T2 or A1 is preferred to encoding T3 or A2 (if encoding T3 or A2 is required, use the MOVW syntax).

The pre-UAL syntax MOV<c>S is equivalent to MOV<c>.

## Operation

```
if ConditionPassed() then
    EncodingSpecificOperations();
    result = imm32;
    if d == 15 then // Can only occur for encoding A1
        ALUWritePC(result); // setflags is always FALSE here
    else
        R[d] = result;
        if setflags then
            APSR.N = result<31>;
            APSR.Z = IsZeroBit(result);
            APSR.C = carry;
            // APSR.V unchanged
```

## Exceptions

None.

### A8.8.103 MOV (register, Thumb)

Move (register) copies a value from a register to the destination register. It can optionally update the condition flags based on the value.

**Encoding T1** ARMv6\*, ARMv7 if <Rd> and <Rm> both from R0-R7  
ARMv4T, ARMv5T\*, ARMv6\*, ARMv7 otherwise

MOV<C> <Rd>, <Rm> If <Rd> is the PC, must be outside or last in IT block.

15	14	13	12	11	10	9	8	7	6	5	4	3	2	1	0
0	1	0	0	0	1	1	0	D	Rm				Rd		

d = UInt(D:Rd); m = UInt(Rm); setflags = FALSE;  
if d == 15 && InITBlock() && !LastInITBlock() then UNPREDICTABLE;

**Encoding T2** ARMv4T, ARMv5T\*, ARMv6\*, ARMv7

MOVS <Rd>, <Rm> Not permitted in IT block

15	14	13	12	11	10	9	8	7	6	5	4	3	2	1	0	
0	0	0	0	0	0	0	0	0	0	Rm				Rd		

d = UInt(Rd); m = UInt(Rm); setflags = TRUE;  
if InITBlock() then UNPREDICTABLE;

**Encoding T3** ARMv6T2, ARMv7

MOV{S}<C>.W <Rd>, <Rm>

15	14	13	12	11	10	9	8	7	6	5	4	3	2	1	0	15	14	13	12	11	10	9	8	7	6	5	4	3	2	1	0
1	1	1	0	1	0	1	0	0	1	0	S	1	1	1	1	(0)	0	0	0	Rd				Rm							

d = UInt(Rd); m = UInt(Rm); setflags = (S == '1');  
if setflags && (d IN {13,15} || m IN {13,15}) then UNPREDICTABLE;  
if !setflags && (d == 15 || m == 15 || (d == 13 && m == 13)) then UNPREDICTABLE;

## Assembler syntax

MOV{S}{<c>}{<q>} <Rd>, <Rm>

where:

- S If S is present, the instruction updates the flags. Otherwise, the flags are not updated.
- <c>, <q> See [Standard assembler syntax fields on page A8-287](#).
- <Rd> The destination register. This register can be the SP or PC. S must not be specified if <Rd> is the SP. If <Rd> is the PC and S is not specified:
  - The instruction causes a branch to the address moved to the PC. This is a simple branch, see [Pseudocode details of operations on ARM core registers on page A2-47](#).
  - The instruction must either be outside an IT block or the last instruction of an IT block.
- <Rm> The source register. This register can be the SP or PC. S must not be specified if <Rm> is the SP or PC.

Encoding T3 is not permitted if:

- <Rd> or <Rm> is the PC
- both <Rd> and <Rm> are the SP.

### ————— Note —————

- ARM deprecates the use of the following MOV (register) instructions:
  - ones in which <Rd> is the SP or PC and <Rm> is also the SP or PC
  - ones in which S is specified and <Rm> is the SP, or <Rm> is the PC.
- See also [Changing between Thumb state and ARM state on page A4-160](#) about the use of the MOV PC, LR instruction.

The pre-UAL syntax MOV<c>S is equivalent to MOV<c>.

## Operation

```

if ConditionPassed() then
    EncodingSpecificOperations();
    result = R[m];
    if d == 15 then
        ALUWritePC(result); // setflags is always FALSE here
    else
        R[d] = result;
        if setflags then
            APSR.N = result<31>;
            APSR.Z = IsZeroBit(result);
            // APSR.C unchanged
            // APSR.V unchanged
    
```

## Exceptions

None.

### A8.8.104 MOV (register, ARM)

Move (register) copies a value from a register to the destination register. It can optionally update the condition flags based on the value.

**Encoding A1** ARMv4\*, ARMv5T\*, ARMv6\*, ARMv7

MOV{S}<c> <Rd>, <Rm>

31	30	29	28	27	26	25	24	23	22	21	20	19	18	17	16	15	14	13	12	11	10	9	8	7	6	5	4	3	2	1	0
cond				0	0	0	1	1	0	1	S	(0)	(0)	(0)	(0)	Rd				0	0	0	0	0	0	0	0	Rm			

if Rd == '1111' && S == '1' then SEE SUBS PC, LR and related instructions;  
d = UInt(Rd); m = UInt(Rm); setflags = (S == '1');

## Assembler syntax

MOV{S}{<C>}{<q>} <Rd>, <Rm>

where:

S If S is present, the instruction updates the flags. Otherwise, the flags are not updated.

<C>, <q> See *Standard assembler syntax fields* on page A8-287.

<Rd> The destination register. If S is specified and <Rd> is the PC, see *SUBS PC, LR and related instructions (ARM)* on page B9-2010. This register can be the SP or PC.

If <Rd> is the PC and S is not specified, the instruction causes a branch to the address moved to the PC. This is an interworking branch, see *Pseudocode details of operations on ARM core registers* on page A2-47.

———— **Note** —————

Before ARMv7, this was a simple branch.

<Rm> The source register. This register can be the SP or PC.

———— **Note** —————

- ARM deprecates the use of the following MOV (register) instructions:
  - ones in which <Rd> is the SP or PC and <Rm> is also the SP or PC
  - ones in which S is specified and <Rd> is the SP, <Rm> is the SP, or <Rm> is the PC.
- See also *Changing between Thumb state and ARM state* on page A4-160 about the use of the MOV PC, LR instruction.

The pre-UAL syntax MOV<C>S is equivalent to MOV{S}{<C>}.

## Operation

```
if ConditionPassed() then
    EncodingSpecificOperations();
    result = R[m];
    if d == 15 then
        ALUWritePC(result); // setflags is always FALSE here
    else
        R[d] = result;
        if setflags then
            APSR.N = result<31>;
            APSR.Z = IsZeroBit(result);
            // APSR.C unchanged
            // APSR.V unchanged
```

## Exceptions

None.

### A8.8.105 MOV (shifted register)

For the special case of MOV<sub>S</sub> where <Rd> is the PC, see *SUBS PC, LR (Thumb)* on page B9-2008 and *SUBS PC, LR and related instructions (ARM)* on page B9-2010. Otherwise, MOV (shifted register) is a pseudo-instruction for ASR, LSL, LSR, ROR, and RRX. For more information see the following sections:

- [ASR \(immediate\)](#) on page A8-330
- [ASR \(register\)](#) on page A8-332
- [LSL \(immediate\)](#) on page A8-468
- [LSL \(register\)](#) on page A8-470
- [LSR \(immediate\)](#) on page A8-472
- [LSR \(register\)](#) on page A8-474
- [ROR \(immediate\)](#) on page A8-568
- [ROR \(register\)](#) on page A8-570
- [RRX](#) on page A8-572.

#### Assembler syntax

Table A8-3 shows the equivalences between MOV (shifted register) and other instructions.

**Table A8-3 MOV (shifted register) equivalences**

MOV instruction	Canonical form
MOV{S} <Rd>, <Rm>, ASR #<n>	ASR{S} <Rd>, <Rm>, #<n>
MOV{S} <Rd>, <Rm>, LSL #<n>	LSL{S} <Rd>, <Rm>, #<n>
MOV{S} <Rd>, <Rm>, LSR #<n>	LSR{S} <Rd>, <Rm>, #<n>
MOV{S} <Rd>, <Rm>, ROR #<n>	ROR{S} <Rd>, <Rm>, #<n>
MOV{S} <Rd>, <Rm>, ASR <Rs>	ASR{S} <Rd>, <Rm>, <Rs>
MOV{S} <Rd>, <Rm>, LSL <Rs>	LSL{S} <Rd>, <Rm>, <Rs>
MOV{S} <Rd>, <Rm>, LSR <Rs>	LSR{S} <Rd>, <Rm>, <Rs>
MOV{S} <Rd>, <Rm>, ROR <Rs>	ROR{S} <Rd>, <Rm>, <Rs>
MOV{S} <Rd>, <Rm>, RRX	RRX{S} <Rd>, <Rm>

Disassembly produces the canonical form of the instruction.

#### Exceptions

None.

## A8.8.106 MOV<sup>T</sup>

Move Top writes an immediate value to the top halfword of the destination register. It does not affect the contents of the bottom halfword.

### Encoding T1 ARMv6T2, ARMv7

MOV<sup>T</sup><c> <Rd>, #<imm16>

15	14	13	12	11	10	9	8	7	6	5	4	3	2	1	0	15	14	13	12	11	10	9	8	7	6	5	4	3	2	1	0
1	1	1	1	0	i	1	0	1	1	0	0	imm4				0	imm3			Rd			imm8								

```
d = UInt(Rd); imm16 = imm4:i:imm3:imm8;
if d IN {13,15} then UNPREDICTABLE;
```

### Encoding A1 ARMv6T2, ARMv7

MOV<sup>T</sup><c> <Rd>, #<imm16>

31	30	29	28	27	26	25	24	23	22	21	20	19	18	17	16	15	14	13	12	11	10	9	8	7	6	5	4	3	2	1	0		
cond		0		0		1		1		0		1		0		0		imm4				Rd				imm12							

```
d = UInt(Rd); imm16 = imm4:imm12;
if d == 15 then UNPREDICTABLE;
```

### Assembler syntax

MOV<sup>T</sup>{<c>}{<q>} <Rd>, #<imm16>

where:

- <c>, <q> See [Standard assembler syntax fields on page A8-287](#).
- <Rd> The destination register.
- <imm16> The immediate value to be written to <Rd>. It must be in the range 0-65535.

### Operation

```
if ConditionPassed() then
    EncodingSpecificOperations();
    R[d]<31:16> = imm16;
    // R[d]<15:0> unchanged
```

### Exceptions

None.

### A8.8.107 MRC, MRC2

Move to ARM core register from Coprocessor causes a coprocessor to transfer a value to an ARM core register or to the condition flags. If no coprocessor can execute the instruction, an Undefined Instruction exception is generated.

This is a generic coprocessor instruction. Some of the fields have no functionality defined by the architecture and are free for use by the coprocessor instruction set designer. These are the *opc1*, *opc2*, *CRn*, and *CRm* fields. However, coprocessors CP8-CP15 are reserved for use by ARM, and this manual defines the valid MRC and MRC2 instructions when *coproc* is in the range p8-p15. For more information see [Coprocesor support on page A2-94](#).

In an implementation that includes the Virtualization Extensions, MRC accesses to system control registers can be trapped to Hyp mode, meaning that an attempt to execute an MRC instruction in a Non-secure mode other than Hyp mode, that would be permitted in the absence of the Hyp trap controls, generates a Hyp Trap exception. For more information, see [Traps to the hypervisor on page B1-1247](#).

———— **Note** —————

Because of the range of possible traps to Hyp mode, the MRC pseudocode does not show these possible traps.

**Encoding T1/A1** ARMv6T2, ARMv7 for encoding T1  
ARMv4\*, ARMv5T\*, ARMv6\*, ARMv7 for encoding A1

MRC<c> <coproc>, <opc1>, <Rt>, <CRn>, <CRm>{, <opc2>}

15	14	13	12	11	10	9	8	7	6	5	4	3	2	1	0	15	14	13	12	11	10	9	8	7	6	5	4	3	2	1	0
1	1	1	0	1	1	1	0	opc1	1	CRn	Rt	coproc	opc2	1	CRm																

31	30	29	28	27	26	25	24	23	22	21	20	19	18	17	16	15	14	13	12	11	10	9	8	7	6	5	4	3	2	1	0
cond	1	1	1	0	opc1	1	CRn	Rt	coproc	opc2	1	CRm																			

```
if coproc IN "101x" then SEE "Advanced SIMD and Floating-point";
t = UInt(Rt); cp = UInt(coproc);
if t == 13 && (CurrentInstrSet() != InstrSet_ARM) then UNPREDICTABLE;
```

**Encoding T2/A2** ARMv6T2, ARMv7 for encoding T2  
ARMv5T\*, ARMv6\*, ARMv7 for encoding A2

MRC2<c> <coproc>, <opc1>, <Rt>, <CRn>, <CRm>{, <opc2>}

15	14	13	12	11	10	9	8	7	6	5	4	3	2	1	0	15	14	13	12	11	10	9	8	7	6	5	4	3	2	1	0
1	1	1	1	1	1	1	0	opc1	1	CRn	Rt	coproc	opc2	1	CRm																

31	30	29	28	27	26	25	24	23	22	21	20	19	18	17	16	15	14	13	12	11	10	9	8	7	6	5	4	3	2	1	0
1	1	1	1	1	1	1	0	opc1	1	CRn	Rt	coproc	opc2	1	CRm																

```
if coproc IN "101x" then UNDEFINED;
t = UInt(Rt); cp = UInt(coproc);
if t == 13 && (CurrentInstrSet() != InstrSet_ARM) then UNPREDICTABLE;
```

**Advanced SIMD and Floating-point**

See [8](#), [16](#), and [32-bit transfer between ARM core and extension registers on page A7-278](#)



## Assembler syntax

MRC{2}{<c>}{<q>} <coproc>, {#}<opc1>, <Rt>, <CRn>, <CRm>{, {#}<opc2>}

where:

- 2            If specified, selects encoding T2/A2. If omitted, selects encoding T1/A1.
- <c>, <q>     See *Standard assembler syntax fields on page A8-287*. An ARM MRC2 instruction must be unconditional.
- <coproc>    The name of the coprocessor. The generic coprocessor names are p0-p15.
- <opc1>      Is a coprocessor-specific opcode in the range 0 to 7.
- <Rt>        Is the destination ARM core register. This register can be R0-R14 or APSR\_nzcv. The last form writes bits[31:28] of the transferred value to the N, Z, C and V condition flags and is specified by setting the Rt field of the encoding to 0b1111. In pre-UAL assembler syntax, PC was written instead of APSR\_nzcv to select this form.
- <CRn>      Is the coprocessor register that contains the first operand.
- <CRm>      Is an additional source or destination coprocessor register.
- <opc2>      Is a coprocessor-specific opcode in the range 0 to 7. If omitted, <opc2> is assumed to be 0.

## Operation

```

if ConditionPassed() then
    EncodingSpecificOperations();
    if !Coprocc_Accepted(cp, ThisInstr()) then
        GenerateCoproccorException();
    else
        value = Coproc_GetOneWord(cp, ThisInstr());
        if t != 15 then
            R[t] = value;
        else
            APSR.N = value<31>;
            APSR.Z = value<30>;
            APSR.C = value<29>;
            APSR.V = value<28>;
            // value<27:0> are not used.

```

## Exceptions

Undefined Instruction, Hyp Trap.

Uses of these instructions by specific coprocessors might generate other exceptions.

## A8.8.108 MRRC, MRRC2

Move to two ARM core registers from Coprocessor causes a coprocessor to transfer values to two ARM core registers. If no coprocessor can execute the instruction, an Undefined Instruction exception is generated.

This is a generic coprocessor instruction. Some of the fields have no functionality defined by the architecture and are free for use by the coprocessor instruction set designer. These are the `opc1` and `CRm` fields. However, coprocessors CP8-CP15 are reserved for use by ARM, and this manual defines the valid MRRC and MRRC2 instructions when `coproc` is in the range p8-p15. For more information see [Coprocessor support on page A2-94](#).

In an implementation that includes the Virtualization Extensions, MRRC accesses to system control registers can be trapped to Hyp mode, meaning that an attempt to execute an MRRC instruction in a Non-secure mode other than Hyp mode, that would be permitted in the absence of the Hyp trap controls, generates a Hyp Trap exception. For more information, see [Traps to the hypervisor on page B1-1247](#).

### ———— Note —————

Because of the range of possible traps to Hyp mode, the MRRC pseudocode does not show these possible traps.

**Encoding T1/A1**      ARMv6T2, ARMv7 for encoding T1  
ARMv5TE\*, ARMv6\*, ARMv7 for encoding A1

MRRC<c> <coproc>, <opc>, <Rt>, <Rt2>, <CRm>

15	14	13	12	11	10	9	8	7	6	5	4	3	2	1	0	15	14	13	12	11	10	9	8	7	6	5	4	3	2	1	0																																																														
1	1	1	0	1	1	0	0	0	1	0	1					Rt2															Rt															coproc																opc1																CRm															

31	30	29	28	27	26	25	24	23	22	21	20	19	18	17	16	15	14	13	12	11	10	9	8	7	6	5	4	3	2	1	0																																																																																																																																																																																																					
																																	cond																																Rt2																																Rt																																	coproc																																	opc1																																	CRm																																

```
if coproc IN "101x" then SEE "Advanced SIMD and Floating-point";
t = UInt(Rt); t2 = UInt(Rt2); cp = UInt(coproc);
if t == 15 || t2 == 15 || t == t2 then UNPREDICTABLE;
if (t == 13 || t2 == 13) && (CurrentInstrSet() != InstrSet_ARM) then UNPREDICTABLE;
```

**Encoding T2/A2**      ARMv6T2, ARMv7 for encoding T2  
ARMv6\*, ARMv7 for encoding A2

MRRC2<c> <coproc>, <opc>, <Rt>, <Rt2>, <CRm>

15	14	13	12	11	10	9	8	7	6	5	4	3	2	1	0	15	14	13	12	11	10	9	8	7	6	5	4	3	2	1	0																																																																		
1	1	1	1	1	1	0	0	0	1	0	1					Rt2																Rt																coproc																opc1																	CRm																

31	30	29	28	27	26	25	24	23	22	21	20	19	18	17	16	15	14	13	12	11	10	9	8	7	6	5	4	3	2	1	0																																																																																																																																																																																																					
																																	cond																																Rt2																																Rt																																	coproc																																	opc1																																	CRm																																

```
if coproc IN "101x" then UNDEFINED;
t = UInt(Rt); t2 = UInt(Rt2); cp = UInt(coproc);
if t == 15 || t2 == 15 || t == t2 then UNPREDICTABLE;
if (t == 13 || t2 == 13) && (CurrentInstrSet() != InstrSet_ARM) then UNPREDICTABLE;
```

**Advanced SIMD and Floating-point**      See [64-bit transfers between ARM core and extension registers on page A7-279](#)

## Assembler syntax

MRRC{2}{<c>}{<q>} <coproc>, {#}<opc1>, <Rt>, <Rt2>, <CRm>

where:

- 2 If specified, selects encoding T2/A2. If omitted, selects encoding T1/A1.
- <c>, <q> See [Standard assembler syntax fields on page A8-287](#). An ARM MRRC2 instruction must be unconditional.
- <coproc> The name of the coprocessor. The generic coprocessor names are p0-p15.
- <opc1> Is a coprocessor-specific opcode in the range 0 to 15.
- <Rt> Is the first destination ARM core register.
- <Rt2> Is the second destination ARM core register.
- <CRm> Is the coprocessor register that supplies the data to be transferred.

---

### Note

---

The relative significance of Rt2 and Rt is IMPLEMENTATION DEFINED, but all uses within this manual treat Rt2 as more significant than Rt

---

## Operation

```
if ConditionPassed() then
    EncodingSpecificOperations();
    if !Coprocc_Accepted(cp, ThisInstr()) then
        GenerateCoproccorException();
    else
        (R[t2], R[t]) = Coproc_GetTwoWords(cp, ThisInstr());
```

## Exceptions

Undefined Instruction, Hyp Trap.

Uses of these instructions by specific coprocessors might generate other exceptions.

### A8.8.109 MRS

Move to Register from Special register moves the value from the APSR into an ARM core register.

For details of system level use of this instruction, see [MRS on page B9-1988](#).

#### Encoding T1 ARMv6T2, ARMv7

MRS<c> <Rd>, <spec\_reg>

15	14	13	12	11	10	9	8	7	6	5	4	3	2	1	0	15	14	13	12	11	10	9	8	7	6	5	4	3	2	1	0
1	1	1	1	0	0	1	1	1	1	1	0	(1)	(1)	(1)	(1)	1	0	(0)	0	Rd	(0)	(0)	0	(0)	(0)	(0)	(0)	(0)			

d = UInt(Rd);  
if d IN {13,15} then UNPREDICTABLE;

#### Encoding A1 ARMv4\*, ARMv5T\*, ARMv6\*, ARMv7

MRS<c> <Rd>, <spec\_reg>

31	30	29	28	27	26	25	24	23	22	21	20	19	18	17	16	15	14	13	12	11	10	9	8	7	6	5	4	3	2	1	0
cond		0	0	0	1	0	0	0	0	(1)	(1)	(1)	(1)	Rd	(0)	(0)	0	(0)	0	0	0	0	(0)	(0)	(0)	(0)	(0)	(0)	(0)	(0)	

d = UInt(Rd);  
if d == 15 then UNPREDICTABLE;

## Assembler syntax

MRS{<c>}{<q>} <Rd>, <spec\_reg>

where:

<c>, <q> See [Standard assembler syntax fields](#) on page A8-287.

<Rd> The destination register.

<spec\_reg> Is one of:

- APSR
- CPSR.

When the MRS instruction is executed in User mode, CPSR is treated as a synonym of APSR.

ARM recommends that application level software uses the APSR form. For more information, see [The Application Program Status Register \(APSR\)](#) on page A2-49.

## Operation

```
if ConditionPassed() then
    EncodingSpecificOperations();
    R[d] = APSR;
```

## Exceptions

None.

**A8.8.110 MRS (Banked register)**

Move to Register from Banked or Special register is a system instruction, see [MRS \(Banked register\)](#) on page B9-1990.

**A8.8.111 MSR (immediate)**

Move immediate value to Special register moves selected bits of an immediate value to the corresponding bits in the APSR.

For details of system level use of this instruction, see [MSR \(immediate\)](#) on page B9-1994.

**Encoding A1** ARMv4\*, ARMv5T\*, ARMv6\*, ARMv7

MSR<c> <spec\_reg>, #<const>

31	30	29	28	27	26	25	24	23	22	21	20	19	18	17	16	15	14	13	12	11	10	9	8	7	6	5	4	3	2	1	0
cond		0	0	1	1	0	0	1	0	mask	0	0	(1)	(1)	(1)	(1)	imm12														

if mask == '00' then SEE "Related encodings";  
imm32 = ARMEExpandImm(imm12); write\_nzcvq = (mask<1> == '1'); write\_g = (mask<0> == '1');

**Related encodings** See [MSR \(immediate\)](#), and [hints](#) on page A5-206.

## Assembler syntax

MSR{<c>}{<q>} <spec\_reg>, #<imm>

where:

<c>, <q>	See <i>Standard assembler syntax fields</i> on page A8-287.
<spec_reg>	Is one of: <ul style="list-style-type: none"> <li>APSR_&lt;bits&gt;</li> <li>CPSR_&lt;fields&gt;.</li> </ul> ARM recommends that application level software uses the APSR forms. For more information, see <i>The Application Program Status Register (APSR)</i> on page A2-49.
<imm>	Is the immediate value to be transferred to <spec_reg>. See <i>Modified immediate constants in ARM instructions</i> on page A5-200 for the range of values.
<bits>	Is one of nzcvcq, g, or nzcvcqg. In the A and R profiles: <ul style="list-style-type: none"> <li>APSR_nzcvcq is the same as CPSR_f</li> <li>APSR_g is the same as CPSR_s</li> <li>APSR_nzcvcqg is the same as CPSR_fs.</li> </ul>
<fields>	Is a sequence of one or more of the following: s, f.

## Operation

```

if ConditionPassed() then
    EncodingSpecificOperations();
    if write_nzcvcq then
        APSR.N = imm32<31>;
        APSR.Z = imm32<30>;
        APSR.C = imm32<29>;
        APSR.V = imm32<28>;
        APSR.Q = imm32<27>;
    if write_g then
        APSR.GE = imm32<19:16>;

```

## Exceptions

None.

## Usage

For details of the APSR see *The Application Program Status Register (APSR)* on page A2-49. Because of the Do-Not-Modify nature of its reserved bits, the immediate form of MSR is normally only useful at the Application level for writing to APSR\_nzcvcq (CPSR\_f).

For the A and R profiles, *MSR (immediate)* on page B9-1994 describes additional functionality that is available using the reserved bits. This includes some deprecated functionality that is also available to unprivileged software and therefore can be used at the Application level.

### A8.8.112 MSR (register)

Move to Special register from ARM core register moves selected bits of an ARM core register to the APSR.

For details of system level use of this instruction, see *MSR (register)* on page B9-1996.

#### Encoding T1 ARMv6T2, ARMv7

MSR<c> <spec\_reg>, <Rn>

15	14	13	12	11	10	9	8	7	6	5	4	3	2	1	0	15	14	13	12	11	10	9	8	7	6	5	4	3	2	1	0
1	1	1	1	0	0	1	1	1	0	0	0	Rn	1	0	(0)	0	mask	0	0	(0)	(0)	0	(0)	(0)	(0)	(0)	(0)	(0)			

n = UInt(Rn); write\_nzcvq = (mask<1> == '1'); write\_g = (mask<0> == '1');  
if mask == '00' then UNPREDICTABLE;  
if n IN {13,15} then UNPREDICTABLE;

#### Encoding A1 ARMv4\*, ARMv5T\*, ARMv6\*, ARMv7

MSR<c> <spec\_reg>, <Rn>

31	30	29	28	27	26	25	24	23	22	21	20	19	18	17	16	15	14	13	12	11	10	9	8	7	6	5	4	3	2	1	0
cond	0	0	0	1	0	0	1	0	mask	0	0	(1)	(1)	(1)	(1)	(0)	(0)	0	(0)	0	0	0	0	0	0	0	0	Rn			

n = UInt(Rn); write\_nzcvq = (mask<1> == '1'); write\_g = (mask<0> == '1');  
if mask == '00' then UNPREDICTABLE;  
if n == 15 then UNPREDICTABLE;



## Assembler syntax

MSR{<c>}{<q>} <spec\_reg>, <Rn>

where:

<c>, <q> See [Standard assembler syntax fields on page A8-287](#).

<spec\_reg> Is one of:

- APSR\_<bits>
- CPSR\_<fields>.

ARM recommends that application level software uses the APSR form. For more information, see [The Application Program Status Register \(APSR\) on page A2-49](#).

<Rn> Is the ARM core register to be transferred to <spec\_reg>.

<bits> Is one of nzcvcq, g, or nzcvcqg.

In the A and R profiles:

- APSR\_nzcvcq is the same as CPSR\_f
- APSR\_g is the same as CPSR\_s
- APSR\_nzcvcqg is the same as CPSR\_fs.

<fields> Is a sequence of one or more of the following: s, f.

## Operation

```
if ConditionPassed() then
    EncodingSpecificOperations();
    if write_nzcvcq then
        APSR.N = R[n]<31>;
        APSR.Z = R[n]<30>;
        APSR.C = R[n]<29>;
        APSR.V = R[n]<28>;
        APSR.Q = R[n]<27>;
    if write_g then
        APSR.GE = R[n]<19:16>;
```

## Exceptions

None.

## Usage

For details of the APSR see [The Application Program Status Register \(APSR\) on page A2-49](#). Because of the Do-Not-Modify nature of its reserved bits, a read-modify-write sequence is normally needed when the MSR instruction is being used at Application level and its destination is not APSR\_nzcvcq (CPSR\_f).

For the A and R profiles, [MSR \(register\) on page B9-1996](#) describes additional functionality that is available using the reserved bits. This includes some deprecated functionality that is also available to unprivileged software and therefore can be used at the Application level.

### A8.8.113 MSR (Banked register)

Move to Banked or Special register from ARM core register is a system instruction, see [MSR \(Banked register\)](#) on page B9-1992.

### A8.8.114 MUL

Multiply multiplies two register values. The least significant 32 bits of the result are written to the destination register. These 32 bits do not depend on whether the source register values are considered to be signed values or unsigned values.

Optionally, it can update the condition flags based on the result. In the Thumb instruction set, this option is limited to only a few forms of the instruction. Use of this option adversely affects performance on many processor implementations.

#### Encoding T1 ARMv4T, ARMv5T\*, ARMv6\*, ARMv7

MULS <Rdm>, <Rn>, <Rdm> Outside IT block.  
MUL<C> <Rdm>, <Rn>, <Rdm> Inside IT block.

15	14	13	12	11	10	9	8	7	6	5	4	3	2	1	0
0	1	0	0	0	0	1	1	0	1	Rn			Rdm		

d = UInt(Rdm); n = UInt(Rn); m = UInt(Rdm); setFlags = !InITBlock();  
if ArchVersion() < 6 && d == n then UNPREDICTABLE;

#### Encoding T2 ARMv6T2, ARMv7

MUL<C> <Rd>, <Rn>, <Rm>

15	14	13	12	11	10	9	8	7	6	5	4	3	2	1	0	15	14	13	12	11	10	9	8	7	6	5	4	3	2	1	0
1	1	1	1	1	0	1	1	0	0	0	Rn			1	1	1	1	Rd			0	0	0	0	Rm						

d = UInt(Rd); n = UInt(Rn); m = UInt(Rm); setFlags = FALSE;  
if d IN {13,15} || n IN {13,15} || m IN {13,15} then UNPREDICTABLE;

#### Encoding A1 ARMv4\*, ARMv5T\*, ARMv6\*, ARMv7

MUL{S}<C> <Rd>, <Rn>, <Rm>

31	30	29	28	27	26	25	24	23	22	21	20	19	18	17	16	15	14	13	12	11	10	9	8	7	6	5	4	3	2	1	0
cond		0	0	0	0	0	0	0	S	Rd			(0)	(0)	(0)	(0)	Rm			1	0	0	1	Rn							

d = UInt(Rd); n = UInt(Rn); m = UInt(Rm); setFlags = (S == '1');  
if d == 15 || n == 15 || m == 15 then UNPREDICTABLE;  
if ArchVersion() < 6 && d == n then UNPREDICTABLE;

## Assembler syntax

MUL{S}{<c>}{<q>} <Rd>, <Rn>{, <Rm>}

where:

S If S is present, the instruction updates the flags. Otherwise, the flags are not updated.  
In the Thumb instruction set, S can be specified only if both <Rn> and <Rm> are R0-R7 and the instruction is outside an IT block.

<c>, <q> See *Standard assembler syntax fields on page A8-287*.

<Rd> The destination register.

<Rn> The first operand register.

<Rm> The second operand register. If omitted, <Rd> is used.

### ————— Note —————

Issues A and B of this document showed the MUL syntax as MUL{S}{<c>}{<q>} {<Rd>, }<Rn>, <Rm>. The <Rm> register is now made optional because omitting <Rd> can generate UNPREDICTABLE instructions in some cases. Some assembler versions might not support this revised specification.

The pre-UAL syntax MUL<c>S is equivalent to MULS<c>.

## Operation

```
if ConditionPassed() then
    EncodingSpecificOperations();
    operand1 = SInt(R[n]); // operand1 = UInt(R[n]) produces the same final results
    operand2 = SInt(R[m]); // operand2 = UInt(R[m]) produces the same final results
    result = operand1 * operand2;
    R[d] = result<31:0>;
    if setflags then
        APSR.N = result<31>;
        APSR.Z = IsZeroBit(result<31:0>);
        if ArchVersion() == 4 then
            APSR.C = bit UNKNOWN;
        // else APSR.C unchanged
        // APSR.V always unchanged
```

## Exceptions

None.

### A8.8.115 MVN (immediate)

Bitwise NOT (immediate) writes the bitwise inverse of an immediate value to the destination register. It can optionally update the condition flags based on the value.

#### Encoding T1 ARMv6T2, ARMv7

MVN{S}<c> <Rd>, #<const>

15	14	13	12	11	10	9	8	7	6	5	4	3	2	1	0	15	14	13	12	11	10	9	8	7	6	5	4	3	2	1	0
1	1	1	1	0	i	0	0	0	1	1	S	1	1	1	1	0	imm3	Rd	imm8												

```
d = UInt(Rd); setflags = (S == '1');
(imm32, carry) = ThumbExpandImm_C(i:imm3:imm8, APSR.C);
if d IN {13,15} then UNPREDICTABLE;
```

#### Encoding A1 ARMv4\*, ARMv5T\*, ARMv6\*, ARMv7

MVN{S}<c> <Rd>, #<const>

31	30	29	28	27	26	25	24	23	22	21	20	19	18	17	16	15	14	13	12	11	10	9	8	7	6	5	4	3	2	1	0
cond		0	0	1	1	1	1	S	(0)	(0)	(0)	(0)	Rd				imm12														

```
if Rd == '1111' && S == '1' then SEE SUBS PC, LR and related instructions;
d = UInt(Rd); setflags = (S == '1');
(imm32, carry) = ARMEExpandImm_C(imm12, APSR.C);
```

## Assembler syntax

MVN{S}{<c>}{<q>} <Rd>, #<const>

where:

S If S is present, the instruction updates the flags. Otherwise, the flags are not updated.

<c>, <q> See *Standard assembler syntax fields* on page A8-287.

<Rd> The destination register. If S is specified and <Rd> is the PC, see *SUBS PC, LR (Thumb)* on page B9-2008 or *SUBS PC, LR and related instructions (ARM)* on page B9-2010.

In ARM instructions, if S is not specified and <Rd> is the PC, the instruction is a branch to the address calculated by the operation. This is an interworking branch, see *Pseudocode details of operations on ARM core registers* on page A2-47.

———— **Note** —————

Before ARMv7, this was a simple branch.

<const> The immediate value to be bitwise inverted. See *Modified immediate constants in Thumb instructions* on page A6-232 or *Modified immediate constants in ARM instructions* on page A5-200 for the range of values.

The pre-UAL syntax MVN<c>S is equivalent to MVNS<c>.

## Operation

```

if ConditionPassed() then
    EncodingSpecificOperations();
    result = NOT(imm32);
    if d == 15 then // Can only occur for ARM encoding
        ALUWritePC(result); // setflags is always FALSE here
    else
        R[d] = result;
        if setflags then
            APSR.N = result<31>;
            APSR.Z = IsZeroBit(result);
            APSR.C = carry;
            // APSR.V unchanged
    
```

## Exceptions

None.

### A8.8.116 MVN (register)

Bitwise NOT (register) writes the bitwise inverse of a register value to the destination register. It can optionally update the condition flags based on the result.

**Encoding T1** ARMv4T, ARMv5T\*, ARMv6\*, ARMv7  
MVNS <Rd>, <Rm> Outside IT block.  
MVN<c> <Rd>, <Rm> Inside IT block.

15	14	13	12	11	10	9	8	7	6	5	4	3	2	1	0
0	1	0	0	0	0	1	1	1	1	Rm	Rd				

```
d = UInt(Rd); m = UInt(Rm); setflags = !InITBlock();
(shift_t, shift_n) = (SRTYPE_LSL, 0);
```

**Encoding T2** ARMv6T2, ARMv7  
MVN{S}<c>.W <Rd>, <Rm>{, <shift>}

15	14	13	12	11	10	9	8	7	6	5	4	3	2	1	0	15	14	13	12	11	10	9	8	7	6	5	4	3	2	1	0
1	1	1	0	1	0	1	0	0	1	1	S	1	1	1	1	(0)	imm3	Rd	imm2	type	Rm										

```
d = UInt(Rd); m = UInt(Rm); setflags = (S == '1');
(shift_t, shift_n) = DecodeImmShift(type, imm3:imm2);
if d IN {13,15} || m IN {13,15} then UNPREDICTABLE;
```

**Encoding A1** ARMv4\*, ARMv5T\*, ARMv6\*, ARMv7  
MVN{S}<c> <Rd>, <Rm>{, <shift>}

31	30	29	28	27	26	25	24	23	22	21	20	19	18	17	16	15	14	13	12	11	10	9	8	7	6	5	4	3	2	1	0
cond			0	0	0	1	1	1	1	S	(0)	(0)	(0)	(0)	Rd	imm5			type	0	Rm										

```
if Rd == '1111' && S == '1' then SEE SUBS PC, LR and related instructions;
d = UInt(Rd); m = UInt(Rm); setflags = (S == '1');
(shift_t, shift_n) = DecodeImmShift(type, imm5);
```

## Assembler syntax

MVN{S}{<c>}{<q>} <Rd>, <Rm> {, <shift>}

where:

- S                    If S is present, the instruction updates the flags. Otherwise, the flags are not updated.
- <c>, <q>            See *Standard assembler syntax fields* on page A8-287.
- <Rd>                The destination register. If S is specified and <Rd> is the PC, see *SUBS PC, LR (Thumb)* on page B9-2008 or *SUBS PC, LR and related instructions (ARM)* on page B9-2010.  
In ARM instructions, if S is not specified and <Rd> is the PC, the instruction is a branch to the address calculated by the operation. This is an interworking branch, see *Pseudocode details of operations on ARM core registers* on page A2-47.
- **Note** —————
- Before ARMv7, this was a simple branch.
- 
- <Rm>                The register that is optionally shifted and used as the source register. The PC can be used in ARM instructions.
- <shift>             The shift to apply to the value read from <Rm>. If present, encoding T1 is not permitted. If absent, no shift is applied and all encodings are permitted. *Shifts applied to a register* on page A8-291 describes the shifts and how they are encoded.

The pre-UAL syntax MVN<c>S is equivalent to MVNS<c>.

## Operation

```

if ConditionPassed() then
    EncodingSpecificOperations();
    (shifted, carry) = Shift_C(R[m], shift_t, shift_n, APSR.C);
    result = NOT(shifted);
    if d == 15 then // Can only occur for ARM encoding
        ALUWritePC(result); // setflags is always FALSE here
    else
        R[d] = result;
        if setflags then
            APSR.N = result<31>;
            APSR.Z = IsZeroBit(result);
            APSR.C = carry;
            // APSR.V unchanged

```

## Exceptions

None.

### A8.8.117 MVN (register-shifted register)

Bitwise NOT (register-shifted register) writes the bitwise inverse of a register-shifted register value to the destination register. It can optionally update the condition flags based on the result.

**Encoding A1** ARMv4\*, ARMv5T\*, ARMv6\*, ARMv7  
MVN{S}<c> <Rd>, <Rm>, <type> <Rs>

31	30	29	28	27	26	25	24	23	22	21	20	19	18	17	16	15	14	13	12	11	10	9	8	7	6	5	4	3	2	1	0
cond				0	0	0	1	1	1	1	S	(0)	(0)	(0)	(0)	Rd				Rs				0	type		1	Rm			

```
d = UInt(Rd); m = UInt(Rm); s = UInt(Rs);
setflags = (S == '1'); shift_t = DecodeRegShift(type);
if d == 15 || m == 15 || s == 15 then UNPREDICTABLE;
```



## Assembler syntax

MVN{S}{<c>}{<q>} <Rd>, <Rm>, <type> <Rs>

where:

S If S is present, the instruction updates the flags. Otherwise, the flags are not updated.

<c>, <q> See [Standard assembler syntax fields on page A8-287](#).

<Rd> The destination register.

<Rm> The register that is shifted and used as the operand.

<type> The type of shift to apply to the value read from <Rm>. It must be one of:

ASR Arithmetic shift right, encoded as type = 0b10.

LSL Logical shift left, encoded as type = 0b00.

LSR Logical shift right, encoded as type = 0b01.

ROR Rotate right, encoded as type = 0b11.

<Rs> The register whose bottom byte contains the amount to shift by.

The pre-UAL syntax MVN<c>S is equivalent to MVNS<c>.

## Operation

```
if ConditionPassed() then
    EncodingSpecificOperations();
    shift_n = UInt(R[s]<7:0>);
    (shifted, carry) = Shift_C(R[m], shift_t, shift_n, APSR.C);
    result = NOT(shifted);
    R[d] = result;
    if setflags then
        APSR.N = result<31>;
        APSR.Z = IsZeroBit(result);
        APSR.C = carry;
        // APSR.V unchanged
```

## Exceptions

None.

### A8.8.118 NEG

Negate is a pre-UAL synonym for RSB (immediate) with an immediate value of 0. For details see [RSB \(immediate\)](#) on page A8-574.

#### Assembler syntax

NEG{<c>}{<q>} <Rd>, <Rm>

This is equivalent to:

RSBS{<c>}{<q>} <Rd>, <Rm>, #0

#### Exceptions

None.

### A8.8.119 NOP

No Operation does nothing. This instruction can be used for instruction alignment purposes.

See [Pre-UAL pseudo-instruction NOP](#) on page AppxH-2472 for details of NOP before the introduction of UAL and the ARMv6K and ARMv6T2 architecture variants.

#### ———— Note ————

The timing effects of including a NOP instruction in a program are not guaranteed. It can increase execution time, leave it unchanged, or even reduce it. Therefore, NOP instructions are not suitable for timing loops.

#### Encoding T1 ARMv6T2, ARMv7

NOP<c>

15	14	13	12	11	10	9	8	7	6	5	4	3	2	1	0
1	0	1	1	1	1	1	1	0	0	0	0	0	0	0	0

// No additional decoding required

#### Encoding T2 ARMv6T2, ARMv7

NOP<c>.w

15	14	13	12	11	10	9	8	7	6	5	4	3	2	1	0	15	14	13	12	11	10	9	8	7	6	5	4	3	2	1	0
1	1	1	1	0	0	1	1	1	0	1	0	(1)	(1)	(1)	(1)	1	0	(0)	0	(0)	0	0	0	0	0	0	0	0	0		

// No additional decoding required

#### Encoding A1 ARMv6K, ARMv6T2, ARMv7

NOP<c>

31	30	29	28	27	26	25	24	23	22	21	20	19	18	17	16	15	14	13	12	11	10	9	8	7	6	5	4	3	2	1	0
cond	0	0	1	1	0	0	1	0	0	0	0	0	(1)	(1)	(1)	(1)	(0)	(0)	(0)	(0)	0	0	0	0	0	0	0	0	0	0	0

// No additional decoding required

## Assembler syntax

NOP{<c>}{<q>}

where:

{<c>}{<q>} See *Standard assembler syntax fields* on page A8-287.

## Operation

```
if ConditionPassed() then
    EncodingSpecificOperations();
    // Do nothing
```

## Exceptions

None.

### A8.8.120 ORN (immediate)

Bitwise OR NOT (immediate) performs a bitwise (inclusive) OR of a register value and the complement of an immediate value, and writes the result to the destination register. It can optionally update the condition flags based on the result.

**Encoding T1** ARMv6T2, ARMv7

ORN{S}<C> <Rd>, <Rn>, #<const>

15	14	13	12	11	10	9	8	7	6	5	4	3	2	1	0	15	14	13	12	11	10	9	8	7	6	5	4	3	2	1	0
1	1	1	1	0	i	0	0	0	1	1	S		Rn		0	imm3		Rd									imm8				

```

if Rn == '1111' then SEE MVN (immediate);
d = UInt(Rd); n = UInt(Rn); setflags = (S == '1');
(imm32, carry) = ThumbExpandImm_C(i:imm3:imm8, APSR.C);
if d IN {13,15} || n == 13 then UNPREDICTABLE;

```

## Assembler syntax

ORN{S}{<c>}{<q>} {<Rd>}, <Rn>, #<const>

where:

- S            If S is present, the instruction updates the flags. Otherwise, the flags are not updated.
- <c>, <q>    See [Standard assembler syntax fields on page A8-287](#).
- <Rd>        The destination register.
- <Rn>        The register that contains the operand.
- <const>    The immediate value to be bitwise inverted and ORed with the value obtained from <Rn>. See [Modified immediate constants in Thumb instructions on page A6-232](#) for the range of values.

## Operation

```
if ConditionPassed() then
    EncodingSpecificOperations();
    result = R[n] OR NOT(imm32);
    R[d] = result;
    if setflags then
        APSR.N = result<31>;
        APSR.Z = IsZeroBit(result);
        APSR.C = carry;
        // APSR.V unchanged
```

## Exceptions

None.

### A8.8.121 ORN (register)

Bitwise OR NOT (register) performs a bitwise (inclusive) OR of a register value and the complement of an optionally-shifted register value, and writes the result to the destination register. It can optionally update the condition flags based on the result.

**Encoding T1** ARMv6T2, ARMv7

ORN{S}<C> <Rd>, <Rn>, <Rm>{, <shift>}

15	14	13	12	11	10	9	8	7	6	5	4	3	2	1	0	15	14	13	12	11	10	9	8	7	6	5	4	3	2	1	0
1	1	1	0	1	0	1	0	0	1	1	S	Rn				(0)	imm3			Rd			imm2		type		Rm				

```

if Rn == '1111' then SEE MVN (register);
d = UInt(Rd); n = UInt(Rn); m = UInt(Rm); setflags = (S == '1');
(shift_t, shift_n) = DecodeImmShift(type, imm3:imm2);
if d IN {13,15} || n == 13 || m IN {13,15} then UNPREDICTABLE;

```

## Assembler syntax

ORN{S}{<c>}{<q>} {<Rd>}, <Rn>, <Rm> {, <shift>}

where:

- S            If S is present, the instruction updates the flags. Otherwise, the flags are not updated.
- <c>, <q>    See [Standard assembler syntax fields on page A8-287](#).
- <Rd>        The destination register.
- <Rn>        The first operand register.
- <Rm>        The register that is optionally shifted and used as the second operand.
- <shift>     The shift to apply to the value read from <Rm>. If omitted, no shift is applied. [Shifts applied to a register on page A8-291](#) describes the shifts and how they are encoded.

## Operation

```
if ConditionPassed() then
    EncodingSpecificOperations();
    (shifted, carry) = Shift_C(R[m], shift_t, shift_n, APSR.C);
    result = R[n] OR NOT(shifted);
    R[d] = result;
    if setflags then
        APSR.N = result<31>;
        APSR.Z = IsZeroBit(result);
        APSR.C = carry;
        // APSR.V unchanged
```

## Exceptions

None.

### A8.8.122 ORR (immediate)

Bitwise OR (immediate) performs a bitwise (inclusive) OR of a register value and an immediate value, and writes the result to the destination register. It can optionally update the condition flags based on the result.

#### Encoding T1 ARMv6T2, ARMv7

ORR{S}<c> <Rd>, <Rn>, #<const>

15	14	13	12	11	10	9	8	7	6	5	4	3	2	1	0	15	14	13	12	11	10	9	8	7	6	5	4	3	2	1	0
1	1	1	1	0	i	0	0	0	1	0	S	Rn				0	imm3			Rd			imm8								

```

if Rn == '1111' then SEE MOV (immediate);
d = UInt(Rd); n = UInt(Rn); setflags = (S == '1');
(imm32, carry) = ThumbExpandImm_C(i:imm3:imm8, APSR.C);
if d IN {13,15} || n == 13 then UNPREDICTABLE;

```

#### Encoding A1 ARMv4\*, ARMv5T\*, ARMv6\*, ARMv7

ORR{S}<c> <Rd>, <Rn>, #<const>

31	30	29	28	27	26	25	24	23	22	21	20	19	18	17	16	15	14	13	12	11	10	9	8	7	6	5	4	3	2	1	0
cond			0	0	1	1	1	0	0	S	Rn				Rd			imm12													

```

if Rd == '1111' && S == '1' then SEE SUBS PC, LR and related instructions;
d = UInt(Rd); n = UInt(Rn); setflags = (S == '1');
(imm32, carry) = ARMEExpandImm_C(imm12, APSR.C);

```



## Assembler syntax

ORR{S}{<c>}{<q>} {<Rd>}, <Rn>, #<const>

where:

- S            If S is present, the instruction updates the flags. Otherwise, the flags are not updated.
- <c>, <q>     See *Standard assembler syntax fields* on page A8-287.
- <Rd>        The destination register. If S is specified and <Rd> is the PC, see *SUBS PC, LR (Thumb)* on page B9-2008 or *SUBS PC, LR and related instructions (ARM)* on page B9-2010.  
In ARM instructions, if S is not specified and <Rd> is the PC, the instruction is a branch to the address calculated by the operation. This is an interworking branch, see *Pseudocode details of operations on ARM core registers* on page A2-47.
- **Note** —————
- Before ARMv7, this was a simple branch.
- 
- <Rn>        The register that contains the operand. The PC can be used in ARM instructions.
- <const>     The immediate value to be bitwise ORed with the value obtained from <Rn>. See *Modified immediate constants in Thumb instructions* on page A6-232 or *Modified immediate constants in ARM instructions* on page A5-200 for the range of values.

The pre-UAL syntax ORR<c>S is equivalent to ORRS<c>.

## Operation

```

if ConditionPassed() then
    EncodingSpecificOperations();
    result = R[n] OR imm32;
    if d == 15 then           // Can only occur for ARM encoding
        ALUWritePC(result); // setflags is always FALSE here
    else
        R[d] = result;
        if setflags then
            APSR.N = result<31>;
            APSR.Z = IsZeroBit(result);
            APSR.C = carry;
            // APSR.V unchanged
    
```

## Exceptions

None.

### A8.8.123 ORR (register)

Bitwise OR (register) performs a bitwise (inclusive) OR of a register value and an optionally-shifted register value, and writes the result to the destination register. It can optionally update the condition flags based on the result.

#### Encoding T1 ARMv4T, ARMv5T\*, ARMv6\*, ARMv7

ORRS <Rdn>, <Rm> Outside IT block.  
ORR<c> <Rdn>, <Rm> Inside IT block.

15	14	13	12	11	10	9	8	7	6	5	4	3	2	1	0
0	1	0	0	0	0	1	1	0	0	Rm			Rdn		

d = UInt(Rdn); n = UInt(Rdn); m = UInt(Rm); setflags = !InITBlock();  
(shift\_t, shift\_n) = (SRTYPE\_LSL, 0);

#### Encoding T2 ARMv6T2, ARMv7

ORR{S}<c>.W <Rd>, <Rn>, <Rm>{, <shift>}

15	14	13	12	11	10	9	8	7	6	5	4	3	2	1	0	15	14	13	12	11	10	9	8	7	6	5	4	3	2	1	0
1	1	1	0	1	0	1	0	0	0	1	0	S	Rn			(0)	imm3			Rd			imm2		type	Rm					

if Rn == '1111' then SEE "Related encodings";  
d = UInt(Rd); n = UInt(Rn); m = UInt(Rm); setflags = (S == '1');  
(shift\_t, shift\_n) = DecodeImmShift(type, imm3:imm2);  
if d IN {13,15} || n == 13 || m IN {13,15} then UNPREDICTABLE;

#### Encoding A1 ARMv4\*, ARMv5T\*, ARMv6\*, ARMv7

ORR{S}<c> <Rd>, <Rn>, <Rm>{, <shift>}

31	30	29	28	27	26	25	24	23	22	21	20	19	18	17	16	15	14	13	12	11	10	9	8	7	6	5	4	3	2	1	0
cond			0	0	0	1	1	0	0	S	Rn			Rd			imm5			type	0	Rm									

if Rd == '1111' && S == '1' then SEE SUBS PC, LR and related instructions;  
d = UInt(Rd); n = UInt(Rn); m = UInt(Rm); setflags = (S == '1');  
(shift\_t, shift\_n) = DecodeImmShift(type, imm5);

**Related encodings** See [Move register and immediate shifts on page A6-244](#).

## Assembler syntax

ORR{S}{<C>}{<q>} {<Rd>}, <Rn>, <Rm> {, <shift>}

where:

- S            If S is present, the instruction updates the flags. Otherwise, the flags are not updated.
- <C>, <q>     See *Standard assembler syntax fields* on page A8-287.
- <Rd>        The destination register. If S is specified and <Rd> is the PC, see *SUBS PC, LR (Thumb)* on page B9-2008 or *SUBS PC, LR and related instructions (ARM)* on page B9-2010.  
In ARM instructions, if S is not specified and <Rd> is the PC, the instruction is a branch to the address calculated by the operation. This is an interworking branch, see *Pseudocode details of operations on ARM core registers* on page A2-47.
- **Note** —————
- Before ARMv7, this was a simple branch.
- 
- <Rn>        The first operand register. The PC can be used in ARM instructions.
- <Rm>        The register that is optionally shifted and used as the second operand. The PC can be used in ARM instructions.
- <shift>     The shift to apply to the value read from <Rm>. If present, encoding T1 is not permitted. If absent, no shift is applied and all encodings are permitted. *Shifts applied to a register* on page A8-291 describes the shifts and how they are encoded.

In Thumb assembly:

- outside an IT block, if ORRS <Rd>, <Rn>, <Rd> is written with <Rd> and <Rn> both in the range R0-R7, it is assembled using encoding T1 as though ORRS <Rd>, <Rn> had been written
- inside an IT block, if ORR<C> <Rd>, <Rn>, <Rd> is written with <Rd> and <Rn> both in the range R0-R7, it is assembled using encoding T1 as though ORR<C> <Rd>, <Rn> had been written.

To prevent either of these happening, use the .W qualifier.

The pre-UAL syntax ORR<C>S is equivalent to ORRS<C>.

## Operation

```

if ConditionPassed() then
    EncodingSpecificOperations();
    (shifted, carry) = Shift_C(R[m], shift_t, shift_n, APSR.C);
    result = R[n] OR shifted;
    if d == 15 then // Can only occur for ARM encoding
        ALUWritePC(result); // setflags is always FALSE here
    else
        R[d] = result;
        if setflags then
            APSR.N = result<31>;
            APSR.Z = IsZeroBit(result);
            APSR.C = carry;
            // APSR.V unchanged
    
```

## Exceptions

None.

### A8.8.124 ORR (register-shifted register)

Bitwise OR (register-shifted register) performs a bitwise (inclusive) OR of a register value and a register-shifted register value, and writes the result to the destination register. It can optionally update the condition flags based on the result.

**Encoding A1** ARMv4\*, ARMv5T\*, ARMv6\*, ARMv7

ORR{S}<C> <Rd>, <Rn>, <Rm>, <type> <Rs>

31	30	29	28	27	26	25	24	23	22	21	20	19	18	17	16	15	14	13	12	11	10	9	8	7	6	5	4	3	2	1	0
cond				0	0	0	1	1	0	0	S	Rn				Rd				Rs				0	type		1	Rm			

```
d = UInt(Rd); n = UInt(Rn); m = UInt(Rm); s = UInt(Rs);
setflags = (S == '1'); shift_t = DecodeRegShift(type);
if d == 15 || n == 15 || m == 15 || s == 15 then UNPREDICTABLE;
```

## Assembler syntax

ORR{S}{<c>}{<q>} {<Rd>}, <Rn>, <Rm>, <type> <Rs>

where:

S If S is present, the instruction updates the flags. Otherwise, the flags are not updated.

<c>, <q> See [Standard assembler syntax fields on page A8-287](#).

<Rd> The destination register.

<Rn> The first operand register.

<Rm> The register that is shifted and used as the second operand.

<type> The type of shift to apply to the value read from <Rm>. It must be one of:

ASR Arithmetic shift right, encoded as type = 0b10.

LSL Logical shift left, encoded as type = 0b00.

LSR Logical shift right, encoded as type = 0b01.

ROR Rotate right, encoded as type = 0b11.

<Rs> The register whose bottom byte contains the amount to shift by.

The pre-UAL syntax ORR<c>S is equivalent to ORRS<c>.

## Operation

```
if ConditionPassed() then
    EncodingSpecificOperations();
    shift_n = UInt(R[s]<7:0>);
    (shifted, carry) = Shift_C(R[m], shift_t, shift_n, APSR.C);
    result = R[n] OR shifted;
    R[d] = result;
    if setflags then
        APSR.N = result<31>;
        APSR.Z = IsZeroBit(result);
        APSR.C = carry;
        // APSR.V unchanged
```

## Exceptions

None.

### A8.8.125 PKH

Pack Halfword combines one halfword of its first operand with the other halfword of its shifted second operand.

#### Encoding T1 ARMv6T2, ARMv7

PKHBT<c> <Rd>, <Rn>, <Rm>{, LSL #<imm>}

PKHTB<c> <Rd>, <Rn>, <Rm>{, ASR #<imm>}

15	14	13	12	11	10	9	8	7	6	5	4	3	2	1	0	15	14	13	12	11	10	9	8	7	6	5	4	3	2	1	0
1	1	1	0	1	0	1	0	1	1	0	S		Rn		(0)	imm3		Rd		imm2	tb	T			Rm						

```
if S == '1' || T == '1' then UNDEFINED;
d = UInt(Rd); n = UInt(Rn); m = UInt(Rm); tbform = (tb == '1');
(shift_t, shift_n) = DecodeImmShift(tb:'0', imm3:imm2);
if d IN {13,15} || n IN {13,15} || m IN {13,15} then UNPREDICTABLE;
```

#### Encoding A1 ARMv6\*, ARMv7

PKHBT<c> <Rd>, <Rn>, <Rm>{, LSL #<imm>}

PKHTB<c> <Rd>, <Rn>, <Rm>{, ASR #<imm>}

31	30	29	28	27	26	25	24	23	22	21	20	19	18	17	16	15	14	13	12	11	10	9	8	7	6	5	4	3	2	1	0
cond		0	1	1	0	1	0	0	0		Rn		Rd		imm5		tb	0	1											Rm	

```
d = UInt(Rd); n = UInt(Rn); m = UInt(Rm); tbform = (tb == '1');
(shift_t, shift_n) = DecodeImmShift(tb:'0', imm5);
if d == 15 || n == 15 || m == 15 then UNPREDICTABLE;
```

## Assembler syntax

```
PKHBT{<c>}{<q>} {<Rd>}, <Rn>, <Rm> {, LSL #<imm>}          tbform == FALSE
PKHTB{<c>}{<q>} {<Rd>}, <Rn>, <Rm> {, ASR #<imm>}          tbform == TRUE
```

where:

<c>, <q> See [Standard assembler syntax fields on page A8-287](#).

<Rd> The destination register.

<Rn> The first operand register.

<Rm> The register that is optionally shifted and used as the second operand.

<imm> The shift to apply to the value read from <Rm>, encoded in imm3:imm2 for encoding T1 and imm5 for encoding A1.

For PKHBT, it is one of:

- omitted** No shift, encoded as `0b00000`.
- 1-31** Left shift by specified number of bits, encoded as a binary number.

For PKHTB, it is one of:

- omitted** Instruction is a pseudo-instruction and is assembled as though PKHBT{<c>}{<q>} <Rd>, <Rm>, <Rn> had been written.
- 1-32** Arithmetic right shift by specified number of bits. A shift by 32 bits is encoded as `0b00000`. Other shift amounts are encoded as binary numbers.

### ————— Note —————

An assembler can permit <imm> = 0 to mean the same thing as omitting the shift, but this is not standard UAL and must not be used for disassembly.

## Operation

```
if ConditionPassed() then
    EncodingSpecificOperations();
    operand2 = Shift(R[m], shift_t, shift_n, APSR.C); // APSR.C ignored
    R[d]<15:0> = if tbform then operand2<15:0> else R[n]<15:0>;
    R[d]<31:16> = if tbform then R[n]<31:16> else operand2<31:16>;
```

## Exceptions

None.

### A8.8.126 PLD, PLDW (immediate)

Preload Data signals the memory system that data memory accesses from a specified address are likely in the near future. The memory system can respond by taking actions that are expected to speed up the memory accesses when they do occur, such as pre-loading the cache line containing the specified address into the data cache.

On an architecture variant that includes both the PLD and PLDW instructions, the PLD instruction signals that the likely memory access is a read, and the PLDW instruction signals that it is a write.

The effect of a PLD or PLDW instruction is IMPLEMENTATION DEFINED. For more information, see [Preloading caches on page A3-157](#) and [Behavior of Preload Data \(PLD, PLDW\) and Preload Instruction \(PLI\) with caches on page B2-1269](#).

**Encoding T1** ARMv6T2, ARMv7 for PLD  
ARMv7 with MP Extensions for PLDW

PLD{W}<c> [<Rn>, #<imm12>]

15	14	13	12	11	10	9	8	7	6	5	4	3	2	1	0	15	14	13	12	11	10	9	8	7	6	5	4	3	2	1	0
1	1	1	1	1	0	0	0	1	0	W	1				Rn	1	1	1	1												

if Rn == '1111' then SEE PLD (literal);  
n = UInt(Rn); imm32 = ZeroExtend(imm12, 32); add = TRUE; is\_pldw = (W == '1');

**Encoding T2** ARMv6T2, ARMv7 for PLD  
ARMv7 with MP Extensions for PLDW

PLD{W}<c> [<Rn>, #-<imm8>]

15	14	13	12	11	10	9	8	7	6	5	4	3	2	1	0	15	14	13	12	11	10	9	8	7	6	5	4	3	2	1	0
1	1	1	1	1	0	0	0	0	0	W	1				Rn	1	1	1	1	1	1	0	0								

if Rn == '1111' then SEE PLD (literal);  
n = UInt(Rn); imm32 = ZeroExtend(imm8, 32); add = FALSE; is\_pldw = (W == '1');

**Encoding A1** ARMv5TE\*, ARMv6\*, ARMv7 for PLD  
ARMv7 with MP Extensions for PLDW

PLD{W} [<Rn>, #+/-<imm12>]

31	30	29	28	27	26	25	24	23	22	21	20	19	18	17	16	15	14	13	12	11	10	9	8	7	6	5	4	3	2	1	0	
1	1	1	1	0	1	0	1	U	R	0	1				Rn	(1)	(1)	(1)	(1)													

if Rn == '1111' then SEE PLD (literal);  
n = UInt(Rn); imm32 = ZeroExtend(imm12, 32); add = (U == '1'); is\_pldw = (R == '0');



## Assembler syntax

PLD{W}{<C>}{<q>} [<Rn> {, #+/-<imm>}]

where:

W	If specified, selects PLDW, encoded as W = 1 in Thumb encodings and R = 0 in ARM encodings. If omitted, selects PLD, encoded as W = 0 in Thumb encodings and R = 1 in ARM encodings.				
<C>, <q>	See <i>Standard assembler syntax fields on page A8-287</i> . An ARM PLD or PLDW instruction must be unconditional.				
<Rn>	The base register. The SP can be used. For PC use in the PLD instruction, see <i>PLD (literal) on page A8-526</i> .				
+/-	Is + or omitted to indicate that the immediate offset is added to the base register value (add == TRUE), or – to indicate that the offset is to be subtracted (add == FALSE). Different instructions are generated for #0 and #-0.				
<imm>	The immediate offset used for forming the address. This offset can be omitted, meaning an offset of 0. Values are: <table> <tr> <td><b>Encoding T1, A1</b></td> <td>any value in the range 0-4095</td> </tr> <tr> <td><b>Encoding T2</b></td> <td>any value in the range 0-255.</td> </tr> </table>	<b>Encoding T1, A1</b>	any value in the range 0-4095	<b>Encoding T2</b>	any value in the range 0-255.
<b>Encoding T1, A1</b>	any value in the range 0-4095				
<b>Encoding T2</b>	any value in the range 0-255.				

## Operation

```

if ConditionPassed() then
    EncodingSpecificOperations();
    address = if add then (R[n] + imm32) else (R[n] - imm32);
    if is_pldw then
        Hint_PreloadDataForWrite(address);
    else
        Hint_PreloadData(address);

```

## Exceptions

None.

### A8.8.127 PLD (literal)

Preload Data signals the memory system that data memory accesses from a specified address are likely in the near future. The memory system can respond by taking actions that are expected to speed up the memory accesses when they do occur, such as pre-loading the cache line containing the specified address into the data cache.

The effect of a PLD instruction is IMPLEMENTATION DEFINED. For more information, see [Preloading caches on page A3-157](#) and [Behavior of Preload Data \(PLD, PLDW\) and Preload Instruction \(PLI\) with caches on page B2-1269](#).

#### Encoding T1 ARMv6T2, ARMv7

PLD<c> <label>

PLD<c> [PC, #-0]

Special case

15	14	13	12	11	10	9	8	7	6	5	4	3	2	1	0	15	14	13	12	11	10	9	8	7	6	5	4	3	2	1	0
1	1	1	1	1	0	0	0	U	0	(0)	1	1	1	1	1	1	1	1	1	imm12											

imm32 = ZeroExtend(imm12, 32); add = (U == '1');

#### Encoding A1 ARMv5TE\*, ARMv6\*, ARMv7

PLD <label>

PLD [PC, #-0]

Special case

31	30	29	28	27	26	25	24	23	22	21	20	19	18	17	16	15	14	13	12	11	10	9	8	7	6	5	4	3	2	1	0
1	1	1	1	0	1	0	1	U	(1)	0	1	1	1	1	1	(1)	(1)	(1)	(1)	imm12											

imm32 = ZeroExtend(imm12, 32); add = (U == '1');

## Assembler syntax

PLD{<c>}{<q>} <label>	Normal form
PLD{<c>}{<q>} [PC, #+/-<imm>]	Alternative form

where:

- <c>, <q> See [Standard assembler syntax fields on page A8-287](#). An ARM PLD instruction must be unconditional.
- <label> The label of the literal data item that is likely to be accessed in the near future. The assembler calculates the required value of the offset from the `Align(PC, 4)` value of the instruction to this label. The offset must be in the range `-4095` to `4095`.  
If the offset is zero or positive, `imm32` is equal to the offset and `add == TRUE`.  
If the offset is negative, `imm32` is equal to minus the offset and `add == FALSE`.
- +/- Is + or omitted to indicate that the immediate offset is added to the `Align(PC, 4)` value (`add == TRUE`), or - to indicate that the offset is to be subtracted (`add == FALSE`). Different instructions are generated for #0 and #-0.
- <imm> The immediate offset used for forming the address. Values are in the range 0-4095.

The alternative syntax permits the addition or subtraction of the offset and the immediate offset to be specified separately, including permitting a subtraction of 0 that cannot be specified using the normal syntax. For more information, see [Use of labels in UAL instruction syntax on page A4-162](#).

## Operation

```
if ConditionPassed() then
    EncodingSpecificOperations();
    address = if add then (Align(PC,4) + imm32) else (Align(PC,4) - imm32);
    Hint_PreloadData(address);
```

## Exceptions

None.

### A8.8.128 PLD, PLDW (register)

Preload Data signals the memory system that data memory accesses from a specified address are likely in the near future. The memory system can respond by taking actions that are expected to speed up the memory accesses when they do occur, such as pre-loading the cache line containing the specified address into the data cache.

On an architecture variant that includes both the PLD and PLDW instructions, the PLD instruction signals that the likely memory access is a read, and the PLDW instruction signals that it is a write.

The effect of a PLD or PLDW instruction is IMPLEMENTATION DEFINED. For more information, see [Preloading caches on page A3-157](#) and [Behavior of Preload Data \(PLD, PLDW\) and Preload Instruction \(PLI\) with caches on page B2-1269](#).

**Encoding T1** ARMv6T2, ARMv7 for PLD  
ARMv7 with MP Extensions for PLDW

PLD{W}<c> [<Rn>, <Rm>{, LSL #<imm2>}]

15	14	13	12	11	10	9	8	7	6	5	4	3	2	1	0	15	14	13	12	11	10	9	8	7	6	5	4	3	2	1	0
1	1	1	1	1	0	0	0	0	0	W	1			Rn		1	1	1	1	0	0	0	0	0	0	imm2		Rm			

```
if Rn == '1111' then SEE PLD (literal);
n = UInt(Rn); m = UInt(Rm); add = TRUE; is_pldw = (W == '1');
(shift_t, shift_n) = (SRTYPE_LSL, UInt(imm2));
if m IN {13,15} then UNPREDICTABLE;
```

**Encoding A1** ARMv5TE\*, ARMv6\*, ARMv7 for PLD  
ARMv7 with MP Extensions for PLDW

PLD{W} [<Rn>, +/-<Rm>{, <shift>}]

31	30	29	28	27	26	25	24	23	22	21	20	19	18	17	16	15	14	13	12	11	10	9	8	7	6	5	4	3	2	1	0
1	1	1	1	0	1	1	1	U	R	0	1			Rn		(1)	(1)	(1)	(1)		imm5		type	0					Rm		

```
n = UInt(Rn); m = UInt(Rm); add = (U == '1'); is_pldw = (R == '0');
(shift_t, shift_n) = DecodeImmShift(type, imm5);
if m == 15 || (n == 15 && is_pldw) then UNPREDICTABLE;
```

## Assembler syntax

PLD[W]{<C>}{<q>} [<Rn>, +/-<Rm> {, <shift>}]

where:

W	If specified, selects PLDW, encoded as W = 1 in Thumb encodings and R = 0 in ARM encodings. If omitted, selects PLD, encoded as W = 0 in Thumb encodings and R = 1 in ARM encodings.
<C>, <q>	See <a href="#">Standard assembler syntax fields on page A8-287</a> . An ARM PLD or PLDW instruction must be unconditional.
<Rn>	Is the base register. The SP can be used. The PC can be used in ARM PLD instructions, but not in Thumb PLD instructions or in any PLDW instructions.
+/-	Is + or omitted if the optionally shifted value of <Rm> is to be added to the base register value (add == TRUE), or – if it is to be subtracted (permitted in ARM instructions only, add == FALSE).
<Rm>	Contains the offset that is optionally shifted and applied to the value of <Rn> to form the address.
<shift>	The shift to apply to the value read from <Rm>. If absent, no shift is applied. For encoding T1, <shift> can only be omitted, encoded as imm2 = 0b00, or LSL #<imm> with <imm> = 1, 2, or 3, with <imm> encoded in imm2. For encoding A1, see <a href="#">Shifts applied to a register on page A8-291</a> .

## Operation

```

if ConditionPassed() then
    EncodingSpecificOperations();
    offset = Shift(R[m], shift_t, shift_n, APSR.C);
    address = if add then (R[n] + offset) else (R[n] - offset);
    if is_pldw then
        Hint_PreloadDataForWrite(address);
    else
        Hint_PreloadData(address);

```

## Exceptions

None.

### A8.8.129 PLI (immediate, literal)

Preload Instruction signals the memory system that instruction memory accesses from a specified address are likely in the near future. The memory system can respond by taking actions that are expected to speed up the memory accesses when they do occur, such as pre-loading the cache line containing the specified address into the instruction cache.

The effect of a PLI instruction is IMPLEMENTATION DEFINED. For more information, see [Preloading caches on page A3-157](#) and [Behavior of Preload Data \(PLD, PLDW\) and Preload Instruction \(PLI\) with caches on page B2-1269](#).

#### Encoding T1 ARMv7

PLI<c> [<Rn>, #<imm12>]

15	14	13	12	11	10	9	8	7	6	5	4	3	2	1	0	15	14	13	12	11	10	9	8	7	6	5	4	3	2	1	0
1	1	1	1	1	0	0	1	1	0	0	1		Rn			1	1	1	1												imm12

if Rn == '1111' then SEE encoding T3;  
n = UInt(Rn); imm32 = ZeroExtend(imm12, 32); add = TRUE;

#### Encoding T2 ARMv7

PLI<c> [<Rn>, #-<imm8>]

15	14	13	12	11	10	9	8	7	6	5	4	3	2	1	0	15	14	13	12	11	10	9	8	7	6	5	4	3	2	1	0
1	1	1	1	1	0	0	1	0	0	0	1		Rn			1	1	1	1	1	1	0	0								imm8

if Rn == '1111' then SEE encoding T3;  
n = UInt(Rn); imm32 = ZeroExtend(imm8, 32); add = FALSE;

#### Encoding T3 ARMv7

PLI<c> <label>

PLI<c> [PC, #-0] Special case

15	14	13	12	11	10	9	8	7	6	5	4	3	2	1	0	15	14	13	12	11	10	9	8	7	6	5	4	3	2	1	0
1	1	1	1	1	0	0	1	U	0	0	1	1	1	1	1	1	1	1	1											imm12	

n = 15; imm32 = ZeroExtend(imm12, 32); add = (U == '1');

#### Encoding A1 ARMv7

PLI [<Rn>, #+/-<imm12>]

PLI <label>

PLI [PC, #-0] Special case

31	30	29	28	27	26	25	24	23	22	21	20	19	18	17	16	15	14	13	12	11	10	9	8	7	6	5	4	3	2	1	0		
1	1	1	1	0	1	0	0	U	1	0	1		Rn			(1)	(1)	(1)	(1)														imm12

n = UInt(Rn); imm32 = ZeroExtend(imm12, 32); add = (U == '1');

## Assembler syntax

PLI{<c>}{<q>} [<Rn> {, #+/-<imm>}]	Immediate form
PLI{<c>}{<q>} <label>	Normal literal form
PLI{<c>}{<q>} [PC, #+/-<imm>]	Alternative literal form

where:

<c>, <q>	See <a href="#">Standard assembler syntax fields on page A8-287</a> . An ARM PLI instruction must be unconditional.
<Rn>	Is the base register. The SP can be used.
+/-	Is + or omitted to indicate that the immediate offset is added to the base register value (add == TRUE), or – to indicate that the offset is to be subtracted (add == FALSE). Different instructions are generated for #0 and #-0.
<imm>	The immediate offset used for forming the address. For the immediate form of the syntax, <imm> can be omitted, in which case the #0 form of the instruction is assembled. Values are: <b>Encoding T1, T3, A1</b> any value in the range 0 to 4095 <b>Encoding T2</b> any value in the range 0 to 255.
<label>	The label of the instruction that is likely to be accessed in the near future. The assembler calculates the required value of the offset from the Align(PC, 4) value of the instruction to this label. The offset must be in the range –4095 to 4095. If the offset is zero or positive, imm32 is equal to the offset and add == TRUE. If the offset is negative, imm32 is equal to minus the offset and add == FALSE.

For the literal forms of the instruction, encoding T3 is used, or Rn is encoded as 0b1111 in encoding A1, to indicate that the PC is the base register.

The alternative literal syntax permits the addition or subtraction of the offset and the immediate offset to be specified separately, including permitting a subtraction of 0 that cannot be specified using the normal syntax. For more information, see [Use of labels in UAL instruction syntax on page A4-162](#).

## Operation

```
if ConditionPassed() then
    EncodingSpecificOperations();
    base = if n == 15 then Align(PC,4) else R[n];
    address = if add then (base + imm32) else (base - imm32);
    Hint_PreloadInstr(address);
```

## Exceptions

None.

### A8.8.130 PLI (register)

Preload Instruction signals the memory system that instruction memory accesses from a specified address are likely in the near future. The memory system can respond by taking actions that are expected to speed up the memory accesses when they do occur, such as pre-loading the cache line containing the specified address into the instruction cache. For more information, see *Behavior of Preload Data (PLD, PLDW) and Preload Instruction (PLI) with caches* on page B2-1269.

The effect of a PLI instruction is IMPLEMENTATION DEFINED. For more information, see *Preloading caches* on page A3-157 and *Behavior of Preload Data (PLD, PLDW) and Preload Instruction (PLI) with caches* on page B2-1269.

#### Encoding T1 ARMv7

PLI<c> [<Rn>, <Rm>{, LSL #<imm2>}]

15	14	13	12	11	10	9	8	7	6	5	4	3	2	1	0	15	14	13	12	11	10	9	8	7	6	5	4	3	2	1	0
1	1	1	1	1	0	0	1	0	0	0	1	Rn				1	1	1	1	0	0	0	0	0	0	imm2	Rm				

```
if Rn == '1111' then SEE PLI (immediate, literal);
n = UInt(Rn); m = UInt(Rm); add = TRUE;
(shift_t, shift_n) = (SRTYPE_LSL, UInt(imm2));
if m IN {13,15} then UNPREDICTABLE;
```

#### Encoding A1 ARMv7

PLI [<Rn>, +/-<Rm>{, <shift>}]

31	30	29	28	27	26	25	24	23	22	21	20	19	18	17	16	15	14	13	12	11	10	9	8	7	6	5	4	3	2	1	0
1	1	1	1	0	1	1	0	U	1	0	1	Rn				(1)	(1)	(1)	(1)	imm5				type	0	Rm					

```
n = UInt(Rn); m = UInt(Rm); add = (U == '1');
(shift_t, shift_n) = DecodeImmShift(type, imm5);
if m == 15 then UNPREDICTABLE;
```



## Assembler syntax

PLI{<c>}{<q>} [<Rn>, +/-<Rm> {, <shift>}]

where:

- <c>, <q> See *Standard assembler syntax fields on page A8-287*. An ARM PLI instruction must be unconditional.
- <Rn> Is the base register. The SP can be used.
- +/- Is + or omitted if the optionally shifted value of <Rm> is to be added to the base register value (add == TRUE), or – if it is to be subtracted (permitted in ARM instructions only, add == FALSE).
- <Rm> Contains the offset that is optionally shifted and applied to the value of <Rn> to form the address.
- <shift> The shift to apply to the value read from <Rm>. If absent, no shift is applied. For encoding T1, <shift> can only be omitted, encoded as imm2 = 0b00, or LSL #<imm> with <imm> = 1, 2, or 3, with <imm> encoded in imm2. For encoding A1, see *Shifts applied to a register on page A8-291*.

## Operation

```
if ConditionPassed() then
    EncodingSpecificOperations();
    offset = Shift(R[m], shift_t, shift_n, APSR.C);
    address = if add then (R[n] + offset) else (R[n] - offset);
    Hint_PreloadInstr(address);
```

## Exceptions

None.

### A8.8.131 POP (Thumb)

Pop Multiple Registers loads multiple registers from the stack, loading from consecutive memory locations starting at the address in SP, and updates SP to point just above the loaded data.

**Encoding T1** ARMv4T, ARMv5T\*, ARMv6\*, ARMv7  
POP<c> <registers>

15	14	13	12	11	10	9	8	7	6	5	4	3	2	1	0
1	0	1	1	1	1	0	P	register_list							

```
registers = P:'000000':register_list; UnalignedAllowed = FALSE;
if BitCount(registers) < 1 then UNPREDICTABLE;
if registers<15> == '1' && InITBlock() && !LastInITBlock() then UNPREDICTABLE;
```

**Encoding T2** ARMv6T2, ARMv7

POP<c>.W <registers> <registers> contains more than one register

15	14	13	12	11	10	9	8	7	6	5	4	3	2	1	0	15	14	13	12	11	10	9	8	7	6	5	4	3	2	1	0
1	1	1	0	1	0	0	0	1	0	1	1	1	1	0	1	P	M(0)	register_list													

```
registers = P:M:'0':register_list; UnalignedAllowed = FALSE;
if BitCount(registers) < 2 || (P == '1' && M == '1') then UNPREDICTABLE;
if registers<15> == '1' && InITBlock() && !LastInITBlock() then UNPREDICTABLE;
```

**Encoding T3** ARMv6T2, ARMv7

POP<c>.W <registers> <registers> contains one register, <Rt>

15	14	13	12	11	10	9	8	7	6	5	4	3	2	1	0	15	14	13	12	11	10	9	8	7	6	5	4	3	2	1	0
1	1	1	1	1	0	0	0	0	1	0	1	1	1	0	1	Rt	1	0	1	1	0	0	0	0	0	1	0	0			

```
t = UInt(Rt); registers = Zeros(16); registers<t> = '1'; UnalignedAllowed = TRUE;
if t == 13 || (t == 15 && InITBlock() && !LastInITBlock()) then UNPREDICTABLE;
```

## Assembler syntax

POP{<c>}{<q>} <registers> Standard syntax  
LDM{<c>}{<q>} SP!, <registers> Equivalent LDM syntax

where:

<c>, <q> See *Standard assembler syntax fields on page A8-287*.

<registers> Is a list of one or more registers to be loaded, separated by commas and surrounded by { and }. The lowest-numbered register is loaded from the lowest memory address, through to the highest-numbered register from the highest memory address. See also *Encoding of lists of ARM core registers on page A8-295*.

If the list contains more than one register, the instruction is assembled to encoding T1 or T2. If the list contains exactly one register, the instruction is assembled to encoding T1 or T3.

The PC can be in the list. If it is, the instruction branches to the address loaded to the PC. In ARMv5T and above, this is an interworking branch, see *Pseudocode details of operations on ARM core registers on page A2-47*. If the PC is in the list:

- the LR must not be in the list
- the instruction must be either outside any IT block, or the last instruction in an IT block.

## Operation

```

if ConditionPassed() then
    EncodingSpecificOperations(); NullCheckIfThumbEE(13);
    address = SP;
    for i = 0 to 14
        if registers<i> == '1' then
            R[i] = if UnalignedAllowed then MemU[address,4] else MemA[address,4];
            address = address + 4;
    if registers<15> == '1' then
        if UnalignedAllowed then
            if address<1:0> == '00' then
                LoadWritePC(MemU[address,4]);
            else
                UNPREDICTABLE;
        else
            LoadWritePC(MemA[address,4]);
    if registers<13> == '0' then SP = SP + 4*BitCount(registers);
    if registers<13> == '1' then SP = bits(32) UNKNOWN;

```

## Exceptions

Data Abort.

### A8.8.132 POP (ARM)

Pop Multiple Registers loads multiple registers from the stack, loading from consecutive memory locations starting at the address in SP, and updates SP to point just above the loaded data.

**Encoding A1** ARMv4\*, ARMv5T\*, ARMv6\*, ARMv7

POP<c> <registers> <registers> contains more than one register

31	30	29	28	27	26	25	24	23	22	21	20	19	18	17	16	15	14	13	12	11	10	9	8	7	6	5	4	3	2	1	0
cond		1	0	0	0	1	0	1	1	1	1	0	1	register_list																	

```
if BitCount(register_list) < 2 then SEE LDM / LDMIA / LDMFD;
registers = register_list; UnalignedAllowed = FALSE;
if registers<13> == '1' && ArchVersion() >= 7 then UNPREDICTABLE;
```

**Encoding A2** ARMv4\*, ARMv5T\*, ARMv6\*, ARMv7

POP<c> <registers> <registers> contains one register, <Rt>

31	30	29	28	27	26	25	24	23	22	21	20	19	18	17	16	15	14	13	12	11	10	9	8	7	6	5	4	3	2	1	0
cond		0	1	0	0	1	0	0	1	1	1	0	1	Rt	0	0	0	0	0	0	0	0	0	0	0	0	1	0	0		

```
t = UInt(Rt); registers = Zeros(16); registers<t> = '1'; UnalignedAllowed = TRUE;
if t == 13 then UNPREDICTABLE;
```

## Assembler syntax

POP{<c>}{<q>} <registers> Standard syntax  
LDM{<c>}{<q>} SP!, <registers> Equivalent LDM syntax

where:

<c>, <q> See *Standard assembler syntax fields on page A8-287*.

<registers> Is a list of one or more registers to be loaded, separated by commas and surrounded by { and }. The lowest-numbered register is loaded from the lowest memory address, through to the highest-numbered register from the highest memory address. See also *Encoding of lists of ARM core registers on page A8-295*.

If the list contains more than one register, the instruction is assembled to encoding A1. If the list contains exactly one register, the instruction is assembled to encoding A2.

The SP can only be in the list before ARMv7. ARM deprecates any use of ARM instructions that include the SP, and the value of the SP after such an instruction is UNKNOWN.

The PC can be in the list. If it is, the instruction branches to the address loaded to the PC. In ARMv5T and above, this is an interworking branch, see *Pseudocode details of operations on ARM core registers on page A2-47*.

ARM deprecates the use of this instruction with both the LR and the PC in the list.

## Operation

```
if ConditionPassed() then
    EncodingSpecificOperations(); NullCheckIfThumbEE(13);
    address = SP;
    for i = 0 to 14
        if registers<i> == '1' then
            R[i] = if UnalignedAllowed then MemU[address,4] else MemA[address,4];
            address = address + 4;
    if registers<15> == '1' then
        if UnalignedAllowed then
            if address<1:0> == '00' then
                LoadWritePC(MemU[address,4]);
            else
                UNPREDICTABLE;
        else
            LoadWritePC(MemA[address,4]);
    if registers<13> == '0' then SP = SP + 4*BitCount(registers);
    if registers<13> == '1' then SP = bits(32) UNKNOWN;
```

## Exceptions

Data Abort.

### A8.8.133 PUSH

Push Multiple Registers stores multiple registers to the stack, storing to consecutive memory locations ending just below the address in SP, and updates SP to point to the start of the stored data.

#### Encoding T1 ARMv4T, ARMv5T\*, ARMv6\*, ARMv7

PUSH<c> <registers>

15	14	13	12	11	10	9	8	7	6	5	4	3	2	1	0
1	0	1	1	0	1	0	M	register_list							

registers = '0':M:'000000':register\_list; UnalignedAllowed = FALSE;  
if BitCount(registers) < 1 then UNPREDICTABLE;

#### Encoding T2 ARMv6T2, ARMv7

PUSH<c>.W <registers> <registers> contains more than one register

15	14	13	12	11	10	9	8	7	6	5	4	3	2	1	0	15	14	13	12	11	10	9	8	7	6	5	4	3	2	1	0
1	1	1	0	1	0	0	1	0	0	1	0	1	1	0	1	(0)	M	(0)	register_list												

registers = '0':M:'0':register\_list; UnalignedAllowed = FALSE;  
if BitCount(registers) < 2 then UNPREDICTABLE;

#### Encoding T3 ARMv6T2, ARMv7

PUSH<c>.W <registers> <registers> contains one register, <Rt>

15	14	13	12	11	10	9	8	7	6	5	4	3	2	1	0	15	14	13	12	11	10	9	8	7	6	5	4	3	2	1	0
1	1	1	1	1	0	0	0	0	1	0	0	1	1	0	1	Rt	1	1	0	1	0	0	0	0	0	1	0	0			

t = UInt(Rt); registers = Zeros(16); registers<t> = '1'; UnalignedAllowed = TRUE;  
if t IN {13,15} then UNPREDICTABLE;

#### Encoding A1 ARMv4\*, ARMv5T\*, ARMv6\*, ARMv7

PUSH<c> <registers> <registers> contains more than one register

31	30	29	28	27	26	25	24	23	22	21	20	19	18	17	16	15	14	13	12	11	10	9	8	7	6	5	4	3	2	1	0
cond		1	0	0	1	0	0	1	0	1	1	0	1	register_list																	

if BitCount(register\_list) < 2 then SEE STMDB / STMFD;  
registers = register\_list; UnalignedAllowed = FALSE;

#### Encoding A2 ARMv4\*, ARMv5T\*, ARMv6\*, ARMv7

PUSH<c> <registers> <registers> contains one register, <Rt>

31	30	29	28	27	26	25	24	23	22	21	20	19	18	17	16	15	14	13	12	11	10	9	8	7	6	5	4	3	2	1	0
cond		0	1	0	1	0	0	1	0	1	1	0	1	Rt	0	0	0	0	0	0	0	0	0	0	0	0	0	1	0	0	

t = UInt(Rt); registers = Zeros(16); registers<t> = '1'; UnalignedAllowed = TRUE;  
if t == 13 then UNPREDICTABLE;

## Assembler syntax

PUSH{<c>}{<q>} <registers> Standard syntax  
STMDB{<c>}{<q>} SP!, <registers> Equivalent STM syntax

where:

<c>, <q> See *Standard assembler syntax fields* on page A8-287.

<registers> Is a list of one or more registers to be stored, separated by commas and surrounded by { and }. The lowest-numbered register is stored to the lowest memory address, through to the highest-numbered register to the highest memory address. See also *Encoding of lists of ARM core registers* on page A8-295.

If the list contains more than one register, the instruction is assembled to encoding T1, T2, or A1. If the list contains exactly one register, the instruction is assembled to encoding T1, T3, or A2.

The SP and PC can be in the list in ARM instructions, but not in Thumb instructions. However:

- ARM deprecates the use of ARM instructions that include the PC in the list
- if the SP is in the list, and it is not the lowest-numbered register in the list, the instruction stores an UNKNOWN value for the SP.

## Operation

```

if ConditionPassed() then
    EncodingSpecificOperations(); NullCheckIfThumbEE(13);
    address = SP - 4*BitCount(registers);
    for i = 0 to 14
        if registers<i> == '1' then
            if i == 13 && i != LowestSetBit(registers) then // Only possible for encoding A1
                MemA[address,4] = bits(32) UNKNOWN;
            else
                if UnalignedAllowed then
                    MemU[address,4] = R[i];
                else
                    MemA[address,4] = R[i];
                address = address + 4;
    if registers<15> == '1' then // Only possible for encoding A1 or A2
        if UnalignedAllowed then
            MemU[address,4] = PCStoreValue();
        else
            MemA[address,4] = PCStoreValue();
    SP = SP - 4*BitCount(registers);

```

## Exceptions

Data Abort.

### A8.8.134 QADD

Saturating Add adds two register values, saturates the result to the 32-bit signed integer range  $-2^{31}$  to  $(2^{31} - 1)$ , and writes the result to the destination register. If saturation occurs, it sets the Q flag in the APSR.

#### Encoding T1 ARMv6T2, ARMv7

QADD<c> <Rd>, <Rm>, <Rn>

15	14	13	12	11	10	9	8	7	6	5	4	3	2	1	0	15	14	13	12	11	10	9	8	7	6	5	4	3	2	1	0
1	1	1	1	1	0	1	0	1	0	0	0	Rn			1	1	1	1	Rd			1	0	0	0	Rm					

d = UInt(Rd); n = UInt(Rn); m = UInt(Rm);  
if d IN {13,15} || n IN {13,15} || m IN {13,15} then UNPREDICTABLE;

#### Encoding A1 ARMv5TE\*, ARMv6\*, ARMv7

QADD<c> <Rd>, <Rm>, <Rn>

31	30	29	28	27	26	25	24	23	22	21	20	19	18	17	16	15	14	13	12	11	10	9	8	7	6	5	4	3	2	1	0
cond		0	0	0	1	0	0	0	0	Rn			Rd			(0)	(0)	(0)	(0)	0	1	0	1	Rm							

d = UInt(Rd); n = UInt(Rn); m = UInt(Rm);  
if d == 15 || n == 15 || m == 15 then UNPREDICTABLE;



## Assembler syntax

QADD{<c>}{<q>} {<Rd>}, <Rm>, <Rn>

where:

<c>, <q> See *Standard assembler syntax fields* on page A8-287.

<Rd> The destination register.

<Rm> The first operand register.

<Rn> The second operand register.

## Operation

```
if ConditionPassed() then
    EncodingSpecificOperations();
    (R[d], sat) = SignedSatQ(SInt(R[m]) + SInt(R[n]), 32);
    if sat then
        APSR.Q = '1';
```

## Exceptions

None.

### A8.8.135 QADD16

Saturating Add 16 performs two 16-bit integer additions, saturates the results to the 16-bit signed integer range  $-2^{15} \leq x \leq 2^{15} - 1$ , and writes the results to the destination register.

**Encoding T1** ARMv6T2, ARMv7

QADD16<c> <Rd>, <Rn>, <Rm>

15	14	13	12	11	10	9	8	7	6	5	4	3	2	1	0	15	14	13	12	11	10	9	8	7	6	5	4	3	2	1	0
1	1	1	1	1	0	1	0	1	0	0	1	Rn			1	1	1	1	Rd			0	0	0	1	Rm					

d = UInt(Rd); n = UInt(Rn); m = UInt(Rm);  
if d IN {13,15} || n IN {13,15} || m IN {13,15} then UNPREDICTABLE;

**Encoding A1** ARMv6\*, ARMv7

QADD16<c> <Rd>, <Rn>, <Rm>

31	30	29	28	27	26	25	24	23	22	21	20	19	18	17	16	15	14	13	12	11	10	9	8	7	6	5	4	3	2	1	0
cond		0	1	1	0	0	0	1	0	Rn			Rd			(1)	(1)	(1)	(1)	0	0	0	1	Rm							

d = UInt(Rd); n = UInt(Rn); m = UInt(Rm);  
if d == 15 || n == 15 || m == 15 then UNPREDICTABLE;

## Assembler syntax

QADD16{<c>}{<q>} {<Rd>}, <Rn>, <Rm>

where:

<c>, <q> See [Standard assembler syntax fields on page A8-287](#).

<Rd> The destination register.

<Rn> The first operand register.

<Rm> The second operand register.

## Operation

```
if ConditionPassed() then
    EncodingSpecificOperations();
    sum1 = SInt(R[n]<15:0>) + SInt(R[m]<15:0>);
    sum2 = SInt(R[n]<31:16>) + SInt(R[m]<31:16>);
    R[d]<15:0> = SignedSat(sum1, 16);
    R[d]<31:16> = SignedSat(sum2, 16);
```

## Exceptions

None.

### A8.8.136 QADD8

Saturating Add 8 performs four 8-bit integer additions, saturates the results to the 8-bit signed integer range  $-2^7 \leq x \leq 2^7 - 1$ , and writes the results to the destination register.

#### Encoding T1 ARMv6T2, ARMv7

QADD8<c> <Rd>, <Rn>, <Rm>

15	14	13	12	11	10	9	8	7	6	5	4	3	2	1	0	15	14	13	12	11	10	9	8	7	6	5	4	3	2	1	0
1	1	1	1	1	0	1	0	1	0	0	0	Rn			1	1	1	1	Rd			0	0	0	1	Rm					

d = UInt(Rd); n = UInt(Rn); m = UInt(Rm);  
if d IN {13,15} || n IN {13,15} || m IN {13,15} then UNPREDICTABLE;

#### Encoding A1 ARMv6\*, ARMv7

QADD8<c> <Rd>, <Rn>, <Rm>

31	30	29	28	27	26	25	24	23	22	21	20	19	18	17	16	15	14	13	12	11	10	9	8	7	6	5	4	3	2	1	0
cond		0	1	1	0	0	0	1	0	Rn			Rd			(1)	(1)	(1)	(1)	1	0	0	1	Rm							

d = UInt(Rd); n = UInt(Rn); m = UInt(Rm);  
if d == 15 || n == 15 || m == 15 then UNPREDICTABLE;

## Assembler syntax

QADD8{<c>}{<q>} {<Rd>}, <Rn>, <Rm>

where:

<c>, <q> See *Standard assembler syntax fields* on page A8-287.

<Rd> The destination register.

<Rn> The first operand register.

<Rm> The second operand register.

## Operation

```
if ConditionPassed() then
    EncodingSpecificOperations();
    sum1 = SInt(R[n]<7:0>) + SInt(R[m]<7:0>);
    sum2 = SInt(R[n]<15:8>) + SInt(R[m]<15:8>);
    sum3 = SInt(R[n]<23:16>) + SInt(R[m]<23:16>);
    sum4 = SInt(R[n]<31:24>) + SInt(R[m]<31:24>);
    R[d]<7:0> = SignedSat(sum1, 8);
    R[d]<15:8> = SignedSat(sum2, 8);
    R[d]<23:16> = SignedSat(sum3, 8);
    R[d]<31:24> = SignedSat(sum4, 8);
```

## Exceptions

None.

### A8.8.137 QASX

Saturating Add and Subtract with Exchange exchanges the two halfwords of the second operand, performs one 16-bit integer addition and one 16-bit subtraction, saturates the results to the 16-bit signed integer range  $-2^{15} \leq x \leq 2^{15} - 1$ , and writes the results to the destination register.

**Encoding T1** ARMv6T2, ARMv7

QASX<c> <Rd>, <Rn>, <Rm>

15	14	13	12	11	10	9	8	7	6	5	4	3	2	1	0	15	14	13	12	11	10	9	8	7	6	5	4	3	2	1	0
1	1	1	1	1	0	1	0	1	0	Rn					1	1	1	1	Rd				0	0	0	1	Rm				

d = UInt(Rd); n = UInt(Rn); m = UInt(Rm);  
if d IN {13,15} || n IN {13,15} || m IN {13,15} then UNPREDICTABLE;

**Encoding A1** ARMv6\*, ARMv7

QASX<c> <Rd>, <Rn>, <Rm>

31	30	29	28	27	26	25	24	23	22	21	20	19	18	17	16	15	14	13	12	11	10	9	8	7	6	5	4	3	2	1	0
cond		0	1	1	0	0	0	1	0	Rn					Rd				(1)	(1)	(1)	(1)	0	0	1	1	Rm				

d = UInt(Rd); n = UInt(Rn); m = UInt(Rm);  
if d == 15 || n == 15 || m == 15 then UNPREDICTABLE;

## Assembler syntax

QASX{<c>}{<q>} {<Rd>}, <Rn>, <Rm>

where:

<c>, <q> See *Standard assembler syntax fields* on page A8-287.

<Rd> The destination register.

<Rn> The first operand register.

<Rm> The second operand register.

The pre-UAL syntax QADDSUBX<c> is equivalent to QASX<c>.

## Operation

```
if ConditionPassed() then
    EncodingSpecificOperations();
    diff = SInt(R[n]<15:0>) - SInt(R[m]<31:16>);
    sum = SInt(R[n]<31:16>) + SInt(R[m]<15:0>);
    R[d]<15:0> = SignedSat(diff, 16);
    R[d]<31:16> = SignedSat(sum, 16);
```

## Exceptions

None.

### A8.8.138 QDADD

Saturating Double and Add adds a doubled register value to another register value, and writes the result to the destination register. Both the doubling and the addition have their results saturated to the 32-bit signed integer range  $-2^{31} \leq x \leq 2^{31} - 1$ . If saturation occurs in either operation, it sets the Q flag in the APSR.

#### Encoding T1 ARMv6T2, ARMv7

QDADD<c> <Rd>, <Rm>, <Rn>

15	14	13	12	11	10	9	8	7	6	5	4	3	2	1	0	15	14	13	12	11	10	9	8	7	6	5	4	3	2	1	0
1	1	1	1	1	0	1	0	1	0	0	0	Rn				1	1	1	1	Rd				1	0	0	1	Rm			

d = UInt(Rd); n = UInt(Rn); m = UInt(Rm);  
if d IN {13,15} || n IN {13,15} || m IN {13,15} then UNPREDICTABLE;

#### Encoding A1 ARMv5TE\*, ARMv6\*, ARMv7

QDADD<c> <Rd>, <Rm>, <Rn>

31	30	29	28	27	26	25	24	23	22	21	20	19	18	17	16	15	14	13	12	11	10	9	8	7	6	5	4	3	2	1	0				
cond				0	0	0	1	0	1	0	0	Rn				Rd				(0)	(0)	(0)	(0)	0	1	0	1	Rm							

d = UInt(Rd); n = UInt(Rn); m = UInt(Rm);  
if d == 15 || n == 15 || m == 15 then UNPREDICTABLE;



## Assembler syntax

QDADD{<c>}{<q>} {<Rd>}, <Rm>, <Rn>

where:

<c>, <q> See [Standard assembler syntax fields on page A8-287](#).

<Rd> The destination register.

<Rm> The first operand register.

<Rn> The second operand register.

## Operation

```
if ConditionPassed() then
    EncodingSpecificOperations();
    (doubled, sat1) = SignedSatQ(2 * SInt(R[n]), 32);
    (R[d], sat2) = SignedSatQ(SInt(R[m]) + SInt(doubled), 32);
    if sat1 || sat2 then
        APSR.Q = '1';
```

## Exceptions

None.

### A8.8.139 QDSUB

Saturating Double and Subtract subtracts a doubled register value from another register value, and writes the result to the destination register. Both the doubling and the subtraction have their results saturated to the 32-bit signed integer range  $-2^{31} \leq x \leq 2^{31} - 1$ . If saturation occurs in either operation, it sets the Q flag in the APSR.

**Encoding T1** ARMv6T2, ARMv7

QDSUB<c> <Rd>, <Rm>, <Rn>

15	14	13	12	11	10	9	8	7	6	5	4	3	2	1	0	15	14	13	12	11	10	9	8	7	6	5	4	3	2	1	0
1	1	1	1	1	0	1	0	1	0	0	0	Rn				1	1	1	1	Rd				1	0	1	1	Rm			

d = UInt(Rd); n = UInt(Rn); m = UInt(Rm);  
if d IN {13,15} || n IN {13,15} || m IN {13,15} then UNPREDICTABLE;

**Encoding A1** ARMv5TE\*, ARMv6\*, ARMv7

QDSUB<c> <Rd>, <Rm>, <Rn>

31	30	29	28	27	26	25	24	23	22	21	20	19	18	17	16	15	14	13	12	11	10	9	8	7	6	5	4	3	2	1	0
cond		0	0	0	1	0	1	1	0	Rn				Rd				(0)	(0)	(0)	(0)	0	1	0	1	Rm					

d = UInt(Rd); n = UInt(Rn); m = UInt(Rm);  
if d == 15 || n == 15 || m == 15 then UNPREDICTABLE;

## Assembler syntax

QDSUB{<c>}{<q>} {<Rd>}, <Rm>, <Rn>

where:

<c>, <q> See [Standard assembler syntax fields on page A8-287](#).

<Rd> The destination register.

<Rm> The first operand register.

<Rn> The second operand register.

## Operation

```
if ConditionPassed() then
    EncodingSpecificOperations();
    (doubled, sat1) = SignedSatQ(2 * SInt(R[n]), 32);
    (R[d], sat2) = SignedSatQ(SInt(R[m]) - SInt(doubled), 32);
    if sat1 || sat2 then
        APSR.Q = '1';
```

## Exceptions

None.

### A8.8.140 QSAX

Saturating Subtract and Add with Exchange exchanges the two halfwords of the second operand, performs one 16-bit integer subtraction and one 16-bit addition, saturates the results to the 16-bit signed integer range  $-2^{15} \leq x \leq 2^{15} - 1$ , and writes the results to the destination register.

**Encoding T1** ARMv6T2, ARMv7

QSAX<c> <Rd>, <Rn>, <Rm>

15	14	13	12	11	10	9	8	7	6	5	4	3	2	1	0	15	14	13	12	11	10	9	8	7	6	5	4	3	2	1	0
1	1	1	1	1	0	1	0	1	1	1	0	Rn				1	1	1	1	Rd				0	0	0	1	Rm			

d = UInt(Rd); n = UInt(Rn); m = UInt(Rm);  
if d IN {13,15} || n IN {13,15} || m IN {13,15} then UNPREDICTABLE;

**Encoding A1** ARMv6\*, ARMv7

QSAX<c> <Rd>, <Rn>, <Rm>

31	30	29	28	27	26	25	24	23	22	21	20	19	18	17	16	15	14	13	12	11	10	9	8	7	6	5	4	3	2	1	0
cond		0	1	1	0	0	0	1	0	Rn				Rd				(1)	(1)	(1)	(1)	0	1	0	1	Rm					

d = UInt(Rd); n = UInt(Rn); m = UInt(Rm);  
if d == 15 || n == 15 || m == 15 then UNPREDICTABLE;

## Assembler syntax

QSAX{<c>}{<q>} {<Rd>}, <Rn>, <Rm>

where:

<c>, <q> See *Standard assembler syntax fields* on page A8-287.

<Rd> The destination register.

<Rn> The first operand register.

<Rm> The second operand register.

The pre-UAL syntax QSUBADDX<c> is equivalent to QSAX<c>.

## Operation

```
if ConditionPassed() then
    EncodingSpecificOperations();
    sum = SInt(R[n]<15:0>) + SInt(R[m]<31:16>);
    diff = SInt(R[n]<31:16>) - SInt(R[m]<15:0>);
    R[d]<15:0> = SignedSat(sum, 16);
    R[d]<31:16> = SignedSat(diff, 16);
```

## Exceptions

None.

### A8.8.141 QSUB

Saturating Subtract subtracts one register value from another register value, saturates the result to the 32-bit signed integer range  $-2^{31} \leq x \leq 2^{31} - 1$ , and writes the result to the destination register. If saturation occurs, it sets the Q flag in the APSR.

**Encoding T1** ARMv6T2, ARMv7

QSUB<c> <Rd>, <Rm>, <Rn>

15	14	13	12	11	10	9	8	7	6	5	4	3	2	1	0	15	14	13	12	11	10	9	8	7	6	5	4	3	2	1	0
1	1	1	1	1	0	1	0	1	0	0	0	Rn				1	1	1	1	Rd				1	0	1	0	Rm			

d = UInt(Rd); n = UInt(Rn); m = UInt(Rm);  
if d IN {13,15} || n IN {13,15} || m IN {13,15} then UNPREDICTABLE;

**Encoding A1** ARMv5TE\*, ARMv6\*, ARMv7

QSUB<c> <Rd>, <Rm>, <Rn>

31	30	29	28	27	26	25	24	23	22	21	20	19	18	17	16	15	14	13	12	11	10	9	8	7	6	5	4	3	2	1	0
cond		0	0	0	1	0	0	1	0	Rn				Rd				(0)	(0)	(0)	(0)	0	1	0	1	Rm					

d = UInt(Rd); n = UInt(Rn); m = UInt(Rm);  
if d == 15 || n == 15 || m == 15 then UNPREDICTABLE;

## Assembler syntax

QSUB{<c>}{<q>} {<Rd>}, <Rm>, <Rn>

where:

<c>, <q> See *Standard assembler syntax fields* on page A8-287.

<Rd> The destination register.

<Rm> The first operand register.

<Rn> The second operand register.

## Operation

```
if ConditionPassed() then
    EncodingSpecificOperations();
    (R[d], sat) = SignedSatQ(SInt(R[m]) - SInt(R[n]), 32);
    if sat then
        APSR.Q = '1';
```

## Exceptions

None.

### A8.8.142 QSUB16

Saturating Subtract 16 performs two 16-bit integer subtractions, saturates the results to the 16-bit signed integer range  $-2^{15} \leq x \leq 2^{15} - 1$ , and writes the results to the destination register.

**Encoding T1** ARMv6T2, ARMv7

QSUB16<c> <Rd>, <Rn>, <Rm>

15	14	13	12	11	10	9	8	7	6	5	4	3	2	1	0	15	14	13	12	11	10	9	8	7	6	5	4	3	2	1	0
1	1	1	1	1	0	1	0	1	1	0	1	Rn			1	1	1	1	Rd			0	0	0	1	Rm					

d = UInt(Rd); n = UInt(Rn); m = UInt(Rm);  
if d IN {13,15} || n IN {13,15} || m IN {13,15} then UNPREDICTABLE;

**Encoding A1** ARMv6\*, ARMv7

QSUB16<c> <Rd>, <Rn>, <Rm>

31	30	29	28	27	26	25	24	23	22	21	20	19	18	17	16	15	14	13	12	11	10	9	8	7	6	5	4	3	2	1	0
cond		0	1	1	0	0	0	1	0	Rn			Rd			(1)	(1)	(1)	(1)	0	1	1	1	Rm							

d = UInt(Rd); n = UInt(Rn); m = UInt(Rm);  
if d == 15 || n == 15 || m == 15 then UNPREDICTABLE;



## Assembler syntax

QSUB16{<c>}{<q>} {<Rd>}, <Rn>, <Rm>

where:

<c>, <q> See [Standard assembler syntax fields on page A8-287](#).

<Rd> The destination register.

<Rn> The first operand register.

<Rm> The second operand register.

## Operation

```
if ConditionPassed() then
    EncodingSpecificOperations();
    diff1 = SInt(R[n]<15:0>) - SInt(R[m]<15:0>);
    diff2 = SInt(R[n]<31:16>) - SInt(R[m]<31:16>);
    R[d]<15:0> = SignedSat(diff1, 16);
    R[d]<31:16> = SignedSat(diff2, 16);
```

## Exceptions

None.

### A8.8.143 QSUB8

Saturating Subtract 8 performs four 8-bit integer subtractions, saturates the results to the 8-bit signed integer range  $-2^7 \leq x \leq 2^7 - 1$ , and writes the results to the destination register.

**Encoding T1** ARMv6T2, ARMv7

QSUB8<c> <Rd>, <Rn>, <Rm>

15	14	13	12	11	10	9	8	7	6	5	4	3	2	1	0	15	14	13	12	11	10	9	8	7	6	5	4	3	2	1	0
1	1	1	1	1	0	1	0	1	1	0	0	Rn			1	1	1	1	Rd			0	0	0	1	Rm					

d = UInt(Rd); n = UInt(Rn); m = UInt(Rm);  
if d IN {13,15} || n IN {13,15} || m IN {13,15} then UNPREDICTABLE;

**Encoding A1** ARMv6\*, ARMv7

QSUB8<c> <Rd>, <Rn>, <Rm>

31	30	29	28	27	26	25	24	23	22	21	20	19	18	17	16	15	14	13	12	11	10	9	8	7	6	5	4	3	2	1	0
cond		0	1	1	0	0	0	1	0	Rn			Rd			(1)	(1)	(1)	(1)	1	1	1	1	Rm							

d = UInt(Rd); n = UInt(Rn); m = UInt(Rm);  
if d == 15 || n == 15 || m == 15 then UNPREDICTABLE;

## Assembler syntax

QSUB8{<c>}{<q>} {<Rd>}, <Rn>, <Rm>

where:

<c>, <q> See [Standard assembler syntax fields on page A8-287](#).

<Rd> The destination register.

<Rn> The first operand register.

<Rm> The second operand register.

## Operation

```
if ConditionPassed() then
    EncodingSpecificOperations();
    diff1 = SInt(R[n]<7:0>) - SInt(R[m]<7:0>);
    diff2 = SInt(R[n]<15:8>) - SInt(R[m]<15:8>);
    diff3 = SInt(R[n]<23:16>) - SInt(R[m]<23:16>);
    diff4 = SInt(R[n]<31:24>) - SInt(R[m]<31:24>);
    R[d]<7:0> = SignedSat(diff1, 8);
    R[d]<15:8> = SignedSat(diff2, 8);
    R[d]<23:16> = SignedSat(diff3, 8);
    R[d]<31:24> = SignedSat(diff4, 8);
```

## Exceptions

None.

### A8.8.144 RBIT

Reverse Bits reverses the bit order in a 32-bit register.

#### Encoding T1 ARMv6T2, ARMv7

RBIT<c> <Rd>, <Rm>

15	14	13	12	11	10	9	8	7	6	5	4	3	2	1	0	15	14	13	12	11	10	9	8	7	6	5	4	3	2	1	0
1	1	1	1	1	0	1	0	1	0	0	1	Rm				1	1	1	1	Rd				1	0	1	0	Rm			

if !Consistent(Rm) then UNPREDICTABLE;  
d = UInt(Rd); m = UInt(Rm);  
if d IN {13,15} || m IN {13,15} then UNPREDICTABLE;

#### Encoding A1 ARMv6T2, ARMv7

RBIT<c> <Rd>, <Rm>

31	30	29	28	27	26	25	24	23	22	21	20	19	18	17	16	15	14	13	12	11	10	9	8	7	6	5	4	3	2	1	0
cond		0	1	1	0	1	1	1	1	(1)(1)(1)(1)				Rd				(1)(1)(1)(1)				0	0	1	1	Rm					

d = UInt(Rd); m = UInt(Rm);  
if d == 15 || m == 15 then UNPREDICTABLE;

## Assembler syntax

RBIT{<c>}{<q>} <Rd>, <Rm>

where:

<c>, <q> See *Standard assembler syntax fields* on page A8-287.

<Rd> The destination register.

<Rm> The register that contains the operand. In encoding T1, its number must be encoded twice.

## Operation

```
if ConditionPassed() then
    EncodingSpecificOperations();
    bits(32) result;
    for i = 0 to 31
        result<31-i> = R[m]<i>;
    R[d] = result;
```

## Exceptions

None.

### A8.8.145 REV

Byte-Reverse Word reverses the byte order in a 32-bit register.

#### Encoding T1 ARMv6\*, ARMv7

REV<c> <Rd>, <Rm>

15	14	13	12	11	10	9	8	7	6	5	4	3	2	1	0
1	0	1	1	1	0	1	0	0	0	Rm				Rd	

d = UInt(Rd); m = UInt(Rm);

#### Encoding T2 ARMv6T2, ARMv7

REV<c>.W <Rd>, <Rm>

15	14	13	12	11	10	9	8	7	6	5	4	3	2	1	0	15	14	13	12	11	10	9	8	7	6	5	4	3	2	1	0
1	1	1	1	1	0	1	0	1	0	0	1	Rm				1	1	1	1	Rd				1	0	0	0	Rm			

if !Consistent(Rm) then UNPREDICTABLE;  
d = UInt(Rd); m = UInt(Rm);  
if d IN {13,15} || m IN {13,15} then UNPREDICTABLE;

#### Encoding A1 ARMv6\*, ARMv7

REV<c> <Rd>, <Rm>

31	30	29	28	27	26	25	24	23	22	21	20	19	18	17	16	15	14	13	12	11	10	9	8	7	6	5	4	3	2	1	0
cond		0	1	1	0	1	0	1	1	(1)	(1)	(1)	(1)	Rd				(1)	(1)	(1)	(1)	0	0	1	1	Rm					

d = UInt(Rd); m = UInt(Rm);  
if d == 15 || m == 15 then UNPREDICTABLE;

## Assembler syntax

REV{<c>}{<q>} <Rd>, <Rm>

where:

<c>, <q> See *Standard assembler syntax fields* on page A8-287.

<Rd> The destination register.

<Rm> The register that contains the operand. Its number must be encoded twice in encoding T2.

## Operation

```
if ConditionPassed() then
    EncodingSpecificOperations();
    bits(32) result;
    result<31:24> = R[m]<7:0>;
    result<23:16> = R[m]<15:8>;
    result<15:8>  = R[m]<23:16>;
    result<7:0>  = R[m]<31:24>;
    R[d] = result;
```

## Exceptions

None.

### A8.8.146 REV16

Byte-Reverse Packed Halfword reverses the byte order in each 16-bit halfword of a 32-bit register.

**Encoding T1** ARMv6\*, ARMv7

REV16<c> <Rd>, <Rm>

15	14	13	12	11	10	9	8	7	6	5	4	3	2	1	0
1	0	1	1	1	0	1	0	0	1	Rm				Rd	

d = UInt(Rd); m = UInt(Rm);

**Encoding T2** ARMv6T2, ARMv7

REV16<c>.W <Rd>, <Rm>

15	14	13	12	11	10	9	8	7	6	5	4	3	2	1	0	15	14	13	12	11	10	9	8	7	6	5	4	3	2	1	0
1	1	1	1	1	0	1	0	1	0	0	1	Rm				1	1	1	1	Rd				1	0	0	1	Rm			

if !Consistent(Rm) then UNPREDICTABLE;  
d = UInt(Rd); m = UInt(Rm);  
if d IN {13,15} || m IN {13,15} then UNPREDICTABLE;

**Encoding A1** ARMv6\*, ARMv7

REV16<c> <Rd>, <Rm>

31	30	29	28	27	26	25	24	23	22	21	20	19	18	17	16	15	14	13	12	11	10	9	8	7	6	5	4	3	2	1	0
cond		0	1	1	0	1	0	1	1	(1)	(1)	(1)	(1)	Rd				(1)	(1)	(1)	(1)	1	0	1	1	Rm					

d = UInt(Rd); m = UInt(Rm);  
if d == 15 || m == 15 then UNPREDICTABLE;



## Assembler syntax

REV16{<c>}{<q>} <Rd>, <Rm>

where:

<c>, <q> See *Standard assembler syntax fields* on page A8-287.

<Rd> The destination register.

<Rm> The register that contains the operand. Its number must be encoded twice in encoding T2.

## Operation

```
if ConditionPassed() then
    EncodingSpecificOperations();
    bits(32) result;
    result<31:24> = R[m]<23:16>;
    result<23:16> = R[m]<31:24>;
    result<15:8>  = R[m]<7:0>;
    result<7:0>  = R[m]<15:8>;
    R[d] = result;
```

## Exceptions

None.

### A8.8.147 REVSH

Byte-Reverse Signed Halfword reverses the byte order in the lower 16-bit halfword of a 32-bit register, and sign-extends the result to 32 bits.

**Encoding T1** ARMv6\*, ARMv7

REVSH<c> <Rd>, <Rm>

15	14	13	12	11	10	9	8	7	6	5	4	3	2	1	0
1	0	1	1	1	0	1	0	1	1	Rm			Rd		

d = UInt(Rd); m = UInt(Rm);

**Encoding T2** ARMv6T2, ARMv7

REVSH<c>.W <Rd>, <Rm>

15	14	13	12	11	10	9	8	7	6	5	4	3	2	1	0	15	14	13	12	11	10	9	8	7	6	5	4	3	2	1	0
1	1	1	1	1	0	1	0	1	0	0	1	Rm			1	1	1	1	Rd			1	0	1	1	Rm					

if !Consistent(Rm) then UNPREDICTABLE;  
d = UInt(Rd); m = UInt(Rm);  
if d IN {13,15} || m IN {13,15} then UNPREDICTABLE;

**Encoding A1** ARMv6\*, ARMv7

REVSH<c> <Rd>, <Rm>

31	30	29	28	27	26	25	24	23	22	21	20	19	18	17	16	15	14	13	12	11	10	9	8	7	6	5	4	3	2	1	0
cond		0	1	1	0	1	1	1	1	(1)	(1)	(1)	(1)	Rd				(1)	(1)	(1)	(1)	1	0	1	1	Rm					

d = UInt(Rd); m = UInt(Rm);  
if d == 15 || m == 15 then UNPREDICTABLE;

## Assembler syntax

REVSH{<c>}{<q>} <Rd>, <Rm>

where:

<c>, <q> See *Standard assembler syntax fields* on page A8-287.

<Rd> The destination register.

<Rm> The register that contains the operand. Its number must be encoded twice in encoding T2.

## Operation

```
if ConditionPassed() then
    EncodingSpecificOperations();
    bits(32) result;
    result<31:8> = SignExtend(R[m]<7:0>, 24);
    result<7:0> = R[m]<15:8>;
    R[d] = result;
```

## Exceptions

None.

### A8.8.148 RFE

Return From Exception is a system instruction. For details see [RFE](#) on page B9-1998.

### A8.8.149 ROR (immediate)

Rotate Right (immediate) provides the value of the contents of a register rotated by a constant value. The bits that are rotated off the right end are inserted into the vacated bit positions on the left. It can optionally update the condition flags based on the result.

#### Encoding T1 ARMv6T2, ARMv7

ROR{S}<c> <Rd>, <Rm>, #<imm>

15	14	13	12	11	10	9	8	7	6	5	4	3	2	1	0	15	14	13	12	11	10	9	8	7	6	5	4	3	2	1	0
1	1	1	0	1	0	1	0	0	1	0	S	1	1	1	1	(0)	imm3			Rd			imm2		1	1	Rm				

```
if (imm3:imm2) == '00000' then SEE RRX;
d = UInt(Rd); m = UInt(Rm); setflags = (S == '1');
(-, shift_n) = DecodeImmShift('11', imm3:imm2);
if d IN {13,15} || m IN {13,15} then UNPREDICTABLE;
```

#### Encoding A1 ARMv4\*, ARMv5T\*, ARMv6\*, ARMv7

ROR{S}<c> <Rd>, <Rm>, #<imm>

31	30	29	28	27	26	25	24	23	22	21	20	19	18	17	16	15	14	13	12	11	10	9	8	7	6	5	4	3	2	1	0
cond		0	0	0	1	1	0	1	S	(0)	(0)	(0)	(0)	Rd			imm5			1	1	0	Rm								

```
if Rd == '1111' && S == '1' then SEE SUBS PC, LR and related instructions;
if imm5 == '00000' then SEE RRX;
d = UInt(Rd); m = UInt(Rm); setflags = (S == '1');
(-, shift_n) = DecodeImmShift('11', imm5);
```

## Assembler syntax

ROR{S}{<c>}{<q>} {<Rd>,} <Rm>, #<imm>

where:

S            If S is present, the instruction updates the flags. Otherwise, the flags are not updated.

<c>, <q>     See [Standard assembler syntax fields on page A8-287](#).

<Rd>        The destination register.

In ARM instructions, if S is not specified and <Rd> is the PC, the instruction is a branch to the address calculated by the operation. This is an interworking branch, see [Pseudocode details of operations on ARM core registers on page A2-47](#).

### ———— Note ————

Before ARMv7, this was a simple branch.

<Rm>        The first operand register. The PC can be used in ARM instructions.

<imm>       The shift amount, in the range 1 to 31. See [Shifts applied to a register on page A8-291](#).

## Operation

```
if ConditionPassed() then
    EncodingSpecificOperations();
    (result, carry) = Shift_C(R[m], SRTYPE_ROR, shift_n, APSR.C);
    if d == 15 then // Can only occur for ARM encoding
        ALUWritePC(result); // setflags is always FALSE here
    else
        R[d] = result;
        if setflags then
            APSR.N = result<31>;
            APSR.Z = IsZeroBit(result);
            APSR.C = carry;
            // APSR.V unchanged
```

## Exceptions

None.

### A8.8.150 ROR (register)

Rotate Right (register) provides the value of the contents of a register rotated by a variable number of bits. The bits that are rotated off the right end are inserted into the vacated bit positions on the left. The variable number of bits is read from the bottom byte of a register. It can optionally update the condition flags based on the result.

**Encoding T1** ARMv4T, ARMv5T\*, ARMv6\*, ARMv7

RORS <Rdn>, <Rm> Outside IT block.

ROR<c> <Rdn>, <Rm> Inside IT block.

15	14	13	12	11	10	9	8	7	6	5	4	3	2	1	0
0	1	0	0	0	0	0	0	1	1	1	Rm	Rdn			

d = UInt(Rdn); n = UInt(Rdn); m = UInt(Rm); setFlags = !InITBlock();

**Encoding T2** ARMv6T2, ARMv7

ROR{S}<c>.W <Rd>, <Rn>, <Rm>

15	14	13	12	11	10	9	8	7	6	5	4	3	2	1	0	15	14	13	12	11	10	9	8	7	6	5	4	3	2	1	0
1	1	1	1	1	0	1	0	0	1	1	S	Rn				1	1	1	1	Rd				0	0	0	0	Rm			

d = UInt(Rd); n = UInt(Rn); m = UInt(Rm); setFlags = (S == '1');  
if d IN {13,15} || n IN {13,15} || m IN {13,15} then UNPREDICTABLE;

**Encoding A1** ARMv4\*, ARMv5T\*, ARMv6\*, ARMv7

ROR{S}<c> <Rd>, <Rn>, <Rm>

31	30	29	28	27	26	25	24	23	22	21	20	19	18	17	16	15	14	13	12	11	10	9	8	7	6	5	4	3	2	1	0
cond		0	0	0	1	1	0	1	S	(0)	(0)	(0)	(0)	Rd				Rm				0	1	1	1	Rn					

d = UInt(Rd); n = UInt(Rn); m = UInt(Rm); setFlags = (S == '1');  
if d == 15 || n == 15 || m == 15 then UNPREDICTABLE;

## Assembler syntax

ROR{S}{<c>}{<q>} {<Rd>}, <Rn>, <Rm>

where:

S                    If S is present, the instruction updates the flags. Otherwise, the flags are not updated.

<c>, <q>            See *Standard assembler syntax fields* on page A8-287.

<Rd>                The destination register.

<Rn>                The first operand register.

<Rm>                The register whose bottom byte contains the amount to rotate by.

## Operation

```
if ConditionPassed() then
    EncodingSpecificOperations();
    shift_n = UInt(R[m]<7:0>);
    (result, carry) = Shift_C(R[n], SRTYPE_ROR, shift_n, APSR.C);
    R[d] = result;
    if setflags then
        APSR.N = result<31>;
        APSR.Z = IsZeroBit(result);
        APSR.C = carry;
        // APSR.V unchanged
```

## Exceptions

None.

### A8.8.151 RRX

Rotate Right with Extend provides the value of the contents of a register shifted right by one place, with the Carry flag shifted into bit[31].

RRX can optionally update the condition flags based on the result. In that case, bit[0] is shifted into the Carry flag.

#### Encoding T1 ARMv6T2, ARMv7

RRX{S}<c> <Rd>, <Rm>

15	14	13	12	11	10	9	8	7	6	5	4	3	2	1	0	15	14	13	12	11	10	9	8	7	6	5	4	3	2	1	0																
1	1	1	0	1	0	1	0	0	1	0	S	1	1	1	1	(0)	0	0	0												Rd																Rm

d = UInt(Rd); m = UInt(Rm); setflags = (S == '1');  
if d IN {13,15} || m IN {13,15} then UNPREDICTABLE;

#### Encoding A1 ARMv4\*, ARMv5T\*, ARMv6\*, ARMv7

RRX{S}<c> <Rd>, <Rm>

31	30	29	28	27	26	25	24	23	22	21	20	19	18	17	16	15	14	13	12	11	10	9	8	7	6	5	4	3	2	1	0																			
cond				0	0	0	1	1	0	1	S	(0)	(0)	(0)	(0)																		Rd																	Rm

if Rd == '1111' && S == '1' then SEE SUBS PC, LR and related instructions;  
d = UInt(Rd); m = UInt(Rm); setflags = (S == '1');



## Assembler syntax

RRX{S}{<c>}{<q>} {<Rd>}, <Rm>

where:

S            If S is present, the instruction updates the flags. Otherwise, the flags are not updated.

<c>, <q>     See *Standard assembler syntax fields on page A8-287*.

<Rd>        The destination register.

In ARM instructions, if S is not specified and <Rd> is the PC, the instruction is a branch to the address calculated by the operation. This is an interworking branch, see *Pseudocode details of operations on ARM core registers on page A2-47*.

### ———— Note ————

Before ARMv7, this was a simple branch.

<Rm>        The register that contains the operand. The PC can be used in ARM instructions.

## Operation

```
if ConditionPassed() then
    EncodingSpecificOperations();
    (result, carry) = Shift_C(R[m], SRTYPE_RRX, 1, APSR.C);
    if d == 15 then // Can only occur for ARM encoding
        ALUWritePC(result); // setflags is always FALSE here
    else
        R[d] = result;
        if setflags then
            APSR.N = result<31>;
            APSR.Z = IsZeroBit(result);
            APSR.C = carry;
            // APSR.V unchanged
```

## Exceptions

None.

### A8.8.152 RSB (immediate)

Reverse Subtract (immediate) subtracts a register value from an immediate value, and writes the result to the destination register. It can optionally update the condition flags based on the result.

**Encoding T1** ARMv4T, ARMv5T\*, ARMv6\*, ARMv7  
RSBS <Rd>, <Rn>, #0 Outside IT block.  
RSB<c> <Rd>, <Rn>, #0 Inside IT block.

15	14	13	12	11	10	9	8	7	6	5	4	3	2	1	0
0	1	0	0	0	0	1	0	0	1	Rn				Rd	

d = UInt(Rd); n = UInt(Rn); setflags = !InITBlock(); imm32 = Zeros(32); // immediate = #0

**Encoding T2** ARMv6T2, ARMv7  
RSB{S}<c>.W <Rd>, <Rn>, #<const>

15	14	13	12	11	10	9	8	7	6	5	4	3	2	1	0	15	14	13	12	11	10	9	8	7	6	5	4	3	2	1	0
1	1	1	1	0	i	0	1	1	1	0	S	Rn				0	imm3			Rd		imm8									

d = UInt(Rd); n = UInt(Rn); setflags = (S == '1'); imm32 = ThumbExpandImm(i:imm3:imm8);  
if d IN {13,15} || n IN {13,15} then UNPREDICTABLE;

**Encoding A1** ARMv4\*, ARMv5T\*, ARMv6\*, ARMv7  
RSB{S}<c> <Rd>, <Rn>, #<const>

31	30	29	28	27	26	25	24	23	22	21	20	19	18	17	16	15	14	13	12	11	10	9	8	7	6	5	4	3	2	1	0
cond		0	0	1	0	0	1	1	S	Rn				Rd				imm12													

if Rd == '1111' && S == '1' then SEE SUBS PC, LR and related instructions;  
d = UInt(Rd); n = UInt(Rn); setflags = (S == '1'); imm32 = ARMEExpandImm(imm12);

## Assembler syntax

RSB{S}{<c>}{<q>} {<Rd>}, <Rn>, #<const>

where:

- S            If S is present, the instruction updates the flags. Otherwise, the flags are not updated.
- <c>, <q>      See *Standard assembler syntax fields* on page A8-287.
- <Rd>        The destination register. If S is specified and <Rd> is the PC, see *SUBS PC, LR (Thumb)* on page B9-2008 or *SUBS PC, LR and related instructions (ARM)* on page B9-2010.  
In ARM instructions, if S is not specified and <Rd> is the PC, the instruction is a branch to the address calculated by the operation. This is an interworking branch, see *Pseudocode details of operations on ARM core registers* on page A2-47.
- **Note** ————
- Before ARMv7, this was a simple branch.
- 
- <Rn>        The first operand register. The PC can be used in ARM instructions.
- <const>     The immediate value to be added to the value obtained from <Rn>. The only permitted value for encoding T1 is 0. See *Modified immediate constants in Thumb instructions* on page A6-232 or *Modified immediate constants in ARM instructions* on page A5-200 for the range of values for encoding T2 or A1.

The pre-UAL syntax RSB<c>S is equivalent to RSBS<c>.

## Operation

```

if ConditionPassed() then
    EncodingSpecificOperations();
    (result, carry, overflow) = AddWithCarry(NOT(R[n]), imm32, '1');
    if d == 15 then           // Can only occur for ARM encoding
        ALUWritePC(result); // setflags is always FALSE here
    else
        R[d] = result;
        if setflags then
            APSR.N = result<31>;
            APSR.Z = IsZeroBit(result);
            APSR.C = carry;
            APSR.V = overflow;

```

## Exceptions

None.

### A8.8.153 RSB (register)

Reverse Subtract (register) subtracts a register value from an optionally-shifted register value, and writes the result to the destination register. It can optionally update the condition flags based on the result.

#### Encoding T1 ARMv6T2, ARMv7

RSB{S}<c> <Rd>, <Rn>, <Rm>{, <shift>}

15	14	13	12	11	10	9	8	7	6	5	4	3	2	1	0	15	14	13	12	11	10	9	8	7	6	5	4	3	2	1	0
1	1	1	0	1	0	1	1	1	1	0	S	Rn				(0)	imm3			Rd			imm2		type	Rm					

```
d = UInt(Rd); n = UInt(Rn); m = UInt(Rm); setflags = (S == '1');
(shift_t, shift_n) = DecodeImmShift(type, imm3:imm2);
if d IN {13,15} || n IN {13,15} || m IN {13,15} then UNPREDICTABLE;
```

#### Encoding A1 ARMv4\*, ARMv5T\*, ARMv6\*, ARMv7

RSB{S}<c> <Rd>, <Rn>, <Rm>{, <shift>}

31	30	29	28	27	26	25	24	23	22	21	20	19	18	17	16	15	14	13	12	11	10	9	8	7	6	5	4	3	2	1	0
cond				0	0	0	0	0	1	1	S	Rn				Rd				imm5					type	0	Rm				

```
if Rd == '1111' && S == '1' then SEE SUBS PC, LR and related instructions;
d = UInt(Rd); n = UInt(Rn); m = UInt(Rm); setflags = (S == '1');
(shift_t, shift_n) = DecodeImmShift(type, imm5);
```

## Assembler syntax

RSB{S}{<c>}{<q>} {<Rd>,<Rn>, <Rm> {, <shift>}

where:

- S            If S is present, the instruction updates the flags. Otherwise, the flags are not updated.
- <c>, <q>      See *Standard assembler syntax fields* on page A8-287.
- <Rd>         The destination register. If S is specified and <Rd> is the PC, see *SUBS PC, LR (Thumb)* on page B9-2008 or *SUBS PC, LR and related instructions (ARM)* on page B9-2010.  
In ARM instructions, if S is not specified and <Rd> is the PC, the instruction is a branch to the address calculated by the operation. This is an interworking branch, see *Pseudocode details of operations on ARM core registers* on page A2-47.
- **Note** —————
- Before ARMv7, this was a simple branch.
- 
- <Rn>         The first operand register. The PC can be used in ARM instructions.
- <Rm>         The register that is optionally shifted and used as the second operand. The PC can be used in ARM instructions.
- <shift>       The shift to apply to the value read from <Rm>. If omitted, no shift is applied. *Shifts applied to a register* on page A8-291 describes the shifts and how they are encoded.

The pre-UAL syntax RSB<c>S is equivalent to RSBS<c>.

## Operation

```
if ConditionPassed() then
    EncodingSpecificOperations();
    shifted = Shift(R[m], shift_t, shift_n, APSR.C);
    (result, carry, overflow) = AddWithCarry(NOT(R[n]), shifted, '1');
    if d == 15 then // Can only occur for ARM encoding
        ALUWritePC(result); // setflags is always FALSE here
    else
        R[d] = result;
        if setflags then
            APSR.N = result<31>;
            APSR.Z = IsZeroBit(result);
            APSR.C = carry;
            APSR.V = overflow;
```

## Exceptions

None.

### A8.8.154 RSB (register-shifted register)

Reverse Subtract (register-shifted register) subtracts a register value from a register-shifted register value, and writes the result to the destination register. It can optionally update the condition flags based on the result.

**Encoding A1** ARMv4\*, ARMv5T\*, ARMv6\*, ARMv7

RSB{S}<c> <Rd>, <Rn>, <Rm>, <type> <Rs>

31	30	29	28	27	26	25	24	23	22	21	20	19	18	17	16	15	14	13	12	11	10	9	8	7	6	5	4	3	2	1	0
cond				0	0	0	0	0	1	1	S	Rn				Rd				Rs				0	type		1	Rm			

```
d = UInt(Rd); n = UInt(Rn); m = UInt(Rm); s = UInt(Rs);
setflags = (S == '1'); shift_t = DecodeRegShift(type);
if d == 15 || n == 15 || m == 15 || s == 15 then UNPREDICTABLE;
```

## Assembler syntax

RSB{S}{<c>}{<q>} {<Rd>}, <Rn>, <Rm>, <type> <Rs>

where:

S If S is present, the instruction updates the flags. Otherwise, the flags are not updated.

<c>, <q> See [Standard assembler syntax fields on page A8-287](#).

<Rd> The destination register.

<Rn> The first operand register.

<Rm> The register that is shifted and used as the second operand.

<type> The type of shift to apply to the value read from <Rm>. It must be one of:

ASR Arithmetic shift right, encoded as type = 0b10.

LSL Logical shift left, encoded as type = 0b00.

LSR Logical shift right, encoded as type = 0b01.

ROR Rotate right, encoded as type = 0b11.

<Rs> The register whose bottom byte contains the amount to shift by.

The pre-UAL syntax RSB<c>S is equivalent to RSBS<c>.

## Operation

```
if ConditionPassed() then
    EncodingSpecificOperations();
    shift_n = UInt(R[s]<7:0>);
    shifted = Shift(R[m], shift_t, shift_n, APSR.C);
    (result, carry, overflow) = AddWithCarry(NOT(R[n]), shifted, '1');
    R[d] = result;
    if setflags then
        APSR.N = result<31>;
        APSR.Z = IsZeroBit(result);
        APSR.C = carry;
        APSR.V = overflow;
```

## Exceptions

None.

### A8.8.155 RSC (immediate)

Reverse Subtract with Carry (immediate) subtracts a register value and the value of NOT (Carry flag) from an immediate value, and writes the result to the destination register. It can optionally update the condition flags based on the result.

**Encoding A1** ARMv4\*, ARMv5T\*, ARMv6\*, ARMv7

RSC{S}<c> <Rd>, <Rn>, #<const>

31	30	29	28	27	26	25	24	23	22	21	20	19	18	17	16	15	14	13	12	11	10	9	8	7	6	5	4	3	2	1	0
cond				0	0	1	0	1	1	1	S	Rn				Rd				imm12											

if Rd == '1111' && S == '1' then SEE SUBS PC, LR and related instructions;  
d = UInt(Rd); n = UInt(Rn); setflags = (S == '1'); imm32 = ARMEExpandImm(imm12);



## Assembler syntax

RSC{S}{<C>}{<q>} {<Rd>,<Rn>, #<const>

where:

S If S is present, the instruction updates the flags. Otherwise, the flags are not updated.

<C>, <q> See [Standard assembler syntax fields on page A8-287](#).

<Rd> The destination register. If S is specified and <Rd> is the PC, see [SUBS PC, LR \(Thumb\) on page B9-2008](#) or [SUBS PC, LR and related instructions \(ARM\) on page B9-2010](#).

<Rn> The first operand register. The PC can be used.

<const> The immediate value that the value obtained from <Rn> is to be subtracted from. See [Modified immediate constants in ARM instructions on page A5-200](#) for the range of values.

The pre-UAL syntax RSC<C>S is equivalent to RSCS<C>.

## Operation

```
if ConditionPassed() then
    EncodingSpecificOperations();
    (result, carry, overflow) = AddWithCarry(NOT(R[n]), imm32, APSR.C);
    if d == 15 then
        ALUWritePC(result); // setflags is always FALSE here
    else
        R[d] = result;
        if setflags then
            APSR.N = result<31>;
            APSR.Z = IsZeroBit(result);
            APSR.C = carry;
            APSR.V = overflow;
```

## Exceptions

None.

### A8.8.156 RSC (register)

Reverse Subtract with Carry (register) subtracts a register value and the value of NOT (Carry flag) from an optionally-shifted register value, and writes the result to the destination register. It can optionally update the condition flags based on the result.

**Encoding A1** ARMv4\*, ARMv5T\*, ARMv6\*, ARMv7

RSC{S}<C> <Rd>, <Rn>, <Rm>{, <shift>}

31	30	29	28	27	26	25	24	23	22	21	20	19	18	17	16	15	14	13	12	11	10	9	8	7	6	5	4	3	2	1	0
cond				0	0	0	0	1	1	1	S	Rn				Rd				imm5				type	0	Rm					

```
if Rd == '1111' && S == '1' then SEE SUBS PC, LR and related instructions;
d = UInt(Rd); n = UInt(Rn); m = UInt(Rm); setflags = (S == '1');
(shift_t, shift_n) = DecodeImmShift(type, imm5);
```

## Assembler syntax

RSC{S}{<c>}{<q>} {<Rd>}, <Rn>, <Rm> {, <shift>}

where:

S If S is present, the instruction updates the flags. Otherwise, the flags are not updated.

<c>, <q> See *Standard assembler syntax fields* on page A8-287.

<Rd> The destination register. If S is specified and <Rd> is the PC, see *SUBS PC, LR (Thumb)* on page B9-2008 or *SUBS PC, LR and related instructions (ARM)* on page B9-2010.

In ARM instructions, if S is not specified and <Rd> is the PC, the instruction is a branch to the address calculated by the operation. This is an interworking branch, see *Pseudocode details of operations on ARM core registers* on page A2-47.

———— **Note** —————

Before ARMv7, this was a simple branch.

<Rn> The first operand register. The PC can be used.

<Rm> The register that is optionally shifted and used as the second operand. The PC can be used.

<shift> The shift to apply to the value read from <Rm>. If omitted, no shift is applied. *Shifts applied to a register* on page A8-291 describes the shifts and how they are encoded.

The pre-UAL syntax RSC<c>S is equivalent to RSCS<c>.

## Operation

```
if ConditionPassed() then
    EncodingSpecificOperations();
    shifted = Shift(R[m], shift_t, shift_n, APSR.C);
    (result, carry, overflow) = AddWithCarry(NOT(R[n]), shifted, APSR.C);
    if d == 15 then
        ALUWritePC(result); // setflags is always FALSE here
    else
        R[d] = result;
        if setflags then
            APSR.N = result<31>;
            APSR.Z = IsZeroBit(result);
            APSR.C = carry;
            APSR.V = overflow;
```

## Exceptions

None.

### A8.8.157 RSC (register-shifted register)

Reverse Subtract (register-shifted register) subtracts a register value and the value of NOT (Carry flag) from a register-shifted register value, and writes the result to the destination register. It can optionally update the condition flags based on the result.

**Encoding A1** ARMv4\*, ARMv5T\*, ARMv6\*, ARMv7

RSC{S}<C> <Rd>, <Rn>, <Rm>, <type> <Rs>

31	30	29	28	27	26	25	24	23	22	21	20	19	18	17	16	15	14	13	12	11	10	9	8	7	6	5	4	3	2	1	0
cond				0	0	0	0	1	1	1	S	Rn				Rd				Rs				0	type		1	Rm			

```
d = UInt(Rd); n = UInt(Rn); m = UInt(Rm); s = UInt(Rs);
setflags = (S == '1'); shift_t = DecodeRegShift(type);
if d == 15 || n == 15 || m == 15 || s == 15 then UNPREDICTABLE;
```

## Assembler syntax

RSC{S}{<c>}{<q>} {<Rd>}, <Rn>, <Rm>, <type> <Rs>

where:

S If S is present, the instruction updates the flags. Otherwise, the flags are not updated.

<c>, <q> See *Standard assembler syntax fields* on page A8-287.

<Rd> The destination register.

<Rn> The first operand register.

<Rm> The register that is shifted and used as the second operand.

<type> The type of shift to apply to the value read from <Rm>. It must be one of:

ASR Arithmetic shift right, encoded as type = 0b10.

LSL Logical shift left, encoded as type = 0b00.

LSR Logical shift right, encoded as type = 0b01.

ROR Rotate right, encoded as type = 0b11.

<Rs> The register whose bottom byte contains the amount to shift by.

The pre-UAL syntax RSC<c>S is equivalent to RSCS<c>.

## Operation

```
if ConditionPassed() then
    EncodingSpecificOperations();
    shift_n = UInt(R[s]<7:0>);
    shifted = Shift(R[m], shift_t, shift_n, APSR.C);
    (result, carry, overflow) = AddWithCarry(NOT(R[n]), shifted, APSR.C);
    R[d] = result;
    if setflags then
        APSR.N = result<31>;
        APSR.Z = IsZeroBit(result);
        APSR.C = carry;
        APSR.V = overflow;
```

## Exceptions

None.

### A8.8.158 SADD16

Signed Add 16 performs two 16-bit signed integer additions, and writes the results to the destination register. It sets the APSR.GE bits according to the results of the additions.

#### Encoding T1 ARMv6T2, ARMv7

SADD16<c> <Rd>, <Rn>, <Rm>

15	14	13	12	11	10	9	8	7	6	5	4	3	2	1	0	15	14	13	12	11	10	9	8	7	6	5	4	3	2	1	0
1	1	1	1	1	0	1	0	1	0	0	1	Rn				1	1	1	1	Rd				0	0	0	0	Rm			

d = UInt(Rd); n = UInt(Rn); m = UInt(Rm);  
if d IN {13,15} || n IN {13,15} || m IN {13,15} then UNPREDICTABLE;

#### Encoding A1 ARMv6\*, ARMv7

SADD16<c> <Rd>, <Rn>, <Rm>

31	30	29	28	27	26	25	24	23	22	21	20	19	18	17	16	15	14	13	12	11	10	9	8	7	6	5	4	3	2	1	0
cond		0	1	1	0	0	0	0	1	Rn				Rd				(1)	(1)	(1)	(1)	0	0	0	1	Rm					

d = UInt(Rd); n = UInt(Rn); m = UInt(Rm);  
if d == 15 || n == 15 || m == 15 then UNPREDICTABLE;

## Assembler syntax

SADD16{<c>}{<q>} {<Rd>}, <Rn>, <Rm>

where:

<c>, <q> See *Standard assembler syntax fields* on page A8-287.

<Rd> The destination register.

<Rn> The first operand register.

<Rm> The second operand register.

## Operation

```
if ConditionPassed() then
    EncodingSpecificOperations();
    sum1 = SInt(R[n]<15:0>) + SInt(R[m]<15:0>);
    sum2 = SInt(R[n]<31:16>) + SInt(R[m]<31:16>);
    R[d]<15:0> = sum1<15:0>;
    R[d]<31:16> = sum2<15:0>;
    APSR.GE<1:0> = if sum1 >= 0 then '11' else '00';
    APSR.GE<3:2> = if sum2 >= 0 then '11' else '00';
```

## Exceptions

None.

### A8.8.159 SADD8

Signed Add 8 performs four 8-bit signed integer additions, and writes the results to the destination register. It sets the APSR.GE bits according to the results of the additions.

#### Encoding T1 ARMv6T2, ARMv7

SADD8<c> <Rd>, <Rn>, <Rm>

15	14	13	12	11	10	9	8	7	6	5	4	3	2	1	0	15	14	13	12	11	10	9	8	7	6	5	4	3	2	1	0
1	1	1	1	1	0	1	0	1	0	0	0	Rn			1	1	1	1	Rd			0	0	0	0	Rm					

d = UInt(Rd); n = UInt(Rn); m = UInt(Rm);  
if d IN {13,15} || n IN {13,15} || m IN {13,15} then UNPREDICTABLE;

#### Encoding A1 ARMv6\*, ARMv7

SADD8<c> <Rd>, <Rn>, <Rm>

31	30	29	28	27	26	25	24	23	22	21	20	19	18	17	16	15	14	13	12	11	10	9	8	7	6	5	4	3	2	1	0
cond		0	1	1	0	0	0	0	1	Rn			Rd			(1)	(1)	(1)	(1)	1	0	0	1	Rm							

d = UInt(Rd); n = UInt(Rn); m = UInt(Rm);  
if d == 15 || n == 15 || m == 15 then UNPREDICTABLE;



## Assembler syntax

SADD8{<c>}{<q>} {<Rd>}, <Rn>, <Rm>

where:

<c>, <q> See [Standard assembler syntax fields](#) on page A8-287.

<Rd> The destination register.

<Rn> The first operand register.

<Rm> The second operand register.

## Operation

```
if ConditionPassed() then
    EncodingSpecificOperations();
    sum1 = SInt(R[n]<7:0>) + SInt(R[m]<7:0>);
    sum2 = SInt(R[n]<15:8>) + SInt(R[m]<15:8>);
    sum3 = SInt(R[n]<23:16>) + SInt(R[m]<23:16>);
    sum4 = SInt(R[n]<31:24>) + SInt(R[m]<31:24>);
    R[d]<7:0> = sum1<7:0>;
    R[d]<15:8> = sum2<7:0>;
    R[d]<23:16> = sum3<7:0>;
    R[d]<31:24> = sum4<7:0>;
    APSR.GE<0> = if sum1 >= 0 then '1' else '0';
    APSR.GE<1> = if sum2 >= 0 then '1' else '0';
    APSR.GE<2> = if sum3 >= 0 then '1' else '0';
    APSR.GE<3> = if sum4 >= 0 then '1' else '0';
```

## Exceptions

None.

### A8.8.160 SASX

Signed Add and Subtract with Exchange exchanges the two halfwords of the second operand, performs one 16-bit integer addition and one 16-bit subtraction, and writes the results to the destination register. It sets the APSR.GE bits according to the results.

#### Encoding T1 ARMv6T2, ARMv7

SASX<c> <Rd>, <Rn>, <Rm>

15	14	13	12	11	10	9	8	7	6	5	4	3	2	1	0	15	14	13	12	11	10	9	8	7	6	5	4	3	2	1	0
1	1	1	1	1	0	1	0	1	0	1	0	Rn			1	1	1	1	Rd			0	0	0	0	Rm					

d = UInt(Rd); n = UInt(Rn); m = UInt(Rm);  
if d IN {13,15} || n IN {13,15} || m IN {13,15} then UNPREDICTABLE;

#### Encoding A1 ARMv6\*, ARMv7

SASX<c> <Rd>, <Rn>, <Rm>

31	30	29	28	27	26	25	24	23	22	21	20	19	18	17	16	15	14	13	12	11	10	9	8	7	6	5	4	3	2	1	0
cond		0	1	1	0	0	0	0	1	Rn			Rd			(1)	(1)	(1)	(1)	0	0	1	1	Rm							

d = UInt(Rd); n = UInt(Rn); m = UInt(Rm);  
if d == 15 || n == 15 || m == 15 then UNPREDICTABLE;

## Assembler syntax

SASX{<c>}{<q>} {<Rd>}, <Rn>, <Rm>

where:

<c>, <q> See *Standard assembler syntax fields* on page A8-287.

<Rd> The destination register.

<Rn> The first operand register.

<Rm> The second operand register.

The pre-UAL syntax SADDSUBX<c> is equivalent to SASX<c>.

## Operation

```
if ConditionPassed() then
    EncodingSpecificOperations();
    diff = SInt(R[n]<15:0>) - SInt(R[m]<31:16>);
    sum = SInt(R[n]<31:16>) + SInt(R[m]<15:0>);
    R[d]<15:0> = diff<15:0>;
    R[d]<31:16> = sum<15:0>;
    APSR.GE<1:0> = if diff >= 0 then '11' else '00';
    APSR.GE<3:2> = if sum >= 0 then '11' else '00';
```

## Exceptions

None.

### A8.8.161 SBC (immediate)

Subtract with Carry (immediate) subtracts an immediate value and the value of NOT (Carry flag) from a register value, and writes the result to the destination register. It can optionally update the condition flags based on the result.

#### Encoding T1 ARMv6T2, ARMv7

SBC{S}<c> <Rd>, <Rn>, #<const>

15	14	13	12	11	10	9	8	7	6	5	4	3	2	1	0	15	14	13	12	11	10	9	8	7	6	5	4	3	2	1	0
1	1	1	1	0	i	0	1	0	1	1	S	Rn				0	imm3			Rd			imm8								

d = UInt(Rd); n = UInt(Rn); setflags = (S == '1'); imm32 = ThumbExpandImm(i:imm3:imm8);  
if d IN {13,15} || n IN {13,15} then UNPREDICTABLE;

#### Encoding A1 ARMv4\*, ARMv5T\*, ARMv6\*, ARMv7

SBC{S}<c> <Rd>, <Rn>, #<const>

31	30	29	28	27	26	25	24	23	22	21	20	19	18	17	16	15	14	13	12	11	10	9	8	7	6	5	4	3	2	1	0
cond		0	0	1	0	1	1	0	S	Rn				Rd				imm12													

if Rd == '1111' && S == '1' then SEE SUBS PC, LR and related instructions;  
d = UInt(Rd); n = UInt(Rn); setflags = (S == '1'); imm32 = ARMEExpandImm(imm12);

## Assembler syntax

SBC{S}{<c>}{<q>} {<Rd>}, <Rn>, #<const>

where:

- S            If S is present, the instruction updates the flags. Otherwise, the flags are not updated.
- <c>, <q>     See *Standard assembler syntax fields* on page A8-287.
- <Rd>        The destination register. If S is specified and <Rd> is the PC, see *SUBS PC, LR (Thumb)* on page B9-2008 or *SUBS PC, LR and related instructions (ARM)* on page B9-2010.  
In ARM instructions, if S is not specified and <Rd> is the PC, the instruction is a branch to the address calculated by the operation. This is an interworking branch, see *Pseudocode details of operations on ARM core registers* on page A2-47.
- **Note** —————  
Before ARMv7, this was a simple branch.
- <Rn>        The first operand register. The PC can be used in ARM instructions.
- <const>     The immediate value to be subtracted from the value obtained from <Rn>. See *Modified immediate constants in Thumb instructions* on page A6-232 or *Modified immediate constants in ARM instructions* on page A5-200 for the range of values.

The pre-UAL syntax SBC<c>S is equivalent to SBCS<c>.

## Operation

```
if ConditionPassed() then
    EncodingSpecificOperations();
    (result, carry, overflow) = AddWithCarry(R[n], NOT(imm32), APSR.C);
    if d == 15 then           // Can only occur for ARM encoding
        ALUWritePC(result); // setflags is always FALSE here
    else
        R[d] = result;
        if setflags then
            APSR.N = result<31>;
            APSR.Z = IsZeroBit(result);
            APSR.C = carry;
            APSR.V = overflow;
```

## Exceptions

None.

### A8.8.162 SBC (register)

Subtract with Carry (register) subtracts an optionally-shifted register value and the value of NOT (Carry flag) from a register value, and writes the result to the destination register. It can optionally update the condition flags based on the result.

#### Encoding T1 ARMv4T, ARMv5T\*, ARMv6\*, ARMv7

SBCS <Rdn>, <Rm> Outside IT block.  
SBC<c> <Rdn>, <Rm> Inside IT block.

15	14	13	12	11	10	9	8	7	6	5	4	3	2	1	0
0	1	0	0	0	0	0	1	1	0	Rm				Rdn	

d = UInt(Rdn); n = UInt(Rdn); m = UInt(Rm); setflags = !InITBlock();  
(shift\_t, shift\_n) = (SRTYPE\_LSL, 0);

#### Encoding T2 ARMv6T2, ARMv7

SBC{S}<c>.W <Rd>, <Rn>, <Rm>{, <shift>}

15	14	13	12	11	10	9	8	7	6	5	4	3	2	1	0	15	14	13	12	11	10	9	8	7	6	5	4	3	2	1	0
1	1	1	0	1	0	1	1	S		Rn		(0)	imm3		Rd		imm2	type		Rm											

d = UInt(Rd); n = UInt(Rn); m = UInt(Rm); setflags = (S == '1');  
(shift\_t, shift\_n) = DecodeImmShift(type, imm3:imm2);  
if d IN {13,15} || n IN {13,15} || m IN {13,15} then UNPREDICTABLE;

#### Encoding A1 ARMv4\*, ARMv5T\*, ARMv6\*, ARMv7

SBC{S}<c> <Rd>, <Rn>, <Rm>{, <shift>}

31	30	29	28	27	26	25	24	23	22	21	20	19	18	17	16	15	14	13	12	11	10	9	8	7	6	5	4	3	2	1	0	
cond		0	0	0	0	1	1	0	S		Rn		Rd		imm5		type	0		Rm												

if Rd == '1111' && S == '1' then SEE SUBS PC, LR and related instructions;  
d = UInt(Rd); n = UInt(Rn); m = UInt(Rm); setflags = (S == '1');  
(shift\_t, shift\_n) = DecodeImmShift(type, imm5);

## Assembler syntax

SBC{S}{<c>}{<q>} {<Rd>}, <Rn>, <Rm> {, <shift>}

where:

- S            If S is present, the instruction updates the flags. Otherwise, the flags are not updated.
- <c>, <q>     See *Standard assembler syntax fields* on page A8-287.
- <Rd>        The destination register. If S is specified and <Rd> is the PC, see *SUBS PC, LR (Thumb)* on page B9-2008 or *SUBS PC, LR and related instructions (ARM)* on page B9-2010.  
In ARM instructions, if S is not specified and <Rd> is the PC, the instruction is a branch to the address calculated by the operation. This is an interworking branch, see *Pseudocode details of operations on ARM core registers* on page A2-47.
- **Note** —————
- Before ARMv7, this was a simple branch.
- 
- <Rn>        The first operand register. The PC can be used in ARM instructions.
- <Rm>        The register that is optionally shifted and used as the second operand. The PC can be used in ARM instructions.
- <shift>     The shift to apply to the value read from <Rm>. If present, encoding T1 is not permitted. If absent, no shift is applied and all encodings are permitted. *Shifts applied to a register* on page A8-291 describes the shifts and how they are encoded.

The pre-UAL syntax SBC<c>S is equivalent to SBCS<c>.

## Operation

```

if ConditionPassed() then
    EncodingSpecificOperations();
    shifted = Shift(R[m], shift_t, shift_n, APSR.C);
    (result, carry, overflow) = AddWithCarry(R[n], NOT(shifted), APSR.C);
    if d == 15 then // Can only occur for ARM encoding
        ALUWritePC(result); // setflags is always FALSE here
    else
        R[d] = result;
        if setflags then
            APSR.N = result<31>;
            APSR.Z = IsZeroBit(result);
            APSR.C = carry;
            APSR.V = overflow;

```

## Exceptions

None.

### A8.8.163 SBC (register-shifted register)

Subtract with Carry (register-shifted register) subtracts a register-shifted register value and the value of NOT (Carry flag) from a register value, and writes the result to the destination register. It can optionally update the condition flags based on the result.

**Encoding A1** ARMv4\*, ARMv5T\*, ARMv6\*, ARMv7

SBC{S}<C> <Rd>, <Rn>, <Rm>, <type> <Rs>

31	30	29	28	27	26	25	24	23	22	21	20	19	18	17	16	15	14	13	12	11	10	9	8	7	6	5	4	3	2	1	0
cond				0	0	0	0	1	1	0	S	Rn				Rd				Rs				0	type		1	Rm			

```
d = UInt(Rd); n = UInt(Rn); m = UInt(Rm); s = UInt(Rs);
setflags = (S == '1'); shift_t = DecodeRegShift(type);
if d == 15 || n == 15 || m == 15 || s == 15 then UNPREDICTABLE;
```



## Assembler syntax

SBC{S}{<c>}{<q>} {<Rd>}, <Rn>, <Rm>, <type> <Rs>

where:

S If S is present, the instruction updates the flags. Otherwise, the flags are not updated.

<c>, <q> See *Standard assembler syntax fields on page A8-287*.

<Rd> The destination register.

<Rn> The first operand register.

<Rm> The register that is shifted and used as the second operand.

<type> The type of shift to apply to the value read from <Rm>. It must be one of:

ASR Arithmetic shift right, encoded as type = 0b10.

LSL Logical shift left, encoded as type = 0b00.

LSR Logical shift right, encoded as type = 0b01.

ROR Rotate right, encoded as type = 0b11.

<Rs> The register whose bottom byte contains the amount to shift by.

The pre-UAL syntax SBC<c>S is equivalent to SBCS<c>.

## Operation

```
if ConditionPassed() then
    EncodingSpecificOperations();
    shift_n = UInt(R[s]<7:0>);
    shifted = Shift(R[m], shift_t, shift_n, APSR.C);
    (result, carry, overflow) = AddWithCarry(R[n], NOT(shifted), APSR.C);
    R[d] = result;
    if setflags then
        APSR.N = result<31>;
        APSR.Z = IsZeroBit(result);
        APSR.C = carry;
        APSR.V = overflow;
```

## Exceptions

None.

### A8.8.164 SBFX

Signed Bit Field Extract extracts any number of adjacent bits at any position from a register, sign-extends them to 32 bits, and writes the result to the destination register.

#### Encoding T1 ARMv6T2, ARMv7

SBFX<< <Rd>, <Rn>, #<lsb>, #<width>

15	14	13	12	11	10	9	8	7	6	5	4	3	2	1	0	15	14	13	12	11	10	9	8	7	6	5	4	3	2	1	0
1	1	1	1	0	(0)	1	1	0	1	0	0	Rn				0	imm3			Rd			imm2(0)		widthm1						

d = UInt(Rd); n = UInt(Rn);  
lsbit = UInt(imm3:imm2); widthminus1 = UInt(widthm1);  
if d IN {13,15} || n IN {13,15} then UNPREDICTABLE;

#### Encoding A1 ARMv6T2, ARMv7

SBFX<< <Rd>, <Rn>, #<lsb>, #<width>

31	30	29	28	27	26	25	24	23	22	21	20	19	18	17	16	15	14	13	12	11	10	9	8	7	6	5	4	3	2	1	0
cond		0	1	1	1	1	0	1	widthm1				Rd			lsb			1		0	1	Rn								

d = UInt(Rd); n = UInt(Rn);  
lsbit = UInt(lsb); widthminus1 = UInt(widthm1);  
if d == 15 || n == 15 then UNPREDICTABLE;

## Assembler syntax

SBFX{<c>}{<q>} <Rd>, <Rn>, #<lsb>, #<width>

where:

- <c>, <q> See [Standard assembler syntax fields on page A8-287](#).
- <Rd> The destination register.
- <Rn> The first operand register.
- <lsb> is the bit number of the least significant bit in the field, in the range 0-31. This determines the required value of `lsbit`.
- <width> is the width of the field, in the range 1 to 32-`<lsb>`. The required value of `widthminus1` is `<width>-1`.

## Operation

```
if ConditionPassed() then
    EncodingSpecificOperations();
    msbit = lsbit + widthminus1;
    if msbit <= 31 then
        R[d] = SignExtend(R[n]<msbit:lsbit>, 32);
    else
        UNPREDICTABLE;
```

## Exceptions

None.

### A8.8.165 SDIV

Signed Divide divides a 32-bit signed integer register value by a 32-bit signed integer register value, and writes the result to the destination register. The condition flags are not affected.

See [ARMv7 implementation requirements and options for the divide instructions on page A4-172](#) for more information about this instruction.

**Encoding T1** ARMv7-R, ARMv7VE, otherwise OPTIONAL in ARMv7-A

SDIV<c> <Rd>, <Rn>, <Rm>

15	14	13	12	11	10	9	8	7	6	5	4	3	2	1	0	15	14	13	12	11	10	9	8	7	6	5	4	3	2	1	0
1	1	1	1	1	0	1	1	1	0	0	1	Rn				(1)	(1)	(1)	(1)	Rd				1	1	1	1	Rm			

d = UInt(Rd); n = UInt(Rn); m = UInt(Rm);  
if d IN {13,15} || n IN {13,15} || m IN {13,15} then UNPREDICTABLE;

**Encoding A1** ARMv7VE, otherwise OPTIONAL in ARMv7-A and ARMv7-R

SDIV<c> <Rd>, <Rn>, <Rm>

31	30	29	28	27	26	25	24	23	22	21	20	19	18	17	16	15	14	13	12	11	10	9	8	7	6	5	4	3	2	1	0
cond		0	1	1	1	0	0	0	1	Rd				(1)	(1)	(1)	(1)	Rm				0	0	0	1	Rn					

d = UInt(Rd); n = UInt(Rn); m = UInt(Rm);  
if d == 15 || n == 15 || m == 15 then UNPREDICTABLE;

## Assembler syntax

SDIV{<c>}{<q>} {<Rd>}, <Rn>, <Rm>

where:

<c>, <q> See [Standard assembler syntax fields on page A8-287](#).

<Rd> The destination register.

<Rn> The register that contains the dividend.

<Rm> The register that contains the divisor.

## Operation

```
if ConditionPassed() then
    EncodingSpecificOperations();
    if SInt(R[m]) == 0 then
        if IntegerZeroDivideTrappingEnabled() then
            GenerateIntegerZeroDivide();
        else
            result = 0;
    else
        result = RoundTowardsZero(SInt(R[n]) / SInt(R[m]));
    R[d] = result<31:0>;
```

## Exceptions

In ARMv7-R profile, Undefined Instruction, see [Divide instructions on page A4-172](#).

In ARMv7-A profile, none.

## Overflow

If the signed integer division  $0x80000000 / 0xFFFFFFFF$  is performed, the pseudocode produces the intermediate integer result  $+2^{31}$ , that overflows the 32-bit signed integer range. No indication of this overflow case is produced, and the 32-bit result written to R[d] must be the bottom 32 bits of the binary representation of  $+2^{31}$ . So the result of the division is  $0x80000000$ .

### A8.8.166 SEL

Select Bytes selects each byte of its result from either its first operand or its second operand, according to the values of the GE flags.

#### Encoding T1 ARMv6T2, ARMv7

SEL<c> <Rd>, <Rn>, <Rm>

15	14	13	12	11	10	9	8	7	6	5	4	3	2	1	0	15	14	13	12	11	10	9	8	7	6	5	4	3	2	1	0
1	1	1	1	1	0	1	0	1	0	1	0	Rn			1	1	1	1	Rd			1	0	0	0	Rm					

d = UInt(Rd); n = UInt(Rn); m = UInt(Rm);  
if d IN {13,15} || n IN {13,15} || m IN {13,15} then UNPREDICTABLE;

#### Encoding A1 ARMv6\*, ARMv7

SEL<c> <Rd>, <Rn>, <Rm>

31	30	29	28	27	26	25	24	23	22	21	20	19	18	17	16	15	14	13	12	11	10	9	8	7	6	5	4	3	2	1	0
cond		0	1	1	0	1	0	0	0	Rn			Rd			(1)	(1)	(1)	(1)	1	0	1	1	Rm							

d = UInt(Rd); n = UInt(Rn); m = UInt(Rm);  
if d == 15 || n == 15 || m == 15 then UNPREDICTABLE;

## Assembler syntax

SEL{<c>}{<q>} {<Rd>}, <Rn>, <Rm>

where:

<c>, <q> See *Standard assembler syntax fields* on page A8-287.

<Rd> The destination register.

<Rn> The first operand register.

<Rm> The second operand register.

## Operation

```
if ConditionPassed() then
    EncodingSpecificOperations();
R[d]<7:0> = if APSR.GE<0> == '1' then R[n]<7:0> else R[m]<7:0>;
R[d]<15:8> = if APSR.GE<1> == '1' then R[n]<15:8> else R[m]<15:8>;
R[d]<23:16> = if APSR.GE<2> == '1' then R[n]<23:16> else R[m]<23:16>;
R[d]<31:24> = if APSR.GE<3> == '1' then R[n]<31:24> else R[m]<31:24>;
```

## Exceptions

None.

### A8.8.167 SETEND

Set Endianness writes a new value to ENDIANSTATE.

**Encoding T1** ARMv6\*, ARMv7

SETEND <endian\_specifier>

Not permitted in IT block

15	14	13	12	11	10	9	8	7	6	5	4	3	2	1	0
1	0	1	1	0	1	1	0	0	1	0	(1)	E	(0)	(0)	(0)

set\_bigend = (E == '1');  
if InITBlock() then UNPREDICTABLE;

**Encoding A1** ARMv6\*, ARMv7

SETEND <endian\_specifier>

Cannot be conditional

31	30	29	28	27	26	25	24	23	22	21	20	19	18	17	16	15	14	13	12	11	10	9	8	7	6	5	4	3	2	1	0
1	1	1	1	0	0	0	1	0	0	0	0	(0)	(0)	(0)	1	(0)	(0)	(0)	(0)	(0)	(0)	E	(0)	0	0	0	0	(0)	(0)	(0)	(0)

set\_bigend = (E == '1');



## Assembler syntax

SETEND{<q>} <endian\_specifier>

where:

<q> See [Standard assembler syntax fields on page A8-287](#). A SETEND instruction must be unconditional.

<endian\_specifier>

Is one of:

- BE Sets the E bit in the instruction. This sets ENDIANSTATE.
- LE Clears the E bit in the instruction. This clears ENDIANSTATE.

## Operation

```
EncodingSpecificOperations();  
ENDIANSTATE = if set_bigend then '1' else '0';
```

## Exceptions

None.

### A8.8.168 SEV

Send Event is a hint instruction. It causes an event to be signaled to all processors in the multiprocessor system. For more information, see *Wait For Event and Send Event* on page B1-1199.

**Encoding T1** ARMv7 (executes as NOP in ARMv6T2)

SEV<c>

15	14	13	12	11	10	9	8	7	6	5	4	3	2	1	0
1	0	1	1	1	1	1	1	0	1	0	0	0	0	0	0

// No additional decoding required

**Encoding T2** ARMv7 (executes as NOP in ARMv6T2)

SEV<c>.w

15	14	13	12	11	10	9	8	7	6	5	4	3	2	1	0	15	14	13	12	11	10	9	8	7	6	5	4	3	2	1	0
1	1	1	1	0	0	1	1	1	0	1	0	(1)	(1)	(1)	(1)	1	0	(0)	0	(0)	0	0	0	0	0	0	0	1	0	0	

// No additional decoding required

**Encoding A1** ARMv6K, ARMv7 (executes as NOP in ARMv6T2)

SEV<c>

31	30	29	28	27	26	25	24	23	22	21	20	19	18	17	16	15	14	13	12	11	10	9	8	7	6	5	4	3	2	1	0
cond	0	0	1	1	0	0	1	0	0	0	0	0	(1)	(1)	(1)	(1)	(0)	(0)	(0)	(0)	0	0	0	0	0	0	0	1	0	0	

// No additional decoding required

## Assembler syntax

SEV{<c>}{<q>}

where:

<c>, <q> See *Standard assembler syntax fields* on page A8-287.

## Operation

```
if ConditionPassed() then
    EncodingSpecificOperations();
    SendEvent();
```

## Exceptions

None.

### A8.8.169 SHADD16

Signed Halving Add 16 performs two signed 16-bit integer additions, halves the results, and writes the results to the destination register.

**Encoding T1** ARMv6T2, ARMv7

SHADD16<c> <Rd>, <Rn>, <Rm>

15	14	13	12	11	10	9	8	7	6	5	4	3	2	1	0	15	14	13	12	11	10	9	8	7	6	5	4	3	2	1	0
1	1	1	1	1	0	1	0	1	0	0	1	Rn				1	1	1	1	Rd		0	0	1	0	Rm					

d = UInt(Rd); n = UInt(Rn); m = UInt(Rm);  
if d IN {13,15} || n IN {13,15} || m IN {13,15} then UNPREDICTABLE;

**Encoding A1** ARMv6\*, ARMv7

SHADD16<c> <Rd>, <Rn>, <Rm>

31	30	29	28	27	26	25	24	23	22	21	20	19	18	17	16	15	14	13	12	11	10	9	8	7	6	5	4	3	2	1	0
cond		0	1	1	0	0	0	1	1	Rn				Rd				(1)	(1)	(1)	(1)	0	0	0	1	Rm					

d = UInt(Rd); n = UInt(Rn); m = UInt(Rm);  
if d == 15 || n == 15 || m == 15 then UNPREDICTABLE;

## Assembler syntax

SHADD16{<c>}{<q>} {<Rd>}, <Rn>, <Rm>

where:

<c>, <q> See *Standard assembler syntax fields* on page A8-287.

<Rd> The destination register.

<Rn> The first operand register.

<Rm> The second operand register.

## Operation

```
if ConditionPassed() then
    EncodingSpecificOperations();
    sum1 = SInt(R[n]<15:0>) + SInt(R[m]<15:0>);
    sum2 = SInt(R[n]<31:16>) + SInt(R[m]<31:16>);
    R[d]<15:0> = sum1<16:1>;
    R[d]<31:16> = sum2<16:1>;
```

## Exceptions

None.

### A8.8.170 SHADD8

Signed Halving Add 8 performs four signed 8-bit integer additions, halves the results, and writes the results to the destination register.

**Encoding T1** ARMv6T2, ARMv7

SHADD8<c> <Rd>, <Rn>, <Rm>

15	14	13	12	11	10	9	8	7	6	5	4	3	2	1	0	15	14	13	12	11	10	9	8	7	6	5	4	3	2	1	0
1	1	1	1	1	0	1	0	1	0	0	0	Rn			1	1	1	1	Rd			0	0	1	0	Rm					

d = UInt(Rd); n = UInt(Rn); m = UInt(Rm);  
if d IN {13,15} || n IN {13,15} || m IN {13,15} then UNPREDICTABLE;

**Encoding A1** ARMv6\*, ARMv7

SHADD8<c> <Rd>, <Rn>, <Rm>

31	30	29	28	27	26	25	24	23	22	21	20	19	18	17	16	15	14	13	12	11	10	9	8	7	6	5	4	3	2	1	0
cond		0	1	1	0	0	0	1	1	Rn			Rd			(1)	(1)	(1)	(1)	1	0	0	1	Rm							

d = UInt(Rd); n = UInt(Rn); m = UInt(Rm);  
if d == 15 || n == 15 || m == 15 then UNPREDICTABLE;

## Assembler syntax

SHADD8{<c>}{<q>} {<Rd>}, <Rn>, <Rm>

where:

<c>, <q> See *Standard assembler syntax fields* on page A8-287.

<Rd> The destination register.

<Rn> The first operand register.

<Rm> The second operand register.

## Operation

```
if ConditionPassed() then
    EncodingSpecificOperations();
    sum1 = SInt(R[n]<7:0>) + SInt(R[m]<7:0>);
    sum2 = SInt(R[n]<15:8>) + SInt(R[m]<15:8>);
    sum3 = SInt(R[n]<23:16>) + SInt(R[m]<23:16>);
    sum4 = SInt(R[n]<31:24>) + SInt(R[m]<31:24>);
    R[d]<7:0> = sum1<8:1>;
    R[d]<15:8> = sum2<8:1>;
    R[d]<23:16> = sum3<8:1>;
    R[d]<31:24> = sum4<8:1>;
```

## Exceptions

None.

### A8.8.171 SHASX

Signed Halving Add and Subtract with Exchange exchanges the two halfwords of the second operand, performs one signed 16-bit integer addition and one signed 16-bit subtraction, halves the results, and writes the results to the destination register.

**Encoding T1** ARMv6T2, ARMv7

SHASX<c> <Rd>, <Rn>, <Rm>

15	14	13	12	11	10	9	8	7	6	5	4	3	2	1	0	15	14	13	12	11	10	9	8	7	6	5	4	3	2	1	0
1	1	1	1	1	0	1	0	1	0	1	0	Rn				1	1	1	1	Rd				0	0	1	0	Rm			

d = UInt(Rd); n = UInt(Rn); m = UInt(Rm);  
if d IN {13,15} || n IN {13,15} || m IN {13,15} then UNPREDICTABLE;

**Encoding A1** ARMv6\*, ARMv7

SHASX<c> <Rd>, <Rn>, <Rm>

31	30	29	28	27	26	25	24	23	22	21	20	19	18	17	16	15	14	13	12	11	10	9	8	7	6	5	4	3	2	1	0
cond		0	1	1	0	0	0	1	1	Rn				Rd				(1)	(1)	(1)	(1)	0	0	1	1	Rm					

d = UInt(Rd); n = UInt(Rn); m = UInt(Rm);  
if d == 15 || n == 15 || m == 15 then UNPREDICTABLE;



## Assembler syntax

SHASX{<c>}{<q>} {<Rd>}, <Rn>, <Rm>

where:

<c>, <q> See [Standard assembler syntax fields on page A8-287](#).

<Rd> The destination register.

<Rn> The first operand register.

<Rm> The second operand register.

The pre-UAL syntax SHADDSUBX<c> is equivalent to SHASX<c>.

## Operation

```
if ConditionPassed() then
    EncodingSpecificOperations();
    diff = SInt(R[n]<15:0>) - SInt(R[m]<31:16>);
    sum = SInt(R[n]<31:16>) + SInt(R[m]<15:0>);
    R[d]<15:0> = diff<16:1>;
    R[d]<31:16> = sum<16:1>;
```

## Exceptions

None.

### A8.8.172 SHSAX

Signed Halving Subtract and Add with Exchange exchanges the two halfwords of the second operand, performs one signed 16-bit integer subtraction and one signed 16-bit addition, halves the results, and writes the results to the destination register.

**Encoding T1** ARMv6T2, ARMv7

SHSAX<c> <Rd>, <Rn>, <Rm>

15	14	13	12	11	10	9	8	7	6	5	4	3	2	1	0	15	14	13	12	11	10	9	8	7	6	5	4	3	2	1	0
1	1	1	1	1	0	1	0	1	1	1	0	Rn				1	1	1	1	Rd				0	0	1	0	Rm			

d = UInt(Rd); n = UInt(Rn); m = UInt(Rm);  
if d IN {13,15} || n IN {13,15} || m IN {13,15} then UNPREDICTABLE;

**Encoding A1** ARMv6\*, ARMv7

SHSAX<c> <Rd>, <Rn>, <Rm>

31	30	29	28	27	26	25	24	23	22	21	20	19	18	17	16	15	14	13	12	11	10	9	8	7	6	5	4	3	2	1	0
cond				0	1	1	0	0	0	1	1	Rn				Rd				(1)	(1)	(1)	(1)	0	1	0	1	Rm			

d = UInt(Rd); n = UInt(Rn); m = UInt(Rm);  
if d == 15 || n == 15 || m == 15 then UNPREDICTABLE;

## Assembler syntax

SHSAX{<c>}{<q>} {<Rd>}, <Rn>, <Rm>

where:

<c>, <q> See *Standard assembler syntax fields* on page A8-287.

<Rd> The destination register.

<Rn> The first operand register.

<Rm> The second operand register.

The pre-UAL syntax SHSUBADDX<c> is equivalent to SHSAX<c>.

## Operation

```
if ConditionPassed() then
    EncodingSpecificOperations();
    sum = SInt(R[n]<15:0>) + SInt(R[m]<31:16>);
    diff = SInt(R[n]<31:16>) - SInt(R[m]<15:0>);
    R[d]<15:0> = sum<16:1>;
    R[d]<31:16> = diff<16:1>;
```

## Exceptions

None.

### A8.8.173 SHSUB16

Signed Halving Subtract 16 performs two signed 16-bit integer subtractions, halves the results, and writes the results to the destination register.

#### Encoding T1 ARMv6T2, ARMv7

SHSUB16<c> <Rd>, <Rn>, <Rm>

15	14	13	12	11	10	9	8	7	6	5	4	3	2	1	0	15	14	13	12	11	10	9	8	7	6	5	4	3	2	1	0
1	1	1	1	1	0	1	0	1	1	0	1	Rn			1	1	1	1	Rd			0	0	1	0	Rm					

d = UInt(Rd); n = UInt(Rn); m = UInt(Rm);  
if d IN {13,15} || n IN {13,15} || m IN {13,15} then UNPREDICTABLE;

#### Encoding A1 ARMv6\*, ARMv7

SHSUB16<c> <Rd>, <Rn>, <Rm>

31	30	29	28	27	26	25	24	23	22	21	20	19	18	17	16	15	14	13	12	11	10	9	8	7	6	5	4	3	2	1	0
cond		0	1	1	0	0	0	1	1	Rn			Rd			(1)	(1)	(1)	(1)	0	1	1	1	Rm							

d = UInt(Rd); n = UInt(Rn); m = UInt(Rm);  
if d == 15 || n == 15 || m == 15 then UNPREDICTABLE;

## Assembler syntax

SHSUB16{<c>}{<q>} {<Rd>}, <Rn>, <Rm>

where:

<c>, <q> See [Standard assembler syntax fields on page A8-287](#).

<Rd> The destination register.

<Rn> The first operand register.

<Rm> The second operand register.

## Operation

```
if ConditionPassed() then
    EncodingSpecificOperations();
    diff1 = SInt(R[n]<15:0>) - SInt(R[m]<15:0>);
    diff2 = SInt(R[n]<31:16>) - SInt(R[m]<31:16>);
    R[d]<15:0> = diff1<16:1>;
    R[d]<31:16> = diff2<16:1>;
```

## Exceptions

None.

### A8.8.174 SHSUB8

Signed Halving Subtract 8 performs four signed 8-bit integer subtractions, halves the results, and writes the results to the destination register.

#### Encoding T1 ARMv6T2, ARMv7

SHSUB8<c> <Rd>, <Rn>, <Rm>

15	14	13	12	11	10	9	8	7	6	5	4	3	2	1	0	15	14	13	12	11	10	9	8	7	6	5	4	3	2	1	0
1	1	1	1	1	0	1	0	1	1	0	0	Rn			1	1	1	1	Rd			0	0	1	0	Rm					

d = UInt(Rd); n = UInt(Rn); m = UInt(Rm);  
if d IN {13,15} || n IN {13,15} || m IN {13,15} then UNPREDICTABLE;

#### Encoding A1 ARMv6\*, ARMv7

SHSUB8<c> <Rd>, <Rn>, <Rm>

31	30	29	28	27	26	25	24	23	22	21	20	19	18	17	16	15	14	13	12	11	10	9	8	7	6	5	4	3	2	1	0
cond		0	1	1	0	0	0	1	1	Rn			Rd			(1)	(1)	(1)	(1)	1	1	1	1	Rm							

d = UInt(Rd); n = UInt(Rn); m = UInt(Rm);  
if d == 15 || n == 15 || m == 15 then UNPREDICTABLE;

## Assembler syntax

SHSUB8{<c>}{<q>} {<Rd>}, <Rn>, <Rm>

where:

<c>, <q> See [Standard assembler syntax fields on page A8-287](#).

<Rd> The destination register.

<Rn> The first operand register.

<Rm> The second operand register.

## Operation

```
if ConditionPassed() then
    EncodingSpecificOperations();
    diff1 = SInt(R[n]<7:0>) - SInt(R[m]<7:0>);
    diff2 = SInt(R[n]<15:8>) - SInt(R[m]<15:8>);
    diff3 = SInt(R[n]<23:16>) - SInt(R[m]<23:16>);
    diff4 = SInt(R[n]<31:24>) - SInt(R[m]<31:24>);
    R[d]<7:0> = diff1<8:1>;
    R[d]<15:8> = diff2<8:1>;
    R[d]<23:16> = diff3<8:1>;
    R[d]<31:24> = diff4<8:1>;
```

## Exceptions

None.

### A8.8.175 SMC (previously SMI)

Secure Monitor Call is a system instruction. For details see *SMC (previously SMI)* on page B9-2000.

### A8.8.176 SMLABB, SMLABT, SMLATB, SMLATT

Signed Multiply Accumulate (halfwords) performs a signed multiply accumulate operation. The multiply acts on two signed 16-bit quantities, taken from either the bottom or the top half of their respective source registers. The other halves of these source registers are ignored. The 32-bit product is added to a 32-bit accumulate value and the result is written to the destination register.

If overflow occurs during the addition of the accumulate value, the instruction sets the Q flag in the APSR. It is not possible for overflow to occur during the multiplication.

#### Encoding T1 ARMv6T2, ARMv7

SMLA<x><y><c> <Rd>, <Rn>, <Rm>, <Ra>

15	14	13	12	11	10	9	8	7	6	5	4	3	2	1	0	15	14	13	12	11	10	9	8	7	6	5	4	3	2	1	0
1	1	1	1	1	0	1	1	0	0	0	1	Rn				Ra				Rd				0	0	N	M	Rm			

if Ra == '1111' then SEE SMULBB, SMULBT, SMULTB, SMULTT;  
d = UInt(Rd); n = UInt(Rn); m = UInt(Rm); a = UInt(Ra);  
n\_high = (N == '1'); m\_high = (M == '1');  
if d IN {13,15} || n IN {13,15} || m IN {13,15} || a == 13 then UNPREDICTABLE;

#### Encoding A1 ARMv5TE\*, ARMv6\*, ARMv7

SMLA<x><y><c> <Rd>, <Rn>, <Rm>, <Ra>

31	30	29	28	27	26	25	24	23	22	21	20	19	18	17	16	15	14	13	12	11	10	9	8	7	6	5	4	3	2	1	0
cond		0	0	0	1	0	0	0	0	Rd				Ra				Rm				1	M	N	0	Rn					

d = UInt(Rd); n = UInt(Rn); m = UInt(Rm); a = UInt(Ra);  
n\_high = (N == '1'); m\_high = (M == '1');  
if d == 15 || n == 15 || m == 15 || a == 15 then UNPREDICTABLE;



## Assembler syntax

SMLA<x><y>{<c>}{<q>} <Rd>, <Rn>, <Rm>, <Ra>

where:

- <x> Specifies which half of the source register <Rn> is used as the first multiply operand. If <x> is B, then the bottom half (bits[15:0]) of <Rn> is used. If <x> is T, then the top half (bits[31:16]) of <Rn> is used.
- <y> Specifies which half of the source register <Rm> is used as the second multiply operand. If <y> is B, then the bottom half (bits[15:0]) of <Rm> is used. If <y> is T, then the top half (bits[31:16]) of <Rm> is used.
- <c>, <q> See [Standard assembler syntax fields on page A8-287](#).
- <Rd> The destination register.
- <Rn> The source register whose bottom or top half (selected by <x>) is the first multiply operand.
- <Rm> The source register whose bottom or top half (selected by <y>) is the second multiply operand.
- <Ra> The register that contains the accumulate value.

## Operation

```
if ConditionPassed() then
    EncodingSpecificOperations();
    operand1 = if n_high then R[n]<31:16> else R[n]<15:0>;
    operand2 = if m_high then R[m]<31:16> else R[m]<15:0>;
    result = SInt(operand1) * SInt(operand2) + SInt(R[a]);
    R[d] = result<31:0>;
    if result != SInt(result<31:0>) then // Signed overflow
        APSR.Q = '1';
```

## Exceptions

None.

### A8.8.177 SMLAD

Signed Multiply Accumulate Dual performs two signed  $16 \times 16$ -bit multiplications. It adds the products to a 32-bit accumulate operand.

Optionally, the instruction can exchange the halfwords of the second operand before performing the arithmetic. This produces top  $\times$  bottom and bottom  $\times$  top multiplication.

This instruction sets the Q flag if the accumulate operation overflows. Overflow cannot occur during the multiplications.

#### Encoding T1 ARMv6T2, ARMv7

SMLAD{X}<C> <Rd>, <Rn>, <Rm>, <Ra>

15	14	13	12	11	10	9	8	7	6	5	4	3	2	1	0	15	14	13	12	11	10	9	8	7	6	5	4	3	2	1	0
1	1	1	1	1	0	1	1	0	0	1	0	Rn				Ra				Rd				0	0	0	M	Rm			

```
if Ra == '1111' then SEE SMUAD;
d = UInt(Rd); n = UInt(Rn); m = UInt(Rm); a = UInt(Ra);
m_swap = (M == '1');
if d IN {13,15} || n IN {13,15} || m IN {13,15} || a == 13 then UNPREDICTABLE;
```

#### Encoding A1 ARMv6\*, ARMv7

SMLAD{X}<C> <Rd>, <Rn>, <Rm>, <Ra>

31	30	29	28	27	26	25	24	23	22	21	20	19	18	17	16	15	14	13	12	11	10	9	8	7	6	5	4	3	2	1	0
cond				0	1	1	1	0	0	0	0	Rd				Ra				Rm				0	0	M	1	Rn			

```
if Ra == '1111' then SEE SMUAD;
d = UInt(Rd); n = UInt(Rn); m = UInt(Rm); a = UInt(Ra);
m_swap = (M == '1');
if d == 15 || n == 15 || m == 15 then UNPREDICTABLE;
```

## Assembler syntax

SMLAD{X}{<c>}{<q>} <Rd>, <Rn>, <Rm>, <Ra>

where:

X            If X is present (encoded as M = 1), the multiplications are bottom × top and top × bottom.  
              If the X is omitted (encoded as M = 0), the multiplications are bottom × bottom and top × top.

<c>, <q>      See *Standard assembler syntax fields* on page A8-287.

<Rd>         The destination register.

<Rn>         The first operand register.

<Rm>         The second operand register.

<Ra>         The register that contains the accumulate value.

## Operation

```
if ConditionPassed() then
    EncodingSpecificOperations();
    operand2 = if m_swap then ROR(R[m],16) else R[m];
    product1 = SInt(R[n]<15:0>) * SInt(operand2<15:0>);
    product2 = SInt(R[n]<31:16>) * SInt(operand2<31:16>);
    result = product1 + product2 + SInt(R[a]);
    R[d] = result<31:0>;
    if result != SInt(result<31:0>) then // Signed overflow
        APSR.Q = '1';
```

## Exceptions

None.

### A8.8.178 SMLAL

Signed Multiply Accumulate Long multiplies two signed 32-bit values to produce a 64-bit value, and accumulates this with a 64-bit value.

In ARM instructions, the condition flags can optionally be updated based on the result. Use of this option adversely affects performance on many processor implementations.

#### Encoding T1 ARMv6T2, ARMv7

SMLAL<c> <RdLo>, <RdHi>, <Rn>, <Rm>

15	14	13	12	11	10	9	8	7	6	5	4	3	2	1	0	15	14	13	12	11	10	9	8	7	6	5	4	3	2	1	0
1	1	1	1	1	0	1	1	1	1	0	0	Rn				RdLo				RdHi				0	0	0	0	Rm			

dLo = UInt(RdLo); dHi = UInt(RdHi); n = UInt(Rn); m = UInt(Rm); setflags = FALSE;  
if dLo IN {13,15} || dHi IN {13,15} || n IN {13,15} || m IN {13,15} then UNPREDICTABLE;  
if dHi == dLo then UNPREDICTABLE;

#### Encoding A1 ARMv4\*, ARMv5T\*, ARMv6\*, ARMv7

SMLAL{S}<c> <RdLo>, <RdHi>, <Rn>, <Rm>

31	30	29	28	27	26	25	24	23	22	21	20	19	18	17	16	15	14	13	12	11	10	9	8	7	6	5	4	3	2	1	0
cond		0	0	0	0	1	1	1	S	RdHi				RdLo				Rm				1	0	0	1	Rn					

dLo = UInt(RdLo); dHi = UInt(RdHi); n = UInt(Rn); m = UInt(Rm); setflags = (S == '1');  
if dLo == 15 || dHi == 15 || n == 15 || m == 15 then UNPREDICTABLE;  
if dHi == dLo then UNPREDICTABLE;  
if ArchVersion() < 6 && (dHi == n || dLo == n) then UNPREDICTABLE;

## Assembler syntax

SMLAL{S}{<c>}{<q>} <RdLo>, <RdHi>, <Rn>, <Rm>

where:

- S            If S is present, the instruction updates the flags. Otherwise, the flags are not updated.  
S can be specified only for the ARM instruction set.
- <c>, <q>    See *Standard assembler syntax fields* on page A8-287.
- <RdLo>     Supplies the lower 32 bits of the accumulate value, and is the destination register for the lower 32 bits of the result.
- <RdHi>     Supplies the upper 32 bits of the accumulate value, and is the destination register for the upper 32 bits of the result.
- <Rn>        The first operand register.
- <Rm>        The second operand register.

The pre-UAL syntax SMLAL<c>S is equivalent to SMLALS<c>.

## Operation

```

if ConditionPassed() then
    EncodingSpecificOperations();
    result = SInt(R[n]) * SInt(R[m]) + SInt(R[dHi]:R[dLo]);
    R[dHi] = result<63:32>;
    R[dLo] = result<31:0>;
    if setflags then
        APSR.N = result<63>;
        APSR.Z = IsZeroBit(result<63:0>);
        if ArchVersion() == 4 then
            APSR.C = bit UNKNOWN;
            APSR.V = bit UNKNOWN;
        // else APSR.C, APSR.V unchanged

```

## Exceptions

None.

### A8.8.179 SMLALBB, SMLALBT, SMLALTB, SMLALTT

Signed Multiply Accumulate Long (halfwords) multiplies two signed 16-bit values to produce a 32-bit value, and accumulates this with a 64-bit value. The multiply acts on two signed 16-bit quantities, taken from either the bottom or the top half of their respective source registers. The other halves of these source registers are ignored. The 32-bit product is sign-extended and accumulated with a 64-bit accumulate value.

Overflow is possible during this instruction, but only as a result of the 64-bit addition. This overflow is not detected if it occurs. Instead, the result wraps around modulo  $2^{64}$ .

#### Encoding T1 ARMv6T2, ARMv7

SMLAL<x><y><c> <RdLo>, <RdHi>, <Rn>, <Rm>

15	14	13	12	11	10	9	8	7	6	5	4	3	2	1	0	15	14	13	12	11	10	9	8	7	6	5	4	3	2	1	0
1	1	1	1	1	0	1	1	1	1	0	0	Rn				RdLo				RdHi				1	0	N	M	Rm			

```
dLo = UInt(RdLo); dHi = UInt(RdHi); n = UInt(Rn); m = UInt(Rm);
n_high = (N == '1'); m_high = (M == '1');
if dLo IN {13,15} || dHi IN {13,15} || n IN {13,15} || m IN {13,15} then UNPREDICTABLE;
if dHi == dLo then UNPREDICTABLE;
```

#### Encoding A1 ARMv5TE\*, ARMv6\*, ARMv7

SMLAL<x><y><c> <RdLo>, <RdHi>, <Rn>, <Rm>

31	30	29	28	27	26	25	24	23	22	21	20	19	18	17	16	15	14	13	12	11	10	9	8	7	6	5	4	3	2	1	0
cond				0	0	0	1	0	1	0	0	RdHi				RdLo				Rm				1	M	N	0	Rn			

```
dLo = UInt(RdLo); dHi = UInt(RdHi); n = UInt(Rn); m = UInt(Rm);
n_high = (N == '1'); m_high = (M == '1');
if dLo == 15 || dHi == 15 || n == 15 || m == 15 then UNPREDICTABLE;
if dHi == dLo then UNPREDICTABLE;
```

## Assembler syntax

SMLAL<x><y>{<c>}{<q>} <RdLo>, <RdHi>, <Rn>, <Rm>

where:

- <x> Specifies which half of the source register <Rn> is used as the first multiply operand. If <x> is B, then the bottom half (bits[15:0]) of <Rn> is used. If <x> is T, then the top half (bits[31:16]) of <Rn> is used.
- <y> Specifies which half of the source register <Rm> is used as the second multiply operand. If <y> is B, then the bottom half (bits[15:0]) of <Rm> is used. If <y> is T, then the top half (bits[31:16]) of <Rm> is used.
- <c>, <q> See [Standard assembler syntax fields on page A8-287](#).
- <RdLo> Supplies the lower 32 bits of the accumulate value, and is the destination register for the lower 32 bits of the result.
- <RdHi> Supplies the upper 32 bits of the accumulate value, and is the destination register for the upper 32 bits of the result.
- <Rn> The source register whose bottom or top half (selected by <x>) is the first multiply operand.
- <Rm> The source register whose bottom or top half (selected by <y>) is the second multiply operand.

## Operation

```
if ConditionPassed() then
    EncodingSpecificOperations();
    operand1 = if n_high then R[n]<31:16> else R[n]<15:0>;
    operand2 = if m_high then R[m]<31:16> else R[m]<15:0>;
    result = SInt(operand1) * SInt(operand2) + SInt(R[dHi]:R[dLo]);
    R[dHi] = result<63:32>;
    R[dLo] = result<31:0>;
```

## Exceptions

None.

### A8.8.180 SMLALD

Signed Multiply Accumulate Long Dual performs two signed  $16 \times 16$ -bit multiplications. It adds the products to a 64-bit accumulate operand.

Optionally, the instruction can exchange the halfwords of the second operand before performing the arithmetic. This produces top  $\times$  bottom and bottom  $\times$  top multiplication.

Overflow is possible during this instruction, but only as a result of the 64-bit addition. This overflow is not detected if it occurs. Instead, the result wraps around modulo  $2^{64}$ .

#### Encoding T1 ARMv6T2, ARMv7

SMLALD{X}<C> <RdLo>, <RdHi>, <Rn>, <Rm>

15	14	13	12	11	10	9	8	7	6	5	4	3	2	1	0	15	14	13	12	11	10	9	8	7	6	5	4	3	2	1	0
1	1	1	1	1	0	1	1	1	1	0	0	Rn				RdLo		RdHi		1	1	0	M	Rm							

```
dLo = UInt(RdLo); dHi = UInt(RdHi); n = UInt(Rn); m = UInt(Rm); m_swap = (M == '1');
if dLo IN {13,15} || dHi IN {13,15} || n IN {13,15} || m IN {13,15} then UNPREDICTABLE;
if dHi == dLo then UNPREDICTABLE;
```

#### Encoding A1 ARMv6\*, ARMv7

SMLALD{X}<C> <RdLo>, <RdHi>, <Rn>, <Rm>

31	30	29	28	27	26	25	24	23	22	21	20	19	18	17	16	15	14	13	12	11	10	9	8	7	6	5	4	3	2	1	0
cond		0	1	1	1	0	1	0	0	RdHi				RdLo		Rm		0	0	M	1	Rn									

```
dLo = UInt(RdLo); dHi = UInt(RdHi); n = UInt(Rn); m = UInt(Rm); m_swap = (M == '1');
if dLo == 15 || dHi == 15 || n == 15 || m == 15 then UNPREDICTABLE;
if dHi == dLo then UNPREDICTABLE;
```



## Assembler syntax

SMLALD{X}{<c>}{<q>} <RdLo>, <RdHi>, <Rn>, <Rm>

where:

X	If X is present, the multiplications are bottom $\times$ top and top $\times$ bottom. If the X is omitted, the multiplications are bottom $\times$ bottom and top $\times$ top.
<c>, <q>	See <i>Standard assembler syntax fields</i> on page A8-287.
<RdLo>	Supplies the lower 32 bits of the accumulate value, and is the destination register for the lower 32 bits of the result.
<RdHi>	Supplies the upper 32 bits of the accumulate value, and is the destination register for the upper 32 bits of the result.
<Rn>	The first operand register.
<Rm>	The second operand register.

## Operation

```
if ConditionPassed() then
    EncodingSpecificOperations();
    operand2 = if m_swap then ROR(R[m],16) else R[m];
    product1 = SInt(R[n]<15:0>) * SInt(operand2<15:0>);
    product2 = SInt(R[n]<31:16>) * SInt(operand2<31:16>);
    result = product1 + product2 + SInt(R[dHi]:R[dLo]);
    R[dHi] = result<63:32>;
    R[dLo] = result<31:0>;
```

## Exceptions

None.

### A8.8.181 SMLAWB, SMLAWT

Signed Multiply Accumulate (word by halfword) performs a signed multiply accumulate operation. The multiply acts on a signed 32-bit quantity and a signed 16-bit quantity. The signed 16-bit quantity is taken from either the bottom or the top half of its source register. The other half of the second source register is ignored. The top 32 bits of the 48-bit product are added to a 32-bit accumulate value and the result is written to the destination register. The bottom 16 bits of the 48-bit product are ignored.

If overflow occurs during the addition of the accumulate value, the instruction sets the Q flag in the APSR. No overflow can occur during the multiplication.

#### Encoding T1 ARMv6T2, ARMv7

SMLAW<y><c> <Rd>, <Rn>, <Rm>, <Ra>

15	14	13	12	11	10	9	8	7	6	5	4	3	2	1	0	15	14	13	12	11	10	9	8	7	6	5	4	3	2	1	0
1	1	1	1	1	0	1	1	0	0	1	1	Rn				Ra				Rd				0	0	0	M	Rm			

```
if Ra == '1111' then SEE SMULWB, SMULWT;
d = UInt(Rd); n = UInt(Rn); m = UInt(Rm); a = UInt(Ra); m_high = (M == '1');
if d IN {13,15} || n IN {13,15} || m IN {13,15} || a == 13 then UNPREDICTABLE;
```

#### Encoding A1 ARMv5TE\*, ARMv6\*, ARMv7

SMLAW<y><c> <Rd>, <Rn>, <Rm>, <Ra>

31	30	29	28	27	26	25	24	23	22	21	20	19	18	17	16	15	14	13	12	11	10	9	8	7	6	5	4	3	2	1	0
cond				0	0	0	1	0	0	1	0	Rd				Ra				Rm				1	M	0	0	Rn			

```
d = UInt(Rd); n = UInt(Rn); m = UInt(Rm); a = UInt(Ra); m_high = (M == '1');
if d == 15 || n == 15 || m == 15 || a == 15 then UNPREDICTABLE;
```

## Assembler syntax

SMLAW<y>{<c>}{<q>} <Rd>, <Rn>, <Rm>, <Ra>

where:

- <y> Specifies which half of the source register <Rm> is used as the second multiply operand. If <y> is B, then the bottom half (bits[15:0]) of <Rm> is used. If <y> is T, then the top half (bits[31:16]) of <Rm> is used.
- <c>, <q> See *Standard assembler syntax fields on page A8-287*.
- <Rd> The destination register.
- <Rn> The first operand register.
- <Rm> The source register whose bottom or top half (selected by <y>) is the second multiply operand.
- <Ra> The register that contains the accumulate value.

## Operation

```
if ConditionPassed() then
    EncodingSpecificOperations();
    operand2 = if m_high then R[m]<31:16> else R[m]<15:0>;
    result = SInt(R[n]) * SInt(operand2) + (SInt(R[a]) << 16);
    R[d] = result<47:16>;
    if (result >> 16) != SInt(R[d]) then // Signed overflow
        APSR.Q = '1';
```

## Exceptions

None.

### A8.8.182 SMLSD

Signed Multiply Subtract Dual performs two signed 16 × 16-bit multiplications. It adds the difference of the products to a 32-bit accumulate operand.

Optionally, the instruction can exchange the halfwords of the second operand before performing the arithmetic. This produces top × bottom and bottom × top multiplication.

This instruction sets the Q flag if the accumulate operation overflows. Overflow cannot occur during the multiplications or subtraction.

#### Encoding T1 ARMv6T2, ARMv7

SMLSD{X}<C> <Rd>, <Rn>, <Rm>, <Ra>

15	14	13	12	11	10	9	8	7	6	5	4	3	2	1	0	15	14	13	12	11	10	9	8	7	6	5	4	3	2	1	0
1	1	1	1	1	0	1	1	0	1	0	0	Rn				Ra				Rd				0	0	0	M	Rm			

```
if Ra == '1111' then SEE SMUSD;
d = UInt(Rd); n = UInt(Rn); m = UInt(Rm); a = UInt(Ra); m_swap = (M == '1');
if d IN {13,15} || n IN {13,15} || m IN {13,15} || a == 13 then UNPREDICTABLE;
```

#### Encoding A1 ARMv6\*, ARMv7

SMLSD{X}<C> <Rd>, <Rn>, <Rm>, <Ra>

31	30	29	28	27	26	25	24	23	22	21	20	19	18	17	16	15	14	13	12	11	10	9	8	7	6	5	4	3	2	1	0
cond				0	1	1	1	0	0	0	0	Rd				Ra				Rm				0	1	M	1	Rn			

```
if Ra == '1111' then SEE SMUSD;
d = UInt(Rd); n = UInt(Rn); m = UInt(Rm); a = UInt(Ra); m_swap = (M == '1');
if d == 15 || n == 15 || m == 15 then UNPREDICTABLE;
```

## Assembler syntax

SMLSD{X}{<c>}{<q>} <Rd>, <Rn>, <Rm>, <Ra>

where:

X	If X is present, the multiplications are bottom $\times$ top and top $\times$ bottom. If the X is omitted, the multiplications are bottom $\times$ bottom and top $\times$ top.
<c>, <q>	See <a href="#">Standard assembler syntax fields on page A8-287</a> .
<Rd>	The destination register.
<Rn>	The first operand register.
<Rm>	The second operand register.
<Ra>	The register that contains the accumulate value.

## Operation

```
if ConditionPassed() then
    EncodingSpecificOperations();
    operand2 = if m_swap then ROR(R[m],16) else R[m];
    product1 = SInt(R[n]<15:0>) * SInt(operand2<15:0>);
    product2 = SInt(R[n]<31:16>) * SInt(operand2<31:16>);
    result = product1 - product2 + SInt(R[a]);
    R[d] = result<31:0>;
    if result != SInt(result<31:0>) then // Signed overflow
        APSR.Q = '1';
```

## Exceptions

None.

### A8.8.183 SMLS LD

Signed Multiply Subtract Long Dual performs two signed  $16 \times 16$ -bit multiplications. It adds the difference of the products to a 64-bit accumulate operand.

Optionally, the instruction can exchange the halfwords of the second operand before performing the arithmetic. This produces top  $\times$  bottom and bottom  $\times$  top multiplication.

Overflow is possible during this instruction, but only as a result of the 64-bit addition. This overflow is not detected if it occurs. Instead, the result wraps around modulo  $2^{64}$ .

#### Encoding T1 ARMv6T2, ARMv7

SMLS LD{X}<C> <RdLo>, <RdHi>, <Rn>, <Rm>

15	14	13	12	11	10	9	8	7	6	5	4	3	2	1	0	15	14	13	12	11	10	9	8	7	6	5	4	3	2	1	0
1	1	1	1	1	0	1	1	1	1	0	1	Rn				RdLo		RdHi		1	1	0	M	Rm							

```
dLo = UInt(RdLo); dHi = UInt(RdHi); n = UInt(Rn); m = UInt(Rm); m_swap = (M == '1');
if dLo IN {13,15} || dHi IN {13,15} || n IN {13,15} || m IN {13,15} then UNPREDICTABLE;
if dHi == dLo then UNPREDICTABLE;
```

#### Encoding A1 ARMv6\*, ARMv7

SMLS LD{X}<C> <RdLo>, <RdHi>, <Rn>, <Rm>

31	30	29	28	27	26	25	24	23	22	21	20	19	18	17	16	15	14	13	12	11	10	9	8	7	6	5	4	3	2	1	0
cond		0	1	1	1	0	1	0	0	RdHi				RdLo		Rm		0	1	M	1	Rn									

```
dLo = UInt(RdLo); dHi = UInt(RdHi); n = UInt(Rn); m = UInt(Rm); m_swap = (M == '1');
if dLo == 15 || dHi == 15 || n == 15 || m == 15 then UNPREDICTABLE;
if dHi == dLo then UNPREDICTABLE;
```

## Assembler syntax

SMLS LD{X}{<C>}{<q>} <RdLo>, <RdHi>, <Rn>, <Rm>

where:

X	If X is present, the multiplications are bottom $\times$ top and top $\times$ bottom. If the X is omitted, the multiplications are bottom $\times$ bottom and top $\times$ top.
<C>, <q>	See <i>Standard assembler syntax fields</i> on page A8-287.
<RdLo>	Supplies the lower 32 bits of the accumulate value, and is the destination register for the lower 32 bits of the result.
<RdHi>	Supplies the upper 32 bits of the accumulate value, and is the destination register for the upper 32 bits of the result.
<Rn>	The first operand register.
<Rm>	The second operand register.

## Operation

```
if ConditionPassed() then
    EncodingSpecificOperations();
    operand2 = if m_swap then ROR(R[m],16) else R[m];
    product1 = SInt(R[n]<15:0>) * SInt(operand2<15:0>);
    product2 = SInt(R[n]<31:16>) * SInt(operand2<31:16>);
    result = product1 - product2 + SInt(R[dHi]:R[dLo]);
    R[dHi] = result<63:32>;
    R[dLo] = result<31:0>;
```

## Exceptions

None.

### A8.8.184 SMMLA

Signed Most Significant Word Multiply Accumulate multiplies two signed 32-bit values, extracts the most significant 32 bits of the result, and adds an accumulate value.

Optionally, the instruction can specify that the result is rounded instead of being truncated. In this case, the constant  $0x80000000$  is added to the product before the high word is extracted.

#### Encoding T1 ARMv6T2, ARMv7

SMMLA{R}<C> <Rd>, <Rn>, <Rm>, <Ra>

15	14	13	12	11	10	9	8	7	6	5	4	3	2	1	0	15	14	13	12	11	10	9	8	7	6	5	4	3	2	1	0
1	1	1	1	1	0	1	1	0	1	0	1	Rn				Ra				Rd				0	0	0	R	Rm			

if Ra == '1111' then SEE SMMUL;  
d = UInt(Rd); n = UInt(Rn); m = UInt(Rm); a = UInt(Ra); round = (R == '1');  
if d IN {13,15} || n IN {13,15} || m IN {13,15} || a == 13 then UNPREDICTABLE;

#### Encoding A1 ARMv6\*, ARMv7

SMMLA{R}<C> <Rd>, <Rn>, <Rm>, <Ra>

31	30	29	28	27	26	25	24	23	22	21	20	19	18	17	16	15	14	13	12	11	10	9	8	7	6	5	4	3	2	1	0
cond		0	1	1	1	0	1	0	1	Rd				Ra				Rm				0	0	R	1	Rn					

if Ra == '1111' then SEE SMMUL;  
d = UInt(Rd); n = UInt(Rn); m = UInt(Rm); a = UInt(Ra); round = (R == '1');  
if d == 15 || n == 15 || m == 15 then UNPREDICTABLE;



## Assembler syntax

SMMLA{R}{<c>}{<q>} <Rd>, <Rn>, <Rm>, <Ra>

where:

R	If R is present, the multiplication is rounded. If the R is omitted, the multiplication is truncated.
<c>, <q>	See <i>Standard assembler syntax fields</i> on page A8-287.
<Rd>	The destination register.
<Rn>	The register that contains the first multiply operand.
<Rm>	The register that contains the second multiply operand.
<Ra>	The register that contains the accumulate value.

## Operation

```
if ConditionPassed() then
    EncodingSpecificOperations();
    result = (SInt(R[a]) << 32) + SInt(R[n]) * SInt(R[m]);
    if round then result = result + 0x80000000;
    R[d] = result<63:32>;
```

## Exceptions

None.

### A8.8.185 SMMLS

Signed Most Significant Word Multiply Subtract multiplies two signed 32-bit values, subtracts the result from a 32-bit accumulate value that is shifted left by 32 bits, and extracts the most significant 32 bits of the result of that subtraction.

Optionally, the instruction can specify that the result of the instruction is rounded instead of being truncated. In this case, the constant 0x80000000 is added to the result of the subtraction before the high word is extracted.

#### Encoding T1 ARMv6T2, ARMv7

SMMLS{R}<C> <Rd>, <Rn>, <Rm>, <Ra>

15	14	13	12	11	10	9	8	7	6	5	4	3	2	1	0	15	14	13	12	11	10	9	8	7	6	5	4	3	2	1	0
1	1	1	1	1	0	1	1	0	1	1	0	Rn				Ra				Rd				0	0	0	R	Rm			

d = UInt(Rd); n = UInt(Rn); m = UInt(Rm); a = UInt(Ra); round = (R == '1');  
if d IN {13,15} || n IN {13,15} || m IN {13,15} || a IN {13,15} then UNPREDICTABLE;

#### Encoding A1 ARMv6\*, ARMv7

SMMLS{R}<C> <Rd>, <Rn>, <Rm>, <Ra>

31	30	29	28	27	26	25	24	23	22	21	20	19	18	17	16	15	14	13	12	11	10	9	8	7	6	5	4	3	2	1	0
cond				0	1	1	1	0	1	0	1	Rd				Ra				Rm				1	1	R	1	Rn			

d = UInt(Rd); n = UInt(Rn); m = UInt(Rm); a = UInt(Ra); round = (R == '1');  
if d == 15 || n == 15 || m == 15 || a == 15 then UNPREDICTABLE;

## Assembler syntax

SMMLS{R}{<c>}{<q>} <Rd>, <Rn>, <Rm>, <Ra>

where:

R	If R is present, the multiplication is rounded. If the R is omitted, the multiplication is truncated.
<c>, <q>	See <i>Standard assembler syntax fields</i> on page A8-287.
<Rd>	The destination register.
<Rn>	The register that contains the first multiply operand.
<Rm>	The register that contains the second multiply operand.
<Ra>	The register that contains the accumulate value.

## Operation

```
if ConditionPassed() then
    EncodingSpecificOperations();
    result = (SInt(R[a]) << 32) - SInt(R[n]) * SInt(R[m]);
    if round then result = result + 0x80000000;
    R[d] = result<63:32>;
```

## Exceptions

None.

### A8.8.186 SMMUL

Signed Most Significant Word Multiply multiplies two signed 32-bit values, extracts the most significant 32 bits of the result, and writes those bits to the destination register.

Optionally, the instruction can specify that the result is rounded instead of being truncated. In this case, the constant  $0x80000000$  is added to the product before the high word is extracted.

#### Encoding T1 ARMv6T2, ARMv7

SMMUL{R}<C> <Rd>, <Rn>, <Rm>

15	14	13	12	11	10	9	8	7	6	5	4	3	2	1	0	15	14	13	12	11	10	9	8	7	6	5	4	3	2	1	0
1	1	1	1	1	0	1	1	0	1	0	1	Rn				1	1	1	1	Rd				0	0	0	R	Rm			

d = UInt(Rd); n = UInt(Rn); m = UInt(Rm); round = (R == '1');  
if d IN {13,15} || n IN {13,15} || m IN {13,15} then UNPREDICTABLE;

#### Encoding A1 ARMv6\*, ARMv7

SMMUL{R}<C> <Rd>, <Rn>, <Rm>

31	30	29	28	27	26	25	24	23	22	21	20	19	18	17	16	15	14	13	12	11	10	9	8	7	6	5	4	3	2	1	0
cond		0	1	1	1	0	1	0	1	Rd				1	1	1	1	Rm				0	0	R	1	Rn					

d = UInt(Rd); n = UInt(Rn); m = UInt(Rm); round = (R == '1');  
if d == 15 || n == 15 || m == 15 then UNPREDICTABLE;

## Assembler syntax

SMMUL{R}{<c>}{<q>} {<Rd>}, <Rn>, <Rm>

where:

- R            If R is present, the multiplication is rounded.  
              If the R is omitted, the multiplication is truncated.
- <c>, <q>     See *Standard assembler syntax fields* on page A8-287.
- <Rd>        The destination register.
- <Rn>        The first operand register.
- <Rm>        The second operand register.

## Operation

```
if ConditionPassed() then
    EncodingSpecificOperations();
    result = SInt(R[n]) * SInt(R[m]);
    if round then result = result + 0x80000000;
    R[d] = result<63:32>;
```

## Exceptions

None.

### A8.8.187 SMUAD

Signed Dual Multiply Add performs two signed 16 × 16-bit multiplications. It adds the products together, and writes the result to the destination register.

Optionally, the instruction can exchange the halfwords of the second operand before performing the arithmetic. This produces top × bottom and bottom × top multiplication.

This instruction sets the Q flag if the addition overflows. The multiplications cannot overflow.

#### Encoding T1 ARMv6T2, ARMv7

SMUAD{X}<C> <Rd>, <Rn>, <Rm>

15	14	13	12	11	10	9	8	7	6	5	4	3	2	1	0	15	14	13	12	11	10	9	8	7	6	5	4	3	2	1	0
1	1	1	1	1	0	1	1	0	0	1	0	Rn			1	1	1	1	Rd			0	0	0	M	Rm					

d = UInt(Rd); n = UInt(Rn); m = UInt(Rm); m\_swap = (M == '1');  
if d IN {13,15} || n IN {13,15} || m IN {13,15} then UNPREDICTABLE;

#### Encoding A1 ARMv6\*, ARMv7

SMUAD{X}<C> <Rd>, <Rn>, <Rm>

31	30	29	28	27	26	25	24	23	22	21	20	19	18	17	16	15	14	13	12	11	10	9	8	7	6	5	4	3	2	1	0
cond		0	1	1	1	0	0	0	0	Rd			1	1	1	1	Rm			0	0	M	1	Rn							

d = UInt(Rd); n = UInt(Rn); m = UInt(Rm); m\_swap = (M == '1');  
if d == 15 || n == 15 || m == 15 then UNPREDICTABLE;

## Assembler syntax

SMUAD{X}{<c>}{<q>} {<Rd>}, <Rn>, <Rm>

where:

- X            If X is present, the multiplications are bottom  $\times$  top and top  $\times$  bottom.  
              If the X is omitted, the multiplications are bottom  $\times$  bottom and top  $\times$  top.
- <c>, <q>     See *Standard assembler syntax fields* on page A8-287.
- <Rd>         The destination register.
- <Rn>         The first operand register.
- <Rm>         The second operand register.

## Operation

```
if ConditionPassed() then
    EncodingSpecificOperations();
    operand2 = if m_swap then ROR(R[m],16) else R[m];
    product1 = SInt(R[n]<15:0>) * SInt(operand2<15:0>);
    product2 = SInt(R[n]<31:16>) * SInt(operand2<31:16>);
    result = product1 + product2;
    R[d] = result<31:0>;
    if result != SInt(result<31:0>) then // Signed overflow
        APSR.Q = '1';
```

## Exceptions

None.

### A8.8.188 SMULBB, SMULBT, SMULTB, SMULTT

Signed Multiply (halfwords) multiplies two signed 16-bit quantities, taken from either the bottom or the top half of their respective source registers. The other halves of these source registers are ignored. The 32-bit product is written to the destination register. No overflow is possible during this instruction.

#### Encoding T1 ARMv6T2, ARMv7

SMUL<x><y><c> <Rd>, <Rn>, <Rm>

15	14	13	12	11	10	9	8	7	6	5	4	3	2	1	0	15	14	13	12	11	10	9	8	7	6	5	4	3	2	1	0
1	1	1	1	1	0	1	1	0	0	0	1	Rn			1	1	1	1	Rd			0	0	N	M	Rm					

d = UInt(Rd); n = UInt(Rn); m = UInt(Rm);  
n\_high = (N == '1'); m\_high = (M == '1');  
if d IN {13,15} || n IN {13,15} || m IN {13,15} then UNPREDICTABLE;

#### Encoding A1 ARMv5TE\*, ARMv6\*, ARMv7

SMUL<x><y><c> <Rd>, <Rn>, <Rm>

31	30	29	28	27	26	25	24	23	22	21	20	19	18	17	16	15	14	13	12	11	10	9	8	7	6	5	4	3	2	1	0
cond		0	0	0	1	0	1	1	0	Rd			(0)(0)(0)(0)				Rm			1	M	N	0	Rn							

d = UInt(Rd); n = UInt(Rn); m = UInt(Rm);  
n\_high = (N == '1'); m\_high = (M == '1');  
if d == 15 || n == 15 || m == 15 then UNPREDICTABLE;



## Assembler syntax

SMUL<x><y>{<c>}{<q>} {<Rd>}, <Rn>, <Rm>

where:

- <x> Specifies which half of the source register <Rn> is used as the first multiply operand. If <x> is B, then the bottom half (bits[15:0]) of <Rn> is used. If <x> is T, then the top half (bits[31:16]) of <Rn> is used.
- <y> Specifies which half of the source register <Rm> is used as the second multiply operand. If <y> is B, then the bottom half (bits[15:0]) of <Rm> is used. If <y> is T, then the top half (bits[31:16]) of <Rm> is used.
- <c>, <q> See *Standard assembler syntax fields* on page A8-287.
- <Rd> The destination register.
- <Rn> The source register whose bottom or top half (selected by <x>) is the first multiply operand.
- <Rm> The source register whose bottom or top half (selected by <y>) is the second multiply operand.

## Operation

```
if ConditionPassed() then
    EncodingSpecificOperations();
    operand1 = if n_high then R[n]<31:16> else R[n]<15:0>;
    operand2 = if m_high then R[m]<31:16> else R[m]<15:0>;
    result = SInt(operand1) * SInt(operand2);
    R[d] = result<31:0>;
    // Signed overflow cannot occur
```

## Exceptions

None.

### A8.8.189 SMULL

Signed Multiply Long multiplies two 32-bit signed values to produce a 64-bit result.

In ARM instructions, the condition flags can optionally be updated based on the result. Use of this option adversely affects performance on many processor implementations.

#### Encoding T1 ARMv6T2, ARMv7

SMULL<C> <RdLo>, <RdHi>, <Rn>, <Rm>

15	14	13	12	11	10	9	8	7	6	5	4	3	2	1	0	15	14	13	12	11	10	9	8	7	6	5	4	3	2	1	0				
1	1	1	1	1	0	1	1	1	0	0	0	Rn			RdLo			RdHi			0			0			0			0			Rm		

```
dLo = UInt(RdLo); dHi = UInt(RdHi); n = UInt(Rn); m = UInt(Rm); setflags = FALSE;
if dLo IN {13,15} || dHi IN {13,15} || n IN {13,15} || m IN {13,15} then UNPREDICTABLE;
if dHi == dLo then UNPREDICTABLE;
```

#### Encoding A1 ARMv4\*, ARMv5T\*, ARMv6\*, ARMv7

SMULL{S}<C> <RdLo>, <RdHi>, <Rn>, <Rm>

31	30	29	28	27	26	25	24	23	22	21	20	19	18	17	16	15	14	13	12	11	10	9	8	7	6	5	4	3	2	1	0																			
cond		0				0				0				1				1				0				S	RdHi			RdLo			Rm			1			0			0			1			Rn		

```
dLo = UInt(RdLo); dHi = UInt(RdHi); n = UInt(Rn); m = UInt(Rm); setflags = (S == '1');
if dLo == 15 || dHi == 15 || n == 15 || m == 15 then UNPREDICTABLE;
if dHi == dLo then UNPREDICTABLE;
if ArchVersion() < 6 && (dHi == n || dLo == n) then UNPREDICTABLE;
```

## Assembler syntax

SMULL{S}{<c>}{<q>} <RdLo>, <RdHi>, <Rn>, <Rm>

where:

S            If S is present, the instruction updates the flags. Otherwise, the flags are not updated.  
S can be specified only for the ARM instruction set.

<c>, <q>     See *Standard assembler syntax fields* on page A8-287.

<RdLo>     Stores the lower 32 bits of the result.

<RdHi>     Stores the upper 32 bits of the result.

<Rn>        The first operand register.

<Rm>        The second operand register.

The pre-UAL syntax SMULL<c>S is equivalent to SMULLS<c>.

## Operation

```
if ConditionPassed() then
    EncodingSpecificOperations();
    result = SInt(R[n]) * SInt(R[m]);
    R[dHi] = result<63:32>;
    R[dLo] = result<31:0>;
    if setflags then
        APSR.N = result<63>;
        APSR.Z = IsZeroBit(result<63:0>);
        if ArchVersion() == 4 then
            APSR.C = bit UNKNOWN;
            APSR.V = bit UNKNOWN;
        // else APSR.C, APSR.V unchanged
```

## Exceptions

None.

### A8.8.190 SMULWB, SMULWT

Signed Multiply (word by halfword) multiplies a signed 32-bit quantity and a signed 16-bit quantity. The signed 16-bit quantity is taken from either the bottom or the top half of its source register. The other half of the second source register is ignored. The top 32 bits of the 48-bit product are written to the destination register. The bottom 16 bits of the 48-bit product are ignored. No overflow is possible during this instruction.

#### Encoding T1 ARMv6T2, ARMv7

SMULW<y><c> <Rd>, <Rn>, <Rm>

15	14	13	12	11	10	9	8	7	6	5	4	3	2	1	0	15	14	13	12	11	10	9	8	7	6	5	4	3	2	1	0
1	1	1	1	1	0	1	1	0	0	1	1	Rn			1	1	1	1	Rd			0	0	0	M	Rm					

d = UInt(Rd); n = UInt(Rn); m = UInt(Rm); m\_high = (M == '1');  
if d IN {13,15} || n IN {13,15} || m IN {13,15} then UNPREDICTABLE;

#### Encoding A1 ARMv5TE\*, ARMv6\*, ARMv7

SMULW<y><c> <Rd>, <Rn>, <Rm>

31	30	29	28	27	26	25	24	23	22	21	20	19	18	17	16	15	14	13	12	11	10	9	8	7	6	5	4	3	2	1	0
cond		0	0	0	1	0	0	1	0	Rd			(0)	(0)	(0)	(0)	Rm			1	M	1	0	Rn							

d = UInt(Rd); n = UInt(Rn); m = UInt(Rm); m\_high = (M == '1');  
if d == 15 || n == 15 || m == 15 then UNPREDICTABLE;

## Assembler syntax

SMULW<y>{<c>}{<q>} {<Rd>}, <Rn>, <Rm>

where:

- <y> Specifies which half of the source register <Rm> is used as the second multiply operand. If <y> is B, then the bottom half (bits[15:0]) of <Rm> is used. If <y> is T, then the top half (bits[31:16]) of <Rm> is used.
- <c>, <q> See *Standard assembler syntax fields* on page A8-287.
- <Rd> The destination register.
- <Rn> The first operand register.
- <Rm> The source register whose bottom or top half (selected by <y>) is the second multiply operand.

## Operation

```
if ConditionPassed() then
    EncodingSpecificOperations();
    operand2 = if m_high then R[m]<31:16> else R[m]<15:0>;
    product = SInt(R[n]) * SInt(operand2);
    R[d] = product<47:16>;
    // Signed overflow cannot occur
```

## Exceptions

None.

### A8.8.191 SMUSD

Signed Multiply Subtract Dual performs two signed  $16 \times 16$ -bit multiplications. It subtracts one of the products from the other, and writes the result to the destination register.

Optionally, the instruction can exchange the halfwords of the second operand before performing the arithmetic. This produces top  $\times$  bottom and bottom  $\times$  top multiplication.

Overflow cannot occur.

#### Encoding T1 ARMv6T2, ARMv7

SMUSD{X}<C> <Rd>, <Rn>, <Rm>

15	14	13	12	11	10	9	8	7	6	5	4	3	2	1	0	15	14	13	12	11	10	9	8	7	6	5	4	3	2	1	0
1	1	1	1	1	0	1	1	0	1	0	0	Rn			1	1	1	1	Rd			0	0	0	M	Rm					

d = UInt(Rd); n = UInt(Rn); m = UInt(Rm); m\_swap = (M == '1');  
if d IN {13,15} || n IN {13,15} || m IN {13,15} then UNPREDICTABLE;

#### Encoding A1 ARMv6\*, ARMv7

SMUSD{X}<C> <Rd>, <Rn>, <Rm>

31	30	29	28	27	26	25	24	23	22	21	20	19	18	17	16	15	14	13	12	11	10	9	8	7	6	5	4	3	2	1	0
cond		0	1	1	1	0	0	0	0	Rd			1	1	1	1	Rm			0	1	M	1	Rn							

d = UInt(Rd); n = UInt(Rn); m = UInt(Rm); m\_swap = (M == '1');  
if d == 15 || n == 15 || m == 15 then UNPREDICTABLE;

## Assembler syntax

SMUSD{X}{<c>}{<q>} {<Rd>}, <Rn>, <Rm>

where:

- X            If X is present, the multiplications are bottom  $\times$  top and top  $\times$  bottom.  
              If the X is omitted, the multiplications are bottom  $\times$  bottom and top  $\times$  top.
- <c>, <q>     See *Standard assembler syntax fields* on page A8-287.
- <Rd>         The destination register.
- <Rn>         The first operand register.
- <Rm>         The second operand register.

## Operation

```
if ConditionPassed() then
    EncodingSpecificOperations();
    operand2 = if m_swap then ROR(R[m],16) else R[m];
    product1 = SInt(R[n]<15:0>) * SInt(operand2<15:0>);
    product2 = SInt(R[n]<31:16>) * SInt(operand2<31:16>);
    result = product1 - product2;
    R[d] = result<31:0>;
    // Signed overflow cannot occur
```

## Exceptions

None.

### A8.8.192 SRS

Store Return State is a system instruction. For details see *SRS (Thumb)* on page B9-2002 and *SRS (ARM)* on page B9-2004.

### A8.8.193 SSAT

Signed Saturate saturates an optionally-shifted signed value to a selectable signed range.

The Q flag is set if the operation saturates.

#### Encoding T1 ARMv6T2, ARMv7

SSAT<c> <Rd>, #<imm>, <Rn>{, <shift>}

15	14	13	12	11	10	9	8	7	6	5	4	3	2	1	0	15	14	13	12	11	10	9	8	7	6	5	4	3	2	1	0
1	1	1	1	0	(0)	1	1	0	0	sh	0		Rn			0	imm3		Rd		imm2	(0)		sat_imm							

```
if sh == '1' && (imm3:imm2) == '0000' then SEE SSAT16;
d = UInt(Rd); n = UInt(Rn); saturate_to = UInt(sat_imm)+1;
(shift_t, shift_n) = DecodeImmShift(sh:'0', imm3:imm2);
if d IN {13,15} || n IN {13,15} then UNPREDICTABLE;
```

#### Encoding A1 ARMv6\*, ARMv7

SSAT<c> <Rd>, #<imm>, <Rn>{, <shift>}

31	30	29	28	27	26	25	24	23	22	21	20	19	18	17	16	15	14	13	12	11	10	9	8	7	6	5	4	3	2	1	0
cond		0	1	1	0	1	0	1		sat_imm			Rd		imm5	sh	0	1			Rn										

```
d = UInt(Rd); n = UInt(Rn); saturate_to = UInt(sat_imm)+1;
(shift_t, shift_n) = DecodeImmShift(sh:'0', imm5);
if d == 15 || n == 15 then UNPREDICTABLE;
```



## Assembler syntax

SSAT{<c>}{<q>} <Rd>, #<imm>, <Rn> {, <shift>}

where:

<c>, <q> See *Standard assembler syntax fields* on page A8-287.

<Rd> The destination register.

<imm> The bit position for saturation, in the range 1 to 32. The sat\_imm field of the instruction encodes this bit position, by taking the value (<imm>-1).

<Rn> The register that contains the value to be saturated.

<shift> The optional shift, encoded in the sh bit and the immsh field, where immsh is:

- imm3:imm2 for encoding T1
- imm5 for encoding A1.

<shift> must be one of:

**omitted** No shift. Encoded as sh = 0, immsh = 0b00000.

LSL #<n> Left shift by <n> bits, with <n> in the range 1-31.  
Encoded as sh = 0, immsh = <n>.

ASR #<n> Arithmetic right shift by <n> bits, with <n> in the range 1-31.  
Encoded as sh = 1, immsh = <n>.

ASR #32 Arithmetic right shift by 32 bits, permitted only for encoding A1.  
Encoded as sh = 1, immsh = 0b00000.

### ———— Note ————

An assembler can permit ASR #0 or LSL #0 to mean the same thing as omitting the shift, but this is not standard UAL and must not be used for disassembly.

## Operation

```
if ConditionPassed() then
    EncodingSpecificOperations();
    operand = Shift(R[n], shift_t, shift_n, APSR.C); // APSR.C ignored
    (result, sat) = SignedSatQ(SInt(operand), saturate_to);
    R[d] = SignExtend(result, 32);
    if sat then
        APSR.Q = '1';
```

## Exceptions

None.

### A8.8.194 SSAT16

Signed Saturate 16 saturates two signed 16-bit values to a selected signed range.

The Q flag is set if the operation saturates.

#### Encoding T1 ARMv6T2, ARMv7

SSAT16<c> <Rd>, #<imm>, <Rn>

15	14	13	12	11	10	9	8	7	6	5	4	3	2	1	0	15	14	13	12	11	10	9	8	7	6	5	4	3	2	1	0
1	1	1	1	0	(0)	1	1	0	0	1	0	Rn				0	0	0	0	Rd				0	0	(0)	(0)	sat_imm			

d = UInt(Rd); n = UInt(Rn); saturate\_to = UInt(sat\_imm)+1;  
if d IN {13,15} || n IN {13,15} then UNPREDICTABLE;

#### Encoding A1 ARMv6\*, ARMv7

SSAT16<c> <Rd>, #<imm>, <Rn>

31	30	29	28	27	26	25	24	23	22	21	20	19	18	17	16	15	14	13	12	11	10	9	8	7	6	5	4	3	2	1	0
cond		0	1	1	0	1	0	1	0	sat_imm		Rd				(1)	(1)	(1)	(1)	0	0	1	1	Rn							

d = UInt(Rd); n = UInt(Rn); saturate\_to = UInt(sat\_imm)+1;  
if d == 15 || n == 15 then UNPREDICTABLE;

## Assembler syntax

SSAT16{<c>}{<q>} <Rd>, #<imm>, <Rn>

where:

- <c>, <q> See [Standard assembler syntax fields on page A8-287](#).
- <Rd> The destination register.
- <imm> The bit position for saturation, in the range 1 to 16. The sat\_imm field of the instruction encodes this bit position, by taking the value (<imm>-1).
- <Rn> The register that contains the values to be saturated.

## Operation

```
if ConditionPassed() then
    EncodingSpecificOperations();
    (result1, sat1) = SignedSatQ(SInt(R[n]<15:0>), saturate_to);
    (result2, sat2) = SignedSatQ(SInt(R[n]<31:16>), saturate_to);
    R[d]<15:0> = SignExtend(result1, 16);
    R[d]<31:16> = SignExtend(result2, 16);
    if sat1 || sat2 then
        APSR.Q = '1';
```

## Exceptions

None.

### A8.8.195 SSAX

Signed Subtract and Add with Exchange exchanges the two halfwords of the second operand, performs one 16-bit integer subtraction and one 16-bit addition, and writes the results to the destination register. It sets the APSR.GE bits according to the results.

#### Encoding T1 ARMv6T2, ARMv7

SSAX<c> <Rd>, <Rn>, <Rm>

15	14	13	12	11	10	9	8	7	6	5	4	3	2	1	0	15	14	13	12	11	10	9	8	7	6	5	4	3	2	1	0
1	1	1	1	1	0	1	0	1	1	1	0	Rn				1	1	1	1	Rd				0	0	0	0	Rm			

d = UInt(Rd); n = UInt(Rn); m = UInt(Rm);  
if d IN {13,15} || n IN {13,15} || m IN {13,15} then UNPREDICTABLE;

#### Encoding A1 ARMv6\*, ARMv7

SSAX<c> <Rd>, <Rn>, <Rm>

31	30	29	28	27	26	25	24	23	22	21	20	19	18	17	16	15	14	13	12	11	10	9	8	7	6	5	4	3	2	1	0		
cond		0	1	1	0	0	0	0	1	Rn				Rd				(1)	(1)	(1)	(1)	0	1	0	1	Rm							

d = UInt(Rd); n = UInt(Rn); m = UInt(Rm);  
if d == 15 || n == 15 || m == 15 then UNPREDICTABLE;

## Assembler syntax

SSAX{<c>}{<q>} {<Rd>}, <Rn>, <Rm>

where:

<c>, <q> See *Standard assembler syntax fields* on page A8-287.

<Rd> The destination register.

<Rn> The first operand register.

<Rm> The second operand register.

The pre-UAL syntax SSUBADDX<c> is equivalent to SSAX<c>.

## Operation

```
if ConditionPassed() then
    EncodingSpecificOperations();
    sum = SInt(R[n]<15:0>) + SInt(R[m]<31:16>);
    diff = SInt(R[n]<31:16>) - SInt(R[m]<15:0>);
    R[d]<15:0> = sum<15:0>;
    R[d]<31:16> = diff<15:0>;
    APSR.GE<1:0> = if sum >= 0 then '11' else '00';
    APSR.GE<3:2> = if diff >= 0 then '11' else '00';
```

## Exceptions

None.

### A8.8.196 SSUB16

Signed Subtract 16 performs two 16-bit signed integer subtractions, and writes the results to the destination register. It sets the APSR.GE bits according to the results of the subtractions.

**Encoding T1** ARMv6T2, ARMv7

SSUB16<c> <Rd>, <Rn>, <Rm>

15	14	13	12	11	10	9	8	7	6	5	4	3	2	1	0	15	14	13	12	11	10	9	8	7	6	5	4	3	2	1	0
1	1	1	1	1	0	1	0	1	1	0	1	Rn			1	1	1	1	Rd			0	0	0	0	Rm					

d = UInt(Rd); n = UInt(Rn); m = UInt(Rm);  
if d IN {13,15} || n IN {13,15} || m IN {13,15} then UNPREDICTABLE;

**Encoding A1** ARMv6\*, ARMv7

SSUB16<c> <Rd>, <Rn>, <Rm>

31	30	29	28	27	26	25	24	23	22	21	20	19	18	17	16	15	14	13	12	11	10	9	8	7	6	5	4	3	2	1	0
cond		0	1	1	0	0	0	0	1	Rn			Rd			(1)	(1)	(1)	(1)	0	1	1	1	Rm							

d = UInt(Rd); n = UInt(Rn); m = UInt(Rm);  
if d == 15 || n == 15 || m == 15 then UNPREDICTABLE;

## Assembler syntax

SSUB16{<c>}{<q>} {<Rd>}, <Rn>, <Rm>

where:

<c>, <q> See [Standard assembler syntax fields on page A8-287](#).

<Rd> The destination register.

<Rn> The first operand register.

<Rm> The second operand register.

## Operation

```
if ConditionPassed() then
    EncodingSpecificOperations();
    diff1 = SInt(R[n]<15:0>) - SInt(R[m]<15:0>);
    diff2 = SInt(R[n]<31:16>) - SInt(R[m]<31:16>);
    R[d]<15:0> = diff1<15:0>;
    R[d]<31:16> = diff2<15:0>;
    APSR.GE<1:0> = if diff1 >= 0 then '11' else '00';
    APSR.GE<3:2> = if diff2 >= 0 then '11' else '00';
```

## Exceptions

None.

### A8.8.197 SSUB8

Signed Subtract 8 performs four 8-bit signed integer subtractions, and writes the results to the destination register. It sets the APSR.GE bits according to the results of the subtractions.

**Encoding T1** ARMv6T2, ARMv7

SSUB8<c> <Rd>, <Rn>, <Rm>

15	14	13	12	11	10	9	8	7	6	5	4	3	2	1	0	15	14	13	12	11	10	9	8	7	6	5	4	3	2	1	0
1	1	1	1	1	0	1	0	1	1	0	0	Rn			1	1	1	1	Rd			0	0	0	0	Rm					

d = UInt(Rd); n = UInt(Rn); m = UInt(Rm);  
if d IN {13,15} || n IN {13,15} || m IN {13,15} then UNPREDICTABLE;

**Encoding A1** ARMv6\*, ARMv7

SSUB8<c> <Rd>, <Rn>, <Rm>

31	30	29	28	27	26	25	24	23	22	21	20	19	18	17	16	15	14	13	12	11	10	9	8	7	6	5	4	3	2	1	0
cond		0	1	1	0	0	0	0	1	Rn			Rd			(1)	(1)	(1)	(1)	1	1	1	1	Rm							

d = UInt(Rd); n = UInt(Rn); m = UInt(Rm);  
if d == 15 || n == 15 || m == 15 then UNPREDICTABLE;



## Assembler syntax

SSUB8{<c>}{<q>} {<Rd>}, <Rn>, <Rm>

where:

<c>, <q> See [Standard assembler syntax fields on page A8-287](#).

<Rd> The destination register.

<Rn> The first operand register.

<Rm> The second operand register.

## Operation

```

if ConditionPassed() then
    EncodingSpecificOperations();
    diff1 = SInt(R[n]<7:0>) - SInt(R[m]<7:0>);
    diff2 = SInt(R[n]<15:8>) - SInt(R[m]<15:8>);
    diff3 = SInt(R[n]<23:16>) - SInt(R[m]<23:16>);
    diff4 = SInt(R[n]<31:24>) - SInt(R[m]<31:24>);
    R[d]<7:0> = diff1<7:0>;
    R[d]<15:8> = diff2<7:0>;
    R[d]<23:16> = diff3<7:0>;
    R[d]<31:24> = diff4<7:0>;
    APSR.GE<0> = if diff1 >= 0 then '1' else '0';
    APSR.GE<1> = if diff2 >= 0 then '1' else '0';
    APSR.GE<2> = if diff3 >= 0 then '1' else '0';
    APSR.GE<3> = if diff4 >= 0 then '1' else '0';

```

## Exceptions

None.

## A8.8.198 STC, STC2

Store Coprocessor stores data from a coprocessor to a sequence of consecutive memory addresses. If no coprocessor can execute the instruction, an Undefined Instruction exception is generated.

This is a generic coprocessor instruction. Some of the fields have no functionality defined by the architecture and are free for use by the coprocessor instruction set designer. These are the D bit, the CRd field, and in the Unindexed addressing mode only, the imm8 field. However, coprocessors CP8-CP15 are reserved for use by ARM, and this manual defines the valid STC and STC2 instructions when coproc is in the range p8-p15. For more information see [Coprocessor support on page A2-94](#).

In an implementation that includes the Virtualization Extensions, the permitted STC access to a system control register can be trapped to Hyp mode, meaning that an attempt to execute an STC instruction in a Non-secure mode other than Hyp mode, that would be permitted in the absence of the Hyp trap controls, generates a Hyp Trap exception. For more information, see [Trapping general CPI4 accesses to debug registers on page B1-1260](#).

### ———— Note ————

For simplicity, the STC pseudocode does not show this possible trap to Hyp mode.

**Encoding T1/A1** ARMv6T2, ARMv7 for encoding T1  
ARMv4\*, ARMv5T\*, ARMv6\*, ARMv7 for encoding A1

STC{L}<c> <coproc>, <CRd>, [<Rn>, #+/-<imm>]{!}  
STC{L}<c> <coproc>, <CRd>, [<Rn>], #+/-<imm>  
STC{L}<c> <coproc>, <CRd>, [<Rn>], <option>

15	14	13	12	11	10	9	8	7	6	5	4	3	2	1	0	15	14	13	12	11	10	9	8	7	6	5	4	3	2	1	0
1	1	1	0	1	1	0	P	U	D	W	0		Rn			CRd															
31	30	29	28	27	26	25	24	23	22	21	20	19	18	17	16	15	14	13	12	11	10	9	8	7	6	5	4	3	2	1	0
																cond															

```

if P == '0' && U == '0' && D == '0' && W == '0' then UNDEFINED;
if P == '0' && U == '0' && D == '1' && W == '0' then SEE MCRR, MCRR2;
if coproc IN "101x" then SEE "Advanced SIMD and Floating-point";
n = UInt(Rn); cp = UInt(coproc);
imm32 = ZeroExtend(imm8:'00', 32); index = (P == '1'); add = (U == '1'); wback = (W == '1');
if n == 15 && (wback || CurrentInstrSet() != InstrSet_ARM) then UNPREDICTABLE;

```

**Encoding T2/A2** ARMv6T2, ARMv7 for encoding T2  
ARMv5T\*, ARMv6\*, ARMv7 for encoding A2

STC2{L}<c> <coproc>, <CRd>, [<Rn>, #+/-<imm>]{!}  
STC2{L}<c> <coproc>, <CRd>, [<Rn>], #+/-<imm>  
STC2{L}<c> <coproc>, <CRd>, [<Rn>], <option>

15	14	13	12	11	10	9	8	7	6	5	4	3	2	1	0	15	14	13	12	11	10	9	8	7	6	5	4	3	2	1	0
1	1	1	1	1	1	0	P	U	D	W	0		Rn			CRd															
31	30	29	28	27	26	25	24	23	22	21	20	19	18	17	16	15	14	13	12	11	10	9	8	7	6	5	4	3	2	1	0
																1	1	1	1	1	1	0	P	U	D	W	0		Rn		

```

if P == '0' && U == '0' && D == '0' && W == '0' then UNDEFINED;
if P == '0' && U == '0' && D == '1' && W == '0' then SEE MCRR, MCRR2;
if coproc IN "101x" then UNDEFINED;
n = UInt(Rn); cp = UInt(coproc);
imm32 = ZeroExtend(imm8:'00', 32); index = (P == '1'); add = (U == '1'); wback = (W == '1');
if n == 15 && (wback || CurrentInstrSet() != InstrSet_ARM) then UNPREDICTABLE;

```

**Advanced SIMD and Floating-point** See [Extension register load/store instructions on page A7-274](#)

## Assembler syntax

STC{2}{L}{<c>}{<q>} <coproc>, <CRd>, [<Rn>{, #+/-<imm>}] Offset. P = 1, W = 0.  
STC{2}{L}{<c>}{<q>} <coproc>, <CRd>, [<Rn>, #+/-<imm>]! Pre-indexed. P = 1, W = 1.  
STC{2}{L}{<c>}{<q>} <coproc>, <CRd>, [<Rn>], #+/-<imm> Post-indexed. P = 0, W = 1.  
STC{2}{L}{<c>}{<q>} <coproc>, <CRd>, [<Rn>], <option> Unindexed. P = 0, W = 0, U = 1.

where:

2 If specified, selects encoding T2/A2. If omitted, selects encoding T1/A1.  
L If specified, selects the D == 1 form of the encoding. If omitted, selects the D == 0 form.  
<c>, <q> See *Standard assembler syntax fields on page A8-287*. An ARM STC2 instruction must be unconditional.  
<coproc> The name of the coprocessor. The generic coprocessor names are p0-p15.  
<CRd> The coprocessor source register.  
<Rn> The base register. The SP can be used. In the ARM instruction set, for offset and unindexed addressing only, the PC can be used. However, ARM deprecates use of the PC.  
+/- Is + or omitted if the immediate offset is to be added to the base register value (add == TRUE), or – if it is to be subtracted (add == FALSE). #0 and #-0 generate different instructions.  
<imm> The immediate offset used for forming the address. Values are multiples of 4 in the range 0-1020. For the offset addressing syntax, <imm> can be omitted, meaning an offset of +0.  
<option> A coprocessor option. An integer in the range 0-255 enclosed in { }. Encoded in imm8.

The pre-UAL syntax STC<c>L is equivalent to STCL<c>.

## Operation

```

if ConditionPassed() then
    EncodingSpecificOperations();
    if !Cproc_Accepted(cp, ThisInstr()) then
        GenerateCoproprocessorException();
    else
        NullCheckIfThumbEE(n);
        offset_addr = if add then (R[n] + imm32) else (R[n] - imm32);
        address = if index then offset_addr else R[n];
        repeat
            MemA[address,4] = Coproc_GetWordToStore(cp, ThisInstr());
            address = address + 4;
        until Coproc_DoneStoring(cp, ThisInstr());
        if wback then R[n] = offset_addr;

```

## Exceptions

Undefined Instruction, Data Abort, Hyp Trap.

Uses of these instructions by specific coprocessors might generate other exceptions.

### A8.8.199 STM (STMIA, STMEA)

Store Multiple Increment After (Store Multiple Empty Ascending) stores multiple registers to consecutive memory locations using an address from a base register. The consecutive memory locations start at this address, and the address just above the last of those locations can optionally be written back to the base register.

For details of related system instructions see [STM \(User registers\) on page B9-2006](#).

#### Encoding T1 ARMv4T, ARMv5T\*, ARMv6\*, ARMv7 (not in ThumbEE)

STM<c> <Rn>!, <registers>

15	14	13	12	11	10	9	8	7	6	5	4	3	2	1	0
1	1	0	0	0	Rn	register_list									

if CurrentInstrSet() == InstrSet\_ThumbEE then SEE "ThumbEE instructions";  
n = UInt(Rn); registers = '00000000':register\_list; wback = TRUE;  
if BitCount(registers) < 1 then UNPREDICTABLE;

#### Encoding T2 ARMv6T2, ARMv7

STM<c>.W <Rn>{!}, <registers>

15	14	13	12	11	10	9	8	7	6	5	4	3	2	1	0	15	14	13	12	11	10	9	8	7	6	5	4	3	2	1	0
1	1	1	0	1	0	0	0	1	0	W	0	Rn	(0)	M	(0)	register_list															

n = UInt(Rn); registers = '0':M:'0':register\_list; wback = (W == '1');  
if n == 15 || BitCount(registers) < 2 then UNPREDICTABLE;  
if wback && registers<n> == '1' then UNPREDICTABLE;

#### Encoding A1 ARMv4\*, ARMv5T\*, ARMv6\*, ARMv7

STM<c> <Rn>{!}, <registers>

31	30	29	28	27	26	25	24	23	22	21	20	19	18	17	16	15	14	13	12	11	10	9	8	7	6	5	4	3	2	1	0
cond		1	0	0	0	1	0	W	0	Rn	register_list																				

n = UInt(Rn); registers = register\_list; wback = (W == '1');  
if n == 15 || BitCount(registers) < 1 then UNPREDICTABLE;

**ThumbEE instructions** See [16-bit ThumbEE instructions on page A9-1115](#).

## Assembler syntax

STM{<c>}{<q>} <Rn>{!}, <registers>

where:

<c>, <q> See *Standard assembler syntax fields* on page A8-287.

<Rn> The base register. The SP can be used.

! Causes the instruction to write a modified value back to <Rn>. Encoded as W = 1.  
If ! is omitted, the instruction does not change <Rn> in this way. Encoded as W = 0.

<registers> Is a list of one or more registers to be stored, separated by commas and surrounded by { and }. The lowest-numbered register is stored to the lowest memory address, through to the highest-numbered register to the highest memory address. See also *Encoding of lists of ARM core registers* on page A8-295.

Encoding T2 does not support a list containing only one register. If an STM instruction with just one register <Rt> in the list is assembled to Thumb and encoding T1 is not available, it is assembled to the equivalent STR{<c>}{<q>} <Rt>, [<Rn>]{, #4} instruction.

The SP and PC can be in the list in ARM instructions, but not in Thumb instructions. However, ARM deprecates the use of ARM instructions that include the SP or the PC in the list.

ARM deprecates the use of instructions with the base register in the list and ! specified. If the base register is not the lowest-numbered register in the list, such an instruction stores an UNKNOWN value for the base register.

An instruction with the base register in the list and ! specified cannot use encoding T2.

STMEA and STMIA are pseudo-instructions for STM. STMEA refers to its use for pushing data onto Empty Ascending stacks.

The pre-UAL syntaxes STM<c>IA and STM<c>EA are equivalent to STM<c>.

## Operation

```
if ConditionPassed() then
    EncodingSpecificOperations(); NullCheckIfThumbEE(n);
    address = R[n];
    for i = 0 to 14
        if registers<i> == '1' then
            if i == n && wback && i != LowestSetBit(registers) then
                MemA[address,4] = bits(32) UNKNOWN; // Only possible for encodings T1 and A1
            else
                MemA[address,4] = R[i];
                address = address + 4;
        if registers<15> == '1' then // Only possible for encoding A1
            MemA[address,4] = PCStoreValue();
        if wback then R[n] = R[n] + 4*BitCount(registers);
```

## Exceptions

Data Abort.

### A8.8.200 STMDA (STMED)

Store Multiple Decrement After (Store Multiple Empty Descending) stores multiple registers to consecutive memory locations using an address from a base register. The consecutive memory locations end at this address, and the address just below the lowest of those locations can optionally be written back to the base register.

For details of related system instructions see [STM \(User registers\)](#) on page B9-2006.

**Encoding A1** ARMv4\*, ARMv5T\*, ARMv6\*, ARMv7

STMDA<c> <Rn>{!}, <registers>

31	30	29	28	27	26	25	24	23	22	21	20	19	18	17	16	15	14	13	12	11	10	9	8	7	6	5	4	3	2	1	0
cond		1	0	0	0	0	0	0	W	0	Rn				register_list																

```
n = UInt(Rn); registers = register_list; wback = (W == '1');
if n == 15 || BitCount(registers) < 1 then UNPREDICTABLE;
```

## Assembler syntax

STMDA{<c>}{<q>} <Rn>{!}, <registers>

where:

- <c>, <q> See [Standard assembler syntax fields on page A8-287](#).
- <Rn> The base register. The SP can be used.
- ! Causes the instruction to write a modified value back to <Rn>. Encoded as W = 1.  
If ! is omitted, the instruction does not change <Rn> in this way. Encoded as W = 0.
- <registers> Is a list of one or more registers to be stored, separated by commas and surrounded by { and }. The lowest-numbered register is stored to the lowest memory address, through to the highest-numbered register to the highest memory address. See also [Encoding of lists of ARM core registers on page A8-295](#).  
The SP and PC can be in the list. However, instructions that include the SP or the PC in the list are deprecated.  
ARM deprecates the use of instructions with the base register in the list and ! specified. If the base register is not the lowest-numbered register in the list, such an instruction stores an UNKNOWN value for the base register.

STMED is a pseudo-instruction for STMDA, referring to its use for pushing data onto Empty Descending stacks.

The pre-UAL syntaxes STM<c>DA and STM<c>ED are equivalent to STMDA<c>.

## Operation

```

if ConditionPassed() then
    EncodingSpecificOperations();
    address = R[n] - 4*BitCount(registers) + 4;
    for i = 0 to 14
        if registers<i> == '1' then
            if i == n && wback && i != LowestSetBit(registers) then
                MemA[address,4] = bits(32) UNKNOWN;
            else
                MemA[address,4] = R[i];
                address = address + 4;
        if registers<15> == '1' then
            MemA[address,4] = PCStoreValue();
    if wback then R[n] = R[n] - 4*BitCount(registers);

```

## Exceptions

Data Abort.

### A8.8.201 STMDB (STMTD)

Store Multiple Decrement Before (Store Multiple Full Descending) stores multiple registers to consecutive memory locations using an address from a base register. The consecutive memory locations end just below this address, and the address of the first of those locations can optionally be written back to the base register.

For details of related system instructions see *STM (User registers)* on page B9-2006.

#### Encoding T1 ARMv6T2, ARMv7

STMDB<c> <Rn>{!}, <registers>

15	14	13	12	11	10	9	8	7	6	5	4	3	2	1	0	15	14	13	12	11	10	9	8	7	6	5	4	3	2	1	0
1	1	1	0	1	0	0	1	0	0	W	0		Rn	(0)	M	(0)	register_list														

```

if W == '1' && Rn == '1101' then SEE PUSH;
n = UInt(Rn); registers = '0':M:'0':register_list; wback = (W == '1');
if n == 15 || BitCount(registers) < 2 then UNPREDICTABLE;
if wback && registers<n> == '1' then UNPREDICTABLE;

```

#### Encoding A1 ARMv4\*, ARMv5T\*, ARMv6\*, ARMv7

STMDB<c> <Rn>{!}, <registers>

31	30	29	28	27	26	25	24	23	22	21	20	19	18	17	16	15	14	13	12	11	10	9	8	7	6	5	4	3	2	1	0
cond		1	0	0	1	0	0	W	0		Rn	register_list																			

```

if W == '1' && Rn == '1101' && BitCount(register_list) >= 2 then SEE PUSH;
n = UInt(Rn); registers = register_list; wback = (W == '1');
if n == 15 || BitCount(registers) < 1 then UNPREDICTABLE;

```



## Assembler syntax

STMDB{<c>}{<q>} <Rn>{!}, <registers>

where:

<c>, <q> See [Standard assembler syntax fields on page A8-287](#).

<Rn> The base register. The SP can be used. If the SP is used, and ! is specified:

- for encoding T1, it is treated as described in [PUSH on page A8-538](#)
- for encoding A1, if there is more than one register in the <registers> list, it is treated as described in [PUSH on page A8-538](#).

! Causes the instruction to write a modified value back to <Rn>. Encoded as W = 1.

If ! is omitted, the instruction does not change <Rn> in this way. Encoded as W = 0.

<registers> Is a list of one or more registers to be stored, separated by commas and surrounded by { and }. The lowest-numbered register is stored to the lowest memory address, through to the highest-numbered register to the highest memory address. See also [Encoding of lists of ARM core registers on page A8-295](#).

Encoding T1 does not support a list containing only one register. If an STMDB instruction with just one register <Rt> in the list is assembled to Thumb, it is assembled to the equivalent STR{<c>}{<q>} <Rt>, [<Rn>, #-4]{!} instruction.

The SP and PC can be in the list in ARM instructions, but not in Thumb instructions. However, ARM deprecates the use of ARM instructions that include the SP or the PC in the list.

Instructions with the base register in the list and ! specified are only available in the ARM instruction set, and ARM deprecates the use of such instructions. If the base register is not the lowest-numbered register in the list, such an instruction stores an UNKNOWN value for the base register.

STMFD is a pseudo-instruction for STMDB, referring to its use for pushing data onto Full Descending stacks.

The pre-UAL syntaxes STM<c>DB and STM<c>FD are equivalent to STMDB<c>.

## Operation

```

if ConditionPassed() then
    EncodingSpecificOperations(); NullCheckIfThumbEE(n);
    address = R[n] - 4*BitCount(registers);
    for i = 0 to 14
        if registers<i> == '1' then
            if i == n && wback && i != LowestSetBit(registers) then
                MemA[address,4] = bits(32) UNKNOWN; // Only possible for encoding A1
            else
                MemA[address,4] = R[i];
            address = address + 4;
        if registers<15> == '1' then // Only possible for encoding A1
            MemA[address,4] = PCStoreValue();
    if wback then R[n] = R[n] - 4*BitCount(registers);

```

## Exceptions

Data Abort.

### A8.8.202 STMIB (STMFA)

Store Multiple Increment Before (Store Multiple Full Ascending) stores multiple registers to consecutive memory locations using an address from a base register. The consecutive memory locations start just above this address, and the address of the last of those locations can optionally be written back to the base register.

For details of related system instructions see *STM (User registers)* on page B9-2006.

**Encoding A1** ARMv4\*, ARMv5T\*, ARMv6\*, ARMv7

STMIB<c> <Rn>{!}, <registers>

31	30	29	28	27	26	25	24	23	22	21	20	19	18	17	16	15	14	13	12	11	10	9	8	7	6	5	4	3	2	1	0		
cond		1	0	0	1	1	0	W	0	Rn								register_list															

```
n = UInt(Rn); registers = register_list; wback = (W == '1');
if n == 15 || BitCount(registers) < 1 then UNPREDICTABLE;
```

## Assembler syntax

STMIB<c>{<q>} <Rn>{!}, <registers>

where:

- <c>, <q> See [Standard assembler syntax fields on page A8-287](#).
- <Rn> The base register. The SP can be used.
- ! Causes the instruction to write a modified value back to <Rn>. Encoded as W = 1.  
If ! is omitted, the instruction does not change <Rn> in this way. Encoded as W = 0.
- <registers> Is a list of one or more registers to be stored, separated by commas and surrounded by { and }. The lowest-numbered register is stored to the lowest memory address, through to the highest-numbered register to the highest memory address. See also [Encoding of lists of ARM core registers on page A8-295](#).  
  
The SP and PC can be in the list. However, instructions that include the SP or the PC in the list are deprecated.  
  
ARM deprecates the use of instructions with the base register in the list and ! specified. If the base register is not the lowest-numbered register in the list, such an instruction stores an UNKNOWN value for the base register.

STMFA is a pseudo-instruction for STMIB, referring to its use for pushing data onto Full Ascending stacks.

The pre-UAL syntax STM<c>IB and STM<c>FA are equivalent to STMIB<c>.

## Operation

```

if ConditionPassed() then
    EncodingSpecificOperations();
    address = R[n] + 4;
    for i = 0 to 14
        if registers<i> == '1' then
            if i == n && wback && i != LowestSetBit(registers) then
                MemA[address,4] = bits(32) UNKNOWN;
            else
                MemA[address,4] = R[i];
            address = address + 4;
        if registers<15> == '1' then
            MemA[address,4] = PCStoreValue();
    if wback then R[n] = R[n] + 4*BitCount(registers);

```

## Exceptions

Data Abort.

### A8.8.203 STR (immediate, Thumb)

Store Register (immediate) calculates an address from a base register value and an immediate offset, and stores a word from a register to memory. It can use offset, post-indexed, or pre-indexed addressing. For information about memory accesses see [Memory accesses on page A8-294](#).

**Encoding T1** ARMv4T, ARMv5T\*, ARMv6\*, ARMv7  
STR<c> <Rt>, [<Rn>{, #<imm>}]

15	14	13	12	11	10	9	8	7	6	5	4	3	2	1	0
0	1	1	0	0	imm5					Rn			Rt		

t = UInt(Rt); n = UInt(Rn); imm32 = ZeroExtend(imm5:'00', 32);  
index = TRUE; add = TRUE; wback = FALSE;

**Encoding T2** ARMv4T, ARMv5T\*, ARMv6\*, ARMv7  
STR<c> <Rt>, [SP, #<imm>]

15	14	13	12	11	10	9	8	7	6	5	4	3	2	1	0
1	0	0	1	0	Rt			imm8							

t = UInt(Rt); n = 13; imm32 = ZeroExtend(imm8:'00', 32);  
index = TRUE; add = TRUE; wback = FALSE;

**Encoding T3** ARMv6T2, ARMv7  
STR<c>.W <Rt>, [<Rn>, #<imm12>]

15	14	13	12	11	10	9	8	7	6	5	4	3	2	1	0	15	14	13	12	11	10	9	8	7	6	5	4	3	2	1	0
1	1	1	1	1	0	0	0	1	1	0	0	Rn			Rt		imm12														

if Rn == '1111' then UNDEFINED;  
t = UInt(Rt); n = UInt(Rn); imm32 = ZeroExtend(imm12, 32);  
index = TRUE; add = TRUE; wback = FALSE;  
if t == 15 then UNPREDICTABLE;

**Encoding T4** ARMv6T2, ARMv7  
STR<c> <Rt>, [<Rn>, #-<imm8>]  
STR<c> <Rt>, [<Rn>], #+/-<imm8>  
STR<c> <Rt>, [<Rn>, #+/-<imm8>!]

15	14	13	12	11	10	9	8	7	6	5	4	3	2	1	0	15	14	13	12	11	10	9	8	7	6	5	4	3	2	1	0
1	1	1	1	1	0	0	0	0	1	0	0	Rn			Rt		1	P	U	W	imm8										

if P == '1' && U == '1' && W == '0' then SEE STRT;  
if Rn == '1101' && P == '1' && U == '0' && W == '1' && imm8 == '00000100' then SEE PUSH;  
if Rn == '1111' || (P == '0' && W == '0') then UNDEFINED;  
t = UInt(Rt); n = UInt(Rn); imm32 = ZeroExtend(imm8, 32);  
index = (P == '1'); add = (U == '1'); wback = (W == '1');  
if t == 15 || (wback && n == t) then UNPREDICTABLE;

## Assembler syntax

STR{<c>}{<q>} <Rt>, [<Rn> {, #+/-<imm>}]	Offset: index==TRUE, wback==FALSE
STR{<c>}{<q>} <Rt>, [<Rn>, #+/-<imm>]!	Pre-indexed: index==TRUE, wback==TRUE
STR{<c>}{<q>} <Rt>, [<Rn>], #+/-<imm>	Post-indexed: index==FALSE, wback==TRUE

where:

<c>, <q> See [Standard assembler syntax fields on page A8-287](#).

<Rt> The source register. The SP can be used.

<Rn> The base register. The SP can be used.

+/- Is + or omitted if the immediate offset is to be added to the base register value (add == TRUE), or – if it is to be subtracted (add == FALSE). #0 and #-0 generate different instructions.

<imm> The immediate offset used for forming the address. Values are:

<b>Encoding T1</b>	multiples of 4 in the range 0-124
<b>Encoding T2</b>	multiples of 4 in the range 0-1020
<b>Encoding T3</b>	any value in the range 0-4095
<b>Encoding T4</b>	any value in the range 0-255.

For the offset addressing syntax, <imm> can be omitted, meaning an offset of 0.

## Operation

```

if ConditionPassed() then
    EncodingSpecificOperations(); NullCheckIfThumbEE(n);
    offset_addr = if add then (R[n] + imm32) else (R[n] - imm32);
    address = if index then offset_addr else R[n];
    if UnalignedSupport() || address<1:0> == '00' then
        MemU[address,4] = R[t];
    else // Can only occur before ARMv7
        MemU[address,4] = bits(32) UNKNOWN;
    if wback then R[n] = offset_addr;

```

## Exceptions

Data Abort.

## ThumbEE instruction

ThumbEE has an additional STR (immediate) encoding. For details see [STR \(immediate\) on page A9-1130](#).

### A8.8.204 STR (immediate, ARM)

Store Register (immediate) calculates an address from a base register value and an immediate offset, and stores a word from a register to memory. It can use offset, post-indexed, or pre-indexed addressing. For information about memory accesses see [Memory accesses on page A8-294](#).

**Encoding A1** ARMv4\*, ARMv5T\*, ARMv6\*, ARMv7

STR<c> <Rt>, [<Rn>{, #+/-<imm12>}]

STR<c> <Rt>, [<Rn>], #+/-<imm12>

STR<c> <Rt>, [<Rn>, #+/-<imm12>]!

31	30	29	28	27	26	25	24	23	22	21	20	19	18	17	16	15	14	13	12	11	10	9	8	7	6	5	4	3	2	1	0
cond				0	1	0	P	U	0	W	0	Rn				Rt				imm12											

```

if P == '0' && W == '1' then SEE STRT;
if Rn == '1101' && P == '1' && U == '0' && W == '1' && imm12 == '00000000100' then SEE PUSH;
t = UInt(Rt); n = UInt(Rn); imm32 = ZeroExtend(imm12, 32);
index = (P == '1'); add = (U == '1'); wback = (P == '0') || (W == '1');
if wback && (n == 15 || n == t) then UNPREDICTABLE;

```

## Assembler syntax

STR{<c>}{<q>} <Rt>, [<Rn> {, #+/-<imm>}]	Offset: index==TRUE, wback==FALSE
STR{<c>}{<q>} <Rt>, [<Rn>, #+/-<imm>]!	Pre-indexed: index==TRUE, wback==TRUE
STR{<c>}{<q>} <Rt>, [<Rn>], #+/-<imm>	Post-indexed: index==FALSE, wback==TRUE

where:

<c>, <q>	See <a href="#">Standard assembler syntax fields on page A8-287</a> .
<Rt>	The source register. The SP or the PC can be used. However, ARM deprecates use of the PC.
<Rn>	The base register. The SP can be used. For offset addressing only, the PC can be used. However, ARM deprecates use of the PC.
+/-	Is + or omitted if the immediate offset is to be added to the base register value (add == TRUE), or – if it is to be subtracted (add == FALSE). #0 and #-0 generate different instructions.
<imm>	The immediate offset used for forming the address. Any value in the range 0-4095 is permitted. For the offset addressing syntax, <imm> can be omitted, meaning an offset of 0.

## Operation

```

if ConditionPassed() then
    EncodingSpecificOperations();
    offset_addr = if add then (R[n] + imm32) else (R[n] - imm32);
    address = if index then offset_addr else R[n];
    MemU[address,4] = if t == 15 then PCStoreValue() else R[t];
    if wback then R[n] = offset_addr;

```

## Exceptions

Data Abort.

### A8.8.205 STR (register)

Store Register (register) calculates an address from a base register value and an offset register value, stores a word from a register to memory. The offset register value can optionally be shifted. For information about memory accesses see [Memory accesses](#) on page A8-294.

**Encoding T1** ARMv4T, ARMv5T\*, ARMv6\*, ARMv7  
STR<c> <Rt>, [<Rn>, <Rm>]

15	14	13	12	11	10	9	8	7	6	5	4	3	2	1	0
0	1	0	1	0	0	0	Rm		Rn		Rt				

```
if CurrentInstrSet() == InstrSet_ThumbEE then SEE "Modified operation in ThumbEE";
t = UInt(Rt); n = UInt(Rn); m = UInt(Rm);
index = TRUE; add = TRUE; wback = FALSE;
(shift_t, shift_n) = (SRTYPE_LSL, 0);
```

**Encoding T2** ARMv6T2, ARMv7  
STR<c>.W <Rt>, [<Rn>, <Rm>{, LSL #<imm2>}]

15	14	13	12	11	10	9	8	7	6	5	4	3	2	1	0	15	14	13	12	11	10	9	8	7	6	5	4	3	2	1	0
1	1	1	1	1	0	0	0	0	1	0	0	Rn		Rt		0	0	0	0	0	0	imm2	Rm								

```
if Rn == '1111' then UNDEFINED;
t = UInt(Rt); n = UInt(Rn); m = UInt(Rm);
index = TRUE; add = TRUE; wback = FALSE;
(shift_t, shift_n) = (SRTYPE_LSL, UInt(imm2));
if t == 15 || m IN {13,15} then UNPREDICTABLE;
```

**Encoding A1** ARMv4\*, ARMv5T\*, ARMv6\*, ARMv7  
STR<c> <Rt>, [<Rn>, +/-<Rm>{, <shift>}]{!}  
STR<c> <Rt>, [<Rn>], +/-<Rm>{, <shift>}

31	30	29	28	27	26	25	24	23	22	21	20	19	18	17	16	15	14	13	12	11	10	9	8	7	6	5	4	3	2	1	0
cond		0	1	1	P	U	0	W	0	Rn		Rt		imm5			type	0	Rm												

```
if P == '0' && W == '1' then SEE STRT;
t = UInt(Rt); n = UInt(Rn); m = UInt(Rm);
index = (P == '1'); add = (U == '1'); wback = (P == '0') || (W == '1');
(shift_t, shift_n) = DecodeImmShift(type, imm5);
if m == 15 then UNPREDICTABLE;
if wback && (n == 15 || n == t) then UNPREDICTABLE;
if ArchVersion() < 6 && wback && m == n then UNPREDICTABLE;
```

**Modified operation in ThumbEE**

See [STR \(register\)](#) on page A9-1121



## Assembler syntax

STR{<c>}{<q>} <Rt>, [<Rn>, <Rm>{, <shift>}]      Offset: index==TRUE, wback==FALSE  
STR{<c>}{<q>} <Rt>, [<Rn>, <Rm>{, <shift>}]!      Pre-indexed: index==TRUE, wback==TRUE  
STR{<c>}{<q>} <Rt>, [<Rn>], <Rm>{, <shift>}      Post-indexed: index==FALSE, wback==TRUE

where:

<c>, <q>      See [Standard assembler syntax fields on page A8-287](#).

<Rt>      The source register. The SP can be used. In the ARM instruction set, the PC can be used. However, ARM deprecates use of the PC.

<Rn>      The base register. The SP can be used. In the ARM instruction set, for offset addressing only, the PC can be used. However, ARM deprecates use of the PC.

+/-      Is + or omitted if the optionally shifted value of <Rm> is to be added to the base register value (add == TRUE), or – if it is to be subtracted (permitted in ARM instructions only, add == FALSE).

<Rm>      Contains the offset that is optionally shifted and added to the value of <Rn> to form the address.

<shift>      The shift to apply to the value read from <Rm>. If present, encoding T1 is not permitted. If absent, no shift is applied and all encodings are permitted. For encoding T2, <shift> can only be omitted, encoded as imm2 = 0b00, or LSL #<imm> with <imm> = 1, 2, or 3, and <imm> encoded in imm2. For encoding A1, see [Shifts applied to a register on page A8-291](#).

## Operation

```
if ConditionPassed() then
    EncodingSpecificOperations(); NullCheckIfThumbEE(n);
    offset = Shift(R[m], shift_t, shift_n, APSR.C);
    offset_addr = if add then (R[n] + offset) else (R[n] - offset);
    address = if index then offset_addr else R[n];
    if t == 15 then // Only possible for encoding A1
        data = PCStoreValue();
    else
        data = R[t];
    if UnalignedSupport() || address<1:0> == '00' || CurrentInstrSet() == InstrSet_ARM then
        MemU[address,4] = data;
    else // Can only occur before ARMv7
        MemU[address,4] = bits(32) UNKNOWN;
    if wback then R[n] = offset_addr;
```

## Exceptions

Data Abort.

### A8.8.206 STRB (immediate, Thumb)

Store Register Byte (immediate) calculates an address from a base register value and an immediate offset, and stores a byte from a register to memory. It can use offset, post-indexed, or pre-indexed addressing. For information about memory accesses see [Memory accesses on page A8-294](#).

#### Encoding T1 ARMv4T, ARMv5T\*, ARMv6\*, ARMv7

STRB<c> <Rt>, [<Rn>, #<imm5>]

15	14	13	12	11	10	9	8	7	6	5	4	3	2	1	0
0	1	1	1	0	imm5					Rn			Rt		

t = UInt(Rt); n = UInt(Rn); imm32 = ZeroExtend(imm5, 32);  
index = TRUE; add = TRUE; wback = FALSE;

#### Encoding T2 ARMv6T2, ARMv7

STRB<c>.W <Rt>, [<Rn>, #<imm12>]

15	14	13	12	11	10	9	8	7	6	5	4	3	2	1	0	15	14	13	12	11	10	9	8	7	6	5	4	3	2	1	0
1	1	1	1	1	0	0	0	1	0	0	0	Rn			Rt			imm12													

if Rn == '1111' then UNDEFINED;  
t = UInt(Rt); n = UInt(Rn); imm32 = ZeroExtend(imm12, 32);  
index = TRUE; add = TRUE; wback = FALSE;  
if t IN {13,15} then UNPREDICTABLE;

#### Encoding T3 ARMv6T2, ARMv7

STRB<c> <Rt>, [<Rn>, #-<imm8>]

STRB<c> <Rt>, [<Rn>], #+/-<imm8>

STRB<c> <Rt>, [<Rn>, #+/-<imm8>]!

15	14	13	12	11	10	9	8	7	6	5	4	3	2	1	0	15	14	13	12	11	10	9	8	7	6	5	4	3	2	1	0
1	1	1	1	1	0	0	0	0	0	0	0	Rn			Rt			1	P	U	W	imm8									

if P == '1' && U == '1' && W == '0' then SEE STRBT;  
if Rn == '1111' || (P == '0' && W == '0') then UNDEFINED;  
t = UInt(Rt); n = UInt(Rn); imm32 = ZeroExtend(imm8, 32);  
index = (P == '1'); add = (U == '1'); wback = (W == '1');  
if t IN {13,15} || (wback && n == t) then UNPREDICTABLE;

## Assembler syntax

STRB{<c>}{<q>} <Rt>, [<Rn> {, #+/-<imm>}]	Offset: index==TRUE, wback==FALSE
STRB{<c>}{<q>} <Rt>, [<Rn>, #+/-<imm>]!	Pre-indexed: index==TRUE, wback==TRUE
STRB{<c>}{<q>} <Rt>, [<Rn>], #+/-<imm>	Post-indexed: index==FALSE, wback==TRUE

where:

<c>, <q> See [Standard assembler syntax fields on page A8-287](#).

<Rt> The source register.

<Rn> The base register. The SP can be used.

+/- Is + or omitted if the immediate offset is to be added to the base register value (add == TRUE), or – if it is to be subtracted (add == FALSE). #0 and #-0 generate different instructions.

<imm> The immediate offset used for forming the address. Values are:

<b>Encoding T1</b>	any value in the range 0-31
<b>Encoding T2</b>	any value in the range 0-4095
<b>Encoding T3</b>	any value in the range 0-255.

For the offset addressing syntax, <imm> can be omitted, meaning an offset of 0.

The pre-UAL syntax STR<c>B is equivalent to STRB<c>.

## Operation

```

if ConditionPassed() then
    EncodingSpecificOperations(); NullCheckIfThumbEE(n);
    offset_addr = if add then (R[n] + imm32) else (R[n] - imm32);
    address = if index then offset_addr else R[n];
    MemU[address,1] = R[t]<7:0>;
    if wback then R[n] = offset_addr;

```

## Exceptions

Data Abort.

### A8.8.207 STRB (immediate, ARM)

Store Register Byte (immediate) calculates an address from a base register value and an immediate offset, and stores a byte from a register to memory. It can use offset, post-indexed, or pre-indexed addressing. For information about memory accesses see [Memory accesses on page A8-294](#).

**Encoding A1** ARMv4\*, ARMv5T\*, ARMv6\*, ARMv7

STRB<c> <Rt>, [<Rn>{, #+/-<imm12>}]

STRB<c> <Rt>, [<Rn>], #+/-<imm12>

STRB<c> <Rt>, [<Rn>, #+/-<imm12>]!

31	30	29	28	27	26	25	24	23	22	21	20	19	18	17	16	15	14	13	12	11	10	9	8	7	6	5	4	3	2	1	0
cond				0	1	0	P	U	1	W	0	Rn				Rt				imm12											

if P == '0' && W == '1' then SEE STRBT;

t = UInt(Rt); n = UInt(Rn); imm32 = ZeroExtend(imm12, 32);

index = (P == '1'); add = (U == '1'); wback = (P == '0') || (W == '1');

if t == 15 then UNPREDICTABLE;

if wback && (n == 15 || n == t) then UNPREDICTABLE;

## Assembler syntax

STRB{<c>}{<q>} <Rt>, [<Rn> {, #+/-<imm>}]	Offset: index==TRUE, wback==FALSE
STRB{<c>}{<q>} <Rt>, [<Rn>, #+/-<imm>]!	Pre-indexed: index==TRUE, wback==TRUE
STRB{<c>}{<q>} <Rt>, [<Rn>], #+/-<imm>	Post-indexed: index==FALSE, wback==TRUE

where:

<c>, <q>	See <i>Standard assembler syntax fields</i> on page A8-287.
<Rt>	The source register.
<Rn>	The base register. The SP can be used. For offset addressing only, the PC can be used. However, ARM deprecates use of the PC.
+/-	Is + or omitted if the immediate offset is to be added to the base register value (add == TRUE), or – if it is to be subtracted (add == FALSE). #0 and #-0 generate different instructions.
<imm>	The immediate offset used for forming the address. Values are 0-4095. For the offset addressing syntax, <imm> can be omitted, meaning an offset of 0.

The pre-UAL syntax STR<c>B is equivalent to STRB<c>.

## Operation

```

if ConditionPassed() then
    EncodingSpecificOperations();
    offset_addr = if add then (R[n] + imm32) else (R[n] - imm32);
    address = if index then offset_addr else R[n];
    MemU[address,1] = R[t]<7:0>;
    if wback then R[n] = offset_addr;

```

## Exceptions

Data Abort.

### A8.8.208 STRB (register)

Store Register Byte (register) calculates an address from a base register value and an offset register value, and stores a byte from a register to memory. The offset register value can optionally be shifted. For information about memory accesses see *Memory accesses* on page A8-294.

**Encoding T1** ARMv4T, ARMv5T\*, ARMv6\*, ARMv7  
STRB<c> <Rt>, [<Rn>, <Rm>]

15	14	13	12	11	10	9	8	7	6	5	4	3	2	1	0
0	1	0	1	0	1	0	Rm			Rn			Rt		

```
t = UInt(Rt); n = UInt(Rn); m = UInt(Rm);
index = TRUE; add = TRUE; wback = FALSE;
(shift_t, shift_n) = (SRTYPE_LSL, 0);
```

**Encoding T2** ARMv6T2, ARMv7  
STRB<c>.W <Rt>, [<Rn>, <Rm>{, LSL #<imm2>}]

15	14	13	12	11	10	9	8	7	6	5	4	3	2	1	0	15	14	13	12	11	10	9	8	7	6	5	4	3	2	1	0
1	1	1	1	1	0	0	0	0	0	0	0	Rn			Rt			0	0	0	0	0	0	imm2	Rm						

```
if Rn == '1111' then UNDEFINED;
t = UInt(Rt); n = UInt(Rn); m = UInt(Rm);
index = TRUE; add = TRUE; wback = FALSE;
(shift_t, shift_n) = (SRTYPE_LSL, UInt(imm2));
if t IN {13,15} || m IN {13,15} then UNPREDICTABLE;
```

**Encoding A1** ARMv4\*, ARMv5T\*, ARMv6\*, ARMv7  
STRB<c> <Rt>, [<Rn>, +/-<Rm>{, <shift>}]{!}  
STRB<c> <Rt>, [<Rn>, +/-<Rm>{, <shift>}]

31	30	29	28	27	26	25	24	23	22	21	20	19	18	17	16	15	14	13	12	11	10	9	8	7	6	5	4	3	2	1	0
cond		0	1	1	P	U	1	W	0	Rn			Rt			imm5			type	0	Rm										

```
if P == '0' && W == '1' then SEE STRBT;
t = UInt(Rt); n = UInt(Rn); m = UInt(Rm);
index = (P == '1'); add = (U == '1'); wback = (P == '0') || (W == '1');
(shift_t, shift_n) = DecodeImmShift(type, imm5);
if t == 15 || m == 15 then UNPREDICTABLE;
if wback && (n == 15 || n == t) then UNPREDICTABLE;
if ArchVersion() < 6 && wback && m == n then UNPREDICTABLE;
```

## Assembler syntax

STRB{<c>}{<q>} <Rt>, [<Rn>, <Rm>{, <shift>}]      Offset: index==TRUE, wback==FALSE  
STRB{<c>}{<q>} <Rt>, [<Rn>, <Rm>{, <shift>}]!      Pre-indexed: index==TRUE, wback==TRUE  
STRB{<c>}{<q>} <Rt>, [<Rn>], <Rm>{, <shift>}      Post-indexed: index==FALSE, wback==TRUE

where:

<c>, <q>      See *Standard assembler syntax fields on page A8-287*.

<Rt>      The source register.

<Rn>      The base register. The SP can be used. In the ARM instruction set, for offset addressing only, the PC can be used. However, ARM deprecates use of the PC.

+/-      Is + or omitted if the optionally shifted value of <Rm> is to be added to the base register value (add == TRUE), or – if it is to be subtracted (permitted in ARM instructions only, add == FALSE).

<Rm>      Contains the offset that is optionally shifted and added to the value of <Rn> to form the address.

<shift>      The shift to apply to the value read from <Rm>. If present, encoding T1 is not permitted. If absent, no shift is applied and all encodings are permitted. For encoding T2, <shift> can only be omitted, encoded as imm2 = 0b00, or LSL #<imm> with <imm> = 1, 2, or 3, and <imm> encoded in imm2. For encoding A1, see *Shifts applied to a register on page A8-291*.

The pre-UAL syntax STR<c>B is equivalent to STRB<c>.

## Operation

```
if ConditionPassed() then
    EncodingSpecificOperations();  NullCheckIfThumbEE(n);
    offset = Shift(R[m], shift_t, shift_n, APSR.C);
    offset_addr = if add then (R[n] + offset) else (R[n] - offset);
    address = if index then offset_addr else R[n];
    MemU[address,1] = R[t]<7:0>;
    if wback then R[n] = offset_addr;
```

## Exceptions

Data Abort.

## A8.8.209 STRBT

Store Register Byte Unprivileged stores a byte from a register to memory. For information about memory accesses see [Memory accesses on page A8-294](#).

The memory access is restricted as if the processor were running in User mode. This makes no difference if the processor is actually running in User mode.

STRBT is UNPREDICTABLE in Hyp mode.

The Thumb instruction uses an offset addressing mode, that calculates the address used for the memory access from a base register value and an immediate offset, and leaves the base register unchanged.

The ARM instruction uses a post-indexed addressing mode, that uses a base register value as the address for the memory access, and calculates a new address from a base register value and an offset and writes it back to the base register. The offset can be an immediate value or an optionally-shifted register value.

### Encoding T1 ARMv6T2, ARMv7

STRBT<c> <Rt>, [<Rn>, #<imm8>]

15	14	13	12	11	10	9	8	7	6	5	4	3	2	1	0	15	14	13	12	11	10	9	8	7	6	5	4	3	2	1	0
1	1	1	1	1	0	0	0	0	0	0	0	Rn				Rt	1	1	1	0	imm8										

```
if Rn == '1111' then UNDEFINED;
t = UInt(Rt); n = UInt(Rn); postindex = FALSE; add = TRUE;
register_form = FALSE; imm32 = ZeroExtend(imm8, 32);
if t IN {13,15} then UNPREDICTABLE;
```

### Encoding A1 ARMv4\*, ARMv5T\*, ARMv6\*, ARMv7

STRBT<c> <Rt>, [<Rn>], #+/-<imm12>

31	30	29	28	27	26	25	24	23	22	21	20	19	18	17	16	15	14	13	12	11	10	9	8	7	6	5	4	3	2	1	0
cond		0	1	0	0	U	1	1	0	Rn				Rt	imm12																

```
t = UInt(Rt); n = UInt(Rn); postindex = TRUE; add = (U == '1');
register_form = FALSE; imm32 = ZeroExtend(imm12, 32);
if t == 15 || n == 15 || n == t then UNPREDICTABLE;
```

### Encoding A2 ARMv4\*, ARMv5T\*, ARMv6\*, ARMv7

STRBT<c> <Rt>, [<Rn>], +/-<Rm>{, <shift>}

31	30	29	28	27	26	25	24	23	22	21	20	19	18	17	16	15	14	13	12	11	10	9	8	7	6	5	4	3	2	1	0
cond		0	1	1	0	U	1	1	0	Rn				Rt	imm5			type	0	Rm											

```
t = UInt(Rt); n = UInt(Rn); m = UInt(Rm); postindex = TRUE; add = (U == '1');
register_form = TRUE; (shift_t, shift_n) = DecodeImmShift(type, imm5);
if t == 15 || n == 15 || n == t || m == 15 then UNPREDICTABLE;
if ArchVersion() < 6 && m == n then UNPREDICTABLE;
```



## Assembler syntax

STRBT{<c>}{<q>} <Rt>, [<Rn> {, #<imm>}]	Offset: Thumb only
STRBT{<c>}{<q>} <Rt>, [<Rn>] {, #<imm>}	Post-indexed: ARM only
STRBT{<c>}{<q>} <Rt>, [<Rn>], +/-<Rm> {, <shift>}	Post-indexed: ARM only

where:

<c>, <q>	See <a href="#">Standard assembler syntax fields on page A8-287</a> .
<Rt>	The source register.
<Rn>	The base register. The SP can be used.
+/-	Is + or omitted if <imm> or the optionally shifted value of <Rm> is to be added to the base register value (add == TRUE), or – if it is to be subtracted (permitted in ARM instructions only, add == FALSE).
<imm>	The immediate offset applied to the value of <Rn>. Values are 0-255 for encoding T1, and 0-4095 for encoding A1. <imm> can be omitted, meaning an offset of 0.
<Rm>	Contains the offset that is optionally shifted and added to the value of <Rn> to form the address.
<shift>	The shift to apply to the value read from <Rm>. If omitted, no shift is applied. <a href="#">Shifts applied to a register on page A8-291</a> describes the shifts and how they are encoded.

The pre-UAL syntax STR<c>BT is equivalent to STRBT<c>.

## Operation

```

if ConditionPassed() then
    if CurrentModeIsHyp() then UNPREDICTABLE;           // Hyp mode
    EncodingSpecificOperations(); NullCheckIfThumbEE(n);
    offset = if register_form then Shift(R[m], shift_t, shift_n, APSR.C) else imm32;
    offset_addr = if add then (R[n] + offset) else (R[n] - offset);
    address = if postindex then R[n] else offset_addr;
    MemU_unpriv[address,1] = R[t]<7:0>;
    if postindex then R[n] = offset_addr;

```

## Exceptions

Data Abort.

### A8.8.210 STRD (immediate)

Store Register Dual (immediate) calculates an address from a base register value and an immediate offset, and stores two words from two registers to memory. It can use offset, post-indexed, or pre-indexed addressing. For information about memory accesses see [Memory accesses](#) on page A8-294.

#### Encoding T1 ARMv6T2, ARMv7

STRD<c> <Rt>, <Rt2>, [<Rn>{, #+/-<imm>}]

STRD<c> <Rt>, <Rt2>, [<Rn>], #+/-<imm>

STRD<c> <Rt>, <Rt2>, [<Rn>, #+/-<imm>]!

15	14	13	12	11	10	9	8	7	6	5	4	3	2	1	0	15	14	13	12	11	10	9	8	7	6	5	4	3	2	1	0
1	1	1	0	1	0	0	P	U	1	W	0	Rn				Rt				Rt2				imm8							

```

if P == '0' && W == '0' then SEE "ReLated encodings";
t = UInt(Rt); t2 = UInt(Rt2); n = UInt(Rn); imm32 = ZeroExtend(imm8:'00', 32);
index = (P == '1'); add = (U == '1'); wback = (W == '1');
if wback && (n == t || n == t2) then UNPREDICTABLE;
if n == 15 || t IN {13,15} || t2 IN {13,15} then UNPREDICTABLE;

```

#### Encoding A1 ARMv5TE\*, ARMv6\*, ARMv7

STRD<c> <Rt>, <Rt2>, [<Rn>{, #+/-<imm8>}]

STRD<c> <Rt>, <Rt2>, [<Rn>], #+/-<imm8>

STRD<c> <Rt>, <Rt2>, [<Rn>, #+/-<imm8>]!

31	30	29	28	27	26	25	24	23	22	21	20	19	18	17	16	15	14	13	12	11	10	9	8	7	6	5	4	3	2	1	0
cond				0	0	0	P	U	1	W	0	Rn				Rt				imm4H				1	1	1	1	imm4L			

```

if Rt<0> == '1' then UNPREDICTABLE;
t = UInt(Rt); t2 = t+1; n = UInt(Rn); imm32 = ZeroExtend(imm4H:imm4L, 32);
index = (P == '1'); add = (U == '1'); wback = (P == '0') || (W == '1');
if P == '0' && W == '1' then UNPREDICTABLE;
if wback && (n == 15 || n == t || n == t2) then UNPREDICTABLE;
if t2 == 15 then UNPREDICTABLE;

```

**Related encodings** See [Load/store dual](#), [load/store exclusive](#), [table branch](#) on page A6-238.

## Assembler syntax

STRD{<c>}{<q>} <Rt>, <Rt2>, [<Rn> {, #+/-<imm>}] Offset: index==TRUE, wback==FALSE  
STRD{<c>}{<q>} <Rt>, <Rt2>, [<Rn>, #+/-<imm>]! Pre-indexed: index==TRUE, wback==TRUE  
STRD{<c>}{<q>} <Rt>, <Rt2>, [<Rn>], #+/-<imm> Post-indexed: index==FALSE, wback==TRUE

where:

<c>, <q> See [Standard assembler syntax fields on page A8-287](#).

<Rt> The first source register. For an ARM instruction, <Rt> must be even-numbered and not R14.

<Rt2> The second source register. For an ARM instruction, <Rt2> must be <R(t+1)>.

<Rn> The base register. The SP can be used. In the ARM instruction set, for offset addressing only, the PC can be used. However, ARM deprecates use of the PC.

+/- Is + or omitted if the immediate offset is to be added to the base register value (add == TRUE), or – if it is to be subtracted (add == FALSE). #0 and #-0 generate different instructions.

<imm> The immediate offset used for forming the address. Values are multiples of 4 in the range 0-1020 for encoding T1, and any value in the range 0-255 for encoding A1. For the offset addressing syntax, <imm> can be omitted, meaning an offset of 0.

The pre-UAL syntax STR<c>D is equivalent to STRD<c>.

## Operation

```

if ConditionPassed() then
    EncodingSpecificOperations(); NullCheckIfThumbEE(n);
    offset_addr = if add then (R[n] + imm32) else (R[n] - imm32);
    address = if index then offset_addr else R[n];
    if HaveLPAE() && address<2:0> == '000' then
        bits(64) data;
        if BigEndian() then
            data<63:32> = R[t];
            data<31:0> = R[t2];
        else
            data<31:0> = R[t];
            data<63:32> = R[t2];
        MemA[Address,8] = data;
    else
        MemA[address,4] = R[t];
        MemA[address+4,4] = R[t2];
    if wback then R[n] = offset_addr;

```

## Exceptions

Data Abort.

### A8.8.211 STRD (register)

Store Register Dual (register) calculates an address from a base register value and a register offset, and stores two words from two registers to memory. It can use offset, post-indexed, or pre-indexed addressing. For information about memory accesses see [Memory accesses](#) on page A8-294.

#### Encoding A1 ARMv5TE\*, ARMv6\*, ARMv7

STRD<c> <Rt>, <Rt2>, [<Rn>, +/-<Rm>]{!}

STRD<c> <Rt>, <Rt2>, [<Rn>], +/-<Rm>

31	30	29	28	27	26	25	24	23	22	21	20	19	18	17	16	15	14	13	12	11	10	9	8	7	6	5	4	3	2	1	0
cond			0	0	0	P	U	0	W	0	Rn				Rt				(0)	(0)	(0)	(0)	1	1	1	1	Rm				

```

if Rt<0> == '1' then UNPREDICTABLE;
t = UInt(Rt); t2 = t+1; n = UInt(Rn); m = UInt(Rm);
index = (P == '1'); add = (U == '1'); wback = (P == '0') || (W == '1');
if P == '0' && W == '1' then UNPREDICTABLE;
if t2 == 15 || m == 15 then UNPREDICTABLE;
if wback && (n == 15 || n == t || n == t2) then UNPREDICTABLE;
if ArchVersion() < 6 && wback && m == n then UNPREDICTABLE;

```

## Assembler syntax

STRD{<c>}{<q>} <Rt>, <Rt2>, [<Rn>, +/-<Rm>]	Offset: index==TRUE, wback==FALSE
STRD{<c>}{<q>} <Rt>, <Rt2>, [<Rn>, +/-<Rm>]!	Pre-indexed: index==TRUE, wback==TRUE
STRD{<c>}{<q>} <Rt>, <Rt2>, [<Rn>], +/-<Rm>	Post-indexed: index==FALSE, wback==TRUE

where:

<c>, <q> See [Standard assembler syntax fields on page A8-287](#).

<Rt> The first source register. This register must be even-numbered and not R14.

<Rt2> The second source register. This register must be <R(t+1)>.

<Rn> The base register. The SP can be used. For offset addressing only, the PC can be used. However, ARM deprecates use of the PC.

+/- Is + or omitted if the immediate offset is to be added to the base register value (add == TRUE), or – if it is to be subtracted (add == FALSE).

<Rm> Contains the offset that is added to the value of <Rn> to form the address.

The pre-UAL syntax STR<c>D is equivalent to STRD<c>.

## Operation

```

if ConditionPassed() then
    EncodingSpecificOperations();
    offset_addr = if add then (R[n] + R[m]) else (R[n] - R[m]);
    address = if index then offset_addr else R[n];
    if HaveLPAE() && address<2:0> == '000' then
        bits(64) data;
        if BigEndian() then
            data<63:32> = R[t];
            data<31:0> = R[t2];
        else
            data<31:0> = R[t];
            data<63:32> = R[t2];
        MemA[Address,8] = data;
    else
        MemA[address,4] = R[t];
        MemA[address+4,4] = R[t2];
    if wback then R[n] = offset_addr;

```

## Exceptions

Data Abort.

### A8.8.212 STREX

Store Register Exclusive calculates an address from a base register value and an immediate offset, and stores a word from a register to memory if the executing processor has exclusive access to the memory addressed.

For more information about support for shared memory see [Synchronization and semaphores on page A3-114](#). For information about memory accesses see [Memory accesses on page A8-294](#).

#### Encoding T1 ARMv6T2, ARMv7

STREX<c> <Rd>, <Rt>, [<Rn>{, #<imm>}]

15	14	13	12	11	10	9	8	7	6	5	4	3	2	1	0	15	14	13	12	11	10	9	8	7	6	5	4	3	2	1	0
1	1	1	0	1	0	0	0	0	1	0	0	Rn				Rt				Rd				imm8							

d = UInt(Rd); t = UInt(Rt); n = UInt(Rn); imm32 = ZeroExtend(imm8:'00', 32);  
if d IN {13,15} || t IN {13,15} || n == 15 then UNPREDICTABLE;  
if d == n || d == t then UNPREDICTABLE;

#### Encoding A1 ARMv6\*, ARMv7

STREX<c> <Rd>, <Rt>, [<Rn>]

31	30	29	28	27	26	25	24	23	22	21	20	19	18	17	16	15	14	13	12	11	10	9	8	7	6	5	4	3	2	1	0
cond		0	0	0	1	1	0	0	0	Rn				Rd				(1)	(1)	(1)	(1)	1	0	0	1	Rt					

d = UInt(Rd); t = UInt(Rt); n = UInt(Rn); imm32 = Zeros(32); // Zero offset  
if d == 15 || t == 15 || n == 15 then UNPREDICTABLE;  
if d == n || d == t then UNPREDICTABLE;

## Assembler syntax

STREX{<c>}{<q>} <Rd>, <Rt>, [<Rn> {, #<imm>}]

where:

<c>, <q> See *Standard assembler syntax fields* on page A8-287.

<Rd> The destination register for the returned status value. The value returned is:  
0 if the operation updates memory  
1 if the operation fails to update memory.

<Rt> The source register.

<Rn> The base register. The SP can be used.

<imm> The immediate offset added to the value of <Rn> to form the address. Values are multiples of 4 in the range 0-1020 for encoding T1, and 0 for encoding A1. <imm> can be omitted, meaning an offset of 0.

## Operation

```
if ConditionPassed() then
    EncodingSpecificOperations(); NullCheckIfThumbEE(n);
    address = R[n] + imm32;
    if ExclusiveMonitorsPass(address,4) then
        MemA[address,4] = R[t];
        R[d] = 0;
    else
        R[d] = 1;
```

## Exceptions

Data Abort.

## Aborts and alignment

If a synchronous Data Abort exception is generated by the execution of this instruction:

- memory is not updated
- <Rd> is not updated.

If [SCTLR.A](#) and [SCTLR.U](#) are both 0, a non word-aligned memory address causes UNPREDICTABLE behavior. Otherwise, a non word-aligned memory address causes an Alignment fault Data Abort exception to be generated, subject to the following rules:

- If `ExclusiveMonitorsPass()` returns TRUE, the exception is generated.
- Otherwise, it is IMPLEMENTATION DEFINED whether the exception is generated.

If `ExclusiveMonitorsPass()` returns FALSE and the memory address, if accessed, would generate a synchronous Data Abort exception, it is IMPLEMENTATION DEFINED whether the exception is generated.

### A8.8.213 STREXB

Store Register Exclusive Byte derives an address from a base register value, and stores a byte from a register to memory if the executing processor has exclusive access to the memory addressed.

For more information about support for shared memory see [Synchronization and semaphores on page A3-114](#). For information about memory accesses see [Memory accesses on page A8-294](#).

#### Encoding T1 ARMv7

STREXB<c> <Rd>, <Rt>, [<Rn>]

15	14	13	12	11	10	9	8	7	6	5	4	3	2	1	0	15	14	13	12	11	10	9	8	7	6	5	4	3	2	1	0
1	1	1	0	1	0	0	0	0	1	1	0	0	Rn			Rt			(1)	(1)	(1)	(1)	0	1	0	0	Rd				

d = UInt(Rd); t = UInt(Rt); n = UInt(Rn);  
if d IN {13,15} || t IN {13,15} || n == 15 then UNPREDICTABLE;  
if d == n || d == t then UNPREDICTABLE;

#### Encoding A1 ARMv6K, ARMv7

STREXB<c> <Rd>, <Rt>, [<Rn>]

31	30	29	28	27	26	25	24	23	22	21	20	19	18	17	16	15	14	13	12	11	10	9	8	7	6	5	4	3	2	1	0
cond		0	0	0	1	1	1	0	0	Rn			Rd			(1)	(1)	(1)	(1)	1	0	0	1	Rt							

d = UInt(Rd); t = UInt(Rt); n = UInt(Rn);  
if d == 15 || t == 15 || n == 15 then UNPREDICTABLE;  
if d == n || d == t then UNPREDICTABLE;



## Assembler syntax

STREXB{<c>}{<q>} <Rd>, <Rt>, [<Rn>]

where:

<c>, <q> See *Standard assembler syntax fields* on page A8-287.

<Rd> The destination register for the returned status value. The value returned is:  
0 if the operation updates memory  
1 if the operation fails to update memory.

<Rt> The source register.

<Rn> The base register. The SP can be used.

## Operation

```
if ConditionPassed() then
    EncodingSpecificOperations(); NullCheckIfThumbEE(n);
    address = R[n];
    if ExclusiveMonitorsPass(address,1) then
        MemA[address,1] = R[t]<7:0>;
        R[d] = 0;
    else
        R[d] = 1;
```

## Exceptions

Data Abort.

## Aborts

If a synchronous Data Abort exception is generated by the execution of this instruction:

- memory is not updated
- <Rd> is not updated.

If ExclusiveMonitorsPass() returns FALSE and the memory address, if accessed, would generate a synchronous Data Abort exception, it is IMPLEMENTATION DEFINED whether the exception is generated.

### A8.8.214 STREXD

Store Register Exclusive Doubleword derives an address from a base register value, and stores a 64-bit doubleword from two registers to memory if the executing processor has exclusive access to the memory addressed.

For more information about support for shared memory see [Synchronization and semaphores on page A3-114](#). For information about memory accesses see [Memory accesses on page A8-294](#).

#### Encoding T1 ARMv7

STREXD<c> <Rd>, <Rt>, <Rt2>, [<Rn>]

15	14	13	12	11	10	9	8	7	6	5	4	3	2	1	0	15	14	13	12	11	10	9	8	7	6	5	4	3	2	1	0
1	1	1	0	1	0	0	0	1	1	0	0	Rn				Rt		Rt2		0	1	1	1	Rd							

d = UInt(Rd); t = UInt(Rt); t2 = UInt(Rt2); n = UInt(Rn);  
if d IN {13,15} || t IN {13,15} || t2 IN {13,15} || n == 15 then UNPREDICTABLE;  
if d == n || d == t || d == t2 then UNPREDICTABLE;

#### Encoding A1 ARMv6K, ARMv7

STREXD<c> <Rd>, <Rt>, <Rt2>, [<Rn>]

31	30	29	28	27	26	25	24	23	22	21	20	19	18	17	16	15	14	13	12	11	10	9	8	7	6	5	4	3	2	1	0
cond				0	0	0	1	1	0	1	0	Rn				Rd				(1)	(1)	(1)	(1)	1	0	0	1	Rt			

d = UInt(Rd); t = UInt(Rt); t2 = t+1; n = UInt(Rn);  
if d == 15 || Rt<0> == '1' || Rt == '1110' || n == 15 then UNPREDICTABLE;  
if d == n || d == t || d == t2 then UNPREDICTABLE;

## Assembler syntax

STREXD{<c>}{<q>} <Rd>, <Rt>, <Rt2>, [<Rn>]

where:

<c>, <q> See [Standard assembler syntax fields on page A8-287](#).

<Rd> The destination register for the returned status value. The value returned is:  
0 if the operation updates memory  
1 if the operation fails to update memory.  
<Rd> must not be the same as <Rn>, <Rt>, or <Rt2>.

<Rt> The first source register. For an ARM instruction, <Rt> must be even-numbered and not R14.

<Rt2> The second source register. For an ARM instruction, <Rt2> must be <R(t+1)>.

<Rn> The base register. The SP can be used.

## Operation

```
if ConditionPassed() then
    EncodingSpecificOperations(); NullCheckIfThumbEE(n);
    address = R[n];
    // Create doubleword to store such that R[t] will be stored at address and R[t2] at address+4.
    value = if BigEndian() then R[t]:R[t2] else R[t2]:R[t];
    if ExclusiveMonitorsPass(address,8) then
        MemA[address,8] = value; R[d] = 0;
    else
        R[d] = 1;
```

## Exceptions

Data Abort.

## Aborts and alignment

If a synchronous Data Abort exception is generated by the execution of this instruction:

- memory is not updated
- <Rd> is not updated.

If [SCTLR.A](#) and [SCTLR.U](#) are both 0, a non doubleword-aligned memory address causes UNPREDICTABLE behavior. Otherwise, a non doubleword-aligned memory address causes an Alignment fault Data Abort exception to be generated, subject to the following rules:

- If [ExclusiveMonitorsPass\(\)](#) returns TRUE, the exception is generated.
- Otherwise, it is IMPLEMENTATION DEFINED whether the exception is generated.

If [ExclusiveMonitorsPass\(\)](#) returns FALSE and the memory address, if accessed, would generate a synchronous Data Abort exception, it is IMPLEMENTATION DEFINED whether the exception is generated.

### A8.8.215 STREXH

Store Register Exclusive Halfword derives an address from a base register value, and stores a halfword from a register to memory if the executing processor has exclusive access to the memory addressed.

For more information about support for shared memory see [Synchronization and semaphores on page A3-114](#). For information about memory accesses see [Memory accesses on page A8-294](#).

#### Encoding T1 ARMv7

STREXH<c> <Rd>, <Rt>, [<Rn>]

15	14	13	12	11	10	9	8	7	6	5	4	3	2	1	0	15	14	13	12	11	10	9	8	7	6	5	4	3	2	1	0
1	1	1	0	1	0	0	0	0	1	1	0	0	Rn			Rt			(1)	(1)	(1)	(1)	0	1	0	1	Rd				

d = UInt(Rd); t = UInt(Rt); n = UInt(Rn);  
if d IN {13,15} || t IN {13,15} || n == 15 then UNPREDICTABLE;  
if d == n || d == t then UNPREDICTABLE;

#### Encoding A1 ARMv6K, ARMv7

STREXH<c> <Rd>, <Rt>, [<Rn>]

31	30	29	28	27	26	25	24	23	22	21	20	19	18	17	16	15	14	13	12	11	10	9	8	7	6	5	4	3	2	1	0
cond		0	0	0	1	1	1	1	0	Rn			Rd			(1)	(1)	(1)	(1)	1	0	0	1	Rt							

d = UInt(Rd); t = UInt(Rt); n = UInt(Rn);  
if d == 15 || t == 15 || n == 15 then UNPREDICTABLE;  
if d == n || d == t then UNPREDICTABLE;

## Assembler syntax

STREXH{<c>}{<q>} <Rd>, <Rt>, [<Rn>]

where:

- <c>, <q> See *Standard assembler syntax fields* on page A8-287.
- <Rd> The destination register for the returned status value. The value returned is:
  - 0 if the operation updates memory
  - 1 if the operation fails to update memory.
- <Rt> The source register.
- <Rn> The base register. The SP can be used.

## Operation

```

if ConditionPassed() then
    EncodingSpecificOperations(); NullCheckIfThumbEE(n);
    address = R[n];
    if ExclusiveMonitorsPass(address,2) then
        MemA[address,2] = R[t]<15:0>;
        R[d] = 0;
    else
        R[d] = 1;

```

## Exceptions

Data Abort.

## Aborts and alignment

If a synchronous Data Abort exception is generated by the execution of this instruction:

- memory is not updated
- <Rd> is not updated.

If **SCTLR.A** and **SCTLR.U** are both 0, a non halfword-aligned memory address causes UNPREDICTABLE behavior. Otherwise, a non halfword-aligned memory address causes an Alignment fault Data Abort exception to be generated, subject to the following rules:

- If **ExclusiveMonitorsPass()** returns TRUE, the exception is generated.
- Otherwise, it is IMPLEMENTATION DEFINED whether the exception is generated.

If **ExclusiveMonitorsPass()** returns FALSE and the memory address, if accessed, would generate a synchronous Data Abort exception, it is IMPLEMENTATION DEFINED whether the exception is generated.

### A8.8.216 STRH (immediate, Thumb)

Store Register Halfword (immediate) calculates an address from a base register value and an immediate offset, and stores a halfword from a register to memory. It can use offset, post-indexed, or pre-indexed addressing. For information about memory accesses see *Memory accesses* on page A8-294.

**Encoding T1** ARMv4T, ARMv5T\*, ARMv6\*, ARMv7  
STRH<c> <Rt>, [<Rn>{, #<imm>}]

15	14	13	12	11	10	9	8	7	6	5	4	3	2	1	0
1	0	0	0	0	imm5					Rn			Rt		

t = UInt(Rt); n = UInt(Rn); imm32 = ZeroExtend(imm5:'0', 32);  
index = TRUE; add = TRUE; wback = FALSE;

**Encoding T2** ARMv6T2, ARMv7  
STRH<c>.W <Rt>, [<Rn>{, #<imm12>}]

15	14	13	12	11	10	9	8	7	6	5	4	3	2	1	0	15	14	13	12	11	10	9	8	7	6	5	4	3	2	1	0
1	1	1	1	1	0	0	0	1	0	1	0	Rn			Rt		imm12														

if Rn == '1111' then UNDEFINED;  
t = UInt(Rt); n = UInt(Rn); imm32 = ZeroExtend(imm12, 32);  
index = TRUE; add = TRUE; wback = FALSE;  
if t IN {13,15} then UNPREDICTABLE;

**Encoding T3** ARMv6T2, ARMv7  
STRH<c> <Rt>, [<Rn>, #-<imm8>]  
STRH<c> <Rt>, [<Rn>], #+/-<imm8>  
STRH<c> <Rt>, [<Rn>, #+/-<imm8>!]

15	14	13	12	11	10	9	8	7	6	5	4	3	2	1	0	15	14	13	12	11	10	9	8	7	6	5	4	3	2	1	0
1	1	1	1	1	0	0	0	0	0	1	0	Rn			Rt		1	P	U	W	imm8										

if P == '1' && U == '1' && W == '0' then SEE STRHT;  
if Rn == '1111' || (P == '0' && W == '0') then UNDEFINED;  
t = UInt(Rt); n = UInt(Rn); imm32 = ZeroExtend(imm8, 32);  
index = (P == '1'); add = (U == '1'); wback = (W == '1');  
if t IN {13,15} || (wback && n == t) then UNPREDICTABLE;

## Assembler syntax

STRH{<c>}{<q>} <Rt>, [<Rn> {, #+/-<imm>}]	Offset: index==TRUE, wback==FALSE
STRH{<c>}{<q>} <Rt>, [<Rn>, #+/-<imm>]!	Pre-indexed: index==TRUE, wback==TRUE
STRH{<c>}{<q>} <Rt>, [<Rn>], #+/-<imm>	Post-indexed: index==FALSE, wback==TRUE

where:

<c>, <q> See [Standard assembler syntax fields on page A8-287](#).

<Rt> The source register.

<Rn> The base register. The SP can be used.

+/- Is + or omitted if the immediate offset is to be added to the base register value (add == TRUE), or – if it is to be subtracted (add == FALSE). #0 and #-0 generate different instructions.

<imm> The immediate offset used for forming the address. Values are:

<b>Encoding T1</b>	multiples of 2 in the range 0-62
<b>Encoding T2</b>	any value in the range 0-4095
<b>Encoding T3</b>	any value in the range 0-255.

For the offset addressing syntax, <imm> can be omitted, meaning an offset of 0.

The pre-UAL syntax STR<c>H is equivalent to STRH<c>.

## Operation

```

if ConditionPassed() then
    EncodingSpecificOperations(); NullCheckIfThumbEE(n);
    offset_addr = if add then (R[n] + imm32) else (R[n] - imm32);
    address = if index then offset_addr else R[n];
    if UnalignedSupport() || address<0> == '0' then
        MemU[address,2] = R[t]<15:0>;
    else // Can only occur before ARMv7
        MemU[address,2] = bits(16) UNKNOWN;
    if wback then R[n] = offset_addr;

```

## Exceptions

Data Abort.

### A8.8.217 STRH (immediate, ARM)

Store Register Halfword (immediate) calculates an address from a base register value and an immediate offset, and stores a halfword from a register to memory. It can use offset, post-indexed, or pre-indexed addressing. For information about memory accesses see [Memory accesses on page A8-294](#).

**Encoding A1** ARMv4\*, ARMv5T\*, ARMv6\*, ARMv7

STRH<c> <Rt>, [<Rn>{, #+/-<imm8>}]

STRH<c> <Rt>, [<Rn>], #+/-<imm8>

STRH<c> <Rt>, [<Rn>, #+/-<imm8>]!

31	30	29	28	27	26	25	24	23	22	21	20	19	18	17	16	15	14	13	12	11	10	9	8	7	6	5	4	3	2	1	0
cond				0	0	0	P	U	1	W	0	Rn				Rt				imm4H				1	0	1	1	imm4L			

```

if P == '0' && W == '1' then SEE STRHT;
t = UInt(Rt); n = UInt(Rn); imm32 = ZeroExtend(imm4H:imm4L, 32);
index = (P == '1'); add = (U == '1'); wback = (P == '0') || (W == '1');
if t == 15 then UNPREDICTABLE;
if wback && (n == 15 || n == t) then UNPREDICTABLE;

```



## Assembler syntax

STRH{<c>}{<q>} <Rt>, [<Rn> {, #+/-<imm>}]	Offset: index==TRUE, wback==FALSE
STRH{<c>}{<q>} <Rt>, [<Rn>, #+/-<imm>]!	Pre-indexed: index==TRUE, wback==TRUE
STRH{<c>}{<q>} <Rt>, [<Rn>], #+/-<imm>	Post-indexed: index==FALSE, wback==TRUE

where:

<c>, <q>	See <a href="#">Standard assembler syntax fields on page A8-287</a> .
<Rt>	The source register.
<Rn>	The base register. The SP can be used. For offset addressing only, the PC can be used. However, ARM deprecates use of the PC.
+/-	Is + or omitted if the immediate offset is to be added to the base register value (add == TRUE), or – if it is to be subtracted (add == FALSE). #0 and #-0 generate different instructions.
<imm>	The immediate offset used for forming the address. Values are 0-255. For the offset addressing syntax, <imm> can be omitted, meaning an offset of 0.

The pre-UAL syntax STR<c>H is equivalent to STRH<c>.

## Operation

```

if ConditionPassed() then
    EncodingSpecificOperations();
    offset_addr = if add then (R[n] + imm32) else (R[n] - imm32);
    address = if index then offset_addr else R[n];
    if UnalignedSupport() || address<0> == '0' then
        MemU[address,2] = R[t]<15:0>;
    else // Can only occur before ARMv7
        MemU[address,2] = bits(16) UNKNOWN;
    if wback then R[n] = offset_addr;

```

## Exceptions

Data Abort.

### A8.8.218 STRH (register)

Store Register Halfword (register) calculates an address from a base register value and an offset register value, and stores a halfword from a register to memory. The offset register value can be shifted left by 0, 1, 2, or 3 bits. For information about memory accesses see *Memory accesses* on page A8-294.

#### Encoding T1 ARMv4T, ARMv5T\*, ARMv6\*, ARMv7

STRH<c> <Rt>, [<Rn>, <Rm>]

15	14	13	12	11	10	9	8	7	6	5	4	3	2	1	0
0	1	0	1	0	0	1	Rm		Rn		Rt				

```
if CurrentInstrSet() == InstrSet_ThumbEE then SEE "Modified operation in ThumbEE";
t = UInt(Rt); n = UInt(Rn); m = UInt(Rm);
index = TRUE; add = TRUE; wback = FALSE;
(shift_t, shift_n) = (SRTYPE_LSL, 0);
```

#### Encoding T2 ARMv6T2, ARMv7

STRH<c>.W <Rt>, [<Rn>, <Rm>{, LSL #<imm2>}]

15	14	13	12	11	10	9	8	7	6	5	4	3	2	1	0	15	14	13	12	11	10	9	8	7	6	5	4	3	2	1	0
1	1	1	1	1	0	0	0	0	0	1	0	Rn				Rt	0	0	0	0	0	0	imm2	Rm							

```
if Rn == '1111' then UNDEFINED;
t = UInt(Rt); n = UInt(Rn); m = UInt(Rm);
index = TRUE; add = TRUE; wback = FALSE;
(shift_t, shift_n) = (SRTYPE_LSL, UInt(imm2));
if t IN {13,15} || m IN {13,15} then UNPREDICTABLE;
```

#### Encoding A1 ARMv4\*, ARMv5T\*, ARMv6\*, ARMv7

STRH<c> <Rt>, [<Rn>, +/-<Rm>]{!}

STRH<c> <Rt>, [<Rn>], +/-<Rm>

31	30	29	28	27	26	25	24	23	22	21	20	19	18	17	16	15	14	13	12	11	10	9	8	7	6	5	4	3	2	1	0
cond		0	0	0	P	U	0	W	0	Rn		Rt	(0)	(0)	(0)	(0)	1	0	1	1	Rm										

```
if P == '0' && W == '1' then SEE STRHT;
t = UInt(Rt); n = UInt(Rn); m = UInt(Rm);
index = (P == '1'); add = (U == '1'); wback = (P == '0') || (W == '1');
(shift_t, shift_n) = (SRTYPE_LSL, 0);
if t == 15 || m == 15 then UNPREDICTABLE;
if wback && (n == 15 || n == t) then UNPREDICTABLE;
if ArchVersion() < 6 && wback && m == n then UNPREDICTABLE;
```

#### Modified operation in ThumbEE

See *STRH (register)* on page A9-1122

## Assembler syntax

STRH{<c>}{<q>} <Rt>, [<Rn>, +/-<Rm>{, LSL #<imm>}] Offset: index==TRUE, wback==FALSE  
STRH{<c>}{<q>} <Rt>, [<Rn>, +/-<Rm>]! Pre-indexed: index==TRUE, wback==TRUE  
STRH{<c>}{<q>} <Rt>, [<Rn>], +/-<Rm> Post-indexed: index==FALSE, wback==TRUE

where:

<c>, <q> See [Standard assembler syntax fields on page A8-287](#).  
<Rt> The source register.  
<Rn> The base register. The SP can be used. In the ARM instruction set, for offset addressing only, the PC can be used. However, ARM deprecates use of the PC.  
+/- Is + or omitted if the optionally shifted value of <Rm> is to be added to the base register value (add == TRUE), or – if it is to be subtracted (permitted in ARM instructions only, add == FALSE).  
<Rm> Contains the offset that is optionally left shifted and added to the value of <Rn> to form the address.  
<imm> If present, the size of the left shift to apply to the value from <Rm>, in the range 1-3. Only encoding T2 is permitted, and <imm> is encoded in imm2.  
If absent, no shift is specified and all encodings are permitted. In encoding T2, imm2 is encoded as 0b00.

The pre-UAL syntax STR<c>H is equivalent to STRH<c>.

## Operation

```
if ConditionPassed() then
    EncodingSpecificOperations(); NullCheckIfThumbEE(n);
    offset = Shift(R[m], shift_t, shift_n, APSR.C);
    offset_addr = if add then (R[n] + offset) else (R[n] - offset);
    address = if index then offset_addr else R[n];
    if UnalignedSupport() || address<0> == '0' then
        MemU[address,2] = R[t]<15:0>;
    else // Can only occur before ARMv7
        MemU[address,2] = bits(16) UNKNOWN;
    if wback then R[n] = offset_addr;
```

## Exceptions

Data Abort.

### A8.8.219 STRHT

Store Register Halfword Unprivileged stores a halfword from a register to memory. For information about memory accesses see [Memory accesses on page A8-294](#).

The memory access is restricted as if the processor were running in User mode. This makes no difference if the processor is actually running in User mode.

STRHT is UNPREDICTABLE in Hyp mode.

The Thumb instruction uses an offset addressing mode, that calculates the address used for the memory access from a base register value and an immediate offset, and leaves the base register unchanged.

The ARM instruction uses a post-indexed addressing mode, that uses a base register value as the address for the memory access, and calculates a new address from a base register value and an offset and writes it back to the base register. The offset can be an immediate value or a register value.

#### Encoding T1 ARMv6T2, ARMv7

STRHT<c> <Rt>, [<Rn>, #<imm8>]

15	14	13	12	11	10	9	8	7	6	5	4	3	2	1	0	15	14	13	12	11	10	9	8	7	6	5	4	3	2	1	0
1	1	1	1	1	0	0	0	0	0	1	0	Rn				Rt		1	1	1	0	imm8									

```
if Rn == '1111' then UNDEFINED;
t = UInt(Rt); n = UInt(Rn); postindex = FALSE; add = TRUE;
register_form = FALSE; imm32 = ZeroExtend(imm8, 32);
if t IN {13,15} then UNPREDICTABLE;
```

#### Encoding A1 ARMv6T2, ARMv7

STRHT<c> <Rt>, [<Rn>] {, #+/-<imm8>}

31	30	29	28	27	26	25	24	23	22	21	20	19	18	17	16	15	14	13	12	11	10	9	8	7	6	5	4	3	2	1	0
cond		0	0	0	0	U	1	1	0	Rn				Rt		imm4H		1	0	1	1	imm4L									

```
t = UInt(Rt); n = UInt(Rn); postindex = TRUE; add = (U == '1');
register_form = FALSE; imm32 = ZeroExtend(imm4H:imm4L, 32);
if t == 15 || n == 15 || n == t then UNPREDICTABLE;
```

#### Encoding A2 ARMv6T2, ARMv7

STRHT<c> <Rt>, [<Rn>], +/-<Rm>

31	30	29	28	27	26	25	24	23	22	21	20	19	18	17	16	15	14	13	12	11	10	9	8	7	6	5	4	3	2	1	0
cond		0	0	0	0	U	0	1	0	Rn				Rt		(0)	(0)	(0)	(0)	1	0	1	1	Rm							

```
t = UInt(Rt); n = UInt(Rn); m = UInt(Rm); postindex = TRUE; add = (U == '1');
register_form = TRUE;
if t == 15 || n == 15 || n == t || m == 15 then UNPREDICTABLE;
```

## Assembler syntax

STRHT{<c>}{<q>} <Rt>, [<Rn> {, #<imm>}]	Offset: Thumb only
STRHT{<c>}{<q>} <Rt>, [<Rn>] {, #+/-<imm>}	Post-indexed: ARM only
STRHT{<c>}{<q>} <Rt>, [<Rn>], +/-<Rm>	Post-indexed: ARM only

where:

<c>, <q>	See <i>Standard assembler syntax fields</i> on page A8-287.
<Rt>	The source register.
<Rn>	The base register. The SP can be used.
+/-	Is + or omitted if <imm> or the optionally shifted value of <Rm> is to be added to the base register value (add == TRUE), or – if it is to be subtracted (permitted in ARM instructions only, add == FALSE).
<imm>	The immediate offset applied to the value of <Rn>. Any value in the range 0-255 is permitted. <imm> can be omitted, meaning an offset of 0.
<Rm>	Contains the offset that is applied to the value of <Rn> to form the address.

## Operation

```

if ConditionPassed() then
    if CurrentModeIsHyp() then UNPREDICTABLE;           // Hyp mode
    EncodingSpecificOperations(); NullCheckIfThumbEE(n);
    offset = if register_form then R[m] else imm32;
    offset_addr = if add then (R[n] + offset) else (R[n] - offset);
    address = if postindex then R[n] else offset_addr;
    if UnalignedSupport() || address<0> == '0' then
        MemU_unpriv[address,2] = R[t]<15:0>;
    else // Can only occur before ARMv7
        MemU_unpriv[address,2] = bits(16) UNKNOWN;
    if postindex then R[n] = offset_addr;

```

## Exceptions

Data Abort.

## A8.8.220 STRT

Store Register Unprivileged stores a word from a register to memory. For information about memory accesses see [Memory accesses on page A8-294](#).

The memory access is restricted as if the processor were running in User mode. This makes no difference if the processor is actually running in User mode.

STRT is UNPREDICTABLE in Hyp mode.

The Thumb instruction uses an offset addressing mode, that calculates the address used for the memory access from a base register value and an immediate offset, and leaves the base register unchanged.

The ARM instruction uses a post-indexed addressing mode, that uses a base register value as the address for the memory access, and calculates a new address from a base register value and an offset and writes it back to the base register. The offset can be an immediate value or an optionally-shifted register value.

### Encoding T1 ARMv6T2, ARMv7

STRT<c> <Rt>, [<Rn>, #<imm8>]

15	14	13	12	11	10	9	8	7	6	5	4	3	2	1	0	15	14	13	12	11	10	9	8	7	6	5	4	3	2	1	0
1	1	1	1	1	0	0	0	0	1	0	0	Rn				Rt		1	1	1	0	imm8									

```
if Rn == '1111' then UNDEFINED;
t = UInt(Rt); n = UInt(Rn); postindex = FALSE; add = TRUE;
register_form = FALSE; imm32 = ZeroExtend(imm8, 32);
if t IN {13,15} then UNPREDICTABLE;
```

### Encoding A1 ARMv4\*, ARMv5T\*, ARMv6\*, ARMv7

STRT<c> <Rt>, [<Rn>] {, +/-<imm12>}

31	30	29	28	27	26	25	24	23	22	21	20	19	18	17	16	15	14	13	12	11	10	9	8	7	6	5	4	3	2	1	0
cond		0	1	0	0	U	0	1	0	Rn				Rt		imm12															

```
t = UInt(Rt); n = UInt(Rn); postindex = TRUE; add = (U == '1');
register_form = FALSE; imm32 = ZeroExtend(imm12, 32);
if n == 15 || n == t then UNPREDICTABLE;
```

### Encoding A2 ARMv4\*, ARMv5T\*, ARMv6\*, ARMv7

STRT<c> <Rt>, [<Rn>], +/-<Rm>{, <shift>}

31	30	29	28	27	26	25	24	23	22	21	20	19	18	17	16	15	14	13	12	11	10	9	8	7	6	5	4	3	2	1	0
cond		0	1	1	0	U	0	1	0	Rn				Rt		imm5			type	0	Rm										

```
t = UInt(Rt); n = UInt(Rn); m = UInt(Rm); postindex = TRUE; add = (U == '1');
register_form = TRUE; (shift_t, shift_n) = DecodeImmShift(type, imm5);
if n == 15 || n == t || m == 15 then UNPREDICTABLE;
if ArchVersion() < 6 && m == n then UNPREDICTABLE;
```

## Assembler syntax

STRT{<c>}{<q>} <Rt>, [<Rn> {, #<imm>}]	Offset: Thumb only
STRT{<c>}{<q>} <Rt>, [<Rn>] {, #+/-<imm>}	Post-indexed: ARM only
STRT{<c>}{<q>} <Rt>, [<Rn>], +/-<Rm> {, <shift>}	Post-indexed: ARM only

where:

<c>, <q>	See <a href="#">Standard assembler syntax fields on page A8-287</a> .
<Rt>	The source register. In the ARM instruction set, the PC can be used. However, ARM deprecates use of the PC.
<Rn>	The base register. The SP can be used.
+/-	Is + or omitted if <imm> or the optionally shifted value of <Rm> is to be added to the base register value (add == TRUE), or – if it is to be subtracted (permitted in ARM instructions only, add == FALSE).
<imm>	The immediate offset applied to the value of <Rn>. Values are 0-255 for encoding T1, and 0-4095 for encoding A1. <imm> can be omitted, meaning an offset of 0.
<Rm>	Contains the offset that is optionally shifted and added to the value of <Rn> to form the address.
<shift>	The shift to apply to the value read from <Rm>. If omitted, no shift is applied. <a href="#">Shifts applied to a register on page A8-291</a> describes the shifts and how they are encoded.

The pre-UAL syntax STR<c>T is equivalent to STRT<c>.

## Operation

```

if ConditionPassed() then
    if CurrentModeIsHyp() then UNPREDICTABLE;           // Hyp mode
    EncodingSpecificOperations();  NullCheckIfThumbEE(n);
    offset = if register_form then Shift(R[m], shift_t, shift_n, APSR.C) else imm32;
    offset_addr = if add then (R[n] + offset) else (R[n] - offset);
    address = if postindex then R[n] else offset_addr;
    if t == 15 then // Only possible for encodings A1 and A2
        data = PCStoreValue();
    else
        data = R[t];
    if UnalignedSupport() || address<1:0> == '00' || CurrentInstrSet() == InstrSet_ARM then
        MemU_unpriv[address,4] = data;
    else // Can only occur before ARMv7
        MemU_unpriv[address,4] = bits(32) UNKNOWN;
    if postindex then R[n] = offset_addr;

```

## Exceptions

Data Abort.

### A8.8.221 SUB (immediate, Thumb)

This instruction subtracts an immediate value from a register value, and writes the result to the destination register. It can optionally update the condition flags based on the result.

**Encoding T1** ARMv4T, ARMv5T\*, ARMv6\*, ARMv7  
SUBS <Rd>, <Rn>, #<imm3> Outside IT block.  
SUB<c> <Rd>, <Rn>, #<imm3> Inside IT block.

15	14	13	12	11	10	9	8	7	6	5	4	3	2	1	0
0	0	0	1	1	1	1	imm3			Rn			Rd		

d = UInt(Rd); n = UInt(Rn); setflags = !InITBlock(); imm32 = ZeroExtend(imm3, 32);

**Encoding T2** ARMv4T, ARMv5T\*, ARMv6\*, ARMv7  
SUBS <Rdn>, #<imm8> Outside IT block.  
SUB<c> <Rdn>, #<imm8> Inside IT block.

15	14	13	12	11	10	9	8	7	6	5	4	3	2	1	0
0	0	1	1	1	Rdn			imm8							

d = UInt(Rdn); n = UInt(Rdn); setflags = !InITBlock(); imm32 = ZeroExtend(imm8, 32);

**Encoding T3** ARMv6T2, ARMv7  
SUB{S}<c>.W <Rd>, <Rn>, #<const>

15	14	13	12	11	10	9	8	7	6	5	4	3	2	1	0	15	14	13	12	11	10	9	8	7	6	5	4	3	2	1	0
1	1	1	1	0	i	0	1	1	0	1	S	Rn			0	imm3			Rd			imm8									

if Rd == '1111' && S == '1' then SEE CMP (immediate);  
if Rn == '1101' then SEE SUB (SP minus immediate);  
d = UInt(Rd); n = UInt(Rn); setflags = (S == '1'); imm32 = ThumbExpandImm(i:imm3:imm8);  
if d == 13 || (d == 15 && S == '0') || n == 15 then UNPREDICTABLE;

**Encoding T4** ARMv6T2, ARMv7  
SUBW<c> <Rd>, <Rn>, #<imm12>

15	14	13	12	11	10	9	8	7	6	5	4	3	2	1	0	15	14	13	12	11	10	9	8	7	6	5	4	3	2	1	0
1	1	1	1	0	i	1	0	1	0	1	0	Rn			0	imm3			Rd			imm8									

if Rn == '1111' then SEE ADR;  
if Rn == '1101' then SEE SUB (SP minus immediate);  
d = UInt(Rd); n = UInt(Rn); setflags = FALSE; imm32 = ZeroExtend(i:imm3:imm8, 32);  
if d IN {13,15} then UNPREDICTABLE;



## Assembler syntax

SUB{S}{<c>}{<q>} {<Rd>}, {<Rn>, #<const>} All encodings permitted  
SUBW{<c>}{<q>} {<Rd>}, {<Rn>, #<const>} Only encoding T4 permitted

where:

- S If S is present, the instruction updates the flags. Otherwise, the flags are not updated.
- <c>, <q> See [Standard assembler syntax fields on page A8-287](#).
- <Rd> The destination register. If S is specified and <Rd> is the PC, see [SUBS PC, LR \(Thumb\) on page B9-2008](#) or [SUBS PC, LR and related instructions \(ARM\) on page B9-2010](#).
- <Rn> The first operand register. If the SP is specified for <Rn>, see [SUB \(SP minus immediate\) on page A8-716](#). If the PC is specified for <Rn>, see [ADR on page A8-322](#).
- <const> The immediate value to be subtracted from the value obtained from <Rn>. The range of values is 0-7 for encoding T1, 0-255 for encoding T2 and 0-4095 for encoding T4. See [Modified immediate constants in Thumb instructions on page A6-232](#) for the range of values for encoding T3.  
When multiple encodings of the same length are available for an instruction, encoding T3 is preferred to encoding T4. If encoding T4 is required, use the SUBW syntax. Encoding T1 is preferred to encoding T2 if <Rd> is specified and encoding T2 is preferred to encoding T1 if <Rd> is omitted.

The pre-UAL syntax SUB<c>S is equivalent to SUBS<c>.

## Operation

```
if ConditionPassed() then
    EncodingSpecificOperations();
    (result, carry, overflow) = AddWithCarry(R[n], NOT(imm32), '1');
    R[d] = result;
    if setflags then
        APSR.N = result<31>;
        APSR.Z = IsZeroBit(result);
        APSR.C = carry;
        APSR.V = overflow;
```

## Exceptions

None.

### A8.8.222 SUB (immediate, ARM)

This instruction subtracts an immediate value from a register value, and writes the result to the destination register. It can optionally update the condition flags based on the result.

**Encoding A1** ARMv4\*, ARMv5T\*, ARMv6\*, ARMv7  
SUB{S}<c> <Rd>, <Rn>, #<const>

31	30	29	28	27	26	25	24	23	22	21	20	19	18	17	16	15	14	13	12	11	10	9	8	7	6	5	4	3	2	1	0
cond			0	0	1	0	0	1	0	S	Rn				Rd				imm12												

```

if Rn == '1111' && S == '0' then SEE ADR;
if Rn == '1101' then SEE SUB (SP minus immediate);
if Rd == '1111' && S == '1' then SEE SUBS PC, LR and related instructions;
d = UInt(Rd); n = UInt(Rn); setflags = (S == '1'); imm32 = ARMEExpandImm(imm12);

```

## Assembler syntax

SUB{S}{<c>}{<q>} {<Rd>}, <Rn>, #<const>

where:

- S If S is present, the instruction updates the flags. Otherwise, the flags are not updated.
- <c>, <q> See *Standard assembler syntax fields* on page A8-287.
- <Rd> The destination register. If S is specified and <Rd> is the PC, see *SUBS PC, LR (Thumb)* on page B9-2008 or *SUBS PC, LR and related instructions (ARM)* on page B9-2010.  
If S is not specified and <Rd> is the PC, the instruction is a branch to the address calculated by the operation. This is an interworking branch, see *Pseudocode details of operations on ARM core registers* on page A2-47.

———— **Note** ————

Before ARMv7, this was a simple branch.

- <Rn> The first operand register. If the SP is specified for <Rn>, see *SUB (SP minus immediate)* on page A8-716. If the PC is specified for <Rn>, see *ADR* on page A8-322.
- <const> The immediate value to be subtracted from the value obtained from <Rn>. See *Modified immediate constants in ARM instructions* on page A5-200 for the range of values.

The pre-UAL syntax SUB<c>S is equivalent to SUBS<c>.

## Operation

```

if ConditionPassed() then
    EncodingSpecificOperations();
    (result, carry, overflow) = AddWithCarry(R[n], NOT(imm32), '1');
    if d == 15 then
        ALUWritePC(result); // setflags is always FALSE here
    else
        R[d] = result;
        if setflags then
            APSR.N = result<31>;
            APSR.Z = IsZeroBit(result);
            APSR.C = carry;
            APSR.V = overflow;

```

## Exceptions

None.

### A8.8.223 SUB (register)

This instruction subtracts an optionally-shifted register value from a register value, and writes the result to the destination register. It can optionally update the condition flags based on the result.

#### Encoding T1 ARMv4T, ARMv5T\*, ARMv6\*, ARMv7

SUBS <Rd>, <Rn>, <Rm> Outside IT block.  
SUB<C> <Rd>, <Rn>, <Rm> Inside IT block.

15	14	13	12	11	10	9	8	7	6	5	4	3	2	1	0
0	0	0	1	1	0	1	Rm		Rn		Rd				

d = UInt(Rd); n = UInt(Rn); m = UInt(Rm); setflags = !InITBlock();  
(shift\_t, shift\_n) = (SRTYPE\_LSL, 0);

#### Encoding T2 ARMv6T2, ARMv7

SUB{S}<C>.W <Rd>, <Rn>, <Rm>{, <shift>}

15	14	13	12	11	10	9	8	7	6	5	4	3	2	1	0	15	14	13	12	11	10	9	8	7	6	5	4	3	2	1	0
1	1	1	0	1	0	1	1	1	0	1	S	Rn		(0)	imm3	Rd		imm2	type	Rm											

if Rd == '1111' && S == '1' then SEE CMP (register);  
if Rn == '1101' then SEE SUB (SP minus register);  
d = UInt(Rd); n = UInt(Rn); m = UInt(Rm); setflags = (S == '1');  
(shift\_t, shift\_n) = DecodeImmShift(type, imm3:imm2);  
if d == 13 || (d == 15 && S == '0') || n == 15 || m IN {13,15} then UNPREDICTABLE;

#### Encoding A1 ARMv4\*, ARMv5T\*, ARMv6\*, ARMv7

SUB{S}<C> <Rd>, <Rn>, <Rm>{, <shift>}

31	30	29	28	27	26	25	24	23	22	21	20	19	18	17	16	15	14	13	12	11	10	9	8	7	6	5	4	3	2	1	0
cond		0	0	0	0	0	1	0	S	Rn		Rd		imm5			type	0	Rm												

if Rd == '1111' && S == '1' then SEE SUBS PC, LR and related instructions;  
if Rn == '1101' then SEE SUB (SP minus register);  
d = UInt(Rd); n = UInt(Rn); m = UInt(Rm); setflags = (S == '1');  
(shift\_t, shift\_n) = DecodeImmShift(type, imm5);

## Assembler syntax

SUB{S}{<c>}{<q>} {<Rd>}, <Rn>, <Rm> {, <shift>}

where:

- S If S is present, the instruction updates the flags. Otherwise, the flags are not updated.
- <c>, <q> See [Standard assembler syntax fields on page A8-287](#).
- <Rd> The destination register. If S is specified and <Rd> is the PC, see [SUBS PC, LR \(Thumb\) on page B9-2008](#) or [SUBS PC, LR and related instructions \(ARM\) on page B9-2010](#).  
In ARM instructions, if S is not specified and <Rd> is the PC, the instruction is a branch to the address calculated by the operation. This is an interworking branch, see [Pseudocode details of operations on ARM core registers on page A2-47](#).
- **Note** —————
- Before ARMv7, this was a simple branch.
- 
- <Rn> The first operand register. The PC can be used in ARM instructions. If the SP is specified for <Rn>, see [SUB \(SP minus register\) on page A8-718](#).
- <Rm> The register that is optionally shifted and used as the second operand. The PC can be used in ARM instructions.
- <shift> The shift to apply to the value read from <Rm>. If present, encoding T1 is not permitted. If absent, no shift is applied and all encodings are permitted. [Shifts applied to a register on page A8-291](#) describes the shifts and how they are encoded.

The pre-UAL syntax SUB<c>S is equivalent to SUBS<c>.

## Operation

```
if ConditionPassed() then
    EncodingSpecificOperations();
    shifted = Shift(R[m], shift_t, shift_n, APSR.C);
    (result, carry, overflow) = AddWithCarry(R[n], NOT(shifted), '1');
    if d == 15 then // Can only occur for ARM encoding
        ALUWritePC(result); // setflags is always FALSE here
    else
        R[d] = result;
        if setflags then
            APSR.N = result<31>;
            APSR.Z = IsZeroBit(result);
            APSR.C = carry;
            APSR.V = overflow;
```

## Exceptions

None.

### A8.8.224 SUB (register-shifted register)

This instruction subtracts a register-shifted register value from a register value, and writes the result to the destination register. It can optionally update the condition flags based on the result.

**Encoding A1** ARMv4\*, ARMv5T\*, ARMv6\*, ARMv7  
SUB{S}<c> <Rd>, <Rn>, <Rm>, <type> <Rs>

31	30	29	28	27	26	25	24	23	22	21	20	19	18	17	16	15	14	13	12	11	10	9	8	7	6	5	4	3	2	1	0
cond				0	0	0	0	0	1	0	S	Rn				Rd				Rs				0	type		1	Rm			

```
d = UInt(Rd); n = UInt(Rn); m = UInt(Rm); s = UInt(Rs);
setflags = (S == '1'); shift_t = DecodeRegShift(type);
if d == 15 || n == 15 || m == 15 || s == 15 then UNPREDICTABLE;
```

## Assembler syntax

SUB{S}{<c>}{<q>} {<Rd>}, <Rn>, <Rm>, <type> <Rs>

where:

S If S is present, the instruction updates the flags. Otherwise, the flags are not updated.

<c>, <q> See *Standard assembler syntax fields* on page A8-287.

<Rd> The destination register.

<Rn> The first operand register.

<Rm> The register that is shifted and used as the second operand.

<type> The type of shift to apply to the value read from <Rm>. It must be one of:

ASR Arithmetic shift right, encoded as type = 0b10.

LSL Logical shift left, encoded as type = 0b00.

LSR Logical shift right, encoded as type = 0b01.

ROR Rotate right, encoded as type = 0b11.

<Rs> The register whose bottom byte contains the amount to shift by.

The pre-UAL syntax SUB<c>S is equivalent to SUBS<c>.

## Operation

```
if ConditionPassed() then
    EncodingSpecificOperations();
    shift_n = UInt(R[s]<7:0>);
    shifted = Shift(R[m], shift_t, shift_n, APSR.C);
    (result, carry, overflow) = AddWithCarry(R[n], NOT(shifted), '1');
    R[d] = result;
    if setflags then
        APSR.N = result<31>;
        APSR.Z = IsZeroBit(result);
        APSR.C = carry;
        APSR.V = overflow;
```

## Exceptions

None.

### A8.8.225 SUB (SP minus immediate)

This instruction subtracts an immediate value from the SP value, and writes the result to the destination register.

**Encoding T1** ARMv4T, ARMv5T\*, ARMv6\*, ARMv7  
SUB<c> SP, SP, #<imm>

15	14	13	12	11	10	9	8	7	6	5	4	3	2	1	0
1	0	1	1	0	0	0	0	1	imm7						

d = 13; setflags = FALSE; imm32 = ZeroExtend(imm7:'00', 32);

**Encoding T2** ARMv6T2, ARMv7  
SUB{S}<c>.W <Rd>, SP, #<const>

15	14	13	12	11	10	9	8	7	6	5	4	3	2	1	0	15	14	13	12	11	10	9	8	7	6	5	4	3	2	1	0
1	1	1	1	0	i	0	1	1	0	1	S	1	1	0	1	0	imm3	Rd	imm8												

if Rd == '1111' && S == '1' then SEE CMP (immediate);  
d = UInt(Rd); setflags = (S == '1'); imm32 = ThumbExpandImm(i:imm3:imm8);  
if d == 15 && S == '0' then UNPREDICTABLE;

**Encoding T3** ARMv6T2, ARMv7  
SUBW<c> <Rd>, SP, #<imm12>

15	14	13	12	11	10	9	8	7	6	5	4	3	2	1	0	15	14	13	12	11	10	9	8	7	6	5	4	3	2	1	0
1	1	1	1	0	i	1	0	1	0	1	0	1	1	0	1	0	imm3	Rd	imm8												

d = UInt(Rd); setflags = FALSE; imm32 = ZeroExtend(i:imm3:imm8, 32);  
if d == 15 then UNPREDICTABLE;

**Encoding A1** ARMv4\*, ARMv5T\*, ARMv6\*, ARMv7  
SUB{S}<c> <Rd>, SP, #<const>

31	30	29	28	27	26	25	24	23	22	21	20	19	18	17	16	15	14	13	12	11	10	9	8	7	6	5	4	3	2	1	0
cond		0	0	1	0	0	1	0	S	1	1	0	1	Rd	imm12																

if Rd == '1111' && S == '1' then SEE SUBS PC, LR and related instructions;  
d = UInt(Rd); setflags = (S == '1'); imm32 = ARMEExpandImm(imm12);



## Assembler syntax

SUB{S}{<c>}{<q>} {<Rd>}, SP, #<const> All encodings permitted  
SUBW{<c>}{<q>} {<Rd>}, SP, #<const> Only encoding T3 permitted

where:

S If S is present, the instruction updates the flags. Otherwise, the flags are not updated.

<c>, <q> See [Standard assembler syntax fields on page A8-287](#).

<Rd> The destination register. If S is specified and <Rd> is the PC, see [SUBS PC, LR \(Thumb\) on page B9-2008](#) or [SUBS PC, LR and related instructions \(ARM\) on page B9-2010](#). If omitted, <Rd> is SP.

In ARM instructions, if S is not specified and <Rd> is the PC, the instruction is a branch to the address calculated by the operation. This is an interworking branch, see [Pseudocode details of operations on ARM core registers on page A2-47](#).

### Note

Before ARMv7, this was a simple branch.

<const> The immediate value to be subtracted from the value obtained from SP. Values are multiples of 4 in the range 0-508 for encoding T1 and any value in the range 0-4095 for encoding T3. See [Modified immediate constants in Thumb instructions on page A6-232](#) or [Modified immediate constants in ARM instructions on page A5-200](#) for the range of values for encodings T2 and A1.

When both 32-bit encodings are available for an instruction, encoding T2 is preferred to encoding T3 (if encoding T3 is required, use the SUBW syntax).

The pre-UAL syntax SUB<c>S is equivalent to SUBS<c>.

## Operation

```
if ConditionPassed() then
    EncodingSpecificOperations();
    (result, carry, overflow) = AddWithCarry(SP, NOT(imm32), '1');
    if d == 15 then // Can only occur for ARM encoding
        ALUWritePC(result); // setflags is always FALSE here
    else
        R[d] = result;
        if setflags then
            APSR.N = result<31>;
            APSR.Z = IsZeroBit(result);
            APSR.C = carry;
            APSR.V = overflow;
```

## Exceptions

None.

### A8.8.226 SUB (SP minus register)

This instruction subtracts an optionally-shifted register value from the SP value, and writes the result to the destination register.

#### Encoding T1 ARMv6T2, ARMv7

SUB{S}<c> <Rd>, SP, <Rm>{, <shift>}

15	14	13	12	11	10	9	8	7	6	5	4	3	2	1	0	15	14	13	12	11	10	9	8	7	6	5	4	3	2	1	0
1	1	1	0	1	0	1	1	1	0	1	S	1	1	0	1	(0)	imm3			Rd			imm2		type	Rm					

if Rd == '1111' && S == '1' then SEE CMP (register);  
d = UInt(Rd); m = UInt(Rm); setflags = (S == '1');  
(shift\_t, shift\_n) = DecodeImmShift(type, imm3:imm2);  
if d == 13 && (shift\_t != SRTYPE\_LSL || shift\_n > 3) then UNPREDICTABLE;  
if (d == 15 && S == '0') || m IN {13,15} then UNPREDICTABLE;

#### Encoding A1 ARMv4\*, ARMv5T\*, ARMv6\*, ARMv7

SUB{S}<c> <Rd>, SP, <Rm>{, <shift>}

31	30	29	28	27	26	25	24	23	22	21	20	19	18	17	16	15	14	13	12	11	10	9	8	7	6	5	4	3	2	1	0
cond			0	0	0	0	0	1	0	S	1	1	0	1	Rd			imm5			type	0	Rm								

if Rd == '1111' && S == '1' then SEE SUBS PC, LR and related instructions;  
d = UInt(Rd); m = UInt(Rm); setflags = (S == '1');  
(shift\_t, shift\_n) = DecodeImmShift(type, imm5);

## Assembler syntax

SUB{S}{<c>}{<q>} {<Rd>}, SP, <Rm> {, <shift>}

where:

- S            If S is present, the instruction updates the flags. Otherwise, the flags are not updated.
- <c><q>        See [Standard assembler syntax fields on page A8-287](#).
- <Rd>        The destination register. If S is specified and <Rd> is the PC, see [SUBS PC, LR \(Thumb\) on page B9-2008](#) or [SUBS PC, LR and related instructions \(ARM\) on page B9-2010](#). If omitted, <Rd> is SP.
- In ARM instructions, if S is not specified and <Rd> is the PC, the instruction is a branch to the address calculated by the operation. This is an interworking branch, see [Pseudocode details of operations on ARM core registers on page A2-47](#).
- **Note** —————
- Before ARMv7, this was a simple branch.
- 
- <Rm>        The register that is optionally shifted and used as the second operand. The PC can be used in ARM instructions.
- <shift>     The shift to apply to the value read from <Rm>. If omitted, no shift is applied. [Shifts applied to a register on page A8-291](#) describes the shifts and how they are encoded.
- In the Thumb instruction set, if <Rd> is SP or omitted, <shift> is only permitted to be omitted, LSL #1, LSL #2, or LSL #3.

The pre-UAL syntax SUB<c>S is equivalent to SUBS<c>.

## Operation

```

if ConditionPassed() then
    EncodingSpecificOperations();
    shifted = Shift(R[m], shift_t, shift_n, APSR.C);
    (result, carry, overflow) = AddWithCarry(SP, NOT(shifted), '1');
    if d == 15 then // Can only occur for ARM encoding
        ALUWritePC(result); // setflags is always FALSE here
    else
        R[d] = result;
        if setflags then
            APSR.N = result<31>;
            APSR.Z = IsZeroBit(result);
            APSR.C = carry;
            APSR.V = overflow;

```

## Exceptions

None.

### A8.8.227 SUBS PC, LR and related instructions

These instructions are for system level use only. See *SUBS PC, LR (Thumb)* on page B9-2008 and *SUBS PC, LR and related instructions (ARM)* on page B9-2010.

### A8.8.228 SVC (previously SWI)

Supervisor Call, previously called Software Interrupt, causes a Supervisor Call exception. For more information, see *Supervisor Call (SVC) exception* on page B1-1209.

Software can use this instruction as a call to an operating system to provide a service.

In the following cases, the Supervisor Call exception generated by the SVC instruction is taken to Hyp mode:

- If the SVC is executed in Hyp mode.
- If *HCR.TGE* is set to 1, and the SVC is executed in Non-secure User mode. For more information, see *Supervisor Call exception, when HCR.TGE is set to 1* on page B1-1191

In these cases, the *HSR* identifies that the exception entry was caused by a Supervisor Call exception, EC value 0x11, see *Use of the HSR* on page B3-1424. The immediate field in the *HSR*:

- if the SVC is unconditional:
  - for the Thumb instruction, is the zero-extended value of the *imm8* field
  - for the ARM instruction, is the least-significant 16 bits the *imm24* field
- if the SVC is conditional, is UNKNOWN.

#### Encoding T1 ARMv4T, ARMv5T\*, ARMv6\*, ARMv7

SVC<c> #<imm8>

15	14	13	12	11	10	9	8	7	6	5	4	3	2	1	0
1	1	0	1	1	1	1	1	imm8							

```
imm32 = ZeroExtend(imm8, 32);
// imm32 is for assembly/disassembly. SVC handlers in some
// systems interpret imm8 in software, for example to determine the required service.
```

#### Encoding A1 ARMv4\*, ARMv5T\*, ARMv6\*, ARMv7

SVC<c> #<imm24>

31	30	29	28	27	26	25	24	23	22	21	20	19	18	17	16	15	14	13	12	11	10	9	8	7	6	5	4	3	2	1	0
cond				1	1	1	1	imm24																							

```
imm32 = ZeroExtend(imm24, 32);
// imm32 is for assembly/disassembly. SVC handlers in some
// systems interpret imm24 in software, for example to determine the required service.
```

## Assembler syntax

SVC{<c>}{<q>} {#}<imm>

where:

<c>, <q> See *Standard assembler syntax fields* on page A8-287.

<imm> Specifies an immediate constant, 8-bit in Thumb instructions, or 24-bit in ARM instructions.

The pre-UAL syntax SWI<c> is equivalent to SVC<c>.

## Operation

```
if ConditionPassed() then
    EncodingSpecificOperations();
    CallSupervisor(imm32<15:0>);
```

## Exceptions

Supervisor Call.

### A8.8.229 SWP, SWPB

SWP (Swap) swaps a word between registers and memory. SWP loads a word from the memory address given by the value of register <Rn>. The value of register <Rt2> is then stored to the memory address given by the value of <Rn>, and the original loaded value is written to register <Rt>. If the same register is specified for <Rt> and <Rt2>, this instruction swaps the value of the register and the value at the memory address.

SWPB (Swap Byte) swaps a byte between registers and memory. SWPB loads a byte from the memory address given by the value of register <Rn>. The value of the least significant byte of register <Rt2> is stored to the memory address given by <Rn>, the original loaded value is zero-extended to a 32-bit word, and the word is written to register <Rt>. If the same register is specified for <Rt> and <Rt2>, this instruction swaps the value of the least significant byte of the register and the byte value at the memory address, and clears the most significant three bytes of the register.

For both instructions, the memory system ensures that no other memory access can occur to the memory location between the load access and the store access.

———— **Note** —————

- The SWP and SWPB instructions rely on the properties of the system beyond the processor to ensure that no stores from other observers can occur between the load access and the store access, and this might not be implemented for all regions of memory on some system implementations. In all cases, SWP and SWPB do ensure that no stores from the processor that executed the SWP or SWPB instruction can occur between the load access and the store access of the SWP or SWPB.
- ARM deprecates the use of SWP and SWPB, and strongly recommends that new software uses:
  - LDREX/STREX in preference to SWP
  - LDREXB/STREXB in preference to SWPB.
- If the translation table entries that relate to a memory location accessed by the SWP or SWPB instruction change, or are seen to change by the executing processor as a result of TLB eviction, this might mean that the translation table attributes, permissions or addresses for the load are different to those for the store. In this case, the architecture makes no guarantee that no memory access occur to these memory locations between the load and store.

The Virtualization Extensions make the SWP and SWPB instructions OPTIONAL and deprecated:

- If an implementation does not include the SWP and SWPB instructions, the `ID_ISAR0.Swap_insts` and `ID_ISAR4.SWP_frac` fields are zero, see *About the Instruction Set Attribute registers* on page B7-1950.
- In an implementation that includes SWP and SWPB, both instructions are UNDEFINED in Hyp mode.

**Encoding A1** ARMv4\*, ARMv5T\*, deprecated in ARMv6\* and ARMv7, OPTIONAL in ARMv7VE  
SWP{B}<c> <Rt>, <Rt2>, [<Rn>]

31	30	29	28	27	26	25	24	23	22	21	20	19	18	17	16	15	14	13	12	11	10	9	8	7	6	5	4	3	2	1	0
cond		0	0	0	1	0	B	0	0	Rn				Rt				(0)	(0)	(0)	(0)	1	0	0	1	Rt2					

t = UInt(Rt); t2 = UInt(Rt2); n = UInt(Rn); size = if B == '1' then 1 else 4;  
if t == 15 || t2 == 15 || n == 15 || n == t || n == t2 then UNPREDICTABLE;

## Assembler syntax

SWP{B}{<c>}{<q>} <Rt>, <Rt2>, [<Rn>]

where:

B If B is present, the instruction operates on a byte. Otherwise, it operates on a word.

<c>, <q> See *Standard assembler syntax fields on page A8-287*.

<Rt> The destination register.

<Rt2> Contains the value that is stored to memory.

<Rn> Contains the memory address to load from.

The pre-UAL syntax SWP<c>B is equivalent to SWPB<c>.

## Operation

```
if ConditionPassed() then
    EncodingSpecificOperations();
    if CurrentModeIsHyp() then UNDEFINED;
    // The MemA[] accesses in the next two statements are locked together, that is, the memory
    // system must ensure that no other access to the same location can occur between them.
    data = MemA[R[n], size];
    MemA[R[n], size] = R[t2]<8*size-1:0>;
    if size == 1 then // SWPB
        R[t] = ZeroExtend(data, 32);
    else // SWP
        // Rotation in the following will always be by zero in ARMv7, due to alignment checks,
        // but can be nonzero in legacy configurations.
        R[t] = ROR(data, 8*UInt(R[n]<1:0>));
```

## Exceptions

Data Abort.

### A8.8.230 SXTAB

Signed Extend and Add Byte extracts an 8-bit value from a register, sign-extends it to 32 bits, adds the result to the value in another register, and writes the final result to the destination register. The instruction can specify a rotation by 0, 8, 16, or 24 bits before extracting the 8-bit value.

#### Encoding T1 ARMv6T2, ARMv7

SXTAB<c> <Rd>, <Rn>, <Rm>{, <rotation>}

15	14	13	12	11	10	9	8	7	6	5	4	3	2	1	0	15	14	13	12	11	10	9	8	7	6	5	4	3	2	1	0
1	1	1	1	1	0	1	0	0	0	1	0	0	Rn			1	1	1	1	Rd			1	(0)	rotate	Rm					

```
if Rn == '1111' then SEE SXTB;
d = UInt(Rd); n = UInt(Rn); m = UInt(Rm); rotation = UInt(rotate:'000');
if d IN {13,15} || n == 13 || m IN {13,15} then UNPREDICTABLE;
```

#### Encoding A1 ARMv6\*, ARMv7

SXTAB<c> <Rd>, <Rn>, <Rm>{, <rotation>}

31	30	29	28	27	26	25	24	23	22	21	20	19	18	17	16	15	14	13	12	11	10	9	8	7	6	5	4	3	2	1	0
cond		0	1	1	0	1	0	1	0	Rn			Rd			rotate	(0)	(0)	0	1	1	1	Rm								

```
if Rn == '1111' then SEE SXTB;
d = UInt(Rd); n = UInt(Rn); m = UInt(Rm); rotation = UInt(rotate:'000');
if d == 15 || m == 15 then UNPREDICTABLE;
```



## Assembler syntax

SXTAB{<c>}{<q>} {<Rd>}, <Rn>, <Rm> {, <rotation>}

where:

<c>, <q> See *Standard assembler syntax fields* on page A8-287.

<Rd> The destination register.

<Rn> The first operand register.

<Rm> The second operand register.

<rotation> This can be any one of:

**omitted** encoded as rotate = 0b00

ROR #8 encoded as rotate = 0b01

ROR #16 encoded as rotate = 0b10

ROR #24 encoded as rotate = 0b11.

### ———— Note —————

An assembler can permit ROR #0 to mean the same thing as omitting the rotation, possibly with restrictions on the permitted encodings, but this is not standard UAL and must not be used for disassembly.

## Operation

```
if ConditionPassed() then
    EncodingSpecificOperations();
    rotated = ROR(R[m], rotation);
    R[d] = R[n] + SignExtend(rotated<7:0>, 32);
```

## Exceptions

None.

### A8.8.231 SXTAB16

Signed Extend and Add Byte 16 extracts two 8-bit values from a register, sign-extends them to 16 bits each, adds the results to two 16-bit values from another register, and writes the final results to the destination register. The instruction can specify a rotation by 0, 8, 16, or 24 bits before extracting the 8-bit values.

**Encoding T1** ARMv6T2, ARMv7  
SXTAB16<c> <Rd>, <Rn>, <Rm>{, <rotation>}

15	14	13	12	11	10	9	8	7	6	5	4	3	2	1	0	15	14	13	12	11	10	9	8	7	6	5	4	3	2	1	0
1	1	1	1	1	0	1	0	0	0	1	0	Rn				1	1	1	1	Rd				1	(0)	rotate	Rm				

if Rn == '1111' then SEE SXTB16;  
d = UInt(Rd); n = UInt(Rn); m = UInt(Rm); rotation = UInt(rotate:'000');  
if d IN {13,15} || n == 13 || m IN {13,15} then UNPREDICTABLE;

**Encoding A1** ARMv6\*, ARMv7  
SXTAB16<c> <Rd>, <Rn>, <Rm>{, <rotation>}

31	30	29	28	27	26	25	24	23	22	21	20	19	18	17	16	15	14	13	12	11	10	9	8	7	6	5	4	3	2	1	0
cond		0	1	1	0	1	0	0	0	Rn				Rd				rotate	(0)	(0)	0	1	1	1	Rm						

if Rn == '1111' then SEE SXTB16;  
d = UInt(Rd); n = UInt(Rn); m = UInt(Rm); rotation = UInt(rotate:'000');  
if d == 15 || m == 15 then UNPREDICTABLE;

## Assembler syntax

SXTAB16{<c>}{<q>} {<Rd>}, <Rn>, <Rm> {, <rotation>}

where:

<c>, <q> See *Standard assembler syntax fields* on page A8-287.

<Rd> The destination register.

<Rn> The first operand register.

<Rm> The second operand register.

<rotation> This can be any one of:

**omitted** encoded as rotate = 0b00

ROR #8 encoded as rotate = 0b01

ROR #16 encoded as rotate = 0b10

ROR #24 encoded as rotate = 0b11.

### ———— Note —————

An assembler can permit ROR #0 to mean the same thing as omitting the rotation, possibly with restrictions on the permitted encodings, but this is not standard UAL and must not be used for disassembly.

## Operation

```
if ConditionPassed() then
    EncodingSpecificOperations();
    rotated = ROR(R[m], rotation);
    R[d]<15:0> = R[n]<15:0> + SignExtend(rotated<7:0>, 16);
    R[d]<31:16> = R[n]<31:16> + SignExtend(rotated<23:16>, 16);
```

## Exceptions

None.

### A8.8.232 SXTAH

Signed Extend and Add Halfword extracts a 16-bit value from a register, sign-extends it to 32 bits, adds the result to a value from another register, and writes the final result to the destination register. The instruction can specify a rotation by 0, 8, 16, or 24 bits before extracting the 16-bit value.

**Encoding T1** ARMv6T2, ARMv7

SXTAH<c> <Rd>, <Rn>, <Rm>{, <rotation>}

15	14	13	12	11	10	9	8	7	6	5	4	3	2	1	0	15	14	13	12	11	10	9	8	7	6	5	4	3	2	1	0
1	1	1	1	1	0	1	0	0	0	0	0	Rn				1	1	1	1	Rd				1	(0)	rotate	Rm				

if Rn == '1111' then SEE SXTB;  
d = UInt(Rd); n = UInt(Rn); m = UInt(Rm); rotation = UInt(rotate:'000');  
if d IN {13,15} || n == 13 || m IN {13,15} then UNPREDICTABLE;

**Encoding A1** ARMv6\*, ARMv7

SXTAH<c> <Rd>, <Rn>, <Rm>{, <rotation>}

31	30	29	28	27	26	25	24	23	22	21	20	19	18	17	16	15	14	13	12	11	10	9	8	7	6	5	4	3	2	1	0
cond		0	1	1	0	1	0	1	1	Rn				Rd				rotate	(0)	(0)	0	1	1	1	Rm						

if Rn == '1111' then SEE SXTB;  
d = UInt(Rd); n = UInt(Rn); m = UInt(Rm); rotation = UInt(rotate:'000');  
if d == 15 || m == 15 then UNPREDICTABLE;

## Assembler syntax

SXTAH{<c>}{<q>} {<Rd>}, <Rn>, <Rm> {, <rotation>}

where:

<c>, <q> See *Standard assembler syntax fields* on page A8-287.

<Rd> The destination register.

<Rn> The first operand register.

<Rm> The second operand register.

<rotation> This can be any one of:

**omitted** encoded as rotate = 0b00

ROR #8 encoded as rotate = 0b01

ROR #16 encoded as rotate = 0b10

ROR #24 encoded as rotate = 0b11.

### ———— Note —————

An assembler can permit ROR #0 to mean the same thing as omitting the rotation, possibly with restrictions on the permitted encodings, but this is not standard UAL and must not be used for disassembly.

## Operation

```
if ConditionPassed() then
    EncodingSpecificOperations();
    rotated = ROR(R[m], rotation);
    R[d] = R[n] + SignExtend(rotated<15:0>, 32);
```

## Exceptions

None.

### A8.8.233 SXTB

Signed Extend Byte extracts an 8-bit value from a register, sign-extends it to 32 bits, and writes the result to the destination register. The instruction can specify a rotation by 0, 8, 16, or 24 bits before extracting the 8-bit value.

#### Encoding T1 ARMv6\*, ARMv7

SXTB<c> <Rd>, <Rm>

15	14	13	12	11	10	9	8	7	6	5	4	3	2	1	0
1	0	1	1	0	0	1	0	0	1	Rm					Rd

d = UInt(Rd); m = UInt(Rm); rotation = 0;

#### Encoding T2 ARMv6T2, ARMv7

SXTB<c>.W <Rd>, <Rm>{, <rotation>}

15	14	13	12	11	10	9	8	7	6	5	4	3	2	1	0	15	14	13	12	11	10	9	8	7	6	5	4	3	2	1	0
1	1	1	1	1	0	1	0	0	0	1	0	0	1	1	1	1	1	1	1	1		Rd		1	(0)	rotate		Rm			

d = UInt(Rd); m = UInt(Rm); rotation = UInt(rotate:'000');  
if d IN {13,15} || m IN {13,15} then UNPREDICTABLE;

#### Encoding A1 ARMv6\*, ARMv7

SXTB<c> <Rd>, <Rm>{, <rotation>}

31	30	29	28	27	26	25	24	23	22	21	20	19	18	17	16	15	14	13	12	11	10	9	8	7	6	5	4	3	2	1	0
cond		0	1	1	0	1	0	1	0	1	0	1	1	1	1		Rd		rotate	(0)	(0)	0	1	1	1					Rm	

d = UInt(Rd); m = UInt(Rm); rotation = UInt(rotate:'000');  
if d == 15 || m == 15 then UNPREDICTABLE;

## Assembler syntax

SXTB{<c>}{<q>} {<Rd>}, <Rm> {, <rotation>}

where:

<c>, <q> See *Standard assembler syntax fields* on page A8-287.

<Rd> The destination register.

<Rm> The register that contains the operand.

<rotation> This can be any one of:

**omitted** any encoding, encoded as rotate = 0b00 in encoding T2 or A1

ROR #8 encoding T2 or A1, encoded as rotate = 0b01

ROR #16 encoding T2 or A1, encoded as rotate = 0b10

ROR #24 encoding T2 or A1, encoded as rotate = 0b11.

### ————— Note —————

An assembler can permit ROR #0 to mean the same thing as omitting the rotation, possibly with restrictions on the permitted encodings, but this is not standard UAL and must not be used for disassembly.

## Operation

```
if ConditionPassed() then
    EncodingSpecificOperations();
    rotated = ROR(R[m], rotation);
    R[d] = SignExtend(rotated<7:0>, 32);
```

## Exceptions

None.

### A8.8.234 SXTB16

Signed Extend Byte 16 extracts two 8-bit values from a register, sign-extends them to 16 bits each, and writes the results to the destination register. The instruction can specify a rotation by 0, 8, 16, or 24 bits before extracting the 8-bit values.

**Encoding T1** ARMv6T2, ARMv7

SXTB16<c> <Rd>, <Rm>{, <rotation>}

15	14	13	12	11	10	9	8	7	6	5	4	3	2	1	0	15	14	13	12	11	10	9	8	7	6	5	4	3	2	1	0
1	1	1	1	1	0	1	0	0	0	1	0	1	1	1	1	1	1	1	1		Rd		1	(0)	rotate		Rm				

d = UInt(Rd); m = UInt(Rm); rotation = UInt(rotate:'000');  
if d IN {13,15} || m IN {13,15} then UNPREDICTABLE;

**Encoding A1** ARMv6\*, ARMv7

SXTB16<c> <Rd>, <Rm>{, <rotation>}

31	30	29	28	27	26	25	24	23	22	21	20	19	18	17	16	15	14	13	12	11	10	9	8	7	6	5	4	3	2	1	0
cond		0	1	1	0	1	0	0	0	1	1	1	1		Rd		rotate	(0)	(0)	0	1	1	1		Rm						

d = UInt(Rd); m = UInt(Rm); rotation = UInt(rotate:'000');  
if d == 15 || m == 15 then UNPREDICTABLE;



## Assembler syntax

SXTB16{<c>}{<q>} {<Rd>}, <Rm> {, <rotation>}

where:

<c>, <q> See [Standard assembler syntax fields on page A8-287](#).

<Rd> The destination register.

<Rm> The register that contains the operand.

<rotation> This can be any one of:

**omitted** encoded as rotate = 0b00  
ROR #8 encoded as rotate = 0b01  
ROR #16 encoded as rotate = 0b10  
ROR #24 encoded as rotate = 0b11.

### ———— Note —————

An assembler can permit ROR #0 to mean the same thing as omitting the rotation, possibly with restrictions on the permitted encodings, but this is not standard UAL and must not be used for disassembly.

## Operation

```
if ConditionPassed() then
    EncodingSpecificOperations();
    rotated = ROR(R[m], rotation);
    R[d]<15:0> = SignExtend(rotated<7:0>, 16);
    R[d]<31:16> = SignExtend(rotated<23:16>, 16);
```

## Exceptions

None.

### A8.8.235 SXTB

Signed Extend Halfword extracts a 16-bit value from a register, sign-extends it to 32 bits, and writes the result to the destination register. The instruction can specify a rotation by 0, 8, 16, or 24 bits before extracting the 16-bit value.

#### Encoding T1 ARMv6\*, ARMv7

SXTB<c> <Rd>, <Rm>

15	14	13	12	11	10	9	8	7	6	5	4	3	2	1	0
1	0	1	1	0	0	1	0	0	0	Rm					Rd

d = UInt(Rd); m = UInt(Rm); rotation = 0;

#### Encoding T2 ARMv6T2, ARMv7

SXTB<c>.W <Rd>, <Rm>{, <rotation>}

15	14	13	12	11	10	9	8	7	6	5	4	3	2	1	0	15	14	13	12	11	10	9	8	7	6	5	4	3	2	1	0
1	1	1	1	1	0	1	0	0	0	0	0	1	1	1	1	1	1	1	1		Rd		1	(0)	rotate		Rm				

d = UInt(Rd); m = UInt(Rm); rotation = UInt(rotate:'000');  
if d IN {13,15} || m IN {13,15} then UNPREDICTABLE;

#### Encoding A1 ARMv6\*, ARMv7

SXTB<c> <Rd>, <Rm>{, <rotation>}

31	30	29	28	27	26	25	24	23	22	21	20	19	18	17	16	15	14	13	12	11	10	9	8	7	6	5	4	3	2	1	0
cond		0	1	1	0	1	0	1	1	1	1					Rd			rotate	(0)	(0)	0	1	1	1					Rm	

d = UInt(Rd); m = UInt(Rm); rotation = UInt(rotate:'000');  
if d == 15 || m == 15 then UNPREDICTABLE;

## Assembler syntax

SXTH{<c>}{<q>} {<Rd>}, <Rm> {, <rotation>}

where:

<c>, <q> See *Standard assembler syntax fields* on page A8-287.

<Rd> The destination register.

<Rm> The register that contains the operand.

<rotation> This can be any one of:

**omitted** any encoding, encoded as rotate = 0b00 in encoding T2 or A1

ROR #8 encoding T2 or A1, encoded as rotate = 0b01

ROR #16 encoding T2 or A1, encoded as rotate = 0b10

ROR #24 encoding T2 or A1, encoded as rotate = 0b11.

### ———— Note —————

An assembler can permit ROR #0 to mean the same thing as omitting the rotation, possibly with restrictions on the permitted encodings, but this is not standard UAL and must not be used for disassembly.

## Operation

```
if ConditionPassed() then
    EncodingSpecificOperations();
    rotated = ROR(R[m], rotation);
    R[d] = SignExtend(rotated<15:0>, 32);
```

## Exceptions

None.

### A8.8.236 TBB, TBH

Table Branch Byte causes a PC-relative forward branch using a table of single byte offsets. A base register provides a pointer to the table, and a second register supplies an index into the table. The branch length is twice the value of the byte returned from the table.

Table Branch Halfword causes a PC-relative forward branch using a table of single halfword offsets. A base register provides a pointer to the table, and a second register supplies an index into the table. The branch length is twice the value of the halfword returned from the table.

**Encoding T1** ARMv6T2, ARMv7

TBB<c> [<Rn>, <Rm>] Outside or last in IT block

TBH<c> [<Rn>, <Rm>, LSL #1] Outside or last in IT block

15	14	13	12	11	10	9	8	7	6	5	4	3	2	1	0	15	14	13	12	11	10	9	8	7	6	5	4	3	2	1	0
1	1	1	0	1	0	0	0	1	1	0	1	Rn				(1)	(1)	(1)	(1)	(0)	(0)	(0)	(0)	0	0	0	H	Rm			

```
n = UInt(Rn); m = UInt(Rm); is_tbh = (H == '1');
if n == 13 || m IN {13,15} then UNPREDICTABLE;
if InITBlock() && !LastInITBlock() then UNPREDICTABLE;
```

## Assembler syntax

TBB{<c>}{<q>} [<Rn>, <Rm>]

TBH{<c>}{<q>} [<Rn>, <Rm>, LSL #1]

where:

<c>, <q> See *Standard assembler syntax fields* on page A8-287.

<Rn> The base register. This contains the address of the table of branch lengths. The PC can be used. If it is, the table immediately follows this instruction.

<Rm> The index register.

For TBB, this contains an integer pointing to a single byte in the table. The offset in the table is the value of the index.

For TBH, this contains an integer pointing to a halfword in the table. The offset in the table is twice the value of the index.

## Operation

```
if ConditionPassed() then
    EncodingSpecificOperations(); NullCheckIfThumbEE(n);
    if is_tbb then
        halfwords = UInt(MemU[R[n]+LSL(R[m],1), 2]);
    else
        halfwords = UInt(MemU[R[n]+R[m], 1]);
    BranchWritePC(PC + 2*halfwords);
```

## Exceptions

Data Abort.

### A8.8.237 TEQ (immediate)

Test Equivalence (immediate) performs a bitwise exclusive OR operation on a register value and an immediate value. It updates the condition flags based on the result, and discards the result.

#### Encoding T1 ARMv6T2, ARMv7

TEQ<c> <Rn>, #<const>

15	14	13	12	11	10	9	8	7	6	5	4	3	2	1	0	15	14	13	12	11	10	9	8	7	6	5	4	3	2	1	0
1	1	1	1	0	i	0	0	1	0	0	1	Rn				0	imm3			1	1	1	1	imm8							

```
n = UInt(Rn);
(imm32, carry) = ThumbExpandImm_C(i:imm3:imm8, APSR.C);
if n IN {13,15} then UNPREDICTABLE;
```

#### Encoding A1 ARMv4\*, ARMv5T\*, ARMv6\*, ARMv7

TEQ<c> <Rn>, #<const>

31	30	29	28	27	26	25	24	23	22	21	20	19	18	17	16	15	14	13	12	11	10	9	8	7	6	5	4	3	2	1	0
cond		0	0	1	1	0	0	1	1	Rn			(0)	(0)	(0)	(0)	imm12														

```
n = UInt(Rn);
(imm32, carry) = ARMEExpandImm_C(imm12, APSR.C);
```

## Assembler syntax

TEQ{<c>}{<q>} <Rn>, #<const>

where:

<c>, <q> See *Standard assembler syntax fields* on page A8-287.

<Rn> The operand register. The PC can be used in ARM instructions.

<const> The immediate value to be tested against the value obtained from <Rn>. See *Modified immediate constants in Thumb instructions* on page A6-232 or *Modified immediate constants in ARM instructions* on page A5-200 for the range of values.

## Operation

```
if ConditionPassed() then
    EncodingSpecificOperations();
    result = R[n] EOR imm32;
    APSR.N = result<31>;
    APSR.Z = IsZeroBit(result);
    APSR.C = carry;
    // APSR.V unchanged
```

## Exceptions

None.

### A8.8.238 TEQ (register)

Test Equivalence (register) performs a bitwise exclusive OR operation on a register value and an optionally-shifted register value. It updates the condition flags based on the result, and discards the result.

#### Encoding T1 ARMv6T2, ARMv7

TEQ<c> <Rn>, <Rm>{, <shift>}

15	14	13	12	11	10	9	8	7	6	5	4	3	2	1	0	15	14	13	12	11	10	9	8	7	6	5	4	3	2	1	0
1	1	1	0	1	0	1	0	1	0	0	1	Rn				(0)	imm3			1	1	1	1	imm2		type	Rm				

n = UInt(Rn); m = UInt(Rm);  
(shift\_t, shift\_n) = DecodeImmShift(type, imm3:imm2);  
if n IN {13,15} || m IN {13,15} then UNPREDICTABLE;

#### Encoding A1 ARMv4\*, ARMv5T\*, ARMv6\*, ARMv7

TEQ<c> <Rn>, <Rm>{, <shift>}

31	30	29	28	27	26	25	24	23	22	21	20	19	18	17	16	15	14	13	12	11	10	9	8	7	6	5	4	3	2	1	0
cond				0	0	0	1	0	0	1	1	Rn				(0)	(0)	(0)	(0)	imm5					type	0	Rm				

n = UInt(Rn); m = UInt(Rm);  
(shift\_t, shift\_n) = DecodeImmShift(type, imm5);



## Assembler syntax

TEQ{<c>}{<q>} <Rn>, <Rm> {, <shift>}

where:

- <c>, <q> See [Standard assembler syntax fields on page A8-287](#).
- <Rn> The first operand register. The PC can be used in ARM instructions.
- <Rm> The register that is optionally shifted and used as the second operand. The PC can be used in ARM instructions.
- <shift> The shift to apply to the value read from <Rm>. If omitted, no shift is applied. [Shifts applied to a register on page A8-291](#) describes the shifts and how they are encoded.

## Operation

```
if ConditionPassed() then
    EncodingSpecificOperations();
    (shifted, carry) = Shift_C(R[m], shift_t, shift_n, APSR.C);
    result = R[n] EOR shifted;
    APSR.N = result<31>;
    APSR.Z = IsZeroBit(result);
    APSR.C = carry;
    // APSR.V unchanged
```

## Exceptions

None.

### A8.8.239 TEQ (register-shifted register)

Test Equivalence (register-shifted register) performs a bitwise exclusive OR operation on a register value and a register-shifted register value. It updates the condition flags based on the result, and discards the result.

#### Encoding A1 ARMv4\*, ARMv5T\*, ARMv6\*, ARMv7

TEQ<c> <Rn>, <Rm>, <type> <Rs>

31	30	29	28	27	26	25	24	23	22	21	20	19	18	17	16	15	14	13	12	11	10	9	8	7	6	5	4	3	2	1	0
cond				0	0	0	1	0	0	1	1	Rn				(0)	(0)	(0)	(0)	Rs				0	type		1	Rm			

```
n = UInt(Rn); m = UInt(Rm); s = UInt(Rs);
shift_t = DecodeRegShift(type);
if n == 15 || m == 15 || s == 15 then UNPREDICTABLE;
```

## Assembler syntax

TEQ{<c>}{<q>} <Rn>, <Rm>, <type> <Rs>

where:

- <c>, <q> See [Standard assembler syntax fields on page A8-287](#).
- <Rn> The first operand register.
- <Rm> The register that is shifted and used as the second operand.
- <type> The type of shift to apply to the value read from <Rm>. It must be one of:
- |     |   |
|-----|---|
| ASR | Arithmetic shift right, encoded as type = 0b10. |
| LSL | Logical shift left, encoded as type = 0b00.     |
| LSR | Logical shift right, encoded as type = 0b01.    |
| ROR | Rotate right, encoded as type = 0b11.           |
- <Rs> The register whose bottom byte contains the amount to shift by.

## Operation

```
if ConditionPassed() then
    EncodingSpecificOperations();
    shift_n = UInt(R[s]<7:0>);
    (shifted, carry) = Shift_C(R[m], shift_t, shift_n, APSR.C);
    result = R[n] EOR shifted;
    APSR.N = result<31>;
    APSR.Z = IsZeroBit(result);
    APSR.C = carry;
    // APSR.V unchanged
```

## Exceptions

None.

### A8.8.240 TST (immediate)

Test (immediate) performs a bitwise AND operation on a register value and an immediate value. It updates the condition flags based on the result, and discards the result.

#### Encoding T1 ARMv6T2, ARMv7

TST<c> <Rn>, #<const>

15	14	13	12	11	10	9	8	7	6	5	4	3	2	1	0	15	14	13	12	11	10	9	8	7	6	5	4	3	2	1	0
1	1	1	1	0	i	0	0	0	0	0	1	Rn				0	imm3			1	1	1	1	imm8							

```
n = UInt(Rn);
(imm32, carry) = ThumbExpandImm_C(i:imm3:imm8, APSR.C);
if n IN {13,15} then UNPREDICTABLE;
```

#### Encoding A1 ARMv4\*, ARMv5T\*, ARMv6\*, ARMv7

TST<c> <Rn>, #<const>

31	30	29	28	27	26	25	24	23	22	21	20	19	18	17	16	15	14	13	12	11	10	9	8	7	6	5	4	3	2	1	0
cond		0	0	1	1	0	0	0	1	Rn				(0)	(0)	(0)	(0)	imm12													

```
n = UInt(Rn);
(imm32, carry) = ARMEExpandImm_C(imm12, APSR.C);
```

## Assembler syntax

TST{<c>}{<q>} <Rn>, #<const>

where:

<c>, <q> See *Standard assembler syntax fields* on page A8-287.

<Rn> The operand register. The PC can be used in ARM instructions.

<const> The immediate value to be tested against the value obtained from <Rn>. See *Modified immediate constants in Thumb instructions* on page A6-232 or *Modified immediate constants in ARM instructions* on page A5-200 for the range of values.

## Operation

```
if ConditionPassed() then
    EncodingSpecificOperations();
    result = R[n] AND imm32;
    APSR.N = result<31>;
    APSR.Z = IsZeroBit(result);
    APSR.C = carry;
    // APSR.V unchanged
```

## Exceptions

None.

### A8.8.241 TST (register)

Test (register) performs a bitwise AND operation on a register value and an optionally-shifted register value. It updates the condition flags based on the result, and discards the result.

**Encoding T1** ARMv4T, ARMv5T\*, ARMv6\*, ARMv7

TST<c> <Rn>, <Rm>

15	14	13	12	11	10	9	8	7	6	5	4	3	2	1	0
0	1	0	0	0	0	1	0	0	0	Rm					Rn

n = UInt(Rn); m = UInt(Rm);  
(shift\_t, shift\_n) = (SRTYPE\_LSL, 0);

**Encoding T2** ARMv6T2, ARMv7

TST<c>.W <Rn>, <Rm>{, <shift>}

15	14	13	12	11	10	9	8	7	6	5	4	3	2	1	0	15	14	13	12	11	10	9	8	7	6	5	4	3	2	1	0
1	1	1	0	1	0	1	0	0	0	0	1	Rn	(0)	imm3	1	1	1	1	imm2	type					Rm						

n = UInt(Rn); m = UInt(Rm);  
(shift\_t, shift\_n) = DecodeImmShift(type, imm3:imm2);  
if n IN {13,15} || m IN {13,15} then UNPREDICTABLE;

**Encoding A1** ARMv4\*, ARMv5T\*, ARMv6\*, ARMv7

TST<c> <Rn>, <Rm>{, <shift>}

31	30	29	28	27	26	25	24	23	22	21	20	19	18	17	16	15	14	13	12	11	10	9	8	7	6	5	4	3	2	1	0
cond	0	0	0	1	0	0	0	1	Rn	(0)	(0)	(0)	(0)	imm5	type	0															Rm

n = UInt(Rn); m = UInt(Rm);  
(shift\_t, shift\_n) = DecodeImmShift(type, imm5);

## Assembler syntax

TST{<c>}{<q>} <Rn>, <Rm> {, <shift>}

where:

- <c>, <q> See [Standard assembler syntax fields on page A8-287](#).
- <Rn> The first operand register. The PC can be used in ARM instructions.
- <Rm> The register that is optionally shifted and used as the second operand. The PC can be used in ARM instructions.
- <shift> The shift to apply to the value read from <Rm>. If present, encoding T1 is not permitted. If absent, no shift is applied and all encodings are permitted. [Shifts applied to a register on page A8-291](#) describes the shifts and how they are encoded.

## Operation

```
if ConditionPassed() then
    EncodingSpecificOperations();
    (shifted, carry) = Shift_C(R[m], shift_t, shift_n, APSR.C);
    result = R[n] AND shifted;
    APSR.N = result<31>;
    APSR.Z = IsZeroBit(result);
    APSR.C = carry;
    // APSR.V unchanged
```

## Exceptions

None.

### A8.8.242 TST (register-shifted register)

Test (register-shifted register) performs a bitwise AND operation on a register value and a register-shifted register value. It updates the condition flags based on the result, and discards the result.

**Encoding A1** ARMv4\*, ARMv5T\*, ARMv6\*, ARMv7

TST<c> <Rn>, <Rm>, <type> <Rs>

31	30	29	28	27	26	25	24	23	22	21	20	19	18	17	16	15	14	13	12	11	10	9	8	7	6	5	4	3	2	1	0
cond				0	0	0	1	0	0	0	1	Rn				(0)	(0)	(0)	(0)	Rs				0	type		1	Rm			

```
n = UInt(Rn); m = UInt(Rm); s = UInt(Rs);
shift_t = DecodeRegShift(type);
if n == 15 || m == 15 || s == 15 then UNPREDICTABLE;
```



## Assembler syntax

TST{<c>}{<q>} <Rn>, <Rm>, <type> <Rs>

where:

- <c>, <q> See [Standard assembler syntax fields on page A8-287](#).
- <Rn> The first operand register.
- <Rm> The register that is shifted and used as the second operand.
- <type> The type of shift to apply to the value read from <Rm>. It must be one of:
- |     |   |
|-----|---|
| ASR | Arithmetic shift right, encoded as type = 0b10. |
| LSL | Logical shift left, encoded as type = 0b00.     |
| LSR | Logical shift right, encoded as type = 0b01.    |
| ROR | Rotate right, encoded as type = 0b11.           |
- <Rs> The register whose bottom byte contains the amount to shift by.

## Operation

```
if ConditionPassed() then
    EncodingSpecificOperations();
    shift_n = UInt(R[s]<7:0>);
    (shifted, carry) = Shift_C(R[m], shift_t, shift_n, APSR.C);
    result = R[n] AND shifted;
    APSR.N = result<31>;
    APSR.Z = IsZeroBit(result);
    APSR.C = carry;
    // APSR.V unchanged
```

## Exceptions

None.

### A8.8.243 UADD16

Unsigned Add 16 performs two 16-bit unsigned integer additions, and writes the results to the destination register. It sets the APSR.GE bits according to the results of the additions.

**Encoding T1** ARMv6T2, ARMv7

UADD16<c> <Rd>, <Rn>, <Rm>

15	14	13	12	11	10	9	8	7	6	5	4	3	2	1	0	15	14	13	12	11	10	9	8	7	6	5	4	3	2	1	0
1	1	1	1	1	0	1	0	1	1	0	0	1	Rn			1	1	1	1	Rd			0	1	0	0	Rm				

d = UInt(Rd); n = UInt(Rn); m = UInt(Rm);  
if d IN {13,15} || n IN {13,15} || m IN {13,15} then UNPREDICTABLE;

**Encoding A1** ARMv6\*, ARMv7

UADD16<c> <Rd>, <Rn>, <Rm>

31	30	29	28	27	26	25	24	23	22	21	20	19	18	17	16	15	14	13	12	11	10	9	8	7	6	5	4	3	2	1	0
cond		0	1	1	0	0	1	0	1	Rn			Rd			(1)	(1)	(1)	(1)	0	0	0	1	Rm							

d = UInt(Rd); n = UInt(Rn); m = UInt(Rm);  
if d == 15 || n == 15 || m == 15 then UNPREDICTABLE;

## Assembler syntax

UADD16{<c>}{<q>} {<Rd>}, <Rn>, <Rm>

where:

<c>, <q> See *Standard assembler syntax fields* on page A8-287.

<Rd> The destination register.

<Rn> The first operand register.

<Rm> The second operand register.

## Operation

```
if ConditionPassed() then
    EncodingSpecificOperations();
    sum1 = UInt(R[n]<15:0>) + UInt(R[m]<15:0>);
    sum2 = UInt(R[n]<31:16>) + UInt(R[m]<31:16>);
    R[d]<15:0> = sum1<15:0>;
    R[d]<31:16> = sum2<15:0>;
    APSR.GE<1:0> = if sum1 >= 0x10000 then '11' else '00';
    APSR.GE<3:2> = if sum2 >= 0x10000 then '11' else '00';
```

## Exceptions

None.

### A8.8.244 UADD8

Unsigned Add 8 performs four unsigned 8-bit integer additions, and writes the results to the destination register. It sets the APSR.GE bits according to the results of the additions.

#### Encoding T1 ARMv6T2, ARMv7

UADD8<c> <Rd>, <Rn>, <Rm>

15	14	13	12	11	10	9	8	7	6	5	4	3	2	1	0	15	14	13	12	11	10	9	8	7	6	5	4	3	2	1	0
1	1	1	1	1	0	1	0	1	0	0	0	Rn			1	1	1	1	Rd			0	1	0	0	Rm					

d = UInt(Rd); n = UInt(Rn); m = UInt(Rm);  
if d IN {13,15} || n IN {13,15} || m IN {13,15} then UNPREDICTABLE;

#### Encoding A1 ARMv6\*, ARMv7

UADD8<c> <Rd>, <Rn>, <Rm>

31	30	29	28	27	26	25	24	23	22	21	20	19	18	17	16	15	14	13	12	11	10	9	8	7	6	5	4	3	2	1	0
cond		0	1	1	0	0	1	0	1	Rn			Rd			(1)	(1)	(1)	(1)	1	0	0	1	Rm							

d = UInt(Rd); n = UInt(Rn); m = UInt(Rm);  
if d == 15 || n == 15 || m == 15 then UNPREDICTABLE;

## Assembler syntax

UADD8{<c>}{<q>} {<Rd>}, <Rn>, <Rm>

where:

<c>, <q> See [Standard assembler syntax fields](#) on page A8-287.

<Rd> The destination register.

<Rn> The first operand register.

<Rm> The second operand register.

## Operation

```
if ConditionPassed() then
    EncodingSpecificOperations();
    sum1 = UInt(R[n]<7:0>) + UInt(R[m]<7:0>);
    sum2 = UInt(R[n]<15:8>) + UInt(R[m]<15:8>);
    sum3 = UInt(R[n]<23:16>) + UInt(R[m]<23:16>);
    sum4 = UInt(R[n]<31:24>) + UInt(R[m]<31:24>);
    R[d]<7:0> = sum1<7:0>;
    R[d]<15:8> = sum2<7:0>;
    R[d]<23:16> = sum3<7:0>;
    R[d]<31:24> = sum4<7:0>;
    APSR.GE<0> = if sum1 >= 0x100 then '1' else '0';
    APSR.GE<1> = if sum2 >= 0x100 then '1' else '0';
    APSR.GE<2> = if sum3 >= 0x100 then '1' else '0';
    APSR.GE<3> = if sum4 >= 0x100 then '1' else '0';
```

## Exceptions

None.

### A8.8.245 UASX

Unsigned Add and Subtract with Exchange exchanges the two halfwords of the second operand, performs one unsigned 16-bit integer addition and one unsigned 16-bit subtraction, and writes the results to the destination register. It sets the APSR.GE bits according to the results.

#### Encoding T1 ARMv6T2, ARMv7

UASX<c> <Rd>, <Rn>, <Rm>

15	14	13	12	11	10	9	8	7	6	5	4	3	2	1	0	15	14	13	12	11	10	9	8	7	6	5	4	3	2	1	0
1	1	1	1	1	0	1	0	1	0	1	0	Rn				1	1	1	1	Rd				0	1	0	0	Rm			

d = UInt(Rd); n = UInt(Rn); m = UInt(Rm);  
if d IN {13,15} || n IN {13,15} || m IN {13,15} then UNPREDICTABLE;

#### Encoding A1 ARMv6\*, ARMv7

UASX<c> <Rd>, <Rn>, <Rm>

31	30	29	28	27	26	25	24	23	22	21	20	19	18	17	16	15	14	13	12	11	10	9	8	7	6	5	4	3	2	1	0
cond		0	1	1	0	0	1	0	1	Rn				Rd				(1)	(1)	(1)	(1)	0	0	1	1	Rm					

d = UInt(Rd); n = UInt(Rn); m = UInt(Rm);  
if d == 15 || n == 15 || m == 15 then UNPREDICTABLE;

## Assembler syntax

UASX{<c>}{<q>} {<Rd>}, <Rn>, <Rm>

where:

<c>, <q> See [Standard assembler syntax fields on page A8-287](#).

<Rd> The destination register.

<Rn> The first operand register.

<Rm> The second operand register.

The pre-UAL syntax UADDSUBX<c> is equivalent to UASX<c>.

## Operation

```
if ConditionPassed() then
    EncodingSpecificOperations();
    diff = UInt(R[n]<15:0>) - UInt(R[m]<31:16>);
    sum = UInt(R[n]<31:16>) + UInt(R[m]<15:0>);
    R[d]<15:0> = diff<15:0>;
    R[d]<31:16> = sum<15:0>;
    APSR.GE<1:0> = if diff >= 0 then '11' else '00';
    APSR.GE<3:2> = if sum >= 0x10000 then '11' else '00';
```

## Exceptions

None.

### A8.8.246 UBFX

Unsigned Bit Field Extract extracts any number of adjacent bits at any position from a register, zero-extends them to 32 bits, and writes the result to the destination register.

#### Encoding T1 ARMv6T2, ARMv7

UBFX<<> <Rd>, <Rn>, #<lsb>, #<width>

15	14	13	12	11	10	9	8	7	6	5	4	3	2	1	0	15	14	13	12	11	10	9	8	7	6	5	4	3	2	1	0
1	1	1	1	0	(0)	1	1	1	1	0	0	Rn				0	imm3			Rd			imm2(0)		widthm1						

d = UInt(Rd); n = UInt(Rn);  
lsbit = UInt(imm3:imm2); widthminus1 = UInt(widthm1);  
if d IN {13,15} || n IN {13,15} then UNPREDICTABLE;

#### Encoding A1 ARMv6T2, ARMv7

UBFX<<> <Rd>, <Rn>, #<lsb>, #<width>

31	30	29	28	27	26	25	24	23	22	21	20	19	18	17	16	15	14	13	12	11	10	9	8	7	6	5	4	3	2	1	0
cond		0	1	1	1	1	1	1	widthm1				Rd			lsb			1		0	1	Rn								

d = UInt(Rd); n = UInt(Rn);  
lsbit = UInt(1sb); widthminus1 = UInt(widthm1);  
if d == 15 || n == 15 then UNPREDICTABLE;



## Assembler syntax

UBFX{<c>}{<q>} <Rd>, <Rn>, #<lsb>, #<width>

where:

- <c>, <q> See [Standard assembler syntax fields on page A8-287](#).
- <Rd> The destination register.
- <Rn> The first operand register.
- <lsb> is the bit number of the least significant bit in the field, in the range 0-31. This determines the required value of `lsbit`.
- <width> is the width of the field, in the range 1 to 32-`<lsb>`. The required value of `widthminus1` is `<width>-1`.

## Operation

```
if ConditionPassed() then
    EncodingSpecificOperations();
    msbit = lsbit + widthminus1;
    if msbit <= 31 then
        R[d] = ZeroExtend(R[n]<msbit:lsbit>, 32);
    else
        UNPREDICTABLE;
```

## Exceptions

None.

## A8.8.247 UDF

Permanently Undefined generates an Undefined Instruction exception.

The encodings for UDF used in this section are defined as permanently UNDEFINED in the versions of the architecture specified in this section. Issue C.a of this manual first defines an assembler mnemonic for these encodings.

However:

- with the Thumb instruction set, ARM deprecates using the UDF instruction in an IT block
- in the ARM instruction set, UDF is not conditional.

### Encoding T1 ARMv4T, ARMv5T\*, ARMv6, ARMv7

UDF<c> #<imm8>

15	14	13	12	11	10	9	8	7	6	5	4	3	2	1	0
1	1	0	1	1	1	1	0	imm8							

imm32 = ZeroExtend(imm8, 32);

// imm32 is for assembly and disassembly only, and is ignored by hardware.

### Encoding T2 ARMv6T2, ARMv7

UDF<c>.W #<imm16>

15	14	13	12	11	10	9	8	7	6	5	4	3	2	1	0	15	14	13	12	11	10	9	8	7	6	5	4	3	2	1	0
1	1	1	1	0	1	1	1	1	1	1	1	1	imm4			1	0	1	0	imm12											

imm32 = ZeroExtend(imm4:imm12, 32);

// imm32 is for assembly and disassembly only, and is ignored by hardware.

### Encoding A1 ARMv4T, ARMv5T\*, ARMv6, ARMv7

UDF<c> #<imm16>

31	30	29	28	27	26	25	24	23	22	21	20	19	18	17	16	15	14	13	12	11	10	9	8	7	6	5	4	3	2	1	0
1	1	1	0	0	1	1	1	1	1	1	1	imm12						1	1	1	1	imm4									

imm32 = ZeroExtend(imm12:imm4, 32);

// imm32 is for assembly and disassembly only, and is ignored by hardware.

## Assembler syntax

UDF{<c>}{<q>} {#}<imm>

where:

<c>, <q> See *Standard assembler syntax fields* on page A8-287.

In the ARM instruction set, <c> must be AL or omitted.

In the Thumb instruction set, ARM deprecates using any <c> value other than AL.

<imm> Specifies an immediate constant, that is 8-bit in encoding T1, and 16-bit in encodings T2 and A1.  
The processor ignores the value of this constant.

## Operation

```
if ConditionPassed() then
    EncodingSpecificOperations();
    UNDEFINED;
```

## Exceptions

Undefined Instruction.

### A8.8.248 UDIV

Unsigned Divide divides a 32-bit unsigned integer register value by a 32-bit unsigned integer register value, and writes the result to the destination register. The condition flags are not affected.

See [ARMv7 implementation requirements and options for the divide instructions on page A4-172](#) for more information about this instruction.

**Encoding T1** ARMv7-R, ARMv7VE, otherwise OPTIONAL in ARMv7-A

UDIV<c> <Rd>, <Rn>, <Rm>

15	14	13	12	11	10	9	8	7	6	5	4	3	2	1	0	15	14	13	12	11	10	9	8	7	6	5	4	3	2	1	0
1	1	1	1	1	0	1	1	1	0	1	1			Rn	(1)	(1)	(1)	(1)		Rd		1	1	1	1			Rm			

d = UInt(Rd); n = UInt(Rn); m = UInt(Rm);  
if d IN {13,15} || n IN {13,15} || m IN {13,15} then UNPREDICTABLE;

**Encoding A1** ARMv7VE, otherwise OPTIONAL in ARMv7-A and ARMv7-R

UDIV<c> <Rd>, <Rn>, <Rm>

31	30	29	28	27	26	25	24	23	22	21	20	19	18	17	16	15	14	13	12	11	10	9	8	7	6	5	4	3	2	1	0
cond		0	1	1	1	0	0	1	1			Rd	(1)	(1)	(1)	(1)			Rm		0	0	0	1					Rn		

d = UInt(Rd); n = UInt(Rn); m = UInt(Rm);  
if d == 15 || n == 15 || m == 15 then UNPREDICTABLE;

## Assembler syntax

UDIV{<c>}{<q>} {<Rd>}, <Rn>, <Rm>

where:

<c>, <q> See [Standard assembler syntax fields](#) on page A8-287.

<Rd> The destination register.

<Rn> The register that contains the dividend.

<Rm> The register that contains the divisor.

## Operation

```
if ConditionPassed() then
    EncodingSpecificOperations();
    if UInt(R[m]) == 0 then
        if IntegerZeroDivideTrappingEnabled() then
            GenerateIntegerZeroDivide();
        else
            result = 0;
    else
        result = RoundTowardsZero(UInt(R[n]) / UInt(R[m]));
    R[d] = result<31:0>;
```

## Exceptions

In ARMv7-R profile, Undefined Instruction, see [Divide instructions](#) on page A4-172.

In ARMv7-A profile, none.

### A8.8.249 UHADD16

Unsigned Halving Add 16 performs two unsigned 16-bit integer additions, halves the results, and writes the results to the destination register.

#### Encoding T1 ARMv6T2, ARMv7

UHADD16<c> <Rd>, <Rn>, <Rm>

15	14	13	12	11	10	9	8	7	6	5	4	3	2	1	0	15	14	13	12	11	10	9	8	7	6	5	4	3	2	1	0
1	1	1	1	1	0	1	0	1	0	0	1	Rn				1	1	1	1	Rd				0	1	1	0	Rm			

d = UInt(Rd); n = UInt(Rn); m = UInt(Rm);  
if d IN {13,15} || n IN {13,15} || m IN {13,15} then UNPREDICTABLE;

#### Encoding A1 ARMv6\*, ARMv7

UHADD16<c> <Rd>, <Rn>, <Rm>

31	30	29	28	27	26	25	24	23	22	21	20	19	18	17	16	15	14	13	12	11	10	9	8	7	6	5	4	3	2	1	0
cond		0	1	1	0	0	1	1	1	Rn				Rd				(1)	(1)	(1)	(1)	0	0	0	1	Rm					

d = UInt(Rd); n = UInt(Rn); m = UInt(Rm);  
if d == 15 || n == 15 || m == 15 then UNPREDICTABLE;

## Assembler syntax

UHADD16{<c>}{<q>} {<Rd>}, <Rn>, <Rm>

where:

<c>, <q> See *Standard assembler syntax fields* on page A8-287.

<Rd> The destination register.

<Rn> The first operand register.

<Rm> The second operand register.

## Operation

```
if ConditionPassed() then
    EncodingSpecificOperations();
    sum1 = UInt(R[n]<15:0>) + UInt(R[m]<15:0>);
    sum2 = UInt(R[n]<31:16>) + UInt(R[m]<31:16>);
    R[d]<15:0> = sum1<16:1>;
    R[d]<31:16> = sum2<16:1>;
```

## Exceptions

None.

### A8.8.250 UHADD8

Unsigned Halving Add 8 performs four unsigned 8-bit integer additions, halves the results, and writes the results to the destination register.

**Encoding T1** ARMv6T2, ARMv7

UHADD8<c> <Rd>, <Rn>, <Rm>

15	14	13	12	11	10	9	8	7	6	5	4	3	2	1	0	15	14	13	12	11	10	9	8	7	6	5	4	3	2	1	0
1	1	1	1	1	0	1	0	1	0	0	0	Rn			1	1	1	1	Rd			0	1	1	0	Rm					

d = UInt(Rd); n = UInt(Rn); m = UInt(Rm);  
if d IN {13,15} || n IN {13,15} || m IN {13,15} then UNPREDICTABLE;

**Encoding A1** ARMv6\*, ARMv7

UHADD8<c> <Rd>, <Rn>, <Rm>

31	30	29	28	27	26	25	24	23	22	21	20	19	18	17	16	15	14	13	12	11	10	9	8	7	6	5	4	3	2	1	0
cond		0	1	1	0	0	1	1	1	Rn			Rd			(1)	(1)	(1)	(1)	1	0	0	1	Rm							

d = UInt(Rd); n = UInt(Rn); m = UInt(Rm);  
if d == 15 || n == 15 || m == 15 then UNPREDICTABLE;



## Assembler syntax

UHADD8{<c>}{<q>} {<Rd>}, <Rn>, <Rm>

where:

<c>, <q> See *Standard assembler syntax fields* on page A8-287.

<Rd> The destination register.

<Rn> The first operand register.

<Rm> The second operand register.

## Operation

```
if ConditionPassed() then
    EncodingSpecificOperations();
    sum1 = UInt(R[n]<7:0>) + UInt(R[m]<7:0>);
    sum2 = UInt(R[n]<15:8>) + UInt(R[m]<15:8>);
    sum3 = UInt(R[n]<23:16>) + UInt(R[m]<23:16>);
    sum4 = UInt(R[n]<31:24>) + UInt(R[m]<31:24>);
    R[d]<7:0> = sum1<8:1>;
    R[d]<15:8> = sum2<8:1>;
    R[d]<23:16> = sum3<8:1>;
    R[d]<31:24> = sum4<8:1>;
```

## Exceptions

None.

### A8.8.251 UHASX

Unsigned Halving Add and Subtract with Exchange exchanges the two halfwords of the second operand, performs one unsigned 16-bit integer addition and one unsigned 16-bit subtraction, halves the results, and writes the results to the destination register.

**Encoding T1** ARMv6T2, ARMv7

UHASX<c> <Rd>, <Rn>, <Rm>

15	14	13	12	11	10	9	8	7	6	5	4	3	2	1	0	15	14	13	12	11	10	9	8	7	6	5	4	3	2	1	0
1	1	1	1	1	0	1	0	1	0	1	0	Rn				1	1	1	1	Rd				0	1	1	0	Rm			

d = UInt(Rd); n = UInt(Rn); m = UInt(Rm);  
if d IN {13,15} || n IN {13,15} || m IN {13,15} then UNPREDICTABLE;

**Encoding A1** ARMv6\*, ARMv7

UHASX<c> <Rd>, <Rn>, <Rm>

31	30	29	28	27	26	25	24	23	22	21	20	19	18	17	16	15	14	13	12	11	10	9	8	7	6	5	4	3	2	1	0
cond		0	1	1	0	0	1	1	1	Rn				Rd				(1)	(1)	(1)	(1)	0	0	1	1	Rm					

d = UInt(Rd); n = UInt(Rn); m = UInt(Rm);  
if d == 15 || n == 15 || m == 15 then UNPREDICTABLE;

## Assembler syntax

UHASX{<c>}{<q>} {<Rd>}, <Rn>, <Rm>

where:

<c>, <q> See [Standard assembler syntax fields on page A8-287](#).

<Rd> The destination register.

<Rn> The first operand register.

<Rm> The second operand register.

The pre-UAL syntax UHADDSUBX<c> is equivalent to UHASX<c>.

## Operation

```
if ConditionPassed() then
    EncodingSpecificOperations();
    diff = UInt(R[n]<15:0>) - UInt(R[m]<31:16>);
    sum = UInt(R[n]<31:16>) + UInt(R[m]<15:0>);
    R[d]<15:0> = diff<16:1>;
    R[d]<31:16> = sum<16:1>;
```

## Exceptions

None.

### A8.8.252 UHSAX

Unsigned Halving Subtract and Add with Exchange exchanges the two halfwords of the second operand, performs one unsigned 16-bit integer subtraction and one unsigned 16-bit addition, halves the results, and writes the results to the destination register.

#### Encoding T1 ARMv6T2, ARMv7

UHSAX<c> <Rd>, <Rn>, <Rm>

15	14	13	12	11	10	9	8	7	6	5	4	3	2	1	0	15	14	13	12	11	10	9	8	7	6	5	4	3	2	1	0
1	1	1	1	1	0	1	0	1	1	1	0	Rn				1	1	1	1	Rd				0	1	1	0	Rm			

d = UInt(Rd); n = UInt(Rn); m = UInt(Rm);  
if d IN {13,15} || n IN {13,15} || m IN {13,15} then UNPREDICTABLE;

#### Encoding A1 ARMv6\*, ARMv7

UHSAX<c> <Rd>, <Rn>, <Rm>

31	30	29	28	27	26	25	24	23	22	21	20	19	18	17	16	15	14	13	12	11	10	9	8	7	6	5	4	3	2	1	0
cond		0	1	1	0	0	1	1	1	Rn				Rd				(1)	(1)	(1)	(1)	0	1	0	1	Rm					

d = UInt(Rd); n = UInt(Rn); m = UInt(Rm);  
if d == 15 || n == 15 || m == 15 then UNPREDICTABLE;

## Assembler syntax

UHSAX{<c>}{<q>} {<Rd>}, <Rn>, <Rm>

where:

<c>, <q> See *Standard assembler syntax fields* on page A8-287.

<Rd> The destination register.

<Rn> The first operand register.

<Rm> The second operand register.

The pre-UAL syntax UHSUBADDX<c> is equivalent to UHSAX<c>.

## Operation

```
if ConditionPassed() then
    EncodingSpecificOperations();
    sum = UInt(R[n]<15:0>) + UInt(R[m]<31:16>);
    diff = UInt(R[n]<31:16>) - UInt(R[m]<15:0>);
    R[d]<15:0> = sum<16:1>;
    R[d]<31:16> = diff<16:1>;
```

## Exceptions

None.

### A8.8.253 UHSUB16

Unsigned Halving Subtract 16 performs two unsigned 16-bit integer subtractions, halves the results, and writes the results to the destination register.

#### Encoding T1 ARMv6T2, ARMv7

UHSUB16<c> <Rd>, <Rn>, <Rm>

15	14	13	12	11	10	9	8	7	6	5	4	3	2	1	0	15	14	13	12	11	10	9	8	7	6	5	4	3	2	1	0
1	1	1	1	1	0	1	0	1	1	0	1	Rn			1	1	1	1	Rd			0	1	1	0	Rm					

d = UInt(Rd); n = UInt(Rn); m = UInt(Rm);  
if d IN {13,15} || n IN {13,15} || m IN {13,15} then UNPREDICTABLE;

#### Encoding A1 ARMv6\*, ARMv7

UHSUB16<c> <Rd>, <Rn>, <Rm>

31	30	29	28	27	26	25	24	23	22	21	20	19	18	17	16	15	14	13	12	11	10	9	8	7	6	5	4	3	2	1	0
cond		0	1	1	0	0	1	1	1	Rn			Rd			(1)	(1)	(1)	(1)	0	1	1	1	Rm							

d = UInt(Rd); n = UInt(Rn); m = UInt(Rm);  
if d == 15 || n == 15 || m == 15 then UNPREDICTABLE;

## Assembler syntax

UHSUB16{<c>}{<q>} {<Rd>}, <Rn>, <Rm>

where:

<c>, <q> See *Standard assembler syntax fields* on page A8-287.

<Rd> The destination register.

<Rn> The first operand register.

<Rm> The second operand register.

## Operation

```
if ConditionPassed() then
    EncodingSpecificOperations();
    diff1 = UInt(R[n]<15:0>) - UInt(R[m]<15:0>);
    diff2 = UInt(R[n]<31:16>) - UInt(R[m]<31:16>);
    R[d]<15:0> = diff1<16:1>;
    R[d]<31:16> = diff2<16:1>;
```

## Exceptions

None.

### A8.8.254 UHSUB8

Unsigned Halving Subtract 8 performs four unsigned 8-bit integer subtractions, halves the results, and writes the results to the destination register.

**Encoding T1** ARMv6T2, ARMv7

UHSUB8<c> <Rd>, <Rn>, <Rm>

15	14	13	12	11	10	9	8	7	6	5	4	3	2	1	0	15	14	13	12	11	10	9	8	7	6	5	4	3	2	1	0
1	1	1	1	1	0	1	0	1	1	0	0	Rn			1	1	1	1	Rd			0	1	1	0	Rm					

d = UInt(Rd); n = UInt(Rn); m = UInt(Rm);  
if d IN {13,15} || n IN {13,15} || m IN {13,15} then UNPREDICTABLE;

**Encoding A1** ARMv6\*, ARMv7

UHSUB8<c> <Rd>, <Rn>, <Rm>

31	30	29	28	27	26	25	24	23	22	21	20	19	18	17	16	15	14	13	12	11	10	9	8	7	6	5	4	3	2	1	0
cond		0	1	1	0	0	1	1	1	Rn			Rd			(1)	(1)	(1)	(1)	1	1	1	1	Rm							

d = UInt(Rd); n = UInt(Rn); m = UInt(Rm);  
if d == 15 || n == 15 || m == 15 then UNPREDICTABLE;



## Assembler syntax

UHSUB8{<c>}{<q>} {<Rd>}, <Rn>, <Rm>

where:

<c>, <q> See *Standard assembler syntax fields* on page A8-287.

<Rd> The destination register.

<Rn> The first operand register.

<Rm> The second operand register.

## Operation

```
if ConditionPassed() then
    EncodingSpecificOperations();
    diff1 = UInt(R[n]<7:0>) - UInt(R[m]<7:0>);
    diff2 = UInt(R[n]<15:8>) - UInt(R[m]<15:8>);
    diff3 = UInt(R[n]<23:16>) - UInt(R[m]<23:16>);
    diff4 = UInt(R[n]<31:24>) - UInt(R[m]<31:24>);
    R[d]<7:0> = diff1<8:1>;
    R[d]<15:8> = diff2<8:1>;
    R[d]<23:16> = diff3<8:1>;
    R[d]<31:24> = diff4<8:1>;
```

## Exceptions

None.

### A8.8.255 UMAAL

Unsigned Multiply Accumulate Accumulate Long multiplies two unsigned 32-bit values to produce a 64-bit value, adds two unsigned 32-bit values, and writes the 64-bit result to two registers.

#### Encoding T1 ARMv6T2, ARMv7

UMAAL<c> <RdLo>, <RdHi>, <Rn>, <Rm>

15	14	13	12	11	10	9	8	7	6	5	4	3	2	1	0	15	14	13	12	11	10	9	8	7	6	5	4	3	2	1	0
1	1	1	1	1	0	1	1	1	1	1	0	Rn				RdLo				RdHi				0	1	1	0	Rm			

dLo = UInt(RdLo); dHi = UInt(RdHi); n = UInt(Rn); m = UInt(Rm);  
if dLo IN {13,15} || dHi IN {13,15} || n IN {13,15} || m IN {13,15} then UNPREDICTABLE;  
if dHi == dLo then UNPREDICTABLE;

#### Encoding A1 ARMv6\*, ARMv7

UMAAL<c> <RdLo>, <RdHi>, <Rn>, <Rm>

31	30	29	28	27	26	25	24	23	22	21	20	19	18	17	16	15	14	13	12	11	10	9	8	7	6	5	4	3	2	1	0
cond				0	0	0	0	0	1	0	0	RdHi				RdLo				Rm				1	0	0	1	Rn			

dLo = UInt(RdLo); dHi = UInt(RdHi); n = UInt(Rn); m = UInt(Rm);  
if dLo == 15 || dHi == 15 || n == 15 || m == 15 then UNPREDICTABLE;  
if dHi == dLo then UNPREDICTABLE;

## Assembler syntax

UMAAL{<c>}{<q>} <RdLo>, <RdHi>, <Rn>, <Rm>

where:

- <c>, <q> See *Standard assembler syntax fields* on page A8-287.
- <RdLo> Supplies one of the 32-bit values to be added, and is the destination register for the lower 32 bits of the result.
- <RdHi> Supplies the other of the 32-bit values to be added, and is the destination register for the upper 32 bits of the result.
- <Rn> The register that contains the first multiply operand.
- <Rm> The register that contains the second multiply operand.

## Operation

```
if ConditionPassed() then
    EncodingSpecificOperations();
    result = UInt(R[n]) * UInt(R[m]) + UInt(R[dHi]) + UInt(R[dLo]);
    R[dHi] = result<63:32>;
    R[dLo] = result<31:0>;
```

## Exceptions

None.

### A8.8.256 UMLAL

Unsigned Multiply Accumulate Long multiplies two unsigned 32-bit values to produce a 64-bit value, and accumulates this with a 64-bit value.

In ARM instructions, the condition flags can optionally be updated based on the result. Use of this option adversely affects performance on many processor implementations.

#### Encoding T1 ARMv6T2, ARMv7

UMLAL<C> <RdLo>, <RdHi>, <Rn>, <Rm>

15	14	13	12	11	10	9	8	7	6	5	4	3	2	1	0	15	14	13	12	11	10	9	8	7	6	5	4	3	2	1	0
1	1	1	1	1	0	1	1	1	1	1	0	Rn				RdLo				RdHi				0 0 0 0				Rm			

dLo = UInt(RdLo); dHi = UInt(RdHi); n = UInt(Rn); m = UInt(Rm); setflags = FALSE;  
if dLo IN {13,15} || dHi IN {13,15} || n IN {13,15} || m IN {13,15} then UNPREDICTABLE;  
if dHi == dLo then UNPREDICTABLE;

#### Encoding A1 ARMv4\*, ARMv5T\*, ARMv6\*, ARMv7

UMLAL{S}<C> <RdLo>, <RdHi>, <Rn>, <Rm>

31	30	29	28	27	26	25	24	23	22	21	20	19	18	17	16	15	14	13	12	11	10	9	8	7	6	5	4	3	2	1	0
cond				0 0 0 0 1 0 1				S	RdHi				RdLo				Rm				1 0 0 1				Rn						

dLo = UInt(RdLo); dHi = UInt(RdHi); n = UInt(Rn); m = UInt(Rm); setflags = (S == '1');  
if dLo == 15 || dHi == 15 || n == 15 || m == 15 then UNPREDICTABLE;  
if dHi == dLo then UNPREDICTABLE;  
if ArchVersion() < 6 && (dHi == n || dLo == n) then UNPREDICTABLE;

## Assembler syntax

UMLAL{S}{<c>}{<q>} <RdLo>, <RdHi>, <Rn>, <Rm>

where:

- S            If S is present, the instruction updates the flags. Otherwise, the flags are not updated.  
S can be specified only for the ARM instruction set.
- <c>, <q>     See *Standard assembler syntax fields* on page A8-287.
- <RdLo>      Supplies the lower 32 bits of the accumulate value, and is the destination register for the lower 32 bits of the result.
- <RdHi>      Supplies the upper 32 bits of the accumulate value, and is the destination register for the upper 32 bits of the result.
- <Rn>        The first operand register.
- <Rm>        The second operand register.

The pre-UAL syntax UMLAL<c>S is equivalent to UMLALS<c>.

## Operation

```

if ConditionPassed() then
    EncodingSpecificOperations();
    result = UInt(R[n]) * UInt(R[m]) + UInt(R[dHi]:R[dLo]);
    R[dHi] = result<63:32>;
    R[dLo] = result<31:0>;
    if setflags then
        APSR.N = result<63>;
        APSR.Z = IsZeroBit(result<63:0>);
        if ArchVersion() == 4 then
            APSR.C = bit UNKNOWN;
            APSR.V = bit UNKNOWN;
        // else APSR.C, APSR.V unchanged

```

## Exceptions

None.

### A8.8.257 UMULL

Unsigned Multiply Long multiplies two 32-bit unsigned values to produce a 64-bit result.

In ARM instructions, the condition flags can optionally be updated based on the result. Use of this option adversely affects performance on many processor implementations.

#### Encoding T1 ARMv6T2, ARMv7

UMULL<C> <RdLo>, <RdHi>, <Rn>, <Rm>

15	14	13	12	11	10	9	8	7	6	5	4	3	2	1	0	15	14	13	12	11	10	9	8	7	6	5	4	3	2	1	0
1	1	1	1	1	0	1	1	1	0	1	0	Rn				RdLo				RdHi				0 0 0 0				Rm			

```
dLo = UInt(RdLo); dHi = UInt(RdHi); n = UInt(Rn); m = UInt(Rm); setFlags = FALSE;
if dLo IN {13,15} || dHi IN {13,15} || n IN {13,15} || m IN {13,15} then UNPREDICTABLE;
if dHi == dLo then UNPREDICTABLE;
```

#### Encoding A1 ARMv4\*, ARMv5T\*, ARMv6\*, ARMv7

UMULL{S}<C> <RdLo>, <RdHi>, <Rn>, <Rm>

31	30	29	28	27	26	25	24	23	22	21	20	19	18	17	16	15	14	13	12	11	10	9	8	7	6	5	4	3	2	1	0
cond		0 0 0 0				1 0 0		S	RdHi				RdLo				Rm				1 0 0 1				Rn						

```
dLo = UInt(RdLo); dHi = UInt(RdHi); n = UInt(Rn); m = UInt(Rm); setFlags = (S == '1');
if dLo == 15 || dHi == 15 || n == 15 || m == 15 then UNPREDICTABLE;
if dHi == dLo then UNPREDICTABLE;
if ArchVersion() < 6 && (dHi == n || dLo == n) then UNPREDICTABLE;
```

## Assembler syntax

UMULL{S}{<c>}{<q>} <RdLo>, <RdHi>, <Rn>, <Rm>

where:

S            If S is present, the instruction updates the flags. Otherwise, the flags are not updated.  
S can be specified only for the ARM instruction set.

<c>, <q>     See *Standard assembler syntax fields* on page A8-287.

<RdLo>      Stores the lower 32 bits of the result.

<RdHi>      Stores the upper 32 bits of the result.

<Rn>        The first operand register.

<Rm>        The second operand register.

The pre-UAL syntax UMULL<c>S is equivalent to UMULLS<c>.

## Operation

```
if ConditionPassed() then
    EncodingSpecificOperations();
    result = UInt(R[n]) * UInt(R[m]);
    R[dHi] = result<63:32>;
    R[dLo] = result<31:0>;
    if setflags then
        APSR.N = result<63>;
        APSR.Z = IsZeroBit(result<63:0>);
        if ArchVersion() == 4 then
            APSR.C = bit UNKNOWN;
            APSR.V = bit UNKNOWN;
        // else APSR.C, APSR.V unchanged
```

## Exceptions

None.

### A8.8.258 UQADD16

Unsigned Saturating Add 16 performs two unsigned 16-bit integer additions, saturates the results to the 16-bit unsigned integer range  $0 \leq x \leq 2^{16} - 1$ , and writes the results to the destination register.

#### Encoding T1 ARMv6T2, ARMv7

UQADD16<c> <Rd>, <Rn>, <Rm>

15	14	13	12	11	10	9	8	7	6	5	4	3	2	1	0	15	14	13	12	11	10	9	8	7	6	5	4	3	2	1	0
1	1	1	1	1	0	1	0	1	0	0	1	Rn			1	1	1	1	Rd			0	1	0	1	Rm					

d = UInt(Rd); n = UInt(Rn); m = UInt(Rm);  
if d IN {13,15} || n IN {13,15} || m IN {13,15} then UNPREDICTABLE;

#### Encoding A1 ARMv6\*, ARMv7

UQADD16<c> <Rd>, <Rn>, <Rm>

31	30	29	28	27	26	25	24	23	22	21	20	19	18	17	16	15	14	13	12	11	10	9	8	7	6	5	4	3	2	1	0
cond		0	1	1	0	0	1	1	0	Rn			Rd			(1)	(1)	(1)	(1)	0	0	0	1	Rm							

d = UInt(Rd); n = UInt(Rn); m = UInt(Rm);  
if d == 15 || n == 15 || m == 15 then UNPREDICTABLE;



## Assembler syntax

UQADD16{<c>}{<q>} {<Rd>}, <Rn>, <Rm>

where:

<c>, <q> See *Standard assembler syntax fields* on page A8-287.

<Rd> The destination register.

<Rn> The first operand register.

<Rm> The second operand register.

## Operation

```
if ConditionPassed() then
    EncodingSpecificOperations();
    sum1 = UInt(R[n]<15:0>) + UInt(R[m]<15:0>);
    sum2 = UInt(R[n]<31:16>) + UInt(R[m]<31:16>);
    R[d]<15:0> = UnsignedSat(sum1, 16);
    R[d]<31:16> = UnsignedSat(sum2, 16);
```

## Exceptions

None.

### A8.8.259 UQADD8

Unsigned Saturating Add 8 performs four unsigned 8-bit integer additions, saturates the results to the 8-bit unsigned integer range  $0 \leq x \leq 2^8 - 1$ , and writes the results to the destination register.

**Encoding T1** ARMv6T2, ARMv7

UQADD8<c> <Rd>, <Rn>, <Rm>

15	14	13	12	11	10	9	8	7	6	5	4	3	2	1	0	15	14	13	12	11	10	9	8	7	6	5	4	3	2	1	0
1	1	1	1	1	0	1	0	1	0	0	0	Rn			1	1	1	1	Rd			0	1	0	1	Rm					

d = UInt(Rd); n = UInt(Rn); m = UInt(Rm);  
if d IN {13,15} || n IN {13,15} || m IN {13,15} then UNPREDICTABLE;

**Encoding A1** ARMv6\*, ARMv7

UQADD8<c> <Rd>, <Rn>, <Rm>

31	30	29	28	27	26	25	24	23	22	21	20	19	18	17	16	15	14	13	12	11	10	9	8	7	6	5	4	3	2	1	0
cond		0	1	1	0	0	1	1	0	Rn			Rd			(1)	(1)	(1)	(1)	1	0	0	1	Rm							

d = UInt(Rd); n = UInt(Rn); m = UInt(Rm);  
if d == 15 || n == 15 || m == 15 then UNPREDICTABLE;

## Assembler syntax

UQADD8{<c>}{<q>} {<Rd>}, <Rn>, <Rm>

where:

<c>, <q> See *Standard assembler syntax fields* on page A8-287.

<Rd> The destination register.

<Rn> The first operand register.

<Rm> The second operand register.

## Operation

```
if ConditionPassed() then
    EncodingSpecificOperations();
    sum1 = UInt(R[n]<7:0>) + UInt(R[m]<7:0>);
    sum2 = UInt(R[n]<15:8>) + UInt(R[m]<15:8>);
    sum3 = UInt(R[n]<23:16>) + UInt(R[m]<23:16>);
    sum4 = UInt(R[n]<31:24>) + UInt(R[m]<31:24>);
    R[d]<7:0> = UnsignedSat(sum1, 8);
    R[d]<15:8> = UnsignedSat(sum2, 8);
    R[d]<23:16> = UnsignedSat(sum3, 8);
    R[d]<31:24> = UnsignedSat(sum4, 8);
```

## Exceptions

None.

### A8.8.260 UQASX

Unsigned Saturating Add and Subtract with Exchange exchanges the two halfwords of the second operand, performs one unsigned 16-bit integer addition and one unsigned 16-bit subtraction, saturates the results to the 16-bit unsigned integer range  $0 \leq x \leq 2^{16} - 1$ , and writes the results to the destination register.

**Encoding T1** ARMv6T2, ARMv7

UQASX<c> <Rd>, <Rn>, <Rm>

15	14	13	12	11	10	9	8	7	6	5	4	3	2	1	0	15	14	13	12	11	10	9	8	7	6	5	4	3	2	1	0
1	1	1	1	1	0	1	0	1	0	1	0	Rn				1	1	1	1	Rd				0	1	0	1	Rm			

d = UInt(Rd); n = UInt(Rn); m = UInt(Rm);  
if d IN {13,15} || n IN {13,15} || m IN {13,15} then UNPREDICTABLE;

**Encoding A1** ARMv6\*, ARMv7

UQASX<c> <Rd>, <Rn>, <Rm>

31	30	29	28	27	26	25	24	23	22	21	20	19	18	17	16	15	14	13	12	11	10	9	8	7	6	5	4	3	2	1	0
cond				0	1	1	0	0	1	1	0	Rn				Rd				(1)	(1)	(1)	(1)	0	0	1	1	Rm			

d = UInt(Rd); n = UInt(Rn); m = UInt(Rm);  
if d == 15 || n == 15 || m == 15 then UNPREDICTABLE;

## Assembler syntax

UQASX{<c>}{<q>} {<Rd>}, <Rn>, <Rm>

where:

<c>, <q> See *Standard assembler syntax fields* on page A8-287.

<Rd> The destination register.

<Rn> The first operand register.

<Rm> The second operand register.

The pre-UAL syntax UQADDSUBX<c> is equivalent to UQASX<c>.

## Operation

```
if ConditionPassed() then
    EncodingSpecificOperations();
    diff = UInt(R[n]<15:0>) - UInt(R[m]<31:16>);
    sum = UInt(R[n]<31:16>) + UInt(R[m]<15:0>);
    R[d]<15:0> = UnsignedSat(diff, 16);
    R[d]<31:16> = UnsignedSat(sum, 16);
```

## Exceptions

None.

### A8.8.261 UQSAX

Unsigned Saturating Subtract and Add with Exchange exchanges the two halfwords of the second operand, performs one unsigned 16-bit integer subtraction and one unsigned 16-bit addition, saturates the results to the 16-bit unsigned integer range  $0 \leq x \leq 2^{16} - 1$ , and writes the results to the destination register.

**Encoding T1** ARMv6T2, ARMv7

UQSAX<c> <Rd>, <Rn>, <Rm>

15	14	13	12	11	10	9	8	7	6	5	4	3	2	1	0	15	14	13	12	11	10	9	8	7	6	5	4	3	2	1	0
1	1	1	1	1	0	1	0	1	1	1	0	Rn				1	1	1	1	Rd				0	1	0	1	Rm			

d = UInt(Rd); n = UInt(Rn); m = UInt(Rm);  
if d IN {13,15} || n IN {13,15} || m IN {13,15} then UNPREDICTABLE;

**Encoding A1** ARMv6\*, ARMv7

UQSAX<c> <Rd>, <Rn>, <Rm>

31	30	29	28	27	26	25	24	23	22	21	20	19	18	17	16	15	14	13	12	11	10	9	8	7	6	5	4	3	2	1	0
cond		0	1	1	0	0	1	1	0	Rn				Rd				(1)	(1)	(1)	(1)	0	1	0	1	Rm					

d = UInt(Rd); n = UInt(Rn); m = UInt(Rm);  
if d == 15 || n == 15 || m == 15 then UNPREDICTABLE;

## Assembler syntax

UQSAX{<c>}{<q>} {<Rd>}, <Rn>, <Rm>

where:

<c>, <q> See *Standard assembler syntax fields* on page A8-287.

<Rd> The destination register.

<Rn> The first operand register.

<Rm> The second operand register.

The pre-UAL syntax UQSUBADDX<c> is equivalent to UQSAX<c>.

## Operation

```
if ConditionPassed() then
    EncodingSpecificOperations();
    sum = UInt(R[n]<15:0>) + UInt(R[m]<31:16>);
    diff = UInt(R[n]<31:16>) - UInt(R[m]<15:0>);
    R[d]<15:0> = UnsignedSat(sum, 16);
    R[d]<31:16> = UnsignedSat(diff, 16);
```

## Exceptions

None.

### A8.8.262 UQSUB16

Unsigned Saturating Subtract 16 performs two unsigned 16-bit integer subtractions, saturates the results to the 16-bit unsigned integer range  $0 \leq x \leq 2^{16} - 1$ , and writes the results to the destination register.

**Encoding T1** ARMv6T2, ARMv7

UQSUB16<c> <Rd>, <Rn>, <Rm>

15	14	13	12	11	10	9	8	7	6	5	4	3	2	1	0	15	14	13	12	11	10	9	8	7	6	5	4	3	2	1	0
1	1	1	1	1	0	1	0	1	1	0	1	Rn			1	1	1	1	Rd			0	1	0	1	Rm					

d = UInt(Rd); n = UInt(Rn); m = UInt(Rm);  
if d IN {13,15} || n IN {13,15} || m IN {13,15} then UNPREDICTABLE;

**Encoding A1** ARMv6\*, ARMv7

UQSUB16<c> <Rd>, <Rn>, <Rm>

31	30	29	28	27	26	25	24	23	22	21	20	19	18	17	16	15	14	13	12	11	10	9	8	7	6	5	4	3	2	1	0
cond		0	1	1	0	0	1	1	0	Rn			Rd			(1)	(1)	(1)	(1)	0	1	1	1	Rm							

d = UInt(Rd); n = UInt(Rn); m = UInt(Rm);  
if d == 15 || n == 15 || m == 15 then UNPREDICTABLE;



## Assembler syntax

UQSUB16{<c>}{<q>} {<Rd>}, <Rn>, <Rm>

where:

<c>, <q> See [Standard assembler syntax fields on page A8-287](#).

<Rd> The destination register.

<Rn> The first operand register.

<Rm> The second operand register.

## Operation

```
if ConditionPassed() then
    EncodingSpecificOperations();
    diff1 = UInt(R[n]<15:0>) - UInt(R[m]<15:0>);
    diff2 = UInt(R[n]<31:16>) - UInt(R[m]<31:16>);
    R[d]<15:0> = UnsignedSat(diff1, 16);
    R[d]<31:16> = UnsignedSat(diff2, 16);
```

## Exceptions

None.

### A8.8.263 UQSUB8

Unsigned Saturating Subtract 8 performs four unsigned 8-bit integer subtractions, saturates the results to the 8-bit unsigned integer range  $0 \leq x \leq 2^8 - 1$ , and writes the results to the destination register.

#### Encoding T1 ARMv6T2, ARMv7

UQSUB8<c> <Rd>, <Rn>, <Rm>

15	14	13	12	11	10	9	8	7	6	5	4	3	2	1	0	15	14	13	12	11	10	9	8	7	6	5	4	3	2	1	0
1	1	1	1	1	0	1	0	1	1	0	0	Rn			1	1	1	1	Rd			0	1	0	1	Rm					

d = UInt(Rd); n = UInt(Rn); m = UInt(Rm);  
if d IN {13,15} || n IN {13,15} || m IN {13,15} then UNPREDICTABLE;

#### Encoding A1 ARMv6\*, ARMv7

UQSUB8<c> <Rd>, <Rn>, <Rm>

31	30	29	28	27	26	25	24	23	22	21	20	19	18	17	16	15	14	13	12	11	10	9	8	7	6	5	4	3	2	1	0
cond		0	1	1	0	0	1	1	0	Rn			Rd			(1)	(1)	(1)	(1)	1	1	1	1	Rm							

d = UInt(Rd); n = UInt(Rn); m = UInt(Rm);  
if d == 15 || n == 15 || m == 15 then UNPREDICTABLE;

## Assembler syntax

UQSUB8{<C>}{<q>} {<Rd>}, <Rn>, <Rm>

where:

<C>, <q> See [Standard assembler syntax fields on page A8-287](#).

<Rd> The destination register.

<Rn> The first operand register.

<Rm> The second operand register.

## Operation

```
if ConditionPassed() then
    EncodingSpecificOperations();
    diff1 = UInt(R[n]<7:0>) - UInt(R[m]<7:0>);
    diff2 = UInt(R[n]<15:8>) - UInt(R[m]<15:8>);
    diff3 = UInt(R[n]<23:16>) - UInt(R[m]<23:16>);
    diff4 = UInt(R[n]<31:24>) - UInt(R[m]<31:24>);
    R[d]<7:0> = UnsignedSat(diff1, 8);
    R[d]<15:8> = UnsignedSat(diff2, 8);
    R[d]<23:16> = UnsignedSat(diff3, 8);
    R[d]<31:24> = UnsignedSat(diff4, 8);
```

## Exceptions

None.

### A8.8.264 USAD8

Unsigned Sum of Absolute Differences performs four unsigned 8-bit subtractions, and adds the absolute values of the differences together.

**Encoding T1** ARMv6T2, ARMv7

USAD8<c> <Rd>, <Rn>, <Rm>

15	14	13	12	11	10	9	8	7	6	5	4	3	2	1	0	15	14	13	12	11	10	9	8	7	6	5	4	3	2	1	0
1	1	1	1	1	0	1	1	0	1	1	1	Rn	1	1	1	1	Rd	0	0	0	0	Rm									

d = UInt(Rd); n = UInt(Rn); m = UInt(Rm);  
if d IN {13,15} || n IN {13,15} || m IN {13,15} then UNPREDICTABLE;

**Encoding A1** ARMv6\*, ARMv7

USAD8<c> <Rd>, <Rn>, <Rm>

31	30	29	28	27	26	25	24	23	22	21	20	19	18	17	16	15	14	13	12	11	10	9	8	7	6	5	4	3	2	1	0
cond	0	1	1	1	1	0	0	0	Rd	1	1	1	1	Rm	0	0	0	1	Rn												

d = UInt(Rd); n = UInt(Rn); m = UInt(Rm);  
if d == 15 || n == 15 || m == 15 then UNPREDICTABLE;

## Assembler syntax

USAD8{<c>}{<q>} {<Rd>}, <Rn>, <Rm>

where:

<c>, <q> See [Standard assembler syntax fields on page A8-287](#).

<Rd> The destination register.

<Rn> The first operand register.

<Rm> The second operand register.

## Operation

```
if ConditionPassed() then
    EncodingSpecificOperations();
    absdiff1 = Abs(UInt(R[n]<7:0>) - UInt(R[m]<7:0>));
    absdiff2 = Abs(UInt(R[n]<15:8>) - UInt(R[m]<15:8>));
    absdiff3 = Abs(UInt(R[n]<23:16>) - UInt(R[m]<23:16>));
    absdiff4 = Abs(UInt(R[n]<31:24>) - UInt(R[m]<31:24>));
    result = absdiff1 + absdiff2 + absdiff3 + absdiff4;
    R[d] = result<31:0>;
```

## Exceptions

None.

### A8.8.265 USADA8

Unsigned Sum of Absolute Differences and Accumulate performs four unsigned 8-bit subtractions, and adds the absolute values of the differences to a 32-bit accumulate operand.

#### Encoding T1 ARMv6T2, ARMv7

USADA8<c> <Rd>, <Rn>, <Rm>, <Ra>

15	14	13	12	11	10	9	8	7	6	5	4	3	2	1	0	15	14	13	12	11	10	9	8	7	6	5	4	3	2	1	0
1	1	1	1	1	0	1	1	0	1	1	1	Rn			Ra			Rd			0	0	0	0	Rm						

if Ra == '1111' then SEE USAD8;  
d = UInt(Rd); n = UInt(Rn); m = UInt(Rm); a = UInt(Ra);  
if d IN {13,15} || n IN {13,15} || m IN {13,15} || a == 13 then UNPREDICTABLE;

#### Encoding A1 ARMv6\*, ARMv7

USADA8<c> <Rd>, <Rn>, <Rm>, <Ra>

31	30	29	28	27	26	25	24	23	22	21	20	19	18	17	16	15	14	13	12	11	10	9	8	7	6	5	4	3	2	1	0
cond		0	1	1	1	1	0	0	0	Rd			Ra			Rm			0	0	0	1	Rn								

if Ra == '1111' then SEE USAD8;  
d = UInt(Rd); n = UInt(Rn); m = UInt(Rm); a = UInt(Ra);  
if d == 15 || n == 15 || m == 15 then UNPREDICTABLE;

## Assembler syntax

USADA8{<c>}{<q>} <Rd>, <Rn>, <Rm>, <Ra>

where:

- <c>, <q> See *Standard assembler syntax fields* on page A8-287.
- <Rd> The destination register.
- <Rn> The first operand register.
- <Rm> The second operand register.
- <Ra> The register that contains the accumulation value.

## Operation

```
if ConditionPassed() then
    EncodingSpecificOperations();
    absdiff1 = Abs(UInt(R[n]<7:0>) - UInt(R[m]<7:0>));
    absdiff2 = Abs(UInt(R[n]<15:8>) - UInt(R[m]<15:8>));
    absdiff3 = Abs(UInt(R[n]<23:16>) - UInt(R[m]<23:16>));
    absdiff4 = Abs(UInt(R[n]<31:24>) - UInt(R[m]<31:24>));
    result = UInt(R[a]) + absdiff1 + absdiff2 + absdiff3 + absdiff4;
    R[d] = result<31:0>;
```

## Exceptions

None.

### A8.8.266 USAT

Unsigned Saturate saturates an optionally-shifted signed value to a selected unsigned range.

The Q flag is set if the operation saturates.

#### Encoding T1 ARMv6T2, ARMv7

USAT<c> <Rd>, #<imm5>, <Rn>{, <shift>}

15	14	13	12	11	10	9	8	7	6	5	4	3	2	1	0	15	14	13	12	11	10	9	8	7	6	5	4	3	2	1	0
1	1	1	1	0	(0)	1	1	1	0	sh	0		Rn		0	imm3		Rd		imm2	(0)		sat_imm								

```

if sh == '1' && (imm3:imm2) == '0000' then SEE USAT16;
d = UInt(Rd); n = UInt(Rn); saturate_to = UInt(sat_imm);
(shift_t, shift_n) = DecodeImmShift(sh:'0', imm3:imm2);
if d IN {13,15} || n IN {13,15} then UNPREDICTABLE;

```

#### Encoding A1 ARMv6\*, ARMv7

USAT<c> <Rd>, #<imm5>, <Rn>{, <shift>}

31	30	29	28	27	26	25	24	23	22	21	20	19	18	17	16	15	14	13	12	11	10	9	8	7	6	5	4	3	2	1	0
cond		0	1	1	0	1	1	1		sat_imm			Rd			imm5		sh	0	1											Rn

```

d = UInt(Rd); n = UInt(Rn); saturate_to = UInt(sat_imm);
(shift_t, shift_n) = DecodeImmShift(sh:'0', imm5);
if d == 15 || n == 15 then UNPREDICTABLE;

```



## Assembler syntax

USAT{<c>}{<q>} <Rd>, #<imm>, <Rn> {, <shift>}

where:

- <c>, <q> See [Standard assembler syntax fields on page A8-287](#).
- <Rd> The destination register.
- <imm> The bit position for saturation, in the range 0 to 31. This is encoded directly in the sat\_imm field of the instruction, meaning sat\_imm takes the value of <imm>.
- <Rn> The register that contains the value to be saturated.
- <shift> The optional shift, encoded in the sh bit and the immsh field, where immsh is:
- imm3:imm2 for encoding T1
  - imm5 for encoding A1.
- <shift> must be one of:
- omitted** No shift. Encoded as sh = 0, immsh = 0b00000.
- LSL #<n> Left shift by <n> bits, with <n> in the range 1-31.  
Encoded as sh = 0, immsh = <n>.
- ASR #<n> Arithmetic right shift by <n> bits, with <n> in the range 1-31.  
Encoded as sh = 1, immsh = <n>.
- ASR #32 Arithmetic right shift by 32 bits, permitted only for encoding A1.  
Encoded as sh = 1, immsh = 0b00000.

### Note

An assembler can permit ASR #0 or LSL #0 to mean the same thing as omitting the shift, but this is not standard UAL and must not be used for disassembly.

## Operation

```
if ConditionPassed() then
    EncodingSpecificOperations();
    operand = Shift(R[n], shift_t, shift_n, APSR.C); // APSR.C ignored
    (result, sat) = UnsignedSatQ(SInt(operand), saturate_to);
    R[d] = ZeroExtend(result, 32);
    if sat then
        APSR.Q = '1';
```

## Exceptions

None.

### A8.8.267 USAT16

Unsigned Saturate 16 saturates two signed 16-bit values to a selected unsigned range.

The Q flag is set if the operation saturates.

#### Encoding T1 ARMv6T2, ARMv7

USAT16<c> <Rd>, #<imm4>, <Rn>

15	14	13	12	11	10	9	8	7	6	5	4	3	2	1	0	15	14	13	12	11	10	9	8	7	6	5	4	3	2	1	0
1	1	1	1	0	(0)	1	1	1	0	1	0		Rn			0	0	0	0			Rd		0	0	(0)	(0)	sat_imm			

d = UInt(Rd); n = UInt(Rn); saturate\_to = UInt(sat\_imm);  
if d IN {13,15} || n IN {13,15} then UNPREDICTABLE;

#### Encoding A1 ARMv6\*, ARMv7

USAT16<c> <Rd>, #<imm4>, <Rn>

31	30	29	28	27	26	25	24	23	22	21	20	19	18	17	16	15	14	13	12	11	10	9	8	7	6	5	4	3	2	1	0
cond		0	1	1	0	1	1	1	0	sat_imm		Rd		(1)	(1)	(1)	(1)	0	0	1	1	Rn									

d = UInt(Rd); n = UInt(Rn); saturate\_to = UInt(sat\_imm);  
if d == 15 || n == 15 then UNPREDICTABLE;

## Assembler syntax

USAT16{<c>}{<q>} <Rd>, #<imm>, <Rn>

where:

- <c>, <q> See [Standard assembler syntax fields on page A8-287](#).
- <Rd> The destination register.
- <imm> The bit position for saturation, in the range 0 to 15. This is encoded directly in the sat\_imm field of the instruction, meaning sat\_imm takes the value of <imm>.
- <Rn> The register that contains the values to be saturated.

## Operation

```
if ConditionPassed() then
    EncodingSpecificOperations();
    (result1, sat1) = UnsignedSatQ(SInt(R[n]<15:0>), saturate_to);
    (result2, sat2) = UnsignedSatQ(SInt(R[n]<31:16>), saturate_to);
    R[d]<15:0> = ZeroExtend(result1, 16);
    R[d]<31:16> = ZeroExtend(result2, 16);
    if sat1 || sat2 then
        APSR.Q = '1';
```

## Exceptions

None.

### A8.8.268 USAX

Unsigned Subtract and Add with Exchange exchanges the two halfwords of the second operand, performs one unsigned 16-bit integer subtraction and one unsigned 16-bit addition, and writes the results to the destination register. It sets the APSR.GE bits according to the results.

#### Encoding T1 ARMv6T2, ARMv7

USAX<c> <Rd>, <Rn>, <Rm>

15	14	13	12	11	10	9	8	7	6	5	4	3	2	1	0	15	14	13	12	11	10	9	8	7	6	5	4	3	2	1	0
1	1	1	1	1	0	1	0	1	1	1	0	Rn				1	1	1	1	Rd				0	1	0	0	Rm			

d = UInt(Rd); n = UInt(Rn); m = UInt(Rm);  
if d IN {13,15} || n IN {13,15} || m IN {13,15} then UNPREDICTABLE;

#### Encoding A1 ARMv6\*, ARMv7

USAX<c> <Rd>, <Rn>, <Rm>

31	30	29	28	27	26	25	24	23	22	21	20	19	18	17	16	15	14	13	12	11	10	9	8	7	6	5	4	3	2	1	0		
cond		0	1	1	0	0	1	0	1	Rn				Rd				(1)	(1)	(1)	(1)	0	1	0	1	Rm							

d = UInt(Rd); n = UInt(Rn); m = UInt(Rm);  
if d == 15 || n == 15 || m == 15 then UNPREDICTABLE;

## Assembler syntax

USAX{<c>}{<q>} {<Rd>}, <Rn>, <Rm>

where:

<c>, <q> See [Standard assembler syntax fields on page A8-287](#).

<Rd> The destination register.

<Rn> The first operand register.

<Rm> The second operand register.

The pre-UAL syntax USUBADDX<c> is equivalent to USAX<c>.

## Operation

```
if ConditionPassed() then
    EncodingSpecificOperations();
    sum = UInt(R[n]<15:0>) + UInt(R[m]<31:16>);
    diff = UInt(R[n]<31:16>) - UInt(R[m]<15:0>);
    R[d]<15:0> = sum<15:0>;
    R[d]<31:16> = diff<15:0>;
    APSR.GE<1:0> = if sum >= 0x10000 then '11' else '00';
    APSR.GE<3:2> = if diff >= 0 then '11' else '00';
```

## Exceptions

None.

### A8.8.269 USUB16

Unsigned Subtract 16 performs two 16-bit unsigned integer subtractions, and writes the results to the destination register. It sets the APSR.GE bits according to the results of the subtractions.

#### Encoding T1 ARMv6T2, ARMv7

USUB16<c> <Rd>, <Rn>, <Rm>

15	14	13	12	11	10	9	8	7	6	5	4	3	2	1	0	15	14	13	12	11	10	9	8	7	6	5	4	3	2	1	0
1	1	1	1	1	0	1	0	1	1	0	1	Rn				1	1	1	1	Rd				0	1	0	0	Rm			

d = UInt(Rd); n = UInt(Rn); m = UInt(Rm);  
if d IN {13,15} || n IN {13,15} || m IN {13,15} then UNPREDICTABLE;

#### Encoding A1 ARMv6\*, ARMv7

USUB16<c> <Rd>, <Rn>, <Rm>

31	30	29	28	27	26	25	24	23	22	21	20	19	18	17	16	15	14	13	12	11	10	9	8	7	6	5	4	3	2	1	0
cond		0	1	1	0	0	1	0	1	Rn				Rd				(1)	(1)	(1)	(1)	0	1	1	1	Rm					

d = UInt(Rd); n = UInt(Rn); m = UInt(Rm);  
if d == 15 || n == 15 || m == 15 then UNPREDICTABLE;

## Assembler syntax

USUB16{<c>}{<q>} {<Rd>}, <Rn>, <Rm>

where:

<c>, <q> See *Standard assembler syntax fields* on page A8-287.

<Rd> The destination register.

<Rn> The first operand register.

<Rm> The second operand register.

## Operation

```
if ConditionPassed() then
    EncodingSpecificOperations();
    diff1 = UInt(R[n]<15:0>) - UInt(R[m]<15:0>);
    diff2 = UInt(R[n]<31:16>) - UInt(R[m]<31:16>);
    R[d]<15:0> = diff1<15:0>;
    R[d]<31:16> = diff2<15:0>;
    APSR.GE<1:0> = if diff1 >= 0 then '11' else '00';
    APSR.GE<3:2> = if diff2 >= 0 then '11' else '00';
```

## Exceptions

None.

### A8.8.270 USUB8

Unsigned Subtract 8 performs four 8-bit unsigned integer subtractions, and writes the results to the destination register. It sets the APSR.GE bits according to the results of the subtractions.

#### Encoding T1 ARMv6T2, ARMv7

USUB8<c> <Rd>, <Rn>, <Rm>

15	14	13	12	11	10	9	8	7	6	5	4	3	2	1	0	15	14	13	12	11	10	9	8	7	6	5	4	3	2	1	0
1	1	1	1	1	0	1	0	1	1	0	0	Rn			1	1	1	1	Rd			0	1	0	0	Rm					

d = UInt(Rd); n = UInt(Rn); m = UInt(Rm);  
if d IN {13,15} || n IN {13,15} || m IN {13,15} then UNPREDICTABLE;

#### Encoding A1 ARMv6\*, ARMv7

USUB8<c> <Rd>, <Rn>, <Rm>

31	30	29	28	27	26	25	24	23	22	21	20	19	18	17	16	15	14	13	12	11	10	9	8	7	6	5	4	3	2	1	0
cond		0	1	1	0	0	1	0	1	Rn			Rd			(1)	(1)	(1)	(1)	1	1	1	1	Rm							

d = UInt(Rd); n = UInt(Rn); m = UInt(Rm);  
if d == 15 || n == 15 || m == 15 then UNPREDICTABLE;



## Assembler syntax

USUB8{<c>}{<q>} {<Rd>}, <Rn>, <Rm>

where:

<c>, <q> See *Standard assembler syntax fields* on page A8-287.

<Rd> The destination register.

<Rn> The first operand register.

<Rm> The second operand register.

## Operation

```
if ConditionPassed() then
    EncodingSpecificOperations();
    diff1 = UInt(R[n]<7:0>) - UInt(R[m]<7:0>);
    diff2 = UInt(R[n]<15:8>) - UInt(R[m]<15:8>);
    diff3 = UInt(R[n]<23:16>) - UInt(R[m]<23:16>);
    diff4 = UInt(R[n]<31:24>) - UInt(R[m]<31:24>);
    R[d]<7:0> = diff1<7:0>;
    R[d]<15:8> = diff2<7:0>;
    R[d]<23:16> = diff3<7:0>;
    R[d]<31:24> = diff4<7:0>;
    APSR.GE<0> = if diff1 >= 0 then '1' else '0';
    APSR.GE<1> = if diff2 >= 0 then '1' else '0';
    APSR.GE<2> = if diff3 >= 0 then '1' else '0';
    APSR.GE<3> = if diff4 >= 0 then '1' else '0';
```

## Exceptions

None.

### A8.8.271 UXTAB

Unsigned Extend and Add Byte extracts an 8-bit value from a register, zero-extends it to 32 bits, adds the result to the value in another register, and writes the final result to the destination register. The instruction can specify a rotation by 0, 8, 16, or 24 bits before extracting the 8-bit value.

**Encoding T1** ARMv6T2, ARMv7  
UXTAB<c> <Rd>, <Rn>, <Rm>{, <rotation>}

15	14	13	12	11	10	9	8	7	6	5	4	3	2	1	0	15	14	13	12	11	10	9	8	7	6	5	4	3	2	1	0
1	1	1	1	1	0	1	0	0	1	0	1	Rn				1	1	1	1	Rd				1	(0)	rotate	Rm				

if Rn == '1111' then SEE UXTB;  
d = UInt(Rd); n = UInt(Rn); m = UInt(Rm); rotation = UInt(rotate:'000');  
if d IN {13,15} || n == 13 || m IN {13,15} then UNPREDICTABLE;

**Encoding A1** ARMv6\*, ARMv7  
UXTAB<c> <Rd>, <Rn>, <Rm>{, <rotation>}

31	30	29	28	27	26	25	24	23	22	21	20	19	18	17	16	15	14	13	12	11	10	9	8	7	6	5	4	3	2	1	0
cond		0	1	1	0	1	1	1	0	Rn				Rd				rotate	(0)	(0)	0	1	1	1	Rm						

if Rn == '1111' then SEE UXTB;  
d = UInt(Rd); n = UInt(Rn); m = UInt(Rm); rotation = UInt(rotate:'000');  
if d == 15 || m == 15 then UNPREDICTABLE;

## Assembler syntax

UXTAB{<c>}{<q>} {<Rd>}, <Rn>, <Rm> {, <rotation>}

where:

<c>, <q> See *Standard assembler syntax fields* on page A8-287.

<Rd> The destination register.

<Rn> The first operand register.

<Rm> The second operand register.

<rotation> This can be any one of:

**omitted** encoded as rotate = 0b00

ROR #8 encoded as rotate = 0b01

ROR #16 encoded as rotate = 0b10

ROR #24 encoded as rotate = 0b11.

### ———— Note ————

An assembler can permit ROR #0 to mean the same thing as omitting the rotation, possibly with restrictions on the permitted encodings, but this is not standard UAL and must not be used for disassembly.

## Operation

```
if ConditionPassed() then
    EncodingSpecificOperations();
    rotated = ROR(R[m], rotation);
    R[d] = R[n] + ZeroExtend(rotated<7:0>, 32);
```

## Exceptions

None.

### A8.8.272 UXTAB16

Unsigned Extend and Add Byte 16 extracts two 8-bit values from a register, zero-extends them to 16 bits each, adds the results to two 16-bit values from another register, and writes the final results to the destination register. The instruction can specify a rotation by 0, 8, 16, or 24 bits before extracting the 8-bit values.

**Encoding T1** ARMv6T2, ARMv7  
UXTAB16<c> <Rd>, <Rn>, <Rm>{, <rotation>}

15	14	13	12	11	10	9	8	7	6	5	4	3	2	1	0	15	14	13	12	11	10	9	8	7	6	5	4	3	2	1	0
1	1	1	1	1	0	1	0	0	0	1	1	Rd				1	1	1	1	Rd				1	(0)	rotate	Rm				

if Rn == '1111' then SEE UXTB16;  
d = UInt(Rd); n = UInt(Rn); m = UInt(Rm); rotation = UInt(rotate:'000');  
if d IN {13,15} || n == 13 || m IN {13,15} then UNPREDICTABLE;

**Encoding A1** ARMv6\*, ARMv7  
UXTAB16<c> <Rd>, <Rn>, <Rm>{, <rotation>}

31	30	29	28	27	26	25	24	23	22	21	20	19	18	17	16	15	14	13	12	11	10	9	8	7	6	5	4	3	2	1	0
cond				0	1	1	0	1	1	0	0	Rn				Rd				rotate	(0)	(0)	0	1	1	1	Rm				

if Rn == '1111' then SEE UXTB16;  
d = UInt(Rd); n = UInt(Rn); m = UInt(Rm); rotation = UInt(rotate:'000');  
if d == 15 || m == 15 then UNPREDICTABLE;

## Assembler syntax

UXTAB16{<c>}{<q>} {<Rd>}, <Rn>, <Rm> {, <rotation>}

where:

<c>, <q> See *Standard assembler syntax fields* on page A8-287.

<Rd> The destination register.

<Rn> The first operand register.

<Rm> The second operand register.

<rotation> This can be any one of:

**omitted** encoded as rotate = 0b00

ROR #8 encoded as rotate = 0b01

ROR #16 encoded as rotate = 0b10

ROR #24 encoded as rotate = 0b11.

———— **Note** —————

An assembler can permit ROR #0 to mean the same thing as omitting the rotation, possibly with restrictions on the permitted encodings, but this is not standard UAL and must not be used for disassembly.

## Operation

```
if ConditionPassed() then
    EncodingSpecificOperations();
    rotated = ROR(R[m], rotation);
    R[d]<15:0> = R[n]<15:0> + ZeroExtend(rotated<7:0>, 16);
    R[d]<31:16> = R[n]<31:16> + ZeroExtend(rotated<23:16>, 16);
```

## Exceptions

None.

### A8.8.273 UXTAH

Unsigned Extend and Add Halfword extracts a 16-bit value from a register, zero-extends it to 32 bits, adds the result to a value from another register, and writes the final result to the destination register. The instruction can specify a rotation by 0, 8, 16, or 24 bits before extracting the 16-bit value.

**Encoding T1** ARMv6T2, ARMv7  
UXTAH<c> <Rd>, <Rn>, <Rm>{, <rotation>}

15	14	13	12	11	10	9	8	7	6	5	4	3	2	1	0	15	14	13	12	11	10	9	8	7	6	5	4	3	2	1	0
1	1	1	1	1	0	1	0	0	0	0	1	Rn				1	1	1	1	Rd				1	(0)	rotate	Rm				

if Rn == '1111' then SEE UXTH;  
d = UInt(Rd); n = UInt(Rn); m = UInt(Rm); rotation = UInt(rotate:'000');  
if d IN {13,15} || n == 13 || m IN {13,15} then UNPREDICTABLE;

**Encoding A1** ARMv6\*, ARMv7  
UXTAH<c> <Rd>, <Rn>, <Rm>{, <rotation>}

31	30	29	28	27	26	25	24	23	22	21	20	19	18	17	16	15	14	13	12	11	10	9	8	7	6	5	4	3	2	1	0
cond		0	1	1	0	1	1	1	1	Rn				Rd				rotate	(0)	(0)	0	1	1	1	Rm						

if Rn == '1111' then SEE UXTH;  
d = UInt(Rd); n = UInt(Rn); m = UInt(Rm); rotation = UInt(rotate:'000');  
if d == 15 || m == 15 then UNPREDICTABLE;

## Assembler syntax

UXTAH{<c>}{<q>} {<Rd>}, <Rn>, <Rm> {, <rotation>}

where:

<c>, <q> See *Standard assembler syntax fields* on page A8-287.

<Rd> The destination register.

<Rn> The first operand register.

<Rm> The second operand register.

<rotation> This can be any one of:

**omitted** encoded as rotate = 0b00

ROR #8 encoded as rotate = 0b01

ROR #16 encoded as rotate = 0b10

ROR #24 encoded as rotate = 0b11.

———— **Note** —————

An assembler can permit ROR #0 to mean the same thing as omitting the rotation, possibly with restrictions on the permitted encodings, but this is not standard UAL and must not be used for disassembly.

---

## Operation

```
if ConditionPassed() then
    EncodingSpecificOperations();
    rotated = ROR(R[m], rotation);
    R[d] = R[n] + ZeroExtend(rotated<15:0>, 32);
```

## Exceptions

None.

### A8.8.274 UXTB

Unsigned Extend Byte extracts an 8-bit value from a register, zero-extends it to 32 bits, and writes the result to the destination register. The instruction can specify a rotation by 0, 8, 16, or 24 bits before extracting the 8-bit value.

#### Encoding T1 ARMv6\*, ARMv7

UXTB<c> <Rd>, <Rm>

15	14	13	12	11	10	9	8	7	6	5	4	3	2	1	0
1	0	1	1	0	0	1	0	1	1	Rm					Rd

d = UInt(Rd); m = UInt(Rm); rotation = 0;

#### Encoding T2 ARMv6T2, ARMv7

UXTB<c>.W <Rd>, <Rm>{, <rotation>}

15	14	13	12	11	10	9	8	7	6	5	4	3	2	1	0	15	14	13	12	11	10	9	8	7	6	5	4	3	2	1	0
1	1	1	1	1	0	1	0	0	1	0	1	1	1	1	1	1	1	1	1	1	Rd	1	(0)	rotate		Rm					

d = UInt(Rd); m = UInt(Rm); rotation = UInt(rotate:'000');  
if d IN {13,15} || m IN {13,15} then UNPREDICTABLE;

#### Encoding A1 ARMv6\*, ARMv7

UXTB<c> <Rd>, <Rm>{, <rotation>}

31	30	29	28	27	26	25	24	23	22	21	20	19	18	17	16	15	14	13	12	11	10	9	8	7	6	5	4	3	2	1	0
cond		0	1	1	0	1	1	1	0	1	1	1	1	Rd	rotate	(0)	(0)	0	1	1	1										Rm

d = UInt(Rd); m = UInt(Rm); rotation = UInt(rotate:'000');  
if d == 15 || m == 15 then UNPREDICTABLE;



## Assembler syntax

UXTB{<c>}{<q>} {<Rd>}, <Rm> {, <rotation>}

where:

<c>, <q> See *Standard assembler syntax fields* on page A8-287.

<Rd> The destination register.

<Rm> The second operand register.

<rotation> This can be any one of:

**omitted** any encoding, encoded as rotate = 0b00 in encoding T2 or A1

ROR #8 encoding T2 or A1, encoded as rotate = 0b01

ROR #16 encoding T2 or A1, encoded as rotate = 0b10

ROR #24 encoding T2 or A1, encoded as rotate = 0b11.

### ———— Note —————

An assembler can permit ROR #0 to mean the same thing as omitting the rotation, possibly with restrictions on the permitted encodings, but this is not standard UAL and must not be used for disassembly.

The pre-UAL syntax UEXT8<c> is equivalent to UXTB<c>.

## Operation

```
if ConditionPassed() then
    EncodingSpecificOperations();
    rotated = ROR(R[m], rotation);
    R[d] = ZeroExtend(rotated<7:0>, 32);
```

## Exceptions

None.

### A8.8.275 UXTB16

Unsigned Extend Byte 16 extracts two 8-bit values from a register, zero-extends them to 16 bits each, and writes the results to the destination register. The instruction can specify a rotation by 0, 8, 16, or 24 bits before extracting the 8-bit values.

**Encoding T1** ARMv6T2, ARMv7

UXTB16<c> <Rd>, <Rm>{, <rotation>}

15	14	13	12	11	10	9	8	7	6	5	4	3	2	1	0	15	14	13	12	11	10	9	8	7	6	5	4	3	2	1	0
1	1	1	1	1	0	1	0	0	0	1	1	1	1	1	1	1	1	1	1		Rd		1	(0)	rotate		Rm				

d = UInt(Rd); m = UInt(Rm); rotation = UInt(rotate:'000');  
if d IN {13,15} || m IN {13,15} then UNPREDICTABLE;

**Encoding A1** ARMv6\*, ARMv7

UXTB16<c> <Rd>, <Rm>{, <rotation>}

31	30	29	28	27	26	25	24	23	22	21	20	19	18	17	16	15	14	13	12	11	10	9	8	7	6	5	4	3	2	1	0
cond		0	1	1	0	1	1	0	0	1	1	1	1		Rd		rotate	(0)	(0)	0	1	1	1			Rm					

d = UInt(Rd); m = UInt(Rm); rotation = UInt(rotate:'000');  
if d == 15 || m == 15 then UNPREDICTABLE;

## Assembler syntax

UXTB16{<c>}{<q>} {<Rd>}, <Rm> {, <rotation>}

where:

<c>, <q> See [Standard assembler syntax fields on page A8-287](#).

<Rd> The destination register.

<Rm> The second operand register.

<rotation> This can be any one of:

**omitted** encoded as rotate = 0b00  
ROR #8 encoded as rotate = 0b01  
ROR #16 encoded as rotate = 0b10  
ROR #24 encoded as rotate = 0b11.

### ———— Note —————

An assembler can permit ROR #0 to mean the same thing as omitting the rotation, possibly with restrictions on the permitted encodings, but this is not standard UAL and must not be used for disassembly.

## Operation

```
if ConditionPassed() then
    EncodingSpecificOperations();
    rotated = ROR(R[m], rotation);
    R[d]<15:0> = ZeroExtend(rotated<7:0>, 16);
    R[d]<31:16> = ZeroExtend(rotated<23:16>, 16);
```

## Exceptions

None.

## A8.8.276 UXTH

Unsigned Extend Halfword extracts a 16-bit value from a register, zero-extends it to 32 bits, and writes the result to the destination register. The instruction can specify a rotation by 0, 8, 16, or 24 bits before extracting the 16-bit value.

### Encoding T1 ARMv6\*, ARMv7

UXTH<c> <Rd>, <Rm>

15	14	13	12	11	10	9	8	7	6	5	4	3	2	1	0
1	0	1	1	0	0	1	0	1	0	Rm			Rd		

d = UInt(Rd); m = UInt(Rm); rotation = 0;

### Encoding T2 ARMv6T2, ARMv7

UXTH<c>.W <Rd>, <Rm>{, <rotation>}

15	14	13	12	11	10	9	8	7	6	5	4	3	2	1	0	15	14	13	12	11	10	9	8	7	6	5	4	3	2	1	0
1	1	1	1	1	0	1	0	0	0	0	1	1	1	1	1	1	1	1	1	Rd			1	(0)	rotate	Rm					

d = UInt(Rd); m = UInt(Rm); rotation = UInt(rotate:'000');  
if d IN {13,15} || m IN {13,15} then UNPREDICTABLE;

### Encoding A1 ARMv6\*, ARMv7

UXTH<c> <Rd>, <Rm>{, <rotation>}

31	30	29	28	27	26	25	24	23	22	21	20	19	18	17	16	15	14	13	12	11	10	9	8	7	6	5	4	3	2	1	0
cond		0	1	1	0	1	1	1	1	1	1	1	1	1	Rd			rotate	(0)	(0)	0	1	1	1	Rm						

d = UInt(Rd); m = UInt(Rm); rotation = UInt(rotate:'000');  
if d == 15 || m == 15 then UNPREDICTABLE;

## Assembler syntax

UXTH{<c>}{<q>} {<Rd>}, <Rm> {, <rotation>}

where:

<c>, <q> See *Standard assembler syntax fields* on page A8-287.

<Rd> The destination register.

<Rm> The second operand register.

<rotation> This can be any one of:

**omitted** any encoding, encoded as rotate = 0b00 in encoding T2 or A1

ROR #8 encoding T2 or A1, encoded as rotate = 0b01

ROR #16 encoding T2 or A1, encoded as rotate = 0b10

ROR #24 encoding T2 or A1, encoded as rotate = 0b11.

### ————— Note —————

An assembler can permit ROR #0 to mean the same thing as omitting the rotation, possibly with restrictions on the permitted encodings, but this is not standard UAL and must not be used for disassembly.

The pre-UAL syntax UEXT16<c> is equivalent to UXTH<c>.

## Operation

```
if ConditionPassed() then
    EncodingSpecificOperations();
    rotated = ROR(R[m], rotation);
    R[d] = ZeroExtend(rotated<15:0>, 32);
```

## Exceptions

None.

### A8.8.277 VABA, VABAL

Vector Absolute Difference and Accumulate {Long} subtracts the elements of one vector from the corresponding elements of another vector, and accumulates the absolute values of the results into the elements of the destination vector.

Operand and result elements are either all integers of the same length, or optionally the results can be double the length of the operands.

Depending on settings in the CPACR, NSACR, and HCPTR registers, and the security state and mode in which the instruction is executed, an attempt to execute the instruction might be UNDEFINED, or trapped to Hyp mode. [Summary of access controls for Advanced SIMD functionality on page B1-1232](#) summarizes these controls.

ARM deprecates the conditional execution of any Advanced SIMD instruction that is not also available as a VFP instruction, see [Conditional execution on page A8-288](#).

#### Encoding T1/A1 Advanced SIMD

VABA<c>.<dt> <Qd>, <Qn>, <Qm>

VABA<c>.<dt> <Dd>, <Dn>, <Dm>

15	14	13	12	11	10	9	8	7	6	5	4	3	2	1	0	15	14	13	12	11	10	9	8	7	6	5	4	3	2	1	0
1	1	1	U	1	1	1	1	0	D	size		Vn		Vd		0	1	1	1	N	Q	M	1		Vm						
31	30	29	28	27	26	25	24	23	22	21	20	19	18	17	16	15	14	13	12	11	10	9	8	7	6	5	4	3	2	1	0
1	1	1	1	0	0	1	U	0	D	size		Vn		Vd		0	1	1	1	N	Q	M	1		Vm						

```
if size == '11' then UNDEFINED;
if Q == '1' && (Vd<0> == '1' || Vn<0> == '1' || Vm<0> == '1') then UNDEFINED;
unsigned = (U == '1'); long_destination = FALSE;
esize = 8 << UInt(size); elements = 64 DIV esize;
d = UInt(D:Vd); n = UInt(N:Vn); m = UInt(M:Vm); regs = if Q == '0' then 1 else 2;
```

#### Encoding T2/A2 Advanced SIMD

VABAL<c>.<dt> <Qd>, <Dn>, <Dm>

15	14	13	12	11	10	9	8	7	6	5	4	3	2	1	0	15	14	13	12	11	10	9	8	7	6	5	4	3	2	1	0
1	1	1	U	1	1	1	1	1	D	size		Vn		Vd		0	1	0	1	N	0	M	0		Vm						
31	30	29	28	27	26	25	24	23	22	21	20	19	18	17	16	15	14	13	12	11	10	9	8	7	6	5	4	3	2	1	0
1	1	1	1	0	0	1	U	1	D	size		Vn		Vd		0	1	0	1	N	0	M	0		Vm						

```
if size == '11' then SEE "Related encodings";
if Vd<0> == '1' then UNDEFINED;
unsigned = (U == '1'); long_destination = TRUE;
esize = 8 << UInt(size); elements = 64 DIV esize;
d = UInt(D:Vd); n = UInt(N:Vn); m = UInt(M:Vm); regs = 1;
```

**Related encodings** See [Advanced SIMD data-processing instructions on page A7-261](#).

## Assembler syntax

VABA{<c>}{<q>}.<dt>	<Qd>, <Qn>, <Qm>	Encoding T1/A1, Q = 1
VABA{<c>}{<q>}.<dt>	<Dd>, <Dn>, <Dm>	Encoding T1/A1, Q = 0
VABAL{<c>}{<q>}.<dt>	<Qd>, <Dn>, <Dm>	Encoding T2/A2

where:

<c>, <q>	See <a href="#">Standard assembler syntax fields on page A8-287</a> . An ARM VABA or VABAL instruction must be unconditional. ARM strongly recommends that a Thumb VABA or VABAL instruction is unconditional, see <a href="#">Conditional execution on page A8-288</a> .
<dt>	The data type for the elements of the operands. It must be one of: S8 encoded as size = 0b00, U = 0. S16 encoded as size = 0b01, U = 0. S32 encoded as size = 0b10, U = 0. U8 encoded as size = 0b00, U = 1. U16 encoded as size = 0b01, U = 1. U32 encoded as size = 0b10, U = 1.
<Qd>, <Qn>, <Qm>	The destination vector and the operand vectors, for a quadword operation.
<Dd>, <Dn>, <Dm>	The destination vector and the operand vectors, for a doubleword operation.
<Qd>, <Dn>, <Dm>	The destination vector and the operand vectors, for a long operation.

## Operation

```

if ConditionPassed() then
    EncodingSpecificOperations(); CheckAdvSIMDEnabled();
    for r = 0 to regs-1
        for e = 0 to elements-1
            op1 = Elem[Din[n+r],e,esize];
            op2 = Elem[Din[m+r],e,esize];
            absdiff = Abs(Int(op1,unsigned) - Int(op2,unsigned));
            if long_destination then
                Elem[Q[d>>1],e,2*esize] = Elem[Qin[d>>1],e,2*esize] + absdiff;
            else
                Elem[D[d+r],e,esize] = Elem[Din[d+r],e,esize] + absdiff;

```

## Exceptions

Undefined Instruction, Hyp Trap.

### A8.8.278 VABD, VABDL (integer)

Vector Absolute Difference {Long} (integer) subtracts the elements of one vector from the corresponding elements of another vector, and places the absolute values of the results in the elements of the destination vector.

Operand and result elements are either all integers of the same length, or optionally the results can be double the length of the operands.

Depending on settings in the CPACR, NSACR, and HCPTR registers, and the security state and mode in which the instruction is executed, an attempt to execute the instruction might be UNDEFINED, or trapped to Hyp mode. [Summary of access controls for Advanced SIMD functionality on page B1-1232](#) summarizes these controls.

ARM deprecates the conditional execution of any Advanced SIMD instruction that is not also available as a VFP instruction, see [Conditional execution on page A8-288](#).

#### Encoding T1/A1 Advanced SIMD

VABD<c>.<dt> <Qd>, <Qn>, <Qm>

VABD<c>.<dt> <Dd>, <Dn>, <Dm>

15	14	13	12	11	10	9	8	7	6	5	4	3	2	1	0	15	14	13	12	11	10	9	8	7	6	5	4	3	2	1	0
1	1	1	U	1	1	1	1	0	D	size	Vn	Vd	0	1	1	1	N	Q	M	0	Vm										

31	30	29	28	27	26	25	24	23	22	21	20	19	18	17	16	15	14	13	12	11	10	9	8	7	6	5	4	3	2	1	0
1	1	1	1	0	0	1	U	0	D	size	Vn	Vd	0	1	1	1	N	Q	M	0	Vm										

```

if size == '11' then UNDEFINED;
if Q == '1' && (Vd<0> == '1' || Vn<0> == '1' || Vm<0> == '1') then UNDEFINED;
unsigned = (U == '1'); long_destination = FALSE;
esize = 8 << UInt(size); elements = 64 DIV esize;
d = UInt(D:Vd); n = UInt(N:Vn); m = UInt(M:Vm); regs = if Q == '0' then 1 else 2;

```

#### Encoding T2/A2 Advanced SIMD

VABDL<c>.<dt> <Qd>, <Dn>, <Dm>

15	14	13	12	11	10	9	8	7	6	5	4	3	2	1	0	15	14	13	12	11	10	9	8	7	6	5	4	3	2	1	0
1	1	1	U	1	1	1	1	1	D	size	Vn	Vd	0	1	1	1	N	0	M	0	Vm										

31	30	29	28	27	26	25	24	23	22	21	20	19	18	17	16	15	14	13	12	11	10	9	8	7	6	5	4	3	2	1	0
1	1	1	1	0	0	1	U	1	D	size	Vn	Vd	0	1	1	1	N	0	M	0	Vm										

```

if size == '11' then SEE "Related encodings";
if Vd<0> == '1' then UNDEFINED;
unsigned = (U == '1'); long_destination = TRUE;
esize = 8 << UInt(size); elements = 64 DIV esize;
d = UInt(D:Vd); n = UInt(N:Vn); m = UInt(M:Vm); regs = 1;

```

**Related encodings** See [Advanced SIMD data-processing instructions on page A7-261](#).



## Assembler syntax

VABD{<c>}{<q>}.<dt> {<Qd>, }<Qn>, <Qm>	Encoding T1/A1, Q = 1
VABD{<c>}{<q>}.<dt> {<Dd>, }<Dn>, <Dm>	Encoding T1/A1, Q = 0
VABDL{<c>}{<q>}.<dt> <Qd>, <Dn>, <Dm>	Encoding T2/A2

where:

<c>, <q>	See <i>Standard assembler syntax fields on page A8-287</i> . An ARM VABD or VABDL instruction must be unconditional. ARM strongly recommends that a Thumb VABD or VABDL instruction is unconditional, see <i>Conditional execution on page A8-288</i> .
<dt>	The data type for the elements of the operands. It must be one of: S8            encoded as size = 0b00, U = 0. S16           encoded as size = 0b01, U = 0. S32           encoded as size = 0b10, U = 0. U8             encoded as size = 0b00, U = 1. U16            encoded as size = 0b01, U = 1. U32            encoded as size = 0b10, U = 1.
<Qd>, <Qn>, <Qm>	The destination vector and the operand vectors, for a quadword operation.
<Dd>, <Dn>, <Dm>	The destination vector and the operand vectors, for a doubleword operation.
<Qd>, <Dn>, <Dm>	The destination vector and the operand vectors, for a long operation.

## Operation

```

if ConditionPassed() then
    EncodingSpecificOperations(); CheckAdvSIMDEnabled();
    for r = 0 to regs-1
        for e = 0 to elements-1
            op1 = Elem[Din[n+r],e,esize];
            op2 = Elem[Din[m+r],e,esize];
            absdiff = Abs(Int(op1,unsigned) - Int(op2,unsigned));
            if long_destination then
                Elem[Q[d>>1],e,2*esize] = absdiff<2*esize-1:0>;
            else
                Elem[D[d+r],e,esize] = absdiff<esize-1:0>;

```

## Exceptions

Undefined Instruction, Hyp Trap.

### A8.8.279 VABD (floating-point)

Vector Absolute Difference (floating-point) subtracts the elements of one vector from the corresponding elements of another vector, and places the absolute values of the results in the elements of the destination vector.

Operand and result elements are all single-precision floating-point numbers.

Depending on settings in the CPACR, NSACR, and HCPTR registers, and the security state and mode in which the instruction is executed, an attempt to execute the instruction might be UNDEFINED, or trapped to Hyp mode. [Summary of access controls for Advanced SIMD functionality on page B1-1232](#) summarizes these controls.

ARM deprecates the conditional execution of any Advanced SIMD instruction that is not also available as a VFP instruction, see [Conditional execution on page A8-288](#).

#### Encoding T1/A1 Advanced SIMD (UNDEFINED in integer-only variant)

VABD<c>.F32 <Qd>, <Qn>, <Qm>

VABD<c>.F32 <Dd>, <Dn>, <Dm>

15	14	13	12	11	10	9	8	7	6	5	4	3	2	1	0	15	14	13	12	11	10	9	8	7	6	5	4	3	2	1	0
1	1	1	1	1	1	1	1	0	D	1	sz	Vn				Vd	1	1	0	1	N	Q	M	0	Vm						

31	30	29	28	27	26	25	24	23	22	21	20	19	18	17	16	15	14	13	12	11	10	9	8	7	6	5	4	3	2	1	0
1	1	1	1	0	0	1	1	0	D	1	sz	Vn				Vd	1	1	0	1	N	Q	M	0	Vm						

```

if Q == '1' && (Vd<0> == '1' || Vn<0> == '1' || Vm<0> == '1') then UNDEFINED;
if sz == '1' then UNDEFINED;
esize = 32; elements = 2;
d = UInt(D:Vd); n = UInt(N:Vn); m = UInt(M:Vm); regs = if Q == '0' then 1 else 2;

```

## Assembler syntax

VABD{<C>}{<q>}.F32 {<Qd>, }<Qn>, <Qm> Encoded as Q = 1, sz = 0  
VABD{<C>}{<q>}.F32 {<Dd>, }<Dn>, <Dm> Encoded as Q = 0, sz = 0

where:

<C>, <q> See [Standard assembler syntax fields on page A8-287](#). An ARM VABD instruction must be unconditional. ARM strongly recommends that a Thumb VABD instruction is unconditional, see [Conditional execution on page A8-288](#).

<Qd>, <Qn>, <Qm> The destination vector and the operand vectors, for a quadword operation.

<Dd>, <Dn>, <Dm> The destination vector and the operand vectors, for a doubleword operation.

## Operation

```
if ConditionPassed() then
    EncodingSpecificOperations(); CheckAdvSIMDEnabled();
    for r = 0 to regs-1
        for e = 0 to elements-1
            op1 = Elem[D[n+r],e,esize]; op2 = Elem[D[m+r],e,esize];
            Elem[D[d+r],e,esize] = FPAbs(FPSub(op1,op2,FALSE));
```

## Exceptions

Undefined Instruction, Hyp Trap.

### ***Floating-point exceptions***

Input Denormal, Invalid Operation, Overflow, Underflow, Inexact.

## A8.8.280 VABS

Vector Absolute takes the absolute value of each element in a vector, and places the results in a second vector. The floating-point version only clears the sign bit.

Depending on settings in the CPACR, NSACR, HCPTR, and FPEXC registers, and the security state and mode in which the instruction is executed, an attempt to execute the instruction might be UNDEFINED, or trapped to Hyp mode. [Summary of general controls of CP10 and CP11 functionality on page B1-1230](#) and [Summary of access controls for Advanced SIMD functionality on page B1-1232](#) summarize these controls.

ARM deprecates the conditional execution of any Advanced SIMD instruction that is not also available as a VFP instruction, see [Conditional execution on page A8-288](#).

### Encoding T1/A1 Advanced SIMD (F = 1 UNDEFINED in integer-only variants)

VABS<c>.<dt> <Qd>, <Qm>

VABS<c>.<dt> <Dd>, <Dm>

15	14	13	12	11	10	9	8	7	6	5	4	3	2	1	0	15	14	13	12	11	10	9	8	7	6	5	4	3	2	1	0
1	1	1	1	1	1	1	1	1	D	1	1	size	0	1	Vd	0	F	1	1	0	Q	M	0	Vm							

31	30	29	28	27	26	25	24	23	22	21	20	19	18	17	16	15	14	13	12	11	10	9	8	7	6	5	4	3	2	1	0
1	1	1	1	0	0	1	1	1	D	1	1	size	0	1	Vd	0	F	1	1	0	Q	M	0	Vm							

```
if size == '11' || (F == '1' && size != '10') then UNDEFINED;
if Q == '1' && (Vd<0> == '1' || Vm<0> == '1') then UNDEFINED;
advsimd = TRUE; floating_point = (F == '1');
esize = 8 << UInt(size); elements = 64 DIV esize;
d = UInt(D:Vd); m = UInt(M:Vm); regs = if Q == '0' then 1 else 2;
```

### Encoding T2/A2 VFPv2, VFPv3, VFPv4 (sz = 1 UNDEFINED in single-precision only variants)

VABS<c>.<F64> <Dd>, <Dm>

VABS<c>.<F32> <Sd>, <Sm>

15	14	13	12	11	10	9	8	7	6	5	4	3	2	1	0	15	14	13	12	11	10	9	8	7	6	5	4	3	2	1	0
1	1	1	0	1	1	1	0	1	D	1	1	0	0	0	0	Vd	1	0	1	sz	1	1	M	0	Vm						

31	30	29	28	27	26	25	24	23	22	21	20	19	18	17	16	15	14	13	12	11	10	9	8	7	6	5	4	3	2	1	0
cond		1	1	1	0	1	D	1	1	0	0	0	0	0	Vd	1	0	1	sz	1	1	M	0	Vm							

```
if FPSCR.Len != '000' || FPSCR.Stride != '00' then SEE "VFP vectors";
advsimd = FALSE; dp_operation = (sz == '1');
d = if dp_operation then UInt(D:Vd) else UInt(Vd:D);
m = if dp_operation then UInt(M:Vm) else UInt(Vm:M);
```

**VFP vectors** Encoding T2/A2 can operate on VFP vectors under control of the FPSCR. {Len, Stride} fields. For details see [Appendix K VFP Vector Operation Support](#).

## Assembler syntax

VABS{<c>}{<q>}.<dt> <Qd>, <Qm>	Encoding T1/A1
VABS{<c>}{<q>}.<dt> <Dd>, <Dm>	Encoding T1/A1
VABS{<c>}{<q>}.F32 <Sd>, <Sm>	Floating-point only, encoding T2/A2, encoded as sz = 0
VABS{<c>}{<q>}.F64 <Dd>, <Dm>	Encoding T2/A2, encoded as sz = 1

where:

<c>, <q>	See <a href="#">Standard assembler syntax fields on page A8-287</a> . An ARM Advanced SIMD VABS instruction must be unconditional. ARM strongly recommends that a Thumb Advanced SIMD VABS instruction is unconditional, see <a href="#">Conditional execution on page A8-288</a> .
<dt>	The data type for the elements of the vectors. It must be one of: S8 Encoded as size = 0b00, F = 0. S16 Encoded as size = 0b01, F = 0. S32 Encoded as size = 0b10, F = 0. F32 Encoded as size = 0b10, F = 1.
<Qd>, <Qm>	The destination vector and the operand vector, for a quadword operation.
<Dd>, <Dm>	The destination vector and the operand vector, for a doubleword operation.
<Sd>, <Sm>	The destination vector and the operand vector, for a singleword operation.

## Operation

```

if ConditionPassed() then
    EncodingSpecificOperations(); CheckAdvSIMDorVFPEEnabled(TRUE, advsimd);
    if advsimd then // Advanced SIMD instruction
        for r = 0 to regs-1
            for e = 0 to elements-1
                if floating_point then
                    Elem[D[d+r],e,esize] = FPAbs(Elem[D[m+r],e,esize]);
                else
                    result = Abs(SInt(Elem[D[m+r],e,esize]));
                    Elem[D[d+r],e,esize] = result<esize-1:0>;
    else // VFP instruction
        if dp_operation then
            D[d] = FPAbs(D[m]);
        else
            S[d] = FPAbs(S[m]);

```

## Exceptions

Undefined Instruction, Hyp Trap.

### A8.8.281 VACGE, VACGT, VACLE, VACLT

VACGE (Vector Absolute Compare Greater Than or Equal) and VACGT (Vector Absolute Compare Greater Than) take the absolute value of each element in a vector, and compare it with the absolute value of the corresponding element of a second vector. If the condition is true, the corresponding element in the destination vector is set to all ones. Otherwise, it is set to all zeros.

VACLE (Vector Absolute Compare Less Than or Equal) is a pseudo-instruction, equivalent to a VACGE instruction with the operands reversed. Disassembly produces the VACGE instruction.

VACLT (Vector Absolute Compare Less Than) is a pseudo-instruction, equivalent to a VACGT instruction with the operands reversed. Disassembly produces the VACGT instruction.

The operands and result can be quadword or doubleword vectors. They must all be the same size.

The operand vector elements must be 32-bit floating-point numbers.

The result vector elements are 32-bit fields.

Depending on settings in the CPACR, NSACR, and HCPTR registers, and the security state and mode in which the instruction is executed, an attempt to execute the instruction might be UNDEFINED, or trapped to Hyp mode.

[Summary of access controls for Advanced SIMD functionality on page B1-1232](#) summarizes these controls.

ARM deprecates the conditional execution of any Advanced SIMD instruction that is not also available as a VFP instruction, see [Conditional execution on page A8-288](#).

#### Encoding T1/A1 Advanced SIMD (UNDEFINED in integer-only variant)

V<op><c>.F32 <Qd>, <Qn>, <Qm>

V<op><c>.F32 <Dd>, <Dn>, <Dm>

15	14	13	12	11	10	9	8	7	6	5	4	3	2	1	0	15	14	13	12	11	10	9	8	7	6	5	4	3	2	1	0
1	1	1	1	1	1	1	1	0	D	op	sz	Vn			Vd			1	1	1	0	N	Q	M	1	Vm					

31	30	29	28	27	26	25	24	23	22	21	20	19	18	17	16	15	14	13	12	11	10	9	8	7	6	5	4	3	2	1	0
1	1	1	1	0	0	1	1	0	D	op	sz	Vn			Vd			1	1	1	0	N	Q	M	1	Vm					

```

if Q == '1' && (Vd<0> == '1' || Vn<0> == '1' || Vm<0> == '1') then UNDEFINED;
if sz == '1' then UNDEFINED;
or_equal = (op == '0');  esize = 32;  elements = 2;
d = UInt(D:Vd);  n = UInt(N:Vn);  m = UInt(M:Vm);  regs = if Q == '0' then 1 else 2;

```

## Assembler syntax

V<op>{<c>}{<q>}.F32 {<Qd>}, <Qn>, <Qm> Encoded as Q = 1  
V<op>{<c>}{<q>}.F32 {<Dd>}, <Dn>, <Dm> Encoded as Q = 0

where:

<op> The operation. It must be one of:  
ACGE Absolute Compare Greater than or Equal, encoded as op = 0.  
ACGT Absolute Compare Greater Than, encoded as op = 1.

<c>, <q> See [Standard assembler syntax fields on page A8-287](#). An ARM VACGE, VACGT, VACLE, or VACLT instruction must be unconditional. ARM strongly recommends that a Thumb VACGE, VACGT, VACLE, or VACLT instruction is unconditional, see [Conditional execution on page A8-288](#).

<Qd>, <Qn>, <Qm> The destination vector and the operand vectors, for a quadword operation.

<Dd>, <Dn>, <Dm> The destination vector and the operand vectors, for a doubleword operation.

## Operation

```

if ConditionPassed() then
    EncodingSpecificOperations(); CheckAdvSIMDEnabled();
    for r = 0 to regs-1
        for e = 0 to elements-1
            op1 = FPAbs(Elem[D[n+r],e,esize]); op2 = FPAbs(Elem[D[m+r],e,esize]);
            if or_equal then
                test_passed = FPCompareGE(op1, op2, FALSE);
            else
                test_passed = FPCompareGT(op1, op2, FALSE);
            Elem[D[d+r],e,esize] = if test_passed then Ones(esize) else Zeros(esize);

```

## Exceptions

Undefined Instruction, Hyp Trap.

### ***Floating-point exceptions***

Input Denormal, Invalid Operation.

### A8.8.282 VADD (integer)

Vector Add adds corresponding elements in two vectors, and places the results in the destination vector.

Depending on settings in the CPACR, NSACR, and HCPTR registers, and the security state and mode in which the instruction is executed, an attempt to execute the instruction might be UNDEFINED, or trapped to Hyp mode.

*Summary of access controls for Advanced SIMD functionality on page B1-1232* summarizes these controls.

ARM deprecates the conditional execution of any Advanced SIMD instruction encoding that is not also available as a VFP instruction encoding, see *Conditional execution on page A8-288*.

#### Encoding T1/A1 Advanced SIMD

VADD<c>.<dt> <Qd>, <Qn>, <Qm>

VADD<c>.<dt> <Dd>, <Dn>, <Dm>

15	14	13	12	11	10	9	8	7	6	5	4	3	2	1	0	15	14	13	12	11	10	9	8	7	6	5	4	3	2	1	0
1	1	1	0	1	1	1	1	0	D	size	Vn	Vd	1	0	0	0	N	Q	M	0	Vm										

31	30	29	28	27	26	25	24	23	22	21	20	19	18	17	16	15	14	13	12	11	10	9	8	7	6	5	4	3	2	1	0
1	1	1	1	0	0	1	0	0	D	size	Vn	Vd	1	0	0	0	N	Q	M	0	Vm										

```
if Q == '1' && (Vd<0> == '1' || Vn<0> == '1' || Vm<0> == '1') then UNDEFINED;
esize = 8 << UInt(size); elements = 64 DIV esize;
d = UInt(D:Vd); n = UInt(N:Vn); m = UInt(M:Vm); regs = if Q == '0' then 1 else 2;
```



## Assembler syntax

VADD{<c>}{<q>}.<dt> {<Qd>}, <Qn>, <Qm>

VADD{<c>}{<q>}.<dt> {<Dd>}, <Dn>, <Dm>

where:

<c>, <q> See [Standard assembler syntax fields on page A8-287](#). An ARM Advanced SIMD VADD instruction must be unconditional. ARM strongly recommends that a Thumb Advanced SIMD VADD instruction is unconditional, see [Conditional execution on page A8-288](#).

<dt> The data type for the elements of the vectors. It must be one of:

I8 size = 0b00.

I16 size = 0b01.

I32 size = 0b10.

I64 size = 0b11.

<Qd>, <Qn>, <Qm> The destination vector and the operand vectors, for a quadword operation.

<Dd>, <Dn>, <Dm> The destination vector and the operand vectors, for a doubleword operation.

## Operation

```
if ConditionPassed() then
    EncodingSpecificOperations(); CheckAdvSIMDEnabled();
    for r = 0 to regs-1
        for e = 0 to elements-1
            Elem[D[d+r],e,esize] = Elem[D[n+r],e,esize] + Elem[D[m+r],e,esize];
```

## Exceptions

Undefined Instruction, Hyp Trap.

### A8.8.283 VADD (floating-point)

Vector Add adds corresponding elements in two vectors, and places the results in the destination vector.

Depending on settings in the [CPACR](#), [NSACR](#), [HCPTR](#), and [FPEXC](#) registers, and the security state and mode in which the instruction is executed, an attempt to execute the instruction might be UNDEFINED, or trapped to Hyp mode. [Summary of general controls of CP10 and CP11 functionality on page B1-1230](#) and [Summary of access controls for Advanced SIMD functionality on page B1-1232](#) summarize these controls.

ARM deprecates the conditional execution of any Advanced SIMD instruction encoding that is not also available as a VFP instruction encoding, see [Conditional execution on page A8-288](#).

#### Encoding T1/A1 Advanced SIMD (UNDEFINED in integer-only variant)

VADD<c>.F32 <Qd>, <Qn>, <Qm>

VADD<c>.F32 <Dd>, <Dn>, <Dm>

15	14	13	12	11	10	9	8	7	6	5	4	3	2	1	0	15	14	13	12	11	10	9	8	7	6	5	4	3	2	1	0
1	1	1	0	1	1	1	1	0	D	0	sz		Vn			Vd	1	1	0	1	N	Q	M	0		Vm					

31	30	29	28	27	26	25	24	23	22	21	20	19	18	17	16	15	14	13	12	11	10	9	8	7	6	5	4	3	2	1	0
1	1	1	1	0	0	1	0	0	D	0	sz		Vn			Vd	1	1	0	1	N	Q	M	0		Vm					

```
if Q == '1' && (Vd<0> == '1' || Vn<0> == '1' || Vm<0> == '1') then UNDEFINED;
if sz == '1' then UNDEFINED;
advsimd = TRUE; esize = 32; elements = 2;
d = UInt(D:Vd); n = UInt(N:Vn); m = UInt(M:Vm); regs = if Q == '0' then 1 else 2;
```

#### Encoding T2/A2 VFPv2, VFPv3, VFPv4 (sz = 1 UNDEFINED in single-precision only variants)

VADD<c>.F64 <Dd>, <Dn>, <Dm>

VADD<c>.F32 <Sd>, <Sn>, <Sm>

15	14	13	12	11	10	9	8	7	6	5	4	3	2	1	0	15	14	13	12	11	10	9	8	7	6	5	4	3	2	1	0
1	1	1	0	1	1	1	0	0	D	1	1		Vn			Vd	1	0	1	sz	N	0	M	0		Vm					

31	30	29	28	27	26	25	24	23	22	21	20	19	18	17	16	15	14	13	12	11	10	9	8	7	6	5	4	3	2	1	0
cond		1	1	1	0	0	D	1	1		Vn			Vd	1	0	1	sz	N	0	M	0		Vm							

```
if FPSCR.Len != '000' || FPSCR.Stride != '00' then SEE "VFP vectors";
advsimd = FALSE; dp_operation = (sz == '1');
d = if dp_operation then UInt(D:Vd) else UInt(Vd:D);
n = if dp_operation then UInt(N:Vn) else UInt(Vn:N);
m = if dp_operation then UInt(M:Vm) else UInt(Vm:M);
```

**VFP vectors** Encoding T2/A2 can operate on VFP vectors under control of the [FPSCR](#). {Len, Stride} fields. For details see [Appendix K VFP Vector Operation Support](#).

## Assembler syntax

VADD{<c>}{<q>}.F32 {<Qd>}, <Qn>, <Qm>	Encoding T1/A1, encoded as Q = 1, sz = 0
VADD{<c>}{<q>}.F32 {<Dd>}, <Dn>, <Dm>	Encoding T1/A1, encoded as Q = 0, sz = 0
VADD{<c>}{<q>}.F32 {<Sd>}, <Sn>, <Sm>	Encoding T2/A2, encoded as sz = 0
VADD{<c>}{<q>}.F64 {<Dd>}, <Dn>, <Dm>	Encoding T2/A2, encoded as sz = 1

where:

<c>, <q>	See <i>Standard assembler syntax fields on page A8-287</i> . An ARM Advanced SIMD VADD instruction must be unconditional. ARM strongly recommends that a Thumb Advanced SIMD VADD instruction is unconditional, see <i>Conditional execution on page A8-288</i>
<Qd>, <Qn>, <Qm>	The destination vector and the operand vectors, for a quadword operation.
<Dd>, <Dn>, <Dm>	The destination vector and the operand vectors, for a doubleword operation.
<Sd>, <Sn>, <Sm>	The destination vector and the operand vectors, for a singleword operation.

## Operation

```

if ConditionPassed() then
    EncodingSpecificOperations(); CheckAdvSIMDorVFPEEnabled(TRUE, advsimd);
    if advsimd then // Advanced SIMD instruction
        for r = 0 to regs-1
            for e = 0 to elements-1
                Elem[D[d+r],e,esize] = FPAAdd(Elem[D[n+r],e,esize], Elem[D[m+r],e,esize], FALSE);
    else // VFP instruction
        if dp_operation then
            D[d] = FPAAdd(D[n], D[m], TRUE);
        else
            S[d] = FPAAdd(S[n], S[m], TRUE);

```

## Exceptions

Undefined Instruction, Hyp Trap.

### *Floating-point exceptions*

Input Denormal, Invalid Operation, Overflow, Underflow, Inexact.

### A8.8.284 VADDHN

Vector Add and Narrow, returning High Half adds corresponding elements in two quadword vectors, and places the most significant half of each result in a doubleword vector. The results are truncated. (For rounded results, see [VRADDHN on page A8-1022](#)).

The operand elements can be 16-bit, 32-bit, or 64-bit integers. There is no distinction between signed and unsigned integers.

Depending on settings in the CPACR, NSACR, and HCPTR registers, and the security state and mode in which the instruction is executed, an attempt to execute the instruction might be UNDEFINED, or trapped to Hyp mode. [Summary of access controls for Advanced SIMD functionality on page B1-1232](#) summarizes these controls.

ARM deprecates the conditional execution of any Advanced SIMD instruction encoding that is not also available as a VFP instruction encoding, see [Conditional execution on page A8-288](#).

#### Encoding T1/A1 Advanced SIMD

VADDHN<c>.<dt> <Dd>, <Qn>, <Qm>

15	14	13	12	11	10	9	8	7	6	5	4	3	2	1	0	15	14	13	12	11	10	9	8	7	6	5	4	3	2	1	0
1	1	1	0	1	1	1	1	1	D	size	Vn				Vd				0	1	0	0	N	0	M	0	Vm				
31	30	29	28	27	26	25	24	23	22	21	20	19	18	17	16	15	14	13	12	11	10	9	8	7	6	5	4	3	2	1	0
1	1	1	1	0	0	1	0	1	D	size	Vn				Vd				0	1	0	0	N	0	M	0	Vm				

```

if size == '11' then SEE "Related encodings";
if Vn<0> == '1' || Vm<0> == '1' then UNDEFINED;
esize = 8 << UInt(size); elements = 64 DIV esize;
d = UInt(D:Vd); n = UInt(N:Vn); m = UInt(M:Vm);

```

**Related encodings** See [Advanced SIMD data-processing instructions on page A7-261](#).

## Assembler syntax

VADDHN{<c>}{<q>}.<dt> <Dd>, <Qn>, <Qm>

where:

<c>, <q> See [Standard assembler syntax fields on page A8-287](#). An ARM VADDHN instruction must be unconditional. ARM strongly recommends that a Thumb VADDHN instruction is unconditional, see [Conditional execution on page A8-288](#).

<dt> The data type for the elements of the operands. It must be one of:  
I16 size = 0b00.  
I32 size = 0b01.  
I64 size = 0b10.

<Dd>, <Qn>, <Qm> The destination vector, the first operand vector, and the second operand vector.

## Operation

```
if ConditionPassed() then
    EncodingSpecificOperations(); CheckAdvSIMDEnabled();
    for e = 0 to elements-1
        result = Elem[Qin[n>>1],e,2*esize] + Elem[Qin[m>>1],e,2*esize];
        Elem[D[d],e,esize] = result<2*esize-1:esize>;
```

## Exceptions

Undefined Instruction, Hyp Trap.

### A8.8.285 VADDL, VADDW

VADDL (Vector Add Long) adds corresponding elements in two doubleword vectors, and places the results in a quadword vector. Before adding, it sign-extends or zero-extends the elements of both operands.

VADDW (Vector Add Wide) adds corresponding elements in one quadword and one doubleword vector, and places the results in a quadword vector. Before adding, it sign-extends or zero-extends the elements of the doubleword operand.

Depending on settings in the CPACR, NSACR, and HCPTR registers, and the security state and mode in which the instruction is executed, an attempt to execute the instruction might be UNDEFINED, or trapped to Hyp mode. [Summary of access controls for Advanced SIMD functionality on page B1-1232](#) summarizes these controls.

ARM deprecates the conditional execution of any Advanced SIMD instruction encoding that is not also available as a VFP instruction encoding, see [Conditional execution on page A8-288](#).

#### Encoding T1/A1 Advanced SIMD

VADDL<c>.<dt> <Qd>, <Dn>, <Dm>

VADDW<c>.<dt> <Qd>, <Qn>, <Dm>

15	14	13	12	11	10	9	8	7	6	5	4	3	2	1	0	15	14	13	12	11	10	9	8	7	6	5	4	3	2	1	0
1	1	1	U	1	1	1	1	1	D	size	Vn	Vd	0	0	0	op	N	0	M	0	Vm										
31	30	29	28	27	26	25	24	23	22	21	20	19	18	17	16	15	14	13	12	11	10	9	8	7	6	5	4	3	2	1	0
1	1	1	1	0	0	1	U	1	D	size	Vn	Vd	0	0	0	op	N	0	M	0	Vm										

```

if size == '11' then SEE "Related encodings";
if Vd<0> == '1' || (op == '1' && Vn<0> == '1') then UNDEFINED;
unsigned = (U == '1');
esize = 8 << UInt(size); elements = 64 DIV esize; is_vaddw = (op == '1');
d = UInt(D:Vd); n = UInt(N:Vn); m = UInt(M:Vm);

```

**Related encodings** See [Advanced SIMD data-processing instructions on page A7-261](#).

## Assembler syntax

VADDL{<c>}{<q>}.<dt> <Qd>, <Dn>, <Dm> Encoded as op = 0  
VADDW{<c>}{<q>}.<dt> {<Qd>}, <Qn>, <Dm> Encoded as op = 1

where:

- <c>, <q> See [Standard assembler syntax fields on page A8-287](#). An ARM VADDL or VADDW instruction must be unconditional. ARM strongly recommends that a Thumb VADDL or VADDW instruction is unconditional, see [Conditional execution on page A8-288](#).
- <dt> The data type for the elements of the second operand vector. It must be one of:
  - S8 encoded as size = 0b00, U = 0.
  - S16 encoded as size = 0b01, U = 0.
  - S32 encoded as size = 0b10, U = 0.
  - U8 encoded as size = 0b00, U = 1.
  - U16 encoded as size = 0b01, U = 1.
  - U32 encoded as size = 0b10, U = 1.
- <Qd> The destination register. If this register is omitted in a VADDW instruction, it is the same register as <Qn>.
- <Qn>, <Dm> The first and second operand registers for a VADDW instruction.
- <Dn>, <Dm> The first and second operand registers for a VADDL instruction.

## Operation

```

if ConditionPassed() then
    EncodingSpecificOperations(); CheckAdvSIMDEnabled();
    for e = 0 to elements-1
        if is_vaddw then
            op1 = Int(Elem[Qin[n>>1],e,2*esize], unsigned);
        else
            op1 = Int(Elem[Din[n],e,esize], unsigned);
        result = op1 + Int(Elem[Din[m],e,esize], unsigned);
        Elem[Q[d>>1],e,2*esize] = result<2*esize-1:0>;

```

## Exceptions

Undefined Instruction, Hyp Trap.

### A8.8.286 VAND (immediate)

This is a pseudo-instruction, equivalent to a VBIC (immediate) instruction with the immediate value bitwise inverted. For details see *VBIC (immediate)* on page A8-838.

### A8.8.287 VAND (register)

This instruction performs a bitwise AND operation between two registers, and places the result in the destination register.

Depending on settings in the CPACR, NSACR, and HCPTR registers, and the security state and mode in which the instruction is executed, an attempt to execute the instruction might be UNDEFINED, or trapped to Hyp mode. *Summary of access controls for Advanced SIMD functionality* on page B1-1232 summarizes these controls.

ARM deprecates the conditional execution of any Advanced SIMD instruction encoding that is not also available as a VFP instruction encoding, see *Conditional execution* on page A8-288.

#### Encoding T1/A1 Advanced SIMD

VAND<c> <Qd>, <Qn>, <Qm>

VAND<c> <Dd>, <Dn>, <Dm>

15	14	13	12	11	10	9	8	7	6	5	4	3	2	1	0	15	14	13	12	11	10	9	8	7	6	5	4	3	2	1	0
1	1	1	0	1	1	1	1	0	D	0	0	Vn				Vd				0	0	0	1	N	Q	M	1	Vm			

31	30	29	28	27	26	25	24	23	22	21	20	19	18	17	16	15	14	13	12	11	10	9	8	7	6	5	4	3	2	1	0
1	1	1	1	0	0	1	0	0	D	0	0	Vn				Vd				0	0	0	1	N	Q	M	1	Vm			

if Q == '1' && (Vd<0> == '1' || Vn<0> == '1' || Vm<0> == '1') then UNDEFINED;  
d = UInt(D:Vd); n = UInt(N:Vn); m = UInt(M:Vm); regs = if Q == '0' then 1 else 2;



## Assembler syntax

VAND{<C>}{<q>}{.<dt>} {<Qd>}, <Qn>, <Qm> Encoded as Q = 1  
VAND{<C>}{<q>}{.<dt>} {<Dd>}, <Dn>, <Dm> Encoded as Q = 0

where:

<C>, <q> See [Standard assembler syntax fields on page A8-287](#). An ARM VAND instruction must be unconditional. ARM strongly recommends that a Thumb VAND instruction is unconditional, see [Conditional execution on page A8-288](#).

<dt> An optional data type. It is ignored by assemblers, and does not affect the encoding.

<Qd>, <Qn>, <Qm> The destination vector and the operand vectors, for a quadword operation.

<Dd>, <Dn>, <Dm> The destination vector and the operand vectors, for a doubleword operation.

## Operation

```
if ConditionPassed() then
    EncodingSpecificOperations(); CheckAdvSIMDEnabled();
    for r = 0 to regs-1
        D[d+r] = D[n+r] AND D[m+r];
```

## Exceptions

Undefined Instruction, Hyp Trap.

### A8.8.288 VBIC (immediate)

Vector Bitwise Bit Clear (immediate) performs a bitwise AND between a register value and the complement of an immediate value, and returns the result into the destination vector. For the range of constants available, see *One register and a modified immediate value* on page A7-269.

Depending on settings in the CPACR, NSACR, and HCPTR registers, and the security state and mode in which the instruction is executed, an attempt to execute the instruction might be UNDEFINED, or trapped to Hyp mode. *Summary of access controls for Advanced SIMD functionality* on page B1-1232 summarizes these controls.

ARM deprecates the conditional execution of any Advanced SIMD instruction encoding that is not also available as a VFP instruction encoding, see *Conditional execution on page A8-288*.

#### Encoding T1/A1 Advanced SIMD

VBIC<c>.<dt> <Qd>, #<imm>

VBIC<c>.<dt> <Dd>, #<imm>

15	14	13	12	11	10	9	8	7	6	5	4	3	2	1	0	15	14	13	12	11	10	9	8	7	6	5	4	3	2	1	0
1	1	1	i	1	1	1	1	1	D	0	0	0	imm3			Vd															
																cmode		0	Q	1	1	imm4									

31	30	29	28	27	26	25	24	23	22	21	20	19	18	17	16	15	14	13	12	11	10	9	8	7	6	5	4	3	2	1	0
1	1	1	1	0	0	1	i	1	D	0	0	0	imm3			Vd															
																cmode		0	Q	1	1	imm4									

```

if cmode<0> == '0' || cmode<3:2> == '11' then SEE "Related encodings";
if Q == '1' && Vd<0> == '1' then UNDEFINED;
imm64 = AdvSIMDEExpandImm('1', cmode, i:imm3:imm4);
d = UInt(D:Vd); regs = if Q == '0' then 1 else 2;

```

**Related encodings** See *One register and a modified immediate value* on page A7-269.

## Assembler syntax

VBIC{<c>}{<q>}.<dt> {<Qd>}, <Qd>, #<imm> Encoded as Q = 1  
VBIC{<c>}{<q>}.<dt> {<Dd>}, <Dd>, #<imm> Encoded as Q = 0

where:

<c>, <q> See [Standard assembler syntax fields on page A8-287](#). An ARM VBIC instruction must be unconditional. ARM strongly recommends that a Thumb VBIC instruction is unconditional, see [Conditional execution on page A8-288](#).

<dt> The data type used for <imm>. It can be either I16 or I32. I8, I64, and F32 are also permitted, but the resulting syntax is a pseudo-instruction.

<Qd> The destination vector for a quadword operation.

<Dd> The destination vector for a doubleword operation.

<imm> A constant of the type specified by <dt>. This constant is replicated enough times to fill the destination register. For example, VBIC.I32 D0, #10 ANDs the complement of 0x0000000A0000000A with D0, and puts the result into D0.

For details of the range of constants available and the encoding of <dt> and <imm>, see [One register and a modified immediate value on page A7-269](#).

## Operation

```
if ConditionPassed() then
    EncodingSpecificOperations(); CheckAdvSIMDEnabled();
    for r = 0 to regs-1
        D[d+r] = D[d+r] AND NOT(imm64);
```

## Exceptions

Undefined Instruction, Hyp Trap.

## Pseudo-instructions

VAND can be used with a range of constants that are the bitwise inverse of the available constants for VBIC. This is assembled as the equivalent VBIC instruction. Disassembly produces the VBIC form.

[One register and a modified immediate value on page A7-269](#) describes pseudo-instructions with a combination of <dt> and <imm> that is not supported by hardware, but that generates the same destination register value as a different combination that is supported by hardware.

### A8.8.289 VBIC (register)

Vector Bitwise Bit Clear (register) performs a bitwise AND between a register value and the complement of a register value, and places the result in the destination register.

Depending on settings in the CPACR, NSACR, and HCPTR registers, and the security state and mode in which the instruction is executed, an attempt to execute the instruction might be UNDEFINED, or trapped to Hyp mode. [Summary of access controls for Advanced SIMD functionality on page B1-1232](#) summarizes these controls.

ARM deprecates the conditional execution of any Advanced SIMD instruction encoding that is not also available as a VFP instruction encoding, see [Conditional execution on page A8-288](#).

#### Encoding T1/A1 Advanced SIMD

VBIC<c> <Qd>, <Qn>, <Qm>

VBIC<c> <Dd>, <Dn>, <Dm>

15	14	13	12	11	10	9	8	7	6	5	4	3	2	1	0	15	14	13	12	11	10	9	8	7	6	5	4	3	2	1	0
1	1	1	0	1	1	1	1	0	D	0	1	Vn				Vd		0	0	0	1	N	Q	M	1	Vm					

31	30	29	28	27	26	25	24	23	22	21	20	19	18	17	16	15	14	13	12	11	10	9	8	7	6	5	4	3	2	1	0
1	1	1	1	0	0	1	0	0	D	0	1	Vn				Vd		0	0	0	1	N	Q	M	1	Vm					

if Q == '1' && (Vd<0> == '1' || Vn<0> == '1' || Vm<0> == '1') then UNDEFINED;  
d = UInt(D:Vd); n = UInt(N:Vn); m = UInt(M:Vm); regs = if Q == '0' then 1 else 2;

## Assembler syntax

VBIC{<C>}{<q>}{.<dt>} {<Qd>}, <Qn>, <Qm> Encoded as Q = 1  
VBIC{<C>}{<q>}{.<dt>} {<Dd>}, <Dn>, <Dm> Encoded as Q = 0

where:

<C>, <q> See [Standard assembler syntax fields on page A8-287](#). An ARM VBIC instruction must be unconditional. ARM strongly recommends that a Thumb VBIC instruction is unconditional, see [Conditional execution on page A8-288](#).

<dt> An optional data type. It is ignored by assemblers, and does not affect the encoding.

<Qd>, <Qn>, <Qm> The destination vector and the operand vectors, for a quadword operation.

<Dd>, <Dn>, <Dm> The destination vector and the operand vectors, for a doubleword operation.

## Operation

```
if ConditionPassed() then
    EncodingSpecificOperations(); CheckAdvSIMDEnabled();
    for r = 0 to regs-1
        D[d+r] = D[n+r] AND NOT(D[m+r]);
```

## Exceptions

Undefined Instruction, Hyp Trap.

### A8.8.290 VBIF, VBIT, VBSL

VBIF (Vector Bitwise Insert if False), VBIT (Vector Bitwise Insert if True), and VBSL (Vector Bitwise Select) perform bitwise selection under the control of a mask, and place the results in the destination register. The registers can be either quadword or doubleword, and must all be the same size.

Depending on settings in the CPACR, NSACR, and HCPTR registers, and the security state and mode in which the instruction is executed, an attempt to execute the instruction might be UNDEFINED, or trapped to Hyp mode. [Summary of access controls for Advanced SIMD functionality on page B1-1232](#) summarizes these controls.

ARM deprecates the conditional execution of any Advanced SIMD instruction encoding that is not also available as a VFP instruction encoding, see [Conditional execution on page A8-288](#).

#### Encoding T1/A1 Advanced SIMD

V<op><c> <Qd>, <Qn>, <Qm>

V<op><c> <Dd>, <Dn>, <Dm>

15	14	13	12	11	10	9	8	7	6	5	4	3	2	1	0	15	14	13	12	11	10	9	8	7	6	5	4	3	2	1	0
1	1	1	1	1	1	1	1	0	D	op	Vn				Vd		0	0	0	1	N	Q	M	1	Vm						

31	30	29	28	27	26	25	24	23	22	21	20	19	18	17	16	15	14	13	12	11	10	9	8	7	6	5	4	3	2	1	0
1	1	1	1	0	0	1	1	0	D	op	Vn				Vd		0	0	0	1	N	Q	M	1	Vm						

```

if Q == '1' && (Vd<0> == '1' || Vn<0> == '1' || Vm<0> == '1') then UNDEFINED;
if op == '00' then SEE VEOR;
if op == '01' then operation = VBitOps_VBSL;
if op == '10' then operation = VBitOps_VBIT;
if op == '11' then operation = VBitOps_VBIF;
d = UInt(D:Vd); n = UInt(N:Vn); m = UInt(M:Vm); regs = if Q == '0' then 1 else 2;

```

## Assembler syntax

V<op>{<c>}{<q>}{. <dt>} {<Qd>}, <Qn>, <Qm> Encoded as Q = 1  
V<op>{<c>}{<q>}{. <dt>} {<Dd>}, <Dn>, <Dm> Encoded as Q = 0

where:

<op> The operation. It must be one of:

BIF	Bitwise Insert if False, encoded as op = 0b11. Inserts each bit from Vn into Vd if the corresponding bit of Vm is 0, otherwise leaves the Vd bit unchanged.
BIT	Bitwise Insert if True, encoded as op = 0b10. Inserts each bit from Vn into Vd if the corresponding bit of Vm is 1, otherwise leaves the Vd bit unchanged.
BSL	Bitwise Select, encoded as op = 0b01. Selects each bit from Vn into Vd if the corresponding bit of Vd is 1, otherwise selects the bit from Vm.

<c>, <q> See [Standard assembler syntax fields on page A8-287](#). An ARM VBIF, VBIT, or VBSL instruction must be unconditional. ARM strongly recommends that a Thumb VBIF, VBIT, or VBSL instruction is unconditional, see [Conditional execution on page A8-288](#).

<dt> An optional data type. It is ignored by assemblers, and does not affect the encoding.

<Qd>, <Qn>, <Qm> The destination vector and the operand vectors, for a quadword operation.

<Dd>, <Dn>, <Dm> The destination vector and the operand vectors, for a doubleword operation.

## Operation

```
enumeration VBitOps {VBitOps_VBIF, VBitOps_VBIT, VBitOps_VBSL};
```

```
if ConditionPassed() then
    EncodingSpecificOperations(); CheckAdvSIMDEnabled();
    for r = 0 to regs-1
        case operation of
            when VBitOps_VBIF D[d+r] = (D[d+r] AND D[m+r]) OR (D[n+r] AND NOT(D[m+r]));
            when VBitOps_VBIT D[d+r] = (D[n+r] AND D[m+r]) OR (D[d+r] AND NOT(D[m+r]));
            when VBitOps_VBSL D[d+r] = (D[n+r] AND D[d+r]) OR (D[m+r] AND NOT(D[d+r]));
```

## Exceptions

Undefined Instruction, Hyp Trap.

### A8.8.291 VCEQ (register)

VCEQ (Vector Compare Equal) takes each element in a vector, and compares it with the corresponding element of a second vector. If they are equal, the corresponding element in the destination vector is set to all ones. Otherwise, it is set to all zeros.

The operand vector elements can be any one of:

- 8-bit, 16-bit, or 32-bit integers. There is no distinction between signed and unsigned integers.
- 32-bit floating-point numbers.

The result vector elements are fields the same size as the operand vector elements.

Depending on settings in the CPACR, NSACR, and HCPTR registers, and the security state and mode in which the instruction is executed, an attempt to execute the instruction might be UNDEFINED, or trapped to Hyp mode.

*Summary of access controls for Advanced SIMD functionality on page B1-1232* summarizes these controls.

ARM deprecates the conditional execution of any Advanced SIMD instruction encoding that is not also available as a VFP instruction encoding, see *Conditional execution on page A8-288*.

#### Encoding T1/A1 Advanced SIMD

VCEQ<c>.<dt> <Qd>, <Qn>, <Qm>                                  <dt> an integer type  
VCEQ<c>.<dt> <Dd>, <Dn>, <Dm>                                  <dt> an integer type

15	14	13	12	11	10	9	8	7	6	5	4	3	2	1	0	15	14	13	12	11	10	9	8	7	6	5	4	3	2	1	0
1	1	1	1	1	1	1	1	0	D	size		Vn		Vd		1	0	0	0	N	Q	M	1		Vm						

31	30	29	28	27	26	25	24	23	22	21	20	19	18	17	16	15	14	13	12	11	10	9	8	7	6	5	4	3	2	1	0
1	1	1	1	0	0	1	1	0	D	size		Vn		Vd		1	0	0	0	N	Q	M	1		Vm						

```

if Q == '1' && (Vd<0> == '1' || Vn<0> == '1' || Vm<0> == '1') then UNDEFINED;
if size == '11' then UNDEFINED;
int_operation = TRUE; esize = 8 << UInt(size); elements = 64 DIV esize;
d = UInt(D:Vd); n = UInt(N:Vn); m = UInt(M:Vm); regs = if Q == '0' then 1 else 2;

```

#### Encoding T2/A2 Advanced SIMD (UNDEFINED in integer-only variant)

VCEQ<c>.F32 <Qd>, <Qn>, <Qm>  
VCEQ<c>.F32 <Dd>, <Dn>, <Dm>

15	14	13	12	11	10	9	8	7	6	5	4	3	2	1	0	15	14	13	12	11	10	9	8	7	6	5	4	3	2	1	0
1	1	1	0	1	1	1	1	0	D	0	sz		Vn		Vd		1	1	1	0	N	Q	M	0		Vm					

31	30	29	28	27	26	25	24	23	22	21	20	19	18	17	16	15	14	13	12	11	10	9	8	7	6	5	4	3	2	1	0
1	1	1	1	0	0	1	0	0	D	0	sz		Vn		Vd		1	1	1	0	N	Q	M	0		Vm					

```

if Q == '1' && (Vd<0> == '1' || Vn<0> == '1' || Vm<0> == '1') then UNDEFINED;
if sz == '1' then UNDEFINED;
int_operation = FALSE; esize = 32; elements = 2;
d = UInt(D:Vd); n = UInt(N:Vn); m = UInt(M:Vm); regs = if Q == '0' then 1 else 2;

```



## Assembler syntax

VCEQ{<c>}{<q>}.<dt> {<Qd>}, <Qn>, <Qm> Encoded as Q = 1  
VCEQ{<c>}{<q>}.<dt> {<Dd>}, <Dn>, <Dm> Encoded as Q = 0

where:

<c>, <q> See [Standard assembler syntax fields on page A8-287](#). An ARM VCEQ instruction must be unconditional. ARM strongly recommends that a Thumb VCEQ instruction is unconditional, see [Conditional execution on page A8-288](#).

<dt> The data types for the elements of the operands. It must be one of:  
I8 encoding T1/A1, size = 0b00.  
I16 encoding T1/A1, size = 0b01.  
I32 encoding T1/A1, size = 0b10.  
F32 encoding T2/A2, sz = 0.

<Qd>, <Qn>, <Qm> The destination vector and the operand vectors, for a quadword operation.

<Dd>, <Dn>, <Dm> The destination vector and the operand vectors, for a doubleword operation.

## Operation

```
if ConditionPassed() then
    EncodingSpecificOperations(); CheckAdvSIMDEnabled();
    for r = 0 to regs-1
        for e = 0 to elements-1
            op1 = Elem[D[n+r],e,esize]; op2 = Elem[D[m+r],e,esize];
            if int_operation then
                test_passed = (op1 == op2);
            else
                test_passed = FPCompareEQ(op1, op2, FALSE);
            Elem[D[d+r],e,esize] = if test_passed then Ones(esize) else Zeros(esize);
```

## Exceptions

Undefined Instruction, Hyp Trap.

### ***Floating-point exceptions***

Input Denormal, Invalid Operation.

### A8.8.292 VCEQ (immediate #0)

VCEQ #0 (Vector Compare Equal to zero) takes each element in a vector, and compares it with zero. If it is equal to zero, the corresponding element in the destination vector is set to all ones. Otherwise, it is set to all zeros.

The operand vector elements can be any one of:

- 8-bit, 16-bit, or 32-bit integers. There is no distinction between signed and unsigned integers.
- 32-bit floating-point numbers.

The result vector elements are fields the same size as the operand vector elements.

Depending on settings in the CPACR, NSACR, and HCPTR registers, and the security state and mode in which the instruction is executed, an attempt to execute the instruction might be UNDEFINED, or trapped to Hyp mode.

[Summary of access controls for Advanced SIMD functionality on page B1-1232](#) summarizes these controls.

ARM deprecates the conditional execution of any Advanced SIMD instruction encoding that is not also available as a VFP instruction encoding, see [Conditional execution on page A8-288](#).

#### Encoding T1/A1 Advanced SIMD (F = 1 UNDEFINED in integer-only variants)

VCEQ<c>.<dt> <Qd>, <Qm>, #0

VCEQ<c>.<dt> <Dd>, <Dm>, #0

15	14	13	12	11	10	9	8	7	6	5	4	3	2	1	0	15	14	13	12	11	10	9	8	7	6	5	4	3	2	1	0
1	1	1	1	1	1	1	1	D	1	1	size	0	1		Vd	0	F	0	1	0	Q	M	0		Vm						

31	30	29	28	27	26	25	24	23	22	21	20	19	18	17	16	15	14	13	12	11	10	9	8	7	6	5	4	3	2	1	0
1	1	1	1	0	0	1	1	1	D	1	1	size	0	1		Vd	0	F	0	1	0	Q	M	0		Vm					

```

if size == '11' || (F == '1' && size != '10') then UNDEFINED;
if Q == '1' && (Vd<0> == '1' || Vm<0> == '1') then UNDEFINED;
floating_point = (F == '1');
esize = 8 << UInt(size); elements = 64 DIV esize;
d = UInt(D:Vd); m = UInt(M:Vm); regs = if Q == '0' then 1 else 2;

```

## Assembler syntax

VCEQ{<c>}{<q>}.<dt> {<Qd>}, <Qm>, #0 Encoded as Q = 1  
VCEQ{<c>}{<q>}.<dt> {<Dd>}, <Dm>, #0 Encoded as Q = 0

where:

<c>, <q> See *Standard assembler syntax fields* on page A8-287. An ARM VCEQ instruction must be unconditional. ARM strongly recommends that a Thumb VCEQ instruction is unconditional, see *Conditional execution* on page A8-288.

<dt> The data types for the elements of the operands. It must be one of:  
I8 encoded as size = 0b00, F = 0.  
I16 encoded as size = 0b01, F = 0.  
I32 encoded as size = 0b10, F = 0.  
F32 encoded as size = 0b10, F = 1.

<Qd>, <Qm> The destination vector and the operand vector, for a quadword operation.

<Dd>, <Dm> The destination vector and the operand vector, for a doubleword operation.

## Operation

```
if ConditionPassed() then
    EncodingSpecificOperations(); CheckAdvSIMDEnabled();
    for r = 0 to regs-1
        for e = 0 to elements-1
            if floating_point then
                test_passed = FPCompareEQ(Elem[D[m+r],e,esize], FPZero('0',esize), FALSE);
            else
                test_passed = (Elem[D[m+r],e,esize] == Zeros(esize));
            Elem[D[d+r],e,esize] = if test_passed then Ones(esize) else Zeros(esize);
```

## Exceptions

Undefined Instruction, Hyp Trap.

### *Floating-point exceptions*

Input Denormal, Invalid Operation.

### A8.8.293 VCGE (register)

VCGE (Vector Compare Greater Than or Equal) takes each element in a vector, and compares it with the corresponding element of a second vector. If the first is greater than or equal to the second, the corresponding element in the destination vector is set to all ones. Otherwise, it is set to all zeros.

The operand vector elements can be any one of:

- 8-bit, 16-bit, or 32-bit signed integers
- 8-bit, 16-bit, or 32-bit unsigned integers
- 32-bit floating-point numbers.

The result vector elements are fields the same size as the operand vector elements.

Depending on settings in the CPACR, NSACR, and HCPTR registers, and the security state and mode in which the instruction is executed, an attempt to execute the instruction might be UNDEFINED, or trapped to Hyp mode.

[Summary of access controls for Advanced SIMD functionality on page B1-1232](#) summarizes these controls.

ARM deprecates the conditional execution of any Advanced SIMD instruction encoding that is not also available as a VFP instruction encoding, see [Conditional execution on page A8-288](#).

#### Encoding T1/A1 Advanced SIMD

VCGE<c>.<dt> <Qd>, <Qn>, <Qm>                                  <dt> an integer type  
VCGE<c>.<dt> <Dd>, <Dn>, <Dm>                                  <dt> an integer type

15	14	13	12	11	10	9	8	7	6	5	4	3	2	1	0	15	14	13	12	11	10	9	8	7	6	5	4	3	2	1	0
1	1	1	U	1	1	1	1	0	D	size		Vn		Vd		0	0	1	1	N	Q	M	1		Vm						

31	30	29	28	27	26	25	24	23	22	21	20	19	18	17	16	15	14	13	12	11	10	9	8	7	6	5	4	3	2	1	0
1	1	1	1	0	0	1	U	0	D	size		Vn		Vd		0	0	1	1	N	Q	M	1		Vm						

```
if Q == '1' && (Vd<0> == '1' || Vn<0> == '1' || Vm<0> == '1') then UNDEFINED;
if size == '11' then UNDEFINED;
type = if U == '1' then VCGEtype_unsigned else VCGEtype_signed;
esize = 8 << UInt(size); elements = 64 DIV esize;
d = UInt(D:Vd); n = UInt(N:Vn); m = UInt(M:Vm); regs = if Q == '0' then 1 else 2;
```

#### Encoding T2/A2 Advanced SIMD (UNDEFINED in integer-only variant)

VCGE<c>.F32 <Qd>, <Qn>, <Qm>  
VCGE<c>.F32 <Dd>, <Dn>, <Dm>

15	14	13	12	11	10	9	8	7	6	5	4	3	2	1	0	15	14	13	12	11	10	9	8	7	6	5	4	3	2	1	0
1	1	1	1	1	1	1	1	0	D	0	sz		Vn		Vd		1	1	1	0	N	Q	M	0		Vm					

31	30	29	28	27	26	25	24	23	22	21	20	19	18	17	16	15	14	13	12	11	10	9	8	7	6	5	4	3	2	1	0
1	1	1	1	0	0	1	1	0	D	0	sz		Vn		Vd		1	1	1	0	N	Q	M	0		Vm					

```
if Q == '1' && (Vd<0> == '1' || Vn<0> == '1' || Vm<0> == '1') then UNDEFINED;
if sz == '1' then UNDEFINED;
type = VCGEtype_fp; esize = 32; elements = 2;
d = UInt(D:Vd); n = UInt(N:Vn); m = UInt(M:Vm); regs = if Q == '0' then 1 else 2;
```

## Assembler syntax

VCGE{<c>}{<q>}.<dt> {<Qd>,> <Qn>, <Qm> Encoded as Q = 1  
VCGE{<c>}{<q>}.<dt> {<Dd>,> <Dn>, <Dm> Encoded as Q = 0

where:

<c>, <q> See [Standard assembler syntax fields on page A8-287](#). An ARM VCGE instruction must be unconditional. ARM strongly recommends that a Thumb VCGE instruction is unconditional, see [Conditional execution on page A8-288](#).

<dt> The data types for the elements of the operands. It must be one of:

S8 encoding T1/A1, encoded as size = 0b00, U = 0.  
S16 encoding T1/A1, encoded as size = 0b01, U = 0.  
S32 encoding T1/A1, encoded as size = 0b10, U = 0.  
U8 encoding T1/A1, encoded as size = 0b00, U = 1.  
U16 encoding T1/A1, encoded as size = 0b01, U = 1.  
U32 encoding T1/A1, encoded as size = 0b10, U = 1.  
F32 encoding T2/A2, encoded as sz = 0.

<Qd>, <Qn>, <Qm> The destination vector and the operand vectors, for a quadword operation.

<Dd>, <Dn>, <Dm> The destination vector and the operand vectors, for a doubleword operation.

## Operation

```
enumeration VCGEtype {VCGEtype_signed, VCGEtype_unsigned, VCGEtype_fp};
```

```
if ConditionPassed() then
    EncodingSpecificOperations(); CheckAdvSIMDEnabled();
    for r = 0 to regs-1
        for e = 0 to elements-1
            op1 = Elem[D[n+r],e,esize]; op2 = Elem[D[m+r],e,esize];
            case type of
                when VCGEtype_signed test_passed = (SInt(op1) >= SInt(op2));
                when VCGEtype_unsigned test_passed = (UInt(op1) >= UInt(op2));
                when VCGEtype_fp test_passed = FPCompareGE(op1, op2, FALSE);
            Elem[D[d+r],e,esize] = if test_passed then Ones(esize) else Zeros(esize);
```

## Exceptions

Undefined Instruction, Hyp Trap.

### Floating-point exceptions

Input Denormal, Invalid Operation.

### A8.8.294 VCGE (immediate #0)

VCGE #0 (Vector Compare Greater Than or Equal to Zero) take each element in a vector, and compares it with zero. If it is greater than or equal to zero, the corresponding element in the destination vector is set to all ones. Otherwise, it is set to all zeros.

The operand vector elements can be any one of:

- 8-bit, 16-bit, or 32-bit signed integers
- 32-bit floating-point numbers.

The result vector elements are fields the same size as the operand vector elements.

Depending on settings in the CPACR, NSACR, and HCPTR registers, and the security state and mode in which the instruction is executed, an attempt to execute the instruction might be UNDEFINED, or trapped to Hyp mode.

*Summary of access controls for Advanced SIMD functionality on page B1-1232* summarizes these controls.

ARM deprecates the conditional execution of any Advanced SIMD instruction encoding that is not also available as a VFP instruction encoding, see *Conditional execution on page A8-288*.

#### Encoding T1/A1 Advanced SIMD (F = 1 UNDEFINED in integer-only variants)

VCGE<c>.<dt> <Qd>, <Qm>, #0

VCGE<c>.<dt> <Dd>, <Dm>, #0

15	14	13	12	11	10	9	8	7	6	5	4	3	2	1	0	15	14	13	12	11	10	9	8	7	6	5	4	3	2	1	0
1	1	1	1	1	1	1	1	D	1	1	size	0	1		Vd	0	F	0	0	1	Q	M	0		Vm						

31	30	29	28	27	26	25	24	23	22	21	20	19	18	17	16	15	14	13	12	11	10	9	8	7	6	5	4	3	2	1	0
1	1	1	1	0	0	1	1	1	D	1	1	size	0	1		Vd	0	F	0	0	1	Q	M	0		Vm					

```

if size == '11' || (F == '1' && size != '10') then UNDEFINED;
if Q == '1' && (Vd<0> == '1' || Vm<0> == '1') then UNDEFINED;
floating_point = (F == '1');
esize = 8 << UInt(size); elements = 64 DIV esize;
d = UInt(D:Vd); m = UInt(M:Vm); regs = if Q == '0' then 1 else 2;

```

## Assembler syntax

VCGE{<c>}{<q>}.<dt> {<Qd>}, <Qm>, #0 Encoded as Q = 1  
VCGE{<c>}{<q>}.<dt> {<Dd>}, <Dm>, #0 Encoded as Q = 0

where:

<c>, <q> See *Standard assembler syntax fields* on page A8-287. An ARM VCGE instruction must be unconditional. ARM strongly recommends that a Thumb VCGE instruction is unconditional, see *Conditional execution* on page A8-288.

<dt> The data types for the elements of the operands. It must be one of:  
S8 encoded as size = 0b00, F = 0.  
S16 encoded as size = 0b01, F = 0.  
S32 encoded as size = 0b10, F = 0.  
F32 encoded as size = 0b10, F = 1.

<Qd>, <Qm> The destination vector and the operand vector, for a quadword operation.

<Dd>, <Dm> The destination vector and the operand vector, for a doubleword operation.

## Operation

```
if ConditionPassed() then
    EncodingSpecificOperations(); CheckAdvSIMDEnabled();
    for r = 0 to regs-1
        for e = 0 to elements-1
            if floating_point then
                test_passed = FPCompareGE(Elem[D[m+r],e,esize], FPZero('0',esize), FALSE);
            else
                test_passed = (SInt(Elem[D[m+r],e,esize]) >= 0);
            Elem[D[d+r],e,esize] = if test_passed then Ones(esize) else Zeros(esize);
```

## Exceptions

Undefined Instruction, Hyp Trap.

### *Floating-point exceptions*

Input Denormal, Invalid Operation.

## A8.8.295 VCGT (register)

VCGT (Vector Compare Greater Than) takes each element in a vector, and compares it with the corresponding element of a second vector. If the first is greater than the second, the corresponding element in the destination vector is set to all ones. Otherwise, it is set to all zeros.

The operand vector elements can be any one of:

- 8-bit, 16-bit, or 32-bit signed integers
- 8-bit, 16-bit, or 32-bit unsigned integers
- 32-bit floating-point numbers.

The result vector elements are fields the same size as the operand vector elements.

Depending on settings in the CPACR, NSACR, and HCPTR registers, and the security state and mode in which the instruction is executed, an attempt to execute the instruction might be UNDEFINED, or trapped to Hyp mode.

*Summary of access controls for Advanced SIMD functionality on page B1-1232* summarizes these controls.

ARM deprecates the conditional execution of any Advanced SIMD instruction encoding that is not also available as a VFP instruction encoding, see *Conditional execution on page A8-288*.

### Encoding T1/A1 Advanced SIMD

VCGT<c>.<dt> <Qd>, <Qn>, <Qm>                      <dt> an integer type  
VCGT<c>.<dt> <Dd>, <Dn>, <Dm>                      <dt> an integer type

15	14	13	12	11	10	9	8	7	6	5	4	3	2	1	0	15	14	13	12	11	10	9	8	7	6	5	4	3	2	1	0
1	1	1	U	1	1	1	1	0	D	size		Vn		Vd		0	0	1	1	N	Q	M	0		Vm						

31	30	29	28	27	26	25	24	23	22	21	20	19	18	17	16	15	14	13	12	11	10	9	8	7	6	5	4	3	2	1	0
1	1	1	1	0	0	1	U	0	D	size		Vn		Vd		0	0	1	1	N	Q	M	0		Vm						

```
if Q == '1' && (Vd<0> == '1' || Vn<0> == '1' || Vm<0> == '1') then UNDEFINED;
if size == '11' then UNDEFINED;
type = if U == '1' then VCGTtype_unsigned else VCGTtype_signed;
esize = 8 << UInt(size); elements = 64 DIV esize;
d = UInt(D:Vd); n = UInt(N:Vn); m = UInt(M:Vm); regs = if Q == '0' then 1 else 2;
```

### Encoding T2/A2 Advanced SIMD (UNDEFINED in integer-only variant)

VCGT<c>.F32 <Qd>, <Qn>, <Qm>  
VCGT<c>.F32 <Dd>, <Dn>, <Dm>

15	14	13	12	11	10	9	8	7	6	5	4	3	2	1	0	15	14	13	12	11	10	9	8	7	6	5	4	3	2	1	0
1	1	1	1	1	1	1	1	0	D	1	sz		Vn		Vd		1	1	1	0	N	Q	M	0		Vm					

31	30	29	28	27	26	25	24	23	22	21	20	19	18	17	16	15	14	13	12	11	10	9	8	7	6	5	4	3	2	1	0
1	1	1	1	0	0	1	1	0	D	1	sz		Vn		Vd		1	1	1	0	N	Q	M	0		Vm					

```
if Q == '1' && (Vd<0> == '1' || Vn<0> == '1' || Vm<0> == '1') then UNDEFINED;
if sz == '1' then UNDEFINED;
type = VCGTtype_fp; esize = 32; elements = 2;
d = UInt(D:Vd); n = UInt(N:Vn); m = UInt(M:Vm); regs = if Q == '0' then 1 else 2;
```



## Assembler syntax

VCGT{<c>}{<q>}.<dt> {<Qd>,> <Qn>, <Qm> Encoded as Q = 1  
VCGT{<c>}{<q>}.<dt> {<Dd>,> <Dn>, <Dm> Encoded as Q = 0

where:

<c>, <q> See [Standard assembler syntax fields on page A8-287](#). An ARM VCGT instruction must be unconditional. ARM strongly recommends that a Thumb VCGT instruction is unconditional, see [Conditional execution on page A8-288](#).

<dt> The data types for the elements of the operands. It must be one of:

S8	encoding T1/A1, encoded as size = 0b00, U = 0.
S16	encoding T1/A1, encoded as size = 0b01, U = 0.
S32	encoding T1/A1, encoded as size = 0b10, U = 0.
U8	encoding T1/A1, encoded as size = 0b00, U = 1.
U16	encoding T1/A1, encoded as size = 0b01, U = 1.
U32	encoding T1/A1, encoded as size = 0b10, U = 1.
F32	encoding T2/A2, encoded as sz = 0.

<Qd>, <Qn>, <Qm> The destination vector and the operand vectors, for a quadword operation.

<Dd>, <Dn>, <Dm> The destination vector and the operand vectors, for a doubleword operation.

## Operation

```
enumeration VCGTtype {VCGTtype_signed, VCGTtype_unsigned, VCGTtype_fp};
```

```
if ConditionPassed() then
    EncodingSpecificOperations(); CheckAdvSIMDEnabled();
    for r = 0 to regs-1
        for e = 0 to elements-1
            op1 = Elem[D[n+r],e,esize]; op2 = Elem[D[m+r],e,esize];
            case type of
                when VCGTtype_signed test_passed = (SInt(op1) > SInt(op2));
                when VCGTtype_unsigned test_passed = (UInt(op1) > UInt(op2));
                when VCGTtype_fp test_passed = FPCompareGT(op1, op2, FALSE);
            Elem[D[d+r],e,esize] = if test_passed then Ones(esize) else Zeros(esize);
```

## Exceptions

Undefined Instruction, Hyp Trap.

### Floating-point exceptions

Input Denormal, Invalid Operation.

### A8.8.296 VCGT (immediate #0)

VCGT #0 (Vector Compare Greater Than Zero) take each element in a vector, and compares it with zero. If it is greater than zero, the corresponding element in the destination vector is set to all ones. Otherwise, it is set to all zeros.

The operand vector elements can be any one of:

- 8-bit, 16-bit, or 32-bit signed integers
- 32-bit floating-point numbers.

The result vector elements are fields the same size as the operand vector elements.

Depending on settings in the CPACR, NSACR, and HCPTR registers, and the security state and mode in which the instruction is executed, an attempt to execute the instruction might be UNDEFINED, or trapped to Hyp mode.

[Summary of access controls for Advanced SIMD functionality on page B1-1232](#) summarizes these controls.

ARM deprecates the conditional execution of any Advanced SIMD instruction encoding that is not also available as a VFP instruction encoding, see [Conditional execution on page A8-288](#).

#### Encoding T1/A1 Advanced SIMD (F = 1 UNDEFINED in integer-only variants)

VCGT<c>.<dt> <Qd>, <Qm>, #0

VCGT<c>.<dt> <Dd>, <Dm>, #0

15	14	13	12	11	10	9	8	7	6	5	4	3	2	1	0	15	14	13	12	11	10	9	8	7	6	5	4	3	2	1	0
1	1	1	1	1	1	1	1	D	1	1	size	0	1		Vd	0	F	0	0	0	Q	M	0		Vm						

31	30	29	28	27	26	25	24	23	22	21	20	19	18	17	16	15	14	13	12	11	10	9	8	7	6	5	4	3	2	1	0
1	1	1	1	0	0	1	1	1	D	1	1	size	0	1		Vd	0	F	0	0	0	Q	M	0		Vm					

```

if size == '11' || (F == '1' && size != '10') then UNDEFINED;
if Q == '1' && (Vd<0> == '1' || Vm<0> == '1') then UNDEFINED;
floating_point = (F == '1');
esize = 8 << UInt(size); elements = 64 DIV esize;
d = UInt(D:Vd); m = UInt(M:Vm); regs = if Q == '0' then 1 else 2;

```

## Assembler syntax

VCGT{<c>}{<q>}.<dt> {<Qd>}, <Qm>, #0 Encoded as Q = 1  
VCVT{<c>}{<q>}.<dt> {<Dd>}, <Dm>, #0 Encoded as Q = 0

where:

<c>, <q> See *Standard assembler syntax fields* on page A8-287. An ARM VCGT instruction must be unconditional. ARM strongly recommends that a Thumb VCGT instruction is unconditional, see *Conditional execution* on page A8-288.

<dt> The data types for the elements of the operands. It must be one of:  
S8 encoded as size = 0b00, F = 0.  
S16 encoded as size = 0b01, F = 0.  
S32 encoded as size = 0b10, F = 0.  
F32 encoded as size = 0b10, F = 1.

<Qd>, <Qm> The destination vector and the operand vector, for a quadword operation.

<Dd>, <Dm> The destination vector and the operand vector, for a doubleword operation.

## Operation

```
if ConditionPassed() then
    EncodingSpecificOperations(); CheckAdvSIMDEnabled();
    for r = 0 to regs-1
        for e = 0 to elements-1
            if floating_point then
                test_passed = FPCompareGT(Elem[D[m+r],e,esize], FPZero('0',esize), FALSE);
            else
                test_passed = (SInt(Elem[D[m+r],e,esize]) > 0);
            Elem[D[d+r],e,esize] = if test_passed then Ones(esize) else Zeros(esize);
```

## Exceptions

Undefined Instruction, Hyp Trap.

### *Floating-point exceptions*

Input Denormal, Invalid Operation.

### A8.8.297 VCLE (register)

VCLE is a pseudo-instruction, equivalent to a VCGE instruction with the operands reversed. For details see [VCGE \(register\)](#) on page A8-848.

### A8.8.298 VCLE (immediate #0)

VCLE #0 (Vector Compare Less Than or Equal to Zero) take each element in a vector, and compares it with zero. If it is less than or equal to zero, the corresponding element in the destination vector is set to all ones. Otherwise, it is set to all zeros.

The operand vector elements can be any one of:

- 8-bit, 16-bit, or 32-bit signed integers
- 32-bit floating-point numbers.

The result vector elements are fields the same size as the operand vector elements.

Depending on settings in the CPACR, NSACR, and HCPTR registers, and the security state and mode in which the instruction is executed, an attempt to execute the instruction might be UNDEFINED, or trapped to Hyp mode. [Summary of access controls for Advanced SIMD functionality on page B1-1232](#) summarizes these controls.

ARM deprecates the conditional execution of any Advanced SIMD instruction encoding that is not also available as a VFP instruction encoding, see [Conditional execution on page A8-288](#).

#### Encoding T1/A1 Advanced SIMD (F = 1 UNDEFINED in integer-only variants)

VCLE<c>.<dt> <Qd>, <Qm>, #0

VCLE<c>.<dt> <Dd>, <Dm>, #0

15	14	13	12	11	10	9	8	7	6	5	4	3	2	1	0	15	14	13	12	11	10	9	8	7	6	5	4	3	2	1	0
1	1	1	1	1	1	1	1	1	D	1	1	size	0	1		Vd	0	F	0	1	1	Q	M	0		Vm					

31	30	29	28	27	26	25	24	23	22	21	20	19	18	17	16	15	14	13	12	11	10	9	8	7	6	5	4	3	2	1	0
1	1	1	1	0	0	1	1	1	D	1	1	size	0	1		Vd	0	F	0	1	1	Q	M	0		Vm					

```

if size == '11' || (F == '1' && size != '10') then UNDEFINED;
if Q == '1' && (Vd<0> == '1' || Vm<0> == '1') then UNDEFINED;
floating_point = (F == '1');
esize = 8 << UInt(size); elements = 64 DIV esize;
d = UInt(D:Vd); m = UInt(M:Vm); regs = if Q == '0' then 1 else 2;

```

## Assembler syntax

VCLE{<c>}{<q>}.<dt> {<Qd>}, <Qm>, #0 Encoded as Q = 1  
VCLE{<c>}{<q>}.<dt> {<Dd>}, <Dm>, #0 Encoded as Q = 0

where:

<c>, <q> See [Standard assembler syntax fields on page A8-287](#). An ARM VCLE instruction must be unconditional. ARM strongly recommends that a Thumb VCLE instruction is unconditional, see [Conditional execution on page A8-288](#).

<dt> The data types for the elements of the operands. It must be one of:

S8 encoded as size = 0b00, F = 0.  
S16 encoded as size = 0b01, F = 0.  
S32 encoded as size = 0b10, F = 0.  
F32 encoded as size = 0b10, F = 1.

<Qd>, <Qm> The destination vector and the operand vector, for a quadword operation.

<Dd>, <Dm> The destination vector and the operand vector, for a doubleword operation.

## Operation

```
if ConditionPassed() then
    EncodingSpecificOperations(); CheckAdvSIMDEnabled();
    for r = 0 to regs-1
        for e = 0 to elements-1
            if floating_point then
                test_passed = FPCompareGE(FPZero('0', esize), Elem[D[m+r],e,esize], FALSE);
            else
                test_passed = (SInt(Elem[D[m+r],e,esize]) <= 0);
            Elem[D[d+r],e,esize] = if test_passed then Ones(esize) else Zeros(esize);
```

## Exceptions

Undefined Instruction, Hyp Trap.

### ***Floating-point exceptions***

Input Denormal, Invalid Operation.

### A8.8.299 VCLS

Vector Count Leading Sign Bits counts the number of consecutive bits following the topmost bit, that are the same as the topmost bit, in each element in a vector, and places the results in a second vector. The count does not include the topmost bit itself.

The operand vector elements can be any one of 8-bit, 16-bit, or 32-bit signed integers.

The result vector elements are the same data type as the operand vector elements.

Depending on settings in the CPACR, NSACR, and HCPTR registers, and the security state and mode in which the instruction is executed, an attempt to execute the instruction might be UNDEFINED, or trapped to Hyp mode.

[Summary of access controls for Advanced SIMD functionality on page B1-1232](#) summarizes these controls.

ARM deprecates the conditional execution of any Advanced SIMD instruction encoding that is not also available as a VFP instruction encoding, see [Conditional execution on page A8-288](#).

#### Encoding T1/A1 Advanced SIMD

VCLS<c>.<dt> <Qd>, <Qm>

VCLS<c>.<dt> <Dd>, <Dm>

15	14	13	12	11	10	9	8	7	6	5	4	3	2	1	0	15	14	13	12	11	10	9	8	7	6	5	4	3	2	1	0
1	1	1	1	1	1	1	1	1	D	1	1	size	0	0	Vd	0	1	0	0	0	Q	M	0	Vm							

31	30	29	28	27	26	25	24	23	22	21	20	19	18	17	16	15	14	13	12	11	10	9	8	7	6	5	4	3	2	1	0
1	1	1	1	0	0	1	1	1	D	1	1	size	0	0	Vd	0	1	0	0	0	Q	M	0	Vm							

```

if size == '11' then UNDEFINED;
if Q == '1' && (Vd<0> == '1' || Vm<0> == '1') then UNDEFINED;
esize = 8 << UInt(size); elements = 64 DIV esize;
d = UInt(D:Vd); m = UInt(M:Vm); regs = if Q == '0' then 1 else 2;

```

## Assembler syntax

VCLS{<c>}{<q>}.<dt> <Qd>, <Qm> Encoded as Q = 1  
VCLS{<c>}{<q>}.<dt> <Dd>, <Dm> Encoded as Q = 0

where:

<c>, <q> See [Standard assembler syntax fields on page A8-287](#). An ARM VCLS instruction must be unconditional. ARM strongly recommends that a Thumb VCLS instruction is unconditional, see [Conditional execution on page A8-288](#).

<dt> The data size for the elements of the operands. It must be one of:  
S8 encoded as size = 0b00.  
S16 encoded as size = 0b01.  
S32 encoded as size = 0b10.

<Qd>, <Qm> The destination vector and the operand vector, for a quadword operation.

<Dd>, <Dm> The destination vector and the operand vector, for a doubleword operation.

## Operation

```
if ConditionPassed() then
    EncodingSpecificOperations(); CheckAdvSIMDEnabled();
    for r = 0 to regs-1
        for e = 0 to elements-1
            Elem[D[d+r],e,esize] = CountLeadingSignBits(Elem[D[m+r],e,esize]);
```

## Exceptions

Undefined Instruction, Hyp Trap.

### A8.8.300 VCLT (register)

VCLT is a pseudo-instruction, equivalent to a VCGT instruction with the operands reversed. For details see [VCGT \(register\)](#) on page A8-852.

### A8.8.301 VCLT (immediate #0)

VCLT #0 (Vector Compare Less Than Zero) take each element in a vector, and compares it with zero. If it is less than zero, the corresponding element in the destination vector is set to all ones. Otherwise, it is set to all zeros.

The operand vector elements can be any one of:

- 8-bit, 16-bit, or 32-bit signed integers
- 32-bit floating-point numbers.

The result vector elements are fields the same size as the operand vector elements.

Depending on settings in the CPACR, NSACR, and HCPTR registers, and the security state and mode in which the instruction is executed, an attempt to execute the instruction might be UNDEFINED, or trapped to Hyp mode. [Summary of access controls for Advanced SIMD functionality on page B1-1232](#) summarizes these controls.

ARM deprecates the conditional execution of any Advanced SIMD instruction encoding that is not also available as a VFP instruction encoding, see [Conditional execution on page A8-288](#).

#### Encoding T1/A1 Advanced SIMD (F = 1 UNDEFINED in integer-only variants)

VCLT<c>.<dt> <Qd>, <Qm>, #0

VCLT<c>.<dt> <Dd>, <Dm>, #0

15	14	13	12	11	10	9	8	7	6	5	4	3	2	1	0	15	14	13	12	11	10	9	8	7	6	5	4	3	2	1	0
1	1	1	1	1	1	1	1	1	D	1	1	size	0	1	Vd	0	F	1	0	0	Q	M	0	Vm							

31	30	29	28	27	26	25	24	23	22	21	20	19	18	17	16	15	14	13	12	11	10	9	8	7	6	5	4	3	2	1	0
1	1	1	1	0	0	1	1	1	D	1	1	size	0	1	Vd	0	F	1	0	0	Q	M	0	Vm							

```

if size == '11' || (F == '1' && size != '10') then UNDEFINED;
if Q == '1' && (Vd<0> == '1' || Vm<0> == '1') then UNDEFINED;
floating_point = (F == '1');
esize = 8 << UInt(size); elements = 64 DIV esize;
d = UInt(D:Vd); m = UInt(M:Vm); regs = if Q == '0' then 1 else 2;

```



## Assembler syntax

VCLT{<c>}{<q>}.<dt> {<Qd>}, <Qm>, #0 Encoded as Q = 1  
VCLT{<c>}{<q>}.<dt> {<Dd>}, <Dm>, #0 Encoded as Q = 0

where:

<c>, <q> See [Standard assembler syntax fields on page A8-287](#). An ARM VCLT instruction must be unconditional. ARM strongly recommends that a Thumb VCLT instruction is unconditional, see [Conditional execution on page A8-288](#).

<dt> The data types for the elements of the operands. It must be one of:

S8 encoded as size = 0b00, F = 0.  
S16 encoded as size = 0b01, F = 0.  
S32 encoded as size = 0b10, F = 0.  
F32 encoded as size = 0b10, F = 1.

<Qd>, <Qm> The destination vector and the operand vector, for a quadword operation.

<Dd>, <Dm> The destination vector and the operand vector, for a doubleword operation.

## Operation

```
if ConditionPassed() then
    EncodingSpecificOperations(); CheckAdvSIMDEnabled();
    for r = 0 to regs-1
        for e = 0 to elements-1
            if floating_point then
                test_passed = FPCompareGT(FPZero('0', esize), Elem[D[m+r],e,esize], FALSE);
            else
                test_passed = (SInt(Elem[D[m+r],e,esize]) < 0);
            Elem[D[d+r],e,esize] = if test_passed then Ones(esize) else Zeros(esize);
```

## Exceptions

Undefined Instruction, Hyp Trap.

### ***Floating-point exceptions***

Input Denormal, Invalid Operation.

### A8.8.302 VCLZ

Vector Count Leading Zeros counts the number of consecutive zeros, starting from the most significant bit, in each element in a vector, and places the results in a second vector.

The operand vector elements can be any one of 8-bit, 16-bit, or 32-bit integers. There is no distinction between signed and unsigned integers.

The result vector elements are the same data type as the operand vector elements.

Depending on settings in the CPACR, NSACR, and HCPTR registers, and the security state and mode in which the instruction is executed, an attempt to execute the instruction might be UNDEFINED, or trapped to Hyp mode.

[Summary of access controls for Advanced SIMD functionality on page B1-1232](#) summarizes these controls.

ARM deprecates the conditional execution of any Advanced SIMD instruction encoding that is not also available as a VFP instruction encoding, see [Conditional execution on page A8-288](#).

#### Encoding T1/A1 Advanced SIMD

VCLZ<c>.<dt> <Qd>, <Qm>

VCLZ<c>.<dt> <Dd>, <Dm>

15	14	13	12	11	10	9	8	7	6	5	4	3	2	1	0	15	14	13	12	11	10	9	8	7	6	5	4	3	2	1	0
1	1	1	1	1	1	1	1	1	D	1	1	size	0	0	Vd	0	1	0	0	1	Q	M	0	Vm							

31	30	29	28	27	26	25	24	23	22	21	20	19	18	17	16	15	14	13	12	11	10	9	8	7	6	5	4	3	2	1	0
1	1	1	1	0	0	1	1	1	D	1	1	size	0	0	Vd	0	1	0	0	1	Q	M	0	Vm							

```

if size == '11' then UNDEFINED;
if Q == '1' && (Vd<0> == '1' || Vm<0> == '1') then UNDEFINED;
esize = 8 << UInt(size); elements = 64 DIV esize;
d = UInt(D:Vd); m = UInt(M:Vm); regs = if Q == '0' then 1 else 2;

```

## Assembler syntax

VCLZ{<c>}{<q>}.<dt> <Qd>, <Qm> Encoded as Q = 1  
VCLZ{<c>}{<q>}.<dt> <Dd>, <Dm> Encoded as Q = 0

where:

<c>, <q> See [Standard assembler syntax fields on page A8-287](#). An ARM VCLZ instruction must be unconditional. ARM strongly recommends that a Thumb VCLZ instruction is unconditional, see [Conditional execution on page A8-288](#).

<dt> The data size for the elements of the operands. It must be one of:  
I8 encoded as size = 0b00.  
I16 encoded as size = 0b01.  
I32 encoded as size = 0b10.

<Qd>, <Qm> The destination vector and the operand vector, for a quadword operation.

<Dd>, <Dm> The destination vector and the operand vector, for a doubleword operation.

## Operation

```
if ConditionPassed() then
    EncodingSpecificOperations(); CheckAdvSIMDEnabled();
    for r = 0 to regs-1
        for e = 0 to elements-1
            Elem[D[d+r],e,esize] = CountLeadingZeroBits(Elem[D[m+r],e,esize]);
```

## Exceptions

Undefined Instruction, Hyp Trap.

### A8.8.303 VCMP, VCMPE

This instruction compares two floating-point registers, or one floating-point register and zero. It writes the result to the **FPSCR** flags. These are normally transferred to the ARM flags by a subsequent **VMRS** instruction.

It can optionally raise an Invalid Operation exception if either operand is any type of NaN. It always raises an Invalid Operation exception if either operand is a signaling NaN.

Depending on settings in the **CPACR**, **NSACR**, and **HCPTR** registers, and the security state and mode in which the instruction is executed, an attempt to execute the instruction might be **UNDEFINED**, or trapped to Hyp mode. [Summary of general controls of CP10 and CP11 functionality on page B1-1230](#) summarizes these controls.

**Encoding T1/A1** VFPv2, VFPv3, VFPv4 (sz = 1 UNDEFINED in single-precision only variants)

VCMP{E}<c>.F64 <Dd>, <Dm>

VCMP{E}<c>.F32 <Sd>, <Sm>

15	14	13	12	11	10	9	8	7	6	5	4	3	2	1	0	15	14	13	12	11	10	9	8	7	6	5	4	3	2	1	0
1	1	1	0	1	1	1	0	1	D	1	1	0	1	0	0	Vd	1	0	1	sz	E	1	M	0	Vm						

31	30	29	28	27	26	25	24	23	22	21	20	19	18	17	16	15	14	13	12	11	10	9	8	7	6	5	4	3	2	1	0
cond	1	1	1	0	1	D	1	1	0	1	0	0	Vd	1	0	1	sz	E	1	M	0	Vm									

```
dp_operation = (sz == '1'); quiet_nan_exc = (E == '1'); with_zero = FALSE;
d = if dp_operation then UInt(D:Vd) else UInt(Vd:D);
m = if dp_operation then UInt(M:Vm) else UInt(Vm:M);
```

**Encoding T2/A2** VFPv2, VFPv3, VFPv4 (sz = 1 UNDEFINED in single-precision only variants)

VCMP{E}<c>.F64 <Dd>, #0.0

VCMP{E}<c>.F32 <Sd>, #0.0

15	14	13	12	11	10	9	8	7	6	5	4	3	2	1	0	15	14	13	12	11	10	9	8	7	6	5	4	3	2	1	0
1	1	1	0	1	1	1	0	1	D	1	1	0	1	0	1	Vd	1	0	1	sz	E	1	(0)	0	(0)	(0)	(0)	(0)			

31	30	29	28	27	26	25	24	23	22	21	20	19	18	17	16	15	14	13	12	11	10	9	8	7	6	5	4	3	2	1	0
cond	1	1	1	0	1	D	1	1	0	1	0	1	Vd	1	0	1	sz	E	1	(0)	0	(0)	(0)	(0)	(0)						

```
dp_operation = (sz == '1'); quiet_nan_exc = (E == '1'); with_zero = TRUE;
d = if dp_operation then UInt(D:Vd) else UInt(Vd:D);
```

## Assembler syntax

VCMP{E}{<C>}{<q>}.F64 <Dd>, <Dm>	Encoding T1/A1, encoded as sz = 1
VCMP{E}{<C>}{<q>}.F32 <Sd>, <Sm>	Encoding T1/A1, encoded as sz = 0
VCMP{E}{<C>}{<q>}.F64 <Dd>, #0.0	Encoding T2/A2, encoded as sz = 1
VCMP{E}{<C>}{<q>}.F32 <Sd>, #0.0	Encoding T2/A2, encoded as sz = 0

where:

E If present, any NaN operand causes an Invalid Operation exception. Encoded as E = 1.  
Otherwise, only a signaling NaN causes the exception. Encoded as E = 0.

<C>, <q> See [Standard assembler syntax fields on page A8-287](#).

<Dd>, <Dm> The operand vectors, for a doubleword operation.

<Sd>, <Sm> The operand vectors, for a singleword operation.

## Operation

```

if ConditionPassed() then
    EncodingSpecificOperations(); CheckVFPEnabled(TRUE);
    if dp_operation then
        op2 = if with_zero then FPZero('0',64) else D[m];
        (FPSCR.N, FPSCR.Z, FPSCR.C, FPSCR.V) = FPCompare(D[d], op2, quiet_nan_exc, TRUE);
    else
        op2 = if with_zero then FPZero('0',32) else S[m];
        (FPSCR.N, FPSCR.Z, FPSCR.C, FPSCR.V) = FPCompare(S[d], op2, quiet_nan_exc, TRUE);

```

## Exceptions

Undefined Instruction, Hyp Trap.

### ***Floating-point exceptions***

Invalid Operation, Input Denormal.

## NaNs

The IEEE 754 standard specifies that the result of a comparison is precisely one of <, ==, > or *unordered*. If either or both of the operands are NaNs, they are unordered, and all three of (Operand1 < Operand2), (Operand1 == Operand2) and (Operand1 > Operand2) are false. This results in the **FPSCR** flags being set as N=0, Z=0, C=1 and V=1.

VCMP<sub>E</sub> raises an Invalid Operation exception if either operand is any type of NaN, and is suitable for testing for <, <=, >, >=, and other predicates that raise an exception when the operands are unordered.

### A8.8.304 VCNT

This instruction counts the number of bits that are one in each element in a vector, and places the results in a second vector.

The operand vector elements must be 8-bit fields.

The result vector elements are 8-bit integers.

Depending on settings in the CPACR, NSACR, and HCPTR registers, and the security state and mode in which the instruction is executed, an attempt to execute the instruction might be UNDEFINED, or trapped to Hyp mode. [Summary of access controls for Advanced SIMD functionality on page B1-1232](#) summarizes these controls.

ARM deprecates the conditional execution of any Advanced SIMD instruction encoding that is not also available as a VFP instruction encoding, see [Conditional execution on page A8-288](#).

#### Encoding T1/A1 Advanced SIMD

VCNT<c>.8 <Qd>, <Qm>

VCNT<c>.8 <Dd>, <Dm>

15	14	13	12	11	10	9	8	7	6	5	4	3	2	1	0	15	14	13	12	11	10	9	8	7	6	5	4	3	2	1	0
1	1	1	1	1	1	1	1	D	1	1	size	0	0			Vd	0	1	0	1	0	Q	M	0			Vm				

31	30	29	28	27	26	25	24	23	22	21	20	19	18	17	16	15	14	13	12	11	10	9	8	7	6	5	4	3	2	1	0
1	1	1	1	0	0	1	1	1	D	1	1	size	0	0			Vd	0	1	0	1	0	Q	M	0			Vm			

```

if size != '00' then UNDEFINED;
if Q == '1' && (Vd<0> == '1' || Vm<0> == '1') then UNDEFINED;
esize = 8; elements = 8;
d = UInt(D:Vd); m = UInt(M:Vm); regs = if Q == '0' then 1 else 2;

```

## Assembler syntax

VCNT{<C>}{<q>}.8 <Qd>, <Qm> Encoded as Q = 1  
VCNT{<C>}{<q>}.8 <Dd>, <Dm> Encoded as Q = 0

where:

<C>, <q> See [Standard assembler syntax fields on page A8-287](#). An ARM VCNT instruction must be unconditional. ARM strongly recommends that a Thumb VCNT instruction is unconditional, see [Conditional execution on page A8-288](#).

<Qd>, <Qm> The destination vector and the operand vector, for a quadword operation.

<Dd>, <Dm> The destination vector and the operand vector, for a doubleword operation.

## Operation

```
if ConditionPassed() then
    EncodingSpecificOperations(); CheckAdvSIMDEnabled();
    for r = 0 to regs-1
        for e = 0 to elements-1
            Elem[D[d+r],e,esize] = BitCount(Elem[D[m+r],e,esize]);
```

## Exceptions

Undefined Instruction, Hyp Trap.

### A8.8.305 VCVT (between floating-point and integer, Advanced SIMD)

This instruction converts each element in a vector from floating-point to integer, or from integer to floating-point, and places the results in a second vector.

The vector elements must be 32-bit floating-point numbers, or 32-bit integers. Signed and unsigned integers are distinct.

The floating-point to integer operation uses the Round towards Zero rounding mode. The integer to floating-point operation uses the Round to Nearest rounding mode.

Depending on settings in the CPACR, NSACR, and HCPTR registers, and the security state and mode in which the instruction is executed, an attempt to execute the instruction might be UNDEFINED, or trapped to Hyp mode. [Summary of access controls for Advanced SIMD functionality on page B1-1232](#) summarizes these controls.

ARM deprecates the conditional execution of any Advanced SIMD instruction encoding that is not also available as a VFP instruction encoding, see [Conditional execution on page A8-288](#).

#### Encoding T1/A1 Advanced SIMD (UNDEFINED in integer-only variant)

VCVT<c>.<Td>.<Tm> <Qd>, <Qm>

VCVT<c>.<Td>.<Tm> <Dd>, <Dm>

15	14	13	12	11	10	9	8	7	6	5	4	3	2	1	0	15	14	13	12	11	10	9	8	7	6	5	4	3	2	1	0
1	1	1	1	1	1	1	1	1	D	1	1	size	1	1		Vd		0	1	1	op	Q	M	0		Vm					

31	30	29	28	27	26	25	24	23	22	21	20	19	18	17	16	15	14	13	12	11	10	9	8	7	6	5	4	3	2	1	0
1	1	1	1	0	0	1	1	1	D	1	1	size	1	1		Vd		0	1	1	op	Q	M	0		Vm					

```

if Q == '1' && (Vd<0> == '1' || Vm<0> == '1') then UNDEFINED;
if size != '10' then UNDEFINED;
to_integer = (op<1> == '1'); unsigned = (op<0> == '1'); esize = 32; elements = 2;
if to_integer then
    round_zero = TRUE; // Variable name indicates purpose of FPToFixed() argument
else
    round_nearest = TRUE; // Variable name indicates purpose of FixedToFP() argument
d = UInt(D:Vd); m = UInt(M:Vm); regs = if Q == '0' then 1 else 2;

```



## Assembler syntax

VCVT{<C>}{<q>}.<Td>.<Tm> <Qd>, <Qm> Encoded as Q = 1  
VCVT{<C>}{<q>}.<Td>.<Tm> <Dd>, <Dm> Encoded as Q = 0

where:

<C>, <q> See *Standard assembler syntax fields on page A8-287*. An ARM Advanced SIMD VCVT instruction must be unconditional. ARM strongly recommends that a Thumb Advanced SIMD VCVT instruction is unconditional, see *Conditional execution on page A8-288*.

.<Td>.<Tm> The data types for the elements of the vectors. They must be one of:  
.S32.F32 encoded as op = 0b10, size = 0b10.  
.U32.F32 encoded as op = 0b11, size = 0b10.  
.F32.S32 encoded as op = 0b00, size = 0b10.  
.F32.U32 encoded as op = 0b01, size = 0b10.

<Qd>, <Qm> The destination vector and the operand vector, for a quadword operation.

<Dd>, <Dm> The destination vector and the operand vector, for a doubleword operation.

## Operation

```
if ConditionPassed() then
    EncodingSpecificOperations(); CheckAdvSIMDEnabled();
    for r = 0 to regs-1
        for e = 0 to elements-1
            op = Elem[D[m+r],e,esize];
            if to_integer then
                result = FPToFixed(op, esize, 0, unsigned, round_zero, FALSE);
            else
                result = FixedToFP(op, esize, 0, unsigned, round_nearest, FALSE);
            Elem[D[d+r],e,esize] = result;
```

## Exceptions

Undefined Instruction, Hyp Trap.

### *Floating-point exceptions*

Input Denormal, Invalid Operation, Inexact.

### A8.8.306 VCVT, VCVTR (between floating-point and integer, Floating-point)

These instructions convert a value in a register from floating-point to a 32-bit integer, or from a 32-bit integer to floating-point, and place the result in a second register.

The floating-point to integer operation normally uses the Round towards Zero rounding mode, but can optionally use the rounding mode specified by the **FPSCR**. The integer to floating-point operation uses the rounding mode specified by the **FPSCR**.

*VCVT (between floating-point and fixed-point, Floating-point)* on page A8-874 describes conversions between floating-point and 16-bit integers.

Depending on settings in the **CPACR**, **NSACR**, **HCPTR**, and **FPEXC** registers, and the security state and mode in which the instruction is executed, an attempt to execute the instruction might be UNDEFINED, or trapped to Hyp mode. *Summary of general controls of CP10 and CP11 functionality* on page B1-1230 summarizes these controls.

**Encoding T1/A1** VFPv2, VFPv3, VFPv4 (sz = 1 UNDEFINED in single-precision only variants)

VCVT{R}<c>.S32.F64 <Sd>, <Dm>

VCVT{R}<c>.S32.F32 <Sd>, <Sm>

VCVT{R}<c>.U32.F64 <Sd>, <Dm>

VCVT{R}<c>.U32.F32 <Sd>, <Sm>

VCVT<c>.F64.<Tm> <Dd>, <Sm>

VCVT<c>.F32.<Tm> <Sd>, <Sm>

15	14	13	12	11	10	9	8	7	6	5	4	3	2	1	0	15	14	13	12	11	10	9	8	7	6	5	4	3	2	1	0
1	1	1	0	1	1	1	0	1	D	1	1	1	opc2			Vd				1	0	1	sz	op	1	M	0		Vm		

31	30	29	28	27	26	25	24	23	22	21	20	19	18	17	16	15	14	13	12	11	10	9	8	7	6	5	4	3	2	1	0
cond				1	1	1	0	1	D	1	1	1	opc2			Vd				1	0	1	sz	op	1	M	0		Vm		

```

if opc2 != '000' && !(opc2 IN "10x") then SEE "Related encodings";
to_integer = (opc2<2> == '1'); dp_operation = (sz == 1);
if to_integer then
    unsigned = (opc2<0> == '0'); round_zero = (op == '1');
    d = UInt(Vd:D); m = if dp_operation then UInt(M:Vm) else UInt(Vm:M);
else
    unsigned = (op == '0'); round_nearest = FALSE; // FALSE selects FPSCR rounding
    m = UInt(Vm:M); d = if dp_operation then UInt(D:Vd) else UInt(Vd:D);

```

**Related encodings** See *Floating-point data-processing instructions* on page A7-272.

## Assembler syntax

VCVT{R}{<C>}{<q>}.S32.F64 <Sd>, <Dm>	Encoded as opc2 = 0b101, sz = 1
VCVT{R}{<C>}{<q>}.S32.F32 <Sd>, <Sm>	Encoded as opc2 = 0b101, sz = 0
VCVT{R}{<C>}{<q>}.U32.F64 <Sd>, <Dm>	Encoded as opc2 = 0b100, sz = 1
VCVT{R}{<C>}{<q>}.U32.F32 <Sd>, <Sm>	Encoded as opc2 = 0b100, sz = 0
VCVT{<C>}{<q>}.F64.<Tm> <Dd>, <Sm>	Encoded as opc2 = 0b000, sz = 1
VCVT{<C>}{<q>}.F32.<Tm> <Sd>, <Sm>	Encoded as opc2 = 0b000, sz = 0

where:

R If R is specified, the operation uses the rounding mode specified by the [FPSCR](#). Encoded as op = 0. If R is omitted, the operation uses the Round towards Zero rounding mode. For syntaxes in which R is optional, op is encoded as 1 if R is omitted.

<C>, <q> See [Standard assembler syntax fields on page A8-287](#).

<Tm> The data type for the operand. It must be one of:  
S32 encoded as op = 1  
U32 encoded as op = 0.

<Sd>, <Dm> The destination register and the operand register, for a double-precision operand.

<Dd>, <Sm> The destination register and the operand register, for a double-precision result.

<Sd>, <Sm> The destination register and the operand register, for a single-precision operand or result.

## Operation

```

if ConditionPassed() then
    EncodingSpecificOperations(); CheckVFPEnabled(TRUE);
    if to_integer then
        if dp_operation then
            S[d] = FPToFixed(D[m], 32, 0, unsigned, round_zero, TRUE);
        else
            S[d] = FPToFixed(S[m], 32, 0, unsigned, round_zero, TRUE);
    else
        if dp_operation then
            D[d] = FixedToFP(S[m], 64, 0, unsigned, round_nearest, TRUE);
        else
            S[d] = FixedToFP(S[m], 32, 0, unsigned, round_nearest, TRUE);

```

## Exceptions

Undefined Instruction, Hyp Trap.

### ***Floating-point exceptions***

Input Denormal, Invalid Operation, Inexact.

### A8.8.307 VCVT (between floating-point and fixed-point, Advanced SIMD)

This instruction converts each element in a vector from floating-point to fixed-point, or from fixed-point to floating-point, and places the results in a second vector.

The vector elements must be 32-bit floating-point numbers, or 32-bit integers. Signed and unsigned integers are distinct.

The floating-point to fixed-point operation uses the Round towards Zero rounding mode. The fixed-point to floating-point operation uses the Round to Nearest rounding mode.

Depending on settings in the CPACR, NSACR, and HCPTR registers, and the security state and mode in which the instruction is executed, an attempt to execute the instruction might be UNDEFINED, or trapped to Hyp mode. [Summary of access controls for Advanced SIMD functionality on page B1-1232](#) summarizes these controls.

ARM deprecates the conditional execution of any Advanced SIMD instruction encoding that is not also available as a VFP instruction encoding, see [Conditional execution on page A8-288](#).

#### Encoding T1/A1 Advanced SIMD (UNDEFINED in integer-only variant)

VCVT<c>.<Td>.<Tm> <Qd>, <Qm>, #<fbits>

VCVT<c>.<Td>.<Tm> <Dd>, <Dm>, #<fbits>

15	14	13	12	11	10	9	8	7	6	5	4	3	2	1	0	15	14	13	12	11	10	9	8	7	6	5	4	3	2	1	0
1	1	1	U	1	1	1	1	1	D	imm6						Vd	1	1	1	op	0	Q	M	1	Vm						

31	30	29	28	27	26	25	24	23	22	21	20	19	18	17	16	15	14	13	12	11	10	9	8	7	6	5	4	3	2	1	0
1	1	1	1	0	0	1	U	1	D	imm6						Vd	1	1	1	op	0	Q	M	1	Vm						

```

if imm6 IN "000xxx" then SEE "Related encodings";
if imm6 IN "0xxxxx" then UNDEFINED;
if Q == '1' && (Vd<0> == '1' || Vm<0> == '1') then UNDEFINED;
to_fixed = (op == '1'); unsigned = (U == '1');
if to_fixed then
    round_zero = TRUE; // Variable name indicates purpose of FPToFixed() argument
else
    round_nearest = TRUE; // Variable name indicates purpose of FixedToFP() argument
esize = 32; frac_bits = 64 - UInt(imm6); elements = 2;
d = UInt(D:Vd); m = UInt(M:Vm); regs = if Q == '0' then 1 else 2;

```

**Related encodings** See [One register and a modified immediate value on page A7-269](#).

## Assembler syntax

VCVT{<C>}{<q>}.<Td>.<Tm> <Qd>, <Qm>, #<fbits> Encoded as Q = 1  
VCVT{<C>}{<q>}.<Td>.<Tm> <Dd>, <Dm>, #<fbits> Encoded as Q = 0

where:

<C>, <q> See [Standard assembler syntax fields on page A8-287](#). An ARM Advanced SIMD VCVT instruction must be unconditional. ARM strongly recommends that a Thumb Advanced SIMD VCVT instruction is unconditional, see [Conditional execution on page A8-288](#).

.<Td>.<Tm> The data types for the elements of the vectors. They must be one of:

- .S32.F32 encoded as op = 1, U = 0
- .U32.F32 encoded as op = 1, U = 1
- .F32.S32 encoded as op = 0, U = 0
- .F32.U32 encoded as op = 0, U = 1.

<Qd>, <Qm> The destination vector and the operand vector, for a quadword operation.

<Dd>, <Dm> The destination vector and the operand vector, for a doubleword operation.

<fbits> The number of fraction bits in the fixed point number, in the range 1 to 32:

- (64 - <fbits>) is encoded in imm6.

An assembler can permit an <fbits> value of 0. This is encoded as floating-point to integer or integer to floating-point instruction, see [VCVT \(between floating-point and integer, Advanced SIMD\) on page A8-868](#).

## Operation

```

if ConditionPassed() then
    EncodingSpecificOperations(); CheckAdvSIMDEnabled();
    for r = 0 to regs-1
        for e = 0 to elements-1
            op = Elem[D[m+r],e,esize];
            if to_fixed then
                result = FPToFixed(op, esize, frac_bits, unsigned, round_zero, FALSE);
            else
                result = FixedToFP(op, esize, frac_bits, unsigned, round_nearest, FALSE);
            Elem[D[d+r],e,esize] = result;

```

## Exceptions

Undefined Instruction, Hyp Trap.

### Floating-point exceptions

Input Denormal, Invalid Operation, Inexact.

### A8.8.308 VCVT (between floating-point and fixed-point, Floating-point)

This instruction converts a value in a register from floating-point to fixed-point, or from fixed-point to floating-point. Software can specify the fixed-point value as either signed or unsigned.

The floating-point value can be single-precision or double-precision.

The fixed-point value can be 16-bit or 32-bit. Conversions from fixed-point values take their operand from the low-order bits of the source register and ignore any remaining bits. Signed conversions to fixed-point values sign-extend the result value to the destination register width. Unsigned conversions to fixed-point values zero-extend the result value to the destination register width.

The floating-point to fixed-point operation uses the Round towards Zero rounding mode. The fixed-point to floating-point operation uses the Round to Nearest rounding mode.

Depending on settings in the CPACR, NSACR, HCPTR, and FPEXC registers, and the security state and mode in which the instruction is executed, an attempt to execute the instruction might be UNDEFINED, or trapped to Hyp mode. *Summary of general controls of CP10 and CP11 functionality on page B1-1230* summarizes these controls.

**Encoding T1/A1** VFPv3, VFPv4 (sf = 1 UNDEFINED in single-precision only variants)

VCVT<c>.<Td>.F64 <Dd>, <Dd>, #<fbits>

VCVT<c>.<Td>.F32 <Sd>, <Sd>, #<fbits>

VCVT<c>.F64.<Td> <Dd>, <Dd>, #<fbits>

VCVT<c>.F32.<Td> <Sd>, <Sd>, #<fbits>

15	14	13	12	11	10	9	8	7	6	5	4	3	2	1	0	15	14	13	12	11	10	9	8	7	6	5	4	3	2	1	0
1	1	1	0	1	1	1	0	1	D	1	1	1	op	1	U	Vd						1	0	1	sf	sx	1	i	0	imm4	

31	30	29	28	27	26	25	24	23	22	21	20	19	18	17	16	15	14	13	12	11	10	9	8	7	6	5	4	3	2	1	0
cond																															

```
to_fixed = (op == '1'); dp_operation = (sf == '1'); unsigned = (U == '1');
size = if sx == '0' then 16 else 32;
frac_bits = size - UInt(imm4:i);
if to_fixed then
    round_zero = TRUE;
else
    round_nearest = TRUE;
d = if dp_operation then UInt(D:Vd) else UInt(Vd:D);
if frac_bits < 0 then UNPREDICTABLE;
```

## Assembler syntax

VCVT{<C>}{<q>}.<Td>.F64 <Dd>, <Dd>, #<fbits>	Encoded as op = 1, sf = 1
VCVT{<C>}{<q>}.<Td>.F32 <Sd>, <Sd>, #<fbits>	Encoded as op = 1, sf = 0
VCVT{<C>}{<q>}.F64.<Td> <Dd>, <Dd>, #<fbits>	Encoded as op = 0, sf = 1
VCVT{<C>}{<q>}.F32.<Td> <Sd>, <Sd>, #<fbits>	Encoded as op = 0, sf = 0

where:

<C>, <q>	See <i>Standard assembler syntax fields</i> on page A8-287.
<Td>	The data type for the fixed-point number. It must be one of: S16 encoded as U = 0, sx = 0 U16 encoded as U = 1, sx = 0 S32 encoded as U = 0, sx = 1 U32 encoded as U = 1, sx = 1.
<Dd>	The destination and operand register, for a double-precision operand.
<Sd>	The destination and operand register, for a single-precision operand.
<fbits>	The number of fraction bits in the fixed-point number: <ul style="list-style-type: none"> <li>If &lt;Td&gt; is S16 or U16, &lt;fbits&gt; must be in the range 0-16. (16 - &lt;fbits&gt;) is encoded in [imm4, i]</li> <li>If &lt;Td&gt; is S32 or U32, &lt;fbits&gt; must be in the range 1-32. (32 - &lt;fbits&gt;) is encoded in [imm4, i].</li> </ul>

## Operation

```

if ConditionPassed() then
    EncodingSpecificOperations(); CheckVFPEnabled(TRUE);
    if to_fixed then
        if dp_operation then
            result = FPToFixed(D[d], size, frac_bits, unsigned, round_zero, TRUE);
            D[d] = if unsigned then ZeroExtend(result, 64) else SignExtend(result, 64);
        else
            result = FPToFixed(S[d], size, frac_bits, unsigned, round_zero, TRUE);
            S[d] = if unsigned then ZeroExtend(result, 32) else SignExtend(result, 32);
    else
        if dp_operation then
            D[d] = FixedToFP(D[d]<size-1:0>, 64, frac_bits, unsigned, round_nearest, TRUE);
        else
            S[d] = FixedToFP(S[d]<size-1:0>, 32, frac_bits, unsigned, round_nearest, TRUE);

```

## Exceptions

Undefined Instruction, Hyp Trap.

### ***Floating-point exceptions***

Input Denormal, Invalid Operation, Inexact.

### A8.8.309 VCVT (between double-precision and single-precision)

This instruction does one of the following:

- converts the value in a double-precision register to single-precision and writes the result to a single-precision register
- converts the value in a single-precision register to double-precision and writes the result to a double-precision register.

Depending on settings in the CPACR, NSACR, HCPTR, and FPEXC registers, and the security state and mode in which the instruction is executed, an attempt to execute the instruction might be UNDEFINED, or trapped to Hyp mode. *Summary of general controls of CP10 and CP11 functionality on page B1-1230* summarizes these controls.

#### Encoding T1/A1 VFPv2, VFPv3, VFPv4 (UNDEFINED in single-precision only variants)

VCVT<c>.F64.F32 <Dd>, <Sm>

VCVT<c>.F32.F64 <Sd>, <Dm>

15	14	13	12	11	10	9	8	7	6	5	4	3	2	1	0	15	14	13	12	11	10	9	8	7	6	5	4	3	2	1	0
1	1	1	0	1	1	1	0	1	D	1	1	0	1	1	1	Vd	1	0	1	sz	1	1	M	0	Vm						

31	30	29	28	27	26	25	24	23	22	21	20	19	18	17	16	15	14	13	12	11	10	9	8	7	6	5	4	3	2	1	0
cond		1	1	1	0	1	D	1	1	0	1	1	1	1	1	Vd	1	0	1	sz	1	1	M	0	Vm						

```
double_to_single = (sz == '1');
d = if double_to_single then UInt(Vd:D) else UInt(D:Vd);
m = if double_to_single then UInt(M:Vm) else UInt(Vm:M);
```



## Assembler syntax

VCVT{<C>}{<q>}.F64.F32 <Dd>, <Sm> Encoded as sz = 0  
VCVT{<C>}{<q>}.F32.F64 <Sd>, <Dm> Encoded as sz = 1

where:

<C>, <q> See *Standard assembler syntax fields* on page A8-287.  
<Dd>, <Sm> The destination register and the operand register, for a single-precision operand.  
<Sd>, <Dm> The destination register and the operand register, for a double-precision operand.

## Operation

```
if ConditionPassed() then
    EncodingSpecificOperations(); CheckVFPEnabled(TRUE);
    if double_to_single then
        S[d] = FPDoubleToSingle(D[m], TRUE);
    else
        D[d] = FPSingleToDouble(S[m], TRUE);
```

## Exceptions

Undefined Instruction, Hyp Trap.

### *Floating-point exceptions*

Invalid Operation, Input Denormal, Overflow, Underflow, Inexact.

### A8.8.310 VCVT (between half-precision and single-precision, Advanced SIMD)

This instruction converts each element in a vector from single-precision to half-precision floating-point or from half-precision to single-precision, and places the results in a second vector.

The vector elements must be 32-bit floating-point numbers, or 16-bit floating-point numbers.

Depending on settings in the CPACR, NSACR, and HCPTR registers, and the security state and mode in which the instruction is executed, an attempt to execute the instruction might be UNDEFINED, or trapped to Hyp mode.

*Summary of access controls for Advanced SIMD functionality on page B1-1232* summarizes these controls.

ARM deprecates the conditional execution of any Advanced SIMD instruction encoding that is not also available as a VFP instruction encoding, see *Conditional execution on page A8-288*.

#### Encoding T1/A1 Advanced SIMD with Half-precision Extension (UNDEFINED in integer-only variant)

VCVT<c>.F32.F16 <Qd>, <Dm>

VCVT<c>.F16.F32 <Dd>, <Qm>

15	14	13	12	11	10	9	8	7	6	5	4	3	2	1	0	15	14	13	12	11	10	9	8	7	6	5	4	3	2	1	0
1	1	1	1	1	1	1	1	D	1	1	size	1	0		Vd	0	1	1	op	0	0	M	0		Vm						

31	30	29	28	27	26	25	24	23	22	21	20	19	18	17	16	15	14	13	12	11	10	9	8	7	6	5	4	3	2	1	0
1	1	1	1	0	0	1	1	1	D	1	1	size	1	0		Vd	0	1	1	op	0	0	M	0		Vm					

```

half_to_single = (op == '1');
if size != '01' then UNDEFINED;
if half_to_single && Vd<0> == '1' then UNDEFINED;
if !half_to_single && Vm<0> == '1' then UNDEFINED;
esize = 16; elements = 4;
m = UInt(M:Vm); d = UInt(D:Vd);

```

## Assembler syntax

VCVT{<C>}{<q>}.F32.F16 <Qd>, <Dm> Encoded as op = 1  
VCVT{<C>}{<q>}.F16.F32 <Dd>, <Qm> Encoded as op = 0

where:

- <C>, <q> See *Standard assembler syntax fields on page A8-287*. An ARM VCVT instruction must be unconditional. ARM strongly recommends that a Thumb VCVT instruction is unconditional, see *Conditional execution on page A8-288*.
- <Qd>, <Dm> The destination vector and the operand vector for a half-precision to single-precision operation.
- <Dd>, <Qm> The destination vector and the operand vectors for a single-precision to half-precision operation.

## Operation

```

if ConditionPassed() then
    EncodingSpecificOperations(); CheckAdvSIMDEnabled();
    for e = 0 to elements-1
        if half_to_single then
            Elem[Q[d>>1],e,2*esize] = FPHalfToSingle(Elem[Din[m],e,esize], FALSE);
        else
            Elem[D[d],e,esize] = FPSingleToHalf(Elem[Qin[m>>1],e,2*esize], FALSE);

```

## Exceptions

Undefined Instruction, Hyp Trap.

### ***Floating-point exceptions***

Invalid Operation, Input Denormal, Overflow, Underflow, Inexact.

### A8.8.311 VCVTB, VCVTT

Vector Convert Bottom and Vector Convert Top do one of the following:

- convert the half-precision value in the top or bottom half of a single-precision register to single-precision and write the result to a single-precision register
- convert the value in a single-precision register to half-precision and write the result into the top or bottom half of a single-precision register, preserving the other half of the target register.

Depending on settings in the CPACR, NSACR, HCPTR, and FPEXC registers, and the security state and mode in which the instruction is executed, an attempt to execute the instruction might be UNDEFINED, or trapped to Hyp mode. *Summary of general controls of CP10 and CP11 functionality on page B1-1230* summarizes these controls.

#### Encoding T1/A1 VFPv3 Half-precision Extension, VFPv4

VCVT<y><c>.F32.F16 <Sd>, <Sm>

VCVT<y><c>.F16.F32 <Sd>, <Sm>

15	14	13	12	11	10	9	8	7	6	5	4	3	2	1	0	15	14	13	12	11	10	9	8	7	6	5	4	3	2	1	0
1	1	1	0	1	1	1	0	1	D	1	1	0	0	1	op	Vd	1	0	1	(0)	T	1	M	0	Vm						

31	30	29	28	27	26	25	24	23	22	21	20	19	18	17	16	15	14	13	12	11	10	9	8	7	6	5	4	3	2	1	0
cond		1	1	1	0	1	D	1	1	0	0	1	op	Vd	1	0	1	(0)	T	1	M	0	Vm								

```
half_to_single = (op == '0');
lowbit = if T == '1' then 16 else 0;
m = UInt(Vm:M); d = UInt(Vd:D);
```

## Assembler syntax

VCVT<y>{<c>}{<q>}.F32.F16 <Sd>, <Sm> Encoded as op = 0  
VCVT<y>{<c>}{<q>}.F16.F32 <Sd>, <Sm> Encoded as op = 1

where:

<y> Specifies which half of the operand register <Sm> or destination register <Sd> is used for the operand or destination. One of:  
B Encoded as T = 0.  
Instruction uses the bottom half of the register, bits[15:0].  
T Encoded as T = 1.  
Instruction uses the top half of the register, bits[31:16].

<c>, <q> See [Standard assembler syntax fields on page A8-287](#).

<Sd> The destination register.

<Sm> The operand register.

## Operation

```
if ConditionPassed() then
    EncodingSpecificOperations(); CheckVFPEnabled(TRUE);
    if half_to_single then
        S[d] = FPHalfToSingle(S[m]<lowbit+15:lowbit>, TRUE);
    else
        S[d]<lowbit+15:lowbit> = FPSingleToHalf(S[m], TRUE);
```

## Exceptions

Undefined Instruction, Hyp Trap.

### ***Floating-point exceptions***

Invalid Operation, Input Denormal, Overflow, Underflow, Inexact.

### A8.8.312 VDIV

This instruction divides one floating-point value by another floating-point value and writes the result to a third floating-point register.

Depending on settings in the [CPACR](#), [NSACR](#), [HCPTR](#), and [FPEXC](#) registers, and the security state and mode in which the instruction is executed, an attempt to execute the instruction might be UNDEFINED, or trapped to Hyp mode. [Summary of general controls of CP10 and CP11 functionality on page B1-1230](#) summarizes these controls.

**Encoding T1/A1** VFPv2, VFPv3, VFPv4 (sz = 1 UNDEFINED in single-precision only variants)

VDIV<c>.F64 <Dd>, <Dn>, <Dm>

VDIV<c>.F32 <Sd>, <Sn>, <Sm>

15	14	13	12	11	10	9	8	7	6	5	4	3	2	1	0	15	14	13	12	11	10	9	8	7	6	5	4	3	2	1	0
1	1	1	0	1	1	1	0	1	D	0	0	Vn			Vd			1	0	1	sz	N	0	M	0	Vm					
31	30	29	28	27	26	25	24	23	22	21	20	19	18	17	16	15	14	13	12	11	10	9	8	7	6	5	4	3	2	1	0
cond			1	1	1	0	1	D	0	0	Vn			Vd			1	0	1	sz	N	0	M	0	Vm						

```
if FPSCR.Len != '000' || FPSCR.Stride != '00' then SEE "VFP vectors";
dp_operation = (sz == '1');
d = if dp_operation then UInt(D:Vd) else UInt(Vd:D);
n = if dp_operation then UInt(N:Vn) else UInt(Vn:N);
m = if dp_operation then UInt(M:Vm) else UInt(Vm:M);
```

**VFP vectors** This instruction can operate on VFP vectors under control of the [FPSCR](#). {Len, Stride} fields. For details see [Appendix K VFP Vector Operation Support](#).

## Assembler syntax

VDIV{<C>}{<q>}.F64 {<Dd>}, <Dn>, <Dm> Encoded as sz = 1  
VDIV{<C>}{<q>}.F32 {<Sd>}, <Sn>, <Sm> Encoded as sz = 0

where:

<C>, <q> See *Standard assembler syntax fields on page A8-287*.  
<Dd>, <Dn>, <Dm> The destination register and the operand registers, for a double-precision operation.  
<Sd>, <Sn>, <Sm> The destination register and the operand registers, for a single-precision operation.

## Operation

```
if ConditionPassed() then
    EncodingSpecificOperations(); CheckVFPEnabled(TRUE);
    if dp_operation then
        D[d] = FPDIV(D[n], D[m], TRUE);
    else
        S[d] = FPDIV(S[n], S[m], TRUE);
```

## Exceptions

Undefined Instruction, Hyp Trap.

### *Floating-point exceptions*

Invalid Operation, Division by Zero, Overflow, Underflow, Inexact, Input Denormal.

### A8.8.313 VDUP (scalar)

Vector Duplicate duplicates a scalar into every element of the destination vector.

The scalar, and the destination vector elements, can be any one of 8-bit, 16-bit, or 32-bit fields. There is no distinction between data types.

For more information about scalars see [Advanced SIMD scalars on page A7-260](#).

Depending on settings in the CPACR, NSACR, and HCPTR registers, and the security state and mode in which the instruction is executed, an attempt to execute the instruction might be UNDEFINED, or trapped to Hyp mode. [Summary of access controls for Advanced SIMD functionality on page B1-1232](#) summarizes these controls.

ARM deprecates the conditional execution of any Advanced SIMD instruction encoding that is not also available as a VFP instruction encoding, see [Conditional execution on page A8-288](#).

#### Encoding T1/A1 Advanced SIMD

VDUP<c>.<size> <Qd>, <Dm[x]>

VDUP<c>.<size> <Dd>, <Dm[x]>

15	14	13	12	11	10	9	8	7	6	5	4	3	2	1	0	15	14	13	12	11	10	9	8	7	6	5	4	3	2	1	0
1	1	1	1	1	1	1	1	D	1	1	imm4					Vd						Q	M	0		Vm					

31	30	29	28	27	26	25	24	23	22	21	20	19	18	17	16	15	14	13	12	11	10	9	8	7	6	5	4	3	2	1	0
1	1	1	1	0	0	1	1	1	D	1	1	imm4				Vd						Q	M	0		Vm					

```

if imm4 IN "x000" then UNDEFINED;
if Q == '1' && Vd<0> == '1' then UNDEFINED;
case imm4 of
  when "xxx1" esize = 8; elements = 8; index = UInt(imm4<3:1>);
  when "xx10" esize = 16; elements = 4; index = UInt(imm4<3:2>);
  when "x100" esize = 32; elements = 2; index = UInt(imm4<3>);
d = UInt(D:Vd); m = UInt(M:Vm); regs = if Q == '0' then 1 else 2;

```



## Assembler syntax

VDUP{<c>}{<q>}.<size> <Qd>, <Dm[x]> Encoded as Q = 1  
VDUP{<c>}{<q>}.<size> <Dd>, <Dm[x]> Encoded as Q = 0

where:

<c>, <q> See *Standard assembler syntax fields on page A8-287*. An ARM VDUP instruction must be unconditional. ARM strongly recommends that a Thumb VDUP instruction is unconditional, see *Conditional execution on page A8-288*.

<size> The data size. It must be one of:  
8 Encoded as imm4<0> = '1'. imm4<3:1> encodes the index [x] of the scalar.  
16 Encoded as imm4<1:0> = '10'. imm4<3:2> encodes the index [x] of the scalar.  
32 Encoded as imm4<2:0> = '100'. imm4<3> encodes the index [x] of the scalar.

<Qd> The destination vector for a quadword operation.

<Dd> The destination vector for a doubleword operation.

<Dm[x]> The scalar. For details of how [x] is encoded, see the description of <size>.

## Operation

```
if ConditionPassed() then
    EncodingSpecificOperations(); CheckAdvSIMDEnabled();
    scalar = Elem[D[m],index,esize];
    for r = 0 to regs-1
        for e = 0 to elements-1
            Elem[D[d+r],e,esize] = scalar;
```

## Exceptions

Undefined Instruction, Hyp Trap.

### A8.8.314 VDUP (ARM core register)

This instruction duplicates an element from an ARM core register into every element of the destination vector.

The destination vector elements can be 8-bit, 16-bit, or 32-bit fields. The source element is the least significant 8, 16, or 32 bits of the ARM core register. There is no distinction between data types.

Depending on settings in the CPACR, NSACR, and HCPTR registers, and the security state and mode in which the instruction is executed, an attempt to execute the instruction might be UNDEFINED, or trapped to Hyp mode. [Summary of access controls for Advanced SIMD functionality on page B1-1232](#) summarizes these controls.

ARM deprecates the conditional execution of any Advanced SIMD instruction encoding that is not also available as a VFP instruction encoding, see [Conditional execution on page A8-288](#).

#### Encoding T1/A1 Advanced SIMD

VDUP<c>.<size> <Qd>, <Rt>

VDUP<c>.<size> <Dd>, <Rt>

15	14	13	12	11	10	9	8	7	6	5	4	3	2	1	0	15	14	13	12	11	10	9	8	7	6	5	4	3	2	1	0
1	1	1	0	1	1	1	0	1	B	Q	0		Vd			Rt		1	0	1	1	D	0	E	1	(0)	(0)	(0)	(0)		

31	30	29	28	27	26	25	24	23	22	21	20	19	18	17	16	15	14	13	12	11	10	9	8	7	6	5	4	3	2	1	0
cond				1	1	1	0	1	B	Q	0		Vd			Rt		1	0	1	1	D	0	E	1	(0)	(0)	(0)	(0)		

```

if Q == '1' && Vd<0> == '1' then UNDEFINED;
d = UInt(D:Vd); t = UInt(Rt); regs = if Q == '0' then 1 else 2;
case B:E of
  when '00' esize = 32; elements = 2;
  when '01' esize = 16; elements = 4;
  when '10' esize = 8; elements = 8;
  when '11' UNDEFINED;
if t == 15 || (CurrentInstrSet() != InstrSet_ARM && t == 13) then UNPREDICTABLE;

```

## Assembler syntax

VDUP{<C>}{<q>}.<size> <Qd>, <Rt> Encoded as Q = 1  
VDUP{<C>}{<q>}.<size> <Dd>, <Rt> Encoded as Q = 0

where:

<C>, <q> See *Standard assembler syntax fields* on page A8-287. ARM strongly recommends that any VDUP instruction is unconditional, see *Conditional execution* on page A8-288.

<size> The data size for the elements of the destination vector. It must be one of:  
8 encoded as [b, e] = 0b10.  
16 encoded as [b, e] = 0b01.  
32 encoded as [b, e] = 0b00.

<Qd> The destination vector for a quadword operation.

<Dd> The destination vector for a doubleword operation.

<Rt> The ARM source register.

## Operation

```
if ConditionPassed() then
    EncodingSpecificOperations(); CheckAdvSIMDEnabled();
    scalar = R[t]<size-1:0>;
    for r = 0 to regs-1
        for e = 0 to elements-1
            Elem[D[d+r],e,esize] = scalar;
```

## Exceptions

Undefined Instruction, Hyp Trap.

### A8.8.315 VEOR

Vector Bitwise Exclusive OR performs a bitwise Exclusive OR operation between two registers, and places the result in the destination register. The operand and result registers can be quadword or doubleword. They must all be the same size.

Depending on settings in the CPACR, NSACR, and HCPTR registers, and the security state and mode in which the instruction is executed, an attempt to execute the instruction might be UNDEFINED, or trapped to Hyp mode. [Summary of access controls for Advanced SIMD functionality on page B1-1232](#) summarizes these controls.

ARM deprecates the conditional execution of any Advanced SIMD instruction encoding that is not also available as a VFP instruction encoding, see [Conditional execution on page A8-288](#).

#### Encoding T1/A1 Advanced SIMD

VEOR<c> <Qd>, <Qn>, <Qm>

VEOR<c> <Dd>, <Dn>, <Dm>

15	14	13	12	11	10	9	8	7	6	5	4	3	2	1	0	15	14	13	12	11	10	9	8	7	6	5	4	3	2	1	0
1	1	1	1	1	1	1	1	0	D	0	0	Vn				Vd	0	0	0	1	N	Q	M	1	Vm						
31	30	29	28	27	26	25	24	23	22	21	20	19	18	17	16	15	14	13	12	11	10	9	8	7	6	5	4	3	2	1	0
1	1	1	1	0	0	1	1	0	D	0	0	Vn				Vd	0	0	0	1	N	Q	M	1	Vm						

```
if Q == '1' && (Vd<0> == '1' || Vn<0> == '1' || Vm<0> == '1') then UNDEFINED;
d = UInt(D:Vd); n = UInt(N:Vn); m = UInt(M:Vm); regs = if Q == '0' then 1 else 2;
```

## Assembler syntax

VEOR{<C>}{<q>}{.<dt>} {<Qd>}, <Qn>, <Qm> Encoded as Q = 1  
VEOR{<C>}{<q>}{.<dt>} {<Dd>}, <Dn>, <Dm> Encoded as Q = 0

where:

<C>, <q> See [Standard assembler syntax fields on page A8-287](#). An ARM VEOR instruction must be unconditional. ARM strongly recommends that a Thumb VEOR instruction is unconditional, see [Conditional execution on page A8-288](#).

<dt> An optional data type. It is ignored by assemblers, and does not affect the encoding.

<Qd>, <Qn>, <Qm> The destination vector and the operand vectors, for a quadword operation.

<Dd>, <Dn>, <Dm> The destination vector and the operand vectors, for a doubleword operation.

## Operation

```
if ConditionPassed() then
    EncodingSpecificOperations(); CheckAdvSIMDEnabled();
    for r = 0 to regs-1
        D[d+r] = D[n+r] EOR D[m+r];
```

## Exceptions

Undefined Instruction, Hyp Trap.

### A8.8.316 VEXT

Vector Extract extracts elements from the bottom end of the second operand vector and the top end of the first, concatenates them and places the result in the destination vector. See [Figure A8-1](#) for an example.

The elements of the vectors are treated as being 8-bit fields. There is no distinction between data types.

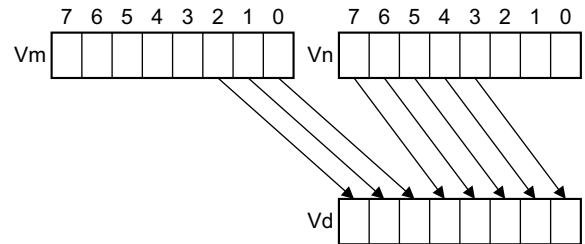

**Figure A8-1 VEXT doubleword operation for imm = 3**

Depending on settings in the [CPACR](#), [NSACR](#), and [HCPTR](#) registers, and the security state and mode in which the instruction is executed, an attempt to execute the instruction might be UNDEFINED, or trapped to Hyp mode. [Summary of access controls for Advanced SIMD functionality on page B1-1232](#) summarizes these controls.

ARM deprecates the conditional execution of any Advanced SIMD instruction encoding that is not also available as a VFP instruction encoding, see [Conditional execution on page A8-288](#).

#### Encoding T1/A1 Advanced SIMD

VEXT<c>.8 <Qd>, <Qn>, <Qm>, #<imm>

VEXT<c>.8 <Dd>, <Dn>, <Dm>, #<imm>

15	14	13	12	11	10	9	8	7	6	5	4	3	2	1	0	15	14	13	12	11	10	9	8	7	6	5	4	3	2	1	0
1	1	1	0	1	1	1	1	1	D	1	1	Vn				Vd				imm4				N	Q	M	0	Vm			
31	30	29	28	27	26	25	24	23	22	21	20	19	18	17	16	15	14	13	12	11	10	9	8	7	6	5	4	3	2	1	0
1	1	1	1	0	0	1	0	1	D	1	1	Vn				Vd				imm4				N	Q	M	0	Vm			

```

if Q == '1' && (Vd<0> == '1' || Vn<0> == '1' || Vm<0> == '1') then UNDEFINED;
if Q == '0' && imm4<3> == '1' then UNDEFINED;
quadword_operation = (Q == '1'); position = 8 * UInt(imm4);
d = UInt(D:Vd); n = UInt(N:Vn); m = UInt(M:Vm);

```

## Assembler syntax

VEXT{<C>}{<q>}.<size> {<Qd>}, <Qn>, <Qm>, #<imm> Encoded as Q = 1  
VEXT{<C>}{<q>}.<size> {<Dd>}, <Dn>, <Dm>, #<imm> Encoded as Q = 0

where:

<C>, <q> See [Standard assembler syntax fields on page A8-287](#). An ARM VEXT instruction must be unconditional. ARM strongly recommends that a Thumb VEXT instruction is unconditional, see [Conditional execution on page A8-288](#).

<size> Size of the operation. The value can be:

- 8, 16, or 32 for doubleword operations
- 8, 16, 32, or 64 for quadword operations.

If the value is 16, 32, or 64, the syntax is a pseudo-instruction for a VEXT instruction specifying the equivalent number of bytes. The following examples show how an assembler treats values greater than 8:

VEXT.16 D0, D1, #x is treated as VEXT.8 D0, D1, #(x\*2)  
VEXT.32 D0, D1, #x is treated as VEXT.8 D0, D1, #(x\*4)  
VEXT.64 Q0, Q1, #x is treated as VEXT.8 Q0, Q1, #(x\*8).

<Qd>, <Qn>, <Qm> The destination vector and the operand vectors, for a quadword operation.

<Dd>, <Dn>, <Dm> The destination vector and the operand vectors, for a doubleword operation.

<imm> The location of the extracted result in the concatenation of the operands, as a number of bytes from the least significant end, in the range 0-7 for a doubleword operation or 0-15 for a quadword operation.

## Operation

```
if ConditionPassed() then
    EncodingSpecificOperations(); CheckAdvSIMDEnabled();
    if quadword_operation then
        Q[d>1] = (Q[m>1]:Q[n>1])<position+127:position>;
    else
        D[d] = (D[m]:D[n])<position+63:position>;
```

## Exceptions

Undefined Instruction, Hyp Trap.

### A8.8.317 VFMA, VFMS

Vector Fused Multiply Accumulate multiplies corresponding elements of two vectors, and accumulates the results into the elements of the destination vector. The instruction does not round the result of the multiply before the accumulation.

Vector Fused Multiply Subtract negates the elements of one vector and multiplies them with the corresponding elements of another vector, adds the products to the corresponding elements of the destination vector, and places the results in the destination vector. The instruction does not round the result of the multiply before the addition.

Depending on settings in the CPACR, NSACR, HCPTR, and FPEXC registers, and the security state and mode in which the instruction is executed, an attempt to execute the instruction might be UNDEFINED, or trapped to Hyp mode. [Summary of general controls of CP10 and CP11 functionality on page B1-1230](#) and [Summary of access controls for Advanced SIMD functionality on page B1-1232](#) summarize these controls.

ARM deprecates the conditional execution of any Advanced SIMD instruction encoding that is not also available as a VFP instruction encoding, see [Conditional execution on page A8-288](#).

#### Encoding T1/A1 Advanced SIMDv2 (UNDEFINED in integer-only variant)

VFM<y><c>.F32 <Qd>, <Qn>, <Qm>

VFM<y><c>.F32 <Dd>, <Dn>, <Dm>

15	14	13	12	11	10	9	8	7	6	5	4	3	2	1	0	15	14	13	12	11	10	9	8	7	6	5	4	3	2	1	0
1	1	1	0	1	1	1	1	0	D	op	sz		Vn		Vd	1	1	0	0	N	Q	M	1		Vm						

31	30	29	28	27	26	25	24	23	22	21	20	19	18	17	16	15	14	13	12	11	10	9	8	7	6	5	4	3	2	1	0
1	1	1	1	0	0	1	0	0	D	op	sz		Vn		Vd	1	1	0	0	N	Q	M	1		Vm						

```
if Q == '1' && (Vd<0> == '1' || Vn<0> == '1' || Vm<0> == '1') then UNDEFINED;
if sz == '1' then UNDEFINED;
advsimd = TRUE; op1_neg = (op == '1'); esize = 32; elements = 2;
d = UInt(D:Vd); n = UInt(N:Vn); m = UInt(M:Vm);
regs = if Q == '0' then 1 else 2;
```

#### Encoding T2/A2 VFPv4 (sz = 1 UNDEFINED in single-precision only variants)

VFM<y><c>.F64 <Dd>, <Dn>, <Dm>

VFM<y><c>.F32 <Sd>, <Sn>, <Sm>

15	14	13	12	11	10	9	8	7	6	5	4	3	2	1	0	15	14	13	12	11	10	9	8	7	6	5	4	3	2	1	0
1	1	1	0	1	1	1	0	1	D	1	0		Vn		Vd	1	0	1	sz	N	op	M	0		Vm						

31	30	29	28	27	26	25	24	23	22	21	20	19	18	17	16	15	14	13	12	11	10	9	8	7	6	5	4	3	2	1	0
cond		1	1	1	0	1	D	1	0		Vn		Vd	1	0	1	sz	N	op	M	0		Vm								

```
if FPSCR.Len != '000' || FPSCR.Stride != '00' then UNPREDICTABLE;
advsimd = FALSE; dp_operation = (sz == '1'); op1_neg = (op == '1');
d = if dp_operation then UInt(D:Vd) else UInt(Vd:D);
n = if dp_operation then UInt(N:Vn) else UInt(Vn:N);
m = if dp_operation then UInt(M:Vm) else UInt(Vm:M);
```



## Assembler syntax

VFM<y><c><q>.F32 <Qd>, <Qn>, <Qm>	Encoding T1/A1, encoded as Q = 1, sz = 0
VFM<y><c><q>.F32 <Dd>, <Dn>, <Dm>	Encoding T1/A1, encoded as Q = 0, sz = 0
VFM<y><c><q>.F64 <Dd>, <Dn>, <Dm>	Encoding T2/A2, encoded as sz = 1
VFM<y><c><q>.F32 <Sd>, <Sn>, <Sm>	Encoding T2/A2, encoded as sz = 0

where:

<y>	One of: A Specifies VFMA, encoded as op = 0. S Specifies VFMS, encoded as op = 1.
<c>, <q>	See <a href="#">Standard assembler syntax fields on page A8-287</a> . An ARM Advanced SIMD VFMA or VMFS instruction must be unconditional. ARM strongly recommends that a Thumb Advanced SIMD VFMA or VMFS instruction is unconditional, see <a href="#">Conditional execution on page A8-288</a> .
<Qd>, <Qn>, <Qm>	The destination vector and the operand vectors, for a quadword operation.
<Dd>, <Dn>, <Dm>	The destination vector and the operand vectors, for a doubleword operation.
<Sd>, <Sn>, <Sm>	The destination vector and the operand vectors, for a singleword operation.

## Operation

```

if ConditionPassed() then
    EncodingSpecificOperations(); CheckAdvSIMDOrVFPEEnabled(TRUE, advsimd);
    if advsimd then // Advanced SIMD instruction
        for r = 0 to regs-1
            for e = 0 to elements-1
                op1 = Elem[D[n+r],e,esize];
                if op1_neg then op1 = FPNeg(op1);
                Elem[D[d+r],e,esize] = FPMulAdd(Elem[D[d+r],e,esize],
                    op1, Elem[D[m+r],e,esize], FALSE);
            else // VFP instruction
                if dp_operation then
                    op1 = if op1_neg then FPNeg(D[n]) else D[n];
                    D[d] = FPMulAdd(D[d], op1, D[m], TRUE);
                else
                    op1 = if op1_neg then FPNeg(S[n]) else S[n];
                    S[d] = FPMulAdd(S[d], op1, S[m], TRUE);

```

## Exceptions

Undefined Instruction, Hyp Trap.

### Floating-point exceptions

Input Denormal, Invalid Operation, Overflow, Underflow, Inexact.

The operation (QNaN + (0 × infinity)) causes an Invalid Operation floating-point exception.

### A8.8.318 VFNMA, VFNMS

Vector Fused Negate Multiply Accumulate negates one floating-point register value and multiplies it by another floating-point register value, adds the negation of the floating-point value in the destination register to the product, and writes the result back to the destination register. The instruction does not round the result of the multiply before the addition.

Vector Fused Negate Multiply Subtract multiplies together two floating-point register values, adds the negation of the floating-point value in the destination register to the product, and writes the result back to the destination register. The instruction does not round the result of the multiply before the addition.

Depending on settings in the CPACR, NSACR, HCPTR, and FPEXC registers, and the security state and mode in which the instruction is executed, an attempt to execute the instruction might be UNDEFINED, or trapped to Hyp mode. *Summary of general controls of CP10 and CP11 functionality on page B1-1230* summarizes these controls.

#### Encoding T1/A1 VFPv4 (sz = 1 UNDEFINED in single-precision only variants)

VFNM<y><c>.F64 <Dd>, <Dn>, <Dm>

VFNM<y><c>.F32 <Sd>, <Sn>, <Sm>

15	14	13	12	11	10	9	8	7	6	5	4	3	2	1	0	15	14	13	12	11	10	9	8	7	6	5	4	3	2	1	0
1	1	1	0	1	1	1	0	1	D	0	1	Vn				Vd				1	0	1	sz	N	op	M	0	Vm			
31	30	29	28	27	26	25	24	23	22	21	20	19	18	17	16	15	14	13	12	11	10	9	8	7	6	5	4	3	2	1	0
cond		1	1	1	0	1	D	0	1	Vn				Vd				1	0	1	sz	N	op	M	0	Vm					

```

if FPSCR.Len != '000' || FPSCR.Stride != '00' then UNPREDICTABLE;
op1_neg = (op == '1');
dp_operation = (sz == '1');
d = if dp_operation then UInt(D:Vd) else UInt(Vd:D);
n = if dp_operation then UInt(N:Vn) else UInt(Vn:N);
m = if dp_operation then UInt(M:Vm) else UInt(Vm:M);

```

## Assembler syntax

VFNM<y><c><q>.F64 <Dd>, <Dn>, <Dm> Encoding T1/A1, encoded as sz = 1  
VFNM<y><c><q>.F32 <Sd>, <Sn>, <Sm> Encoding T1/A1, encoded as sz = 0

where:

<y> One of:  
A Specifies VFNMA, encoded as op = 1.  
S Specifies VFNMS, encoded as op = 0.

<c>, <q> See [Standard assembler syntax fields on page A8-287](#).

<Dd>, <Dn>, <Dm> The destination vector and the operand vectors, for a doubleword operation.

<Sd>, <Sn>, <Sm> The destination vector and the operand vectors, for a singleword operation.

## Operation

```
if ConditionPassed() then
    EncodingSpecificOperations(); CheckVFPEEnabled(TRUE);
    if dp_operation then
        op1 = if op1_neg then FPNeg(D[n]) else D[n];
        D[d] = FPMu1Add(FPNeg(D[d]), op1, D[m], TRUE);
    else
        op1 = if op1_neg then FPNeg(S[n]) else S[n];
        S[d] = FPMu1Add(FPNeg(S[d]), op1, S[m], TRUE);
```

## Exceptions

Undefined Instruction, Hyp Trap.

### ***Floating-point exceptions***

Input Denormal, Invalid Operation, Overflow, Underflow, Inexact.

The operation (QNaN + (0 × infinity)) causes an Invalid Operation floating-point exception.

### A8.8.319 VHADD, VHSUB

Vector Halving Add adds corresponding elements in two vectors of integers, shifts each result right one bit, and places the final results in the destination vector. The results of the halving operations are truncated (for rounded results see [VRHADD on page A8-1030](#)).

Vector Halving Subtract subtracts the elements of the second operand from the corresponding elements of the first operand, shifts each result right one bit, and places the final results in the destination vector. The results of the halving operations are truncated (there is no rounding version).

The operand and result elements are all the same type, and can be any one of:

- 8-bit, 16-bit, or 32-bit signed integers
- 8-bit, 16-bit, or 32-bit unsigned integers.

Depending on settings in the [CPACR](#), [NSACR](#), and [HCPTR](#) registers, and the security state and mode in which the instruction is executed, an attempt to execute the instruction might be UNDEFINED, or trapped to Hyp mode. [Summary of access controls for Advanced SIMD functionality on page B1-1232](#) summarizes these controls.

ARM deprecates the conditional execution of any Advanced SIMD instruction encoding that is not also available as a VFP instruction encoding, see [Conditional execution on page A8-288](#).

#### Encoding T1/A1 Advanced SIMD

VH<op><c> <Qd>, <Qn>, <Qm>

VH<op><c> <Dd>, <Dn>, <Dm>

15	14	13	12	11	10	9	8	7	6	5	4	3	2	1	0	15	14	13	12	11	10	9	8	7	6	5	4	3	2	1	0
1	1	1	U	1	1	1	1	0	D	size	Vn	Vd	0	0	op	0	N	Q	M	0	Vm										

31	30	29	28	27	26	25	24	23	22	21	20	19	18	17	16	15	14	13	12	11	10	9	8	7	6	5	4	3	2	1	0
1	1	1	1	0	0	1	U	0	D	size	Vn	Vd	0	0	op	0	N	Q	M	0	Vm										

```

if Q == '1' && (Vd<0> == '1' || Vn<0> == '1' || Vm<0> == '1') then UNDEFINED;
if size == '11' then UNDEFINED;
add = (op == '0'); unsigned = (U == '1');
esize = 8 << UInt(size); elements = 64 DIV esize;
d = UInt(D:Vd); n = UInt(N:Vn); m = UInt(M:Vm); regs = if Q == '0' then 1 else 2;

```

## Assembler syntax

VH<op>{<c>}{<q>}.<dt> {<Qd>}, <Qn>, <Qm> Encoded as Q = 1  
VH<op>{<c>}{<q>}.<dt> {<Dd>}, <Dn>, <Dm> Encoded as Q = 0

where:

<op> The operation, It must be one of:  
ADD encoded as op = 0.  
SUB encoded as op = 1.

<c>, <q> See [Standard assembler syntax fields on page A8-287](#). An ARM VHADD or VHSUB instruction must be unconditional. ARM strongly recommends that a Thumb VHADD or VHSUB instruction is unconditional, see [Conditional execution on page A8-288](#).

<dt> The data type for the elements of the vectors. It must be one of:  
S8 encoded as size = 0b00, U = 0.  
S16 encoded as size = 0b01, U = 0.  
S32 encoded as size = 0b10, U = 0.  
U8 encoded as size = 0b00, U = 1.  
U16 encoded as size = 0b01, U = 1.  
U32 encoded as size = 0b10, U = 1.

<Qd>, <Qn>, <Qm> The destination vector and the operand vectors, for a quadword operation.

<Dd>, <Dn>, <Dm> The destination vector and the operand vectors, for a doubleword operation.

## Operation

```
if ConditionPassed() then
    EncodingSpecificOperations(); CheckAdvSIMDEnabled();
    for r = 0 to regs-1
        for e = 0 to elements-1
            op1 = Int(Elem[D[n+r],e,esize], unsigned);
            op2 = Int(Elem[D[m+r],e,esize], unsigned);
            result = if add then op1+op2 else op1-op2;
            Elem[D[d+r],e,esize] = result<esize:1>;
```

## Exceptions

Undefined Instruction, Hyp Trap.

### A8.8.320 VLD1 (multiple single elements)

This instruction loads elements from memory into one, two, three, or four registers, without de-interleaving. Every element of each register is loaded. For details of the addressing mode see [Advanced SIMD addressing mode on page A7-277](#).

Depending on settings in the CPACR, NSACR, and HCPTR registers, and the security state and mode in which the instruction is executed, an attempt to execute the instruction might be UNDEFINED, or trapped to Hyp mode. [Summary of access controls for Advanced SIMD functionality on page B1-1232](#) summarizes these controls.

ARM deprecates the conditional execution of any Advanced SIMD instruction encoding that is not also available as a VFP instruction encoding, see [Conditional execution on page A8-288](#).

#### Encoding T1/A1 Advanced SIMD

VLD1<c>.<size> <list>, [<Rn>{:<align>}]{!}

VLD1<c>.<size> <list>, [<Rn>{:<align>}], <Rm>

15	14	13	12	11	10	9	8	7	6	5	4	3	2	1	0	15	14	13	12	11	10	9	8	7	6	5	4	3	2	1	0
1	1	1	1	1	0	0	1	0	D	1	0		Rn			Vd			type	size	align					Rm					

31	30	29	28	27	26	25	24	23	22	21	20	19	18	17	16	15	14	13	12	11	10	9	8	7	6	5	4	3	2	1	0
1	1	1	1	0	1	0	0	0	D	1	0		Rn			Vd			type	size	align									Rm	

```

case type of
  when '0111'
    regs = 1; if align<1> == '1' then UNDEFINED;
  when '1010'
    regs = 2; if align == '11' then UNDEFINED;
  when '0110'
    regs = 3; if align<1> == '1' then UNDEFINED;
  when '0010'
    regs = 4;
  otherwise
    SEE "Related encodings";
alignment = if align == '00' then 1 else 4 << UInt(align);
ebytes = 1 << UInt(size); esize = 8 * ebytes; elements = 8 DIV ebytes;
d = UInt(D:Vd); n = UInt(Rn); m = UInt(Rm);
wback = (m != 15); register_index = (m != 15 && m != 13);
if n == 15 || d+regs > 32 then UNPREDICTABLE;

```

**Related encodings** See [Advanced SIMD element or structure load/store instructions on page A7-275](#).

#### Assembler syntax

VLD1{<c>}{<q>}.<size> <list>, [<Rn>{:<align>}]	Encoded as Rm = 0b1111
VLD1{<c>}{<q>}.<size> <list>, [<Rn>{:<align>}]!	Encoded as Rm = 0b1101
VLD1{<c>}{<q>}.<size> <list>, [<Rn>{:<align>}], <Rm>	Rm cannot be 0b11x1

where:

<c>, <q> See [Standard assembler syntax fields on page A8-287](#). An ARM VLD1 instruction must be unconditional. ARM strongly recommends that a Thumb VLD1 instruction is unconditional, see [Conditional execution on page A8-288](#).

<size> The data size. It must be one of:

8	encoded as size = 0b00.
16	encoded as size = 0b01.
32	encoded as size = 0b10.
64	encoded as size = 0b11.

- <list> The list of registers to load. It must be one of:
- {<Dd>} encoded as D:Vd = <Dd>, type = 0b0111.
  - {<Dd>, <Dd+1>} encoded as D:Vd = <Dd>, type = 0b1010.
  - {<Dd>, <Dd+1>, <Dd+2>} encoded as D:Vd = <Dd>, type = 0b0110.
  - {<Dd>, <Dd+1>, <Dd+2>, <Dd+3>} encoded as D:Vd = <Dd>, type = 0b0010.
- <Rn> Contains the base address for the access.
- <align> The alignment. It can be one of:
- 64 8-byte alignment, encoded as align = 0b01.
  - 128 16-byte alignment, available only if <list> contains two or four registers, encoded as align = 0b10.
  - 256 32-byte alignment, available only if <list> contains four registers, encoded as align = 0b11.
  - omitted** Standard alignment, see *Unaligned data access* on page A3-108. Encoded as align = 0b00.
- : is the preferred separator before the <align> value, but the alignment can be specified as @<align>, see *Advanced SIMD addressing mode* on page A7-277.
- ! If present, specifies writeback.
- <Rm> Contains an address offset applied after the access.
- For more information about <Rn>, !, and <Rm>, see *Advanced SIMD addressing mode* on page A7-277.

## Operation

```

if ConditionPassed() then
    EncodingSpecificOperations(); CheckAdvSIMDEnabled(); NullCheckIfThumbEE(n);
    address = R[n]; if (address MOD alignment) != 0 then GenerateAlignmentException();
    if wback then R[n] = R[n] + (if register_index then R[m] else 8*regs);
    for r = 0 to regs-1
        for e = 0 to elements-1
            if ebytes != 8 then
                data<esize-1:0> = MemU[address,ebytes];
            else
                data<31:0> = if BigEndian() then MemU[address+4,4] else MemU[address,4];
                data<63:32> = if BigEndian() then MemU[address,4] else MemU[address+4,4];
            Elem[D[d+r],e,esize] = data<esize-1:0>;
            address = address + ebytes;

```

## Exceptions

Undefined Instruction, Hyp Trap, Data Abort.

### A8.8.321 VLD1 (single element to one lane)

This instruction loads one element from memory into one element of a register. Elements of the register that are not loaded are unchanged. For details of the addressing mode see *Advanced SIMD addressing mode* on page A7-277.

Depending on settings in the CPACR, NSACR, and HCPTR registers, and the security state and mode in which the instruction is executed, an attempt to execute the instruction might be UNDEFINED, or trapped to Hyp mode. *Summary of access controls for Advanced SIMD functionality* on page B1-1232 summarizes these controls.

ARM deprecates the conditional execution of any Advanced SIMD instruction encoding that is not also available as a VFP instruction encoding, see *Conditional execution* on page A8-288.

#### Encoding T1/A1 Advanced SIMD

VLD1<c>.<size> <list>, [<Rn>{:<align>}]{!}

VLD1<c>.<size> <list>, [<Rn>{:<align>}], <Rm>

15	14	13	12	11	10	9	8	7	6	5	4	3	2	1	0	15	14	13	12	11	10	9	8	7	6	5	4	3	2	1	0
1	1	1	1	1	0	0	1	1	D	1	0		Rn			Vd		size	0	0	index_align		Rm								

31	30	29	28	27	26	25	24	23	22	21	20	19	18	17	16	15	14	13	12	11	10	9	8	7	6	5	4	3	2	1	0
1	1	1	1	0	1	0	0	1	D	1	0		Rn			Vd		size	0	0	index_align		Rm								

```

if size == '11' then SEE VLD1 (single element to all lanes);
case size of
  when '00'
    if index_align<0> != '0' then UNDEFINED;
    ebytes = 1; esize = 8; index = UInt(index_align<3:1>); alignment = 1;
  when '01'
    if index_align<1> != '0' then UNDEFINED;
    ebytes = 2; esize = 16; index = UInt(index_align<3:2>);
    alignment = if index_align<0> == '0' then 1 else 2;
  when '10'
    if index_align<2> != '0' then UNDEFINED;
    if index_align<1:0> != '00' && index_align<1:0> != '11' then UNDEFINED;
    ebytes = 4; esize = 32; index = UInt(index_align<3>);
    alignment = if index_align<1:0> == '00' then 1 else 4;
d = UInt(D:Vd); n = UInt(Rn); m = UInt(Rm);
wback = (m != 15); register_index = (m != 15 && m != 13);
if n == 15 then UNPREDICTABLE;

```



## Assembler syntax

VLD1{<c>}{<q>}.<size> <list>, [<Rn>{:<align>}]	Encoded as Rm = 0b1111
VLD1{<c>}{<q>}.<size> <list>, [<Rn>{:<align>}]!	Encoded as Rm = 0b1101
VLD1{<c>}{<q>}.<size> <list>, [<Rn>{:<align>}], <Rm>	Rm cannot be 0b11x1

where:

<c>, <q>	See <i>Standard assembler syntax fields on page A8-287</i> . An ARM VLD1 instruction must be unconditional. ARM strongly recommends that a Thumb VLD1 instruction is unconditional, see <i>Conditional execution on page A8-288</i> .
<size>	The data size. It must be one of: 8            encoded as size = 0b00. 16          encoded as size = 0b01. 32          encoded as size = 0b10.
<list>	The register containing the element to load. It must be {<Dd[x]>}. The register <Dd> is encoded in D:Vd.
<Rn>	Contains the base address for the access.
<align>	The alignment. It can be one of: 16          2-byte alignment, available only if <size> is 16 32          4-byte alignment, available only if <size> is 32 <b>omitted</b> Standard alignment, see <i>Unaligned data access on page A3-108</i> . : is the preferred separator before the <align> value, but the alignment can be specified as @<align>, see <i>Advanced SIMD addressing mode on page A7-277</i> .
!	If present, specifies writeback.
<Rm>	Contains an address offset applied after the access.

For more information about <Rn>, !, and <Rm>, see *Advanced SIMD addressing mode on page A7-277*.

Table A8-4 shows the encoding of index and alignment for the different <size> values.

**Table A8-4 Encoding of index and alignment**

	<size> == 8	<size> == 16	<size> == 32
Index	index_align[3:1] = x	index_align[3:2] = x	index_align[3] = x
<align> omitted	index_align[0] = 0	index_align[1:0] = '00'	index_align[2:0] = '000'
<align> == 16	-	index_align[1:0] = '01'	-
<align> == 32	-	-	index_align[2:0] = '011'

## Operation

```

if ConditionPassed() then
    EncodingSpecificOperations(); CheckAdvSIMDEnabled(); NullCheckIfThumbEE(n);
    address = R[n]; if (address MOD alignment) != 0 then GenerateAlignmentException();
    if wback then R[n] = R[n] + (if register_index then R[m] else ebytes);
    Elem[D[d],index,esize] = MemU[address,ebytes];

```

## Exceptions

Undefined Instruction, Hyp Trap, Data Abort.

### A8.8.322 VLD1 (single element to all lanes)

This instruction loads one element from memory into every element of one or two vectors. For details of the addressing mode see *Advanced SIMD addressing mode* on page A7-277.

Depending on settings in the CPACR, NSACR, and HCPTR registers, and the security state and mode in which the instruction is executed, an attempt to execute the instruction might be UNDEFINED, or trapped to Hyp mode. *Summary of access controls for Advanced SIMD functionality* on page B1-1232 summarizes these controls.

ARM deprecates the conditional execution of any Advanced SIMD instruction encoding that is not also available as a VFP instruction encoding, see *Conditional execution* on page A8-288.

#### Encoding T1/A1 Advanced SIMD

VLD1<c>.<size> <list>, [<Rn>{:<align>}]{!}

VLD1<c>.<size> <list>, [<Rn>{:<align>}], <Rm>

15	14	13	12	11	10	9	8	7	6	5	4	3	2	1	0	15	14	13	12	11	10	9	8	7	6	5	4	3	2	1	0
1	1	1	1	1	0	0	1	1	D	1	0		Rn			Vd		1	1	0	0	size	T	a		Rm					

31	30	29	28	27	26	25	24	23	22	21	20	19	18	17	16	15	14	13	12	11	10	9	8	7	6	5	4	3	2	1	0
1	1	1	1	0	1	0	0	1	D	1	0		Rn			Vd		1	1	0	0	size	T	a		Rm					

```

if size == '11' || (size == '00' && a == '1') then UNDEFINED;
ebytes = 1 << UInt(size); elements = 8 DIV ebytes; regs = if T == '0' then 1 else 2;
alignment = if a == '0' then 1 else ebytes;
d = UInt(D:Vd); n = UInt(Rn); m = UInt(Rm);
wback = (m != 15); register_index = (m != 15 && m != 13);
if n == 15 || d+regs > 32 then UNPREDICTABLE;

```

## Assembler syntax

VLD1{<c>}{<q>}.<size> <list>, [<Rn>{:<align>}] Encoded as Rm = 0b1111  
VLD1{<c>}{<q>}.<size> <list>, [<Rn>{:<align>}]! Encoded as Rm = 0b1101  
VLD1{<c>}{<q>}.<size> <list>, [<Rn>{:<align>}], <Rm> Rm cannot be 0b11x1

where:

<c>, <q> See [Standard assembler syntax fields on page A8-287](#). An ARM VLD1 instruction must be unconditional. ARM strongly recommends that a Thumb VLD1 instruction is unconditional, see [Conditional execution on page A8-288](#).

<size> The data size. It must be one of:  
8 encoded as size = 0b00.  
16 encoded as size = 0b01.  
32 encoded as size = 0b10.

<list> The list of registers to load. It must be one of:  
{<Dd[>]} encoded as D:Vd = <Dd>, T = 0.  
{<Dd[>], <Dd+1[>]} encoded as D:Vd = <Dd>, T = 1.

<Rn> Contains the base address for the access.

<align> The alignment. It can be one of:  
16 2-byte alignment, available only if <size> is 16, encoded as a = 1.  
32 4-byte alignment, available only if <size> is 32, encoded as a = 1.  
**omitted** Standard alignment, see [Unaligned data access on page A3-108](#). Encoded as a = 0.  
: is the preferred separator before the <align> value, but the alignment can be specified as @<align>, see [Advanced SIMD addressing mode on page A7-277](#).

! If present, specifies writeback.

<Rm> Contains an address offset applied after the access.

For more information about <Rn>, !, and <Rm>, see [Advanced SIMD addressing mode on page A7-277](#).

## Operation

```
if ConditionPassed() then
    EncodingSpecificOperations(); CheckAdvSIMDEnabled(); NullCheckIfThumbEE(n);
    address = R[n]; if (address MOD alignment) != 0 then GenerateAlignmentException();
    if wback then R[n] = R[n] + (if register_index then R[m] else ebytes);
    replicated_element = Replicate(MemU[address,ebytes], elements);
    for r = 0 to regs-1
        D[d+r] = replicated_element;
```

## Exceptions

Undefined Instruction, Hyp Trap, Data Abort.

### A8.8.323 VLD2 (multiple 2-element structures)

This instruction loads multiple 2-element structures from memory into two or four registers, with de-interleaving. For more information, see [Element and structure load/store instructions on page A4-181](#). Every element of each register is loaded. For details of the addressing mode see [Advanced SIMD addressing mode on page A7-277](#).

Depending on settings in the CPACR, NSACR, and HCPTR registers, and the security state and mode in which the instruction is executed, an attempt to execute the instruction might be UNDEFINED, or trapped to Hyp mode. [Summary of access controls for Advanced SIMD functionality on page B1-1232](#) summarizes these controls.

ARM deprecates the conditional execution of any Advanced SIMD instruction encoding that is not also available as a VFP instruction encoding, see [Conditional execution on page A8-288](#).

#### Encoding T1/A1 Advanced SIMD

VLD2<c>.<size> <list>, [<Rn>{:<align>}]{!}

VLD2<c>.<size> <list>, [<Rn>{:<align>}], <Rm>

15	14	13	12	11	10	9	8	7	6	5	4	3	2	1	0	15	14	13	12	11	10	9	8	7	6	5	4	3	2	1	0
1	1	1	1	1	0	0	1	0	D	1	0		Rn			Vd			type	size	align					Rm					

31	30	29	28	27	26	25	24	23	22	21	20	19	18	17	16	15	14	13	12	11	10	9	8	7	6	5	4	3	2	1	0
1	1	1	1	0	1	0	0	0	D	1	0		Rn			Vd			type	size	align								Rm		

```

if size == '11' then UNDEFINED;
case type of
  when '1000'
    regs = 1; inc = 1; if align == '11' then UNDEFINED;
  when '1001'
    regs = 1; inc = 2; if align == '11' then UNDEFINED;
  when '0011'
    regs = 2; inc = 2;
  otherwise
    SEE "Related encodings";
alignment = if align == '00' then 1 else 4 << UInt(align);
ebytes = 1 << UInt(size); esize = 8 * ebytes; elements = 8 DIV ebytes;
d = UInt(D:Vd); d2 = d + inc; n = UInt(Rn); m = UInt(Rm);
wback = (m != 15); register_index = (m != 15 && m != 13);
if n == 15 || d2+regs > 32 then UNPREDICTABLE;

```

**Related encodings** See [Advanced SIMD element or structure load/store instructions on page A7-275](#).

## Assembler syntax

VLD2{<c>}{<q>}.<size> <list>, [<Rn>{:<align>}]	Encoded as Rm = 0b1111
VLD2{<c>}{<q>}.<size> <list>, [<Rn>{:<align>}]!	Encoded as Rm = 0b1101
VLD2{<c>}{<q>}.<size> <list>, [<Rn>{:<align>}], <Rm>	Rm cannot be 0b11x1

where:

<c>, <q>	See <a href="#">Standard assembler syntax fields on page A8-287</a> . An ARM VLD2 instruction must be unconditional. ARM strongly recommends that a Thumb VLD2 instruction is unconditional, see <a href="#">Conditional execution on page A8-288</a> .
<size>	The data size. It must be one of: 8            encoded as size = 0b00. 16          encoded as size = 0b01. 32          encoded as size = 0b10.
<list>	The list of registers to load. It must be one of: {<Dd>, <Dd+1>}      Single-spaced registers, encoded as D:Vd = <Dd>, type = 0b1000. {<Dd>, <Dd+2>}      Double-spaced registers, encoded as D:Vd = <Dd>, type = 0b1001. {<Dd>, <Dd+1>, <Dd+2>, <Dd+3>} Single-spaced registers, encoded as D:Vd = <Dd>, type = 0b0011.
<Rn>	Contains the base address for the access.
<align>	The alignment. It can be one of: 64            8-byte alignment, encoded as align = 0b01. 128          16-byte alignment, encoded as align = 0b10. 256          32-byte alignment, available only if <list> contains four registers. Encoded as align = 0b11. <b>omitted</b> Standard alignment, see <a href="#">Unaligned data access on page A3-108</a> . Encoded as align = 0b00. : is the preferred separator before the <align> value, but the alignment can be specified as @<align>, see <a href="#">Advanced SIMD addressing mode on page A7-277</a> .
!	If present, specifies writeback.
<Rm>	Contains an address offset applied after the access.

For more information about <Rn>, !, and <Rm>, see [Advanced SIMD addressing mode on page A7-277](#).

## Operation

```

if ConditionPassed() then
    EncodingSpecificOperations(); CheckAdvSIMDEnabled(); NullCheckIfThumbEE(n);
    address = R[n]; if (address MOD alignment) != 0 then GenerateAlignmentException();
    if wback then R[n] = R[n] + (if register_index then R[m] else 16*regs);
    for r = 0 to regs-1
        for e = 0 to elements-1
            Elem[D[d+r],e,esize] = MemU[address,ebytes];
            Elem[D[d2+r],e,esize] = MemU[address+ebytes,ebytes];
            address = address + 2*ebytes;

```

## Exceptions

Undefined Instruction, Hyp Trap, Data Abort.

### A8.8.324 VLD2 (single 2-element structure to one lane)

This instruction loads one 2-element structure from memory into corresponding elements of two registers. Elements of the registers that are not loaded are unchanged. For details of the addressing mode see [Advanced SIMD addressing mode on page A7-277](#).

Depending on settings in the CPACR, NSACR, and HCPTR registers, and the security state and mode in which the instruction is executed, an attempt to execute the instruction might be UNDEFINED, or trapped to Hyp mode. [Summary of access controls for Advanced SIMD functionality on page B1-1232](#) summarizes these controls.

ARM deprecates the conditional execution of any Advanced SIMD instruction encoding that is not also available as a VFP instruction encoding, see [Conditional execution on page A8-288](#).

#### Encoding T1/A1 Advanced SIMD

VLD2<<c>.<size> <list>, [<Rn>{:<align>}]{!}

VLD2<<c>.<size> <list>, [<Rn>{:<align>}], <Rm>

15	14	13	12	11	10	9	8	7	6	5	4	3	2	1	0	15	14	13	12	11	10	9	8	7	6	5	4	3	2	1	0
1	1	1	1	1	0	0	1	1	D	1	0		Rn			Vd		size	0	1	index_align					Rm					

31	30	29	28	27	26	25	24	23	22	21	20	19	18	17	16	15	14	13	12	11	10	9	8	7	6	5	4	3	2	1	0
1	1	1	1	0	1	0	0	1	D	1	0		Rn			Vd		size	0	1	index_align								Rm		

```

if size == '11' then SEE VLD2 (single 2-element structure to all lanes);
case size of
  when '00'
    ebytes = 1; esize = 8; index = UInt(index_align<3:1>); inc = 1;
    alignment = if index_align<0> == '0' then 1 else 2;
  when '01'
    ebytes = 2; esize = 16; index = UInt(index_align<3:2>);
    inc = if index_align<1> == '0' then 1 else 2;
    alignment = if index_align<0> == '0' then 1 else 4;
  when '10'
    if index_align<1> != '0' then UNDEFINED;
    ebytes = 4; esize = 32; index = UInt(index_align<3>);
    inc = if index_align<2> == '0' then 1 else 2;
    alignment = if index_align<0> == '0' then 1 else 8;
d = UInt(D:Vd); d2 = d + inc; n = UInt(Rn); m = UInt(Rm);
wback = (m != 15); register_index = (m != 15 && m != 13);
if n == 15 || d2 > 31 then UNPREDICTABLE;

```

#### Assembler syntax

VLD2{<c>}{<q>}.<size> <list>, [<Rn>{:<align>}]	Encoded as Rm = 0b1111
VLD2{<c>}{<q>}.<size> <list>, [<Rn>{:<align>}]!	Encoded as Rm = 0b1101
VLD2{<c>}{<q>}.<size> <list>, [<Rn>{:<align>}], <Rm>	Rm cannot be 0b11x1

where:

<c>, <q> See [Standard assembler syntax fields on page A8-287](#). An ARM VLD2 instruction must be unconditional. ARM strongly recommends that a Thumb VLD2 instruction is unconditional, see [Conditional execution on page A8-288](#).

<size> The data size. It must be one of:

8	encoded as size = 0b00.
16	encoded as size = 0b01.
32	encoded as size = 0b10.

- <list> The registers containing the structure. Encoded with D:Vd = <Dd>. It must be one of:  
 {<Dd[x]>, <Dd+1[x]>} Single-spaced registers, see [Table A8-5](#).  
 {<Dd[x]>, <Dd+2[x]>} Double-spaced registers, see [Table A8-5](#).  
 This is not available if <size> == 8.
- <Rn> Contains the base address for the access.
- <align> The alignment. It can be one of:  
 16 2-byte alignment, available only if <size> is 8  
 32 4-byte alignment, available only if <size> is 16  
 64 8-byte alignment, available only if <size> is 32  
**omitted** Standard alignment, see [Unaligned data access on page A3-108](#).  
 : is the preferred separator before the <align> value, but the alignment can be specified as @<align>, see [Advanced SIMD addressing mode on page A7-277](#).
- ! If present, specifies writeback.
- <Rm> Contains an address offset applied after the access.

For more information about <Rn>, !, and <Rm> see [Advanced SIMD addressing mode on page A7-277](#).

**Table A8-5 Encoding of index, alignment, and register spacing**

	<size> == 8	<size> == 16	<size> == 32
Index	index_align[3:1] = x	index_align[3:2] = x	index_align[3] = x
Single-spacing	-	index_align[1] = 0	index_align[2] = 0
Double-spacing	-	index_align[1] = 1	index_align[2] = 1
<align> omitted	index_align[0] = 0	index_align[0] = 0	index_align[1:0] = '00'
<align> == 16	index_align[0] = 1	-	-
<align> == 32	-	index_align[0] = 1	-
<align> == 64	-	-	index_align[1:0] = '01'

## Operation

```

if ConditionPassed() then
    EncodingSpecificOperations(); CheckAdvSIMDEnabled(); NullCheckIfThumbEE(n);
    address = R[n]; if (address MOD alignment) != 0 then GenerateAlignmentException();
    if wback then R[n] = R[n] + (if register_index then R[m] else 2*ebytes);
    Elem[D[d],index,esize] = MemU[address,ebytes];
    Elem[D[d2],index,esize] = MemU[address+ebytes,ebytes];
  
```

## Exceptions

Undefined Instruction, Hyp Trap, Data Abort.

### A8.8.325 VLD2 (single 2-element structure to all lanes)

This instruction loads one 2-element structure from memory into all lanes of two registers. For details of the addressing mode see *Advanced SIMD addressing mode on page A7-277*.

Depending on settings in the CPACR, NSACR, and HCPTR registers, and the security state and mode in which the instruction is executed, an attempt to execute the instruction might be UNDEFINED, or trapped to Hyp mode. *Summary of access controls for Advanced SIMD functionality on page B1-1232* summarizes these controls.

ARM deprecates the conditional execution of any Advanced SIMD instruction encoding that is not also available as a VFP instruction encoding, see *Conditional execution on page A8-288*.

#### Encoding T1/A1 Advanced SIMD

VLD2<c>.<size> <list>, [<Rn>{:<align>}]{!}

VLD2<c>.<size> <list>, [<Rn>{:<align>}], <Rm>

15	14	13	12	11	10	9	8	7	6	5	4	3	2	1	0	15	14	13	12	11	10	9	8	7	6	5	4	3	2	1	0
1	1	1	1	1	0	0	1	1	D	1	0		Rn			Vd		1	1	0	1	size	T	a		Rm					

31	30	29	28	27	26	25	24	23	22	21	20	19	18	17	16	15	14	13	12	11	10	9	8	7	6	5	4	3	2	1	0
1	1	1	1	0	1	0	0	1	D	1	0		Rn			Vd		1	1	0	1	size	T	a		Rm					

```

if size == '11' then UNDEFINED;
ebytes = 1 << UInt(size); elements = 8 DIV ebytes;
alignment = if a == '0' then 1 else 2*ebytes;
inc = if T == '0' then 1 else 2;
d = UInt(D:Vd); d2 = d + inc; n = UInt(Rn); m = UInt(Rm);
wback = (m != 15); register_index = (m != 15 && m != 13);
if n == 15 || d2 > 31 then UNPREDICTABLE;

```



## Assembler syntax

VLD2{<c>}{<q>}.<size> <list>, [<Rn>{:<align>}] Encoded as Rm = 0b1111  
VLD2{<c>}{<q>}.<size> <list>, [<Rn>{:<align>}]! Encoded as Rm = 0b1101  
VLD2{<c>}{<q>}.<size> <list>, [<Rn>{:<align>}], <Rm> Rm cannot be 0b11x1

where:

<c>, <q> See [Standard assembler syntax fields on page A8-287](#). An ARM VLD2 instruction must be unconditional. ARM strongly recommends that a Thumb VLD2 instruction is unconditional, see [Conditional execution on page A8-288](#).

<size> The data size. It must be one of:  
8 encoded as size = 0b00.  
16 encoded as size = 0b01.  
32 encoded as size = 0b10.

<list> The registers containing the structure. It must be one of:  
{<Dd[>, <Dd+1[>} Single-spaced registers, encoded as D:Vd = <Dd>, T = 0.  
{<Dd[>, <Dd+2[>} Double-spaced registers, encoded as D:Vd = <Dd>, T = 1.

<Rn> Contains the base address for the access.

<align> The alignment. It can be one of:  
16 2-byte alignment, available only if <size> is 8, encoded as a = 1.  
32 4-byte alignment, available only if <size> is 16, encoded as a = 1.  
64 8-byte alignment, available only if <size> is 32, encoded as a = 1.  
**omitted** Standard alignment, see [Unaligned data access on page A3-108](#). Encoded as a = 0.  
: is the preferred separator before the <align> value, but the alignment can be specified as @<align>, see [Advanced SIMD addressing mode on page A7-277](#).

! If present, specifies writeback.

<Rm> Contains an address offset applied after the access.

For more information about <Rn>, !, and <Rm>, see [Advanced SIMD addressing mode on page A7-277](#).

## Operation

```
if ConditionPassed() then
    EncodingSpecificOperations(); CheckAdvSIMDEnabled(); NullCheckIfThumbEE(n);
    address = R[n]; if (address MOD alignment) != 0 then GenerateAlignmentException();
    if wback then R[n] = R[n] + (if register_index then R[m] else 2*ebytes);
    D[d] = Replicate(MemU[address,ebytes], elements);
    D[d2] = Replicate(MemU[address+ebytes,ebytes], elements);
```

## Exceptions

Undefined Instruction, Hyp Trap, Data Abort.

### A8.8.326 VLD3 (multiple 3-element structures)

This instruction loads multiple 3-element structures from memory into three registers, with de-interleaving. For more information, see [Element and structure load/store instructions on page A4-181](#). Every element of each register is loaded. For details of the addressing mode see [Advanced SIMD addressing mode on page A7-277](#).

Depending on settings in the CPACR, NSACR, and HCPTR registers, and the security state and mode in which the instruction is executed, an attempt to execute the instruction might be UNDEFINED, or trapped to Hyp mode. [Summary of access controls for Advanced SIMD functionality on page B1-1232](#) summarizes these controls.

ARM deprecates the conditional execution of any Advanced SIMD instruction encoding that is not also available as a VFP instruction encoding, see [Conditional execution on page A8-288](#).

#### Encoding T1/A1 Advanced SIMD

VLD3<c>.<size> <list>, [<Rn>{:<align>}]{!}

VLD3<c>.<size> <list>, [<Rn>{:<align>}], <Rm>

15	14	13	12	11	10	9	8	7	6	5	4	3	2	1	0	15	14	13	12	11	10	9	8	7	6	5	4	3	2	1	0
1	1	1	1	1	0	0	1	0	D	1	0			Rn			Vd		type	size	align				Rm						

31	30	29	28	27	26	25	24	23	22	21	20	19	18	17	16	15	14	13	12	11	10	9	8	7	6	5	4	3	2	1	0
1	1	1	1	0	1	0	0	0	D	1	0			Rn			Vd		type	size	align				Rm						

```

if size == '11' || align<1> == '1' then UNDEFINED;
case type of
  when '0100'
    inc = 1;
  when '0101'
    inc = 2;
  otherwise
    SEE "Related encodings";
alignment = if align<0> == '0' then 1 else 8;
ebytes = 1 << UInt(size); esize = 8 * ebytes; elements = 8 DIV ebytes;
d = UInt(D:Vd); d2 = d + inc; d3 = d2 + inc; n = UInt(Rn); m = UInt(Rm);
wback = (m != 15); register_index = (m != 15 && m != 13);
if n == 15 || d3 > 31 then UNPREDICTABLE;

```

**Related encodings** See [Advanced SIMD element or structure load/store instructions on page A7-275](#).

## Assembler syntax

VLD3{<c>}{<q>}.<size> <list>, [<Rn>{:<align>}]	Encoded as Rm = 0b1111
VLD3{<c>}{<q>}.<size> <list>, [<Rn>{:<align>}]!	Encoded as Rm = 0b1101
VLD3{<c>}{<q>}.<size> <list>, [<Rn>{:<align>}], <Rm>	Rm cannot be 0b11x1

where:

<c>, <q>	See <a href="#">Standard assembler syntax fields on page A8-287</a> . An ARM VLD3 instruction must be unconditional. ARM strongly recommends that a Thumb VLD3 instruction is unconditional, see <a href="#">Conditional execution on page A8-288</a> .
<size>	The data size. It must be one of: 8            encoded as size = 0b00. 16          encoded as size = 0b01. 32          encoded as size = 0b10.
<list>	The list of registers to load. It must be one of: {<Dd>, <Dd+1>, <Dd+2>} Single-spaced registers, encoded as D:Vd = <Dd>, type = 0b0100. {<Dd>, <Dd+2>, <Dd+4>} Double-spaced registers, encoded as D:Vd = <Dd>, type = 0b0101.
<Rn>	Contains the base address for the access.
<align>	The alignment. It can be: 64            8-byte alignment, encoded as align = 0b01. <b>omitted</b> Standard alignment, see <a href="#">Unaligned data access on page A3-108</a> . Encoded as align = 0b00. : is the preferred separator before the <align> value, but the alignment can be specified as @<align>, see <a href="#">Advanced SIMD addressing mode on page A7-277</a> .
!	If present, specifies writeback.
<Rm>	Contains an address offset applied after the access.

For more information about <Rn>, !, and <Rm>, see [Advanced SIMD addressing mode on page A7-277](#).

## Operation

```

if ConditionPassed() then
    EncodingSpecificOperations(); CheckAdvSIMDEnabled(); NullCheckIfThumbEE(n);
    address = R[n]; if (address MOD alignment) != 0 then GenerateAlignmentException();
    if wback then R[n] = R[n] + (if register_index then R[m] else 24);
    for e = 0 to elements-1
        Elem[D[d],e,esize] = MemU[address,ebytes];
        Elem[D[d2],e,esize] = MemU[address+ebytes,ebytes];
        Elem[D[d3],e,esize] = MemU[address+2*ebytes,ebytes];
        address = address + 3*ebytes;

```

## Exceptions

Undefined Instruction, Hyp Trap, Data Abort.

### A8.8.327 VLD3 (single 3-element structure to one lane)

This instruction loads one 3-element structure from memory into corresponding elements of three registers. Elements of the registers that are not loaded are unchanged. For details of the addressing mode see *Advanced SIMD addressing mode* on page A7-277.

Depending on settings in the CPACR, NSACR, and HCPTR registers, and the security state and mode in which the instruction is executed, an attempt to execute the instruction might be UNDEFINED, or trapped to Hyp mode. *Summary of access controls for Advanced SIMD functionality* on page B1-1232 summarizes these controls.

ARM deprecates the conditional execution of any Advanced SIMD instruction encoding that is not also available as a VFP instruction encoding, see *Conditional execution* on page A8-288.

#### Encoding T1/A1 Advanced SIMD

VLD3<c>.<size> <list>, [<Rn>]{}!

VLD3<c>.<size> <list>, [<Rn>], <Rm>

15	14	13	12	11	10	9	8	7	6	5	4	3	2	1	0	15	14	13	12	11	10	9	8	7	6	5	4	3	2	1	0
1	1	1	1	1	0	0	1	1	D	1	0		Rn			Vd		size	1	0	index_align			Rm							

31	30	29	28	27	26	25	24	23	22	21	20	19	18	17	16	15	14	13	12	11	10	9	8	7	6	5	4	3	2	1	0
1	1	1	1	0	1	0	0	1	D	1	0		Rn			Vd		size	1	0	index_align			Rm							

```

if size == '11' then SEE VLD3 (single 3-element structure to all lanes);
case size of
  when '00'
    if index_align<0> != '0' then UNDEFINED;
    ebytes = 1; esize = 8; index = UInt(index_align<3:1>); inc = 1;
  when '01'
    if index_align<0> != '0' then UNDEFINED;
    ebytes = 2; esize = 16; index = UInt(index_align<3:2>);
    inc = if index_align<1> == '0' then 1 else 2;
  when '10'
    if index_align<1:0> != '00' then UNDEFINED;
    ebytes = 4; esize = 32; index = UInt(index_align<3>);
    inc = if index_align<2> == '0' then 1 else 2;
d = UInt(D:Vd); d2 = d + inc; d3 = d2 + inc; n = UInt(Rn); m = UInt(Rm);
wback = (m != 15); register_index = (m != 15 && m != 13);
if n == 15 || d3 > 31 then UNPREDICTABLE;

```

## Assembler syntax

VLD3{<c>}{<q>}.<size> <list>, [<Rn>]	Encoded as Rm = 0b1111
VLD3{<c>}{<q>}.<size> <list>, [<Rn>]!	Encoded as Rm = 0b1101
VLD3{<c>}{<q>}.<size> <list>, [<Rn>], <Rm>	Rm cannot be 0b11x1

where:

<c>, <q>	See <a href="#">Standard assembler syntax fields on page A8-287</a> . An ARM VLD3 instruction must be unconditional. ARM strongly recommends that a Thumb VLD3 instruction is unconditional, see <a href="#">Conditional execution on page A8-288</a> .
<size>	The data size. It must be one of: 8            encoded as size = 0b00. 16           encoded as size = 0b01. 32           encoded as size = 0b10.
<list>	The registers containing the structure. Encoded with D:Vd = <Dd>. It must be one of: {<Dd[x]>, <Dd+1[x]>, <Dd+2[x]>} Single-spaced registers, see <a href="#">Table A8-6</a> . {<Dd[x]>, <Dd+2[x]>, <Dd+4[x]>} Double-spaced registers, see <a href="#">Table A8-6</a> . This is not available if <size> == 8.
<Rn>	Contains the base address for the access.
!	If present, specifies writeback.
<Rm>	Contains an address offset applied after the access.

For more information about <Rn>, !, and <Rm>, see [Advanced SIMD addressing mode on page A7-277](#).

**Table A8-6 Encoding of index and register spacing**

	<size> == 8	<size> == 16	<size> == 32
Index	index_align[3:1] = x	index_align[3:2] = x	index_align[3] = x
Single-spacing	index_align[0] = 0	index_align[1:0] = '00'	index_align[2:0] = '000'
Double-spacing	-	index_align[1:0] = '10'	index_align[2:0] = '100'

## Alignment

Standard alignment rules apply, see [Unaligned data access on page A3-108](#).

## Operation

```

if ConditionPassed() then
    EncodingSpecificOperations(); CheckAdvSIMDEnabled(); NullCheckIfThumbEE(n);
    address = R[n];
    if wback then R[n] = R[n] + (if register_index then R[m] else 3*bytes);
    Elem[D[d],index,esize] = MemU[address,ebytes];
    Elem[D[d2],index,esize] = MemU[address+ebytes,ebytes];
    Elem[D[d3],index,esize] = MemU[address+2*ebytes,ebytes];

```

## Exceptions

Undefined Instruction, Hyp Trap, Data Abort.

### A8.8.328 VLD3 (single 3-element structure to all lanes)

This instruction loads one 3-element structure from memory into all lanes of three registers. For details of the addressing mode see *Advanced SIMD addressing mode on page A7-277*.

Depending on settings in the CPACR, NSACR, and HCPTR registers, and the security state and mode in which the instruction is executed, an attempt to execute the instruction might be UNDEFINED, or trapped to Hyp mode. *Summary of access controls for Advanced SIMD functionality on page B1-1232* summarizes these controls.

ARM deprecates the conditional execution of any Advanced SIMD instruction encoding that is not also available as a VFP instruction encoding, see *Conditional execution on page A8-288*.

#### Encoding T1/A1 Advanced SIMD

VLD3<c>.<size> <list>, [<Rn>]{!}

VLD3<c>.<size> <list>, [<Rn>], <Rm>

15	14	13	12	11	10	9	8	7	6	5	4	3	2	1	0	15	14	13	12	11	10	9	8	7	6	5	4	3	2	1	0
1	1	1	1	1	0	0	1	1	D	1	0		Rn			Vd		1	1	1	0	size	T	a		Rm					

31	30	29	28	27	26	25	24	23	22	21	20	19	18	17	16	15	14	13	12	11	10	9	8	7	6	5	4	3	2	1	0
1	1	1	1	0	1	0	0	1	D	1	0		Rn			Vd		1	1	1	0	size	T	a		Rm					

```

if size == '11' || a == '1' then UNDEFINED;
ebytes = 1 << UInt(size); elements = 8 DIV ebytes;
inc = if T == '0' then 1 else 2;
d = UInt(D:Vd); d2 = d + inc; d3 = d2 + inc; n = UInt(Rn); m = UInt(Rm);
wback = (m != 15); register_index = (m != 15 && m != 13);
if n == 15 || d3 > 31 then UNPREDICTABLE;

```

## Assembler syntax

VLD3{<c>}{<q>}.<size> <list>, [<Rn>]	Encoded as Rm = 0b1111
VLD3{<c>}{<q>}.<size> <list>, [<Rn>!]	Encoded as Rm = 0b1101
VLD3{<c>}{<q>}.<size> <list>, [<Rn>], <Rm>	Rm cannot be 0b11x1

where:

<c>, <q>	See <a href="#">Standard assembler syntax fields on page A8-287</a> . An ARM VLD3 instruction must be unconditional. ARM strongly recommends that a Thumb VLD3 instruction is unconditional, see <a href="#">Conditional execution on page A8-288</a> .
<size>	The data size. It must be one of: 8            encoded as size = 0b00. 16          encoded as size = 0b01. 32          encoded as size = 0b10.
<list>	The registers containing the structures. It must be one of: {<Dd[]>, <Dd+1[]>, <Dd+2[]>} Single-spaced registers, encoded as D:Vd = <Dd>, T = 0. {<Dd[]>, <Dd+2[]>, <Dd+4[]>} Double-spaced registers, encoded as D:Vd = <Dd>, T = 1.
<Rn>	Contains the base address for the access.
!	If present, specifies writeback.
<Rm>	Contains an address offset applied after the access.

For more information about <Rn>, !, and <Rm>, see [Advanced SIMD addressing mode on page A7-277](#).

## Alignment

Standard alignment rules apply, see [Unaligned data access on page A3-108](#).

The a bit must be encoded as 0.

## Operation

```
if ConditionPassed() then
    EncodingSpecificOperations(); CheckAdvSIMDEnabled(); NullCheckIfThumbEE(n);
    address = R[n];
    if wback then R[n] = R[n] + (if register_index then R[m] else 3*bytes);
    D[d] = Replicate(MemU[address,ebytes], elements);
    D[d2] = Replicate(MemU[address+ebytes,ebytes], elements);
    D[d3] = Replicate(MemU[address+2*ebytes,ebytes], elements);
```

## Exceptions

Undefined Instruction, Hyp Trap, Data Abort.

### A8.8.329 VLD4 (multiple 4-element structures)

This instruction loads multiple 4-element structures from memory into four registers, with de-interleaving. For more information, see *Element and structure load/store instructions* on page A4-181. Every element of each register is loaded. For details of the addressing mode see *Advanced SIMD addressing mode* on page A7-277.

Depending on settings in the CPACR, NSACR, and HCPTR registers, and the security state and mode in which the instruction is executed, an attempt to execute the instruction might be UNDEFINED, or trapped to Hyp mode. *Summary of access controls for Advanced SIMD functionality* on page B1-1232 summarizes these controls.

ARM deprecates the conditional execution of any Advanced SIMD instruction encoding that is not also available as a VFP instruction encoding, see *Conditional execution* on page A8-288.

#### Encoding T1/A1 Advanced SIMD

VLD4<c>.<size> <list>, [<Rn>{:<align>}]{!}

VLD4<c>.<size> <list>, [<Rn>{:<align>}], <Rm>

15	14	13	12	11	10	9	8	7	6	5	4	3	2	1	0	15	14	13	12	11	10	9	8	7	6	5	4	3	2	1	0
1	1	1	1	1	0	0	1	0	D	1	0		Rn			Vd			type		size	align		Rm							

31	30	29	28	27	26	25	24	23	22	21	20	19	18	17	16	15	14	13	12	11	10	9	8	7	6	5	4	3	2	1	0
1	1	1	1	0	1	0	0	0	D	1	0		Rn			Vd			type		size	align		Rm							

```

if size == '11' then UNDEFINED;
case type of
  when '0000'
    inc = 1;
  when '0001'
    inc = 2;
  otherwise
    SEE "Related encodings";
alignment = if align == '00' then 1 else 4 << UInt(align);
ebytes = 1 << UInt(size); esize = 8 * ebytes; elements = 8 DIV ebytes;
d = UInt(D:Vd); d2 = d + inc; d3 = d2 + inc; d4 = d3 + inc; n = UInt(Rn); m = UInt(Rm);
wback = (m != 15); register_index = (m != 15 && m != 13);
if n == 15 || d4 > 31 then UNPREDICTABLE;

```

**Related encodings** See *Advanced SIMD element or structure load/store instructions* on page A7-275.



## Assembler syntax

VLD4{<c>}{<q>}.<size> <list>, [<Rn>{:<align>}]	Encoded as Rm = 0b1111
VLD4{<c>}{<q>}.<size> <list>, [<Rn>{:<align>}]!	Encoded as Rm = 0b1101
VLD4{<c>}{<q>}.<size> <list>, [<Rn>{:<align>}], <Rm>	Rm cannot be 0b11x1

where:

<c>, <q>	See <a href="#">Standard assembler syntax fields on page A8-287</a> . An ARM VLD4 instruction must be unconditional. ARM strongly recommends that a Thumb VLD4 instruction is unconditional, see <a href="#">Conditional execution on page A8-288</a> .
<size>	The data size. It must be one of: 8            encoded as size = 0b00. 16          encoded as size = 0b01. 32          encoded as size = 0b10.
<list>	The list of registers to load. It must be one of: {<Dd>, <Dd+1>, <Dd+2>, <Dd+3>} Single-spaced registers, encoded as D:Vd = <Dd>, type = 0b0000. {<Dd>, <Dd+2>, <Dd+4>, <Dd+6>} Double-spaced registers, encoded as D:Vd = <Dd>, type = 0b0001.
<Rn>	Contains the base address for the access.
<align>	The alignment. It can be one of: 64            8-byte alignment, encoded as align = 0b01. 128          16-byte alignment, encoded as align = 0b10. 256          32-byte alignment, encoded as align = 0b11. <b>omitted</b> Standard alignment, see <a href="#">Unaligned data access on page A3-108</a> . Encoded as align = 0b00. : is the preferred separator before the <align> value, but the alignment can be specified as @<align>, see <a href="#">Advanced SIMD addressing mode on page A7-277</a> .
!	If present, specifies writeback.
<Rm>	Contains an address offset applied after the access.

For more information about <Rn>, !, and <Rm>, see [Advanced SIMD addressing mode on page A7-277](#).

## Operation

```

if ConditionPassed() then
    EncodingSpecificOperations(); CheckAdvSIMDEnabled(); NullCheckIfThumbEE(n);
    address = R[n]; if (address MOD alignment) != 0 then GenerateAlignmentException();
    if wback then R[n] = R[n] + (if register_index then R[m] else 32);
    for e = 0 to elements-1
        Elem[D[d],e,esize] = MemU[address,ebytes];
        Elem[D[d2],e,esize] = MemU[address+ebytes,ebytes];
        Elem[D[d3],e,esize] = MemU[address+2*ebytes,ebytes];
        Elem[D[d4],e,esize] = MemU[address+3*ebytes,ebytes];
        address = address + 4*ebytes;

```

## Exceptions

Undefined Instruction, Hyp Trap, Data Abort.

### A8.8.330 VLD4 (single 4-element structure to one lane)

This instruction loads one 4-element structure from memory into corresponding elements of four registers. Elements of the registers that are not loaded are unchanged. For details of the addressing mode see [Advanced SIMD addressing mode on page A7-277](#).

Depending on settings in the CPACR, NSACR, and HCPTR registers, and the security state and mode in which the instruction is executed, an attempt to execute the instruction might be UNDEFINED, or trapped to Hyp mode. [Summary of access controls for Advanced SIMD functionality on page B1-1232](#) summarizes these controls.

ARM deprecates the conditional execution of any Advanced SIMD instruction encoding that is not also available as a VFP instruction encoding, see [Conditional execution on page A8-288](#).

#### Encoding T1/A1 Advanced SIMD

VLD4<<c>.<size> <list>, [<Rn>{:<align>}]{!}  
VLD4<<c>.<size> <list>, [<Rn>{:<align>}], <Rm>

15	14	13	12	11	10	9	8	7	6	5	4	3	2	1	0	15	14	13	12	11	10	9	8	7	6	5	4	3	2	1	0
1	1	1	1	1	0	0	1	1	D	1	0		Rn			Vd		size	1	1	index_align				Rm						

31	30	29	28	27	26	25	24	23	22	21	20	19	18	17	16	15	14	13	12	11	10	9	8	7	6	5	4	3	2	1	0
1	1	1	1	0	1	0	0	1	D	1	0		Rn			Vd		size	1	1	index_align				Rm						

```

if size == '11' then SEE VLD4 (single 4-element structure to all lanes);
case size of
  when '00'
    ebytes = 1; esize = 8; index = UInt(index_align<3:1>); inc = 1;
    alignment = if index_align<0> == '0' then 1 else 4;
  when '01'
    ebytes = 2; esize = 16; index = UInt(index_align<3:2>);
    inc = if index_align<1> == '0' then 1 else 2;
    alignment = if index_align<0> == '0' then 1 else 8;
  when '10'
    if index_align<1:0> == '11' then UNDEFINED;
    ebytes = 4; esize = 32; index = UInt(index_align<3>);
    inc = if index_align<2> == '0' then 1 else 2;
    alignment = if index_align<1:0> == '00' then 1 else 4 << UInt(index_align<1:0>);
d = UInt(D:Vd); d2 = d + inc; d3 = d2 + inc; d4 = d3 + inc; n = UInt(Rn); m = UInt(Rm);
wback = (m != 15); register_index = (m != 15 && m != 13);
if n == 15 || d4 > 31 then UNPREDICTABLE;

```

#### Assembler syntax

VLD4{<c>}{<q>}.<size> <list>, [<Rn>{:<align>}] Encoded as Rm = 0b1111  
VLD4{<c>}{<q>}.<size> <list>, [<Rn>{:<align>}]! Encoded as Rm = 0b1101  
VLD4{<c>}{<q>}.<size> <list>, [<Rn>{:<align>}], <Rm> Rm cannot be 0b11x1

where:

<c>, <q> See [Standard assembler syntax fields on page A8-287](#). An ARM VLD4 instruction must be unconditional. ARM strongly recommends that a Thumb VLD4 instruction is unconditional, see [Conditional execution on page A8-288](#).

<size> The data size. It must be one of:  
8 encoded as size = 0b00.  
16 encoded as size = 0b01.  
32 encoded as size = 0b10.

<list> The registers containing the structure. Encoded with D:Vd = <Dd>. It must be one of:  
{<Dd[x]>, <Dd+1[x]>, <Dd+2[x]>, <Dd+3[x]>}  
Single-spaced registers, see [Table A8-7](#).  
{<Dd[x]>, <Dd+2[x]>, <Dd+4[x]>, <Dd+6[x]>}  
Double-spaced registers, see [Table A8-7](#).  
Not available if <size> == 8.

<Rn> The base address for the access.

<align> The alignment. It can be:  
32 4-byte alignment, available only if <size> is 8.  
64 8-byte alignment, available only if <size> is 16 or 32.  
128 16-byte alignment, available only if <size> is 32.  
**omitted** Standard alignment, see [Unaligned data access on page A3-108](#).  
: is the preferred separator before the <align> value, but the alignment can be specified as @<align>, see [Advanced SIMD addressing mode on page A7-277](#).

! If present, specifies writeback.

<Rm> Contains an address offset applied after the access.

For more information about <Rn>, !, and <Rm> see [Advanced SIMD addressing mode on page A7-277](#).

**Table A8-7 Encoding of index, alignment, and register spacing**

	<size> == 8	<size> == 16	<size> == 32
Index	index_align[3:1] = x	index_align[3:2] = x	index_align[3] = x
Single-spacing	-	index_align[1] = 0	index_align[2] = 0
Double-spacing	-	index_align[1] = 1	index_align[2] = 1
<align> omitted	index_align[0] = 0	index_align[0] = 0	index_align[1:0] = '00'
<align> == 32	index_align[0] = 1	-	-
<align> == 64	-	index_align[0] = 1	index_align[1:0] = '01'
<align> == 128	-	-	index_align[1:0] = '10'

## Operation

```

if ConditionPassed() then
    EncodingSpecificOperations(); CheckAdvSIMDEnabled(); NullCheckIfThumbEE(n);
    address = R[n]; if (address MOD alignment) != 0 then GenerateAlignmentException();
    if wback then R[n] = R[n] + (if register_index then R[m] else 4*bytes);
    Elem[D[d],index,esize] = MemU[address,ebytes];
    Elem[D[d2],index,esize] = MemU[address+ebytes,ebytes];
    Elem[D[d3],index,esize] = MemU[address+2*ebytes,ebytes];
    Elem[D[d4],index,esize] = MemU[address+3*ebytes,ebytes];

```

## Exceptions

Undefined Instruction, Hyp Trap, Data Abort.

### A8.8.331 VLD4 (single 4-element structure to all lanes)

This instruction loads one 4-element structure from memory into all lanes of four registers. For details of the addressing mode see *Advanced SIMD addressing mode on page A7-277*.

Depending on settings in the CPACR, NSACR, and HCPTR registers, and the security state and mode in which the instruction is executed, an attempt to execute the instruction might be UNDEFINED, or trapped to Hyp mode. *Summary of access controls for Advanced SIMD functionality on page B1-1232* summarizes these controls.

ARM deprecates the conditional execution of any Advanced SIMD instruction encoding that is not also available as a VFP instruction encoding, see *Conditional execution on page A8-288*.

#### Encoding T1/A1 Advanced SIMD

VLD4<c>.<size> <list>, [<Rn>{ :<align>}]{!}

VLD4<c>.<size> <list>, [<Rn>{ :<align>}], <Rm>

15	14	13	12	11	10	9	8	7	6	5	4	3	2	1	0	15	14	13	12	11	10	9	8	7	6	5	4	3	2	1	0
1	1	1	1	1	0	0	1	1	D	1	0		Rn			Vd		1	1	1	1	size	T	a		Rm					

31	30	29	28	27	26	25	24	23	22	21	20	19	18	17	16	15	14	13	12	11	10	9	8	7	6	5	4	3	2	1	0
1	1	1	1	0	1	0	0	1	D	1	0		Rn			Vd		1	1	1	1	size	T	a		Rm					

```

if size == '11' && a == '0' then UNDEFINED;
if size == '11' then
    ebytes = 4; elements = 2; alignment = 16;
else
    ebytes = 1 << UInt(size); elements = 8 DIV ebytes;
    if size == '10' then
        alignment = if a == '0' then 1 else 8;
    else
        alignment = if a == '0' then 1 else 4*ebytes;
inc = if T == '0' then 1 else 2;
d = UInt(D:Vd); d2 = d + inc; d3 = d2 + inc; d4 = d3 + inc; n = UInt(Rn); m = UInt(Rm);
wback = (m != 15); register_index = (m != 15 && m != 13);
if n == 15 || d4 > 31 then UNPREDICTABLE;

```

## Assembler syntax

VLD4{<c>}{<q>}.<size> <list>, [<Rn>{ :<align>}]	Encoded as Rm = 0b1111
VLD4{<c>}{<q>}.<size> <list>, [<Rn>{ :<align>}]!	Encoded as Rm = 0b1101
VLD4{<c>}{<q>}.<size> <list>, [<Rn>{ :<align>}], <Rm>	Rm cannot be 0b11x1

where:

<c>, <q>	See <a href="#">Standard assembler syntax fields on page A8-287</a> . An ARM VLD4 instruction must be unconditional. ARM strongly recommends that a Thumb VLD4 instruction is unconditional, see <a href="#">Conditional execution on page A8-288</a> .
<size>	The data size. It must be one of: 8            encoded as size = 0b00. 16          encoded as size = 0b01. 32          encoded as size = 0b10, or 0b11 for 16-byte alignment.
<list>	The registers containing the structures. It must be one of: {<Dd[>], <Dd+1[>], <Dd+2[>], <Dd+3[>]} Single-spaced registers, encoded as D:Vd = <Dd>, T = 0 {<Dd[>], <Dd+2[>], <Dd+4[>], <Dd+6[>]} Double-spaced registers, encoded as D:Vd = <Dd>, T = 1.
<Rn>	The base address for the access.
<align>	The alignment. It can be one of: 32            4-byte alignment, available only if <size> is 8, encoded as a = 1. 64            8-byte alignment, available only if <size> is 16 or 32, encoded as a = 1. 128          16-byte alignment, available only if <size> is 32, encoded as a = 1, size = 0b11. <b>omitted</b> Standard alignment, see <a href="#">Unaligned data access on page A3-108</a> . Encoded as a = 0. : is the preferred separator before the <align> value, but the alignment can be specified as @<align>, see <a href="#">Advanced SIMD addressing mode on page A7-277</a> .
!	If present, specifies writeback.
<Rm>	Contains an address offset applied after the access.

For more information about <Rn>, !, and <Rm>, see [Advanced SIMD addressing mode on page A7-277](#).

## Operation

```
if ConditionPassed() then
    EncodingSpecificOperations(); CheckAdvSIMDEnabled(); NullCheckIfThumbEE(n);
    address = R[n]; if (address MOD alignment) != 0 then GenerateAlignmentException();
    if wback then R[n] = R[n] + (if register_index then R[m] else 4*ebytes);
    D[d] = Replicate(MemU[address,ebytes], elements);
    D[d2] = Replicate(MemU[address+ebytes,ebytes], elements);
    D[d3] = Replicate(MemU[address+2*ebytes,ebytes], elements);
    D[d4] = Replicate(MemU[address+3*ebytes,ebytes], elements);
```

## Exceptions

Undefined Instruction, Hyp Trap, Data Abort.

### A8.8.332 VLDM

Vector Load Multiple loads multiple extension registers from consecutive memory locations using an address from an ARM core register.

Depending on settings in the [CPACR](#), [NSACR](#), [HCPTR](#), and [FPEXC](#) registers, and the security state and mode in which the instruction is executed, an attempt to execute the instruction might be UNDEFINED, or trapped to Hyp mode. [Summary of general controls of CP10 and CP11 functionality on page B1-1230](#) summarizes these controls.

#### Encoding T1/A1 VFPv2, VFPv3, VFPv4, Advanced SIMD

VLDM{mode}<c> <Rn>{!}, <list> <list> is consecutive 64-bit registers

15	14	13	12	11	10	9	8	7	6	5	4	3	2	1	0	15	14	13	12	11	10	9	8	7	6	5	4	3	2	1	0
1	1	1	0	1	1	0	P	U	D	W	1	Rn				Vd				1	0	1	1	imm8							

31	30	29	28	27	26	25	24	23	22	21	20	19	18	17	16	15	14	13	12	11	10	9	8	7	6	5	4	3	2	1	0
cond				1	1	0	P	U	D	W	1	Rn				Vd				1	0	1	1	imm8							

```

if P == '0' && U == '0' && W == '0' then SEE "Related encodings";
if P == '0' && U == '1' && W == '1' && Rn == '1101' then SEE VPOP;
if P == '1' && W == '0' then SEE VLDR;
if P == U && W == '1' then UNDEFINED;
// Remaining combinations are PUW = 010 (IA without !), 011 (IA with !), 101 (DB with !)
single_regs = FALSE; add = (U == '1'); wback = (W == '1');
d = UInt(D:Vd); n = UInt(Rn); imm32 = ZeroExtend(imm8:'00', 32);
regs = UInt(imm8) DIV 2; // If UInt(imm8) is odd, see "FLDMX".
if n == 15 && (wback || CurrentInstrSet() != InstrSet_ARM) then UNPREDICTABLE;
if regs == 0 || regs > 16 || (d+regs) > 32 then UNPREDICTABLE;
if VFPSmallRegisterBank() && (d+regs) > 16 then UNPREDICTABLE;

```

#### Encoding T2/A2 VFPv2, VFPv3, VFPv4

VLDM{mode}<c> <Rn>{!}, <list> <list> is consecutive 32-bit registers

15	14	13	12	11	10	9	8	7	6	5	4	3	2	1	0	15	14	13	12	11	10	9	8	7	6	5	4	3	2	1	0
1	1	1	0	1	1	0	P	U	D	W	1	Rn				Vd				1	0	1	0	imm8							

31	30	29	28	27	26	25	24	23	22	21	20	19	18	17	16	15	14	13	12	11	10	9	8	7	6	5	4	3	2	1	0
cond				1	1	0	P	U	D	W	1	Rn				Vd				1	0	1	0	imm8							

```

if P == '0' && U == '0' && W == '0' then SEE "Related encodings";
if P == '0' && U == '1' && W == '1' && Rn == '1101' then SEE VPOP;
if P == '1' && W == '0' then SEE VLDR;
if P == U && W == '1' then UNDEFINED;
// Remaining combinations are PUW = 010 (IA without !), 011 (IA with !), 101 (DB with !)
single_regs = TRUE; add = (U == '1'); wback = (W == '1'); d = UInt(Vd:D); n = UInt(Rn);
imm32 = ZeroExtend(imm8:'00', 32); regs = UInt(imm8);
if n == 15 && (wback || CurrentInstrSet() != InstrSet_ARM) then UNPREDICTABLE;
if regs == 0 || (d+regs) > 32 then UNPREDICTABLE;

```

**Related encodings** See [64-bit transfers between ARM core and extension registers on page A7-279](#).

#### FLDMX

Encoding T1/A1 behaves as described by the pseudocode if imm8 is odd. However, there is no UAL syntax for such encodings and ARM deprecates their use. For more information, see [FLDMX, FSTMX on page A8-388](#).

## Assembler syntax

VLDM{<mode>}{<c>}{<q>}{.<size>} <Rn>{!}, <list>

where:

<mode>	The addressing mode:
IA	Increment After. The consecutive addresses start at the address specified in <Rn>. This is the default and can be omitted. Encoded as P = 0, U = 1.
DB	Decrement Before. The consecutive addresses end just before the address specified in <Rn>. Encoded as P = 1, U = 0.
<c>, <q>	See <i>Standard assembler syntax fields</i> on page A8-287.
<size>	An optional data size specifier. If present, it must be equal to the size in bits, 32 or 64, of the registers in <list>.
<Rn>	The base register. The SP can be used. In the ARM instruction set, if ! is not specified the PC can be used.
!	Causes the instruction to write a modified value back to <Rn>. This is required if <mode> == DB, and is optional if <mode> == IA. Encoded as W = 1. If ! is omitted, the instruction does not change <Rn> in this way. Encoded as W = 0.
<list>	The extension registers to be loaded, as a list of consecutively numbered doubleword (encoding T1/A1) or singleword (encoding T2/A2) registers, separated by commas and surrounded by brackets. It is encoded in the instruction by setting D and Vd to specify the first register in the list, and imm8 to twice the number of registers in the list (encoding T1/A1) or the number of registers in the list (encoding T2/A2). <list> must contain at least one register. If it contains doubleword registers it must not contain more than 16 registers.

## Operation

```
if ConditionPassed() then
    EncodingSpecificOperations(); CheckVFPEnabled(TRUE); NullCheckIfThumbEE(n);
    address = if add then R[n] else R[n]-imm32;
    if wback then R[n] = if add then R[n]+imm32 else R[n]-imm32;
    for r = 0 to regs-1
        if single_regs then
            S[d+r] = MemA[address,4]; address = address+4;
        else
            word1 = MemA[address,4]; word2 = MemA[address+4,4]; address = address+8;
            // Combine the word-aligned words in the correct order for current endianness.
            D[d+r] = if BigEndian() then word1:word2 else word2:word1;
```

## Exceptions

Undefined Instruction, Hyp Trap, Data Abort.

### A8.8.333 VLDR

This instruction loads a single extension register from memory, using an address from an ARM core register, with an optional offset.

Depending on settings in the CPACR, NSACR, HCPTR, and FPEXC registers, and the security state and mode in which the instruction is executed, an attempt to execute the instruction might be UNDEFINED, or trapped to Hyp mode. [Summary of general controls of CP10 and CP11 functionality on page B1-1230](#) and [Summary of access controls for Advanced SIMD functionality on page B1-1232](#) summarize these controls.

#### Encoding T1/A1 VFPv2, VFPv3, VFPv4, Advanced SIMD

VLDR<c> <Dd>, [<Rn>{, #+/-<imm>}]

VLDR<c> <Dd>, <label>

VLDR<c> <Dd>, [PC, #-0] Special case

15	14	13	12	11	10	9	8	7	6	5	4	3	2	1	0	15	14	13	12	11	10	9	8	7	6	5	4	3	2	1	0
1	1	1	0	1	1	0	1	U	D	0	1		Rn			Vd		1	0	1	1								imm8		

31	30	29	28	27	26	25	24	23	22	21	20	19	18	17	16	15	14	13	12	11	10	9	8	7	6	5	4	3	2	1	0
	cond		1	1	0	1	U	D	0	1		Rn				Vd		1	0	1	1										imm8

```
single_reg = FALSE; add = (U == '1'); imm32 = ZeroExtend(imm8:'00', 32);
d = UInt(D:Vd); n = UInt(Rn);
```

#### Encoding T2/A2 VFPv2, VFPv3, VFPv4

VLDR<c> <Sd>, [<Rn>{, #+/-<imm>}]

VLDR<c> <Sd>, <label>

VLDR<c> <Sd>, [PC, #-0] Special case

15	14	13	12	11	10	9	8	7	6	5	4	3	2	1	0	15	14	13	12	11	10	9	8	7	6	5	4	3	2	1	0
1	1	1	0	1	1	0	1	U	D	0	1		Rn			Vd		1	0	1	0									imm8	

31	30	29	28	27	26	25	24	23	22	21	20	19	18	17	16	15	14	13	12	11	10	9	8	7	6	5	4	3	2	1	0
	cond		1	1	0	1	U	D	0	1		Rn				Vd		1	0	1	0										imm8

```
single_reg = TRUE; add = (U == '1'); imm32 = ZeroExtend(imm8:'00', 32);
d = UInt(Vd:D); n = UInt(Rn);
```



## Assembler syntax

VLDR{<C>}{<q>}{.64} <Dd>, [<Rn> {, #+/-<imm>}]	Encoding T1/A1, immediate form
VLDR{<C>}{<q>}{.64} <Dd>, <label>	Encoding T1/A1, normal literal form
VLDR{<C>}{<q>}{.64} <Dd>, [PC, #+/-<imm>]	Encoding T1/A1, alternative literal form
VLDR{<C>}{<q>}{.32} <Sd>, [<Rn> {, #+/-<imm>}]	Encoding T2/A2, immediate form
VLDR{<C>}{<q>}{.32} <Sd>, <label>	Encoding T2/A2, normal literal form
VLDR{<C>}{<q>}{.32} <Sd>, [PC, #+/-<imm>]	Encoding T2/A2, alternative literal form

where:

<C>, <q>	See <a href="#">Standard assembler syntax fields on page A8-287</a> .
.32, .64	Optional data size specifiers.
<Dd>	The destination register for a doubleword load.
<Sd>	The destination register for a singleword load.
<Rn>	The base register. The SP can be used.
+/-	Is + or omitted if the immediate offset is to be added to the base register value (add == TRUE), or – if it is to be subtracted (add == FALSE). #0 and #-0 generate different instructions.
<imm>	The immediate offset used for forming the address. For the immediate forms of the syntax, <imm> can be omitted, in which case the #0 form of the instruction is assembled. Permitted values are multiples of 4 in the range 0 to 1020.
<label>	The label of the literal data item to be loaded. The assembler calculates the required value of the offset from the Align(PC, 4) value of the instruction to this label. Permitted values are multiples of 4 in the range -1020 to 1020.  If the offset is zero or positive, imm32 is equal to the offset and add == TRUE. If the offset is negative, imm32 is equal to minus the offset and add == FALSE.

For the literal forms of the instruction, the base register is encoded as 0b1111 to indicate that the PC is the base register.

The alternative syntax permits the addition or subtraction of the offset and the immediate offset to be specified separately, including permitting a subtraction of 0 that cannot be specified using the normal syntax. For more information, see [Use of labels in UAL instruction syntax on page A4-162](#).

## Operation

```

if ConditionPassed() then
    EncodingSpecificOperations(); CheckVFPEnabled(TRUE); NullCheckIfThumbEE(n);
    base = if n == 15 then Align(PC,4) else R[n];
    address = if add then (base + imm32) else (base - imm32);
    if single_reg then
        S[d] = MemA[address,4];
    else
        word1 = MemA[address,4]; word2 = MemA[address+4,4];
        // Combine the word-aligned words in the correct order for current endianness.
        D[d] = if BigEndian() then word1:word2 else word2:word1;

```

## Exceptions

Undefined Instruction, Hyp Trap, Data Abort.

### A8.8.334 VMAX, VMIN (integer)

Vector Maximum compares corresponding elements in two vectors, and copies the larger of each pair into the corresponding element in the destination vector.

Vector Minimum compares corresponding elements in two vectors, and copies the smaller of each pair into the corresponding element in the destination vector.

The operand vector elements can be any one of:

- 8-bit, 16-bit, or 32-bit signed integers
- 8-bit, 16-bit, or 32-bit unsigned integers.

The result vector elements are the same size as the operand vector elements.

Depending on settings in the CPACR, NSACR, and HCPTR registers, and the security state and mode in which the instruction is executed, an attempt to execute the instruction might be UNDEFINED, or trapped to Hyp mode.

[Summary of access controls for Advanced SIMD functionality on page B1-1232](#) summarizes these controls.

ARM deprecates the conditional execution of any Advanced SIMD instruction encoding that is not also available as a VFP instruction encoding, see [Conditional execution on page A8-288](#).

#### Encoding T1/A1 Advanced SIMD

V<op><c>.<dt> <Qd>, <Qn>, <Qm>

V<op><c>.<dt> <Dd>, <Dn>, <Dm>

15	14	13	12	11	10	9	8	7	6	5	4	3	2	1	0	15	14	13	12	11	10	9	8	7	6	5	4	3	2	1	0
1	1	1	U	1	1	1	1	0	D	size		Vn		Vd	0	1	1	0	N	Q	M	op		Vm							

31	30	29	28	27	26	25	24	23	22	21	20	19	18	17	16	15	14	13	12	11	10	9	8	7	6	5	4	3	2	1	0
1	1	1	1	0	0	1	U	0	D	size		Vn		Vd	0	1	1	0	N	Q	M	op		Vm							

```

if Q == '1' && (Vd<0> == '1' || Vn<0> == '1' || Vm<0> == '1') then UNDEFINED;
if size == '11' then UNDEFINED;
maximum = (op == '0'); unsigned = (U == '1');
esize = 8 << UInt(size); elements = 64 DIV esize;
d = UInt(D:Vd); n = UInt(N:Vn); m = UInt(M:Vm); regs = if Q == '0' then 1 else 2;

```

## Assembler syntax

V<op>{<c>}{<q>}.<dt> {<Qd>}, <Qn>, <Qm> Encoded as Q = 1  
V<op>{<c>}{<q>}.<dt> {<Dd>}, <Dn>, <Dm> Encoded as Q = 0

where:

<op> The operation. It must be one of:  
MAX encoded as op = 0.  
MIN encoded as op = 1.

<c>, <q> See [Standard assembler syntax fields on page A8-287](#). An ARM VMAX or VMIN instruction must be unconditional. ARM strongly recommends that a Thumb VMAX or VMIN instruction is unconditional, see [Conditional execution on page A8-288](#).

<dt> The data types for the elements of the vectors. It must be one of:  
S8 encoded as size = 0b00, U = 0.  
S16 encoded as size = 0b01, U = 0.  
S32 encoded as size = 0b10, U = 0.  
U8 encoded as size = 0b00, U = 1.  
U16 encoded as size = 0b01, U = 1.  
U32 encoded as size = 0b10, U = 1.

<Qd>, <Qn>, <Qm> The destination vector and the operand vectors, for a quadword operation.

<Dd>, <Dn>, <Dm> The destination vector and the operand vectors, for a doubleword operation.

## Operation

```
if ConditionPassed() then
    EncodingSpecificOperations(); CheckAdvSIMDEnabled();
    for r = 0 to regs-1
        for e = 0 to elements-1
            op1 = Int(Elem[D[n+r],e,esize], unsigned);
            op2 = Int(Elem[D[m+r],e,esize], unsigned);
            result = if maximum then Max(op1,op2) else Min(op1,op2);
            Elem[D[d+r],e,esize] = result<esize-1:0>;
```

## Exceptions

Undefined Instruction, Hyp Trap.

### A8.8.335 VMAX, VMIN (floating-point)

Vector Maximum compares corresponding elements in two vectors, and copies the larger of each pair into the corresponding element in the destination vector.

Vector Minimum compares corresponding elements in two vectors, and copies the smaller of each pair into the corresponding element in the destination vector.

The operand vector elements are 32-bit floating-point numbers.

Depending on settings in the CPACR, NSACR, and HCPTR registers, and the security state and mode in which the instruction is executed, an attempt to execute the instruction might be UNDEFINED, or trapped to Hyp mode. [Summary of access controls for Advanced SIMD functionality on page B1-1232](#) summarizes these controls.

ARM deprecates the conditional execution of any Advanced SIMD instruction encoding that is not also available as a VFP instruction encoding, see [Conditional execution on page A8-288](#).

#### Encoding T1/A1 Advanced SIMD (UNDEFINED in integer-only variant)

V<op><c>.F32 <Qd>, <Qn>, <Qm>

V<op><c>.F32 <Dd>, <Dn>, <Dm>

15	14	13	12	11	10	9	8	7	6	5	4	3	2	1	0	15	14	13	12	11	10	9	8	7	6	5	4	3	2	1	0
1	1	1	0	1	1	1	1	0	D	op	sz	Vn				Vd	1	1	1	1	N	Q	M	0	Vm						
31	30	29	28	27	26	25	24	23	22	21	20	19	18	17	16	15	14	13	12	11	10	9	8	7	6	5	4	3	2	1	0
1	1	1	1	0	0	1	0	0	D	op	sz	Vn				Vd	1	1	1	1	N	Q	M	0	Vm						

```

if Q == '1' && (Vd<0> == '1' || Vn<0> == '1' || Vm<0> == '1') then UNDEFINED;
if sz == '1' then UNDEFINED;
maximum = (op == '0'); esize = 32; elements = 2;
d = UInt(D:Vd); n = UInt(N:Vn); m = UInt(M:Vm); regs = if Q == '0' then 1 else 2;

```

## Assembler syntax

V<op>{<c>}{<q>}.F32 {<Qd>}, <Qn>, <Qm> Encoded as Q = 1  
V<op>{<c>}{<q>}.F32 {<Dd>}, <Dn>, <Dm> Encoded as Q = 0

where:

<op> The operation. It must be one of:  
MAX Encoded as op = 0.  
MIN Encoded as op = 1.

<c>, <q> See [Standard assembler syntax fields on page A8-287](#). An ARM VMAX or VMIN instruction must be unconditional. ARM strongly recommends that a Thumb VMAX or VMIN instruction is unconditional, see [Conditional execution on page A8-288](#).

<Qd>, <Qn>, <Qm> The destination vector and the operand vectors, for a quadword operation.

<Dd>, <Dn>, <Dm> The destination vector and the operand vectors, for a doubleword operation.

## Operation

```
if ConditionPassed() then
    EncodingSpecificOperations(); CheckAdvSIMDEnabled();
    for r = 0 to regs-1
        for e = 0 to elements-1
            op1 = Elem[D[n+r],e,esize]; op2 = Elem[D[m+r],e,esize];
            Elem[D[d+r],e,esize] = if maximum then FPMax(op1,op2,FALSE) else FPMin(op1,op2,FALSE);
```

## Exceptions

Undefined Instruction, Hyp Trap.

### ***Floating-point exceptions***

Invalid Operation, Input Denormal.

### **Floating-point maximum and minimum**

- $\max(+0.0, -0.0) = +0.0$
- $\min(+0.0, -0.0) = -0.0$
- If any input is a NaN, the corresponding result element is the default NaN.

### A8.8.336 VMLA, VMLAL, VMLS, VMLSL (integer)

Vector Multiply Accumulate and Vector Multiply Subtract multiply corresponding elements in two vectors, and either add the products to, or subtract them from, the corresponding elements of the destination vector. Vector Multiply Accumulate Long and Vector Multiply Subtract Long do the same thing, but with destination vector elements that are twice as long as the elements that are multiplied.

Depending on settings in the CPACR, NSACR, and HCPTR registers, and the security state and mode in which the instruction is executed, an attempt to execute the instruction might be UNDEFINED, or trapped to Hyp mode. [Summary of access controls for Advanced SIMD functionality on page B1-1232](#) summarizes these controls.

ARM deprecates the conditional execution of any Advanced SIMD instruction encoding that is not also available as a VFP instruction encoding, see [Conditional execution on page A8-288](#).

#### Encoding T1/A1 Advanced SIMD

V<op><c>.<dt> <Qd>, <Qn>, <Qm>

V<op><c>.<dt> <Dd>, <Dn>, <Dm>

15	14	13	12	11	10	9	8	7	6	5	4	3	2	1	0	15	14	13	12	11	10	9	8	7	6	5	4	3	2	1	0
1	1	1	op	1	1	1	1	0	D	size	Vn	Vd	1	0	0	1	N	Q	M	0	Vm										

31	30	29	28	27	26	25	24	23	22	21	20	19	18	17	16	15	14	13	12	11	10	9	8	7	6	5	4	3	2	1	0
1	1	1	1	0	0	1	op	0	D	size	Vn	Vd	1	0	0	1	N	Q	M	0	Vm										

```

if size == '11' then UNDEFINED;
if Q == '1' && (Vd<0> == '1' || Vn<0> == '1' || Vm<0> == '1') then UNDEFINED;
add = (op == '0'); long_destination = FALSE;
unsigned = FALSE; // "Don't care" value: TRUE produces same functionality
esize = 8 << UInt(size); elements = 64 DIV esize;
d = UInt(D:Vd); n = UInt(N:Vn); m = UInt(M:Vm); regs = if Q == '0' then 1 else 2;

```

#### Encoding T2/A2 Advanced SIMD

V<op>L<c>.<dt> <Qd>, <Dn>, <Dm>

15	14	13	12	11	10	9	8	7	6	5	4	3	2	1	0	15	14	13	12	11	10	9	8	7	6	5	4	3	2	1	0
1	1	1	U	1	1	1	1	1	D	size	Vn	Vd	1	0	op	0	N	0	M	0	Vm										

31	30	29	28	27	26	25	24	23	22	21	20	19	18	17	16	15	14	13	12	11	10	9	8	7	6	5	4	3	2	1	0
1	1	1	1	0	0	1	U	1	D	size	Vn	Vd	1	0	op	0	N	0	M	0	Vm										

```

if size == '11' then SEE "Related encodings";
if Vd<0> == '1' then UNDEFINED;
add = (op == '0'); long_destination = TRUE; unsigned = (U == '1');
esize = 8 << UInt(size); elements = 64 DIV esize;
d = UInt(D:Vd); n = UInt(N:Vn); m = UInt(M:Vm); regs = 1;

```

**Related encodings** See [Advanced SIMD data-processing instructions on page A7-261](#).

## Assembler syntax

V<op>{<c>}{<q>}.<type><size> <Qd>, <Qn>, <Qm> Encoding T1/A1, encoded as Q = 1  
V<op>{<c>}{<q>}.<type><size> <Dd>, <Dn>, <Dm> Encoding T1/A1, encoded as Q = 0  
V<op>L{<c>}{<q>}.<type><size> <Qd>, <Dn>, <Dm> Encoding T2/A2

where:

<op> The operation. It must be one of:  
MLA Vector Multiply Accumulate. Encoded as op = 0.  
MLS Vector Multiply Subtract. Encoded as op = 1.

<c>, <q> See [Standard assembler syntax fields on page A8-287](#). An ARM Advanced SIMD VMLA, VMLAL, VMLS, or VMLS L instruction must be unconditional. ARM strongly recommends that a Thumb Advanced SIMD VMLA, VMLAL, VMLS, or VMLS L instruction is unconditional, see [Conditional execution on page A8-288](#).

<type> The data type for the elements of the operands. It must be one of:  
S Optional in encoding T1/A1. Encoded as U = 0 in encoding T2/A2.  
U Optional in encoding T1/A1. Encoded as U = 1 in encoding T2/A2.  
I Available only in encoding T1/A1.

<size> The data size for the elements of the operands. It must be one of:  
8 Encoded as size = 0b00.  
16 Encoded as size = 0b01.  
32 Encoded as size = 0b10.

<Qd>, <Qn>, <Qm> The destination vector and the operand vectors, for a quadword operation.

<Dd>, <Dn>, <Dm> The destination vector and the operand vectors, for a doubleword operation.

<Qd>, <Dn>, <Dm> The destination vector and the operand vectors, for a long operation.

## Operation

```
if ConditionPassed() then
    EncodingSpecificOperations(); CheckAdvSIMDEnabled();
    for r = 0 to regs-1
        for e = 0 to elements-1
            product = Int(Elem[Din[n+r],e,esize],unsigned) * Int(Elem[Din[m+r],e,esize],unsigned);
            addend = if add then product else -product;
            if long_destination then
                Elem[Q[d>>1],e,2*esize] = Elem[Qin[d>>1],e,2*esize] + addend;
            else
                Elem[D[d+r],e,esize] = Elem[Din[d+r],e,esize] + addend;
```

## Exceptions

Undefined Instruction, Hyp Trap.

### A8.8.337 VMLA, VMLS (floating-point)

Vector Multiply Accumulate multiplies corresponding elements in two vectors, and accumulates the results into the elements of the destination vector.

Vector Multiply Subtract multiplies corresponding elements in two vectors, subtracts the products from corresponding elements of the destination vector, and places the results in the destination vector.

———— **Note** ————

ARM recommends that software does not use the VMLS instruction in the *Round towards Plus Infinity* and *Round towards Minus Infinity* rounding modes, because the rounding of the product and of the sum can change the result of the instruction in opposite directions, defeating the purpose of these rounding modes.

Depending on settings in the CPACR, NSACR, HCPTR, and FPEXC registers, and the security state and mode in which the instruction is executed, an attempt to execute the instruction might be UNDEFINED, or trapped to Hyp mode. [Summary of general controls of CP10 and CP11 functionality on page B1-1230](#) and [Summary of access controls for Advanced SIMD functionality on page B1-1232](#) summarize these controls.

ARM deprecates the conditional execution of any Advanced SIMD instruction encoding that is not also available as a VFP instruction encoding, see [Conditional execution on page A8-288](#).

**Encoding T1/A1** Advanced SIMD (UNDEFINED in integer-only variant)

V<op><c>.F32 <Qd>, <Qn>, <Qm>

V<op><c>.F32 <Dd>, <Dn>, <Dm>

15	14	13	12	11	10	9	8	7	6	5	4	3	2	1	0	15	14	13	12	11	10	9	8	7	6	5	4	3	2	1	0
1	1	1	0	1	1	1	1	0	D	op	sz		Vn		Vd	1	1	0	1	N	Q	M	1		Vm						

31	30	29	28	27	26	25	24	23	22	21	20	19	18	17	16	15	14	13	12	11	10	9	8	7	6	5	4	3	2	1	0
1	1	1	1	0	0	1	0	0	D	op	sz		Vn		Vd	1	1	0	1	N	Q	M	1		Vm						

```
if Q == '1' && (Vd<0> == '1' || Vn<0> == '1' || Vm<0> == '1') then UNDEFINED;
if sz == '1' then UNDEFINED;
advsimd = TRUE; add = (op == '0'); esize = 32; elements = 2;
d = UInt(D:Vd); n = UInt(N:Vn); m = UInt(M:Vm); regs = if Q == '0' then 1 else 2;
```

**Encoding T2/A2** VFPv2, VFPv3, VFPv4 (sz = 1 UNDEFINED in single-precision only variants)

V<op><c>.F64 <Dd>, <Dn>, <Dm>

V<op><c>.F32 <Sd>, <Sn>, <Sm>

15	14	13	12	11	10	9	8	7	6	5	4	3	2	1	0	15	14	13	12	11	10	9	8	7	6	5	4	3	2	1	0
1	1	1	0	1	1	1	0	0	D	0	0		Vn		Vd	1	0	1	sz	N	op	M	0		Vm						

31	30	29	28	27	26	25	24	23	22	21	20	19	18	17	16	15	14	13	12	11	10	9	8	7	6	5	4	3	2	1	0
cond				1	1	1	0	0	D	0	0		Vn		Vd	1	0	1	sz	N	op	M	0		Vm						

```
if FPSCR.Len != '000' || FPSCR.Stride != '00' then SEE "VFP vectors";
advsimd = FALSE; dp_operation = (sz == '1'); add = (op == '0');
d = if dp_operation then UInt(D:Vd) else UInt(Vd:D);
n = if dp_operation then UInt(N:Vn) else UInt(Vn:N);
m = if dp_operation then UInt(M:Vm) else UInt(Vm:M);
```

**VFP vectors** Encoding T2/A2 can operate on VFP vectors under control of the FPSCR. {Len, Stride} fields. For details see [Appendix K VFP Vector Operation Support](#).



## Assembler syntax

V<op>{<c>}{<q>}.F32	<Qd>, <Qn>, <Qm>	Encoding T1/A1, encoded as Q = 1, sz = 0
V<op>{<c>}{<q>}.F32	<Dd>, <Dn>, <Dm>	Encoding T1/A1, encoded as Q = 0, sz = 0
V<op>{<c>}{<q>}.F64	<Dd>, <Dn>, <Dm>	Encoding T2/A2, encoded as sz = 1
V<op>{<c>}{<q>}.F32	<Sd>, <Sn>, <Sm>	Encoding T2/A2, encoded as sz = 0

where:

<op>	The operation. It must be one of: MLA        Vector Multiply Accumulate. Encoded as op = 0. MLS        Vector Multiply Subtract. Encoded as op = 1.
<c>, <q>	See <a href="#">Standard assembler syntax fields on page A8-287</a> . An ARM Advanced SIMD VMLA or VMLS instruction must be unconditional. ARM strongly recommends that a Thumb Advanced SIMD VMLA or VMLS instruction is unconditional, see <a href="#">Conditional execution on page A8-288</a> .
<Qd>, <Qn>, <Qm>	The destination vector and the operand vectors, for a quadword operation.
<Dd>, <Dn>, <Dm>	The destination vector and the operand vectors, for a doubleword operation.
<Sd>, <Sn>, <Sm>	The destination vector and the operand vectors, for a singleword operation.

## Operation

```

if ConditionPassed() then
    EncodingSpecificOperations(); CheckAdvSIMDOrVFPEEnabled(TRUE, advsimd);
    if advsimd then // Advanced SIMD instruction
        for r = 0 to regs-1
            for e = 0 to elements-1
                product = FPMul(Elem[D[n+r],e,esize], Elem[D[m+r],e,esize], FALSE);
                addend = if add then product else FPNeg(product);
                Elem[D[d+r],e,esize] = FPAdd(Elem[D[d+r],e,esize], addend, FALSE);
    else // VFP instruction
        if dp_operation then
            addend = if add then FPMul(D[n], D[m], TRUE) else FPNeg(FPMul(D[n], D[m], TRUE));
            D[d] = FPAdd(D[d], addend, TRUE);
        else
            addend = if add then FPMul(S[n], S[m], TRUE) else FPNeg(FPMul(S[n], S[m], TRUE));
            S[d] = FPAdd(S[d], addend, TRUE);

```

## Exceptions

Undefined Instruction, Hyp Trap.

### Floating-point exceptions

Input Denormal, Invalid Operation, Overflow, Underflow, Inexact.

### A8.8.338 VMLA, VMLAL, VMLS, VMLSL (by scalar)

Vector Multiply Accumulate and Vector Multiply Subtract multiply elements of a vector by a scalar, and either add the products to, or subtract them from, corresponding elements of the destination vector. Vector Multiply Accumulate Long and Vector Multiply Subtract Long do the same thing, but with destination vector elements that are twice as long as the elements that are multiplied.

For more information about scalars see [Advanced SIMD scalars on page A7-260](#).

Depending on settings in the CPACR, NSACR, and HCPTR registers, and the security state and mode in which the instruction is executed, an attempt to execute the instruction might be UNDEFINED, or trapped to Hyp mode. [Summary of access controls for Advanced SIMD functionality on page B1-1232](#) summarizes these controls.

ARM deprecates the conditional execution of any Advanced SIMD instruction encoding that is not also available as a VFP instruction encoding, see [Conditional execution on page A8-288](#).

#### Encoding T1/A1 Advanced SIMD (F = 1 UNDEFINED in integer-only variants)

V<op><c>.<dt> <Qd>, <Qn>, <Dm[x]>

V<op><c>.<dt> <Dd>, <Dn>, <Dm[x]>

15	14	13	12	11	10	9	8	7	6	5	4	3	2	1	0	15	14	13	12	11	10	9	8	7	6	5	4	3	2	1	0
1	1	1	Q	1	1	1	1	1	D	size	Vn	Vd	0	op	0	F	N	1	M	0	Vm										
31	30	29	28	27	26	25	24	23	22	21	20	19	18	17	16	15	14	13	12	11	10	9	8	7	6	5	4	3	2	1	0
1	1	1	1	0	0	1	Q	1	D	size	Vn	Vd	0	op	0	F	N	1	M	0	Vm										

```

if size == '11' then SEE "Related encodings";
if size == '00' || (F == '1' && size == '01') then UNDEFINED;
if Q == '1' && (Vd<0> == '1' || Vn<0> == '1') then UNDEFINED;
unsigned = FALSE; // "Don't care" value: TRUE produces same functionality
add = (op == '0'); floating_point = (F == '1'); long_destination = FALSE;
d = UInt(D:Vd); n = UInt(N:Vn); regs = if Q == '0' then 1 else 2;
if size == '01' then esize = 16; elements = 4; m = UInt(Vm<2:0>); index = UInt(M:Vm<3>);
if size == '10' then esize = 32; elements = 2; m = UInt(Vm); index = UInt(M);

```

#### Encoding T2/A2 Advanced SIMD

V<op>L<c>.<dt> <Qd>, <Dn>, <Dm[x]>

15	14	13	12	11	10	9	8	7	6	5	4	3	2	1	0	15	14	13	12	11	10	9	8	7	6	5	4	3	2	1	0
1	1	1	U	1	1	1	1	1	D	size	Vn	Vd	0	op	1	0	N	1	M	0	Vm										
31	30	29	28	27	26	25	24	23	22	21	20	19	18	17	16	15	14	13	12	11	10	9	8	7	6	5	4	3	2	1	0
1	1	1	1	0	0	1	U	1	D	size	Vn	Vd	0	op	1	0	N	1	M	0	Vm										

```

if size == '11' then SEE "Related encodings";
if size == '00' || Vd<0> == '1' then UNDEFINED;
unsigned = (U == '1'); add = (op == '0'); floating_point = FALSE; long_destination = TRUE;
d = UInt(D:Vd); n = UInt(N:Vn); regs = 1;
if size == '01' then esize = 16; elements = 4; m = UInt(Vm<2:0>); index = UInt(M:Vm<3>);
if size == '10' then esize = 32; elements = 2; m = UInt(Vm); index = UInt(M);

```

**Related encodings** See [Advanced SIMD data-processing instructions on page A7-261](#).

## Assembler syntax

V<op>{<c>}{<q>}.<type><size> <Qd>, <Qn>, <Dm[x]> Encoding T1/A1, encoded as Q = 1  
V<op>{<c>}{<q>}.<type><size> <Dd>, <Dn>, <Dm[x]> Encoding T1/A1, encoded as Q = 0  
V<op>L{<c>}{<q>}.<type><size> <Qd>, <Dn>, <Dm[x]> Encoding T2/A2

where:

<op> The operation. It must be one of:  
MLA Vector Multiply Accumulate. Encoded as op = 0.  
MLS Vector Multiply Subtract. Encoded as op = 1.

<c>, <q> See [Standard assembler syntax fields on page A8-287](#). An ARM Advanced SIMD VMLA, VMLAL, VMLS, or VMLS instruction must be unconditional. ARM strongly recommends that a Thumb Advanced SIMD VMLA, VMLAL, VMLS, or VMLS instruction is unconditional, see [Conditional execution on page A8-288](#).

<type> The data type for the elements of the operands. It must be one of:  
S Encoding T2/A2, encoded as U = 0.  
U Encoding T2/A2, encoded as U = 1.  
I Encoding T1/A1, encoded as F = 0.  
F Encoding T1/A1, encoded as F = 1. <size> must be 32.

<size> The operand element data size. It can be:  
16 Encoded as size = 01.  
32 Encoded as size = 10.

<Qd>, <Qn> The accumulate vector, and the operand vector, for a quadword operation.  
<Dd>, <Dn> The accumulate vector, and the operand vector, for a doubleword operation.  
<Qd>, <Dn> The accumulate vector, and the operand vector, for a long operation.  
<Dm[x]> The scalar. Dm is restricted to D0-D7 if <size> is 16, or D0-D15 otherwise.

## Operation

```
if ConditionPassed() then
    EncodingSpecificOperations(); CheckAdvSIMDEnabled();
    op2 = Elem[Din[m],index,esize]; op2val = Int(op2, unsigned);
    for r = 0 to regs-1
        for e = 0 to elements-1
            op1 = Elem[Din[n+r],e,esize]; op1val = Int(op1, unsigned);
            if floating_point then
                fp_addend = if add then FPMul(op1,op2,FALSE) else FPNeg(FPMul(op1,op2,FALSE));
                Elem[D[d+r],e,esize] = FPAdd(Elem[Din[d+r],e,esize], fp_addend, FALSE);
            else
                addend = if add then op1val*op2val else -op1val*op2val;
                if long_destination then
                    Elem[Q[d>>1],e,2*esize] = Elem[Qin[d>>1],e,2*esize] + addend;
                else
                    Elem[D[d+r],e,esize] = Elem[Din[d+r],e,esize] + addend;
```

## Exceptions

Undefined Instruction, Hyp Trap.

### Floating-point exceptions

Input Denormal, Invalid Operation, Overflow, Underflow, Inexact.

### A8.8.339 VMOV (immediate)

This instruction places an immediate constant into every element of the destination register.

Depending on settings in the CPACR, NSACR, HCPTR, and FPEXC registers, and the security state and mode in which the instruction is executed, an attempt to execute the instruction might be UNDEFINED, or trapped to Hyp mode. *Summary of general controls of CP10 and CP11 functionality* on page B1-1230 and *Summary of access controls for Advanced SIMD functionality* on page B1-1232 summarize these controls.

ARM deprecates the conditional execution of any Advanced SIMD instruction encoding that is not also available as a VFP instruction encoding, see *Conditional execution* on page A8-288.

#### Encoding T1/A1 Advanced SIMD

VMOV<c>.<dt> <Qd>, #<imm>

VMOV<c>.<dt> <Dd>, #<imm>

15	14	13	12	11	10	9	8	7	6	5	4	3	2	1	0	15	14	13	12	11	10	9	8	7	6	5	4	3	2	1	0
1	1	1	i	1	1	1	1	1	D	0	0	0	imm3			Vd	cmode			0	Q	op	1	imm4							

31	30	29	28	27	26	25	24	23	22	21	20	19	18	17	16	15	14	13	12	11	10	9	8	7	6	5	4	3	2	1	0
1	1	1	1	0	0	1	i	1	D	0	0	0	imm3			Vd	cmode			0	Q	op	1	imm4							

```

if op == '0' && cmode<0> == '1' && cmode<3:2> != '11' then SEE VORR (immediate);
if op == '1' && cmode != '1110' then SEE "Related encodings";
if Q == '1' && Vd<0> == '1' then UNDEFINED;
single_register = FALSE; advsimd = TRUE; imm64 = AdvSIMDExpandImm(op, cmode, i:imm3:imm4);
d = UInt(D:Vd); regs = if Q == '0' then 1 else 2;

```

#### Encoding T2/A2 VFPv3, VFPv4 (sz = 1 UNDEFINED in single-precision only variants)

VMOV<c>.F64 <Dd>, #<imm>

VMOV<c>.F32 <Sd>, #<imm>

15	14	13	12	11	10	9	8	7	6	5	4	3	2	1	0	15	14	13	12	11	10	9	8	7	6	5	4	3	2	1	0
1	1	1	0	1	1	1	0	1	D	1	1	imm4H			Vd	1	0	1	sz	(0)	0	(0)	0	imm4L							

31	30	29	28	27	26	25	24	23	22	21	20	19	18	17	16	15	14	13	12	11	10	9	8	7	6	5	4	3	2	1	0
cond			1	1	1	0	1	D	1	1	imm4H			Vd	1	0	1	sz	(0)	0	(0)	0	imm4L								

```

if FPSCR.Len != '000' || FPSCR.Stride != '00' then SEE "VFP vectors";
single_register = (sz == '0'); advsimd = FALSE;
if single_register then
    d = UInt(Vd:D); imm32 = VFPEExpandImm(imm4H:imm4L, 32);
else
    d = UInt(D:Vd); imm64 = VFPEExpandImm(imm4H:imm4L, 64); regs = 1;

```

**Related encodings** See *One register and a modified immediate value* on page A7-269.

**VFP vectors** Encoding T2/A2 can operate on VFP vectors under control of the FPSCR.{Len, Stride} fields. For details see *Appendix K VFP Vector Operation Support*.

## Assembler syntax

VMOV{<c>}{<q>}.<dt> <Qd>, #<imm>	Encoding T1/A1, encoded as Q = 1
VMOV{<c>}{<q>}.<dt> <Dd>, #<imm>	Encoding T1/A1, encoded as Q = 0
VMOV{<c>}{<q>}.F64 <Dd>, #<imm>	Encoding T2/A2, encoded as sz = 1
VMOV{<c>}{<q>}.F32 <Sd>, #<imm>	Encoding T2/A2, encoded as sz = 0

where:

<c>, <q>	See <a href="#">Standard assembler syntax fields on page A8-287</a> . An ARM Advanced SIMD VMOV (immediate) instruction must be unconditional. ARM strongly recommends that a Thumb Advanced SIMD VMOV (immediate) instruction is unconditional, see <a href="#">Conditional execution on page A8-288</a> .
<dt>	The data type. It must be one of I8, I16, I32, I64, or F32.
<Qd>	The destination register for a quadword operation.
<Dd>	The destination register for a doubleword operation.
<Sd>	The destination register for a singleword operation.
<imm>	A constant of the type specified by <dt>. This constant is replicated enough times to fill the destination register. For example, VMOV.I32 D0, #10 writes 0x0000000A0000000A to D0.

For the range of constants available, and the encoding of <dt> and <imm>, see:

- [One register and a modified immediate value on page A7-269](#) for encoding T1/A1
- [Floating-point data-processing instructions on page A7-272](#) for encoding T2/A2.

## Operation

```

if ConditionPassed() then
    EncodingSpecificOperations(); CheckAdvSIMDorVFPEEnabled(TRUE, advsimd);
    if single_register then
        S[d] = imm32;
    else
        for r = 0 to regs-1
            D[d+r] = imm64;

```

## Exceptions

Undefined Instruction, Hyp Trap.

## Pseudo-instructions

[One register and a modified immediate value on page A7-269](#) describes pseudo-instructions with a combination of <dt> and <imm> that is not supported by hardware, but that generates the same destination register value as a different combination that is supported by hardware.

### A8.8.340 VMOV (register)

This instruction copies the contents of one register to another.

Depending on settings in the CPACR, NSACR, HCPTR, and FPEXC registers, and the security state and mode in which the instruction is executed, an attempt to execute the instruction might be UNDEFINED, or trapped to Hyp mode. *Summary of general controls of CP10 and CP11 functionality* on page B1-1230 and *Summary of access controls for Advanced SIMD functionality* on page B1-1232 summarize these controls.

ARM deprecates the conditional execution of any Advanced SIMD instruction encoding that is not also available as a VFP instruction encoding, see *Conditional execution* on page A8-288.

#### Encoding T1/A1 Advanced SIMD

VMOV<c> <Qd>, <Qm>

VMOV<c> <Dd>, <Dm>

15	14	13	12	11	10	9	8	7	6	5	4	3	2	1	0	15	14	13	12	11	10	9	8	7	6	5	4	3	2	1	0
1	1	1	0	1	1	1	1	0	D	1	0			Vm		Vd		0	0	0	1	M	Q	M	1		Vm				

31	30	29	28	27	26	25	24	23	22	21	20	19	18	17	16	15	14	13	12	11	10	9	8	7	6	5	4	3	2	1	0
1	1	1	1	0	0	1	0	0	D	1	0			Vm		Vd		0	0	0	1	M	Q	M	1		Vm				

```
if !Consistent(M) || !Consistent(Vm) then SEE VORR (register);
if Q == '1' && (Vd<0> == '1' || Vm<0> == '1') then UNDEFINED;
single_register = FALSE; advsimd = TRUE;
d = UInt(D:Vd); m = UInt(M:Vm); regs = if Q == '0' then 1 else 2;
```

#### Encoding T2/A2 VFPv2, VFPv3, VFPv4 (sz = 1 UNDEFINED in single-precision only variants)

VMOV<c>.F64 <Dd>, <Dm>

VMOV<c>.F32 <Sd>, <Sm>

15	14	13	12	11	10	9	8	7	6	5	4	3	2	1	0	15	14	13	12	11	10	9	8	7	6	5	4	3	2	1	0
1	1	1	0	1	1	1	0	1	D	1	1	0	0	0	0		Vd		1	0	1	sz	0	1	M	0		Vm			

31	30	29	28	27	26	25	24	23	22	21	20	19	18	17	16	15	14	13	12	11	10	9	8	7	6	5	4	3	2	1	0
cond		1	1	1	0	1	D	1	1	0	0	0	0		Vd		1	0	1	sz	0	1	M	0		Vm					

```
if FPSCR.Len != '000' || FPSCR.Stride != '00' then SEE "VFP vectors";
single_register = (sz == '0'); advsimd = FALSE;
if single_register then
    d = UInt(Vd:D); m = UInt(Vm:M);
else
    d = UInt(D:Vd); m = UInt(M:Vm); regs = 1;
```

**VFP vectors** Encoding T2/A2 can operate on VFP vectors under control of the FPSCR.{Len, Stride} fields. For details see [Appendix K VFP Vector Operation Support](#).

## Assembler syntax

VMOV{<c>}{<q>}{.<dt>} <Qd>, <Qm>	Encoding T1/A1, encoded as Q = 1
VMOV{<c>}{<q>}{.<dt>} <Dd>, <Dm>	Encoding T1/A1, encoded as Q = 0
VMOV{<c>}{<q>}.F64 <Dd>, <Dm>	Encoding T2/A2, encoded as sz = 1
VMOV{<c>}{<q>}.F32 <Sd>, <Sm>	Encoding T2/A2, encoded as sz = 0

where:

<c>, <q>	See <a href="#">Standard assembler syntax fields on page A8-287</a> . An ARM Advanced SIMD VMOV (register) instruction must be unconditional. ARM strongly recommends that a Thumb Advanced SIMD VMOV (register) instruction is unconditional, see <a href="#">Conditional execution on page A8-288</a> .
<dt>	An optional data type. <dt> must not be F64, but it is otherwise ignored.
<Qd>, <Qm>	The destination register and the source register, for a quadword operation.
<Dd>, <Dm>	The destination register and the source register, for a doubleword operation.
<Sd>, <Sm>	The destination register and the source register, for a singleword operation.

## Operation

```

if ConditionPassed() then
    EncodingSpecificOperations(); CheckAdvSIMDorVFPEEnabled(TRUE, advsimd);
    if single_register then
        S[d] = S[m];
    else
        for r = 0 to regs-1
            D[d+r] = D[m+r];

```

## Exceptions

Undefined Instruction, Hyp Trap.

### A8.8.341 VMOV (ARM core register to scalar)

This instruction copies a byte, halfword, or word from an ARM core register into an Advanced SIMD scalar.

On a Floating-point-only system, this instruction transfers one word to the upper or lower half of a double-precision floating-point register from an ARM core register. This is an identical operation to the Advanced SIMD single word transfer.

For more information about scalars see [Advanced SIMD scalars on page A7-260](#).

Depending on settings in the CPACR, NSACR, HCPTR, and FPEXC registers, and the security state and mode in which the instruction is executed, an attempt to execute the instruction might be UNDEFINED, or trapped to Hyp mode. [Summary of general controls of CP10 and CP11 functionality on page B1-1230](#) and [Summary of access controls for Advanced SIMD functionality on page B1-1232](#) summarize these controls.

**Encoding T1/A1** Word version (opc1:opc2 == '0x00'): VFPv2, VFPv3, VFPv4, Advanced SIMD  
Advanced SIMD otherwise

VMOV<c>.<size> <Dd[x]>, <Rt>

15	14	13	12	11	10	9	8	7	6	5	4	3	2	1	0	15	14	13	12	11	10	9	8	7	6	5	4	3	2	1	0
1	1	1	0	1	1	1	0	0	opc1	0		Vd				Rt		1	0	1	1	D	opc2	1	(0)	(0)	(0)	(0)			

31	30	29	28	27	26	25	24	23	22	21	20	19	18	17	16	15	14	13	12	11	10	9	8	7	6	5	4	3	2	1	0
cond			1	1	1	0	0	opc1	0		Vd					Rt		1	0	1	1	D	opc2	1	(0)	(0)	(0)	(0)			

```

case opc1:opc2 of
  when "1xxx" advsimd = TRUE; esize = 8; index = UInt(opc1<0>:opc2);
  when "0xx1" advsimd = TRUE; esize = 16; index = UInt(opc1<0>:opc2<1>);
  when "0x00" advsimd = FALSE; esize = 32; index = UInt(opc1<0>);
  when "0x10" UNDEFINED;
d = UInt(D:Vd); t = UInt(Rt);
if t == 15 || (CurrentInstrSet() != InstrSet_ARM && t == 13) then UNPREDICTABLE;

```



## Assembler syntax

VMOV{<c>}{<q>}{.<size>} <Dd[x]>, <Rt>

where:

<c>, <q>	See <i>Standard assembler syntax fields</i> on page A8-287.
<size>	The data size. It must be one of: 8 Encoded as opc1<1> = 1. [x] is encoded in opc1<0>, opc2. 16 Encoded as opc1<1> = 0, opc2<0> = 1. [x] is encoded in opc1<0>, opc2<1>. 32 Encoded as opc1<1> = 0, opc2 = 0b00. [x] is encoded in opc1<0>. <b>omitted</b> Equivalent to 32.
<Dd[x]>	The scalar. The register <Dd> is encoded in D:Vd. For details of how [x] is encoded, see the description of <size>.
<Rt>	The source ARM core register.

## Operation

```
if ConditionPassed() then
    EncodingSpecificOperations(); CheckAdvSIMDOrVFPEEnabled(TRUE, advsimd);
    Elem[D[d],index,esize] = R[t]<esize-1:0>;
```

## Exceptions

Undefined Instruction, Hyp Trap.

### A8.8.342 VMOV (scalar to ARM core register)

This instruction copies a byte, halfword, or word from an Advanced SIMD scalar to an ARM core register. Bytes and halfwords can be either zero-extended or sign-extended.

On a Floating-point-only system, this instruction transfers one word from the upper or lower half of a double-precision floating-point register to an ARM core register. This is an identical operation to the Advanced SIMD single word transfer.

For more information about scalars see [Advanced SIMD scalars on page A7-260](#).

Depending on settings in the CPACR, NSACR, HCPTR, and FPEXC registers, and the security state and mode in which the instruction is executed, an attempt to execute the instruction might be UNDEFINED, or trapped to Hyp mode. [Summary of general controls of CP10 and CP11 functionality on page B1-1230](#) and [Summary of access controls for Advanced SIMD functionality on page B1-1232](#) summarize these controls.

**Encoding T1/A1** Word version (U:opc1:opc2 == '00x00'): VFPv2, VFPv3, VFPv4, Advanced SIMD  
Advanced SIMD otherwise

VMOV<c>.<dt> <Rt>, <Dn[x]>

15	14	13	12	11	10	9	8	7	6	5	4	3	2	1	0	15	14	13	12	11	10	9	8	7	6	5	4	3	2	1	0
1	1	1	0	1	1	1	0	U	opc1	1		Vn		Rt		1	0	1	1	N	opc2	1	(0)	(0)	(0)	(0)					
31	30	29	28	27	26	25	24	23	22	21	20	19	18	17	16	15	14	13	12	11	10	9	8	7	6	5	4	3	2	1	0
	cond		1	1	1	0	U	opc1	1		Vn		Rt		1	0	1	1	N	opc2	1	(0)	(0)	(0)	(0)						

```

case U:opc1:opc2 of
  when "x1xxx" advsimd = TRUE; esize = 8; index = UInt(opc1<0>:opc2);
  when "x0xx1" advsimd = TRUE; esize = 16; index = UInt(opc1<0>:opc2<1>);
  when "00x00" advsimd = FALSE; esize = 32; index = UInt(opc1<0>);
  when "10x00" UNDEFINED;
  when "x0x10" UNDEFINED;
t = UInt(Rt); n = UInt(N:Vn); unsigned = (U == '1');
if t == 15 || (CurrentInstrSet() != InstrSet_ARM && t == 13) then UNPREDICTABLE;

```

## Assembler syntax

VMOV{<c>}{<q>}{.<dt>} <Rt>, <Dn[x]>

where:

<c>, <q> See *Standard assembler syntax fields* on page A8-287.

<dt> The data type. It must be one of:

S8 Encoded as U = 0, opc1<1> = 1. [x] is encoded in opc1<0>, opc2.

S16 Encoded as U = 0, opc1<1> = 0, opc2<0> = 1. [x] is encoded in opc1<0>, opc2<1>.

U8 Encoded as U = 1, opc1<1> = 1. [x] is encoded in opc1<0>, opc2.

U16 Encoded as U = 1, opc1<1> = 0, opc2<0> = 1. [x] is encoded in opc1<0>, opc2<1>.

32 Encoded as U = 0, opc1<1> = 0, opc2 = 0b00. [x] is encoded in opc1<0>.

**omitted** Equivalent to 32.

<Dn[x]> The scalar. For details of how [x] is encoded see the description of <dt>.

<Rt> The destination ARM core register.

## Operation

```
if ConditionPassed() then
    EncodingSpecificOperations(); CheckAdvSIMDorVFPEEnabled(TRUE, advsimd);
    if unsigned then
        R[t] = ZeroExtend(Elem[D[n],index,esize], 32);
    else
        R[t] = SignExtend(Elem[D[n],index,esize], 32);
```

## Exceptions

Undefined Instruction, Hyp Trap.

### A8.8.343 VMOV (between ARM core register and single-precision register)

This instruction transfers the contents of a single-precision Floating-point register to an ARM core register, or the contents of an ARM core register to a single-precision Floating-point register.

Depending on settings in the CPACR, NSACR, HCPTR, and FPEXC registers, and the security state and mode in which the instruction is executed, an attempt to execute the instruction might be UNDEFINED, or trapped to Hyp mode. *Summary of general controls of CP10 and CP11 functionality on page B1-1230* summarizes these controls.

#### Encoding T1/A1 VFPv2, VFPv3, VFPv4

VMOV<c> <Sn>, <Rt>

VMOV<c> <Rt>, <Sn>

15	14	13	12	11	10	9	8	7	6	5	4	3	2	1	0	15	14	13	12	11	10	9	8	7	6	5	4	3	2	1	0
1	1	1	0	1	1	1	0	0	0	0	op	Vn				Rt				1	0	1	0	N	(0)	(0)	1	(0)	(0)	(0)	(0)
31	30	29	28	27	26	25	24	23	22	21	20	19	18	17	16	15	14	13	12	11	10	9	8	7	6	5	4	3	2	1	0
cond				1	1	1	0	0	0	0	op	Vn				Rt				1	0	1	0	N	(0)	(0)	1	(0)	(0)	(0)	(0)

```
to_arm_register = (op == '1'); t = UInt(Rt); n = UInt(Vn:N);
if t == 15 || (CurrentInstrSet() != InstrSet_ARM && t == 13) then UNPREDICTABLE;
```

## Assembler syntax

VMOV{<c>}{<q>} <Sn>, <Rt>

Encoded as op = 0

VMOV{<c>}{<q>} <Rt>, <Sn>

Encoded as op = 1

where:

<c>, <q> See *Standard assembler syntax fields* on page A8-287.

<Sn> The single-precision VFP register.

<Rt> The ARM core register.

## Operation

```
if ConditionPassed() then
    EncodingSpecificOperations(); CheckVFPEEnabled(TRUE);
    if to_arm_register then
        R[t] = S[n];
    else
        S[n] = R[t];
```

## Exceptions

Undefined Instruction, Hyp Trap.

### A8.8.344 VMOV (between two ARM core registers and two single-precision registers)

This instruction transfers the contents of two consecutively numbered single-precision Floating-point registers to two ARM core registers, or the contents of two ARM core registers to a pair of single-precision Floating-point registers. The ARM core registers do not have to be contiguous.

Depending on settings in the CPACR, NSACR, HCPTR, and FPEXC registers, and the security state and mode in which the instruction is executed, an attempt to execute the instruction might be UNDEFINED, or trapped to Hyp mode. *Summary of general controls of CP10 and CP11 functionality on page B1-1230* summarizes these controls.

#### Encoding T1/A1 VFPv2, VFPv3, VFPv4

VMOV<c> <Sm>, <Sm1>, <Rt>, <Rt2>

VMOV<c> <Rt>, <Rt2>, <Sm>, <Sm1>

15	14	13	12	11	10	9	8	7	6	5	4	3	2	1	0	15	14	13	12	11	10	9	8	7	6	5	4	3	2	1	0
1	1	1	0	1	1	0	0	0	1	0	op	Rt2				Rt				1	0	1	0	0	0	M	1	Vm			

31	30	29	28	27	26	25	24	23	22	21	20	19	18	17	16	15	14	13	12	11	10	9	8	7	6	5	4	3	2	1	0
cond				1	1	0	0	0	1	0	op	Rt2				Rt				1	0	1	0	0	0	M	1	Vm			

```
to_arm_registers = (op == '1'); t = UInt(Rt); t2 = UInt(Rt2); m = UInt(Vm:M);
if t == 15 || t2 == 15 || m == 31 then UNPREDICTABLE;
if CurrentInstrSet() != InstrSet_ARM && (t == 13 || t2 == 13) then UNPREDICTABLE;
if to_arm_registers && t == t2 then UNPREDICTABLE;
```

## Assembler syntax

VMOV{<c>}{<q>} <Sm>, <Sm1>, <Rt>, <Rt2> Encoded as op = 0  
VMOV{<c>}{<q>} <Rt>, <Rt2>, <Sm>, <Sm1> Encoded as op = 1

where:

- <c>, <q> See *Standard assembler syntax fields* on page A8-287.
- <Sm> The first single-precision Floating-point register.
- <Sm1> The second single-precision Floating-point register. This is the next single-precision Floating-point register after <Sm>.
- <Rt> The ARM core register that <Sm> is transferred to or from.
- <Rt2> The ARM core register that <Sm1> is transferred to or from.

## Operation

```
if ConditionPassed() then
    EncodingSpecificOperations(); CheckVFPEnabled(TRUE);
    if to_arm_registers then
        R[t] = S[m];
        R[t2] = S[m+1];
    else
        S[m] = R[t];
        S[m+1] = R[t2];
```

## Exceptions

Undefined Instruction, Hyp Trap.

### A8.8.345 VMOV (between two ARM core registers and a doubleword extension register)

This instruction copies two words from two ARM core registers into a doubleword extension register, or from a doubleword extension register to two ARM core registers.

Depending on settings in the CPACR, NSACR, HCPTR, and FPEXC registers, and the security state and mode in which the instruction is executed, an attempt to execute the instruction might be UNDEFINED, or trapped to Hyp mode. [Summary of general controls of CP10 and CP11 functionality on page B1-1230](#) and [Summary of access controls for Advanced SIMD functionality on page B1-1232](#) summarize these controls.

#### Encoding T1/A1 VFPv2, VFPv3, VFPv4, Advanced SIMD

VMOV<c> <Dm>, <Rt>, <Rt2>

VMOV<c> <Rt>, <Rt2>, <Dm>

15	14	13	12	11	10	9	8	7	6	5	4	3	2	1	0	15	14	13	12	11	10	9	8	7	6	5	4	3	2	1	0
1	1	1	0	1	1	0	0	0	1	0	op	Rt2				Rt				1	0	1	1	0	0	M	1	Vm			

31	30	29	28	27	26	25	24	23	22	21	20	19	18	17	16	15	14	13	12	11	10	9	8	7	6	5	4	3	2	1	0
cond				1	1	0	0	0	1	0	op	Rt2				Rt				1	0	1	1	0	0	M	1	Vm			

```
to_arm_registers = (op == '1'); t = UInt(Rt); t2 = UInt(Rt2); m = UInt(M:Vm);
if t == 15 || t2 == 15 then UNPREDICTABLE;
if CurrentInstrSet() != InstrSet_ARM && (t == 13 || t2 == 13) then UNPREDICTABLE;
if to_arm_registers && t == t2 then UNPREDICTABLE;
```



## Assembler syntax

VMOV{<c>}{<q>} <Dm>, <Rt>, <Rt2>

Encoded as op = 0

VMOV{<c>}{<q>} <Rt>, <Rt2>, <Dm>

Encoded as op = 1

where:

<c>, <q> See *Standard assembler syntax fields* on page A8-287.

<Dm> The doubleword extension register.

<Rt>, <Rt2> The two ARM core registers.

## Operation

```
if ConditionPassed() then
    EncodingSpecificOperations(); CheckVFPEnabled(TRUE);
    if to_arm_registers then
        R[t] = D[m]<31:0>;
        R[t2] = D[m]<63:32>;
    else
        D[m]<31:0> = R[t];
        D[m]<63:32> = R[t2];
```

## Exceptions

Undefined Instruction, Hyp Trap.

### A8.8.346 VMOVL

Vector Move Long takes each element in a doubleword vector, sign or zero-extends them to twice their original length, and places the results in a quadword vector.

Depending on settings in the CPACR, NSACR, and HCPTR registers, and the security state and mode in which the instruction is executed, an attempt to execute the instruction might be UNDEFINED, or trapped to Hyp mode. [Summary of access controls for Advanced SIMD functionality on page B1-1232](#) summarizes these controls.

ARM deprecates the conditional execution of any Advanced SIMD instruction encoding that is not also available as a VFP instruction encoding, see [Conditional execution on page A8-288](#).

#### Encoding T1/A1 Advanced SIMD

VMOVL<c>.<dt> <Qd>, <Dm>

15	14	13	12	11	10	9	8	7	6	5	4	3	2	1	0	15	14	13	12	11	10	9	8	7	6	5	4	3	2	1	0
1	1	1	U	1	1	1	1	1	D	imm3	0	0	0			Vd															

31	30	29	28	27	26	25	24	23	22	21	20	19	18	17	16	15	14	13	12	11	10	9	8	7	6	5	4	3	2	1	0
1	1	1	1	0	0	1	U	1	D	imm3	0	0	0			Vd															

```

if imm3 == '000' then SEE "Related encodings";
if imm3 != '001' && imm3 != '010' && imm3 != '100' then SEE VSHLL;
if Vd<0> == '1' then UNDEFINED;
esize = 8 * UInt(imm3);
unsigned = (U == '1'); elements = 64 DIV esize;
d = UInt(D:Vd); m = UInt(M:Vm);

```

**Related encodings** See [One register and a modified immediate value on page A7-269](#).

## Assembler syntax

`VMOVL{<c>}{<q>}.dt <Qd>, <Dm>`

where:

<c>, <q> See [Standard assembler syntax fields on page A8-287](#). An ARM VMOVL instruction must be unconditional. ARM strongly recommends that a Thumb VMOVL instruction is unconditional, see [Conditional execution on page A8-288](#).

<dt> The data type for the elements of the operand. It must be one of:

S8	Encoded as U = 0, imm3 = 0b001.
S16	Encoded as U = 0, imm3 = 0b010.
S32	Encoded as U = 0, imm3 = 0b100.
U8	Encoded as U = 1, imm3 = 0b001.
U16	Encoded as U = 1, imm3 = 0b010.
U32	Encoded as U = 1, imm3 = 0b100.

<Qd>, <Dm> The destination vector and the operand vector.

## Operation

```
if ConditionPassed() then
    EncodingSpecificOperations(); CheckAdvSIMDEnabled();
    for e = 0 to elements-1
        result = Int(Elem[Din[m],e,esize], unsigned);
        Elem[Q[d>>1],e,2*esize] = result<2*esize-1:0>;
```

## Exceptions

Undefined Instruction, Hyp Trap.

### A8.8.347 VMOVN

Vector Move and Narrow copies the least significant half of each element of a quadword vector into the corresponding elements of a doubleword vector.

The operand vector elements can be any one of 16-bit, 32-bit, or 64-bit integers. There is no distinction between signed and unsigned integers.

Depending on settings in the CPACR, NSACR, and HCPTR registers, and the security state and mode in which the instruction is executed, an attempt to execute the instruction might be UNDEFINED, or trapped to Hyp mode. [Summary of access controls for Advanced SIMD functionality on page B1-1232](#) summarizes these controls.

ARM deprecates the conditional execution of any Advanced SIMD instruction encoding that is not also available as a VFP instruction encoding, see [Conditional execution on page A8-288](#).

#### Encoding T1/A1 Advanced SIMD

VMOVN<c>.<dt> <Dd>, <Qm>

15	14	13	12	11	10	9	8	7	6	5	4	3	2	1	0	15	14	13	12	11	10	9	8	7	6	5	4	3	2	1	0
1	1	1	1	1	1	1	1	D	1	1	size	1	0			Vd	0	0	1	0	0	0	M	0		Vm					

31	30	29	28	27	26	25	24	23	22	21	20	19	18	17	16	15	14	13	12	11	10	9	8	7	6	5	4	3	2	1	0
1	1	1	1	0	0	1	1	1	D	1	1	size	1	0			Vd	0	0	1	0	0	0	M	0		Vm				

```

if size == '11' then UNDEFINED;
if Vm<0> == '1' then UNDEFINED;
esize = 8 << UInt(size); elements = 64 DIV esize;
d = UInt(D:Vd); m = UInt(M:Vm);

```

## Assembler syntax

VMOVN{<c>}{<q>}.<dt> <Dd>, <Qm>

where:

<c>, <q> See [Standard assembler syntax fields on page A8-287](#). An ARM VMOVN instruction must be unconditional. ARM strongly recommends that a Thumb VMOVN instruction is unconditional, see [Conditional execution on page A8-288](#).

<dt> The data type for the elements of the operand. It must be one of:  
I16 Encoded as size = 0b00.  
I32 Encoded as size = 0b01.  
I64 Encoded as size = 0b10.

<Dd>, <Qm> The destination vector and the operand vector.

## Operation

```
if ConditionPassed() then
    EncodingSpecificOperations(); CheckAdvSIMDEnabled();
    for e = 0 to elements-1
        Elem[D[d],e,esize] = Elem[Qin[m>>1],e,2*esize]<size-1:0>;
```

## Exceptions

Undefined Instruction, Hyp Trap.

### A8.8.348 VMRS

Move to ARM core register from Advanced SIMD and Floating-point Extension System Register moves the value of the FPSCR to an ARM core register.

For details of system level use of this instruction, see *VMS* on page B9-2012.

Depending on settings in the CPACR, NSACR, HCPTR, and FPEXC registers, and the security state and mode in which the instruction is executed, an attempt to execute the instruction might be UNDEFINED, or trapped to Hyp mode. *Summary of general controls of CP10 and CP11 functionality* on page B1-1230 and *Summary of access controls for Advanced SIMD functionality* on page B1-1232 summarize these controls.

#### Encoding T1/A1 VFPv2, VFPv3, VFPv4, Advanced SIMD

VMRS<c> <Rt>, FPSCR

15	14	13	12	11	10	9	8	7	6	5	4	3	2	1	0	15	14	13	12	11	10	9	8	7	6	5	4	3	2	1	0
1	1	1	0	1	1	1	0	1	1	1	1	0	0	0	1	Rt	1	0	1	0	(0)	(0)	(0)	1	(0)	(0)	(0)	(0)			
31	30	29	28	27	26	25	24	23	22	21	20	19	18	17	16	15	14	13	12	11	10	9	8	7	6	5	4	3	2	1	0
cond	1	1	1	0	1	1	1	1	0	0	0	1	Rt	1	0	1	0	(0)	(0)	(0)	1	(0)	(0)	(0)	(0)						

```
t = UInt(Rt);
if t == 13 && CurrentInstrSet() != InstrSet_ARM then UNPREDICTABLE;
```

## Assembler syntax

VMRS{<c>}{<q>} <Rt>, FPSCR

where:

<c>, <q> See *Standard assembler syntax fields* on page A8-287.

<Rt> The destination ARM core register. This register can be R0-R14 or APSR\_nzcv. APSR\_nzcv is encoded as Rt = 0b1111, and the instruction transfers the FPSCR.{N, Z, C, V} condition flags to the APSR.{N, Z, C, V} condition flags.

The pre-UAL instruction FMSTAT is equivalent to VMRS APSR\_nzcv, FPSCR.

## Operation

```
if ConditionPassed() then
    EncodingSpecificOperations(); CheckVFPEEnabled(TRUE);
    SerializeVFP(); VFPExcBarrier();
    if t != 15 then
        R[t] = FPSCR;
    else
        APSR.N = FPSCR.N;
        APSR.Z = FPSCR.Z;
        APSR.C = FPSCR.C;
        APSR.V = FPSCR.V;
```

## Exceptions

Undefined Instruction, Hyp Trap.

### A8.8.349 VMSR

Move to Advanced SIMD and Floating-point Extension System Register from ARM core register moves the value of an ARM core register to the **FPSCR**.

For details of system level use of this instruction, see *VMSR* on page B9-2014.

Depending on settings in the **CPACR**, **NSACR**, **HCPTR**, and **FPEXC** registers, and the security state and mode in which the instruction is executed, an attempt to execute the instruction might be UNDEFINED, or trapped to Hyp mode. *Summary of general controls of CP10 and CP11 functionality* on page B1-1230 and *Summary of access controls for Advanced SIMD functionality* on page B1-1232 summarize these controls.

#### Encoding T1/A1 VFPv2, VFPv3, VFPv4, Advanced SIMD

VMSR<c> FPSCR, <Rt>

15	14	13	12	11	10	9	8	7	6	5	4	3	2	1	0	15	14	13	12	11	10	9	8	7	6	5	4	3	2	1	0
1	1	1	0	1	1	1	0	1	1	1	0	0	0	0	1	Rt	1	0	1	0	(0)	(0)	(0)	1	(0)	(0)	(0)	(0)			
31	30	29	28	27	26	25	24	23	22	21	20	19	18	17	16	15	14	13	12	11	10	9	8	7	6	5	4	3	2	1	0
cond	1	1	1	0	1	1	1	0	0	0	0	1	Rt	1	0	1	0	(0)	(0)	(0)	1	(0)	(0)	(0)	(0)						

```
t = UInt(Rt);
if t == 15 || (t == 13 && CurrentInstrSet() != InstrSet_ARM) then UNPREDICTABLE;
```



## Assembler syntax

VMSR{<c>}{<q>} FPSCR, <Rt>

where:

<c>, <q> See *Standard assembler syntax fields* on page A8-287.

<Rt> The ARM core register to be transferred to the FPSCR.

## Operation

```
if ConditionPassed() then
    EncodingSpecificOperations(); CheckVFPEEnabled(TRUE);
    SerializeVFP(); VFPExcBarrier();
    FPSCR = R[t];
```

## Exceptions

Undefined Instruction, Hyp Trap.

### A8.8.350 VMUL, VMULL (integer and polynomial)

Vector Multiply multiplies corresponding elements in two vectors. Vector Multiply Long does the same thing, but with destination vector elements that are twice as long as the elements that are multiplied.

For information about multiplying polynomials see [Polynomial arithmetic over {0, 1}](#) on page A2-93.

Depending on settings in the CPACR, NSACR, and HCPTR registers, and the security state and mode in which the instruction is executed, an attempt to execute the instruction might be UNDEFINED, or trapped to Hyp mode. [Summary of access controls for Advanced SIMD functionality](#) on page B1-1232 summarizes these controls.

ARM deprecates the conditional execution of any Advanced SIMD instruction encoding that is not also available as a VFP instruction encoding, see [Conditional execution](#) on page A8-288.

#### Encoding T1/A1 Advanced SIMD

VMUL<c>.<dt> <Qd>, <Qn>, <Qm>

VMUL<c>.<dt> <Dd>, <Dn>, <Dm>

15	14	13	12	11	10	9	8	7	6	5	4	3	2	1	0	15	14	13	12	11	10	9	8	7	6	5	4	3	2	1	0
1	1	1	op	1	1	1	1	0	D	size	Vn	Vd	1	0	0	1	N	Q	M	1	Vm										

31	30	29	28	27	26	25	24	23	22	21	20	19	18	17	16	15	14	13	12	11	10	9	8	7	6	5	4	3	2	1	0
1	1	1	1	0	0	1	op	0	D	size	Vn	Vd	1	0	0	1	N	Q	M	1	Vm										

```

if size == '11' || (op == '1' && size != '00') then UNDEFINED;
if Q == '1' && (Vd<0> == '1' || Vn<0> == '1' || Vm<0> == '1') then UNDEFINED;
polynomial = (op == '1'); long_destination = FALSE;
unsigned = FALSE; // "Don't care" value: TRUE produces same functionality
esize = 8 << UInt(size); elements = 64 DIV esize;
d = UInt(D:Vd); n = UInt(N:Vn); m = UInt(M:Vm); regs = if Q == '0' then 1 else 2;

```

#### Encoding T2/A2 Advanced SIMD

VMULL<c>.<dt> <Qd>, <Dn>, <Dm>

15	14	13	12	11	10	9	8	7	6	5	4	3	2	1	0	15	14	13	12	11	10	9	8	7	6	5	4	3	2	1	0
1	1	1	U	1	1	1	1	1	D	size	Vn	Vd	1	1	op	0	N	0	M	0	Vm										

31	30	29	28	27	26	25	24	23	22	21	20	19	18	17	16	15	14	13	12	11	10	9	8	7	6	5	4	3	2	1	0
1	1	1	1	0	0	1	U	1	D	size	Vn	Vd	1	1	op	0	N	0	M	0	Vm										

```

if size == '11' then SEE "Related encodings";
if op == '1' && (U != '0' || size != '00') then UNDEFINED;
if Vd<0> == '1' then UNDEFINED;
polynomial = (op == '1'); long_destination = TRUE; unsigned = (U == '1');
esize = 8 << UInt(size); elements = 64 DIV esize;
d = UInt(D:Vd); n = UInt(N:Vn); m = UInt(M:Vm); regs = 1;

```

**Related encodings** See [Advanced SIMD data-processing instructions](#) on page A7-261.

## Assembler syntax

VMUL{<c>}{<q>}.<type><size> {<Qd>}, <Qn>, <Qm>	Encoding T1/A1, encoded as Q = 1
VMUL{<c>}{<q>}.<type><size> {<Dd>}, <Dn>, <Dm>	Encoding T1/A1, encoded as Q = 0
VMULL{<c>}{<q>}.<type><size> <Qd>, <Dn>, <Dm>	Encoding T2/A2

where:

<c>, <q>	See <i>Standard assembler syntax fields on page A8-287</i> . An ARM Advanced SIMD VMUL or VMULL instruction must be unconditional. ARM strongly recommends that a Thumb Advanced SIMD VMUL or VMULL instruction is unconditional, see <i>Conditional execution on page A8-288</i> .
<type>	The data type for the elements of the operands. It must be one of: S Encoded as op = 0 in both encodings, with U = 0 in encoding T2/A2. U Encoded as op = 0 in both encodings, with U = 1 in encoding T2/A2. I Encoding T1/A1 only, encoded as op = 0. P Encoded as op = 1 in both encodings, with U = 0 in encoding T2/A2. When <type> is P, <size> must be 8.
<size>	The data size for the elements of the operands. It must be one of: 8 Encoded as size = 0b00. 16 Encoded as size = 0b01. 32 Encoded as size = 0b10.
<Qd>, <Qn>, <Qm>	The destination vector and the operand vectors, for a quadword operation.
<Dd>, <Dn>, <Dm>	The destination vector and the operand vectors, for a doubleword operation.
<Qd>, <Dn>, <Dm>	The destination vector and the operand vectors, for a long operation.

## Operation

```

if ConditionPassed() then
    EncodingSpecificOperations(); CheckAdvSIMDEnabled();
    for r = 0 to regs-1
        for e = 0 to elements-1
            op1 = Elem[Din[n+r],e,esize]; op1val = Int(op1, unsigned);
            op2 = Elem[Din[m+r],e,esize]; op2val = Int(op2, unsigned);
            if polynomial then
                product = PolynomialMult(op1,op2);
            else
                product = (op1val*op2val)<2*esize-1:0>;
            if long_destination then
                Elem[Q[d>>1],e,2*esize] = product;
            else
                Elem[D[d+r],e,esize] = product<esize-1:0>;

```

## Exceptions

Undefined Instruction, Hyp Trap.

### A8.8.351 VMUL (floating-point)

Vector Multiply multiplies corresponding elements in two vectors, and places the results in the destination vector.

Depending on settings in the CPACR, NSACR, HCPTR, and FPEXC registers, and the security state and mode in which the instruction is executed, an attempt to execute the instruction might be UNDEFINED, or trapped to Hyp mode. *Summary of general controls of CP10 and CP11 functionality* on page B1-1230 and *Summary of access controls for Advanced SIMD functionality* on page B1-1232 summarize these controls.

ARM deprecates the conditional execution of any Advanced SIMD instruction encoding that is not also available as a VFP instruction encoding, see *Conditional execution* on page A8-288.

#### Encoding T1/A1 Advanced SIMD (UNDEFINED in integer-only variant)

VMUL<c>.F32 <Qd>, <Qn>, <Qm>

VMUL<c>.F32 <Dd>, <Dn>, <Dm>

15	14	13	12	11	10	9	8	7	6	5	4	3	2	1	0	15	14	13	12	11	10	9	8	7	6	5	4	3	2	1	0
1	1	1	1	1	1	1	1	0	D	0	sz		Vn			Vd		1	1	0	1	N	Q	M	1		Vm				

31	30	29	28	27	26	25	24	23	22	21	20	19	18	17	16	15	14	13	12	11	10	9	8	7	6	5	4	3	2	1	0
1	1	1	1	0	0	1	1	0	D	0	sz		Vn			Vd		1	1	0	1	N	Q	M	1		Vm				

```
if Q == '1' && (Vd<0> == '1' || Vn<0> == '1' || Vm<0> == '1') then UNDEFINED;
if sz == '1' then UNDEFINED;
advsimd = TRUE; esize = 32; elements = 2;
d = UInt(D:Vd); n = UInt(N:Vn); m = UInt(M:Vm); regs = if Q == '0' then 1 else 2;
```

#### Encoding T2/A2 VFPv2, VFPv3, VFPv4 (sz = 1 UNDEFINED in single-precision only variants)

VMUL<c>.F64 <Dd>, <Dn>, <Dm>

VMUL<c>.F32 <Sd>, <Sn>, <Sm>

15	14	13	12	11	10	9	8	7	6	5	4	3	2	1	0	15	14	13	12	11	10	9	8	7	6	5	4	3	2	1	0
1	1	1	0	1	1	1	0	0	D	1	0		Vn			Vd		1	0	1	sz	N	0	M	0		Vm				

31	30	29	28	27	26	25	24	23	22	21	20	19	18	17	16	15	14	13	12	11	10	9	8	7	6	5	4	3	2	1	0
cond		1	1	1	0	0	D	1	0		Vn			Vd		1	0	1	sz	N	0	M	0		Vm						

```
if FPSCR.Len != '000' || FPSCR.Stride != '00' then SEE "VFP vectors";
advsimd = FALSE; dp_operation = (sz == '1');
d = if dp_operation then UInt(D:Vd) else UInt(Vd:D);
n = if dp_operation then UInt(N:Vn) else UInt(Vn:N);
m = if dp_operation then UInt(M:Vm) else UInt(Vm:M);
```

**VFP vectors** Encoding T2/A2 can operate on VFP vectors under control of the FPSCR. {Len, Stride} fields. For details see [Appendix K VFP Vector Operation Support](#).

## Assembler syntax

VMUL{<c>}{<q>}.F32 {<Qd>}, <Qn>, <Qm>	Encoding T1/A1, encoded as Q = 1, sz = 0
VMUL{<c>}{<q>}.F32 {<Dd>}, <Dn>, <Dm>	Encoding T1/A1, encoded as Q = 0, sz = 0
VMUL{<c>}{<q>}.F64 {<Dd>}, <Dn>, <Dm>	Encoding T2/A2, encoded as sz = 1
VMUL{<c>}{<q>}.F32 {<Sd>}, <Sn>, <Sm>	Encoding T2/A2, encoded as sz = 0

where:

<c>, <q>	See <a href="#">Standard assembler syntax fields on page A8-287</a> . An ARM Advanced SIMD VMUL instruction must be unconditional. ARM strongly recommends that a Thumb Advanced SIMD VMUL instruction is unconditional, see <a href="#">Conditional execution on page A8-288</a> .
<Qd>, <Qn>, <Qm>	The destination vector and the operand vectors, for a quadword operation.
<Dd>, <Dn>, <Dm>	The destination vector and the operand vectors, for a doubleword operation.
<Sd>, <Sn>, <Sm>	The destination vector and the operand vectors, for a singleword operation.

## Operation

```

if ConditionPassed() then
    EncodingSpecificOperations(); CheckAdvSIMDorVFPEEnabled(TRUE, advsimd);
    if advsimd then // Advanced SIMD instruction
        for r = 0 to regs-1
            for e = 0 to elements-1
                Elem[D[d+r],e,esize] = FPMul(Elem[D[n+r],e,esize], Elem[D[m+r],e,esize], FALSE);
    else // VFP instruction
        if dp_operation then
            D[d] = FPMul(D[n], D[m], TRUE);
        else
            S[d] = FPMul(S[n], S[m], TRUE);

```

## Exceptions

Undefined Instruction, Hyp Trap.

### ***Floating-point exceptions***

Input Denormal, Invalid Operation, Overflow, Underflow, Inexact.

### A8.8.352 VMUL, VMULL (by scalar)

Vector Multiply multiplies each element in a vector by a scalar, and places the results in a second vector. Vector Multiply Long does the same thing, but with destination vector elements that are twice as long as the elements that are multiplied.

For more information about scalars see [Advanced SIMD scalars on page A7-260](#).

Depending on settings in the CPACR, NSACR, and HCPTR registers, and the security state and mode in which the instruction is executed, an attempt to execute the instruction might be UNDEFINED, or trapped to Hyp mode. [Summary of access controls for Advanced SIMD functionality on page B1-1232](#) summarizes these controls.

ARM deprecates the conditional execution of any Advanced SIMD instruction encoding that is not also available as a VFP instruction encoding, see [Conditional execution on page A8-288](#).

#### Encoding T1/A1 Advanced SIMD (F = 1 UNDEFINED in integer-only variants)

VMUL<c>.<dt> <Qd>, <Qn>, <Dm[x]>

VMUL<c>.<dt> <Dd>, <Dn>, <Dm[x]>

15	14	13	12	11	10	9	8	7	6	5	4	3	2	1	0	15	14	13	12	11	10	9	8	7	6	5	4	3	2	1	0
1	1	1	Q	1	1	1	1	1	D	size	Vn	Vd	1	0	0	F	N	1	M	0	Vm										

31	30	29	28	27	26	25	24	23	22	21	20	19	18	17	16	15	14	13	12	11	10	9	8	7	6	5	4	3	2	1	0
1	1	1	1	0	0	1	Q	1	D	size	Vn	Vd	1	0	0	F	N	1	M	0	Vm										

```

if size == '11' then SEE "Related encodings";
if size == '00' || (F == '1' && size == '01') then UNDEFINED;
if Q == '1' && (Vd<0> == '1' || Vn<0> == '1') then UNDEFINED;
unsigned = FALSE; // "Don't care" value: TRUE produces same functionality
floating_point = (F == '1'); long_destination = FALSE;
d = UInt(D:Vd); n = UInt(N:Vn); regs = if Q == '0' then 1 else 2;
if size == '01' then esize = 16; elements = 4; m = UInt(Vm<2:0>); index = UInt(M:Vm<3>);
if size == '10' then esize = 32; elements = 2; m = UInt(Vm); index = UInt(M);

```

#### Encoding T2/A2 Advanced SIMD

VMULL<c>.<dt> <Qd>, <Dn>, <Dm[x]>

15	14	13	12	11	10	9	8	7	6	5	4	3	2	1	0	15	14	13	12	11	10	9	8	7	6	5	4	3	2	1	0
1	1	1	U	1	1	1	1	1	D	size	Vn	Vd	1	0	1	0	N	1	M	0	Vm										

31	30	29	28	27	26	25	24	23	22	21	20	19	18	17	16	15	14	13	12	11	10	9	8	7	6	5	4	3	2	1	0
1	1	1	1	0	0	1	U	1	D	size	Vn	Vd	1	0	1	0	N	1	M	0	Vm										

```

if size == '11' then SEE "Related encodings";
if size == '00' || Vd<0> == '1' then UNDEFINED;
unsigned = (U == '1'); long_destination = TRUE; floating_point = FALSE;
d = UInt(D:Vd); n = UInt(N:Vn); regs = 1;
if size == '01' then esize = 16; elements = 4; m = UInt(Vm<2:0>); index = UInt(M:Vm<3>);
if size == '10' then esize = 32; elements = 2; m = UInt(Vm); index = UInt(M);

```

**Related encodings** See [Advanced SIMD data-processing instructions on page A7-261](#).

## Assembler syntax

VMUL{<c>}{<q>}.<dt> {<Qd>}, <Qn>, <Dm[x]>	Encoding T1/A1, encoded as Q = 1
VMUL{<c>}{<q>}.<dt> {<Dd>}, <Dn>, <Dm[x]>	Encoding T1/A1, encoded as Q = 0
VMULL{<c>}{<q>}.<dt> <Qd>, <Dn>, <Dm[x]>	Encoding T2/A2

where:

<c>, <q>	See <a href="#">Standard assembler syntax fields on page A8-287</a> . An ARM Advanced SIMD VMUL or VMULL instruction must be unconditional. ARM strongly recommends that a Thumb Advanced SIMD VMUL or VMULL instruction is unconditional, see <a href="#">Conditional execution on page A8-288</a> .
<dt>	The data type for the scalar, and the elements of the operand vector. It must be one of: I16        Encoding T1/A1, encoded as size = 0b01, F = 0. I32        Encoding T1/A1, encoded as size = 0b10, F = 0. F32        Encoding T1/A1, encoded as size = 0b10, F = 1. S16        Encoding T2/A2, encoded as size = 0b01, U = 0. S32        Encoding T2/A2, encoded as size = 0b10, U = 0. U16        Encoding T2/A2, encoded as size = 0b01, U = 1. U32        Encoding T2/A2, encoded as size = 0b10, U = 1.
<Qd>, <Qn>	The destination vector, and the operand vector, for a quadword operation.
<Dd>, <Dn>	The destination vector, and the operand vector, for a doubleword operation.
<Qd>, <Dn>	The destination vector, and the operand vector, for a long operation.
<Dm[x]>	The scalar. Dm is restricted to D0-D7 if <dt> is I16, S16, or U16, or D0-D15 otherwise.

## Operation

```

if ConditionPassed() then
    EncodingSpecificOperations(); CheckAdvSIMDEnabled();
    op2 = Elem[Din[m],index,esize]; op2val = Int(op2, unsigned);
    for r = 0 to regs-1
        for e = 0 to elements-1
            op1 = Elem[Din[n+r],e,esize]; op1val = Int(op1, unsigned);
            if floating_point then
                Elem[D[d+r],e,esize] = FPMul(op1, op2, FALSE);
            else
                if long_destination then
                    Elem[Q[d>1],e,2*esize] = (op1val*op2val)<2*esize-1:0>;
                else
                    Elem[D[d+r],e,esize] = (op1val*op2val)<esize-1:0>;

```

## Exceptions

Undefined Instruction, Hyp Trap.

### **Floating-point exceptions**

Input Denormal, Invalid Operation, Overflow, Underflow, Inexact.

### A8.8.353 VMVN (immediate)

Vector Bitwise NOT (immediate) places the bitwise inverse of an immediate integer constant into every element of the destination register. For the range of constants available, see [One register and a modified immediate value on page A7-269](#).

Depending on settings in the CPACR, NSACR, and HCPTR registers, and the security state and mode in which the instruction is executed, an attempt to execute the instruction might be UNDEFINED, or trapped to Hyp mode. [Summary of access controls for Advanced SIMD functionality on page B1-1232](#) summarizes these controls.

ARM deprecates the conditional execution of any Advanced SIMD instruction encoding that is not also available as a VFP instruction encoding, see [Conditional execution on page A8-288](#).

#### Encoding T1/A1 Advanced SIMD

VMVN<c>.<dt> <Qd>, #<imm>

VMVN<c>.<dt> <Dd>, #<imm>

15	14	13	12	11	10	9	8	7	6	5	4	3	2	1	0	15	14	13	12	11	10	9	8	7	6	5	4	3	2	1	0
1	1	1	i	1	1	1	1	1	D	0	0	0	imm3			Vd		cmode		0	Q	1	1	imm4							

31	30	29	28	27	26	25	24	23	22	21	20	19	18	17	16	15	14	13	12	11	10	9	8	7	6	5	4	3	2	1	0
1	1	1	1	0	0	1	i	1	D	0	0	0	imm3			Vd		cmode		0	Q	1	1	imm4							

```

if (cmode<0> == '1' && cmode<3:2> != '11') || cmode<3:1> == '111' then SEE "Related encodings";
if Q == '1' && Vd<0> == '1' then UNDEFINED;
imm64 = AdvSIMDEExpandImm('1', cmode, i:imm3:imm4);
d = UInt(D:Vd); regs = if Q == '0' then 1 else 2;

```

**Related encodings** See [One register and a modified immediate value on page A7-269](#).



## Assembler syntax

VMVN{<c>}{<q>}.dt <Qd>, #<imm> Encoding T1/A1, encoded as Q = 1  
VMVN{<c>}{<q>}.dt <Dd>, #<imm> Encoding T1/A1, encoded as Q = 0

where:

<c>, <q> See [Standard assembler syntax fields on page A8-287](#). An ARM VMVN instruction must be unconditional. ARM strongly recommends that a Thumb VMVN instruction is unconditional, see [Conditional execution on page A8-288](#).

<dt> The data type. It must be either I16 or I32.

<Qd> The destination register for a quadword operation.

<Dd> The destination register for a doubleword operation.

<imm> A constant of the specified type.

See [One register and a modified immediate value on page A7-269](#) for the range of constants available, and the encoding of <dt> and <imm>.

## Operation

```
if ConditionPassed() then
    EncodingSpecificOperations(); CheckAdvSIMDEnabled();
    for r = 0 to regs-1
        D[d+r] = NOT(imm64);
```

## Exceptions

Undefined Instruction, Hyp Trap.

## Pseudo-instructions

[One register and a modified immediate value on page A7-269](#) describes pseudo-instructions with a combination of <dt> and <imm> that is not supported by hardware, but that generates the same destination register value as a different combination that is supported by hardware.

### A8.8.354 VMVN (register)

Vector Bitwise NOT (register) takes a value from a register, inverts the value of each bit, and places the result in the destination register. The registers can be either doubleword or quadword.

Depending on settings in the CPACR, NSACR, and HCPTR registers, and the security state and mode in which the instruction is executed, an attempt to execute the instruction might be UNDEFINED, or trapped to Hyp mode. [Summary of access controls for Advanced SIMD functionality on page B1-1232](#) summarizes these controls.

ARM deprecates the conditional execution of any Advanced SIMD instruction encoding that is not also available as a VFP instruction encoding, see [Conditional execution on page A8-288](#).

#### Encoding T1/A1 Advanced SIMD

VMVN<c> <Qd>, <Qm>

VMVN<c> <Dd>, <Dm>

15	14	13	12	11	10	9	8	7	6	5	4	3	2	1	0	15	14	13	12	11	10	9	8	7	6	5	4	3	2	1	0
1	1	1	1	1	1	1	1	D	1	1	size	0	0		Vd	0	1	0	1	1	Q	M	0		Vm						

31	30	29	28	27	26	25	24	23	22	21	20	19	18	17	16	15	14	13	12	11	10	9	8	7	6	5	4	3	2	1	0
1	1	1	1	0	0	1	1	1	D	1	1	size	0	0		Vd	0	1	0	1	1	Q	M	0		Vm					

```

if size != '00' then UNDEFINED;
if Q == '1' && (Vd<0> == '1' || Vm<0> == '1') then UNDEFINED;
d = UInt(D:Vd); m = UInt(M:Vm); regs = if Q == '0' then 1 else 2;

```

## Assembler syntax

VMVN{<c>}{<q>}{.<dt>} <Qd>, <Qm>

VMVN{<c>}{<q>}{.<dt>} <Dd>, <Dm>

where:

- <c>, <q> See [Standard assembler syntax fields on page A8-287](#). An ARM VMVN instruction must be unconditional. ARM strongly recommends that a Thumb VMVN instruction is unconditional, see [Conditional execution on page A8-288](#).
- <dt> An optional data type. It is ignored by assemblers, and does not affect the encoding.
- <Qd>, <Qm> The destination vector and the operand vector, for a quadword operation.
- <Dd>, <Dm> The destination vector and the operand vector, for a doubleword operation.

## Operation

```
if ConditionPassed() then
    EncodingSpecificOperations(); CheckAdvSIMDEnabled();
    for r = 0 to regs-1
        D[d+r] = NOT(D[m+r]);
```

## Exceptions

Undefined Instruction, Hyp Trap.

### A8.8.355 VNEG

Vector Negate negates each element in a vector, and places the results in a second vector. The floating-point version only inverts the sign bit.

Depending on settings in the CPACR, NSACR, HCPTR, and FPEXC registers, and the security state and mode in which the instruction is executed, an attempt to execute the instruction might be UNDEFINED, or trapped to Hyp mode. [Summary of general controls of CP10 and CP11 functionality on page B1-1230](#) and [Summary of access controls for Advanced SIMD functionality on page B1-1232](#) summarize these controls.

ARM deprecates the conditional execution of any Advanced SIMD instruction encoding that is not also available as a VFP instruction encoding, see [Conditional execution on page A8-288](#).

**Encoding T1/A1** Advanced SIMD (F = 1 UNDEFINED in integer-only variants)

VNEG<c>.<dt> <Qd>, <Qm>

VNEG<c>.<dt> <Dd>, <Dm>

15	14	13	12	11	10	9	8	7	6	5	4	3	2	1	0	15	14	13	12	11	10	9	8	7	6	5	4	3	2	1	0
1	1	1	1	1	1	1	1	1	D	1	1	size	0	1	Vd	0	F	1	1	1	Q	M	0	Vm							

31	30	29	28	27	26	25	24	23	22	21	20	19	18	17	16	15	14	13	12	11	10	9	8	7	6	5	4	3	2	1	0
1	1	1	1	0	0	1	1	1	D	1	1	size	0	1	Vd	0	F	1	1	1	Q	M	0	Vm							

```
if size == '11' || (F == '1' && size != '10') then UNDEFINED;
if Q == '1' && (Vd<0> == '1' || Vm<0> == '1') then UNDEFINED;
advsimd = TRUE; floating_point = (F == '1');
esize = 8 << UInt(size); elements = 64 DIV esize;
d = UInt(D:Vd); m = UInt(M:Vm); regs = if Q == '0' then 1 else 2;
```

**Encoding T2/A2** VFPv2, VFPv3, VFPv4 (sz = 1 UNDEFINED in single-precision only variants)

VNEG<c>.<F64> <Dd>, <Dm>

VNEG<c>.<F32> <Sd>, <Sm>

15	14	13	12	11	10	9	8	7	6	5	4	3	2	1	0	15	14	13	12	11	10	9	8	7	6	5	4	3	2	1	0
1	1	1	0	1	1	1	0	1	D	1	1	0	0	0	1	Vd	1	0	1	sz	0	1	M	0	Vm						

31	30	29	28	27	26	25	24	23	22	21	20	19	18	17	16	15	14	13	12	11	10	9	8	7	6	5	4	3	2	1	0
cond		1	1	1	0	1	D	1	1	0	0	0	1	Vd	1	0	1	sz	0	1	M	0	Vm								

```
if FPSCR.Len != '000' || FPSCR.Stride != '00' then SEE "VFP vectors";
advsimd = FALSE; dp_operation = (sz == '1');
d = if dp_operation then UInt(D:Vd) else UInt(Vd:D);
m = if dp_operation then UInt(M:Vm) else UInt(Vm:M);
```

**VFP vectors** Encoding T2/A2 can operate on VFP vectors under control of the FPSCR.{Len, Stride} fields. For details see [Appendix K VFP Vector Operation Support](#).

## Assembler syntax

VNEG{<c>}{<q>}.<dt> <Qd>, <Qm>	Encoding T1/A1
VNEG{<c>}{<q>}.<dt> <Dd>, <Dm>	Encoding T1/A1
VNEG{<c>}{<q>}.F32 <Sd>, <Sm>	Floating-point only, encoding T2/A2, encoded as sz = 0
VNEG{<c>}{<q>}.F64 <Dd>, <Dm>	Encoding T2/A2, encoded as sz = 1

where:

<c>, <q>	See <a href="#">Standard assembler syntax fields on page A8-287</a> . An ARM Advanced SIMD VNEG instruction must be unconditional. ARM strongly recommends that a Thumb Advanced SIMD VNEG instruction is unconditional, see <a href="#">Conditional execution on page A8-288</a> .
<dt>	The data type for the elements of the vectors. It must be one of: S8 Encoded as size = 0b00, F = 0. S16 Encoded as size = 0b01, F = 0. S32 Encoded as size = 0b10, F = 0. F32 Encoded as size = 0b10, F = 1.
<Qd>, <Qm>	The destination vector and the operand vector, for a quadword operation.
<Dd>, <Dm>	The destination vector and the operand vector, for a doubleword operation.
<Sd>, <Sm>	The destination vector and the operand vector, for a singleword operation.

## Operation

```

if ConditionPassed() then
    EncodingSpecificOperations(); CheckAdvSIMDorVFPEEnabled(TRUE, advsimd);
    if advsimd then // Advanced SIMD instruction
        for r = 0 to regs-1
            for e = 0 to elements-1
                if floating_point then
                    Elem[D[d+r],e,esize] = FPNeg(Elem[D[m+r],e,esize]);
                else
                    result = -SInt(Elem[D[m+r],e,esize]);
                    Elem[D[d+r],e,esize] = result<esize-1:0>;
            // VFP instruction
    else
        if dp_operation then
            D[d] = FPNeg(D[m]);
        else
            S[d] = FPNeg(S[m]);

```

## Exceptions

Undefined Instruction, Hyp Trap.

### A8.8.356 VNMLA, VNMLS, VNMUL

VNMLA multiplies together two floating-point register values, adds the negation of the floating-point value in the destination register to the negation of the product, and writes the result back to the destination register.

VNMLS multiplies together two floating-point register values, adds the negation of the floating-point value in the destination register to the product, and writes the result back to the destination register.

VNMUL multiplies together two floating-point register values, and writes the negation of the result to the destination register.

———— **Note** ————

ARM recommends that software does not use the VNMLA instruction in the *Round towards Plus Infinity* and *Round towards Minus Infinity* rounding modes, because the rounding of the product and of the sum can change the result of the instruction in opposite directions, defeating the purpose of these rounding modes.

Depending on settings in the CPACR, NSACR, HCPTR, and FPEXC registers, and the security state and mode in which the instruction is executed, an attempt to execute the instruction might be UNDEFINED, or trapped to Hyp mode. [Summary of general controls of CP10 and CP11 functionality on page B1-1230](#) summarizes these controls.

**Encoding T1/A1** VFPv2, VFPv3, VFPv4 (sz = 1 UNDEFINED in single-precision only variants)

VNMLA<c>.F64 <Dd>, <Dn>, <Dm>  
VNMLA<c>.F32 <Sd>, <Sn>, <Sm>  
VNMLS<c>.F64 <Dd>, <Dn>, <Dm>  
VNMLS<c>.F32 <Sd>, <Sn>, <Sm>

15	14	13	12	11	10	9	8	7	6	5	4	3	2	1	0	15	14	13	12	11	10	9	8	7	6	5	4	3	2	1	0
1	1	1	0	1	1	1	0	0	D	0	1	Vn				Vd	1	0	1	sz	N	op	M	0	Vm						
31	30	29	28	27	26	25	24	23	22	21	20	19	18	17	16	15	14	13	12	11	10	9	8	7	6	5	4	3	2	1	0
cond		1	1	1	0	0	D	0	1	Vn				Vd	1	0	1	sz	N	op	M	0	Vm								

```
if FPSCR.Len != '000' || FPSCR.Stride != '00' then SEE "VFP vectors";
type = if op == '1' then VFPNegMul_VNMLA else VFPNegMul_VNMLS;
dp_operation = (sz == '1');
d = if dp_operation then UInt(D:Vd) else UInt(Vd:D);
n = if dp_operation then UInt(N:Vn) else UInt(Vn:N);
m = if dp_operation then UInt(M:Vm) else UInt(Vm:M);
```

**Encoding T2/A2** VFPv2, VFPv3, VFPv4 (sz = 1 UNDEFINED in single-precision only variants)

VNMUL<c>.F64 <Dd>, <Dn>, <Dm>  
VNMUL<c>.F32 <Sd>, <Sn>, <Sm>

15	14	13	12	11	10	9	8	7	6	5	4	3	2	1	0	15	14	13	12	11	10	9	8	7	6	5	4	3	2	1	0
1	1	1	0	1	1	1	0	0	D	1	0	Vn				Vd	1	0	1	sz	N	1	M	0	Vm						
31	30	29	28	27	26	25	24	23	22	21	20	19	18	17	16	15	14	13	12	11	10	9	8	7	6	5	4	3	2	1	0
cond		1	1	1	0	0	D	1	0	Vn				Vd	1	0	1	sz	N	1	M	0	Vm								

```
if FPSCR.Len != '000' || FPSCR.Stride != '00' then SEE "VFP vectors";
type = VFPNegMul_VNMUL;
dp_operation = (sz == '1');
d = if dp_operation then UInt(D:Vd) else UInt(Vd:D);
n = if dp_operation then UInt(N:Vn) else UInt(Vn:N);
m = if dp_operation then UInt(M:Vm) else UInt(Vm:M);
```

**VFP vectors** These instructions can operate on VFP vectors under control of the FPSCR.{Len, Stride} fields. For details see [Appendix K VFP Vector Operation Support](#).

## Assembler syntax

VN<op>{<c>}{<q>}.F64 <Dd>, <Dn>, <Dm>	Encoding T1/A1, encoded as sz = 1
VN<op>{<c>}{<q>}.F32 <Sd>, <Sn>, <Sm>	Encoding T1/A1, encoded as sz = 0
VNMUL{<c>}{<q>}.F64 {<Dd>}, <Dn>, <Dm>	Encoding T2/A2, encoded as sz = 1
VNMUL{<c>}{<q>}.F32 {<Sd>}, <Sn>, <Sm>	Encoding T2/A2, encoded as sz = 0

where:

<op>	The operation. It must be one of: MLA        Vector Negate Multiply Accumulate. Encoded as op = 0. MLS        Vector Negate Multiply Subtract. Encoded as op = 1.
<c>, <q>	See <a href="#">Standard assembler syntax fields on page A8-287</a> .
<Dd>, <Dn>, <Dm>	The destination register and the operand registers, for a double-precision operation.
<Sd>, <Sn>, <Sm>	The destination register and the operand registers, for a single-precision operation.

## Operation

```
enumeration VFPMul {VFPMul_VNMLA, VFPMul_VNMMLS, VFPMul_VNMUL};
```

```
if ConditionPassed() then
    EncodingSpecificOperations(); CheckVFPEEnabled(TRUE);
    if dp_operation then
        product = FPMul(D[n], D[m], TRUE);
        case type of
            when VFPMul_VNMLA D[d] = FPMul(FPNeg(D[d]), FPNeg(product), TRUE);
            when VFPMul_VNMMLS D[d] = FPMul(FPNeg(D[d]), product, TRUE);
            when VFPMul_VNMUL D[d] = FPNeg(product);
        else
            product = FPMul(S[n], S[m], TRUE);
            case type of
                when VFPMul_VNMLA S[d] = FPMul(FPNeg(S[d]), FPNeg(product), TRUE);
                when VFPMul_VNMMLS S[d] = FPMul(FPNeg(S[d]), product, TRUE);
                when VFPMul_VNMUL S[d] = FPNeg(product);
```

## Exceptions

Undefined Instruction, Hyp Trap.

### ***Floating-point exceptions***

Invalid Operation, Overflow, Underflow, Inexact, Input Denormal.

### A8.8.357 VORN (immediate)

VORN (immediate) is a pseudo-instruction, equivalent to a VORR (immediate) instruction with the immediate value bitwise inverted. For details see *VORR (immediate)* on page A8-974.

### A8.8.358 VORN (register)

This instruction performs a bitwise OR NOT operation between two registers, and places the result in the destination register. The operand and result registers can be quadword or doubleword. They must all be the same size.

Depending on settings in the CPACR, NSACR, and HCPTR registers, and the security state and mode in which the instruction is executed, an attempt to execute the instruction might be UNDEFINED, or trapped to Hyp mode. *Summary of access controls for Advanced SIMD functionality* on page B1-1232 summarizes these controls.

ARM deprecates the conditional execution of any Advanced SIMD instruction encoding that is not also available as a VFP instruction encoding, see *Conditional execution* on page A8-288.

#### Encoding T1/A1 Advanced SIMD

VORN<c> <Qd>, <Qn>, <Qm>

VORN<c> <Dd>, <Dn>, <Dm>

15	14	13	12	11	10	9	8	7	6	5	4	3	2	1	0	15	14	13	12	11	10	9	8	7	6	5	4	3	2	1	0
1	1	1	0	1	1	1	1	0	D	1	1	Vn				Vd				0	0	0	1	N	Q	M	1	Vm			

31	30	29	28	27	26	25	24	23	22	21	20	19	18	17	16	15	14	13	12	11	10	9	8	7	6	5	4	3	2	1	0
1	1	1	1	0	0	1	0	0	D	1	1	Vn				Vd				0	0	0	1	N	Q	M	1	Vm			

```
if Q == '1' && (Vd<0> == '1' || Vn<0> == '1' || Vm<0> == '1') then UNDEFINED;
d = UInt(D:Vd); n = UInt(N:Vn); m = UInt(M:Vm); regs = if Q == '0' then 1 else 2;
```



## Assembler syntax

VORN{<C>}{<q>}{.<dt>} {<Qd>}, <Qn>, <Qm> Encoded as Q = 1  
VORN{<C>}{<q>}{.<dt>} {<Dd>}, <Dn>, <Dm> Encoded as Q = 0

where:

<C>, <q> See [Standard assembler syntax fields on page A8-287](#). An ARM VORN instruction must be unconditional. ARM strongly recommends that a Thumb VORN instruction is unconditional, see [Conditional execution on page A8-288](#).

<dt> An optional data type. It is ignored by assemblers, and does not affect the encoding.

<Qd>, <Qn>, <Qm> The destination vector and the operand vectors, for a quadword operation.

<Dd>, <Dn>, <Dm> The destination vector and the operand vectors, for a doubleword operation.

## Operation

```
if ConditionPassed() then
    EncodingSpecificOperations(); CheckAdvSIMDEnabled();
    for r = 0 to regs-1
        D[d+r] = D[n+r] OR NOT(D[m+r]);
```

## Exceptions

Undefined Instruction, Hyp Trap.

### A8.8.359 VORR (immediate)

This instruction takes the contents of the destination vector, performs a bitwise OR with an immediate constant, and returns the result into the destination vector. For the range of constants available, see [One register and a modified immediate value on page A7-269](#).

Depending on settings in the CPACR, NSACR, and HCPTR registers, and the security state and mode in which the instruction is executed, an attempt to execute the instruction might be UNDEFINED, or trapped to Hyp mode. [Summary of access controls for Advanced SIMD functionality on page B1-1232](#) summarizes these controls.

ARM deprecates the conditional execution of any Advanced SIMD instruction encoding that is not also available as a VFP instruction encoding, see [Conditional execution on page A8-288](#).

#### Encoding T1/A1 Advanced SIMD

VORR<c>.<dt> <Qd>, #<imm>

VORR<c>.<dt> <Dd>, #<imm>

15	14	13	12	11	10	9	8	7	6	5	4	3	2	1	0	15	14	13	12	11	10	9	8	7	6	5	4	3	2	1	0
1	1	1	i	1	1	1	1	1	D	0	0	0	imm3	Vd	cmode	0	Q	0	1	imm4											

31	30	29	28	27	26	25	24	23	22	21	20	19	18	17	16	15	14	13	12	11	10	9	8	7	6	5	4	3	2	1	0
1	1	1	1	0	0	1	i	1	D	0	0	0	imm3	Vd	cmode	0	Q	0	1	imm4											

```
if cmode<0> == '0' || cmode<3:2> == '11' then SEE VMOV (immediate);
if Q == '1' && Vd<0> == '1' then UNDEFINED;
imm64 = AdvSIMDExpandImm('0', cmode, i:imm3:imm4);
d = UInt(D:Vd); regs = if Q == '0' then 1 else 2;
```

## Assembler syntax

VORR{<c>}{<q>}.<dt> {<Qd>}, <Qd>, #<imm> Encoded as Q = 1  
VORR{<c>}{<q>}.<dt> {<Dd>}, <Dd>, #<imm> Encoded as Q = 0

where:

<c>, <q> See [Standard assembler syntax fields on page A8-287](#). An ARM VORR instruction must be unconditional. ARM strongly recommends that a Thumb VORR instruction is unconditional, see [Conditional execution on page A8-288](#).

<dt> The data type used for <imm>. It can be either I16 or I32. I8, I64, and F32 are also permitted, but the resulting syntax is a pseudo-instruction.

<Qd> The destination vector for a quadword operation.

<Dd> The destination vector for a doubleword operation.

<imm> A constant of the type specified by <dt>. This constant is replicated enough times to fill the destination register. For example, VORR.I32 D0, #10 ORs 0x0000000A0000000A into D0.

For details of the range of constants available, and the encoding of <dt> and <imm>, see [One register and a modified immediate value on page A7-269](#).

## Operation

```
if ConditionPassed() then
    EncodingSpecificOperations(); CheckAdvSIMDEnabled();
    for r = 0 to regs-1
        D[d+r] = D[d+r] OR imm64;
```

## Exceptions

Undefined Instruction, Hyp Trap.

## Pseudo-instructions

VORN can be used, with a range of constants that are the bitwise inverse of the available constants for VORR. This is assembled as the equivalent VORR instruction. Disassembly produces the VORR form.

[One register and a modified immediate value on page A7-269](#) describes pseudo-instructions with a combination of <dt> and <imm> that is not supported by hardware, but that generates the same destination register value as a different combination that is supported by hardware.

### A8.8.360 VORR (register)

This instruction performs a bitwise OR operation between two registers, and places the result in the destination register. The operand and result registers can be quadword or doubleword. They must all be the same size.

Depending on settings in the CPACR, NSACR, and HCPTR registers, and the security state and mode in which the instruction is executed, an attempt to execute the instruction might be UNDEFINED, or trapped to Hyp mode. [Summary of access controls for Advanced SIMD functionality on page B1-1232](#) summarizes these controls.

ARM deprecates the conditional execution of any Advanced SIMD instruction encoding that is not also available as a VFP instruction encoding, see [Conditional execution on page A8-288](#).

#### Encoding T1/A1 Advanced SIMD

VORR<c> <Qd>, <Qn>, <Qm>

VORR<c> <Dd>, <Dn>, <Dm>

15	14	13	12	11	10	9	8	7	6	5	4	3	2	1	0	15	14	13	12	11	10	9	8	7	6	5	4	3	2	1	0
1	1	1	0	1	1	1	1	0	D	1	0	Vn				Vd				0	0	0	1	N	Q	M	1	Vm			

31	30	29	28	27	26	25	24	23	22	21	20	19	18	17	16	15	14	13	12	11	10	9	8	7	6	5	4	3	2	1	0
1	1	1	1	0	0	1	0	0	D	1	0	Vn				Vd				0	0	0	1	N	Q	M	1	Vm			

```
if N == M && Vn == Vm then SEE VMOV (register);
if Q == '1' && (Vd<0> == '1' || Vn<0> == '1' || Vm<0> == '1') then UNDEFINED;
d = UInt(D:Vd); n = UInt(N:Vn); m = UInt(M:Vm); regs = if Q == '0' then 1 else 2;
```

## Assembler syntax

VORR{<C>}{<q>}{.<dt>} {<Qd>}, <Qn>, <Qm> Encoded as Q = 1  
VORR{<C>}{<q>}{.<dt>} {<Dd>}, <Dn>, <Dm> Encoded as Q = 0

where:

<C>, <q> See [Standard assembler syntax fields on page A8-287](#). An ARM VORR instruction must be unconditional. ARM strongly recommends that a Thumb VORR instruction is unconditional, see [Conditional execution on page A8-288](#).

<dt> An optional data type. It is ignored by assemblers, and does not affect the encoding.

<Qd>, <Qn>, <Qm> The destination vector and the operand vectors, for a quadword operation.

<Dd>, <Dn>, <Dm> The destination vector and the operand vectors, for a doubleword operation.

## Operation

```
if ConditionPassed() then
    EncodingSpecificOperations(); CheckAdvSIMDEnabled();
    for r = 0 to regs-1
        D[d+r] = D[n+r] OR D[m+r];
```

## Exceptions

Undefined Instruction, Hyp Trap.

### A8.8.361 VPADAL

Vector Pairwise Add and Accumulate Long adds adjacent pairs of elements of a vector, and accumulates the results into the elements of the destination vector.

The vectors can be doubleword or quadword. The operand elements can be 8-bit, 16-bit, or 32-bit integers. The result elements are twice the length of the operand elements.

Figure A8-2 shows an example of the operation of VPADAL.

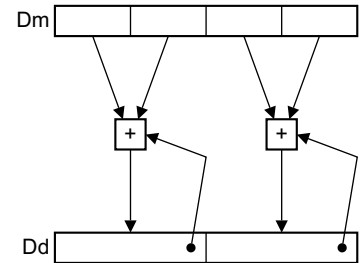

Figure A8-2 VPADAL doubleword operation for data type S16

Depending on settings in the CPACR, NSACR, and HCPTR registers, and the security state and mode in which the instruction is executed, an attempt to execute the instruction might be UNDEFINED, or trapped to Hyp mode. [Summary of access controls for Advanced SIMD functionality on page B1-1232](#) summarizes these controls.

ARM deprecates the conditional execution of any Advanced SIMD instruction encoding that is not also available as a VFP instruction encoding, see [Conditional execution on page A8-288](#).

#### Encoding T1/A1 Advanced SIMD

VPADAL<c>.<dt> <Qd>, <Qm>

VPADAL<c>.<dt> <Dd>, <Dm>

15	14	13	12	11	10	9	8	7	6	5	4	3	2	1	0	15	14	13	12	11	10	9	8	7	6	5	4	3	2	1	0
1	1	1	1	1	1	1	1	1	D	1	1	size	0	0	Vd	0	1	1	0	op	Q	M	0	Vm							

31	30	29	28	27	26	25	24	23	22	21	20	19	18	17	16	15	14	13	12	11	10	9	8	7	6	5	4	3	2	1	0
1	1	1	1	0	0	1	1	1	D	1	1	size	0	0	Vd	0	1	1	0	op	Q	M	0	Vm							

```

if size == '11' then UNDEFINED;
if Q == '1' && (Vd<0> == '1' || Vm<0> == '1') then UNDEFINED;
unsigned = (op == '1');
esize = 8 << UInt(size); elements = 64 DIV esize;
d = UInt(D:Vd); m = UInt(M:Vm); regs = if Q == '0' then 1 else 2;

```

## Assembler syntax

VPADAL{<c>}{<q>}.<dt> <Qd>, <Qm> Encoded as Q = 1  
VPADAL{<c>}{<q>}.<dt> <Dd>, <Dm> Encoded as Q = 0

where:

<c>, <q> See [Standard assembler syntax fields on page A8-287](#). An ARM VPADAL instruction must be unconditional. ARM strongly recommends that a Thumb VPADAL instruction is unconditional, see [Conditional execution on page A8-288](#).

<dt> The data type for the elements of the vectors. It must be one of:

S8	Encoded as size = 0b00, op = 0.
S16	Encoded as size = 0b01, op = 0.
S32	Encoded as size = 0b10, op = 0.
U8	Encoded as size = 0b00, op = 1.
U16	Encoded as size = 0b01, op = 1.
U32	Encoded as size = 0b10, op = 1.

<Qd>, <Qm> The destination vector and the operand vector, for a quadword operation.

<Dd>, <Dm> The destination vector and the operand vector, for a doubleword operation.

## Operation

```
if ConditionPassed() then
    EncodingSpecificOperations(); CheckAdvSIMDEnabled();
    h = elements/2;

    for r = 0 to regs-1
        for e = 0 to h-1
            op1 = Elem[D[m+r],2*e,esize]; op2 = Elem[D[m+r],2*e+1,esize];
            result = Int(op1, unsigned) + Int(op2, unsigned);
            Elem[D[d+r],e,2*esize] = Elem[D[d+r],e,2*esize] + result;
```

## Exceptions

Undefined Instruction, Hyp Trap.

### A8.8.362 VPADD (integer)

Vector Pairwise Add (integer) adds adjacent pairs of elements of two vectors, and places the results in the destination vector.

The operands and result are doubleword vectors.

The operand and result elements must all be the same type, and can be 8-bit, 16-bit, or 32-bit integers. There is no distinction between signed and unsigned integers.

Figure A8-3 shows an example of the operation of VPADD.

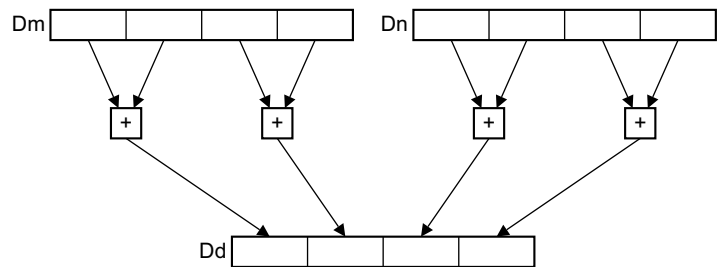

Figure A8-3 VPADD operation for data type I16

Depending on settings in the CPACR, NSACR, and HCPTR registers, and the security state and mode in which the instruction is executed, an attempt to execute the instruction might be UNDEFINED, or trapped to Hyp mode. [Summary of access controls for Advanced SIMD functionality on page B1-1232](#) summarizes these controls.

ARM deprecates the conditional execution of any Advanced SIMD instruction encoding that is not also available as a VFP instruction encoding, see [Conditional execution on page A8-288](#).

#### Encoding T1/A1 Advanced SIMD

VPADD<c>.<dt> <Dd>, <Dn>, <Dm>

15	14	13	12	11	10	9	8	7	6	5	4	3	2	1	0	15	14	13	12	11	10	9	8	7	6	5	4	3	2	1	0
1	1	1	0	1	1	1	1	0	D	size		Vn		Vd	1	0	1	1	N	Q	M	1		Vm							
31	30	29	28	27	26	25	24	23	22	21	20	19	18	17	16	15	14	13	12	11	10	9	8	7	6	5	4	3	2	1	0
1	1	1	1	0	0	1	0	0	D	size		Vn		Vd	1	0	1	1	N	Q	M	1		Vm							

```
if size == '11' || Q == '1' then UNDEFINED;
esize = 8 << UInt(size);  elements = 64 DIV esize;
d = UInt(D:Vd);  n = UInt(N:Vn);  m = UInt(M:Vm);
```



## Assembler syntax

VPADD{<c>}{<q>}.<dt> {<Dd>}, <Dn>, <Dm> Encoded as Q = 0

where:

<c>, <q> See [Standard assembler syntax fields on page A8-287](#). An ARM VPADD instruction must be unconditional. ARM strongly recommends that a Thumb VPADD instruction is unconditional, see [Conditional execution on page A8-288](#).

<dt> The data type for the elements of the vectors. It must be one of:  
I8            Encoding T1/A1, encoded as size = 0b00.  
I16          Encoding T1/A1, encoded as size = 0b01.  
I32          Encoding T1/A1, encoded as size = 0b10.

<Dd>, <Dn>, <Dm> The destination vector, the first operand vector, and the second operand vector.

## Operation

```
if ConditionPassed() then
    EncodingSpecificOperations(); CheckAdvSIMDEnabled();
    bits(64) dest;
    h = elements/2;

    for e = 0 to h-1
        Elem[dest,e,esize] = Elem[D[n],2*e,esize] + Elem[D[n],2*e+1,esize];
        Elem[dest,e+h,esize] = Elem[D[m],2*e,esize] + Elem[D[m],2*e+1,esize];

    D[d] = dest;
```

## Exceptions

Undefined Instruction, Hyp Trap.

### A8.8.363 VPADD (floating-point)

Vector Pairwise Add (floating-point) adds adjacent pairs of elements of two vectors, and places the results in the destination vector.

The operands and result are doubleword vectors.

The operand and result elements are 32-bit floating-point numbers.

Figure A8-3 on page A8-980 shows an example of the operation of VPADD.

Depending on settings in the CPACR, NSACR, and HCPTR registers, and the security state and mode in which the instruction is executed, an attempt to execute the instruction might be UNDEFINED, or trapped to Hyp mode.

Summary of access controls for Advanced SIMD functionality on page B1-1232 summarizes these controls.

ARM deprecates the conditional execution of any Advanced SIMD instruction encoding that is not also available as a VFP instruction encoding, see Conditional execution on page A8-288.

#### Encoding T1/A1 Advanced SIMD (UNDEFINED in integer-only variant)

VPADD<c>.F32 <Dd>, <Dn>, <Dm>

15	14	13	12	11	10	9	8	7	6	5	4	3	2	1	0	15	14	13	12	11	10	9	8	7	6	5	4	3	2	1	0
1	1	1	1	1	1	1	1	0	D	0	sz	Vn				Vd				1	1	0	1	N	Q	M	0	Vm			
31	30	29	28	27	26	25	24	23	22	21	20	19	18	17	16	15	14	13	12	11	10	9	8	7	6	5	4	3	2	1	0
1	1	1	1	0	0	1	1	0	D	0	sz	Vn				Vd				1	1	0	1	N	Q	M	0	Vm			

```
if sz == '1' || Q == '1' then UNDEFINED;
esize = 32; elements = 2;
d = UInt(D:Vd); n = UInt(N:Vn); m = UInt(M:Vm);
```

## Assembler syntax

VPADD{<c>}{<q>}.F32 {<Dd>}, <Dn>, <Dm>

Encoded as Q = 0, sz = 0

where:

<c>, <q> See [Standard assembler syntax fields on page A8-287](#). An ARM VPADD instruction must be unconditional. ARM strongly recommends that a Thumb VPADD instruction is unconditional, see [Conditional execution on page A8-288](#).

<Dd>, <Dn>, <Dm> The destination vector, the first operand vector, and the second operand vector.

## Operation

```
if ConditionPassed() then
    EncodingSpecificOperations(); CheckAdvSIMDEnabled();
    bits(64) dest;
    h = elements/2;

    for e = 0 to h-1
        Elem[dest,e,esize] = FPAdd(Elem[D[n],2*e,esize], Elem[D[n],2*e+1,esize], FALSE);
        Elem[dest,e+h,esize] = FPAdd(Elem[D[m],2*e,esize], Elem[D[m],2*e+1,esize], FALSE);

    D[d] = dest;
```

## Exceptions

Undefined Instruction, Hyp Trap.

### ***Floating-point exceptions***

Input Denormal, Invalid Operation, Overflow, Underflow, Inexact.

### A8.8.364 VPADDL

Vector Pairwise Add Long adds adjacent pairs of elements of two vectors, and places the results in the destination vector.

The vectors can be doubleword or quadword. The operand elements can be 8-bit, 16-bit, or 32-bit integers. The result elements are twice the length of the operand elements.

Figure A8-4 shows an example of the operation of VPADDL.

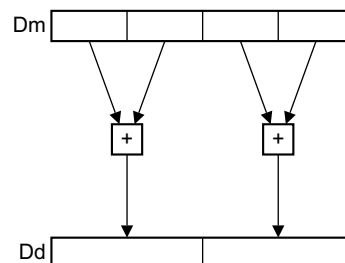

Figure A8-4 VPADDL doubleword operation for data type S16

Depending on settings in the CPACR, NSACR, and HCPTR registers, and the security state and mode in which the instruction is executed, an attempt to execute the instruction might be UNDEFINED, or trapped to Hyp mode. [Summary of access controls for Advanced SIMD functionality on page B1-1232](#) summarizes these controls.

ARM deprecates the conditional execution of any Advanced SIMD instruction encoding that is not also available as a VFP instruction encoding, see [Conditional execution on page A8-288](#).

#### Encoding T1/A1 Advanced SIMD

VPADDL<c>.<dt> <Qd>, <Qm>

VPADDL<c>.<dt> <Dd>, <Dm>

15	14	13	12	11	10	9	8	7	6	5	4	3	2	1	0	15	14	13	12	11	10	9	8	7	6	5	4	3	2	1	0
1	1	1	1	1	1	1	1	1	D	1	1	size	0	0	Vd	0	0	1	0	op	Q	M	0	Vm							

31	30	29	28	27	26	25	24	23	22	21	20	19	18	17	16	15	14	13	12	11	10	9	8	7	6	5	4	3	2	1	0
1	1	1	1	0	0	1	1	1	D	1	1	size	0	0	Vd	0	0	1	0	op	Q	M	0	Vm							

```

if size == '11' then UNDEFINED;
if Q == '1' && (Vd<0> == '1' || Vm<0> == '1') then UNDEFINED;
unsigned = (op == '1');
esize = 8 << UInt(size); elements = 64 DIV esize;
d = UInt(D:Vd); m = UInt(M:Vm); regs = if Q == '0' then 1 else 2;

```

## Assembler syntax

VPADDL{<c>}{<q>}.<dt> <Qd>, <Qm> Encoded as Q = 1  
VPADDL{<c>}{<q>}.<dt> <Dd>, <Dm> Encoded as Q = 0

where:

<c>, <q> See [Standard assembler syntax fields on page A8-287](#). An ARM VPADDL instruction must be unconditional. ARM strongly recommends that a Thumb VPADDL instruction is unconditional, see [Conditional execution on page A8-288](#).

<dt> The data type for the elements of the vectors. It must be one of:

S8	Encoded as size = 0b00, op = 0.
S16	Encoded as size = 0b01, op = 0.
S32	Encoded as size = 0b10, op = 0.
U8	Encoded as size = 0b00, op = 1.
U16	Encoded as size = 0b01, op = 1.
U32	Encoded as size = 0b10, op = 1.

<Qd>, <Qm> The destination vector and the operand vector, for a quadword operation.

<Dd>, <Dm> The destination vector and the operand vector, for a doubleword operation.

## Operation

```
if ConditionPassed() then
    EncodingSpecificOperations(); CheckAdvSIMDEnabled();
    h = elements/2;

    for r = 0 to regs-1
        for e = 0 to h-1
            op1 = Elem[D[m+r],2*e,esize]; op2 = Elem[D[m+r],2*e+1,esize];
            result = Int(op1, unsigned) + Int(op2, unsigned);
            Elem[D[d+r],e,2*esize] = result<2*esize-1:0>;
```

## Exceptions

Undefined Instruction, Hyp Trap.

### A8.8.365 VPMAX, VPMIN (integer)

Vector Pairwise Maximum compares adjacent pairs of elements in two doubleword vectors, and copies the larger of each pair into the corresponding element in the destination doubleword vector.

Vector Pairwise Minimum compares adjacent pairs of elements in two doubleword vectors, and copies the smaller of each pair into the corresponding element in the destination doubleword vector.

Figure A8-5 shows an example of the operation of VPMAX.

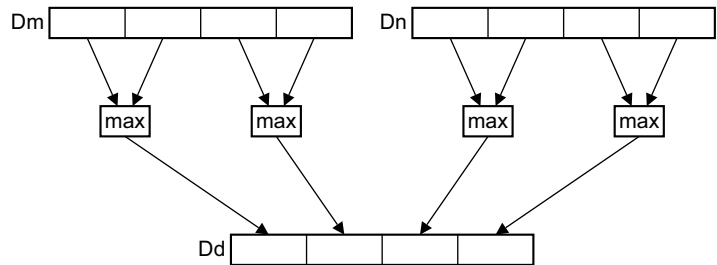

Figure A8-5 VPMAX operation for data type S16 or U16

Depending on settings in the CPACR, NSACR, and HCPTR registers, and the security state and mode in which the instruction is executed, an attempt to execute the instruction might be UNDEFINED, or trapped to Hyp mode. [Summary of access controls for Advanced SIMD functionality on page B1-1232](#) summarizes these controls.

ARM deprecates the conditional execution of any Advanced SIMD instruction encoding that is not also available as a VFP instruction encoding, see [Conditional execution on page A8-288](#).

#### Encoding T1/A1 Advanced SIMD

VP<op><c>.<dt> <Dd>, <Dn>, <Dm>

15	14	13	12	11	10	9	8	7	6	5	4	3	2	1	0	15	14	13	12	11	10	9	8	7	6	5	4	3	2	1	0
1	1	1	U	1	1	1	1	0	D	size		Vn		Vd	1	0	1	0	N	Q	M	op		Vm							

31	30	29	28	27	26	25	24	23	22	21	20	19	18	17	16	15	14	13	12	11	10	9	8	7	6	5	4	3	2	1	0
1	1	1	1	0	0	1	U	0	D	size		Vn		Vd	1	0	1	0	N	Q	M	op		Vm							

```

if size == '11' || Q == '1' then UNDEFINED;
maximum = (op == '0'); unsigned = (U == '1');
esize = 8 << UInt(size); elements = 64 DIV esize;
d = UInt(D:Vd); n = UInt(N:Vn); m = UInt(M:Vm);

```

## Assembler syntax

VP<op>{<c>}{<q>}.<dt> {<Dd>,<Dn>, <Dm>} Encoded as Q = 0

where:

<op>	The operation. It must be one of: MAX Encoded as op = 0. MIN Encoded as op = 1.
<c>, <q>	See <a href="#">Standard assembler syntax fields on page A8-287</a> . An ARM VPMAX or VPMIN instruction must be unconditional. ARM strongly recommends that a Thumb VPMAX or VPMIN instruction is unconditional, see <a href="#">Conditional execution on page A8-288</a> .
<dt>	The data type for the elements of the vectors. It must be one of: S8 Encoding T1/A1, encoded as size = 0b00, U = 0. S16 Encoding T1/A1, encoded as size = 0b01, U = 0. S32 Encoding T1/A1, encoded as size = 0b10, U = 0. U8 Encoding T1/A1, encoded as size = 0b00, U = 1. U16 Encoding T1/A1, encoded as size = 0b01, U = 1. U32 Encoding T1/A1, encoded as size = 0b10, U = 1.
<Dd>, <Dn>, <Dm>	The destination vector and the operand vectors.

## Operation

```

if ConditionPassed() then
    EncodingSpecificOperations(); CheckAdvSIMDEnabled();
    bits(64) dest;
    h = elements/2;

    for e = 0 to h-1
        op1 = Int(Elem[D[n],2*e,esize], unsigned);
        op2 = Int(Elem[D[n],2*e+1,esize], unsigned);
        result = if maximum then Max(op1,op2) else Min(op1,op2);
        Elem[dest,e,esize] = result<esize-1:0>;
        op1 = Int(Elem[D[m],2*e,esize], unsigned);
        op2 = Int(Elem[D[m],2*e+1,esize], unsigned);
        result = if maximum then Max(op1,op2) else Min(op1,op2);
        Elem[dest,e+h,esize] = result<esize-1:0>;

    D[d] = dest;

```

## Exceptions

Undefined Instruction, Hyp Trap.

### A8.8.366 VPMAX, VPMIN (floating-point)

Vector Pairwise Maximum compares adjacent pairs of elements in two doubleword vectors, and copies the larger of each pair into the corresponding element in the destination doubleword vector.

Vector Pairwise Minimum compares adjacent pairs of elements in two doubleword vectors, and copies the smaller of each pair into the corresponding element in the destination doubleword vector.

Figure A8-5 on page A8-986 shows an example of the operation of VPMAX.

Depending on settings in the CPACR, NSACR, and HCPTR registers, and the security state and mode in which the instruction is executed, an attempt to execute the instruction might be UNDEFINED, or trapped to Hyp mode.

Summary of access controls for Advanced SIMD functionality on page B1-1232 summarizes these controls.

ARM deprecates the conditional execution of any Advanced SIMD instruction encoding that is not also available as a VFP instruction encoding, see Conditional execution on page A8-288.

#### Encoding T1/A1 Advanced SIMD (UNDEFINED in integer-only variant)

VP<op><c>.F32 <Dd>, <Dn>, <Dm>

15	14	13	12	11	10	9	8	7	6	5	4	3	2	1	0	15	14	13	12	11	10	9	8	7	6	5	4	3	2	1	0
1	1	1	1	1	1	1	1	0	D	op	sz	Vn			Vd			1	1	1	1	N	Q	M	0	Vm					
31	30	29	28	27	26	25	24	23	22	21	20	19	18	17	16	15	14	13	12	11	10	9	8	7	6	5	4	3	2	1	0
1	1	1	1	0	0	1	1	0	D	op	sz	Vn			Vd			1	1	1	1	N	Q	M	0	Vm					

```
if sz == '1' || Q == '1' then UNDEFINED;
maximum = (op == '0'); esize = 32; elements = 2;
d = UInt(D:Vd); n = UInt(N:Vn); m = UInt(M:Vm);
```



## Assembler syntax

VP<op>{<c>}{<q>}.F32 {<Dd>}, <Dn>, <Dm> Encoded as Q = 0, sz = 0

where:

<op> The operation. It must be one of:  
MAX Encoded as op = 0.  
MIN Encoded as op = 1.

<c>, <q> See [Standard assembler syntax fields on page A8-287](#). An ARM VPMAX or VPMIN instruction must be unconditional. ARM strongly recommends that a Thumb VPMAX or VPMIN instruction is unconditional, see [Conditional execution on page A8-288](#).

<Dd>, <Dn>, <Dm> The destination vector and the operand vectors.

## Operation

```
if ConditionPassed() then
    EncodingSpecificOperations(); CheckAdvSIMDEnabled();
    bits(64) dest;
    h = elements/2;

    for e = 0 to h-1
        op1 = Elem[D[n],2*e,esize]; op2 = Elem[D[n],2*e+1,esize];
        Elem[dest,e,esize] = if maximum then FPMAX(op1,op2,FALSE) else FPMIN(op1,op2,FALSE);
        op1 = Elem[D[m],2*e,esize]; op2 = Elem[D[m],2*e+1,esize];
        Elem[dest,e+h,esize] = if maximum then FPMAX(op1,op2,FALSE) else FPMIN(op1,op2,FALSE);

    D[d] = dest;
```

## Exceptions

Undefined Instruction, Hyp Trap.

### *Floating-point exceptions*

Invalid Operation, Input Denormal.

### A8.8.367 VPOP

Vector Pop loads multiple consecutive extension registers from the stack.

Depending on settings in the [CPACR](#), [NSACR](#), [HCPTR](#), and [FPEXC](#) registers, and the security state and mode in which the instruction is executed, an attempt to execute the instruction might be UNDEFINED, or trapped to Hyp mode. [Summary of general controls of CP10 and CP11 functionality on page B1-1230](#) and [Summary of access controls for Advanced SIMD functionality on page B1-1232](#) summarize these controls.

#### Encoding T1/A1 VFPv2, VFPv3, VFPv4, Advanced SIMD

VPOP <list> <list> is consecutive 64-bit registers

15	14	13	12	11	10	9	8	7	6	5	4	3	2	1	0	15	14	13	12	11	10	9	8	7	6	5	4	3	2	1	0
1	1	1	0	1	1	0	0	1	D	1	1	1	1	0	1	Vd	1	0	1	1	imm8										

31	30	29	28	27	26	25	24	23	22	21	20	19	18	17	16	15	14	13	12	11	10	9	8	7	6	5	4	3	2	1	0
cond		1	1	0	0	1	D	1	1	1	1	0	1	Vd	1	0	1	1	imm8												

```
single_regs = FALSE; d = UInt(D:Vd); imm32 = ZeroExtend(imm8:'00', 32);
regs = UInt(imm8) DIV 2; // If UInt(imm8) is odd, see "FLDMX".
if regs == 0 || regs > 16 || (d+regs) > 32 then UNPREDICTABLE;
if VFPSmallRegisterBank() && (d+regs) > 16 then UNPREDICTABLE;
```

#### Encoding T2/A2 VFPv2, VFPv3, VFPv4

VPOP <list> <list> is consecutive 32-bit registers

15	14	13	12	11	10	9	8	7	6	5	4	3	2	1	0	15	14	13	12	11	10	9	8	7	6	5	4	3	2	1	0
1	1	1	0	1	1	0	0	1	D	1	1	1	1	0	1	Vd	1	0	1	0	imm8										

31	30	29	28	27	26	25	24	23	22	21	20	19	18	17	16	15	14	13	12	11	10	9	8	7	6	5	4	3	2	1	0
cond		1	1	0	0	1	D	1	1	1	1	0	1	Vd	1	0	1	0	imm8												

```
single_regs = TRUE; d = UInt(Vd:D); imm32 = ZeroExtend(imm8:'00', 32);
regs = UInt(imm8);
if regs == 0 || (d+regs) > 32 then UNPREDICTABLE;
```

#### FLDMX

Encoding T1/A1 behaves as described by the pseudocode if imm8 is odd. However, there is no UAL syntax for such encodings and ARM deprecates their use. For more information, see [FLDMX, FSTMX on page A8-388](#).

## Assembler syntax

VPOP{<c>}{<q>}{.<size>} <list>

where:

- <c>, <q>      See *Standard assembler syntax fields* on page A8-287.
- <size>        An optional data size specifier. If present, it must be equal to the size in bits, 32 or 64, of the registers in <list>.
- <list>        The extension registers to be loaded, as a list of consecutively numbered doubleword (encoding T1/A1) or singleword (encoding T2/A2) registers, separated by commas and surrounded by brackets. It is encoded in the instruction by setting D and Vd to specify the first register in the list, and imm8 to twice the number of registers in the list (encoding T1/A1) or the number of registers in the list (encoding T2/A2). <list> must contain at least one register, and not more than sixteen.

## Operation

```

if ConditionPassed() then
    EncodingSpecificOperations(); CheckVFPEnabled(TRUE); NullCheckIfThumbEE(13);
    address = SP;
    SP = SP + imm32;
    if single_regs then
        for r = 0 to regs-1
            S[d+r] = MemA[address,4]; address = address+4;
    else
        for r = 0 to regs-1
            word1 = MemA[address,4]; word2 = MemA[address+4,4]; address = address+8;
            // Combine the word-aligned words in the correct order for current endianness.
            D[d+r] = if BigEndian() then word1:word2 else word2:word1;

```

## Exceptions

Undefined Instruction, Hyp Trap, Data Abort.

### A8.8.368 V PUSH

Vector Push stores multiple consecutive extension registers to the stack.

Depending on settings in the CPACR, NSACR, HCPTR, and FPEXC registers, and the security state and mode in which the instruction is executed, an attempt to execute the instruction might be UNDEFINED, or trapped to Hyp mode. *Summary of general controls of CP10 and CP11 functionality* on page B1-1230 and *Summary of access controls for Advanced SIMD functionality* on page B1-1232 summarize these controls.

#### Encoding T1/A1 VFPv2, VFPv3, VFPv4, Advanced SIMD

V PUSH<c> <list> <list> is consecutive 64-bit registers

15	14	13	12	11	10	9	8	7	6	5	4	3	2	1	0	15	14	13	12	11	10	9	8	7	6	5	4	3	2	1	0
1	1	1	0	1	1	0	1	0	D	1	0	1	1	0	1	Vd	1	0	1	1	imm8										

31	30	29	28	27	26	25	24	23	22	21	20	19	18	17	16	15	14	13	12	11	10	9	8	7	6	5	4	3	2	1	0
cond		1	1	0	1	0	D	1	0	1	1	0	1	Vd		1	0	1	1	imm8											

```
single_regs = FALSE; d = UInt(D:Vd); imm32 = ZeroExtend(imm8:'00', 32);
regs = UInt(imm8) DIV 2; // If UInt(imm8) is odd, see "FSTMX".
if regs == 0 || regs > 16 || (d+regs) > 32 then UNPREDICTABLE;
if VFPsmallRegisterBank() && (d+regs) > 16 then UNPREDICTABLE;
```

#### Encoding T2/A2 VFPv2, VFPv3, VFPv4

V PUSH<c> <list> <list> is consecutive 32-bit registers

15	14	13	12	11	10	9	8	7	6	5	4	3	2	1	0	15	14	13	12	11	10	9	8	7	6	5	4	3	2	1	0
1	1	1	0	1	1	0	1	0	D	1	0	1	1	0	1	Vd	1	0	1	0	imm8										

31	30	29	28	27	26	25	24	23	22	21	20	19	18	17	16	15	14	13	12	11	10	9	8	7	6	5	4	3	2	1	0
cond		1	1	0	1	0	D	1	0	1	1	0	1	Vd		1	0	1	0	imm8											

```
single_regs = TRUE; d = UInt(Vd:D);
imm32 = ZeroExtend(imm8:'00', 32); regs = UInt(imm8);
if regs == 0 || (d+regs) > 32 then UNPREDICTABLE;
```

#### FSTMX

Encoding T1/A1 behaves as described by the pseudocode if imm8 is odd. However, there is no UAL syntax for such encodings and ARM deprecates their use. For more information, see *FLDMX, FSTMX* on page A8-388.

## Assembler syntax

VPUSH{<c>}{<q>}{.<size>} <list>

where:

- <c>, <q>     See *Standard assembler syntax fields* on page A8-287.
- <size>       An optional data size specifier. If present, it must be equal to the size in bits, 32 or 64, of the registers in <list>.
- <list>       The extension registers to be stored, as a list of consecutively numbered doubleword (encoding T1/A1) or singleword (encoding T2/A2) registers, separated by commas and surrounded by brackets. It is encoded in the instruction by setting D and Vd to specify the first register in the list, and imm8 to twice the number of registers in the list (encoding T1/A1), or the number of registers in the list (encoding T2/A2). <list> must contain at least one register, and not more than sixteen.

## Operation

```

if ConditionPassed() then
    EncodingSpecificOperations(); CheckVFPEnabled(TRUE); NullCheckIfThumbEE(13);
    address = SP - imm32;
    SP = SP - imm32;
    if single_regs then
        for r = 0 to regs-1
            MemA[address,4] = S[d+r]; address = address+4;
    else
        for r = 0 to regs-1
            // Store as two word-aligned words in the correct order for current endianness.
            MemA[address,4] = if BigEndian() then D[d+r]<63:32> else D[d+r]<31:0>;
            MemA[address+4,4] = if BigEndian() then D[d+r]<31:0> else D[d+r]<63:32>;
            address = address+8;

```

## Exceptions

Undefined Instruction, Hyp Trap, Data Abort.

### A8.8.369 VQABS

Vector Saturating Absolute takes the absolute value of each element in a vector, and places the results in the destination vector.

If any of the results overflow, they are saturated. The cumulative saturation bit, `FPSCR.QC`, is set if saturation occurs. For details see [Pseudocode details of saturation on page A2-44](#).

Depending on settings in the `CPACR`, `NSACR`, and `HCPTR` registers, and the security state and mode in which the instruction is executed, an attempt to execute the instruction might be UNDEFINED, or trapped to Hyp mode. [Summary of access controls for Advanced SIMD functionality on page B1-1232](#) summarizes these controls.

ARM deprecates the conditional execution of any Advanced SIMD instruction encoding that is not also available as a VFP instruction encoding, see [Conditional execution on page A8-288](#).

#### Encoding T1/A1 Advanced SIMD

VQABS<c>.<dt> <Qd>, <Qm>

VQABS<c>.<dt> <Dd>, <Dm>

15	14	13	12	11	10	9	8	7	6	5	4	3	2	1	0	15	14	13	12	11	10	9	8	7	6	5	4	3	2	1	0
1	1	1	1	1	1	1	1	D	1	1	size	0	0		Vd	0	1	1	1	0	Q	M	0		Vm						
31	30	29	28	27	26	25	24	23	22	21	20	19	18	17	16	15	14	13	12	11	10	9	8	7	6	5	4	3	2	1	0
1	1	1	1	0	0	1	1	1	D	1	1	size	0	0		Vd	0	1	1	1	0	Q	M	0		Vm					

```

if size == '11' then UNDEFINED;
if Q == '1' && (Vd<0> == '1' || Vm<0> == '1') then UNDEFINED;
esize = 8 << UInt(size); elements = 64 DIV esize;
d = UInt(D:Vd); m = UInt(M:Vm); regs = if Q == '0' then 1 else 2;

```

## Assembler syntax

VQABS{<c>}{<q>}.<dt> <Qd>, <Qm> Encoded as Q = 1  
VQABS{<c>}{<q>}.<dt> <Dd>, <Dm> Encoded as Q = 0

where:

<c>, <q> See [Standard assembler syntax fields on page A8-287](#). An ARM VQABS instruction must be unconditional. ARM strongly recommends that a Thumb VQABS instruction is unconditional, see [Conditional execution on page A8-288](#).

<dt> The data type for the elements of the vectors. It must be one of:  
S8 Encoded as size = 0b00.  
S16 Encoded as size = 0b01.  
S32 Encoded as size = 0b10.

<Qd>, <Qm> The destination vector and the operand vector, for a quadword operation.

<Dd>, <Dm> The destination vector and the operand vector, for a doubleword operation.

## Operation

```
if ConditionPassed() then
    EncodingSpecificOperations(); CheckAdvSIMDEnabled();
    for r = 0 to regs-1
        for e = 0 to elements-1
            result = Abs(SInt(Elem[D[m+r],e,esize]));
            (Elem[D[d+r],e,esize], sat) = SignedSatQ(result, esize);
            if sat then FPSCR.QC = '1';
```

## Exceptions

Undefined Instruction, Hyp Trap.

### A8.8.370 VQADD

Vector Saturating Add adds the values of corresponding elements of two vectors, and places the results in the destination vector.

If any of the results overflow, they are saturated. The cumulative saturation bit, `FPSCR.QC`, is set if saturation occurs. For details see [Pseudocode details of saturation on page A2-44](#).

Depending on settings in the `CPACR`, `NSACR`, and `HCPTR` registers, and the security state and mode in which the instruction is executed, an attempt to execute the instruction might be UNDEFINED, or trapped to Hyp mode. [Summary of access controls for Advanced SIMD functionality on page B1-1232](#) summarizes these controls.

ARM deprecates the conditional execution of any Advanced SIMD instruction encoding that is not also available as a VFP instruction encoding, see [Conditional execution on page A8-288](#).

#### Encoding T1/A1 Advanced SIMD

VQADD<c>.<dt> <Qd>, <Qn>, <Qm>

VQADD<c>.<dt> <Dd>, <Dn>, <Dm>

```
if Q == '1' && (Vd<0> == '1' || Vn<0> == '1' || Vm<0> == '1') then UNDEFINED;
unsigned = (U == '1');
esize = 8 << UInt(size); elements = 64 DIV esize;
d = UInt(D:Vd); n = UInt(N:Vn); m = UInt(M:Vm); regs = if Q == '0' then 1 else 2;
```

15	14	13	12	11	10	9	8	7	6	5	4	3	2	1	0	15	14	13	12	11	10	9	8	7	6	5	4	3	2	1	0
1	1	1	U	1	1	1	1	0	D	size		Vn		Vd		0	0	0	0	N	Q	M	1		Vm						

31	30	29	28	27	26	25	24	23	22	21	20	19	18	17	16	15	14	13	12	11	10	9	8	7	6	5	4	3	2	1	0
1	1	1	1	0	0	1	U	0	D	size		Vn		Vd		0	0	0	0	N	Q	M	1		Vm						



## Assembler syntax

VQADD{<c>}{<q>}.<type><size> {<Qd>}, <Qn>, <Qm> Encoded as Q = 1  
VQADD{<c>}{<q>}.<type><size> {<Dd>}, <Dn>, <Dm> Encoded as Q = 0

where:

<c>, <q> See [Standard assembler syntax fields on page A8-287](#). An ARM VQADD instruction must be unconditional. ARM strongly recommends that a Thumb VQADD instruction is unconditional, see [Conditional execution on page A8-288](#).

<type> The data type for the elements of the vectors. It must be one of:

S Signed, encoded as U = 0.  
U Unsigned, encoded as U = 1.

<size> The data size for the elements of the vectors. It must be one of:

8 Encoded as size = 0b00.  
16 Encoded as size = 0b01.  
32 Encoded as size = 0b10.  
64 Encoded as size = 0b11.

<Qd>, <Qn>, <Qm> The destination vector and the operand vectors, for a quadword operation.

<Dd>, <Dn>, <Dm> The destination vector and the operand vectors, for a doubleword operation.

## Operation

```
if ConditionPassed() then
    EncodingSpecificOperations(); CheckAdvSIMDEnabled();
    for r = 0 to regs-1
        for e = 0 to elements-1
            sum = Int(Elem[D[n+r],e,esize], unsigned) + Int(Elem[D[m+r],e,esize], unsigned);
            (Elem[D[d+r],e,esize], sat) = SatQ(sum, esize, unsigned);
            if sat then FPSCR.QC = '1';
```

## Exceptions

Undefined Instruction, Hyp Trap.

### A8.8.371 VQDMLAL, VQDMLSL

Vector Saturating Doubling Multiply Accumulate Long multiplies corresponding elements in two doubleword vectors, doubles the products, and accumulates the results into the elements of a quadword vector.

Vector Saturating Doubling Multiply Subtract Long multiplies corresponding elements in two doubleword vectors, subtracts double the products from corresponding elements of a quadword vector, and places the results in the same quadword vector.

In both instructions, the second operand can be a scalar instead of a vector. For more information about scalars see [Advanced SIMD scalars on page A7-260](#).

If any of the results overflow, they are saturated. The cumulative saturation bit, `FPSCR.QC`, is set if saturation occurs. For details see [Pseudocode details of saturation on page A2-44](#).

Depending on settings in the `CPACR`, `NSACR`, and `HCPTR` registers, and the security state and mode in which the instruction is executed, an attempt to execute the instruction might be `UNDEFINED`, or trapped to Hyp mode. [Summary of access controls for Advanced SIMD functionality on page B1-1232](#) summarizes these controls.

ARM deprecates the conditional execution of any Advanced SIMD instruction encoding that is not also available as a VFP instruction encoding, see [Conditional execution on page A8-288](#).

#### Encoding T1/A1 Advanced SIMD

VQD<op><c>.<dt> <Qd>, <Dn>, <Dm>

15	14	13	12	11	10	9	8	7	6	5	4	3	2	1	0	15	14	13	12	11	10	9	8	7	6	5	4	3	2	1	0
1	1	1	0	1	1	1	1	1	D	size	Vn	Vd	1	0	op	1	N	0	M	0	Vm										
31	30	29	28	27	26	25	24	23	22	21	20	19	18	17	16	15	14	13	12	11	10	9	8	7	6	5	4	3	2	1	0
1	1	1	1	0	0	1	0	1	D	size	Vn	Vd	1	0	op	1	N	0	M	0	Vm										

```
if size == '11' then SEE "Related encodings";
if size == '00' || Vd<0> == '1' then UNDEFINED;
add = (op == '0');
scalar_form = FALSE; d = UInt(D:Vd); n = UInt(N:Vn); m = UInt(M:Vm);
esize = 8 << UInt(size); elements = 64 DIV esize;
```

#### Encoding T2/A2 Advanced SIMD

VQD<op><c>.<dt> <Qd>, <Dn>, <Dm[x]>

15	14	13	12	11	10	9	8	7	6	5	4	3	2	1	0	15	14	13	12	11	10	9	8	7	6	5	4	3	2	1	0
1	1	1	0	1	1	1	1	1	D	size	Vn	Vd	0	op	1	1	N	1	M	0	Vm										
31	30	29	28	27	26	25	24	23	22	21	20	19	18	17	16	15	14	13	12	11	10	9	8	7	6	5	4	3	2	1	0
1	1	1	1	0	0	1	0	1	D	size	Vn	Vd	0	op	1	1	N	1	M	0	Vm										

```
if size == '11' then SEE "Related encodings";
if size == '00' || Vd<0> == '1' then UNDEFINED;
add = (op == '0');
scalar_form = TRUE; d = UInt(D:Vd); n = UInt(N:Vn);
if size == '01' then esize = 16; elements = 4; m = UInt(Vm<2:0>); index = UInt(M:Vm<3>);
if size == '10' then esize = 32; elements = 2; m = UInt(Vm); index = UInt(M);
```

**Related encodings** See [Advanced SIMD data-processing instructions on page A7-261](#).

## Assembler syntax

```
VQD<op>{<c>}{<q>}.<dt> <Qd>, <Dn>, <Dm>
VQD<op>{<c>}{<q>}.<dt> <Qd>, <Dn>, <Dm[x]>
```

where:

<op>	The operation. It must be one of: MLAL        Encoded as op = 0. MLSL        Encoded as op = 1.
<c>, <q>	See <a href="#">Standard assembler syntax fields on page A8-287</a> . An ARM VQDMLAL or VQDMLSL instruction must be unconditional. ARM strongly recommends that a Thumb VQDMLAL or VQDMLSL instruction is unconditional, see <a href="#">Conditional execution on page A8-288</a> .
<dt>	The data type for the elements of the operands. It must be one of: S16         Encoded as size = 0b01. S32         Encoded as size = 0b10.
<Qd>, <Dn>	The destination vector and the first operand vector.
<Dm>	The second operand vector, for an all vector operation.
<Dm[x]>	The scalar for a scalar operation. If <dt> is S16, Dm is restricted to D0-D7. If <dt> is S32, Dm is restricted to D0-D15.

## Operation

```
if ConditionPassed() then
    EncodingSpecificOperations(); CheckAdvSIMDEnabled();
    if scalar_form then op2 = SInt(Elem[Din[m],index,esize]);
    for e = 0 to elements-1
        if !scalar_form then op2 = SInt(Elem[Din[m],e,esize]);
        op1 = SInt(Elem[Din[n],e,esize]);
        // The following only saturates if both op1 and op2 equal -(2^(esize-1))
        (product, sat1) = SignedSatQ(2*op1*op2, 2*esize);
        if add then
            result = SInt(Elem[Qin[d>>1],e,2*esize]) + SInt(product);
        else
            result = SInt(Elem[Qin[d>>1],e,2*esize]) - SInt(product);
        (Elem[Q[d>>1],e,2*esize], sat2) = SignedSatQ(result, 2*esize);
        if sat1 || sat2 then FPSCR.QC = '1';
```

## Exceptions

Undefined Instruction, Hyp Trap.

### A8.8.372 VQDMULH

Vector Saturating Doubling Multiply Returning High Half multiplies corresponding elements in two vectors, doubles the results, and places the most significant half of the final results in the destination vector. The results are truncated (for rounded results see *VQRDMULH* on page A8-1008).

The second operand can be a scalar instead of a vector. For more information about scalars see *Advanced SIMD scalars* on page A7-260.

If any of the results overflow, they are saturated. The cumulative saturation bit, *FPSCR.QC*, is set if saturation occurs. For details see *Pseudocode details of saturation* on page A2-44.

Depending on settings in the *CPACR*, *NSACR*, and *HCPTR* registers, and the security state and mode in which the instruction is executed, an attempt to execute the instruction might be UNDEFINED, or trapped to Hyp mode. *Summary of access controls for Advanced SIMD functionality* on page B1-1232 summarizes these controls.

ARM deprecates the conditional execution of any Advanced SIMD instruction encoding that is not also available as a VFP instruction encoding, see *Conditional execution* on page A8-288.

#### Encoding T1/A1 Advanced SIMD

VQDMULH<c>.<dt> <Qd>, <Qn>, <Qm>

VQDMULH<c>.<dt> <Dd>, <Dn>, <Dm>

15	14	13	12	11	10	9	8	7	6	5	4	3	2	1	0	15	14	13	12	11	10	9	8	7	6	5	4	3	2	1	0
1	1	1	0	1	1	1	1	0	D	size	Vn	Vd	1	0	1	1	N	Q	M	0	Vm										

31	30	29	28	27	26	25	24	23	22	21	20	19	18	17	16	15	14	13	12	11	10	9	8	7	6	5	4	3	2	1	0
1	1	1	1	0	0	1	0	0	D	size	Vn	Vd	1	0	1	1	N	Q	M	0	Vm										

```
if Q == '1' && (Vd<0> == '1' || Vn<0> == '1' || Vm<0> == '1') then UNDEFINED;
if size == '00' || size == '11' then UNDEFINED;
scalar_form = FALSE; esize = 8 << UInt(size); elements = 64 DIV esize;
d = UInt(D:Vd); n = UInt(N:Vn); m = UInt(M:Vm); regs = if Q == '0' then 1 else 2;
```

#### Encoding T2/A2 Advanced SIMD

VQDMULH<c>.<dt> <Qd>, <Qn>, <Dm[x]>

VQDMULH<c>.<dt> <Dd>, <Dn>, <Dm[x]>

15	14	13	12	11	10	9	8	7	6	5	4	3	2	1	0	15	14	13	12	11	10	9	8	7	6	5	4	3	2	1	0
1	1	1	Q	1	1	1	1	1	D	size	Vn	Vd	1	1	0	0	N	1	M	0	Vm										

31	30	29	28	27	26	25	24	23	22	21	20	19	18	17	16	15	14	13	12	11	10	9	8	7	6	5	4	3	2	1	0
1	1	1	1	0	0	1	Q	1	D	size	Vn	Vd	1	1	0	0	N	1	M	0	Vm										

```
if size == '11' then SEE "Related encodings";
if size == '00' then UNDEFINED;
if Q == '1' && (Vd<0> == '1' || Vn<0> == '1') then UNDEFINED;
scalar_form = TRUE; d = UInt(D:Vd); n = UInt(N:Vn); regs = if Q == '0' then 1 else 2;
if size == '01' then esize = 16; elements = 4; m = UInt(Vm<2:0>); index = UInt(M:Vm<3>);
if size == '10' then esize = 32; elements = 2; m = UInt(Vm); index = UInt(M);
```

**Related encodings** See *Advanced SIMD data-processing instructions* on page A7-261.

## Assembler syntax

VQDMULH{<c>}{<q>}.<dt> {<Qd>}, <Qn>, <Qm>	Encoding T1/A1, encoded as Q = 1
VQDMULH{<c>}{<q>}.<dt> {<Dd>}, <Dn>, <Dm>	Encoding T1/A1, encoded as Q = 0
VQDMULH{<c>}{<q>}.<dt> {<Qd>}, <Qn>, <Dm[x]>	Encoding T2/A2, encoded as Q = 1
VQDMULH{<c>}{<q>}.<dt> {<Dd>}, <Dn>, <Dm[x]>	Encoding T2/A2, encoded as Q = 0

where:

<c>, <q>	See <a href="#">Standard assembler syntax fields on page A8-287</a> . An ARM VQDMULH instruction must be unconditional. ARM strongly recommends that a Thumb VQDMULH instruction is unconditional, see <a href="#">Conditional execution on page A8-288</a> .
<dt>	The data type for the elements of the operands. It must be one of: S16 Encoded as size = 0b01. S32 Encoded as size = 0b10.
<Qd>, <Qn>	The destination vector and the first operand vector, for a quadword operation.
<Dd>, <Dn>	The destination vector and the first operand vector, for a doubleword operation.
<Qm>	The second operand vector, for a quadword all vector operation.
<Dm>	The second operand vector, for a doubleword all vector operation.
<Dm[x]>	The scalar for either a quadword or a doubleword scalar operation. If <dt> is S16, Dm is restricted to D0-D7. If <dt> is S32, Dm is restricted to D0-D15.

## Operation

```

if ConditionPassed() then
    EncodingSpecificOperations(); CheckAdvSIMDEnabled();
    if scalar_form then op2 = SInt(Elem[D[m],index,esize]);
    for r = 0 to regs-1
        for e = 0 to elements-1
            if !scalar_form then op2 = SInt(Elem[D[m+r],e,esize]);
            op1 = SInt(Elem[D[n+r],e,esize]);
            // The following only saturates if both op1 and op2 equal -(2^(esize-1))
            (result, sat) = SignedSatQ((2*op1*op2) >> esize, esize);
            Elem[D[d+r],e,esize] = result;
            if sat then FPSCR.QC = '1';

```

## Exceptions

Undefined Instruction, Hyp Trap.

### A8.8.373 VQDMULL

Vector Saturating Doubling Multiply Long multiplies corresponding elements in two doubleword vectors, doubles the products, and places the results in a quadword vector.

The second operand can be a scalar instead of a vector. For more information about scalars see [Advanced SIMD scalars](#) on page A7-260.

If any of the results overflow, they are saturated. The cumulative saturation bit, `FPSCR.QC`, is set if saturation occurs. For details see [Pseudocode details of saturation](#) on page A2-44.

Depending on settings in the `CPACR`, `NSACR`, and `HCPTR` registers, and the security state and mode in which the instruction is executed, an attempt to execute the instruction might be UNDEFINED, or trapped to Hyp mode. [Summary of access controls for Advanced SIMD functionality](#) on page B1-1232 summarizes these controls.

ARM deprecates the conditional execution of any Advanced SIMD instruction encoding that is not also available as a VFP instruction encoding, see [Conditional execution](#) on page A8-288.

#### Encoding T1/A1 Advanced SIMD

VQDMULL<c>.<dt> <Qd>, <Dn>, <Dm>

15	14	13	12	11	10	9	8	7	6	5	4	3	2	1	0	15	14	13	12	11	10	9	8	7	6	5	4	3	2	1	0
1	1	1	0	1	1	1	1	1	D	size	Vn	Vd	1	1	0	1	N	0	M	0	Vm										
31	30	29	28	27	26	25	24	23	22	21	20	19	18	17	16	15	14	13	12	11	10	9	8	7	6	5	4	3	2	1	0
1	1	1	1	0	0	1	0	1	D	size	Vn	Vd	1	1	0	1	N	0	M	0	Vm										

```
if size == '11' then SEE "Related encodings";
if size == '00' || Vd<0> == '1' then UNDEFINED;
scalar_form = FALSE; d = UInt(D:Vd); n = UInt(N:Vn); m = UInt(M:Vm);
esize = 8 << UInt(size); elements = 64 DIV esize;
```

#### Encoding T2/A2 Advanced SIMD

VQDMULL<c>.<dt> <Qd>, <Dn>, <Dm[x]>

15	14	13	12	11	10	9	8	7	6	5	4	3	2	1	0	15	14	13	12	11	10	9	8	7	6	5	4	3	2	1	0
1	1	1	0	1	1	1	1	1	D	size	Vn	Vd	1	0	1	1	N	1	M	0	Vm										
31	30	29	28	27	26	25	24	23	22	21	20	19	18	17	16	15	14	13	12	11	10	9	8	7	6	5	4	3	2	1	0
1	1	1	1	0	0	1	0	1	D	size	Vn	Vd	1	0	1	1	N	1	M	0	Vm										

```
if size == '11' then SEE "Related encodings";
if size == '00' || Vd<0> == '1' then UNDEFINED;
scalar_form = TRUE; d = UInt(D:Vd); n = UInt(N:Vn);
if size == '01' then esize = 16; elements = 4; m = UInt(Vm<2:0>); index = UInt(M:Vm<3>);
if size == '10' then esize = 32; elements = 2; m = UInt(Vm); index = UInt(M);
```

**Related encodings** See [Advanced SIMD data-processing instructions](#) on page A7-261.

## Assembler syntax

```
VQDMULL{<c>}{<q>}.<dt> <Qd>, <Dn>, <Dm>
VQDMULL{<c>}{<q>}.<dt> <Qd>, <Dn>, <Dm[x]>
```

where:

<c>, <q> See [Standard assembler syntax fields on page A8-287](#). An ARM VQDMULL instruction must be unconditional. ARM strongly recommends that a Thumb VQDMULL instruction is unconditional, see [Conditional execution on page A8-288](#).

<dt> The data type for the elements of the operands. It must be one of:

S16	Encoded as size = 0b01.
S32	Encoded as size = 0b10.

<Qd>, <Dn> The destination vector and the first operand vector.

<Dm> The second operand vector, for an all vector operation.

<Dm[x]> The scalar for a scalar operation. If <dt> is S16, Dm is restricted to D0-D7. If <dt> is S32, Dm is restricted to D0-D15.

## Operation

```
if ConditionPassed() then
    EncodingSpecificOperations(); CheckAdvSIMDEnabled();
    if scalar_form then op2 = SInt(Elem[Din[m],index,esize]);
    for e = 0 to elements-1
        if !scalar_form then op2 = SInt(Elem[Din[m],e,esize]);
        op1 = SInt(Elem[Din[n],e,esize]);
        // The following only saturates if both op1 and op2 equal -(2^(esize-1))
        (product, sat) = SignedSatQ(2*op1*op2, 2*esize);
        Elem[Q[d>>1],e,2*esize] = product;
        if sat then FPSCR.QC = '1';
```

## Exceptions

Undefined Instruction, Hyp Trap.

### A8.8.374 VQMOVN, VQMOVUN

Vector Saturating Move and Narrow copies each element of the operand vector to the corresponding element of the destination vector.

The operand is a quadword vector. The elements can be any one of:

- 16-bit, 32-bit, or 64-bit signed integers
- 16-bit, 32-bit, or 64-bit unsigned integers.

The result is a doubleword vector. The elements are half the length of the operand vector elements. If the operand is unsigned, the results are unsigned. If the operand is signed, the results can be signed or unsigned.

If any of the results overflow, they are saturated. The cumulative saturation bit, `FPSCR.QC`, is set if saturation occurs. For details see [Pseudocode details of saturation on page A2-44](#).

Depending on settings in the `CPACR`, `NSACR`, and `HCPTR` registers, and the security state and mode in which the instruction is executed, an attempt to execute the instruction might be UNDEFINED, or trapped to Hyp mode. [Summary of access controls for Advanced SIMD functionality on page B1-1232](#) summarizes these controls.

ARM deprecates the conditional execution of any Advanced SIMD instruction encoding that is not also available as a VFP instruction encoding, see [Conditional execution on page A8-288](#).

#### Encoding T1/A1 Advanced SIMD

VQMOV{U}N<c>.<type><size> <Dd>, <Qm>

15	14	13	12	11	10	9	8	7	6	5	4	3	2	1	0	15	14	13	12	11	10	9	8	7	6	5	4	3	2	1	0
1	1	1	1	1	1	1	1	1	D	1	1	size	1	0	Vd	0	0	1	0	op	M	0	Vm								
31	30	29	28	27	26	25	24	23	22	21	20	19	18	17	16	15	14	13	12	11	10	9	8	7	6	5	4	3	2	1	0
1	1	1	1	0	0	1	1	1	D	1	1	size	1	0	Vd	0	0	1	0	op	M	0	Vm								

```

if op == '00' then SEE VMOVN;
if size == '11' || Vm<0> == '1' then UNDEFINED;
src_unsigned = (op == '11'); dest_unsigned = (op<0> == '1');
esize = 8 << UInt(size); elements = 64 DIV esize;
d = UInt(D:Vd); m = UInt(M:Vm);

```



## Assembler syntax

VQMOV{U}N{<c>}{<q>}.<type><size> <Dd>, <Qm>

where:

U	If present, specifies that the operation produces unsigned results, even though the operands are signed. Encoded as <code>op = 0b01</code> .						
<c>, <q>	See <i>Standard assembler syntax fields</i> on page A8-287. An ARM VQMOVN or VQMOVUN instruction must be unconditional. ARM strongly recommends that a Thumb VQMOVN or VQMOVUN instruction is unconditional, see <i>Conditional execution</i> on page A8-288.						
<type>	The data type for the elements of the operand. It must be one of: <table> <tr> <td>S</td> <td>Encoded as: <ul style="list-style-type: none"> <li>• <code>op = 0b10</code> for VQMOVN.</li> <li>• <code>op = 0b01</code> for VQMOVUN.</li> </ul> </td> </tr> <tr> <td>U</td> <td>Encoded as <code>op = 0b11</code>. Not available for VQMOVUN.</td> </tr> </table>	S	Encoded as: <ul style="list-style-type: none"> <li>• <code>op = 0b10</code> for VQMOVN.</li> <li>• <code>op = 0b01</code> for VQMOVUN.</li> </ul>	U	Encoded as <code>op = 0b11</code> . Not available for VQMOVUN.		
S	Encoded as: <ul style="list-style-type: none"> <li>• <code>op = 0b10</code> for VQMOVN.</li> <li>• <code>op = 0b01</code> for VQMOVUN.</li> </ul>						
U	Encoded as <code>op = 0b11</code> . Not available for VQMOVUN.						
<size>	The data size for the elements of the operand. It must be one of: <table> <tr> <td>16</td> <td>Encoded as <code>size = 0b00</code>.</td> </tr> <tr> <td>32</td> <td>Encoded as <code>size = 0b01</code>.</td> </tr> <tr> <td>64</td> <td>Encoded as <code>size = 0b10</code>.</td> </tr> </table>	16	Encoded as <code>size = 0b00</code> .	32	Encoded as <code>size = 0b01</code> .	64	Encoded as <code>size = 0b10</code> .
16	Encoded as <code>size = 0b00</code> .						
32	Encoded as <code>size = 0b01</code> .						
64	Encoded as <code>size = 0b10</code> .						
<Dd>, <Qm>	The destination vector and the operand vector.						

## Operation

```
if ConditionPassed() then
    EncodingSpecificOperations(); CheckAdvSIMDEnabled();
    for e = 0 to elements-1
        operand = Int(Elem[Qin[m]>1],e,2*esize], src_unsigned);
        (Elem[D[d],e,esize], sat) = SatQ(operand, esize, dest_unsigned);
        if sat then FPSCR.QC = '1';
```

## Exceptions

Undefined Instruction, Hyp Trap.

### A8.8.375 VQNEG

Vector Saturating Negate negates each element in a vector, and places the results in the destination vector.

If any of the results overflow, they are saturated. The cumulative saturation bit, `FPSCR.QC`, is set if saturation occurs. For details see [Pseudocode details of saturation on page A2-44](#).

Depending on settings in the `CPACR`, `NSACR`, and `HCPTR` registers, and the security state and mode in which the instruction is executed, an attempt to execute the instruction might be UNDEFINED, or trapped to Hyp mode. [Summary of access controls for Advanced SIMD functionality on page B1-1232](#) summarizes these controls.

ARM deprecates the conditional execution of any Advanced SIMD instruction encoding that is not also available as a VFP instruction encoding, see [Conditional execution on page A8-288](#).

#### Encoding T1/A1 Advanced SIMD

VQNEG<c>.<dt> <Qd>, <Qm>

VQNEG<c>.<dt> <Dd>, <Dm>

15	14	13	12	11	10	9	8	7	6	5	4	3	2	1	0	15	14	13	12	11	10	9	8	7	6	5	4	3	2	1	0
1	1	1	1	1	1	1	1	D	1	1	size	0	0			Vd	0	1	1	1	1	Q	M	0		Vm					

31	30	29	28	27	26	25	24	23	22	21	20	19	18	17	16	15	14	13	12	11	10	9	8	7	6	5	4	3	2	1	0
1	1	1	1	0	0	1	1	1	D	1	1	size	0	0		Vd	0	1	1	1	1	Q	M	0		Vm					

```

if size == '11' then UNDEFINED;
if Q == '1' && (Vd<0> == '1' || Vm<0> == '1') then UNDEFINED;
esize = 8 << UInt(size); elements = 64 DIV esize;
d = UInt(D:Vd); m = UInt(M:Vm); regs = if Q == '0' then 1 else 2;

```

## Assembler syntax

VQNEG{<c>}{<q>}.<dt> <Qd>, <Qm> Encoded as Q = 1  
VQNEG{<c>}{<q>}.<dt> <Dd>, <Dm> Encoded as Q = 0

where:

<c>, <q> See [Standard assembler syntax fields on page A8-287](#). An ARM VQNEG instruction must be unconditional. ARM strongly recommends that a Thumb VQNEG instruction is unconditional, see [Conditional execution on page A8-288](#).

<dt> The data type for the elements of the vectors. It must be one of:  
S8 Encoded as size = 0b00.  
S16 Encoded as size = 0b01.  
S32 Encoded as size = 0b10.

<Qd>, <Qm> The destination vector and the operand vector, for a quadword operation.

<Dd>, <Dm> The destination vector and the operand vector, for a doubleword operation.

## Operation

```
if ConditionPassed() then
    EncodingSpecificOperations(); CheckAdvSIMDEnabled();
    for r = 0 to regs-1
        for e = 0 to elements-1
            result = -SInt(Elem[D[m+r],e,esize]);
            (Elem[D[d+r],e,esize], sat) = SignedSatQ(result, esize);
            if sat then FPSCR.QC = '1';
```

## Exceptions

Undefined Instruction, Hyp Trap.

### A8.8.376 VQRDMULH

Vector Saturating Rounding Doubling Multiply Returning High Half multiplies corresponding elements in two vectors, doubles the results, and places the most significant half of the final results in the destination vector. The results are rounded (for truncated results see [VQDMULH](#) on page A8-1000).

The second operand can be a scalar instead of a vector. For more information about scalars see [Advanced SIMD scalars](#) on page A7-260.

If any of the results overflow, they are saturated. The cumulative saturation bit, `FPSCR.QC`, is set if saturation occurs. For details see [Pseudocode details of saturation](#) on page A2-44.

Depending on settings in the `CPACR`, `NSACR`, and `HCPTR` registers, and the security state and mode in which the instruction is executed, an attempt to execute the instruction might be UNDEFINED, or trapped to Hyp mode. [Summary of access controls for Advanced SIMD functionality](#) on page B1-1232 summarizes these controls.

ARM deprecates the conditional execution of any Advanced SIMD instruction encoding that is not also available as a VFP instruction encoding, see [Conditional execution](#) on page A8-288.

#### Encoding T1/A1 Advanced SIMD

VQRDMULH<c>.<dt> <Qd>, <Qn>, <Qm>

VQRDMULH<c>.<dt> <Dd>, <Dn>, <Dm>

15	14	13	12	11	10	9	8	7	6	5	4	3	2	1	0	15	14	13	12	11	10	9	8	7	6	5	4	3	2	1	0
1	1	1	1	1	1	1	1	0	D	size		Vn		Vd	1	0	1	1	N	Q	M	0		Vm							

31	30	29	28	27	26	25	24	23	22	21	20	19	18	17	16	15	14	13	12	11	10	9	8	7	6	5	4	3	2	1	0
1	1	1	1	0	0	1	1	0	D	size		Vn		Vd	1	0	1	1	N	Q	M	0		Vm							

```
if Q == '1' && (Vd<0> == '1' || Vn<0> == '1' || Vm<0> == '1') then UNDEFINED;
if size == '00' || size == '11' then UNDEFINED;
scalar_form = FALSE; esize = 8 << UInt(size); elements = 64 DIV esize;
d = UInt(D:Vd); n = UInt(N:Vn); m = UInt(M:Vm); regs = if Q == '0' then 1 else 2;
```

#### Encoding T2/A2 Advanced SIMD

VQRDMULH<c>.<dt> <Qd>, <Qn>, <Dm[x]>

VQRDMULH<c>.<dt> <Dd>, <Dn>, <Dm[x]>

15	14	13	12	11	10	9	8	7	6	5	4	3	2	1	0	15	14	13	12	11	10	9	8	7	6	5	4	3	2	1	0
1	1	1	Q	1	1	1	1	1	D	size		Vn		Vd	1	1	0	1	N	1	M	0		Vm							

31	30	29	28	27	26	25	24	23	22	21	20	19	18	17	16	15	14	13	12	11	10	9	8	7	6	5	4	3	2	1	0
1	1	1	1	0	0	1	Q	1	D	size		Vn		Vd	1	1	0	1	N	1	M	0		Vm							

```
if size == '11' then SEE "Related encodings";
if size == '00' then UNDEFINED;
if Q == '1' && (Vd<0> == '1' || Vn<0> == '1') then UNDEFINED;
scalar_form = TRUE; d = UInt(D:Vd); n = UInt(N:Vn); regs = if Q == '0' then 1 else 2;
if size == '01' then esize = 16; elements = 4; m = UInt(Vm<2:0>); index = UInt(M:Vm<3>);
if size == '10' then esize = 32; elements = 2; m = UInt(Vm); index = UInt(M);
```

**Related encodings** See [Advanced SIMD data-processing instructions](#) on page A7-261.

## Assembler syntax

VQRDMULH{<c>}{<q>}.<dt> {<Qd>}, <Qn>, <Qm>	Encoding T1/A1, encoded as Q = 1
VQRDMULH{<c>}{<q>}.<dt> {<Dd>}, <Dn>, <Dm>	Encoding T1/A1, encoded as Q = 0
VQRDMULH{<c>}{<q>}.<dt> {<Qd>}, <Qn>, <Dm[x]>	Encoding T2/A2, encoded as Q = 1
VQRDMULH{<c>}{<q>}.<dt> {<Dd>}, <Dn>, <Dm[x]>	Encoding T2/A2, encoded as Q = 0

where:

<c>, <q>	See <a href="#">Standard assembler syntax fields on page A8-287</a> . An ARM VQRDMULH instruction must be unconditional. ARM strongly recommends that a Thumb VQRDMULH instruction is unconditional, see <a href="#">Conditional execution on page A8-288</a> .
<dt>	The data type for the elements of the operands. It must be one of: S16 Encoded as size = 0b01. S32 Encoded as size = 0b10.
<Qd>, <Qn>	The destination vector and the first operand vector, for a quadword operation.
<Dd>, <Dn>	The destination vector and the first operand vector, for a doubleword operation.
<Qm>	The second operand vector, for a quadword all vector operation.
<Dm>	The second operand vector, for a doubleword all vector operation.
<Dm[x]>	The scalar for either a quadword or a doubleword scalar operation. If <dt> is S16, Dm is restricted to D0-D7. If <dt> is S32, Dm is restricted to D0-D15.

## Operation

```

if ConditionPassed() then
    EncodingSpecificOperations(); CheckAdvSIMDEnabled();
    round_const = 1 << (esize-1);
    if scalar_form then op2 = SInt(Elem[D[m],index,esize]);
    for r = 0 to regs-1
        for e = 0 to elements-1
            op1 = SInt(Elem[D[n+r],e,esize]);
            if !scalar_form then op2 = SInt(Elem[D[m+r],e,esize]);
            (result, sat) = SignedSatQ((2*op1*op2 + round_const) >> esize, esize);
            Elem[D[d+r],e,esize] = result;
            if sat then FPSCR.QC = '1';

```

## Exceptions

Undefined Instruction, Hyp Trap.

### A8.8.377 VQRSHL

Vector Saturating Rounding Shift Left takes each element in a vector, shifts them by a value from the least significant byte of the corresponding element of a second vector, and places the results in the destination vector. If the shift value is positive, the operation is a left shift. Otherwise, it is a right shift.

For truncated results see [VQSHL \(register\)](#) on page A8-1014.

The first operand and result elements are the same data type, and can be any one of:

- 8-bit, 16-bit, 32-bit, or 64-bit signed integers
- 8-bit, 16-bit, 32-bit, or 64-bit unsigned integers.

The second operand is a signed integer of the same size.

If any of the results overflow, they are saturated. The cumulative saturation bit, `FPSCR.QC`, is set if saturation occurs. For details see [Pseudocode details of saturation](#) on page A2-44.

Depending on settings in the `CPACR`, `NSACR`, and `HCPTR` registers, and the security state and mode in which the instruction is executed, an attempt to execute the instruction might be UNDEFINED, or trapped to Hyp mode. [Summary of access controls for Advanced SIMD functionality](#) on page B1-1232 summarizes these controls.

ARM deprecates the conditional execution of any Advanced SIMD instruction encoding that is not also available as a VFP instruction encoding, see [Conditional execution](#) on page A8-288.

#### Encoding T1/A1 Advanced SIMD

VQRSHL<c>.<type><size> <Qd>, <Qm>, <Qn>

VQRSHL<c>.<type><size> <Dd>, <Dm>, <Dn>

15	14	13	12	11	10	9	8	7	6	5	4	3	2	1	0	15	14	13	12	11	10	9	8	7	6	5	4	3	2	1	0
1	1	1	U	1	1	1	1	0	D	size	Vn	Vd	0	1	0	1	N	Q	M	1	Vm										

31	30	29	28	27	26	25	24	23	22	21	20	19	18	17	16	15	14	13	12	11	10	9	8	7	6	5	4	3	2	1	0
1	1	1	1	0	0	1	U	0	D	size	Vn	Vd	0	1	0	1	N	Q	M	1	Vm										

```

if Q == '1' && (Vd<0> == '1' || Vm<0> == '1' || Vn<0> == '1') then UNDEFINED;
unsigned = (U == '1');
esize = 8 << UInt(size); elements = 64 DIV esize;
d = UInt(D:Vd); m = UInt(M:Vm); n = UInt(N:Vn); regs = if Q == '0' then 1 else 2;

```

## Assembler syntax

VQRSHL{<c>}{<q>}.<type><size> {<Qd>}, <Qm>, <Qn> Encoded as Q = 1  
VQRSHL{<c>}{<q>}.<type><size> {<Dd>}, <Dm>, <Dn> Encoded as Q = 0

where:

<c>, <q> See [Standard assembler syntax fields on page A8-287](#). An ARM VQRSHL instruction must be unconditional. ARM strongly recommends that a Thumb VQRSHL instruction is unconditional, see [Conditional execution on page A8-288](#).

<type> The data type for the elements of the vectors. It must be one of:  
S Signed, encoded as U = 0.  
U Unsigned, encoded as U = 1.  
Together with the <size> field, this indicates the data type and size of the first operand and the result.

<size> The data size for the elements of the vectors. It must be one of:  
8 Encoded as size = 0b00.  
16 Encoded as size = 0b01.  
32 Encoded as size = 0b10.  
64 Encoded as size = 0b11.

<Qd>, <Qm>, <Qn> The destination vector and the operand vectors, for a quadword operation.

<Dd>, <Dm>, <Dn> The destination vector and the operand vectors, for a doubleword operation.

## Operation

```
if ConditionPassed() then
    EncodingSpecificOperations(); CheckAdvSIMDEnabled();
    for r = 0 to regs-1
        for e = 0 to elements-1
            shift = SInt(Elem[D[n+r],e,esize]<7:0>);
            round_const = 1 << (-1-shift); // 0 for left shift, 2^(n-1) for right shift
            operand = Int(Elem[D[m+r],e,esize], unsigned);
            (result, sat) = SatQ((operand + round_const) << shift, esize, unsigned);
            Elem[D[d+r],e,esize] = result;
            if sat then FPSCR.QC = '1';
```

## Exceptions

Undefined Instruction, Hyp Trap.

### A8.8.378 VQRSHRN, VQRSHRUN

Vector Saturating Rounding Shift Right, Narrow takes each element in a quadword vector of integers, right shifts them by an immediate value, and places the rounded results in a doubleword vector.

For truncated results, see [VQSHRN, VQSHRUN on page A8-1018](#).

The operand elements must all be the same size, and can be any one of:

- 16-bit, 32-bit, or 64-bit signed integers
- 16-bit, 32-bit, or 64-bit unsigned integers.

The result elements are half the width of the operand elements. If the operand elements are signed, the results can be either signed or unsigned. If the operand elements are unsigned, the result elements must also be unsigned.

If any of the results overflow, they are saturated. The cumulative saturation bit, `FPSCR.QC`, is set if saturation occurs. For details see [Pseudocode details of saturation on page A2-44](#).

Depending on settings in the `CPACR`, `NSACR`, and `HCPTR` registers, and the security state and mode in which the instruction is executed, an attempt to execute the instruction might be UNDEFINED, or trapped to Hyp mode. [Summary of access controls for Advanced SIMD functionality on page B1-1232](#) summarizes these controls.

ARM deprecates the conditional execution of any Advanced SIMD instruction encoding that is not also available as a VFP instruction encoding, see [Conditional execution on page A8-288](#).

#### Encoding T1/A1 Advanced SIMD

VQRSHR{U}N<c>.<type><size> <Dd>, <Qm>, #<imm>

15	14	13	12	11	10	9	8	7	6	5	4	3	2	1	0	15	14	13	12	11	10	9	8	7	6	5	4	3	2	1	0
1	1	1	U	1	1	1	1	1	D	imm6						Vd	1	0	0	op	0	1	M	1	Vm						
31	30	29	28	27	26	25	24	23	22	21	20	19	18	17	16	15	14	13	12	11	10	9	8	7	6	5	4	3	2	1	0
1	1	1	1	0	0	1	U	1	D	imm6						Vd	1	0	0	op	0	1	M	1	Vm						

```

if imm6 IN "000xxx" then SEE "Related encodings";
if U == '0' && op == '0' then SEE VRSHRN;
if Vm<0> == '1' then UNDEFINED;
case imm6 of
  when "001xxx" esize = 8; elements = 8; shift_amount = 16 - UInt(imm6);
  when "01xxxx" esize = 16; elements = 4; shift_amount = 32 - UInt(imm6);
  when "1xxxxx" esize = 32; elements = 2; shift_amount = 64 - UInt(imm6);
src_unsigned = (U == '1' && op == '1'); dest_unsigned = (U == '1');
d = UInt(D:Vd); m = UInt(M:Vm);

```

**Related encodings** See [One register and a modified immediate value on page A7-269](#).



## Assembler syntax

VQRSHR{U}N{<c>}{<q>}.<type><size> <Dd>, <Qm>, #<imm>

where:

U	If present, specifies that the results are unsigned, although the operands are signed.
<c>, <q>	See <i>Standard assembler syntax fields on page A8-287</i> . An ARM VQRSHRN or VQRSHRUN instruction must be unconditional. ARM strongly recommends that a Thumb VQRSHRN or VQRSHRUN instruction is unconditional, see <i>Conditional execution on page A8-288</i> .
<type>	The data type for the elements of the vectors. It must be one of: <ul style="list-style-type: none"> <li>S Signed. Encoded as: <ul style="list-style-type: none"> <li>• U = 0, op = 1, for VQRSHRN.</li> <li>• U = 1, op = 0, for VQRSHRUN.</li> </ul> </li> <li>U Unsigned: <ul style="list-style-type: none"> <li>• Encoded as U = 1, op = 1, for VQRSHRN.</li> <li>• Not available for VQRSHRUN.</li> </ul> </li> </ul>
<size>	The data size for the elements of the vectors. It must be one of: <ul style="list-style-type: none"> <li>16 Encoded as imm6&lt;5:3&gt; = 0b001. (8 – &lt;imm&gt;) is encoded in imm6&lt;2:0&gt;.</li> <li>32 Encoded as imm6&lt;5:4&gt; = 0b01. (16 – &lt;imm&gt;) is encoded in imm6&lt;3:0&gt;.</li> <li>64 Encoded as imm6&lt;5&gt; = 0b1. (32 – &lt;imm&gt;) is encoded in imm6&lt;4:0&gt;.</li> </ul>
<Dd>, <Qm>	The destination vector and the operand vector.
<imm>	The immediate value, in the range 1 to <size>/2. See the description of <size> for how <imm> is encoded.

## Operation

```

if ConditionPassed() then
    EncodingSpecificOperations(); CheckAdvSIMDEnabled();
    round_const = 1 << (shift_amount - 1);
    for e = 0 to elements-1
        operand = Int(Elem[Qin[m]>>1],e,2*esize], src_unsigned);
        (result, sat) = SatQ((operand + round_const) >> shift_amount, esize, dest_unsigned);
        Elem[D[d],e,esize] = result;
        if sat then FPSCR.QC = '1';

```

## Exceptions

Undefined Instruction, Hyp Trap.

## Pseudo-instructions

VQRSHRN.I<size> <Dd>, <Qm>, #0	is a synonym for	VQMOVN.I<size> <Dd>, <Qm>
VQRSHRUN.I<size> <Dd>, <Qm>, #0	is a synonym for	VQMOVUN.I<size> <Dd>, <Qm>

### A8.8.379 VQSHL (register)

Vector Saturating Shift Left (register) takes each element in a vector, shifts them by a value from the least significant byte of the corresponding element of a second vector, and places the results in the destination vector. If the shift value is positive, the operation is a left shift. Otherwise, it is a right shift.

The results are truncated. For rounded results, see [VQRSHL on page A8-1010](#).

The first operand and result elements are the same data type, and can be any one of:

- 8-bit, 16-bit, 32-bit, or 64-bit signed integers
- 8-bit, 16-bit, 32-bit, or 64-bit unsigned integers.

The second operand is a signed integer of the same size.

If any of the results overflow, they are saturated. The cumulative saturation bit, `FPSCR.QC`, is set if saturation occurs. For details see [Pseudocode details of saturation on page A2-44](#).

Depending on settings in the `CPACR`, `NSACR`, and `HCPTR` registers, and the security state and mode in which the instruction is executed, an attempt to execute the instruction might be UNDEFINED, or trapped to Hyp mode. [Summary of access controls for Advanced SIMD functionality on page B1-1232](#) summarizes these controls.

ARM deprecates the conditional execution of any Advanced SIMD instruction encoding that is not also available as a VFP instruction encoding, see [Conditional execution on page A8-288](#).

#### Encoding T1/A1 Advanced SIMD

VQSHL<c>.<type><size> <Qd>, <Qm>, <Qn>

VQSHL<c>.<type><size> <Dd>, <Dm>, <Dn>

15	14	13	12	11	10	9	8	7	6	5	4	3	2	1	0	15	14	13	12	11	10	9	8	7	6	5	4	3	2	1	0
1	1	1	U	1	1	1	1	0	D	size		Vn		Vd		0	1	0	0	N	Q	M	1		Vm						

31	30	29	28	27	26	25	24	23	22	21	20	19	18	17	16	15	14	13	12	11	10	9	8	7	6	5	4	3	2	1	0
1	1	1	1	0	0	1	U	0	D	size		Vn		Vd		0	1	0	0	N	Q	M	1		Vm						

```

if Q == '1' && (Vd<0> == '1' || Vm<0> == '1' || Vn<0> == '1') then UNDEFINED;
unsigned = (U == '1');
esize = 8 << UInt(size); elements = 64 DIV esize;
d = UInt(D:Vd); m = UInt(M:Vm); n = UInt(N:Vn); regs = if Q == '0' then 1 else 2;

```

## Assembler syntax

VQSHL{<c>}{<q>}.<type><size> {<Qd>}, <Qm>, <Qn> Encoded as Q = 1  
VQSHL{<c>}{<q>}.<type><size> {<Dd>}, <Dm>, <Dn> Encoded as Q = 0

where:

<c>, <q> See [Standard assembler syntax fields on page A8-287](#). An ARM VQSHL instruction must be unconditional. ARM strongly recommends that a Thumb VQSHL instruction is unconditional, see [Conditional execution on page A8-288](#).

<type> The data type for the elements of the vectors. It must be one of:  
S Signed, encoded as U = 0.  
U Unsigned, encoded as U = 1.  
Together with the <size> field, this indicates the data type and size of the first operand and the result.

<size> The data size for the elements of the vectors. It must be one of:  
8 Encoded as size = 0b00.  
16 Encoded as size = 0b01.  
32 Encoded as size = 0b10.  
64 Encoded as size = 0b11.

<Qd>, <Qm>, <Qn> The destination vector and the operand vectors, for a quadword operation.

<Dd>, <Dm>, <Dn> The destination vector and the operand vectors, for a doubleword operation.

## Operation

```
if ConditionPassed() then
    EncodingSpecificOperations(); CheckAdvSIMDEnabled();
    for r = 0 to regs-1
        for e = 0 to elements-1
            shift = SInt(Elem[D[n+r],e,esize]<7:0>);
            operand = Int(Elem[D[m+r],e,esize], unsigned);
            (result,sat) = SatQ(operand << shift, esize, unsigned);
            Elem[D[d+r],e,esize] = result;
            if sat then FPSCR.QC = '1';
```

## Exceptions

Undefined Instruction, Hyp Trap.

### A8.8.380 VQSHL, VQSHLU (immediate)

Vector Saturating Shift Left (immediate) takes each element in a vector of integers, left shifts them by an immediate value, and places the results in a second vector.

The operand elements must all be the same size, and can be any one of:

- 8-bit, 16-bit, 32-bit, or 64-bit signed integers
- 8-bit, 16-bit, 32-bit, or 64-bit unsigned integers.

The result elements are the same size as the operand elements. If the operand elements are signed, the results can be either signed or unsigned. If the operand elements are unsigned, the result elements must also be unsigned.

If any of the results overflow, they are saturated. The cumulative saturation bit, `FPSCR.QC`, is set if saturation occurs. For details see [Pseudocode details of saturation on page A2-44](#).

Depending on settings in the `CPACR`, `NSACR`, and `HCPTR` registers, and the security state and mode in which the instruction is executed, an attempt to execute the instruction might be UNDEFINED, or trapped to Hyp mode. [Summary of access controls for Advanced SIMD functionality on page B1-1232](#) summarizes these controls.

ARM deprecates the conditional execution of any Advanced SIMD instruction encoding that is not also available as a VFP instruction encoding, see [Conditional execution on page A8-288](#).

#### Encoding T1/A1 Advanced SIMD

VQSHL{U}<c>.<type><size> <Qd>, <Qm>, #<imm>

VQSHL{U}<c>.<type><size> <Dd>, <Dm>, #<imm>

15	14	13	12	11	10	9	8	7	6	5	4	3	2	1	0	15	14	13	12	11	10	9	8	7	6	5	4	3	2	1	0
1	1	1	U	1	1	1	1	1	D	imm6						Vd	0	1	1	op	L	Q	M	1	Vm						

31	30	29	28	27	26	25	24	23	22	21	20	19	18	17	16	15	14	13	12	11	10	9	8	7	6	5	4	3	2	1	0
1	1	1	1	0	0	1	U	1	D	imm6						Vd	0	1	1	op	L	Q	M	1	Vm						

```

if (L:imm6) IN "0000xxx" then SEE "Related encodings";
if U == '0' && op == '0' then UNDEFINED;
if Q == '1' && (Vd<0> == '1' || Vm<0> == '1') then UNDEFINED;
case L:imm6 of
  when "0001xxx" esize = 8; elements = 8; shift_amount = UInt(imm6) - 8;
  when "001xxxx" esize = 16; elements = 4; shift_amount = UInt(imm6) - 16;
  when "01xxxxx" esize = 32; elements = 2; shift_amount = UInt(imm6) - 32;
  when "1xxxxxx" esize = 64; elements = 1; shift_amount = UInt(imm6);
src_unsigned = (U == '1' && op == '1'); dest_unsigned = (U == '1');
d = UInt(D:Vd); m = UInt(M:Vm); regs = if Q == '0' then 1 else 2;

```

**Related encodings** See [One register and a modified immediate value on page A7-269](#).

## Assembler syntax

VQSHL{U}{<c>}{<q>}.<type><size> {<Qd>}, <Qm>, #<imm> Encoded as Q = 1  
VQSHL{U}{<c>}{<q>}.<type><size> {<Dd>}, <Dm>, #<imm> Encoded as Q = 0

where:

U If present, specifies that the results are unsigned, although the operands are signed.

<c>, <q> See [Standard assembler syntax fields on page A8-287](#). An ARM VQSHL or VQSHLU instruction must be unconditional. ARM strongly recommends that a Thumb VQSHL or VQSHLU instruction is unconditional, see [Conditional execution on page A8-288](#).

<type> The data type for the elements of the vectors. It must be one of:  
S Signed. Encoded as:  

- U = 0, op = 1, for VQSHL.
- U = 1, op = 0, for VQSHLU.

U Unsigned:  

- Encoded as U = 1, op = 1, for VQSHL.
- Not available for VQSHLU.

<size> The data size for the elements of the vectors. It must be one of:  
8 Encoded as L = 0, imm6<5:3> = 0b001. <imm> is encoded in imm6<2:0>.  
16 Encoded as L = 0, imm6<5:4> = 0b01. <imm> is encoded in imm6<3:0>.  
32 Encoded as L = 0, imm6<5> = 0b1. <imm> is encoded in imm6<4:0>.  
64 Encoded as L = 1. <imm> is encoded in imm6<5:0>.

<Qd>, <Qm> The destination vector, and the operand vector, for a quadword operation.

<Dd>, <Dm> The destination vector, and the operand vector, for a doubleword operation.

<imm> The immediate value, in the range 0 to <size>-1. See the description of <size> for how <imm> is encoded.

## Operation

```

if ConditionPassed() then
    EncodingSpecificOperations(); CheckAdvSIMDEnabled();
    for r = 0 to regs-1
        for e = 0 to elements-1
            operand = Int(Elem[D[m+r],e,esize], src_unsigned);
            (result, sat) = SatQ(operand << shift_amount, esize, dest_unsigned);
            Elem[D[d+r],e,esize] = result;
            if sat then FPSCR.QC = '1';
    
```

## Exceptions

Undefined Instruction, Hyp Trap.

### A8.8.381 VQSHRN, VQSHRUN

Vector Saturating Shift Right, Narrow takes each element in a quadword vector of integers, right shifts them by an immediate value, and places the truncated results in a doubleword vector.

For rounded results, see *VQRSHRN, VQRSHRUN* on page A8-1012.

The operand elements must all be the same size, and can be any one of:

- 16-bit, 32-bit, or 64-bit signed integers
- 16-bit, 32-bit, or 64-bit unsigned integers.

The result elements are half the width of the operand elements. If the operand elements are signed, the results can be either signed or unsigned. If the operand elements are unsigned, the result elements must also be unsigned.

If any of the results overflow, they are saturated. The cumulative saturation bit, *FPSCR.QC*, is set if saturation occurs. For details see *Pseudocode details of saturation* on page A2-44.

Depending on settings in the *CPACR*, *NSACR*, and *HCPTR* registers, and the security state and mode in which the instruction is executed, an attempt to execute the instruction might be UNDEFINED, or trapped to Hyp mode. *Summary of access controls for Advanced SIMD functionality* on page B1-1232 summarizes these controls.

ARM deprecates the conditional execution of any Advanced SIMD instruction encoding that is not also available as a VFP instruction encoding, see *Conditional execution* on page A8-288.

#### Encoding T1/A1 Advanced SIMD

VQSHR{U}N<c>.<type><size> <Dd>, <Qm>, #<imm>

15	14	13	12	11	10	9	8	7	6	5	4	3	2	1	0	15	14	13	12	11	10	9	8	7	6	5	4	3	2	1	0
1	1	1	U	1	1	1	1	1	D	imm6						Vd	1	0	0	op	0	0	M	1	Vm						
31	30	29	28	27	26	25	24	23	22	21	20	19	18	17	16	15	14	13	12	11	10	9	8	7	6	5	4	3	2	1	0
1	1	1	1	0	0	1	U	1	D	imm6						Vd	1	0	0	op	0	0	M	1	Vm						

```

if imm6 IN "000xxx" then SEE "Related encodings";
if U == '0' && op == '0' then SEE VSHRN;
if Vm<0> == '1' then UNDEFINED;
case imm6 of
  when "001xxx" esize = 8; elements = 8; shift_amount = 16 - UInt(imm6);
  when "01xxxx" esize = 16; elements = 4; shift_amount = 32 - UInt(imm6);
  when "1xxxxx" esize = 32; elements = 2; shift_amount = 64 - UInt(imm6);
src_unsigned = (U == '1' && op == '1'); dest_unsigned = (U == '1');
d = UInt(D:Vd); m = UInt(M:Vm);

```

**Related encodings** See *One register and a modified immediate value* on page A7-269.

## Assembler syntax

VQSHR{U}N{<c>}{<q>}.<type><size> <Dd>, <Qm>, #<imm>

where:

U	If present, specifies that the results are unsigned, although the operands are signed.
<c>, <q>	See <i>Standard assembler syntax fields</i> on page A8-287. An ARM VQSHRN or VQSHRUN instruction must be unconditional. ARM strongly recommends that a Thumb VQSHRN or VQSHRUN instruction is unconditional, see <i>Conditional execution</i> on page A8-288.
<type>	The data type for the elements of the vectors. It must be one of: <ul style="list-style-type: none"> <li>S Signed. Encoded as: <ul style="list-style-type: none"> <li>• U = 0, op = 1, for VQSHRN.</li> <li>• U = 1, op = 0, for VQSHRUN.</li> </ul> </li> <li>U Unsigned: <ul style="list-style-type: none"> <li>• Encoded as U = 1, op = 1, for VQSHRN.</li> <li>• Not available for VQSHRUN.</li> </ul> </li> </ul>
<size>	The data size for the elements of the vectors. It must be one of: <ul style="list-style-type: none"> <li>16 Encoded as imm6&lt;5:3&gt; = 0b001. (8 – &lt;imm&gt;) is encoded in imm6&lt;2:0&gt;.</li> <li>32 Encoded as imm6&lt;5:4&gt; = 0b01. (16 – &lt;imm&gt;) is encoded in imm6&lt;3:0&gt;.</li> <li>64 Encoded as imm6&lt;5&gt; = 0b1. (32 – &lt;imm&gt;) is encoded in imm6&lt;4:0&gt;.</li> </ul>
<Dd>, <Qm>	The destination vector, and the operand vector.
<imm>	The immediate value, in the range 1 to <size>/2. See the description of <size> for how <imm> is encoded.

## Operation

```

if ConditionPassed() then
    EncodingSpecificOperations(); CheckAdvSIMDEnabled();
    for e = 0 to elements-1
        operand = Int(Elem[Qin[m]>>1],e,2*esize], src_unsigned);
        (result, sat) = SatQ(operand >> shift_amount, esize, dest_unsigned);
        Elem[D[d],e,esize] = result;
        if sat then FPSCR.QC = '1';

```

## Exceptions

Undefined Instruction, Hyp Trap.

## Pseudo-instructions

VQSHRN.I<size> <Dd>, <Qm>, #0	is a synonym for	VQMOVN.I<size> <Dd>, <Qm>
VQSHRUN.I<size> <Dd>, <Qm>, #0	is a synonym for	VQMOVUN.I<size> <Dd>, <Qm>

### A8.8.382 VQSUB

Vector Saturating Subtract subtracts the elements of the second operand vector from the corresponding elements of the first operand vector, and places the results in the destination vector. Signed and unsigned operations are distinct.

The operand and result elements must all be the same type, and can be any one of:

- 8-bit, 16-bit, 32-bit, or 64-bit signed integers
- 8-bit, 16-bit, 32-bit, or 64-bit unsigned integers.

If any of the results overflow, they are saturated. The cumulative saturation bit, `FPSCR.QC`, is set if saturation occurs. For details see [Pseudocode details of saturation on page A2-44](#).

Depending on settings in the `CPACR`, `NSACR`, and `HCPTR` registers, and the security state and mode in which the instruction is executed, an attempt to execute the instruction might be UNDEFINED, or trapped to Hyp mode. [Summary of access controls for Advanced SIMD functionality on page B1-1232](#) summarizes these controls.

ARM deprecates the conditional execution of any Advanced SIMD instruction encoding that is not also available as a VFP instruction encoding, see [Conditional execution on page A8-288](#).

#### Encoding T1/A1 Advanced SIMD

VQSUB<c>.<type><size> <Qd>, <Qn>, <Qm>

VQSUB<c>.<type><size> <Dd>, <Dn>, <Dm>

15	14	13	12	11	10	9	8	7	6	5	4	3	2	1	0	15	14	13	12	11	10	9	8	7	6	5	4	3	2	1	0
1	1	1	U	1	1	1	1	0	D	size		Vn		Vd		0	0	1	0	N	Q	M	1		Vm						

31	30	29	28	27	26	25	24	23	22	21	20	19	18	17	16	15	14	13	12	11	10	9	8	7	6	5	4	3	2	1	0
1	1	1	1	0	0	1																									

```

if Q == '1' && (Vd<0> == '1' || Vn<0> == '1' || Vm<0> == '1') then UNDEFINED;
unsigned = (U == '1');
esize = 8 << UInt(size); elements = 64 DIV esize;
d = UInt(D:Vd); n = UInt(N:Vn); m = UInt(M:Vm); regs = if Q == '0' then 1 else 2;

```



## Assembler syntax

VQSUB{<c>}{<q>}.<type><size> {<Qd>}, <Qn>, <Qm> Encoded as Q = 1  
VQSUB{<c>}{<q>}.<type><size> {<Dd>}, <Dn>, <Dm> Encoded as Q = 0

where:

<c>, <q> See [Standard assembler syntax fields on page A8-287](#). An ARM VQSUB instruction must be unconditional. ARM strongly recommends that a Thumb VQSUB instruction is unconditional, see [Conditional execution on page A8-288](#).

<type> The data type for the elements of the vectors. It must be one of:  
S Signed, encoded as U = 0.  
U Unsigned, encoded as U = 1.

<size> The data size for the elements of the vectors. It must be one of:  
8 Encoded as size = 0b00.  
16 Encoded as size = 0b01.  
32 Encoded as size = 0b10.  
64 Encoded as size = 0b11.

<Qd>, <Qn>, <Qm> The destination vector and the operand vectors, for a quadword operation.

<Dd>, <Dn>, <Dm> The destination vector and the operand vectors, for a doubleword operation.

## Operation

```

if ConditionPassed() then
    EncodingSpecificOperations(); CheckAdvSIMDEnabled();
    for r = 0 to regs-1
        for e = 0 to elements-1
            diff = Int(Elem[D[n+r],e,esize], unsigned) - Int(Elem[D[m+r],e,esize], unsigned);
            (Elem[D[d+r],e,esize], sat) = SatQ(diff, esize, unsigned);
            if sat then FPSCR.QC = '1';

```

## Exceptions

Undefined Instruction, Hyp Trap.

### A8.8.383 VRADDHN

Vector Rounding Add and Narrow, returning High Half adds corresponding elements in two quadword vectors, and places the most significant half of each result in a doubleword vector. The results are rounded. (For truncated results, see [VADDHN](#) on page A8-832.)

The operand elements can be 16-bit, 32-bit, or 64-bit integers. There is no distinction between signed and unsigned integers.

Depending on settings in the CPACR, NSACR, and HCPTR registers, and the security state and mode in which the instruction is executed, an attempt to execute the instruction might be UNDEFINED, or trapped to Hyp mode. [Summary of access controls for Advanced SIMD functionality on page B1-1232](#) summarizes these controls.

ARM deprecates the conditional execution of any Advanced SIMD instruction encoding that is not also available as a VFP instruction encoding, see [Conditional execution on page A8-288](#).

#### Encoding T1/A1 Advanced SIMD

VRADDHN<c>.<dt> <Dd>, <Qn>, <Qm>

15	14	13	12	11	10	9	8	7	6	5	4	3	2	1	0	15	14	13	12	11	10	9	8	7	6	5	4	3	2	1	0
1	1	1	1	1	1	1	1	1	D	size	Vn				Vd				0	1	0	0	N	0	M	0	Vm				
31	30	29	28	27	26	25	24	23	22	21	20	19	18	17	16	15	14	13	12	11	10	9	8	7	6	5	4	3	2	1	0
1	1	1	1	0	0	1	1	1	D	size	Vn				Vd				0	1	0	0	N	0	M	0	Vm				

```
if size == '11' then SEE "Related encodings";
if Vn<0> == '1' || Vm<0> == '1' then UNDEFINED;
esize = 8 << UInt(size); elements = 64 DIV esize;
d = UInt(D:Vd); n = UInt(N:Vn); m = UInt(M:Vm);
```

**Related encodings** See [Advanced SIMD data-processing instructions on page A7-261](#).

## Assembler syntax

VRADDHN{<c>}{<q>}.<dt> <Dd>, <Qn>, <Qm>

where:

<c>, <q> See [Standard assembler syntax fields on page A8-287](#). An ARM VRADDHN instruction must be unconditional. ARM strongly recommends that a Thumb VRADDHN instruction is unconditional, see [Conditional execution on page A8-288](#).

<dt> The data type for the elements of the operands. It must be one of:

I16	Encoded as size = 0b00.
I32	Encoded as size = 0b01.
I64	Encoded as size = 0b10.

<Dd>, <Qn>, <Qm> The destination vector and the operand vectors.

## Operation

```

if ConditionPassed() then
    EncodingSpecificOperations(); CheckAdvSIMDEnabled();
    round_const = 1 << (esize-1);
    for e = 0 to elements-1
        result = Elem[Qin[n>>1],e,2*esize] + Elem[Qin[m>>1],e,2*esize] + round_const;
        Elem[D[d],e,esize] = result<2*esize-1:esize>;

```

## Exceptions

Undefined Instruction, Hyp Trap.

### A8.8.384 VRECPE

Vector Reciprocal Estimate finds an approximate reciprocal of each element in the operand vector, and places the results in the destination vector.

The operand and result elements are the same type, and can be 32-bit floating-point numbers, or 32-bit unsigned integers.

For details of the operation performed by this instruction see [Floating-point reciprocal estimate and step on page A2-85](#).

Depending on settings in the CPACR, NSACR, and HCPTR registers, and the security state and mode in which the instruction is executed, an attempt to execute the instruction might be UNDEFINED, or trapped to Hyp mode. [Summary of access controls for Advanced SIMD functionality on page B1-1232](#) summarizes these controls.

ARM deprecates the conditional execution of any Advanced SIMD instruction encoding that is not also available as a VFP instruction encoding, see [Conditional execution on page A8-288](#).

**Encoding T1/A1**      Advanced SIMD (F = 1 UNDEFINED in integer-only variants)

VRECPE<c>.<dt> <Qd>, <Qm>

VRECPE<c>.<dt> <Dd>, <Dm>

15	14	13	12	11	10	9	8	7	6	5	4	3	2	1	0	15	14	13	12	11	10	9	8	7	6	5	4	3	2	1	0
1	1	1	1	1	1	1	1	1	D	1	1	size	1	1		Vd				0	1	0	F	0	Q	M	0		Vm		

31	30	29	28	27	26	25	24	23	22	21	20	19	18	17	16	15	14	13	12	11	10	9	8	7	6	5	4	3	2	1	0
1	1	1	1	0	0	1	1	1	D	1	1	size	1	1		Vd				0	1	0	F	0	Q	M	0		Vm		

```

if Q == '1' && (Vd<0> == '1' || Vm<0> == '1') then UNDEFINED;
if size != '10' then UNDEFINED;
floating_point = (F == '1'); esize = 32; elements = 2;
d = UInt(D:Vd); m = UInt(M:Vm); regs = if Q == '0' then 1 else 2;

```

## Assembler syntax

VRECPE{<c>}{<q>}.<dt> <Qd>, <Qm> Encoded as Q = 1  
VRECPE{<c>}{<q>}.<dt> <Dd>, <Dm> Encoded as Q = 0

where:

<c>, <q> See [Standard assembler syntax fields on page A8-287](#). An ARM VRECPE instruction must be unconditional. ARM strongly recommends that a Thumb VRECPE instruction is unconditional, see [Conditional execution on page A8-288](#).

<dt> The data types for the elements of the vectors. It must be one of:  
U32 Encoded as F = 0, size = 0b10.  
F32 Encoded as F = 1, size = 0b10.

<Qd>, <Qm> The destination vector and the operand vector, for a quadword operation.

<Dd>, <Dm> The destination vector and the operand vector, for a doubleword operation.

## Operation

```

if ConditionPassed() then
    EncodingSpecificOperations(); CheckAdvSIMDEnabled();
    for r = 0 to regs-1
        for e = 0 to elements-1
            if floating_point then
                Elem[D[d+r],e,esize] = FPREcipEstimate(Elem[D[m+r],e,esize]);
            else
                Elem[D[d+r],e,esize] = UnsignedRecipEstimate(Elem[D[m+r],e,esize]);

```

## Exceptions

Undefined Instruction, Hyp Trap.

### ***Floating-point exceptions***

Input Denormal, Invalid Operation, Underflow, Division by Zero.

## Newton-Raphson iteration

For details of the operation performed and how it can be used in a Newton-Raphson iteration to calculate the reciprocal of a number, see [Floating-point reciprocal estimate and step on page A2-85](#).

### A8.8.385 VRECPS

Vector Reciprocal Step multiplies the elements of one vector by the corresponding elements of another vector, subtracts each of the products from 2.0, and places the results into the elements of the destination vector.

The operand and result elements are 32-bit floating-point numbers.

For details of the operation performed by this instruction see [Floating-point reciprocal estimate and step on page A2-85](#).

Depending on settings in the CPACR, NSACR, and HCPTR registers, and the security state and mode in which the instruction is executed, an attempt to execute the instruction might be UNDEFINED, or trapped to Hyp mode. [Summary of access controls for Advanced SIMD functionality on page B1-1232](#) summarizes these controls.

ARM deprecates the conditional execution of any Advanced SIMD instruction encoding that is not also available as a VFP instruction encoding, see [Conditional execution on page A8-288](#).

#### Encoding T1/A1 Advanced SIMD (UNDEFINED in integer-only variant)

VRECPS<c>.F32 <Qd>, <Qn>, <Qm>

VRECPS<c>.F32 <Dd>, <Dn>, <Dm>

15	14	13	12	11	10	9	8	7	6	5	4	3	2	1	0	15	14	13	12	11	10	9	8	7	6	5	4	3	2	1	0
1	1	1	0	1	1	1	1	0	D	0	sz		Vn			Vd		1	1	1	1	N	Q	M	1		Vm				
31	30	29	28	27	26	25	24	23	22	21	20	19	18	17	16	15	14	13	12	11	10	9	8	7	6	5	4	3	2	1	0
1	1	1	1	0	0	1	0	0	D	0	sz		Vn			Vd		1	1	1	1	N	Q	M	1		Vm				

```

if Q == '1' && (Vd<0> == '1' || Vn<0> == '1' || Vm<0> == '1') then UNDEFINED;
if sz == '1' then UNDEFINED;
esize = 32; elements = 2;
d = UInt(D:Vd); n = UInt(N:Vn); m = UInt(M:Vm); regs = if Q == '0' then 1 else 2;

```

## Assembler syntax

VRECPS{<c>}{<q>}.F32 {<Qd>}, <Qn>, <Qm> Encoded as Q = 1  
VRECPS{<c>}{<q>}.F32 {<Dd>}, <Dn>, <Dm> Encoded as Q = 0

where:

<c>, <q> See [Standard assembler syntax fields on page A8-287](#). An ARM VRECPS instruction must be unconditional. ARM strongly recommends that a Thumb VRECPS instruction is unconditional, see [Conditional execution on page A8-288](#).

<Qd>, <Qn>, <Qm> The destination vector and the operand vectors for a quadword operation.

<Dd>, <Dn>, <Dm> The destination vector and the operand vectors for a doubleword operation.

## Operation

```
if ConditionPassed() then
    EncodingSpecificOperations(); CheckAdvSIMDEnabled();
    for r = 0 to regs-1
        for e = 0 to elements-1
            Elem[D[d+r],e,esize] = FPREcipStep(Elem[D[n+r],e,esize], Elem[D[m+r],e,esize]);
```

## Exceptions

Undefined Instruction, Hyp Trap.

### *Floating-point exceptions*

Input Denormal, Invalid Operation, Overflow, Underflow, Inexact.

## Newton-Raphson iteration

For details of the operation performed and how it can be used in a Newton-Raphson iteration to calculate the reciprocal of a number, see [Floating-point reciprocal estimate and step on page A2-85](#).

### A8.8.386 VREV16, VREV32, VREV64

VREV16 (Vector Reverse in halfwords) reverses the order of 8-bit elements in each halfword of the vector, and places the result in the corresponding destination vector.

VREV32 (Vector Reverse in words) reverses the order of 8-bit or 16-bit elements in each word of the vector, and places the result in the corresponding destination vector.

VREV64 (Vector Reverse in doublewords) reverses the order of 8-bit, 16-bit, or 32-bit elements in each doubleword of the vector, and places the result in the corresponding destination vector.

There is no distinction between data types, other than size.

Figure A8-6 shows two examples of the operation of VREV.

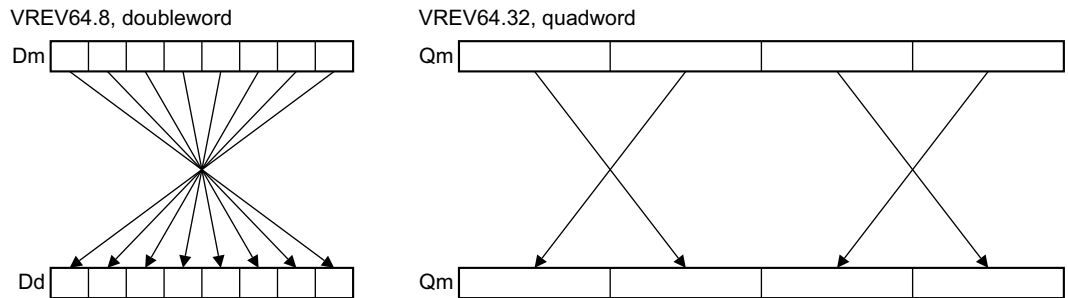

Figure A8-6 VREV operation examples

Depending on settings in the CPACR, NSACR, and HCPTR registers, and the security state and mode in which the instruction is executed, an attempt to execute the instruction might be UNDEFINED, or trapped to Hyp mode. [Summary of access controls for Advanced SIMD functionality on page B1-1232](#) summarizes these controls.

ARM deprecates the conditional execution of any Advanced SIMD instruction encoding that is not also available as a VFP instruction encoding, see [Conditional execution on page A8-288](#).

#### Encoding T1/A1 Advanced SIMD

VREV<n><c>.<size> <Qd>, <Qm>

VREV<n><c>.<size> <Dd>, <Dm>

15	14	13	12	11	10	9	8	7	6	5	4	3	2	1	0	15	14	13	12	11	10	9	8	7	6	5	4	3	2	1	0
1	1	1	1	1	1	1	1	1	D	1	1	size	0	0	Vd	0	0	0	op	Q	M	0	Vm								

31	30	29	28	27	26	25	24	23	22	21	20	19	18	17	16	15	14	13	12	11	10	9	8	7	6	5	4	3	2	1	0
1	1	1	1	0	0	1	1	1	D	1	1	size	0	0	Vd	0	0	0	op	Q	M	0	Vm								

```

if UInt(op)+UInt(size) >= 3 then UNDEFINED;
if Q == '1' && (Vd<0> == '1' || Vm<0> == '1') then UNDEFINED;
esize = 8 << UInt(size); elements = 64 DIV esize;
groupsize = (1 << (3-UInt(op)-UInt(size))); // elements per reversing group: 2, 4 or 8
reverse_mask = (groupsize-1)<size-1:0>; // EORing mask used for index calculations
d = UInt(D:Vd); m = UInt(M:Vm); regs = if Q == '0' then 1 else 2;

```



## Assembler syntax

VREV<n>{<c>}{<q>}.<size> <Qd>, <Qm> Encoded as Q = 1  
VREV<n>{<c>}{<q>}.<size> <Dd>, <Dm> Encoded as Q = 0

where:

<n> The size of the regions in which the vector elements are reversed. It must be one of:  
16 Encoded as op = 0b10.  
32 Encoded as op = 0b01.  
64 Encoded as op = 0b00.

<c>, <q> See [Standard assembler syntax fields on page A8-287](#). An ARM VREV instruction must be unconditional. ARM strongly recommends that a Thumb VREV instruction is unconditional, see [Conditional execution on page A8-288](#).

<size> The size of the vector elements. It must be one of:  
8 Encoded as size = 0b00.  
16 Encoded as size = 0b01.  
32 Encoded as size = 0b10.  
<size> must specify a smaller size than <n>.

<Qd>, <Qm> The destination vector and the operand vector, for a quadword operation.

<Dd>, <Dm> The destination vector and the operand vector, for a doubleword operation.

If op + size >= 3, the instruction is reserved.

## Operation

```
if ConditionPassed() then
    EncodingSpecificOperations(); CheckAdvSIMDEnabled();
    bits(64) dest;

    for r = 0 to regs-1
        for e = 0 to elements-1
            // Calculate destination element index by bitwise EOR on source element index:
            e_bits = e<size-1:0>; d_bits = e_bits EOR reverse_mask; d = UInt(d_bits);
            Elem[dest,d,esize] = Elem[D[m+r],e,esize];
            D[d+r] = dest;
```

## Exceptions

Undefined Instruction, Hyp Trap.

### A8.8.387 VRHADD

Vector Rounding Halving Add adds corresponding elements in two vectors of integers, shifts each result right one bit, and places the final results in the destination vector.

The operand and result elements are all the same type, and can be any one of:

- 8-bit, 16-bit, or 32-bit signed integers
- 8-bit, 16-bit, or 32-bit unsigned integers.

The results of the halving operations are rounded. For truncated results see [VHADD](#), [VHSUB](#) on page A8-896.

Depending on settings in the [CPACR](#), [NSACR](#), and [HCPTR](#) registers, and the security state and mode in which the instruction is executed, an attempt to execute the instruction might be UNDEFINED, or trapped to Hyp mode.

[Summary of access controls for Advanced SIMD functionality on page B1-1232](#) summarizes these controls.

ARM deprecates the conditional execution of any Advanced SIMD instruction encoding that is not also available as a VFP instruction encoding, see [Conditional execution on page A8-288](#).

#### Encoding T1/A1 Advanced SIMD

VRHADD<c> <Qd>, <Qn>, <Qm>

VRHADD<c> <Dd>, <Dn>, <Dm>

15	14	13	12	11	10	9	8	7	6	5	4	3	2	1	0	15	14	13	12	11	10	9	8	7	6	5	4	3	2	1	0
1	1	1	U	1	1	1	1	0	D	size	Vn	Vd	0	0	0	1	N	Q	M	0	Vm										

31	30	29	28	27	26	25	24	23	22	21	20	19	18	17	16	15	14	13	12	11	10	9	8	7	6	5	4	3	2	1	0
1	1	1	1	0	0	1	U	0	D	size	Vn	Vd	0	0	0	1	N	Q	M	0	Vm										

```

if Q == '1' && (Vd<0> == '1' || Vn<0> == '1' || Vm<0> == '1') then UNDEFINED;
if size == '11' then UNDEFINED;
unsigned = (U == '1');
esize = 8 << UInt(size); elements = 64 DIV esize;
d = UInt(D:Vd); n = UInt(N:Vn); m = UInt(M:Vm); regs = if Q == '0' then 1 else 2;

```

## Assembler syntax

VRHADD{<c>}{<q>}.<dt> {<Qd>}, <Qn>, <Qm> Encoded as Q = 1  
VRHADD{<c>}{<q>}.<dt> {<Dd>}, <Dn>, <Dm> Encoded as Q = 0

where:

<c>, <q> See [Standard assembler syntax fields on page A8-287](#). An ARM VRHADD instruction must be unconditional. ARM strongly recommends that a Thumb VRHADD instruction is unconditional, see [Conditional execution on page A8-288](#).

<dt> The data type for the elements of the vectors. It must be one of:

S8	Encoded as size = 0b00, U = 0.
S16	Encoded as size = 0b01, U = 0.
S32	Encoded as size = 0b10, U = 0.
U8	Encoded as size = 0b00, U = 1.
U16	Encoded as size = 0b01, U = 1.
U32	Encoded as size = 0b10, U = 1.

<Qd>, <Qn>, <Qm> The destination vector and the operand vectors, for a quadword operation.

<Dd>, <Dn>, <Dm> The destination vector and the operand vectors, for a doubleword operation.

## Operation

```

if ConditionPassed() then
    EncodingSpecificOperations(); CheckAdvSIMDEnabled();
    for r = 0 to regs-1
        for e = 0 to elements-1
            op1 = Int(Elem[D[n+r],e,esize], unsigned);
            op2 = Int(Elem[D[m+r],e,esize], unsigned);
            result = op1 + op2 + 1;
            Elem[D[d+r],e,esize] = result<esize:1>;

```

## Exceptions

Undefined Instruction, Hyp Trap.

### A8.8.388 VRSHL

Vector Rounding Shift Left takes each element in a vector, shifts them by a value from the least significant byte of the corresponding element of a second vector, and places the results in the destination vector. If the shift value is positive, the operation is a left shift. If the shift value is negative, it is a rounding right shift. (For a truncating shift, see *VSHL (register)* on page A8-1048).

The first operand and result elements are the same data type, and can be any one of:

- 8-bit, 16-bit, 32-bit, or 64-bit signed integers
- 8-bit, 16-bit, 32-bit, or 64-bit unsigned integers.

The second operand is always a signed integer of the same size.

Depending on settings in the CPACR, NSACR, and HCPTR registers, and the security state and mode in which the instruction is executed, an attempt to execute the instruction might be UNDEFINED, or trapped to Hyp mode.

*Summary of access controls for Advanced SIMD functionality* on page B1-1232 summarizes these controls.

ARM deprecates the conditional execution of any Advanced SIMD instruction encoding that is not also available as a VFP instruction encoding, see *Conditional execution* on page A8-288.

#### Encoding T1/A1 Advanced SIMD

VRSHL<c>.<type><size> <Qd>, <Qm>, <Qn>

VRSHL<c>.<type><size> <Dd>, <Dm>, <Dn>

15	14	13	12	11	10	9	8	7	6	5	4	3	2	1	0	15	14	13	12	11	10	9	8	7	6	5	4	3	2	1	0
1	1	1	U	1	1	1	1	0	D	size	Vn	Vd	0	1	0	1	N	Q	M	0	Vm										

31	30	29	28	27	26	25	24	23	22	21	20	19	18	17	16	15	14	13	12	11	10	9	8	7	6	5	4	3	2	1	0
1	1	1	1	0	0	1	U	0	D	size	Vn	Vd	0	1	0	1	N	Q	M	0	Vm										

```

if Q == '1' && (Vd<0> == '1' || Vm<0> == '1' || Vn<0> == '1') then UNDEFINED;
unsigned = (U == '1');
esize = 8 << UInt(size); elements = 64 DIV esize;
d = UInt(D:Vd); m = UInt(M:Vm); n = UInt(N:Vn); regs = if Q == '0' then 1 else 2;

```

## Assembler syntax

VRSHL{<c>}{<q>}.<type><size> {<Qd>}, <Qm>, <Qn> Encoded as Q = 1  
VRSHL{<c>}{<q>}.<type><size> {<Dd>}, <Dm>, <Dn> Encoded as Q = 0

where:

<c>, <q> See [Standard assembler syntax fields on page A8-287](#). An ARM VRSHL instruction must be unconditional. ARM strongly recommends that a Thumb VRSHL instruction is unconditional, see [Conditional execution on page A8-288](#).

<type> The data type for the elements of the vectors. It must be one of:  
S Signed, encoded as U = 0.  
U Unsigned, encoded as U = 1.  
Together with the <size> field, this indicates the data type and size of the first operand and the result.

<size> The data size for the elements of the vectors. It must be one of:  
8 Encoded as size = 0b00.  
16 Encoded as size = 0b01.  
32 Encoded as size = 0b10.  
64 Encoded as size = 0b11.

<Qd>, <Qm>, <Qn> The destination vector and the operand vectors, for a quadword operation.

<Dd>, <Dm>, <Dn> The destination vector and the operand vectors, for a doubleword operation.

## Operation

```
if ConditionPassed() then
    EncodingSpecificOperations(); CheckAdvSIMDEnabled();
    for r = 0 to regs-1
        for e = 0 to elements-1
            shift = SInt(Elem[D[n+r],e,esize]<7:0>);
            round_const = 1 << (-shift-1); // 0 for left shift, 2^(n-1) for right shift
            result = (Int(Elem[D[m+r],e,esize], unsigned) + result + round_const) << shift;
            Elem[D[d+r],e,esize] = result<esize-1:0>;
```

## Exceptions

Undefined Instruction, Hyp Trap.

### A8.8.389 VRSHR

Vector Rounding Shift Right takes each element in a vector, right shifts them by an immediate value, and places the rounded results in the destination vector. For truncated results, see *VSHR* on page A8-1052.

The operand and result elements must be the same size, and can be any one of:

- 8-bit, 16-bit, 32-bit, or 64-bit signed integers.
- 8-bit, 16-bit, 32-bit, or 64-bit unsigned integers.

Depending on settings in the CPACR, NSACR, and HCPTR registers, and the security state and mode in which the instruction is executed, an attempt to execute the instruction might be UNDEFINED, or trapped to Hyp mode.

*Summary of access controls for Advanced SIMD functionality* on page B1-1232 summarizes these controls.

ARM deprecates the conditional execution of any Advanced SIMD instruction encoding that is not also available as a VFP instruction encoding, see *Conditional execution* on page A8-288.

#### Encoding T1/A1 Advanced SIMD

VRSHR<c>.<type><size> <Qd>, <Qm>, #<imm>

VRSHR<c>.<type><size> <Dd>, <Dm>, #<imm>

15	14	13	12	11	10	9	8	7	6	5	4	3	2	1	0	15	14	13	12	11	10	9	8	7	6	5	4	3	2	1	0
1	1	1	U	1	1	1	1	1	D	imm6						Vd	0	0	1	0	L	Q	M	1	Vm						
31	30	29	28	27	26	25	24	23	22	21	20	19	18	17	16	15	14	13	12	11	10	9	8	7	6	5	4	3	2	1	0
1	1	1	1	0	0	1	U	1	D	imm6						Vd	0	0	1	0	L	Q	M	1	Vm						

```

if (L:imm6) IN "0000xxx" then SEE "Related encodings";
if Q == '1' && (Vd<0> == '1' || Vm<0> == '1') then UNDEFINED;
case L:imm6 of
  when "0001xxx" esize = 8; elements = 8; shift_amount = 16 - UInt(imm6);
  when "001xxxx" esize = 16; elements = 4; shift_amount = 32 - UInt(imm6);
  when "01xxxxx" esize = 32; elements = 2; shift_amount = 64 - UInt(imm6);
  when "1xxxxxx" esize = 64; elements = 1; shift_amount = 64 - UInt(imm6);
unsigned = (U == '1'); d = UInt(D:Vd); m = UInt(M:Vm); regs = if Q == '0' then 1 else 2;

```

**Related encodings** See *One register and a modified immediate value* on page A7-269.

## Assembler syntax

VRSHR{<c>}{<q>}.<type><size> {<Qd>}, <Qm>, #<imm> Encoded as Q = 1  
VRSHR{<c>}{<q>}.<type><size> {<Dd>}, <Dm>, #<imm> Encoded as Q = 0

where:

<c>, <q> See [Standard assembler syntax fields on page A8-287](#). An ARM VRSHR instruction must be unconditional. ARM strongly recommends that a Thumb VRSHR instruction is unconditional, see [Conditional execution on page A8-288](#).

<type> The data type for the elements of the vectors. It must be one of:  
S Signed, encoded as U = 0  
U Unsigned, encoded as U = 1.

<size> The data size for the elements of the vectors. It must be one of:  
8 Encoded as L = 0, imm6<5:3> = 0b001. (8 - <imm>) is encoded in imm6<2:0>.  
16 Encoded as L = 0, imm6<5:4> = 0b01. (16 - <imm>) is encoded in imm6<3:0>.  
32 Encoded as L = 0, imm6<5> = 0b1. (32 - <imm>) is encoded in imm6<4:0>.  
64 Encoded as L = 1. (64 - <imm>) is encoded in imm6<5:0>.

<Qd>, <Qm> The destination vector, and the operand vector, for a quadword operation.

<Dd>, <Dm> The destination vector, and the operand vector, for a doubleword operation.

<imm> The immediate value, in the range 1 to <size>. See the description of <size> for how <imm> is encoded.

## Operation

```
if ConditionPassed() then
    EncodingSpecificOperations(); CheckAdvSIMDEnabled();
    round_const = 1 << (shift_amount - 1);
    for r = 0 to regs-1
        for e = 0 to elements-1
            result = (Int(Elem[D[m+r],e,esize], unsigned) + round_const) >> shift_amount;
            Elem[D[d+r],e,esize] = result<esize-1:0>;
```

## Exceptions

Undefined Instruction, Hyp Trap.

## Pseudo-instructions

VRSHR.<type><size> <Qd>, <Qm>, #0 is a synonym for VMOV <Qd>, <Qm>  
VRSHR.<type><size> <Dd>, <Dm>, #0 is a synonym for VMOV <Dd>, <Dm>

For details see [VMOV \(register\) on page A8-938](#).

### A8.8.390 VRSHRN

Vector Rounding Shift Right and Narrow takes each element in a vector, right shifts them by an immediate value, and places the rounded results in the destination vector. For truncated results, see *VSHRN* on page A8-1054.

The operand elements can be 16-bit, 32-bit, or 64-bit integers. There is no distinction between signed and unsigned integers. The destination elements are half the size of the source elements.

Depending on settings in the CPACR, NSACR, and HCPTR registers, and the security state and mode in which the instruction is executed, an attempt to execute the instruction might be UNDEFINED, or trapped to Hyp mode. *Summary of access controls for Advanced SIMD functionality* on page B1-1232 summarizes these controls.

ARM deprecates the conditional execution of any Advanced SIMD instruction encoding that is not also available as a VFP instruction encoding, see *Conditional execution* on page A8-288.

#### Encoding T1/A1 Advanced SIMD

VRSHRN<c>.I<size> <Dd>, <Qm>, #<imm>

15	14	13	12	11	10	9	8	7	6	5	4	3	2	1	0	15	14	13	12	11	10	9	8	7	6	5	4	3	2	1	0
1	1	1	0	1	1	1	1	1	D	imm6						Vd			1	0	0	0	0	1	M	1	Vm				

31	30	29	28	27	26	25	24	23	22	21	20	19	18	17	16	15	14	13	12	11	10	9	8	7	6	5	4	3	2	1	0
1	1	1	1	0	0	1	0	1	D	imm6						Vd			1	0	0	0	0	1	M	1	Vm				

```

if imm6 IN "000xxx" then SEE "Related encodings";
if Vm<0> == '1' then UNDEFINED;
case imm6 of
  when "001xxx" esize = 8; elements = 8; shift_amount = 16 - UInt(imm6);
  when "01xxxx" esize = 16; elements = 4; shift_amount = 32 - UInt(imm6);
  when "1xxxxx" esize = 32; elements = 2; shift_amount = 64 - UInt(imm6);
d = UInt(D:Vd); m = UInt(M:Vm);

```

**Related encodings** See *One register and a modified immediate value* on page A7-269.



## Assembler syntax

VRSHRN{<c>}{<q>}.I<size> <Dd>, <Qm>, #<imm>

where:

- <c>, <q> See [Standard assembler syntax fields on page A8-287](#). An ARM VRSHRN instruction must be unconditional. ARM strongly recommends that a Thumb VRSHRN instruction is unconditional, see [Conditional execution on page A8-288](#).
- <size> The data size for the elements of the vectors. It must be one of:
- |    |  |
|----|--|
| 16 | Encoded as imm6<5:3> = 0b001. (8 – <imm>) is encoded in imm6<2:0>. |
| 32 | Encoded as imm6<5:4> = 0b01. (16 – <imm>) is encoded in imm6<3:0>. |
| 64 | Encoded as imm6<5> = 0b1. (32 – <imm>) is encoded in imm6<4:0>.    |
- <Dd>, <Qm> The destination vector, and the operand vector.
- <imm> The immediate value, in the range 1 to <size>/2. See the description of <size> for how <imm> is encoded.

## Operation

```
if ConditionPassed() then
    EncodingSpecificOperations(); CheckAdvSIMDEnabled();
    round_const = 1 << (shift_amount-1);
    for e = 0 to elements-1
        result = LSR(Elem[Qin[m>>1],e,2*esize] + round_const, shift_amount);
        Elem[D[d],e,esize] = result<esize-1:0>;
```

## Exceptions

Undefined Instruction, Hyp Trap.

## Pseudo-instructions

VRSHRN.I<size> <Dd>, <Qm>, #0 is a synonym for VMOVN.I<size> <Dd>, <Qm>

For details see [VMOYN on page A8-952](#).

### A8.8.391 VRSQRTE

Vector Reciprocal Square Root Estimate finds an approximate reciprocal square root of each element in a vector, and places the results in a second vector.

The operand and result elements are the same type, and can be 32-bit floating-point numbers, or 32-bit unsigned integers.

For details of the operation performed by this instruction see [Floating-point reciprocal square root estimate and step on page A2-87](#).

Depending on settings in the CPACR, NSACR, and HCPTR registers, and the security state and mode in which the instruction is executed, an attempt to execute the instruction might be UNDEFINED, or trapped to Hyp mode. [Summary of access controls for Advanced SIMD functionality on page B1-1232](#) summarizes these controls.

ARM deprecates the conditional execution of any Advanced SIMD instruction encoding that is not also available as a VFP instruction encoding, see [Conditional execution on page A8-288](#).

**Encoding T1/A1**      Advanced SIMD (F = 1 UNDEFINED in integer-only variants)

VRSQRTE<c>.<dt> <Qd>, <Qm>

VRSQRTE<c>.<dt> <Dd>, <Dm>

15	14	13	12	11	10	9	8	7	6	5	4	3	2	1	0	15	14	13	12	11	10	9	8	7	6	5	4	3	2	1	0
1	1	1	1	1	1	1	1	1	D	1	1	size	1	1		Vd				0	1	0	F	1	Q	M	0		Vm		

31	30	29	28	27	26	25	24	23	22	21	20	19	18	17	16	15	14	13	12	11	10	9	8	7	6	5	4	3	2	1	0
1	1	1	1	0	0	1	1	1	D	1	1	size	1	1		Vd				0	1	0	F	1	Q	M	0		Vm		

```

if Q == '1' && (Vd<0> == '1' || Vm<0> == '1') then UNDEFINED;
if size != '10' then UNDEFINED;
floating_point = (F == '1'); esize = 32; elements = 2;
d = UInt(D:Vd); m = UInt(M:Vm); regs = if Q == '0' then 1 else 2;

```

## Assembler syntax

VRSQRTE{<C>}{<q>}.<dt> <Qd>, <Qm> Encoded as Q = 1  
VRSQRTE{<C>}{<q>}.<dt> <Dd>, <Dm> Encoded as Q = 0

where:

<C>, <q> See [Standard assembler syntax fields on page A8-287](#). An ARM VRSQRTE instruction must be unconditional. ARM strongly recommends that a Thumb VRSQRTE instruction is unconditional, see [Conditional execution on page A8-288](#).

<dt> The data types for the elements of the vectors. It must be one of:  
U32 Encoded as F = 0, size = 0b10.  
F32 Encoded as F = 1, size = 0b10.

<Qd>, <Qm> The destination vector and the operand vector, for a quadword operation.

<Dd>, <Dm> The destination vector and the operand vector, for a doubleword operation.

## Operation

```

if ConditionPassed() then
    EncodingSpecificOperations(); CheckAdvSIMDEnabled();
    for r = 0 to regs-1
        for e = 0 to elements-1
            if floating_point then
                Elem[D[d+r],e,esize] = FPRSqrtEstimate(Elem[D[m+r],e,esize]);
            else
                Elem[D[d+r],e,esize] = UnsignedRSqrtEstimate(Elem[D[m+r],e,esize]);

```

## Exceptions

Undefined Instruction, Hyp Trap.

### ***Floating-point exceptions***

Input Denormal, Invalid Operation, Division by Zero.

## Newton-Raphson iteration

For details of the operation performed and how it can be used in a Newton-Raphson iteration to calculate the reciprocal of the square root of a number, see [Floating-point reciprocal square root estimate and step on page A2-87](#).

### A8.8.392 VRSQRTS

Vector Reciprocal Square Root Step multiplies the elements of one vector by the corresponding elements of another vector, subtracts each of the products from 3.0, divides these results by 2.0, and places the results into the elements of the destination vector.

The operand and result elements are 32-bit floating-point numbers.

For details of the operation performed by this instruction see [Floating-point reciprocal square root estimate and step on page A2-87](#).

Depending on settings in the CPACR, NSACR, and HCPTR registers, and the security state and mode in which the instruction is executed, an attempt to execute the instruction might be UNDEFINED, or trapped to Hyp mode. [Summary of access controls for Advanced SIMD functionality on page B1-1232](#) summarizes these controls.

ARM deprecates the conditional execution of any Advanced SIMD instruction encoding that is not also available as a VFP instruction encoding, see [Conditional execution on page A8-288](#).

#### Encoding T1/A1 Advanced SIMD (UNDEFINED in integer-only variant)

VRSQRTS<c>.F32 <Qd>, <Qn>, <Qm>

VRSQRTS<c>.F32 <Dd>, <Dn>, <Dm>

15	14	13	12	11	10	9	8	7	6	5	4	3	2	1	0	15	14	13	12	11	10	9	8	7	6	5	4	3	2	1	0
1	1	1	0	1	1	1	1	0	D	1	sz	Vn			Vd			1	1	1	1	N	Q	M	1	Vm					

31	30	29	28	27	26	25	24	23	22	21	20	19	18	17	16	15	14	13	12	11	10	9	8	7	6	5	4	3	2	1	0
1	1	1	1	0	0	1	0	0	D	1	sz	Vn			Vd			1	1	1	1	N	Q	M	1	Vm					

```

if Q == '1' && (Vd<0> == '1' || Vn<0> == '1' || Vm<0> == '1') then UNDEFINED;
if sz == '1' then UNDEFINED;
esize = 32; elements = 2;
d = UInt(D:Vd); n = UInt(N:Vn); m = UInt(M:Vm); regs = if Q == '0' then 1 else 2;

```

## Assembler syntax

VRSQRTS{<c>}{<q>}.F32 {<Qd>}, <Qn>, <Qm> Encoded as Q = 1, sz = 0  
VRSQRTS{<c>}{<q>}.F32 {<Dd>}, <Dn>, <Dm> Encoded as Q = 0, sz = 0

where:

<c>, <q> See [Standard assembler syntax fields on page A8-287](#). An ARM VRSQRTS instruction must be unconditional. ARM strongly recommends that a Thumb VRSQRTS instruction is unconditional, see [Conditional execution on page A8-288](#).

<Qd>, <Qn>, <Qm> The destination vector and the operand vectors for a quadword operation.

<Dd>, <Dn>, <Dm> The destination vector and the operand vectors for a doubleword operation.

## Operation

```
if ConditionPassed() then
    EncodingSpecificOperations(); CheckAdvSIMDEnabled();
    for r = 0 to regs-1
        for e = 0 to elements-1
            Elem[D[d+r],e,esize] = FPRSqrtStep(Elem[D[n+r],e,esize], Elem[D[m+r],e,esize]);
```

## Exceptions

Undefined Instruction, Hyp Trap.

### *Floating-point exceptions*

Input Denormal, Invalid Operation, Overflow, Underflow, Inexact.

## Newton-Raphson iteration

For details of the operation performed and how it can be used in a Newton-Raphson iteration to calculate the reciprocal of the square root of a number, see [Floating-point reciprocal square root estimate and step on page A2-87](#).

### A8.8.393 VRSRA

Vector Rounding Shift Right and Accumulate takes each element in a vector, right shifts them by an immediate value, and accumulates the rounded results into the destination vector. (For truncated results, see *VSR* on page A8-1060.)

The operand and result elements must all be the same type, and can be any one of:

- 8-bit, 16-bit, 32-bit, or 64-bit signed integers.
- 8-bit, 16-bit, 32-bit, or 64-bit unsigned integers.

Depending on settings in the CPACR, NSACR, and HCPTR registers, and the security state and mode in which the instruction is executed, an attempt to execute the instruction might be UNDEFINED, or trapped to Hyp mode.

*Summary of access controls for Advanced SIMD functionality* on page B1-1232 summarizes these controls.

ARM deprecates the conditional execution of any Advanced SIMD instruction encoding that is not also available as a VFP instruction encoding, see *Conditional execution* on page A8-288.

#### Encoding T1/A1 Advanced SIMD

VRSRA<c>.<type><size> <Qd>, <Qm>, #<imm>

VRSRA<c>.<type><size> <Dd>, <Dm>, #<imm>

15	14	13	12	11	10	9	8	7	6	5	4	3	2	1	0	15	14	13	12	11	10	9	8	7	6	5	4	3	2	1	0
1	1	1	U	1	1	1	1	1	D	imm6						Vd	0	0	1	1	L	Q	M	1	Vm						
31	30	29	28	27	26	25	24	23	22	21	20	19	18	17	16	15	14	13	12	11	10	9	8	7	6	5	4	3	2	1	0
1	1	1	1	0	0	1	U	1	D	imm6						Vd	0	0	1	1	L	Q	M	1	Vm						

```

if (L:imm6) IN "0000xxx" then SEE "Related encodings";
if Q == '1' && (Vd<0> == '1' || Vm<0> == '1') then UNDEFINED;
case L:imm6 of
  when "0001xxx" esize = 8; elements = 8; shift_amount = 16 - UInt(imm6);
  when "001xxxx" esize = 16; elements = 4; shift_amount = 32 - UInt(imm6);
  when "01xxxxx" esize = 32; elements = 2; shift_amount = 64 - UInt(imm6);
  when "1xxxxxx" esize = 64; elements = 1; shift_amount = 64 - UInt(imm6);
unsigned = (U == '1'); d = UInt(D:Vd); m = UInt(M:Vm); regs = if Q == '0' then 1 else 2;

```

**Related encodings** See *One register and a modified immediate value* on page A7-269.

## Assembler syntax

VRSRA{<c>}{<q>}.<type><size> {<Qd>}, <Qm>, #<imm> Encoded as Q = 1  
VRSRA{<c>}{<q>}.<type><size> {<Dd>}, <Dm>, #<imm> Encoded as Q = 0

where:

<c>, <q> See [Standard assembler syntax fields on page A8-287](#). An ARM VRSRA instruction must be unconditional. ARM strongly recommends that a Thumb VRSRA instruction is unconditional, see [Conditional execution on page A8-288](#).

<type> The data type for the elements of the vectors. It must be one of:  
S Signed, encoded as U = 0.  
U Unsigned, encoded as U = 1.

<size> The data size for the elements of the vectors. It must be one of:  
8 Encoded as L = 0, imm6<5:3> = 0b001. (8 – <imm>) is encoded in imm6<2:0>.  
16 Encoded as L = 0, imm6<5:4> = 0b01. (16 – <imm>) is encoded in imm6<3:0>.  
32 Encoded as L = 0, imm6<5> = 0b1. (32 – <imm>) is encoded in imm6<4:0>.  
64 Encoded as L = 1. (64 – <imm>) is encoded in imm6<5:0>.

<Qd>, <Qm> The destination vector, and the operand vector, for a quadword operation.

<Dd>, <Dm> The destination vector, and the operand vector, for a doubleword operation.

<imm> The immediate value, in the range 1 to <size>. See the description of <size> for how <imm> is encoded.

## Operation

```
if ConditionPassed() then
    EncodingSpecificOperations(); CheckAdvSIMDEnabled();
    round_const = 1 << (shift_amount - 1);
    for r = 0 to regs-1
        for e = 0 to elements-1
            result = (Int(Elem[D[m+r],e,esize], unsigned) + round_const) >> shift_amount;
            Elem[D[d+r],e,esize] = Elem[D[d+r],e,esize] + result;
```

## Exceptions

Undefined Instruction, Hyp Trap.

### A8.8.394 VRSUBHN

Vector Rounding Subtract and Narrow, returning High Half subtracts the elements of one quadword vector from the corresponding elements of another quadword vector takes the most significant half of each result, and places the final results in a doubleword vector. The results are rounded. (For truncated results, see [VRSUBHN on page A8-1088](#).)

The operand elements can be 16-bit, 32-bit, or 64-bit integers. There is no distinction between signed and unsigned integers.

Depending on settings in the [CPACR](#), [NSACR](#), and [HCPTR](#) registers, and the security state and mode in which the instruction is executed, an attempt to execute the instruction might be UNDEFINED, or trapped to Hyp mode. [Summary of access controls for Advanced SIMD functionality on page B1-1232](#) summarizes these controls.

ARM deprecates the conditional execution of any Advanced SIMD instruction encoding that is not also available as a VFP instruction encoding, see [Conditional execution on page A8-288](#).

#### Encoding T1/A1 Advanced SIMD

VRSUBHN<c>.<dt> <Dd>, <Qn>, <Qm>

15	14	13	12	11	10	9	8	7	6	5	4	3	2	1	0	15	14	13	12	11	10	9	8	7	6	5	4	3	2	1	0
1	1	1	1	1	1	1	1	1	D	size		Vn		Vd		0	1	1	0	N	0	M	0		Vm						
31	30	29	28	27	26	25	24	23	22	21	20	19	18	17	16	15	14	13	12	11	10	9	8	7	6	5	4	3	2	1	0
1	1	1	1	0	0	1	1	1	D	size		Vn		Vd		0	1	1	0	N	0	M	0		Vm						

```
if size == '11' then SEE "Related encodings";
if Vn<0> == '1' || Vm<0> == '1' then UNDEFINED;
esize = 8 << UInt(size); elements = 64 DIV esize;
d = UInt(D:Vd); n = UInt(N:Vn); m = UInt(M:Vm);
```

**Related encodings** See [Advanced SIMD data-processing instructions on page A7-261](#).



## Assembler syntax

VRSUBHN{<c>}{<q>}.<dt> <Dd>, <Qn>, <Qm>

where:

<c>, <q> See [Standard assembler syntax fields on page A8-287](#). An ARM VRSUBHN instruction must be unconditional. ARM strongly recommends that a Thumb VRSUBHN instruction is unconditional, see [Conditional execution on page A8-288](#).

<dt> The data type for the elements of the operands. It must be one of:

I16	Encoded as size = 0b00.
I32	Encoded as size = 0b01.
I64	Encoded as size = 0b10.

<Dd>, <Qn>, <Qm> The destination vector and the operand vectors.

## Operation

```

if ConditionPassed() then
    EncodingSpecificOperations(); CheckAdvSIMDEnabled();
    round_const = 1 << (esize-1);
    for e = 0 to elements-1
        result = Elem[Qin[n>>1],e,2*esize] - Elem[Qin[m>>1],e,2*esize] + round_const;
        Elem[D[d],e,esize] = result<2*esize-1:esize>;

```

## Exceptions

Undefined Instruction, Hyp Trap.

### A8.8.395 VSHL (immediate)

Vector Shift Left (immediate) takes each element in a vector of integers, left shifts them by an immediate value, and places the results in the destination vector.

Bits shifted out of the left of each element are lost.

The elements must all be the same size, and can be 8-bit, 16-bit, 32-bit, or 64-bit integers. There is no distinction between signed and unsigned integers.

Depending on settings in the CPACR, NSACR, and HCPTR registers, and the security state and mode in which the instruction is executed, an attempt to execute the instruction might be UNDEFINED, or trapped to Hyp mode. [Summary of access controls for Advanced SIMD functionality on page B1-1232](#) summarizes these controls.

ARM deprecates the conditional execution of any Advanced SIMD instruction encoding that is not also available as a VFP instruction encoding, see [Conditional execution on page A8-288](#).

#### Encoding T1/A1 Advanced SIMD

VSHL<c>.I<size> <Qd>, <Qm>, #<imm>

VSHL<c>.I<size> <Dd>, <Dm>, #<imm>

15	14	13	12	11	10	9	8	7	6	5	4	3	2	1	0	15	14	13	12	11	10	9	8	7	6	5	4	3	2	1	0
1	1	1	0	1	1	1	1	1	D	imm6						Vd	0	1	0	1	L	Q	M	1	Vm						
31	30	29	28	27	26	25	24	23	22	21	20	19	18	17	16	15	14	13	12	11	10	9	8	7	6	5	4	3	2	1	0
1	1	1	1	0	0	1	0	1	D	imm6						Vd	0	1	0	1	L	Q	M	1	Vm						

```

if L:imm6 IN "0000xxx" then SEE "Related encodings";
if Q == '1' && (Vd<0> == '1' || Vm<0> == '1') then UNDEFINED;
case L:imm6 of
  when "0001xxx" esize = 8; elements = 8; shift_amount = UInt(imm6) - 8;
  when "001xxxx" esize = 16; elements = 4; shift_amount = UInt(imm6) - 16;
  when "01xxxxx" esize = 32; elements = 2; shift_amount = UInt(imm6) - 32;
  when "1xxxxxx" esize = 64; elements = 1; shift_amount = UInt(imm6);
d = UInt(D:Vd); m = UInt(M:Vm); regs = if Q == '0' then 1 else 2;

```

**Related encodings** See [One register and a modified immediate value on page A7-269](#).

## Assembler syntax

VSHL{<C>}{<Q>}.I<size> {<Qd>}, <Qm>, #<imm> Encoded as Q = 1  
VSHL{<C>}{<Q>}.I<size> {<Dd>}, <Dm>, #<imm> Encoded as Q = 0

where:

<C>, <Q> See [Standard assembler syntax fields on page A8-287](#). An ARM VSHL instruction must be unconditional. ARM strongly recommends that a Thumb VSHL instruction is unconditional, see [Conditional execution on page A8-288](#).

<size> The data size for the elements of the vectors. It must be one of:  
8 Encoded as L = 0, imm6<5:3> = 0b001. <imm> is encoded in imm6<2:0>.  
16 Encoded as L = 0, imm6<5:4> = 0b01. <imm> is encoded in imm6<3:0>.  
32 Encoded as L = 0, imm6<5> = 0b1. <imm> is encoded in imm6<4:0>.  
64 Encoded as L = 1. <imm> is encoded in imm6<5:0>.

<Qd>, <Qm> The destination vector, and the operand vector, for a quadword operation.

<Dd>, <Dm> The destination vector, and the operand vector, for a doubleword operation.

<imm> The immediate value, in the range 0 to <size>-1. See the description of <size> for how <imm> is encoded.

## Operation

```
if ConditionPassed() then
    EncodingSpecificOperations(); CheckAdvSIMDEnabled();
    for r = 0 to regs-1
        for e = 0 to elements-1
            Elem[D[d+r],e,esize] = LSL(Elem[D[m+r],e,esize], shift_amount);
```

## Exceptions

Undefined Instruction, Hyp Trap.

### A8.8.396 VSHL (register)

Vector Shift Left (register) takes each element in a vector, shifts them by a value from the least significant byte of the corresponding element of a second vector, and places the results in the destination vector. If the shift value is positive, the operation is a left shift. If the shift value is negative, it is a truncating right shift.

———— **Note** —————

For a rounding shift, see [VRSHL on page A8-1032](#).

The first operand and result elements are the same data type, and can be any one of:

- 8-bit, 16-bit, 32-bit, or 64-bit signed integers
- 8-bit, 16-bit, 32-bit, or 64-bit unsigned integers.

The second operand is always a signed integer of the same size.

Depending on settings in the [CPACR](#), [NSACR](#), and [HCPTR](#) registers, and the security state and mode in which the instruction is executed, an attempt to execute the instruction might be UNDEFINED, or trapped to Hyp mode. [Summary of access controls for Advanced SIMD functionality on page B1-1232](#) summarizes these controls.

ARM deprecates the conditional execution of any Advanced SIMD instruction encoding that is not also available as a VFP instruction encoding, see [Conditional execution on page A8-288](#).

#### Encoding T1/A1 Advanced SIMD

VSHL<c>.<type><size> <Qd>, <Qm>, <Qn>

VSHL<c>.<type><size> <Dd>, <Dm>, <Dn>

15	14	13	12	11	10	9	8	7	6	5	4	3	2	1	0	15	14	13	12	11	10	9	8	7	6	5	4	3	2	1	0
1	1	1	U	1	1	1	1	0	D	size	Vn	Vd	0	1	0	0	N	Q	M	0	Vm										
31	30	29	28	27	26	25	24	23	22	21	20	19	18	17	16	15	14	13	12	11	10	9	8	7	6	5	4	3	2	1	0
1	1	1	1	0	0	1	U	0	D	size	Vn	Vd	0	1	0	0	N	Q	M	0	Vm										

```
if Q == '1' && (Vd<0> == '1' || Vm<0> == '1' || Vn<0> == '1') then UNDEFINED;
unsigned = (U == '1');
esize = 8 << UInt(size); elements = 64 DIV esize;
d = UInt(D:Vd); m = UInt(M:Vm); n = UInt(N:Vn); regs = if Q == '0' then 1 else 2;
```

## Assembler syntax

VSHL{<C>}{<q>}.<type><size> {<Qd>}, <Qm>, <Qn> Encoded as Q = 1  
VSHL{<C>}{<q>}.<type><size> {<Dd>}, <Dm>, <Dn> Encoded as Q = 0

where:

<C>, <q> See [Standard assembler syntax fields on page A8-287](#). An ARM VSHL instruction must be unconditional. ARM strongly recommends that a Thumb VSHL instruction is unconditional, see [Conditional execution on page A8-288](#).

<type> The data type for the elements of the vectors. It must be one of:  
S Signed, encoded as U = 0.  
U Unsigned, encoded as U = 1.  
Together with the <size> field, this indicates the data type and size of the first operand and the result.

<size> The data size for the elements of the vectors. It must be one of:  
8 Encoded as size = 0b00.  
16 Encoded as size = 0b01.  
32 Encoded as size = 0b10.  
64 Encoded as size = 0b11.

<Qd>, <Qm>, <Qn> The destination vector and the operand vectors, for a quadword operation.

<Dd>, <Dm>, <Dn> The destination vector and the operand vectors, for a doubleword operation.

## Operation

```
if ConditionPassed() then
    EncodingSpecificOperations(); CheckAdvSIMDEnabled();
    for r = 0 to regs-1
        for e = 0 to elements-1
            shift = SInt(Elem[D[n+r],e,esize]<7:0>);
            result = Int(Elem[D[m+r],e,esize], unsigned) << shift;
            Elem[D[d+r],e,esize] = result<esize-1:0>;
```

## Exceptions

Undefined Instruction, Hyp Trap.

### A8.8.397 VSHLL

Vector Shift Left Long takes each element in a doubleword vector, left shifts them by an immediate value, and places the results in a quadword vector.

The operand elements can be:

- 8-bit, 16-bit, or 32-bit signed integers
- 8-bit, 16-bit, or 32-bit unsigned integers
- 8-bit, 16-bit, or 32-bit untyped integers (maximum shift only).

The result elements are twice the length of the operand elements.

Depending on settings in the CPACR, NSACR, and HCPTR registers, and the security state and mode in which the instruction is executed, an attempt to execute the instruction might be UNDEFINED, or trapped to Hyp mode. [Summary of access controls for Advanced SIMD functionality on page B1-1232](#) summarizes these controls.

ARM deprecates the conditional execution of any Advanced SIMD instruction encoding that is not also available as a VFP instruction encoding, see [Conditional execution on page A8-288](#).

#### Encoding T1/A1 Advanced SIMD

VSHLL<c>.<type><size> <Qd>, <Dm>, #<imm> (0 < <imm> < <size>)

15	14	13	12	11	10	9	8	7	6	5	4	3	2	1	0	15	14	13	12	11	10	9	8	7	6	5	4	3	2	1	0
1	1	1	U	1	1	1	1	1	D	imm6						Vd	1	0	1	0	0	0	M	1	Vm						
31	30	29	28	27	26	25	24	23	22	21	20	19	18	17	16	15	14	13	12	11	10	9	8	7	6	5	4	3	2	1	0
1	1	1	1	0	0	1	U	1	D	imm6						Vd	1	0	1	0	0	0	M	1	Vm						

```

if imm6 IN "000xxx" then SEE "Related encodings";
if Vd<0> == '1' then UNDEFINED;
case imm6 of
  when "001xxx" esize = 8; elements = 8; shift_amount = UInt(imm6) - 8;
  when "01xxxx" esize = 16; elements = 4; shift_amount = UInt(imm6) - 16;
  when "1xxxxx" esize = 32; elements = 2; shift_amount = UInt(imm6) - 32;
if shift_amount == 0 then SEE VMOVL;
unsigned = (U == '1'); d = UInt(D:Vd); m = UInt(M:Vm);

```

#### Encoding T2/A2 Advanced SIMD

VSHLL<c>.<type><size> <Qd>, <Dm>, #<imm> (<imm> == <size>)

15	14	13	12	11	10	9	8	7	6	5	4	3	2	1	0	15	14	13	12	11	10	9	8	7	6	5	4	3	2	1	0
1	1	1	1	1	1	1	1	1	D	1	1	size	1	0	Vd	0	0	1	1	0	0	M	0	Vm							
31	30	29	28	27	26	25	24	23	22	21	20	19	18	17	16	15	14	13	12	11	10	9	8	7	6	5	4	3	2	1	0
1	1	1	1	0	0	1	1	1	D	1	1	size	1	0	Vd	0	0	1	1	0	0	M	0	Vm							

```

if size == '11' || Vd<0> == '1' then UNDEFINED;
esize = 8 << UInt(size); shift_amount = esize;
unsigned = FALSE; // Or TRUE without change of functionality
d = UInt(D:Vd); m = UInt(M:Vm);

```

**Related encodings** See [One register and a modified immediate value on page A7-269](#).

## Assembler syntax

VSHLL{<c>}{<q>}.<type><size> <Qd>, <Dm>, #<imm>

where:

- <c>, <q> See [Standard assembler syntax fields on page A8-287](#). An ARM VSHLL instruction must be unconditional. ARM strongly recommends that a Thumb VSHLL instruction is unconditional, see [Conditional execution on page A8-288](#).
- <type> The data type for the elements of the operand. It must be one of:
- S Signed. In encoding T1/A1, encoded as U = 0.
  - U Unsigned. In encoding T1/A1, encoded as U = 1.
  - I Untyped integer, Available only in encoding T2/A2.
- <size> The data size for the elements of the operand. [Table A8-8](#) shows the permitted values and their encodings:

**Table A8-8 VSHLL <size> field encoding**

<size>	Encoding T1/A1	Encoding T2/A2
8	Encoded as imm6<5:3> = 0b001	Encoded as size = 0b00
16	Encoded as imm6<5:4> = 0b01	Encoded as size = 0b01
32	Encoded as imm6<5> = 1	Encoded as size = 0b10

- <Qd>, <Dm> The destination vector and the operand vector.
- <imm> The immediate value. <imm> must lie in the range 1 to <size>, and:
- if <size> == <imm>, the encoding is T2/A2
  - otherwise, the encoding is T1/A1, and:
    - if <size> == 8, <imm> is encoded in imm6<2:0>
    - if <size> == 16, <imm> is encoded in imm6<3:0>
    - if <size> == 32, <imm> is encoded in imm6<4:0>.

## Operation

```
if ConditionPassed() then
    EncodingSpecificOperations(); CheckAdvSIMDEnabled();
    for e = 0 to elements-1
        result = Int(Elem[Din[m],e,esize], unsigned) << shift_amount;
        Elem[Q[d>>1],e,2*esize] = result<2*esize-1:0>;
```

## Exceptions

Undefined Instruction, Hyp Trap.

### A8.8.398 VSHR

Vector Shift Right takes each element in a vector, right shifts them by an immediate value, and places the truncated results in the destination vector. For rounded results, see *VRSHR* on page A8-1034.

The operand and result elements must be the same size, and can be any one of:

- 8-bit, 16-bit, 32-bit, or 64-bit signed integers.
- 8-bit, 16-bit, 32-bit, or 64-bit unsigned integers.

Depending on settings in the CPACR, NSACR, and HCPTR registers, and the security state and mode in which the instruction is executed, an attempt to execute the instruction might be UNDEFINED, or trapped to Hyp mode.

*Summary of access controls for Advanced SIMD functionality* on page B1-1232 summarizes these controls.

ARM deprecates the conditional execution of any Advanced SIMD instruction encoding that is not also available as a VFP instruction encoding, see *Conditional execution* on page A8-288.

#### Encoding T1/A1 Advanced SIMD

VSHR<c>.<type><size> <Qd>, <Qm>, #<imm>

VSHR<c>.<type><size> <Dd>, <Dm>, #<imm>

15	14	13	12	11	10	9	8	7	6	5	4	3	2	1	0	15	14	13	12	11	10	9	8	7	6	5	4	3	2	1	0
1	1	1	U	1	1	1	1	1	D	imm6						Vd		0	0	0	0	L	Q	M	1	Vm					

31	30	29	28	27	26	25	24	23	22	21	20	19	18	17	16	15	14	13	12	11	10	9	8	7	6	5	4	3	2	1	0
1	1	1	1	0	0	1	U	1	D	imm6						Vd		0	0	0	0	L	Q	M	1	Vm					

```

if (L:imm6) IN "0000xxx" then SEE "Related encodings";
if Q == '1' && (Vd<0> == '1' || Vm<0> == '1') then UNDEFINED;
case L:imm6 of
  when "0001xxx" esize = 8; elements = 8; shift_amount = 16 - UInt(imm6);
  when "001xxxx" esize = 16; elements = 4; shift_amount = 32 - UInt(imm6);
  when "01xxxxx" esize = 32; elements = 2; shift_amount = 64 - UInt(imm6);
  when "1xxxxxx" esize = 64; elements = 1; shift_amount = 64 - UInt(imm6);
unsigned = (U == '1'); d = UInt(D:Vd); m = UInt(M:Vm); regs = if Q == '0' then 1 else 2;

```

**Related encodings** See *One register and a modified immediate value* on page A7-269.



## Assembler syntax

VSHR{<c>}{<q>}.<type><size> {<Qd>}, <Qm>, #<imm> Encoded as Q = 1  
VSHR{<c>}{<q>}.<type><size> {<Dd>}, <Dm>, #<imm> Encoded as Q = 0

where:

<c>, <q> See [Standard assembler syntax fields on page A8-287](#). An ARM VSHR instruction must be unconditional. ARM strongly recommends that a Thumb VSHR instruction is unconditional, see [Conditional execution on page A8-288](#).

<type> The data type for the elements of the vectors. It must be one of:  
S Signed, encoded as U = 0.  
U Unsigned, encoded as U = 1.

<size> The data size for the elements of the vectors. It must be one of:  
8 Encoded as L = 0, imm6<5:3> = 0b001. (8 – <imm>) is encoded in imm6<2:0>.  
16 Encoded as L = 0, imm6<5:4> = 0b01. (16 – <imm>) is encoded in imm6<3:0>.  
32 Encoded as L = 0, imm6<5> = 0b1. (32 – <imm>) is encoded in imm6<4:0>.  
64 Encoded as L = 1. (64 – <imm>) is encoded in imm6<5:0>.

<Qd>, <Qm> The destination vector, and the operand vector, for a quadword operation.

<Dd>, <Dm> The destination vector, and the operand vector, for a doubleword operation.

<imm> The immediate value, in the range 1 to <size>. See the description of <size> for how <imm> is encoded.

## Operation

```
if ConditionPassed() then
    EncodingSpecificOperations(); CheckAdvSIMDEnabled();
    for r = 0 to regs-1
        for e = 0 to elements-1
            result = Int(Elem[D[m+r],e,esize], unsigned) >> shift_amount;
            Elem[D[d+r],e,esize] = result<esize-1:0>;
```

## Exceptions

Undefined Instruction, Hyp Trap.

## Pseudo-instructions

VSHR.<type><size> <Qd>, <Qm>, #0 is a synonym for VMOV <Qd>, <Qm>  
VSHR.<type><size> <Dd>, <Dm>, #0 is a synonym for VMOV <Dd>, <Dm>

### A8.8.399 VSHRN

Vector Shift Right Narrow takes each element in a vector, right shifts them by an immediate value, and places the truncated results in the destination vector. For rounded results, see *VRSHRN* on page A8-1036.

The operand elements can be 16-bit, 32-bit, or 64-bit integers. There is no distinction between signed and unsigned integers. The destination elements are half the size of the source elements.

Depending on settings in the CPACR, NSACR, and HCPTR registers, and the security state and mode in which the instruction is executed, an attempt to execute the instruction might be UNDEFINED, or trapped to Hyp mode. *Summary of access controls for Advanced SIMD functionality* on page B1-1232 summarizes these controls.

ARM deprecates the conditional execution of any Advanced SIMD instruction encoding that is not also available as a VFP instruction encoding, see *Conditional execution* on page A8-288.

#### Encoding T1/A1 Advanced SIMD

VSHRN<c>.I<size> <Dd>, <Qm>, #<imm>

15	14	13	12	11	10	9	8	7	6	5	4	3	2	1	0	15	14	13	12	11	10	9	8	7	6	5	4	3	2	1	0
1	1	1	0	1	1	1	1	1	D	imm6						Vd				1	0	0	0	0	0	M	1	Vm			

31	30	29	28	27	26	25	24	23	22	21	20	19	18	17	16	15	14	13	12	11	10	9	8	7	6	5	4	3	2	1	0
1	1	1	1	0	0	1	0	1	D	imm6						Vd				1	0	0	0	0	0	M	1	Vm			

```

if imm6 IN "000xxx" then SEE "Related encodings";
if Vm<0> == '1' then UNDEFINED;
case imm6 of
  when "001xxx" esize = 8; elements = 8; shift_amount = 16 - UInt(imm6);
  when "01xxxx" esize = 16; elements = 4; shift_amount = 32 - UInt(imm6);
  when "1xxxxx" esize = 32; elements = 2; shift_amount = 64 - UInt(imm6);
d = UInt(D:Vd); m = UInt(M:Vm);

```

**Related encodings** See *One register and a modified immediate value* on page A7-269.

## Assembler syntax

VSHRN{<c>}{<q>}.I<size> <Dd>, <Qm>, #<imm>

where:

- <c>, <q> See [Standard assembler syntax fields on page A8-287](#). An ARM VSHRN instruction must be unconditional. ARM strongly recommends that a Thumb VSHRN instruction is unconditional, see [Conditional execution on page A8-288](#).
- <size> The data size for the elements of the vectors. It must be one of:
- |    |  |
|----|--|
| 16 | Encoded as imm6<5:3> = 0b001. (8 – <imm>) is encoded in imm6<2:0>. |
| 32 | Encoded as imm6<5:4> = 0b01. (16 – <imm>) is encoded in imm6<3:0>. |
| 64 | Encoded as imm6<5> = 0b1. (32 – <imm>) is encoded in imm6<4:0>.    |
- <Dd>, <Qm> The destination vector, and the operand vector.
- <imm> The immediate value, in the range 1 to <size>/2. See the description of <size> for how <imm> is encoded.

## Operation

```
if ConditionPassed() then
    EncodingSpecificOperations(); CheckAdvSIMDEnabled();
    for e = 0 to elements-1
        result = LSR(Elem[Qin[m]>>1], e, 2*esize), shift_amount);
        Elem[D[d], e, esize] = result<size-1:0>;
```

## Exceptions

Undefined Instruction, Hyp Trap.

## Pseudo-instructions

VSHRN.I<size> <Dd>, <Qm>, #0 is a synonym for VMOVN.I<size> <Dd>, <Qm>

For details see [VMOVN on page A8-952](#).

## A8.8.400 VSLI

Vector Shift Left and Insert takes each element in the operand vector, left shifts them by an immediate value, and inserts the results in the destination vector. Bits shifted out of the left of each element are lost.

The elements must all be the same size, and can be 8-bit, 16-bit, 32-bit, or 64-bit. There is no distinction between data types.

Depending on settings in the CPACR, NSACR, and HCPTR registers, and the security state and mode in which the instruction is executed, an attempt to execute the instruction might be UNDEFINED, or trapped to Hyp mode. [Summary of access controls for Advanced SIMD functionality on page B1-1232](#) summarizes these controls.

ARM deprecates the conditional execution of any Advanced SIMD instruction encoding that is not also available as a VFP instruction encoding, see [Conditional execution on page A8-288](#).

### Encoding T1/A1 Advanced SIMD

VSLI<c>.<size> <Qd>, <Qm>, #<imm>

VSLI<c>.<size> <Dd>, <Dm>, #<imm>

15	14	13	12	11	10	9	8	7	6	5	4	3	2	1	0	15	14	13	12	11	10	9	8	7	6	5	4	3	2	1	0
1	1	1	1	1	1	1	1	1	D	imm6						Vd	0	1	0	1	L	Q	M	1	Vm						
31	30	29	28	27	26	25	24	23	22	21	20	19	18	17	16	15	14	13	12	11	10	9	8	7	6	5	4	3	2	1	0
1	1	1	1	0	0	1	1	1	D	imm6						Vd	0	1	0	1	L	Q	M	1	Vm						

```

if (L:imm6) IN "0001xxx" then SEE "Related encodings";
if Q == '1' && (Vd<0> == '1' || Vm<0> == '1') then UNDEFINED;
case L:imm6 of
  when "0001xxx" esize = 8; elements = 8; shift_amount = UInt(imm6) - 8;
  when "001xxxx" esize = 16; elements = 4; shift_amount = UInt(imm6) - 16;
  when "01xxxxx" esize = 32; elements = 2; shift_amount = UInt(imm6) - 32;
  when "1xxxxxx" esize = 64; elements = 1; shift_amount = UInt(imm6);
d = UInt(D:Vd); m = UInt(M:Vm); regs = if Q == '0' then 1 else 2;

```

**Related encodings** See [One register and a modified immediate value on page A7-269](#).

## Assembler syntax

VSLI{<C>}{<q>}.<size> {<Qd>}, <Qm>, #<imm> Encoded as Q = 1  
VSLI{<C>}{<q>}.<size> {<Dd>}, <Dm>, #<imm> Encoded as Q = 0

where:

<C>, <q> See [Standard assembler syntax fields on page A8-287](#). An ARM VSLI instruction must be unconditional. ARM strongly recommends that a Thumb VSLI instruction is unconditional, see [Conditional execution on page A8-288](#).

<size> The data size for the elements of the vectors. It must be one of:  
8 Encoded as L = 0, imm6<5:3> = 0b001. <imm> is encoded in imm6<2:0>.  
16 Encoded as L = 0, imm6<5:4> = 0b01. <imm> is encoded in imm6<3:0>.  
32 Encoded as L = 0, imm6<5> = 0b1. <imm> is encoded in imm6<4:0>.  
64 Encoded as L = 1. <imm> is encoded in imm6<5:0>.

<Qd>, <Qm> The destination vector, and the operand vector, for a quadword operation.

<Dd>, <Dm> The destination vector, and the operand vector, for a doubleword operation.

<imm> The immediate value, in the range 0 to <size>-1. See the description of <size> for how <imm> is encoded.

## Operation

```
if ConditionPassed() then
    EncodingSpecificOperations(); CheckAdvSIMDEnabled();
    mask = LSL(Ones(esize), shift_amount);
    for r = 0 to regs-1
        for e = 0 to elements-1
            shifted_op = LSL(Elem[D[m+r],e,esize], shift_amount);
            Elem[D[d+r],e,esize] = (Elem[D[d+r],e,esize] AND NOT(mask)) OR shifted_op;
```

## Exceptions

Undefined Instruction, Hyp Trap.

### A8.8.401 VSQRT

This instruction calculates the square root of the value in a floating-point register and writes the result to another floating-point register.

Depending on settings in the [CPACR](#), [NSACR](#), [HCPTR](#), and [FPEXC](#) registers, and the security state and mode in which the instruction is executed, an attempt to execute the instruction might be UNDEFINED, or trapped to Hyp mode. [Summary of general controls of CP10 and CP11 functionality on page B1-1230](#) summarizes these controls.

**Encoding T1/A1** VFPv2, VFPv3, VFPv4 (sz = 1 UNDEFINED in single-precision only variants)

VSQRT<c>.F64 <Dd>, <Dm>

VSQRT<c>.F32 <Sd>, <Sm>

15	14	13	12	11	10	9	8	7	6	5	4	3	2	1	0	15	14	13	12	11	10	9	8	7	6	5	4	3	2	1	0
1	1	1	0	1	1	1	0	1	D	1	1	0	0	0	1	Vd	1	0	1	sz	1	1	M	0	Vm						
31	30	29	28	27	26	25	24	23	22	21	20	19	18	17	16	15	14	13	12	11	10	9	8	7	6	5	4	3	2	1	0
cond		1	1	1	0	1	D	1	1	0	0	0	1	Vd	1	0	1	sz	1	1	M	0	Vm								

```
if FPSCR.Len != '000' || FPSCR.Stride != '00' then SEE "VFP vectors";
dp_operation = (sz == '1');
d = if dp_operation then UInt(D:Vd) else UInt(Vd:D);
m = if dp_operation then UInt(M:Vm) else UInt(Vm:M);
```

**VFP vectors** This instruction can operate on VFP vectors under control of the [FPSCR](#). {Len, Stride} fields. For details see [Appendix K VFP Vector Operation Support](#).

## Assembler syntax

VSQRT{<c>}{<q>}.F64 <Dd>, <Dm> Encoded as sz = 1  
VSQRT{<c>}{<q>}.F32 <Sd>, <Sm> Encoded as sz = 0

where:

<c>, <q> See *Standard assembler syntax fields* on page A8-287.  
<Dd>, <Dm> The destination vector and the operand vector, for a double-precision operation.  
<Sd>, <Sm> The destination vector and the operand vector, for a single-precision operation.

## Operation

```
if ConditionPassed() then
    EncodingSpecificOperations(); CheckVFPEnabled(TRUE);
    if dp_operation then
        D[d] = FPSqrt(D[m]);
    else
        S[d] = FPSqrt(S[m]);
```

## Exceptions

Undefined Instruction, Hyp Trap.

### *Floating-point exceptions*

Invalid Operation, Inexact, Input Denormal.

## A8.8.402 VSRA

Vector Shift Right and Accumulate takes each element in a vector, right shifts them by an immediate value, and accumulates the truncated results into the destination vector. (For rounded results, see *VRSRA* on page A8-1042.)

The operand and result elements must all be the same type, and can be any one of:

- 8-bit, 16-bit, 32-bit, or 64-bit signed integers.
- 8-bit, 16-bit, 32-bit, or 64-bit unsigned integers.

Depending on settings in the *CPACR*, *NSACR*, and *HCPTR* registers, and the security state and mode in which the instruction is executed, an attempt to execute the instruction might be UNDEFINED, or trapped to Hyp mode.

*Summary of access controls for Advanced SIMD functionality* on page B1-1232 summarizes these controls.

ARM deprecates the conditional execution of any Advanced SIMD instruction encoding that is not also available as a VFP instruction encoding, see *Conditional execution* on page A8-288.

### Encoding T1/A1 Advanced SIMD

VSRA<c>.<type><size> <Qd>, <Qm>, #<imm>

VSRA<c>.<type><size> <Dd>, <Dm>, #<imm>

15	14	13	12	11	10	9	8	7	6	5	4	3	2	1	0	15	14	13	12	11	10	9	8	7	6	5	4	3	2	1	0
1	1	1	U	1	1	1	1	1	D	imm6						Vd	0	0	0	1	L	Q	M	1	Vm						

31	30	29	28	27	26	25	24	23	22	21	20	19	18	17	16	15	14	13	12	11	10	9	8	7	6	5	4	3	2	1	0
1	1	1	1	0	0	1	U	1	D	imm6						Vd	0	0	0	1	L	Q	M	1	Vm						

```

if (L:imm6) IN "0000xxx" then SEE "Related encodings";
if Q == '1' && (Vd<0> == '1' || Vm<0> == '1') then UNDEFINED;
case L:imm6 of
  when "0001xxx" esize = 8; elements = 8; shift_amount = 16 - UInt(imm6);
  when "001xxxx" esize = 16; elements = 4; shift_amount = 32 - UInt(imm6);
  when "01xxxxx" esize = 32; elements = 2; shift_amount = 64 - UInt(imm6);
  when "1xxxxxx" esize = 64; elements = 1; shift_amount = 64 - UInt(imm6);
unsigned = (U == '1'); d = UInt(D:Vd); m = UInt(M:Vm); regs = if Q == '0' then 1 else 2;

```

**Related encodings** See *One register and a modified immediate value* on page A7-269.



## Assembler syntax

VSRA{<c>}{<q>}.<type><size> {<Qd>,<Qm>,<imm>} Encoded as Q = 1  
VSRA{<c>}{<q>}.<type><size> {<Dd>,<Dm>,<imm>} Encoded as Q = 0

where:

<c>, <q> See [Standard assembler syntax fields on page A8-287](#). An ARM VSRA instruction must be unconditional. ARM strongly recommends that a Thumb VSRA instruction is unconditional, see [Conditional execution on page A8-288](#).

<type> The data type for the elements of the vectors. It must be one of:  
S Signed, encoded as U = 0.  
U Unsigned, encoded as U = 1.

<size> The data size for the elements of the vectors. It must be one of:  
8 Encoded as L = 0, imm6<5:3> = 0b001. (8 - <imm>) is encoded in imm6<2:0>.  
16 Encoded as L = 0, imm6<5:4> = 0b01. (16 - <imm>) is encoded in imm6<3:0>.  
32 Encoded as L = 0, imm6<5> = 0b1. (32 - <imm>) is encoded in imm6<4:0>.  
64 Encoded as L = 1. (64 - <imm>) is encoded in imm6<5:0>.

<Qd>, <Qm> The destination vector, and the operand vector, for a quadword operation.

<Dd>, <Dm> The destination vector, and the operand vector, for a doubleword operation.

<imm> The immediate value, in the range 1 to <size>. See the description of <size> for how <imm> is encoded.

## Operation

```
if ConditionPassed() then
    EncodingSpecificOperations(); CheckAdvSIMDEnabled();
    for r = 0 to regs-1
        for e = 0 to elements-1
            result = Int(Elem[D[m+r],e,esize], unsigned) >> shift_amount;
            Elem[D[d+r],e,esize] = Elem[D[d+r],e,esize] + result;
```

## Exceptions

Undefined Instruction, Hyp Trap.

### A8.8.403 VSRI

Vector Shift Right and Insert takes each element in the operand vector, right shifts them by an immediate value, and inserts the results in the destination vector. Bits shifted out of the right of each element are lost.

The elements must all be the same size, and can be 8-bit, 16-bit, 32-bit, or 64-bit. There is no distinction between data types.

Depending on settings in the CPACR, NSACR, and HCPTR registers, and the security state and mode in which the instruction is executed, an attempt to execute the instruction might be UNDEFINED, or trapped to Hyp mode.

[Summary of access controls for Advanced SIMD functionality on page B1-1232](#) summarizes these controls.

ARM deprecates the conditional execution of any Advanced SIMD instruction encoding that is not also available as a VFP instruction encoding, see [Conditional execution on page A8-288](#).

#### Encoding T1/A1 Advanced SIMD

VSRI<c>.<size> <Qd>, <Qm>, #<imm>

VSRI<c>.<size> <Dd>, <Dm>, #<imm>

15	14	13	12	11	10	9	8	7	6	5	4	3	2	1	0	15	14	13	12	11	10	9	8	7	6	5	4	3	2	1	0
1	1	1	1	1	1	1	1	1	D	imm6						Vd	0	1	0	0	L	Q	M	1	Vm						
31	30	29	28	27	26	25	24	23	22	21	20	19	18	17	16	15	14	13	12	11	10	9	8	7	6	5	4	3	2	1	0
1	1	1	1	0	0	1	1	1	D	imm6						Vd	0	1	0	0	L	Q	M	1	Vm						

```

if (L:imm6) IN "0001xxx" then SEE "Related encodings";
if Q == '1' && (Vd<0> == '1' || Vm<0> == '1') then UNDEFINED;
case L:imm6 of
  when "0001xxx" esize = 8; elements = 8; shift_amount = 16 - UInt(imm6);
  when "001xxxx" esize = 16; elements = 4; shift_amount = 32 - UInt(imm6);
  when "01xxxxx" esize = 32; elements = 2; shift_amount = 64 - UInt(imm6);
  when "1xxxxxx" esize = 64; elements = 1; shift_amount = 64 - UInt(imm6);
d = UInt(D:Vd); m = UInt(M:Vm); regs = if Q == '0' then 1 else 2;

```

**Related encodings** See [One register and a modified immediate value on page A7-269](#).

## Assembler syntax

VSRI{<C>}{<q>}.<size> {<Qd>}, <Qm>, #<imm> Encoded as Q = 1  
VSRI{<C>}{<q>}.<size> {<Dd>}, <Dm>, #<imm> Encoded as Q = 0

where:

<C>, <q> See [Standard assembler syntax fields on page A8-287](#). An ARM VSRI instruction must be unconditional. ARM strongly recommends that a Thumb VSRI instruction is unconditional, see [Conditional execution on page A8-288](#).

<size> The data size for the elements of the vectors. It must be one of:  
8 Encoded as L = 0, imm6<5:3> = 0b001. (8 – <imm>) is encoded in imm6<2:0>.  
16 Encoded as L = 0, imm6<5:4> = 0b01. (16 – <imm>) is encoded in imm6<3:0>.  
32 Encoded as L = 0, imm6<5> = 0b1. (32 – <imm>) is encoded in imm6<4:0>.  
64 Encoded as L = 1. (64 – <imm>) is encoded in imm6<5:0>.

<Qd>, <Qm> The destination vector, and the operand vector, for a quadword operation.

<Dd>, <Dm> The destination vector, and the operand vector, for a doubleword operation.

<imm> The immediate value, in the range 1 to <size>. See the description of <size> for how <imm> is encoded.

## Operation

```
if ConditionPassed() then
    EncodingSpecificOperations(); CheckAdvSIMDEnabled();
    mask = LSR(Ones(esize), shift_amount);
    for r = 0 to regs-1
        for e = 0 to elements-1
            shifted_op = LSR(Elem[D[m+r],e,esize], shift_amount);
            Elem[D[d+r],e,esize] = (Elem[D[d+r],e,esize] AND NOT(mask)) OR shifted_op;
```

## Exceptions

Undefined Instruction, Hyp Trap.

### A8.8.404 VST1 (multiple single elements)

Vector Store (multiple single elements) stores elements to memory from one, two, three, or four registers, without interleaving. Every element of each register is stored. For details of the addressing mode see [Advanced SIMD addressing mode on page A7-277](#).

Depending on settings in the CPACR, NSACR, and HCPTR registers, and the security state and mode in which the instruction is executed, an attempt to execute the instruction might be UNDEFINED, or trapped to Hyp mode. [Summary of access controls for Advanced SIMD functionality on page B1-1232](#) summarizes these controls.

ARM deprecates the conditional execution of any Advanced SIMD instruction encoding that is not also available as a VFP instruction encoding, see [Conditional execution on page A8-288](#).

#### Encoding T1/A1 Advanced SIMD

VST1<c>.<size> <list>, [<Rn>{:<align>}]{!}

VST1<c>.<size> <list>, [<Rn>{:<align>}], <Rm>

15	14	13	12	11	10	9	8	7	6	5	4	3	2	1	0	15	14	13	12	11	10	9	8	7	6	5	4	3	2	1	0
1	1	1	1	1	0	0	1	0	D	0	0		Rn			Vd		type	size	align				Rm							

31	30	29	28	27	26	25	24	23	22	21	20	19	18	17	16	15	14	13	12	11	10	9	8	7	6	5	4	3	2	1	0
1	1	1	1	0	1	0	0	0	D	0	0		Rn			Vd		type	size	align				Rm							

```

case type of
  when '0111'
    regs = 1; if align<1> == '1' then UNDEFINED;
  when '1010'
    regs = 2; if align == '11' then UNDEFINED;
  when '0110'
    regs = 3; if align<1> == '1' then UNDEFINED;
  when '0010'
    regs = 4;
  otherwise
    SEE "Related encodings";
alignment = if align == '00' then 1 else 4 << UInt(align);
ebytes = 1 << UInt(size); esize = 8 * ebytes; elements = 8 DIV ebytes;
d = UInt(D:Vd); n = UInt(Rn); m = UInt(Rm);
wback = (m != 15); register_index = (m != 15 && m != 13);
if n == 15 || d+regs > 32 then UNPREDICTABLE;

```

**Related encodings** See [Advanced SIMD element or structure load/store instructions on page A7-275](#).

#### Assembler syntax

VST1{<c>}{<q>}.<size> <list>, [<Rn>{:<align>}]	Encoded as Rm = 0b1111
VST1{<c>}{<q>}.<size> <list>, [<Rn>{:<align>}]!	Encoded as Rm = 0b1101
VST1{<c>}{<q>}.<size> <list>, [<Rn>{:<align>}], <Rm>	Rm cannot be 0b11x1

where:

<c>, <q> See [Standard assembler syntax fields on page A8-287](#). An ARM VST1 instruction must be unconditional. ARM strongly recommends that a Thumb VST1 instruction is unconditional, see [Conditional execution on page A8-288](#).

<size> The data size. It must be one of:

8	Encoded as size = 0b00.
16	Encoded as size = 0b01.
32	Encoded as size = 0b10.
64	Encoded as size = 0b11.

- <list> The list of registers to store. It must be one of:
- {<Dd>} Encoded as D:Vd = <Dd>, type = 0b0111.
  - {<Dd>, <Dd+1>} Encoded as D:Vd = <Dd>, type = 0b1010.
  - {<Dd>, <Dd+1>, <Dd+2>} Encoded as D:Vd = <Dd>, type = 0b0110.
  - {<Dd>, <Dd+1>, <Dd+2>, <Dd+3>} Encoded as D:Vd = <Dd>, type = 0b0010.
- <Rn> Contains the base address for the access.
- <align> The alignment. It can be one of:
- 64 8-byte alignment, encoded as align = 0b01.
  - 128 16-byte alignment, available only if <list> contains two or four registers, encoded as align = 0b10.
  - 256 32-byte alignment, available only if <list> contains four registers, encoded as align = 0b11.
  - omitted** Standard alignment, see *Unaligned data access on page A3-108*. Encoded as align = 0b00.
- : is the preferred separator before the <align> value, but the alignment can be specified as @<align>, see *Advanced SIMD addressing mode on page A7-277*.
- ! If present, specifies writeback.
- <Rm> Contains an address offset applied after the access.

For more information about <Rn>, !, and <Rm>, see *Advanced SIMD addressing mode on page A7-277*.

## Operation

```

if ConditionPassed() then
    EncodingSpecificOperations(); CheckAdvSIMDEnabled(); NullCheckIfThumbEE(n);
    address = R[n]; if (address MOD alignment) != 0 then GenerateAlignmentException();
    if wback then R[n] = R[n] + (if register_index then R[m] else 8*regs);
    for r = 0 to regs-1
        for e = 0 to elements-1
            if ebytes != 8 then
                MemU[address,ebytes] = Elem[D[d+r],e,esize];
            else
                data =Elem[D[d+r],e,esize];
                MemU[address,4] = if BigEndian() then data<63:32> else data<31:0>;
                MemU[address+4,4] = if BigEndian() then data<31:0> else data<63:32>;
                address = address + ebytes;

```

## Exceptions

Undefined Instruction, Hyp Trap, Data Abort.

### A8.8.405 VST1 (single element from one lane)

This instruction stores one element to memory from one element of a register. For details of the addressing mode see [Advanced SIMD addressing mode on page A7-277](#).

Depending on settings in the CPACR, NSACR, and HCPTR registers, and the security state and mode in which the instruction is executed, an attempt to execute the instruction might be UNDEFINED, or trapped to Hyp mode. [Summary of access controls for Advanced SIMD functionality on page B1-1232](#) summarizes these controls.

ARM deprecates the conditional execution of any Advanced SIMD instruction encoding that is not also available as a VFP instruction encoding, see [Conditional execution on page A8-288](#).

#### Encoding T1/A1 Advanced SIMD

VST1<c>.<size> <list>, [<Rn>{:<align>}]{!}

VST1<c>.<size> <list>, [<Rn>{:<align>}], <Rm>

15	14	13	12	11	10	9	8	7	6	5	4	3	2	1	0	15	14	13	12	11	10	9	8	7	6	5	4	3	2	1	0
1	1	1	1	1	0	0	1	1	D	0	0		Rn			Vd		size	0	0	index_align			Rm							

31	30	29	28	27	26	25	24	23	22	21	20	19	18	17	16	15	14	13	12	11	10	9	8	7	6	5	4	3	2	1	0
1	1	1	1	0	1	0	0	1	D	0	0		Rn			Vd		size	0	0	index_align			Rm							

```

if size == '11' then UNDEFINED;
case size of
  when '00'
    if index_align<0> != '0' then UNDEFINED;
    ebytes = 1; esize = 8; index = UInt(index_align<3:1>); alignment = 1;
  when '01'
    if index_align<1> != '0' then UNDEFINED;
    ebytes = 2; esize = 16; index = UInt(index_align<3:2>);
    alignment = if index_align<0> == '0' then 1 else 2;
  when '10'
    if index_align<2> != '0' then UNDEFINED;
    if index_align<1:0> != '00' && index_align<1:0> != '11' then UNDEFINED;
    ebytes = 4; esize = 32; index = UInt(index_align<3>);
    alignment = if index_align<1:0> == '00' then 1 else 4;
d = UInt(D:Vd); n = UInt(Rn); m = UInt(Rm);
wback = (m != 15); register_index = (m != 15 && m != 13);
if n == 15 then UNPREDICTABLE;

```

## Assembler syntax

VST1{<c>}{<q>}.<size> <list>, [<Rn>{:<align>}] Encoded as Rm = 0b1111  
VST1{<c>}{<q>}.<size> <list>, [<Rn>{:<align>}]! Encoded as Rm = 0b1101  
VST1{<c>}{<q>}.<size> <list>, [<Rn>{:<align>}], <Rm> Rm cannot be 0b11x1

where:

<c>, <q> See [Standard assembler syntax fields on page A8-287](#). An ARM VST1 instruction must be unconditional. ARM strongly recommends that a Thumb VST1 instruction is unconditional, see [Conditional execution on page A8-288](#).

<size> The data size. It must be one of:  
8 Encoded as size = 0b00.  
16 Encoded as size = 0b01.  
32 Encoded as size = 0b10.

<list> The register containing the element to store. It must be {<Dd[x]>}. The register Dd is encoded in D:Vd

<Rn> Contains the base address for the access.

<align> The alignment. It can be one of:  
16 2-byte alignment, available only if <size> is 16.  
32 4-byte alignment, available only if <size> is 32.  
**omitted** Standard alignment, see [Unaligned data access on page A3-108](#).  
: is the preferred separator before the <align> value, but the alignment can be specified as @<align>, see [Advanced SIMD addressing mode on page A7-277](#).

! If present, specifies writeback.

<Rm> Contains an address offset applied after the access.

For more information about <Rn>, !, and <Rm>, see [Advanced SIMD addressing mode on page A7-277](#).

[Table A8-9](#) shows the encoding of index and alignment for different <size> values.

**Table A8-9 Encoding of index and alignment**

	<size> == 8	<size> == 16	<size> == 32
Index	index_align[3:1] = x	index_align[3:2] = x	index_align[3] = x
<align> omitted	index_align[0] = 0	index_align[1:0] = '00'	index_align[2:0] = '000'
<align> == 16	-	index_align[1:0] = '01'	-
<align> == 32	-	-	index_align[2:0] = '011'

## Operation

```
if ConditionPassed() then
    EncodingSpecificOperations(); CheckAdvSIMDEnabled(); NullCheckIfThumbEE(n);
    address = R[n]; if (address MOD alignment) != 0 then GenerateAlignmentException();
    if wback then R[n] = R[n] + (if register_index then R[m] else ebytes);
    MemU[address,ebytes] = Elem[D[d],index,esize];
```

## Exceptions

Undefined Instruction, Hyp Trap, Data Abort.

### A8.8.406 VST2 (multiple 2-element structures)

This instruction stores multiple 2-element structures from two or four registers to memory, with interleaving. For more information, see *Element and structure load/store instructions* on page A4-181. Every element of each register is saved. For details of the addressing mode see *Advanced SIMD addressing mode* on page A7-277.

Depending on settings in the CPACR, NSACR, and HCPTR registers, and the security state and mode in which the instruction is executed, an attempt to execute the instruction might be UNDEFINED, or trapped to Hyp mode. *Summary of access controls for Advanced SIMD functionality* on page B1-1232 summarizes these controls.

ARM deprecates the conditional execution of any Advanced SIMD instruction encoding that is not also available as a VFP instruction encoding, see *Conditional execution* on page A8-288.

#### Encoding T1/A1 Advanced SIMD

VST2<c>.<size> <list>, [<Rn>{:<align>}]{!}

VST2<c>.<size> <list>, [<Rn>{:<align>}], <Rm>

15	14	13	12	11	10	9	8	7	6	5	4	3	2	1	0	15	14	13	12	11	10	9	8	7	6	5	4	3	2	1	0
1	1	1	1	1	0	0	1	0	D	0	0		Rn			Vd			type		size	align			Rm						

31	30	29	28	27	26	25	24	23	22	21	20	19	18	17	16	15	14	13	12	11	10	9	8	7	6	5	4	3	2	1	0
1	1	1	1	0	1	0	0	0	D	0	0		Rn			Vd			type		size	align			Rm						

```

if size == '11' then UNDEFINED;
case type of
  when '1000'
    regs = 1; inc = 1; if align == '11' then UNDEFINED;
  when '1001'
    regs = 1; inc = 2; if align == '11' then UNDEFINED;
  when '0011'
    regs = 2; inc = 2;
  otherwise
    SEE "Related encodings";
alignment = if align == '00' then 1 else 4 << UInt(align);
ebytes = 1 << UInt(size); esize = 8 * ebytes; elements = 8 DIV ebytes;
d = UInt(D:Vd); d2 = d + inc; n = UInt(Rn); m = UInt(Rm);
wback = (m != 15); register_index = (m != 15 && m != 13);
if n == 15 || d2+regs > 32 then UNPREDICTABLE;

```

**Related encodings** See *Advanced SIMD element or structure load/store instructions* on page A7-275.



## Assembler syntax

VST2{<C>}{<q>}.<size> <list>, [<Rn>{:<align>}]	Encoded as Rm = 0b1111
VST2{<C>}{<q>}.<size> <list>, [<Rn>{:<align>}]!	Encoded as Rm = 0b1101
VST2{<C>}{<q>}.<size> <list>, [<Rn>{:<align>}], <Rm>	Rm cannot be 0b11x1

where:

<C>, <q>	See <a href="#">Standard assembler syntax fields on page A8-287</a> . An ARM VST2 instruction must be unconditional. ARM strongly recommends that a Thumb VST2 instruction is unconditional, see <a href="#">Conditional execution on page A8-288</a> .
<size>	The data size. It must be one of: 8            Encoded as size = 0b00. 16          Encoded as size = 0b01. 32          Encoded as size = 0b10.
<list>	The list of registers to store. It must be one of: {<Dd>, <Dd+1>}        Encoded as D:Vd = <Dd>, type = 0b1000. {<Dd>, <Dd+2>}        Encoded as D:Vd = <Dd>, type = 0b1001. {<Dd>, <Dd+1>, <Dd+2>, <Dd+3>} Encoded as D:Vd = <Dd>, type = 0b0011.
<Rn>	Contains the base address for the access.
<align>	The alignment. It can be one of: 64            8-byte alignment, encoded as align = 0b01. 128          16-byte alignment, encoded as align = 0b10. 256          32-byte alignment, available only if <list> contains four registers, encoded as align = 0b11. <b>omitted</b> Standard alignment, see <a href="#">Unaligned data access on page A3-108</a> . Encoded as align = 0b00. : is the preferred separator before the <align> value, but the alignment can be specified as @<align>, see <a href="#">Advanced SIMD addressing mode on page A7-277</a> .
!	If present, specifies writeback.
<Rm>	Contains an address offset applied after the access.

For more information about <Rn>, !, and <Rm>, see [Advanced SIMD addressing mode on page A7-277](#).

## Operation

```

if ConditionPassed() then
    EncodingSpecificOperations(); CheckAdvSIMDEnabled(); NullCheckIfThumbEE(n);
    address = R[n]; if (address MOD alignment) != 0 then GenerateAlignmentException();
    if wback then R[n] = R[n] + (if register_index then R[m] else 16*regs);
    for r = 0 to regs-1
        for e = 0 to elements-1
            MemU[address,ebytes] = Elem[D[d+r],e,esize];
            MemU[address+ebytes,ebytes] = Elem[D[d2+r],e,esize];
            address = address + 2*ebytes;
  
```

## Exceptions

Undefined Instruction, Hyp Trap, Data Abort.

### A8.8.407 VST2 (single 2-element structure from one lane)

This instruction stores one 2-element structure to memory from corresponding elements of two registers. For details of the addressing mode see *Advanced SIMD addressing mode* on page A7-277.

Depending on settings in the CPACR, NSACR, and HCPTR registers, and the security state and mode in which the instruction is executed, an attempt to execute the instruction might be UNDEFINED, or trapped to Hyp mode. *Summary of access controls for Advanced SIMD functionality* on page B1-1232 summarizes these controls.

ARM deprecates the conditional execution of any Advanced SIMD instruction encoding that is not also available as a VFP instruction encoding, see *Conditional execution* on page A8-288.

#### Encoding T1/A1 Advanced SIMD

VST2<c>.<size> <list>, [<Rn>{:<align>}]{!}

VST2<c>.<size> <list>, [<Rn>{:<align>}], <Rm>

15	14	13	12	11	10	9	8	7	6	5	4	3	2	1	0	15	14	13	12	11	10	9	8	7	6	5	4	3	2	1	0
1	1	1	1	1	0	0	1	1	D	0	0		Rn			Vd			size	0	1	index_align				Rm					

31	30	29	28	27	26	25	24	23	22	21	20	19	18	17	16	15	14	13	12	11	10	9	8	7	6	5	4	3	2	1	0
1	1	1	1	0	1	0	0	1	D	0	0		Rn			Vd			size	0	1	index_align							Rm		

```

if size == '11' then UNDEFINED;
case size of
  when '00'
    ebytes = 1; esize = 8; index = UInt(index_align<3:1>); inc = 1;
    alignment = if index_align<0> == '0' then 1 else 2;
  when '01'
    ebytes = 2; esize = 16; index = UInt(index_align<3:2>);
    inc = if index_align<1> == '0' then 1 else 2;
    alignment = if index_align<0> == '0' then 1 else 4;
  when '10'
    if index_align<1> != '0' then UNDEFINED;
    ebytes = 4; esize = 32; index = UInt(index_align<3>);
    inc = if index_align<2> == '0' then 1 else 2;
    alignment = if index_align<0> == '0' then 1 else 8;
d = UInt(D:Vd); d2 = d + inc; n = UInt(Rn); m = UInt(Rm);
wback = (m != 15); register_index = (m != 15 && m != 13);
if n == 15 || d2 > 31 then UNPREDICTABLE;

```

#### Assembler syntax

VST2{<c>}{<q>}.<size> <list>, [<Rn>{:<align>}]	Encoded as Rm = 0b1111
VST2{<c>}{<q>}.<size> <list>, [<Rn>{:<align>}]!	Encoded as Rm = 0b1101
VST2{<c>}{<q>}.<size> <list>, [<Rn>{:<align>}], <Rm>	Rm cannot be 0b11x1

where:

<c>, <q> See *Standard assembler syntax fields* on page A8-287. An ARM VST2 instruction must be unconditional. ARM strongly recommends that a Thumb VST2 instruction is unconditional, see *Conditional execution* on page A8-288.

<size> The data size. It must be one of:  
8 Encoded as size = 0b00.  
16 Encoded as size = 0b01.  
32 Encoded as size = 0b10.

<list> The registers containing the structure. Encoded with D:Vd = <Dd>. It must be one of:  
{<Dd[x]>, <Dd+1[x]>} Single-spaced registers, see Table A8-10 on page A8-1071.  
{<Dd[x]>, <Dd+2[x]>} Double-spaced registers, see Table A8-10 on page A8-1071. This is not available if <size> == 8.

- <Rn> Contains the base address for the access.
- <align> The alignment. It can be one of:  
 16 2-byte alignment, available only if <size> is 8  
 32 4-byte alignment, available only if <size> is 16  
 64 8-byte alignment, available only if <size> is 32  
**omitted** Standard alignment, see [Unaligned data access on page A3-108](#).  
 : is the preferred separator before the <align> value, but the alignment can be specified as @<align>, see [Advanced SIMD addressing mode on page A7-277](#).
- ! If present, specifies writeback.
- <Rm> Contains an address offset applied after the access.

For more information about <Rn>, !, and <Rm>, see [Advanced SIMD addressing mode on page A7-277](#).

**Table A8-10 Encoding of index, alignment, and register spacing**

	<size> == 8	<size> == 16	<size> == 32
Index	index_align[3:1] = x	index_align[3:2] = x	index_align[3] = x
Single-spacing	-	index_align[1] = 0	index_align[2] = 0
Double-spacing	-	index_align[1] = 1	index_align[2] = 1
<align> omitted	index_align[0] = 0	index_align[0] = 0	index_align[1:0] = '00'
<align> == 16	index_align[0] = 1	-	-
<align> == 32	-	index_align[0] = 1	-
<align> == 64	-	-	index_align[1:0] = '01'

## Operation

```

if ConditionPassed() then
    EncodingSpecificOperations(); CheckAdvSIMDEnabled(); NullCheckIfThumbEE(n);
    address = R[n]; if (address MOD alignment) != 0 then GenerateAlignmentException();
    if wback then R[n] = R[n] + (if register_index then R[m] else 2*ebytes);
    MemU[address,ebytes] = Elem[D[d],index,esize];
    MemU[address+ebytes,ebytes] = Elem[D[d2],index,esize];
    
```

## Exceptions

Undefined Instruction, Hyp Trap, Data Abort.

### A8.8.408 VST3 (multiple 3-element structures)

This instruction stores multiple 3-element structures to memory from three registers, with interleaving. For more information, see [Element and structure load/store instructions on page A4-181](#). Every element of each register is saved. For details of the addressing mode see [Advanced SIMD addressing mode on page A7-277](#).

Depending on settings in the CPACR, NSACR, and HCPTR registers, and the security state and mode in which the instruction is executed, an attempt to execute the instruction might be UNDEFINED, or trapped to Hyp mode. [Summary of access controls for Advanced SIMD functionality on page B1-1232](#) summarizes these controls.

ARM deprecates the conditional execution of any Advanced SIMD instruction encoding that is not also available as a VFP instruction encoding, see [Conditional execution on page A8-288](#).

#### Encoding T1/A1 Advanced SIMD

VST3<c>.<size> <list>, [<Rn>{:<align>}]{!}

VST3<c>.<size> <list>, [<Rn>{:<align>}], <Rm>

15	14	13	12	11	10	9	8	7	6	5	4	3	2	1	0	15	14	13	12	11	10	9	8	7	6	5	4	3	2	1	0
1	1	1	1	1	0	0	1	0	D	0	0			Rn		Vd		type	size	align			Rm								

31	30	29	28	27	26	25	24	23	22	21	20	19	18	17	16	15	14	13	12	11	10	9	8	7	6	5	4	3	2	1	0
1	1	1	1	0	1	0	0	0	D	0	0			Rn		Vd		type	size	align			Rm								

```

if size == '11' || align<1> == '1' then UNDEFINED;
case type of
  when '0100'
    inc = 1;
  when '0101'
    inc = 2;
  otherwise
    SEE "Related encodings";
alignment = if align<0> == '0' then 1 else 8;
ebytes = 1 << UInt(size); esize = 8 * ebytes; elements = 8 DIV ebytes;
d = UInt(D:Vd); d2 = d + inc; d3 = d2 + inc; n = UInt(Rn); m = UInt(Rm);
wback = (m != 15); register_index = (m != 15 && m != 13);
if n == 15 || d3 > 31 then UNPREDICTABLE;

```

**Related encodings** See [Advanced SIMD element or structure load/store instructions on page A7-275](#).

## Assembler syntax

VST3{<c>}{<q>}.<size> <list>, [<Rn>{:<align>}]	Encoded as Rm = 0b1111
VST3{<c>}{<q>}.<size> <list>, [<Rn>{:<align>}]!	Encoded as Rm = 0b1101
VST3{<c>}{<q>}.<size> <list>, [<Rn>{:<align>}], <Rm>	Rm cannot be 0b11x1

where:

<c>, <q>	See <a href="#">Standard assembler syntax fields on page A8-287</a> . An ARM VST3 instruction must be unconditional. ARM strongly recommends that a Thumb VST3 instruction is unconditional, see <a href="#">Conditional execution on page A8-288</a> .
<size>	The data size. It must be one of: 8            Encoded as size = 0b00. 16          Encoded as size = 0b01. 32          Encoded as size = 0b10.
<list>	The list of registers to store. It must be one of: {<Dd>, <Dd+1>, <Dd+2>} Encoded as D:Vd = <Dd>, type = 0b0100. {<Dd>, <Dd+2>, <Dd+4>} Encoded as D:Vd = <Dd>, type = 0b0101.
<Rn>	Contains the base address for the access.
<align>	The alignment. It can be: 64            8-byte alignment, encoded as align = 0b01. <b>omitted</b> Standard alignment, see <a href="#">Unaligned data access on page A3-108</a> . Encoded as align = 0b00. : is the preferred separator before the <align> value, but the alignment can be specified as @<align>, see <a href="#">Advanced SIMD addressing mode on page A7-277</a> .
!	If present, specifies writeback.
<Rm>	Contains an address offset applied after the access.

For more information about <Rn>, !, and <Rm>, see [Advanced SIMD addressing mode on page A7-277](#).

## Operation

```

if ConditionPassed() then
    EncodingSpecificOperations(); CheckAdvSIMDEnabled(); NullCheckIfThumbEE(n);
    address = R[n]; if (address MOD alignment) != 0 then GenerateAlignmentException();
    if wback then R[n] = R[n] + (if register_index then R[m] else 24);
    for e = 0 to elements-1
        MemU[address,ebytes] = Elem[D[d],e,esize];
        MemU[address+ebytes,ebytes] = Elem[D[d2],e,esize];
        MemU[address+2*ebytes,ebytes] = Elem[D[d3],e,esize];
        address = address + 3*ebytes;

```

## Exceptions

Undefined Instruction, Hyp Trap, Data Abort.

### A8.8.409 VST3 (single 3-element structure from one lane)

This instruction stores one 3-element structure to memory from corresponding elements of three registers. For details of the addressing mode see *Advanced SIMD addressing mode on page A7-277*.

Depending on settings in the CPACR, NSACR, and HCPTR registers, and the security state and mode in which the instruction is executed, an attempt to execute the instruction might be UNDEFINED, or trapped to Hyp mode. *Summary of access controls for Advanced SIMD functionality on page B1-1232* summarizes these controls.

ARM deprecates the conditional execution of any Advanced SIMD instruction encoding that is not also available as a VFP instruction encoding, see *Conditional execution on page A8-288*.

#### Encoding T1/A1 Advanced SIMD

VST3<c>.<size> <list>, [<Rn>]{!}

VST3<c>.<size> <list>, [<Rn>], <Rm>

15	14	13	12	11	10	9	8	7	6	5	4	3	2	1	0	15	14	13	12	11	10	9	8	7	6	5	4	3	2	1	0
1	1	1	1	1	0	0	1	1	D	0	0		Rn			Vd		size	1	0	index_align			Rm							

31	30	29	28	27	26	25	24	23	22	21	20	19	18	17	16	15	14	13	12	11	10	9	8	7	6	5	4	3	2	1	0
1	1	1	1	0	1	0	0	1	D	0	0		Rn			Vd		size	1	0	index_align			Rm							

```

if size == '11' then UNDEFINED;
case size of
  when '00'
    if index_align<0> != '0' then UNDEFINED;
    ebytes = 1; esize = 8; index = UInt(index_align<3:1>); inc = 1;
  when '01'
    if index_align<0> != '0' then UNDEFINED;
    ebytes = 2; esize = 16; index = UInt(index_align<3:2>);
    inc = if index_align<1> == '0' then 1 else 2;
  when '10'
    if index_align<1:0> != '00' then UNDEFINED;
    ebytes = 4; esize = 32; index = UInt(index_align<3>);
    inc = if index_align<2> == '0' then 1 else 2;
d = UInt(D:Vd); d2 = d + inc; d3 = d2 + inc; n = UInt(Rn); m = UInt(Rm);
wback = (m != 15); register_index = (m != 15 && m != 13);
if n == 15 || d3 > 31 then UNPREDICTABLE;

```

## Assembler syntax

VST3{<C>}{<q>}.<size> <list>, [<Rn>] Encoded as Rm = 0b1111  
 VST3{<C>}{<q>}.<size> <list>, [<Rn>! Encoded as Rm = 0b1101  
 VST3{<C>}{<q>}.<size> <list>, [<Rn>], <Rm> Rm cannot be 0b11x1

where:

<C>, <q> See [Standard assembler syntax fields on page A8-287](#). An ARM VST3 instruction must be unconditional. ARM strongly recommends that a Thumb VST3 instruction is unconditional, see [Conditional execution on page A8-288](#).

<size> The data size. It must be one of:  
 8 Encoded as size = 0b00.  
 16 Encoded as size = 0b01.  
 32 Encoded as size = 0b10.

<list> The registers containing the structure. Encoded with D:Vd = <Dd>. It must be one of:  
 {<Dd[x]>, <Dd+1[x]>, <Dd+2[x]>}  
 Single-spaced registers, see [Table A8-11](#).  
 {<Dd[x]>, <Dd+2[x]>, <Dd+4[x]>}  
 Double-spaced registers, see [Table A8-11](#). This is not available if <size> == 8.

<Rn> Contains the base address for the access.

! If present, specifies writeback.

<Rm> Contains an address offset applied after the access.

For more information about <Rn>, !, and <Rm>, see [Advanced SIMD addressing mode on page A7-277](#).

**Table A8-11 Encoding of index and register spacing**

	<size> == 8	<size> == 16	<size> == 32
Index	index_align[3:1] = x	index_align[3:2] = x	index_align[3] = x
Single-spacing	index_align[0] = 0	index_align[1:0] = '00'	index_align[2:0] = '000'
Double-spacing	-	index_align[1:0] = '10'	index_align[2:0] = '100'

## Alignment

Standard alignment rules apply, see [Unaligned data access on page A3-108](#).

## Operation

```
if ConditionPassed() then
  EncodingSpecificOperations(); CheckAdvSIMDEnabled(); NullCheckIfThumbEE(n);
  address = R[n];
  if wback then R[n] = R[n] + (if register_index then R[m] else 3*ebytes);
  MemU[address,ebytes] = Elem[D[d],index,esize];
  MemU[address+ebytes,ebytes] = Elem[D[d2],index,esize];
  MemU[address+2*ebytes,ebytes] = Elem[D[d3],index,esize];
```

## Exceptions

Undefined Instruction, Hyp Trap, Data Abort.

### A8.8.410 VST4 (multiple 4-element structures)

This instruction stores multiple 4-element structures to memory from four registers, with interleaving. For more information, see [Element and structure load/store instructions on page A4-181](#). Every element of each register is saved. For details of the addressing mode see [Advanced SIMD addressing mode on page A7-277](#).

Depending on settings in the CPACR, NSACR, and HCPTR registers, and the security state and mode in which the instruction is executed, an attempt to execute the instruction might be UNDEFINED, or trapped to Hyp mode. [Summary of access controls for Advanced SIMD functionality on page B1-1232](#) summarizes these controls.

ARM deprecates the conditional execution of any Advanced SIMD instruction encoding that is not also available as a VFP instruction encoding, see [Conditional execution on page A8-288](#).

#### Encoding T1/A1 Advanced SIMD

VST4<c>.<size> <list>, [<Rn>{:<align>}]{!}

VST4<c>.<size> <list>, [<Rn>{:<align>}], <Rm>

15	14	13	12	11	10	9	8	7	6	5	4	3	2	1	0	15	14	13	12	11	10	9	8	7	6	5	4	3	2	1	0
1	1	1	1	1	0	0	1	0	D	0	0		Rn			Vd			type		size	align		Rm							

31	30	29	28	27	26	25	24	23	22	21	20	19	18	17	16	15	14	13	12	11	10	9	8	7	6	5	4	3	2	1	0
1	1	1	1	0	1	0	0	0	D	0	0		Rn			Vd			type		size	align		Rm							

```

if size == '11' then UNDEFINED;
case type of
  when '0000'
    inc = 1;
  when '0001'
    inc = 2;
  otherwise
    SEE "Related encodings";
alignment = if align == '00' then 1 else 4 << UInt(align);
ebytes = 1 << UInt(size); esize = 8 * ebytes; elements = 8 DIV ebytes;
d = UInt(D:Vd); d2 = d + inc; d3 = d2 + inc; d4 = d3 + inc; n = UInt(Rn); m = UInt(Rm);
wback = (m != 15); register_index = (m != 15 && m != 13);
if n == 15 || d4 > 31 then UNPREDICTABLE;

```

**Related encodings** See [Advanced SIMD element or structure load/store instructions on page A7-275](#).



## Assembler syntax

VST4{<c>}{<q>}.<size> <list>, [<Rn>{:<align>}]	Encoded as Rm = 0b1111
VST4{<c>}{<q>}.<size> <list>, [<Rn>{:<align>}]!	Encoded as Rm = 0b1101
VST4{<c>}{<q>}.<size> <list>, [<Rn>{:<align>}], <Rm>	Rm cannot be 0b11x1

where:

<c>, <q>	See <a href="#">Standard assembler syntax fields on page A8-287</a> . An ARM VST4 instruction must be unconditional. ARM strongly recommends that a Thumb VST4 instruction is unconditional, see <a href="#">Conditional execution on page A8-288</a> .
<size>	The data size. It must be one of: 8            Encoded as size = 0b00. 16          Encoded as size = 0b01. 32          Encoded as size = 0b10.
<list>	The list of registers to store. It must be one of: {<Dd>, <Dd+1>, <Dd+2>, <Dd+3>} Encoded as D:Vd = <Dd>, type = 0b0000. {<Dd>, <Dd+2>, <Dd+4>, <Dd+6>} Encoded as D:Vd = <Dd>, type = 0b0001.
<Rn>	Contains the base address for the access.
<align>	The alignment. It can be one of: 64            8-byte alignment, encoded as align = 0b01. 128          16-byte alignment, encoded as align = 0b10. 256          32-byte alignment, encoded as align = 0b11. <b>omitted</b> Standard alignment, see <a href="#">Unaligned data access on page A3-108</a> . Encoded as align = 0b00. : is the preferred separator before the <align> value, but the alignment can be specified as @<align>, see <a href="#">Advanced SIMD addressing mode on page A7-277</a> .
!	If present, specifies writeback.
<Rm>	Contains an address offset applied after the access.

For more information about <Rn>, !, and <Rm>, see [Advanced SIMD addressing mode on page A7-277](#).

## Operation

```

if ConditionPassed() then
    EncodingSpecificOperations(); CheckAdvSIMDEnabled(); NullCheckIfThumbEE(n);
    address = R[n]; if (address MOD alignment) != 0 then GenerateAlignmentException();
    if wback then R[n] = R[n] + (if register_index then R[m] else 32);
    for e = 0 to elements-1
        MemU[address,ebytes] = Elem[D[d],e,esize];
        MemU[address+ebytes,ebytes] = Elem[D[d2],e,esize];
        MemU[address+2*ebytes,ebytes] = Elem[D[d3],e,esize];
        MemU[address+3*ebytes,ebytes] = Elem[D[d4],e,esize];
        address = address + 4*ebytes;

```

## Exceptions

Undefined Instruction, Hyp Trap, Data Abort.

### A8.8.411 VST4 (single 4-element structure from one lane)

This instruction stores one 4-element structure to memory from corresponding elements of four registers. For details of the addressing mode see *Advanced SIMD addressing mode* on page A7-277.

Depending on settings in the CPACR, NSACR, and HCPTR registers, and the security state and mode in which the instruction is executed, an attempt to execute the instruction might be UNDEFINED, or trapped to Hyp mode. *Summary of access controls for Advanced SIMD functionality* on page B1-1232 summarizes these controls.

ARM deprecates the conditional execution of any Advanced SIMD instruction encoding that is not also available as a VFP instruction encoding, see *Conditional execution* on page A8-288.

#### Encoding T1/A1 Advanced SIMD

VST4<c>.<size> <list>, [<Rn>{:<align>}]{!}

VST4<c>.<size> <list>, [<Rn>{:<align>}], <Rm>

15	14	13	12	11	10	9	8	7	6	5	4	3	2	1	0	15	14	13	12	11	10	9	8	7	6	5	4	3	2	1	0
1	1	1	1	1	0	0	1	1	D	0	0		Rn			Vd			size	1	1	index_align				Rm					

31	30	29	28	27	26	25	24	23	22	21	20	19	18	17	16	15	14	13	12	11	10	9	8	7	6	5	4	3	2	1	0
1	1	1	1	0	1	0	0	1	D	0	0		Rn			Vd			size	1	1	index_align				Rm					

```

if size == '11' then UNDEFINED;
case size of
  when '00'
    ebytes = 1; esize = 8; index = UInt(index_align<3:1>); inc = 1;
    alignment = if index_align<0> == '0' then 1 else 4;
  when '01'
    ebytes = 2; esize = 16; index = UInt(index_align<3:2>);
    inc = if index_align<1> == '0' then 1 else 2;
    alignment = if index_align<0> == '0' then 1 else 8;
  when '10'
    if index_align<1:0> == '11' then UNDEFINED;
    ebytes = 4; esize = 32; index = UInt(index_align<3>);
    inc = if index_align<2> == '0' then 1 else 2;
    alignment = if index_align<1:0> == '00' then 1 else 4 << UInt(index_align<1:0>);
d = UInt(D:Vd); d2 = d + inc; d3 = d2 + inc; d4 = d3 + inc; n = UInt(Rn); m = UInt(Rm);
wback = (m != 15); register_index = (m != 15 && m != 13);
if n == 15 || d4 > 31 then UNPREDICTABLE;

```

#### Assembler syntax

VST4{<c>}{<q>}.<size> <list>, [<Rn>{:<align>}] Encoded as Rm = 0b1111  
VST4{<c>}{<q>}.<size> <list>, [<Rn>{:<align>}]! Encoded as Rm = 0b1101  
VST4{<c>}{<q>}.<size> <list>, [<Rn>{:<align>}], <Rm> Rm cannot be 0b11x1

where:

<c>, <q> See *Standard assembler syntax fields* on page A8-287. An ARM VST4 instruction must be unconditional. ARM strongly recommends that a Thumb VST4 instruction is unconditional, see *Conditional execution* on page A8-288.

<size> The data size. It must be one of:  
8 Encoded as size = 0b00.  
16 Encoded as size = 0b01.  
32 Encoded as size = 0b10.

<list> The registers containing the structure. Encoded with D:Vd = <Dd>. It must be one of:  
{<Dd[x]>, <Dd+1[x]>, <Dd+2[x]>, <Dd+3[x]>}  
Single-spaced registers, see *Table A8-12* on page A8-1079.  
{<Dd[x]>, <Dd+2[x]>, <Dd+4[x]>, <Dd+6[x]>}  
Double-spaced registers, see *Table A8-12* on page A8-1079. This is not available if <size> == 8.

<Rn> The base address for the access.  
 <align> The alignment. It can be:  
 32 4-byte alignment, available only if <size> is 8.  
 64 8-byte alignment, available only if <size> is 16 or 32.  
 128 16-byte alignment, available only if <size> is 32.  
**omitted** Standard alignment, see [Unaligned data access on page A3-108](#).  
 : is the preferred separator before the <align> value, but the alignment can be specified as @<align>, see [Advanced SIMD addressing mode on page A7-277](#).  
 ! If present, specifies writeback.  
 <Rm> Contains an address offset applied after the access.

For more information about <Rn>, !, and <Rm>, see [Advanced SIMD addressing mode on page A7-277](#).

**Table A8-12 Encoding of index, alignment, and register spacing**

	<size> == 8	<size> == 16	<size> == 32
Index	index_align[3:1] = x	index_align[3:2] = x	index_align[3] = x
Single-spacing	-	index_align[1] = 0	index_align[2] = 0
Double-spacing	-	index_align[1] = 1	index_align[2] = 1
<align> omitted	index_align[0] = 0	index_align[0] = 0	index_align[1:0] = '00'
<align> == 32	index_align[0] = 1	-	-
<align> == 64	-	index_align[0] = 1	index_align[1:0] = '01'
<align> == 128	-	-	index_align[1:0] = '10'

## Operation

```

if ConditionPassed() then
    EncodingSpecificOperations(); CheckAdvSIMDEnabled(); NullCheckIfThumbEE(n);
    address = R[n]; if (address MOD alignment) != 0 then GenerateAlignmentException();
    if wback then R[n] = R[n] + (if register_index then R[m] else 4*ebytes);
    MemU[address,ebytes] = Elem[D[d],index,esize];
    MemU[address+ebytes,ebytes] = Elem[D[d2],index,esize];
    MemU[address+2*ebytes,ebytes] = Elem[D[d3],index,esize];
    MemU[address+3*ebytes,ebytes] = Elem[D[d4],index,esize];
    
```

## Exceptions

Undefined Instruction, Hyp Trap, Data Abort.

### A8.8.412 VSTM

Vector Store Multiple stores multiple extension registers to consecutive memory locations using an address from an ARM core register.

Depending on settings in the CPACR, NSACR, HCPTR, and FPEXC registers, and the security state and mode in which the instruction is executed, an attempt to execute the instruction might be UNDEFINED, or trapped to Hyp mode. [Summary of general controls of CP10 and CP11 functionality on page B1-1230](#) and [Summary of access controls for Advanced SIMD functionality on page B1-1232](#) summarize these controls.

#### Encoding T1/A1 VFPv2, VFPv3, VFPv4, Advanced SIMD

VSTM{mode}<c> <Rn>{!}, <list> <list> is consecutive 64-bit registers

15	14	13	12	11	10	9	8	7	6	5	4	3	2	1	0	15	14	13	12	11	10	9	8	7	6	5	4	3	2	1	0
1	1	1	0	1	1	0	P	U	D	W	0	Rn				Vd		1	0	1	1	imm8									

31	30	29	28	27	26	25	24	23	22	21	20	19	18	17	16	15	14	13	12	11	10	9	8	7	6	5	4	3	2	1	0
cond		1	1	0	P	U	D	W	0	Rn				Vd		1	0	1	1	imm8											

```

if P == '0' && U == '0' && W == '0' then SEE "Related encodings";
if P == '1' && U == '0' && W == '1' && Rn == '1101' then SEE VPUSH;
if P == '1' && W == '0' then SEE VSTR;
if P == U && W == '1' then UNDEFINED;
// Remaining combinations are PUW = 010 (IA without !), 011 (IA with !), 101 (DB with !)
single_regs = FALSE; add = (U == '1'); wback = (W == '1');
d = UInt(D:Vd); n = UInt(Rn); imm32 = ZeroExtend(imm8:'00', 32);
regs = UInt(imm8) DIV 2; // If UInt(imm8) is odd, see "FSTMX".
if n == 15 && (wback || CurrentInstrSet() != InstrSet_ARM) then UNPREDICTABLE;
if regs == 0 || regs > 16 || (d+regs) > 32 then UNPREDICTABLE;
if VFPSmallRegisterBank() && (d+regs) > 16 then UNPREDICTABLE;

```

#### Encoding T2/A2 VFPv2, VFPv3, VFPv4

VSTM{mode}<c> <Rn>{!}, <list> <list> is consecutive 32-bit registers

15	14	13	12	11	10	9	8	7	6	5	4	3	2	1	0	15	14	13	12	11	10	9	8	7	6	5	4	3	2	1	0
1	1	1	0	1	1	0	P	U	D	W	0	Rn				Vd		1	0	1	0	imm8									

31	30	29	28	27	26	25	24	23	22	21	20	19	18	17	16	15	14	13	12	11	10	9	8	7	6	5	4	3	2	1	0
cond		1	1	0	P	U	D	W	0	Rn				Vd		1	0	1	0	imm8											

```

if P == '0' && U == '0' && W == '0' then SEE "Related encodings";
if P == '1' && U == '0' && W == '1' && Rn == '1101' then SEE VPUSH;
if P == '1' && W == '0' then SEE VSTR;
if P == U && W == '1' then UNDEFINED;
// Remaining combinations are PUW = 010 (IA without !), 011 (IA with !), 101 (DB with !)
single_regs = TRUE; add = (U == '1'); wback = (W == '1'); d = UInt(Vd:D); n = UInt(Rn);
imm32 = ZeroExtend(imm8:'00', 32); regs = UInt(imm8);
if n == 15 && (wback || CurrentInstrSet() != InstrSet_ARM) then UNPREDICTABLE;
if regs == 0 || (d+regs) > 32 then UNPREDICTABLE;

```

**Related encodings** See [64-bit transfers between ARM core and extension registers on page A7-279](#).

#### FSTMX

Encoding T1/A1 behaves as described by the pseudocode if imm8 is odd. However, there is no UAL syntax for such encodings and ARM deprecates their use. For more information, see [FLDMX, FSTMX on page A8-388](#).

## Assembler syntax

VSTM{<mode>}{<c>}{<q>}{.<size>} <Rn>{!}, <list>

where:

<mode>	The addressing mode:
IA	Increment After. The consecutive addresses start at the address specified in <Rn>. This is the default and can be omitted. Encoded as P = 0, U = 1.
DB	Decrement Before. The consecutive addresses end just before the address specified in <Rn>. Encoded as P = 1, U = 0.
<c>, <q>	See <i>Standard assembler syntax fields</i> on page A8-287.
<size>	An optional data size specifier. If present, it must be equal to the size in bits, 32 or 64, of the registers in <list>.
<Rn>	The base register. The SP can be used. In the ARM instruction set, if ! is not specified the PC can be used. However, ARM deprecates use of the PC.
!	Causes the instruction to write a modified value back to <Rn>. Required if <mode> == DB. Encoded as W = 1. If ! is omitted, the instruction does not change <Rn> in this way. Encoded as W = 0.
<list>	The extension registers to be stored, as a list of consecutively numbered doubleword (encoding T1/A1) or singleword (encoding T2/A2) registers, separated by commas and surrounded by brackets. It is encoded in the instruction by setting D and Vd to specify the first register in the list, and imm8 to twice the number of registers in the list (encoding T1/A1) or the number of registers (encoding T2/A2). <list> must contain at least one register. If it contains doubleword registers it must not contain more than 16 registers.

## Operation

```

if ConditionPassed() then
    EncodingSpecificOperations(); CheckVFPEEnabled(TRUE); NullCheckIfThumbEE(n);
    address = if add then R[n] else R[n]-imm32;
    if wback then R[n] = if add then R[n]+imm32 else R[n]-imm32;
    for r = 0 to regs-1
        if single_regs then
            MemA[address,4] = S[d+r]; address = address+4;
        else
            // Store as two word-aligned words in the correct order for current endianness.
            MemA[address,4] = if BigEndian() then D[d+r]<63:32> else D[d+r]<31:0>;
            MemA[address+4,4] = if BigEndian() then D[d+r]<31:0> else D[d+r]<63:32>;
            address = address+8;

```

## Exceptions

Undefined Instruction, Hyp Trap, Data Abort.

### A8.8.413 VSTR

This instruction stores a single extension register to memory, using an address from an ARM core register, with an optional offset.

Depending on settings in the CPACR, NSACR, HCPTR, and FPEXC registers, and the security state and mode in which the instruction is executed, an attempt to execute the instruction might be UNDEFINED, or trapped to Hyp mode. [Summary of general controls of CP10 and CP11 functionality on page B1-1230](#) and [Summary of access controls for Advanced SIMD functionality on page B1-1232](#) summarize these controls.

#### Encoding T1/A1 VFPv2, VFPv3, VFPv4, Advanced SIMD

VSTR<c> <Dd>, [<Rn>{, #+/-<imm>}]

15	14	13	12	11	10	9	8	7	6	5	4	3	2	1	0	15	14	13	12	11	10	9	8	7	6	5	4	3	2	1	0
1	1	1	0	1	1	0	1	U	D	0	0	Rn				Vd		1	0	1	1	imm8									

31	30	29	28	27	26	25	24	23	22	21	20	19	18	17	16	15	14	13	12	11	10	9	8	7	6	5	4	3	2	1	0
cond		1	1	0	1	U	D	0	0	Rn				Vd		1	0	1	1	imm8											

```
single_reg = FALSE; add = (U == '1'); imm32 = ZeroExtend(imm8:'00', 32);
d = UInt(D:Vd); n = UInt(Rn);
if n == 15 && CurrentInstrSet() != InstrSet_ARM then UNPREDICTABLE;
```

#### Encoding T2/A2 VFPv2, VFPv3, VFPv4

VSTR<c> <Sd>, [<Rn>{, #+/-<imm>}]

15	14	13	12	11	10	9	8	7	6	5	4	3	2	1	0	15	14	13	12	11	10	9	8	7	6	5	4	3	2	1	0
1	1	1	0	1	1	0	1	U	D	0	0	Rn				Vd		1	0	1	0	imm8									

31	30	29	28	27	26	25	24	23	22	21	20	19	18	17	16	15	14	13	12	11	10	9	8	7	6	5	4	3	2	1	0
cond		1	1	0	1	U	D	0	0	Rn				Vd		1	0	1	0	imm8											

```
single_reg = TRUE; add = (U == '1'); imm32 = ZeroExtend(imm8:'00', 32);
d = UInt(Vd:D); n = UInt(Rn);
if n == 15 && CurrentInstrSet() != InstrSet_ARM then UNPREDICTABLE;
```

## Assembler syntax

VSTR{<C>}{<q>}{.64} <Dd>, [<Rn>{, #+/-<imm>}] Encoding T1/A1  
VSTR{<C>}{<q>}{.32} <Sd>, [<Rn>{, #+/-<imm>}] Encoding T2/A2

where:

<C>, <q> See *Standard assembler syntax fields* on page A8-287.  
.32, .64 Optional data size specifiers.  
<Dd> The source register for a doubleword store.  
<Sd> The source register for a singleword store.  
<Rn> The base register. The SP can be used. In the ARM instruction set the PC can be used. However, ARM deprecates use of the PC.  
+/- Is + or omitted if the immediate offset is to be added to the base register value (add == TRUE), or – if it is to be subtracted (add == FALSE). #0 and #-0 generate different instructions.  
<imm> The immediate offset used for forming the address. Values are multiples of 4 in the range 0-1020. <imm> can be omitted, meaning an offset of +0.

## Operation

```
if ConditionPassed() then
    EncodingSpecificOperations(); CheckVFPEnabled(TRUE); NullCheckIfThumbEE(n);
    address = if add then (R[n] + imm32) else (R[n] - imm32);
    if single_reg then
        MemA[address,4] = S[d];
    else
        // Store as two word-aligned words in the correct order for current endianness.
        MemA[address,4] = if BigEndian() then D[d]<63:32> else D[d]<31:0>;
        MemA[address+4,4] = if BigEndian() then D[d]<31:0> else D[d]<63:32>;
```

## Exceptions

Undefined Instruction, Hyp Trap, Data Abort.

### A8.8.414 VSUB (integer)

Vector Subtract subtracts the elements of one vector from the corresponding elements of another vector, and places the results in the destination vector.

Depending on settings in the CPACR, NSACR, and HCPTR registers, and the security state and mode in which the instruction is executed, an attempt to execute the instruction might be UNDEFINED, or trapped to Hyp mode. [Summary of access controls for Advanced SIMD functionality on page B1-1232](#) summarizes these controls.

ARM deprecates the conditional execution of any Advanced SIMD instruction encoding that is not also available as a VFP instruction encoding, see [Conditional execution on page A8-288](#).

#### Encoding T1/A1 Advanced SIMD

VSUB<c>.<dt> <Qd>, <Qn>, <Qm>

VSUB<c>.<dt> <Dd>, <Dn>, <Dm>

15	14	13	12	11	10	9	8	7	6	5	4	3	2	1	0	15	14	13	12	11	10	9	8	7	6	5	4	3	2	1	0
1	1	1	1	1	1	1	1	0	D	size		Vn		Vd		1	0	0	0	N	Q	M	0		Vm						

31	30	29	28	27	26	25	24	23	22	21	20	19	18	17	16	15	14	13	12	11	10	9	8	7	6	5	4	3	2	1	0
1	1	1	1	0	0	1	1	0	D	size		Vn		Vd		1	0	0	0	N	Q	M	0		Vm						

```
if Q == '1' && (Vd<0> == '1' || Vn<0> == '1' || Vm<0> == '1') then UNDEFINED;
esize = 8 << UInt(size); elements = 64 DIV esize;
d = UInt(D:Vd); n = UInt(N:Vn); m = UInt(M:Vm); regs = if Q == '0' then 1 else 2;
```



## Assembler syntax

VSUB{<c>}{<q>}.<dt> {<Qd>}, <Qn>, <Qm>

VSUB{<c>}{<q>}.<dt> {<Dd>}, <Dn>, <Dm>

where:

<c>, <q> See [Standard assembler syntax fields on page A8-287](#). An ARM Advanced SIMD VSUB instruction must be unconditional. ARM strongly recommends that a Thumb Advanced SIMD VSUB instruction is unconditional, see [Conditional execution on page A8-288](#).

<dt> The data type for the elements of the vectors. It must be one of:

I8 Encoded as size = 0b00.

I16 Encoded as size = 0b01.

I32 Encoded as size = 0b10.

I64 Encoded as size = 0b11.

<Qd>, <Qn>, <Qm> The destination vector and the operand vectors, for a quadword operation.

<Dd>, <Dn>, <Dm> The destination vector and the operand vectors, for a doubleword operation.

## Operation

```
if ConditionPassed() then
    EncodingSpecificOperations(); CheckAdvSIMDEnabled();
    for r = 0 to regs-1
        for e = 0 to elements-1
            Elem[D[d+r],e,esize] = Elem[D[n+r],e,esize] - Elem[D[m+r],e,esize];
```

## Exceptions

Undefined Instruction, Hyp Trap.

### A8.8.415 VSUB (floating-point)

Vector Subtract subtracts the elements of one vector from the corresponding elements of another vector, and places the results in the destination vector.

Depending on settings in the CPACR, NSACR, HCPTR, and FPEXC registers, and the security state and mode in which the instruction is executed, an attempt to execute the instruction might be UNDEFINED, or trapped to Hyp mode. [Summary of general controls of CP10 and CP11 functionality on page B1-1230](#) and [Summary of access controls for Advanced SIMD functionality on page B1-1232](#) summarize these controls.

ARM deprecates the conditional execution of any Advanced SIMD instruction encoding that is not also available as a VFP instruction encoding, see [Conditional execution on page A8-288](#).

#### Encoding T1/A1 Advanced SIMD (UNDEFINED in integer-only variant)

VSUB<c>.F32 <Qd>, <Qn>, <Qm>

VSUB<c>.F32 <Dd>, <Dn>, <Dm>

15	14	13	12	11	10	9	8	7	6	5	4	3	2	1	0	15	14	13	12	11	10	9	8	7	6	5	4	3	2	1	0
1	1	1	0	1	1	1	1	0	D	1	sz	Vn			Vd			1	1	0	1	N	Q	M	0	Vm					

31	30	29	28	27	26	25	24	23	22	21	20	19	18	17	16	15	14	13	12	11	10	9	8	7	6	5	4	3	2	1	0
1	1	1	1	0	0	1	0	0	D	1	sz	Vn			Vd			1	1	0	1	N	Q	M	0	Vm					

```
if Q == '1' && (Vd<0> == '1' || Vn<0> == '1' || Vm<0> == '1') then UNDEFINED;
if sz == '1' then UNDEFINED;
advsimd = TRUE; esize = 32; elements = 2;
d = UInt(D:Vd); n = UInt(N:Vn); m = UInt(M:Vm); regs = if Q == '0' then 1 else 2;
```

#### Encoding T2/A2 VFPv2, VFPv3, VFPv4 (sz = 1 UNDEFINED in single-precision only variants)

VSUB<c>.F64 <Dd>, <Dn>, <Dm>

VSUB<c>.F32 <Sd>, <Sn>, <Sm>

15	14	13	12	11	10	9	8	7	6	5	4	3	2	1	0	15	14	13	12	11	10	9	8	7	6	5	4	3	2	1	0
1	1	1	0	1	1	1	0	0	D	1	1	Vn			Vd			1	0	1	sz	N	1	M	0	Vm					

31	30	29	28	27	26	25	24	23	22	21	20	19	18	17	16	15	14	13	12	11	10	9	8	7	6	5	4	3	2	1	0
cond		1	1	1	0	0	D	1	1	Vn			Vd			1	0	1	sz	N	1	M	0	Vm							

```
if FPSCR.Len != '000' || FPSCR.Stride != '00' then SEE "VFP vectors";
advsimd = FALSE; dp_operation = (sz == '1');
d = if dp_operation then UInt(D:Vd) else UInt(Vd:D);
n = if dp_operation then UInt(N:Vn) else UInt(Vn:N);
m = if dp_operation then UInt(M:Vm) else UInt(Vm:M);
```

**VFP vectors** Encoding T2/A2 can operate on VFP vectors under control of the FPSCR.{Len, Stride} fields. For details see [Appendix K VFP Vector Operation Support](#).

## Assembler syntax

VSUB{<c>}{<q>}.F32 {<Qd>}, <Qn>, <Qm>	Encoding T1/A1, encoded as Q = 1, sz = 0
VSUB{<c>}{<q>}.F32 {<Dd>}, <Dn>, <Dm>	Encoding T1/A1, encoded as Q = 0, sz = 0
VSUB{<c>}{<q>}.F64 {<Dd>}, <Dn>, <Dm>	Encoding T2/A2, encoded as sz = 1
VSUB{<c>}{<q>}.F32 {<Sd>}, <Sn>, <Sm>	Encoding T2/A2, encoded as sz = 0

where:

<c>, <q>	See <a href="#">Standard assembler syntax fields on page A8-287</a> . An ARM Advanced SIMD VSUB instruction must be unconditional. ARM strongly recommends that a Thumb Advanced SIMD VSUB instruction is unconditional, see <a href="#">Conditional execution on page A8-288</a> .
<Qd>, <Qn>, <Qm>	The destination vector and the operand vectors, for a quadword operation.
<Dd>, <Dn>, <Dm>	The destination vector and the operand vectors, for a doubleword operation.
<Sd>, <Sn>, <Sm>	The destination vector and the operand vectors, for a singleword operation.

## Operation

```

if ConditionPassed() then
    EncodingSpecificOperations(); CheckAdvSIMDorVFPEEnabled(TRUE, advsimd);
    if advsimd then // Advanced SIMD instruction
        for r = 0 to regs-1
            for e = 0 to elements-1
                Elem[D[d+r],e,esize] = FPSub(Elem[D[n+r],e,esize], Elem[D[m+r],e,esize], FALSE);
    else // VFP instruction
        if dp_operation then
            D[d] = FPSub(D[n], D[m], TRUE);
        else
            S[d] = FPSub(S[n], S[m], TRUE);

```

## Exceptions

Undefined Instruction, Hyp Trap.

### ***Floating-point exceptions***

Input Denormal, Invalid Operation, Overflow, Underflow, Inexact.

### A8.8.416 VSUBHN

Vector Subtract and Narrow, returning High Half subtracts the elements of one quadword vector from the corresponding elements of another quadword vector, takes the most significant half of each result, and places the final results in a doubleword vector. The results are truncated. (For rounded results, see [VRSUBHN](#) on page A8-1044.

There is no distinction between signed and unsigned integers.

Depending on settings in the CPACR, NSACR, and HCPTR registers, and the security state and mode in which the instruction is executed, an attempt to execute the instruction might be UNDEFINED, or trapped to Hyp mode. [Summary of access controls for Advanced SIMD functionality on page B1-1232](#) summarizes these controls.

ARM deprecates the conditional execution of any Advanced SIMD instruction encoding that is not also available as a VFP instruction encoding, see [Conditional execution on page A8-288](#).

#### Encoding T1/A1 Advanced SIMD

VSUBHN<c>.<dt> <Dd>, <Qn>, <Qm>

15	14	13	12	11	10	9	8	7	6	5	4	3	2	1	0	15	14	13	12	11	10	9	8	7	6	5	4	3	2	1	0
1	1	1	0	1	1	1	1	1	D	size	Vn				Vd				0	1	1	0	N	0	M	0	Vm				
31	30	29	28	27	26	25	24	23	22	21	20	19	18	17	16	15	14	13	12	11	10	9	8	7	6	5	4	3	2	1	0
1	1	1	1	0	0	1	0	1	D	size	Vn				Vd				0	1	1	0	N	0	M	0	Vm				

```

if size == '11' then SEE "Related encodings";
if Vn<0> == '1' || Vm<0> == '1' then UNDEFINED;
esize = 8 << UInt(size); elements = 64 DIV esize;
d = UInt(D:Vd); n = UInt(N:Vn); m = UInt(M:Vm);

```

**Related encodings** See [Advanced SIMD data-processing instructions on page A7-261](#).

## Assembler syntax

VSUBHN{<c>}{<q>}.<dt> <Dd>, <Qn>, <Qm>

where:

<c>, <q> See [Standard assembler syntax fields on page A8-287](#). An ARM VSUBHN instruction must be unconditional. ARM strongly recommends that a Thumb VSUBHN instruction is unconditional, see [Conditional execution on page A8-288](#).

<dt> The data type for the elements of the operands. It must be one of:  
I16 Encoded as size = 0b00.  
I32 Encoded as size = 0b01.  
I64 Encoded as size = 0b10.

<Dd>, <Qn>, <Qm> The destination vector, the first operand vector, and the second operand vector.

## Operation

```
if ConditionPassed() then
    EncodingSpecificOperations(); CheckAdvSIMDEnabled();
    for e = 0 to elements-1
        result = Elem[Qin[n>>1],e,2*esize] - Elem[Qin[m>>1],e,2*esize];
        Elem[D[d],e,esize] = result<2*esize-1:esize>;
```

## Exceptions

Undefined Instruction, Hyp Trap.

### A8.8.417 VSUBL, VSUBW

Vector Subtract Long subtracts the elements of one doubleword vector from the corresponding elements of another doubleword vector, and places the results in a quadword vector. Before subtracting, it sign-extends or zero-extends the elements of both operands.

Vector Subtract Wide subtracts the elements of a doubleword vector from the corresponding elements of a quadword vector, and places the results in another quadword vector. Before subtracting, it sign-extends or zero-extends the elements of the doubleword operand.

Depending on settings in the CPACR, NSACR, and HCPTR registers, and the security state and mode in which the instruction is executed, an attempt to execute the instruction might be UNDEFINED, or trapped to Hyp mode. [Summary of access controls for Advanced SIMD functionality on page B1-1232](#) summarizes these controls.

ARM deprecates the conditional execution of any Advanced SIMD instruction encoding that is not also available as a VFP instruction encoding, see [Conditional execution on page A8-288](#).

#### Encoding T1/A1 Advanced SIMD

VSUBL<c>.<dt> <Qd>, <Dn>, <Dm>

VSUBW<c>.<dt> <Qd>, <Qn>, <Dm>

15	14	13	12	11	10	9	8	7	6	5	4	3	2	1	0	15	14	13	12	11	10	9	8	7	6	5	4	3	2	1	0
1	1	1	U	1	1	1	1	1	D	size	Vn	Vd	0	0	1	op	N	0	M	0	Vm										

31	30	29	28	27	26	25	24	23	22	21	20	19	18	17	16	15	14	13	12	11	10	9	8	7	6	5	4	3	2	1	0
1	1	1	1	0	0	1	U	1	D	size	Vn	Vd	0	0	1	op	N	0	M	0	Vm										

```

if size == '11' then SEE "Related encodings";
if Vd<0> == '1' || (op == '1' && Vn<0> == '1') then UNDEFINED;
unsigned = (U == '1');
esize = 8 << UInt(size); elements = 64 DIV esize; is_vsubw = (op == '1');
d = UInt(D:Vd); n = UInt(N:Vn); m = UInt(M:Vm);

```

**Related encodings** See [Advanced SIMD data-processing instructions on page A7-261](#).

## Assembler syntax

VSUBL{<c>}{<q>}.<dt> <Qd>, <Dn>, <Dm> Encoded as op = 0  
VSUBW{<c>}{<q>}.<dt> {<Qd>}, <Qn>, <Dm> Encoded as op = 1

where:

<c>, <q> See [Standard assembler syntax fields on page A8-287](#). An ARM VSUBL or VSUBW instruction must be unconditional. ARM strongly recommends that a Thumb VSUBL or VSUBW instruction is unconditional, see [Conditional execution on page A8-288](#).

<dt> The data type for the elements of the second operand. It must be one of:

S8	Encoded as size = 0b00, U = 0.
S16	Encoded as size = 0b01, U = 0.
S32	Encoded as size = 0b10, U = 0.
U8	Encoded as size = 0b00, U = 1.
U16	Encoded as size = 0b01, U = 1.
U32	Encoded as size = 0b10, U = 1.

<Qd> The destination register.

<Qn>, <Dm> The first and second operand registers for a VSUBW instruction.

<Dn>, <Dm> The first and second operand registers for a VSUBL instruction.

## Operation

```

if ConditionPassed() then
    EncodingSpecificOperations(); CheckAdvSIMDEnabled();
    for e = 0 to elements-1
        if is_vsubw then
            op1 = Int(Elem[Qin[n>>1],e,2*esize], unsigned);
        else
            op1 = Int(Elem[Din[n],e,esize], unsigned);
            result = op1 - Int(Elem[Din[m],e,esize], unsigned);
            Elem[Q[d>>1],e,2*esize] = result<2*esize-1:0>;

```

## Exceptions

Undefined Instruction, Hyp Trap.

### A8.8.418 VSWP

VSWP (Vector Swap) exchanges the contents of two vectors. The vectors can be either doubleword or quadword. There is no distinction between data types.

Depending on settings in the CPACR, NSACR, and HCPTR registers, and the security state and mode in which the instruction is executed, an attempt to execute the instruction might be UNDEFINED, or trapped to Hyp mode. [Summary of access controls for Advanced SIMD functionality on page B1-1232](#) summarizes these controls.

ARM deprecates the conditional execution of any Advanced SIMD instruction encoding that is not also available as a VFP instruction encoding, see [Conditional execution on page A8-288](#).

#### Encoding T1/A1 Advanced SIMD

VSWP<c> <Qd>, <Qm>

VSWP<c> <Dd>, <Dm>

15	14	13	12	11	10	9	8	7	6	5	4	3	2	1	0	15	14	13	12	11	10	9	8	7	6	5	4	3	2	1	0
1	1	1	1	1	1	1	1	D	1	1	size	1	0		Vd	0	0	0	0	0	0	Q	M	0		Vm					

31	30	29	28	27	26	25	24	23	22	21	20	19	18	17	16	15	14	13	12	11	10	9	8	7	6	5	4	3	2	1	0
1	1	1	1	0	0	1	1	1	D	1	1	size	1	0		Vd	0	0	0	0	0	0	Q	M	0		Vm				

```

if size != '00' then UNDEFINED;
if Q == '1' && (Vd<0> == '1' || Vm<0> == '1') then UNDEFINED;
d = UInt(D:Vd); m = UInt(M:Vm); regs = if Q == '0' then 1 else 2;

```



## Assembler syntax

VSWP{<c>}{<q>}{.<dt>} <Qd>, <Qm> Encoded as Q = 1, size = 0b00  
VSWP{<c>}{<q>}{.<dt>} <Dd>, <Dm> Encoded as Q = 0, size = 0b00

where:

<c>, <q> See [Standard assembler syntax fields on page A8-287](#). An ARM VSWP instruction must be unconditional. ARM strongly recommends that a Thumb VSWP instruction is unconditional, see [Conditional execution on page A8-288](#).

<dt> An optional data type. It is ignored by assemblers, and does not affect the encoding.

<Qd>, <Qm> The vectors for a quadword operation.

<Dd>, <Dm> The vectors for a doubleword operation.

## Operation

```
if ConditionPassed() then
    EncodingSpecificOperations(); CheckAdvSIMDEnabled();
    for r = 0 to regs-1
        if d == m then
            D[d+r] = bits(64) UNKNOWN;
        else
            D[d+r] = Din[m+r];
            D[m+r] = Din[d+r];
```

## Exceptions

Undefined Instruction, Hyp Trap.

### A8.8.419 VTBL, VTBX

Vector Table Lookup uses byte indexes in a control vector to look up byte values in a table and generate a new vector. Indexes out of range return 0.

Vector Table Extension works in the same way, except that indexes out of range leave the destination element unchanged.

Depending on settings in the CPACR, NSACR, and HCPTR registers, and the security state and mode in which the instruction is executed, an attempt to execute the instruction might be UNDEFINED, or trapped to Hyp mode.

[Summary of access controls for Advanced SIMD functionality on page B1-1232](#) summarizes these controls.

ARM deprecates the conditional execution of any Advanced SIMD instruction encoding that is not also available as a VFP instruction encoding, see [Conditional execution on page A8-288](#).

#### Encoding T1/A1 Advanced SIMD

V<op><c>.8 <Dd>, <list>, <Dm>

15	14	13	12	11	10	9	8	7	6	5	4	3	2	1	0	15	14	13	12	11	10	9	8	7	6	5	4	3	2	1	0
1	1	1	1	1	1	1	1	D	1	1	Vn				Vd		1	0	len	N	op	M	0	Vm							

31	30	29	28	27	26	25	24	23	22	21	20	19	18	17	16	15	14	13	12	11	10	9	8	7	6	5	4	3	2	1	0
1	1	1	1	0	0	1	1	1	D	1	1	Vn				Vd		1	0	len	N	op	M	0	Vm						

```
is_vtbl = (op == '0'); length = UInt(len)+1;
d = UInt(D:Vd); n = UInt(N:Vn); m = UInt(M:Vm);
if n+length > 32 then UNPREDICTABLE;
```

## Assembler syntax

V<op>{<c>}{<q>}.8 <Dd>, <list>, <Dm>

where:

<op> The operation. It must be one of:  
TBL Vector Table Lookup. Encoded as op = 0.  
TBX Vector Table Extension. Encoded as op = 1.

<c>, <q> See [Standard assembler syntax fields on page A8-287](#). An ARM VTBL or VTBX instruction must be unconditional. ARM strongly recommends that a Thumb VTBL or VTBX instruction is unconditional, see [Conditional execution on page A8-288](#).

<Dd> The destination vector.

<list> The vectors containing the table. It must be one of:  
{<Dn>} encoded as len = 0b00.  
{<Dn>, <Dn+1>} encoded as len = 0b01.  
{<Dn>, <Dn+1>, <Dn+2>} encoded as len = 0b10.  
{<Dn>, <Dn+1>, <Dn+2>, <Dn+3>} encoded as len = 0b11.

<Dm> The index vector.

## Operation

```
if ConditionPassed() then
    EncodingSpecificOperations(); CheckAdvSIMDEnabled();

    // Create 256-bit = 32-byte table variable, with zeros in entries that will not be used.
    table3 = if length == 4 then D[n+3] else Zeros(64);
    table2 = if length >= 3 then D[n+2] else Zeros(64);
    table1 = if length >= 2 then D[n+1] else Zeros(64);
    table = table3 : table2 : table1 : D[n];

    for i = 0 to 7
        index = UInt(Elem[D[m],i,8]);
        if index < 8*length then
            Elem[D[d],i,8] = Elem[table,index,8];
        else
            if is_vtbl then
                Elem[D[d],i,8] = Zeros(8);
            // else Elem[D[d],i,8] unchanged
```

## Exceptions

Undefined Instruction, Hyp Trap.

### A8.8.420 VTRN

Vector Transpose treats the elements of its operand vectors as elements of  $2 \times 2$  matrices, and transposes the matrices.

The elements of the vectors can be 8-bit, 16-bit, or 32-bit. There is no distinction between data types.

Figure A8-7 shows the operation of doubleword VTRN. Quadword VTRN performs the same operation as doubleword VTRN twice, once on the upper halves of the quadword vectors, and once on the lower halves

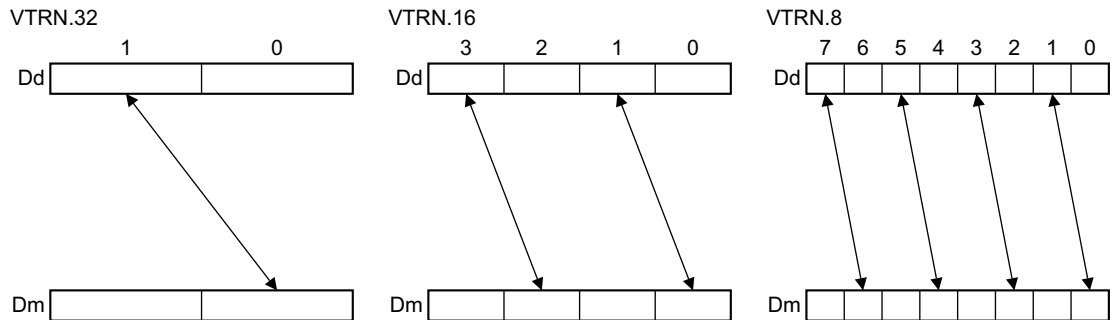

Figure A8-7 VTRN doubleword operation

Depending on settings in the CPACR, NSACR, and HCPTR registers, and the security state and mode in which the instruction is executed, an attempt to execute the instruction might be UNDEFINED, or trapped to Hyp mode.

Summary of access controls for Advanced SIMD functionality on page B1-1232 summarizes these controls.

ARM deprecates the conditional execution of any Advanced SIMD instruction encoding that is not also available as a VFP instruction encoding, see Conditional execution on page A8-288.

#### Encoding T1/A1 Advanced SIMD

VTRN<c>.<size> <Qd>, <Qm>

VTRN<c>.<size> <Dd>, <Dm>

15	14	13	12	11	10	9	8	7	6	5	4	3	2	1	0	15	14	13	12	11	10	9	8	7	6	5	4	3	2	1	0
1	1	1	1	1	1	1	1	D	1	1	size	1	0	Vd	0	0	0	0	1	Q	M	0	Vm								

31	30	29	28	27	26	25	24	23	22	21	20	19	18	17	16	15	14	13	12	11	10	9	8	7	6	5	4	3	2	1	0
1	1	1	1	0	0	1	1	1	D	1	1	size	1	0	Vd	0	0	0	0	1	Q	M	0	Vm							

```

if size == '11' then UNDEFINED;
if Q == '1' && (Vd<0> == '1' || Vm<0> == '1') then UNDEFINED;
esize = 8 << UInt(size);  elements = 64 DIV esize;
d = UInt(D:Vd);  m = UInt(M:Vm);  regs = if Q == '0' then 1 else 2;

```

## Assembler syntax

VTRN{<c>}{<q>}.<size> <Qd>, <Qm> Encoded as Q = 1  
VTRN{<c>}{<q>}.<size> <Dd>, <Dm> Encoded as Q = 0

where:

<c>, <q> See [Standard assembler syntax fields on page A8-287](#). An ARM VTRN instruction must be unconditional. ARM strongly recommends that a Thumb VTRN instruction is unconditional, see [Conditional execution on page A8-288](#).

<size> The data size for the elements of the vectors. It must be one of:  
8 Encoded as size = 0b00.  
16 Encoded as size = 0b01.  
32 Encoded as size = 0b10.

<Qd>, <Qm> The destination vector, and the operand vector, for a quadword operation.

<Dd>, <Dm> The destination vector, and the operand vector, for a doubleword operation.

## Operation

```
if ConditionPassed() then
    EncodingSpecificOperations(); CheckAdvSIMDEnabled();
    h = elements/2;

    for r = 0 to regs-1
        if d == m then
            D[d+r] = bits(64) UNKNOWN;
        else
            for e = 0 to h-1
                Elem[D[d+r],2*e+1,esize] = Elem[Din[m+r],2*e,esize];
                Elem[D[m+r],2*e,esize] = Elem[Din[d+r],2*e+1,esize];
```

## Exceptions

Undefined Instruction, Hyp Trap.

### A8.8.421 VTST

Vector Test Bits takes each element in a vector, and bitwise ANDs it with the corresponding element of a second vector. If the result is not zero, the corresponding element in the destination vector is set to all ones. Otherwise, it is set to all zeros.

The operand vector elements can be any one of:

- 8-bit, 16-bit, or 32-bit fields.

The result vector elements are fields the same size as the operand vector elements.

Depending on settings in the CPACR, NSACR, and HCPTR registers, and the security state and mode in which the instruction is executed, an attempt to execute the instruction might be UNDEFINED, or trapped to Hyp mode. [Summary of access controls for Advanced SIMD functionality on page B1-1232](#) summarizes these controls.

ARM deprecates the conditional execution of any Advanced SIMD instruction encoding that is not also available as a VFP instruction encoding, see [Conditional execution on page A8-288](#).

#### Encoding T1/A1 Advanced SIMD

VTST<c>.<size> <Qd>, <Qn>, <Qm>

VTST<c>.<size> <Dd>, <Dn>, <Dm>

15	14	13	12	11	10	9	8	7	6	5	4	3	2	1	0	15	14	13	12	11	10	9	8	7	6	5	4	3	2	1	0
1	1	1	0	1	1	1	1	0	D	size	Vn	Vd	1	0	0	0	N	Q	M	1	Vm										

31	30	29	28	27	26	25	24	23	22	21	20	19	18	17	16	15	14	13	12	11	10	9	8	7	6	5	4	3	2	1	0
1	1	1	1	0	0	1	0	0	D	size	Vn	Vd	1	0	0	0	N	Q	M	1	Vm										

```

if Q == '1' && (Vd<0> == '1' || Vn<0> == '1' || Vm<0> == '1') then UNDEFINED;
if size == '11' then UNDEFINED;
esize = 8 << UInt(size); elements = 64 DIV esize;
d = UInt(D:Vd); n = UInt(N:Vn); m = UInt(M:Vm); regs = if Q == '0' then 1 else 2;

```

## Assembler syntax

VTST{<c>}{<q>}.<size> {<Qd>}, <Qn>, <Qm> Encoded as Q = 1  
VTST{<c>}{<q>}.<size> {<Dd>}, <Dn>, <Dm> Encoded as Q = 0

where:

<c>, <q> See [Standard assembler syntax fields on page A8-287](#). An ARM VTST instruction must be unconditional. ARM strongly recommends that a Thumb VTST instruction is unconditional, see [Conditional execution on page A8-288](#).

<size> The data size for the elements of the operands. It must be one of:  
8 Encoded as size = 0b00.  
16 Encoded as size = 0b01.  
32 Encoded as size = 0b10.

<Qd>, <Qn>, <Qm> The destination vector and the operand vectors, for a quadword operation.

<Dd>, <Dn>, <Dm> The destination vector and the operand vectors, for a doubleword operation.

## Operation

```
if ConditionPassed() then
    EncodingSpecificOperations(); CheckAdvSIMDEnabled();
    for r = 0 to regs-1
        for e = 0 to elements-1
            if !IsZero(Elem[D[n+r],e,esize] AND Elem[D[m+r],e,esize]) then
                Elem[D[d+r],e,esize] = Ones(esize);
            else
                Elem[D[d+r],e,esize] = Zeros(esize);
```

## Exceptions

Undefined Instruction, Hyp Trap.

### A8.8.422 VUZP

Vector Unzip de-interleaves the elements of two vectors. See [Table A8-13](#) and [Table A8-14](#) for examples of the operation.

The elements of the vectors can be 8-bit, 16-bit, or 32-bit. There is no distinction between data types.

Depending on settings in the [CPACR](#), [NSACR](#), and [HCPTR](#) registers, and the security state and mode in which the instruction is executed, an attempt to execute the instruction might be UNDEFINED, or trapped to Hyp mode. [Summary of access controls for Advanced SIMD functionality on page B1-1232](#) summarizes these controls.

ARM deprecates the conditional execution of any Advanced SIMD instruction encoding that is not also available as a VFP instruction encoding, see [Conditional execution on page A8-288](#).

#### Encoding T1/A1 Advanced SIMD

VUZP<c>.<size> <Qd>, <Qm>

VUZP<c>.<size> <Dd>, <Dm>

15	14	13	12	11	10	9	8	7	6	5	4	3	2	1	0	15	14	13	12	11	10	9	8	7	6	5	4	3	2	1	0
1	1	1	1	1	1	1	1	D	1	1	size	1	0	Vd	0	0	0	1	0	Q	M	0	Vm								
31	30	29	28	27	26	25	24	23	22	21	20	19	18	17	16	15	14	13	12	11	10	9	8	7	6	5	4	3	2	1	0
1	1	1	1	0	0	1	1	1	D	1	1	size	1	0	Vd	0	0	0	1	0	Q	M	0	Vm							

```

if size == '11' || (Q == '0' && size == '10') then UNDEFINED;
if Q == '1' && (Vd<0> == '1' || Vm<0> == '1') then UNDEFINED;
quadword_operation = (Q == '1');  esize = 8 << UInt(size);
d = UInt(D:Vd);  m = UInt(M:Vm);

```

[Table A8-13](#) shows the operation of a doubleword VUZP.8 instruction, and [Table A8-14](#) shows the operation of a quadword VUZP.32 instruction, and

**Table A8-13 Operation of doubleword VUZP.8**

	Register state before operation	Register state after operation
Dd	A <sub>7</sub> A <sub>6</sub> A <sub>5</sub> A <sub>4</sub> A <sub>3</sub> A <sub>2</sub> A <sub>1</sub> A <sub>0</sub>	B <sub>6</sub> B <sub>4</sub> B <sub>2</sub> B <sub>0</sub> A <sub>6</sub> A <sub>4</sub> A <sub>2</sub> A <sub>0</sub>
Dm	B <sub>7</sub> B <sub>6</sub> B <sub>5</sub> B <sub>4</sub> B <sub>3</sub> B <sub>2</sub> B <sub>1</sub> B <sub>0</sub>	B <sub>7</sub> B <sub>5</sub> B <sub>3</sub> B <sub>1</sub> A <sub>7</sub> A <sub>5</sub> A <sub>3</sub> A <sub>1</sub>

**Table A8-14 Operation of quadword VUZP.32**

	Register state before operation	Register state after operation
Qd	A <sub>3</sub> A <sub>2</sub> A <sub>1</sub> A <sub>0</sub>	B <sub>2</sub> B <sub>0</sub> A <sub>2</sub> A <sub>0</sub>
Qm	B <sub>3</sub> B <sub>2</sub> B <sub>1</sub> B <sub>0</sub>	B <sub>3</sub> B <sub>1</sub> A <sub>3</sub> A <sub>1</sub>



## Assembler syntax

VUZP{<c>}{<q>}.<size> <Qd>, <Qm> Encoded as Q = 1  
VUZP{<c>}{<q>}.<size> <Dd>, <Dm> Encoded as Q = 0

where:

<c>, <q> See [Standard assembler syntax fields on page A8-287](#). An ARM VUZP instruction must be unconditional. ARM strongly recommends that a Thumb VUZP instruction is unconditional, see [Conditional execution on page A8-288](#).

<size> The data size for the elements of the vectors. It must be one of:  
8 Encoded as size = 0b00.  
16 Encoded as size = 0b01.  
32 Encoded as size = 0b10 for a quadword operation.  
Doubleword operation with <size> = 32 is a pseudo-instruction.

<Qd>, <Qm> The vectors for a quadword operation.

<Dd>, <Dm> The vectors for a doubleword operation.

## Operation

```
if ConditionPassed() then
    EncodingSpecificOperations(); CheckAdvSIMDEnabled();
    if quadword_operation then
        if d == m then
            Q[d>>1] = bits(128) UNKNOWN; Q[m>>1] = bits(128) UNKNOWN;
        else
            zipped_q = Q[m>>1]:Q[d>>1];
            for e = 0 to (128 DIV esize) - 1
                Elem[Q[d>>1],e,esize] = Elem[zipped_q,2*e,esize];
                Elem[Q[m>>1],e,esize] = Elem[zipped_q,2*e+1,esize];
    else
        if d == m then
            D[d] = bits(64) UNKNOWN; D[m] = bits(64) UNKNOWN;
        else
            zipped_d = D[m]:D[d];
            for e = 0 to (64 DIV esize) - 1
                Elem[D[d],e,esize] = Elem[zipped_d,2*e,esize];
                Elem[D[m],e,esize] = Elem[zipped_d,2*e+1,esize];
```

## Exceptions

Undefined Instruction, Hyp Trap.

## Pseudo-instruction

VUZP.32 <Dd>, <Dm> is a synonym for VTRN.32 <Dd>, <Dm>. For details see [VTRN on page A8-1096](#).

### A8.8.423 VZIP

Vector Zip interleaves the elements of two vectors. See [Table A8-15](#) and [Table A8-16](#) for examples of the operation.

The elements of the vectors can be 8-bit, 16-bit, or 32-bit. There is no distinction between data types.

Depending on settings in the [CPACR](#), [NSACR](#), and [HCPTR](#) registers, and the security state and mode in which the instruction is executed, an attempt to execute the instruction might be UNDEFINED, or trapped to Hyp mode. [Summary of access controls for Advanced SIMD functionality on page B1-1232](#) summarizes these controls.

ARM deprecates the conditional execution of any Advanced SIMD instruction encoding that is not also available as a VFP instruction encoding, see [Conditional execution on page A8-288](#).

#### Encoding T1/A1 Advanced SIMD

VZIP<c>.<size> <Qd>, <Qm>

VZIP<c>.<size> <Dd>, <Dm>

15	14	13	12	11	10	9	8	7	6	5	4	3	2	1	0	15	14	13	12	11	10	9	8	7	6	5	4	3	2	1	0
1	1	1	1	1	1	1	1	D	1	1	size	1	0			Vd	0	0	0	1	1	Q	M	0			Vm				

31	30	29	28	27	26	25	24	23	22	21	20	19	18	17	16	15	14	13	12	11	10	9	8	7	6	5	4	3	2	1	0
1	1	1	1	0	0	1	1	1	D	1	1	size	1	0			Vd	0	0	0	1	1	Q	M	0			Vm			

```
if size == '11' || (Q == '0' && size == '10') then UNDEFINED;
if Q == '1' && (Vd<0> == '1' || Vm<0> == '1') then UNDEFINED;
quadword_operation = (Q == '1');  esize = 8 << UInt(size);
d = UInt(D:Vd);  m = UInt(M:Vm);
```

[Table A8-15](#) shows the operation of a doubleword VZIP.8 instruction, and [Table A8-16](#) shows the operation of a quadword VZIP.32 instruction.

**Table A8-15 Operation of doubleword VZIP.8**

	Register state before operation								Register state after operation							
Dd	A <sub>7</sub>	A <sub>6</sub>	A <sub>5</sub>	A <sub>4</sub>	A <sub>3</sub>	A <sub>2</sub>	A <sub>1</sub>	A <sub>0</sub>	B <sub>3</sub>	A <sub>3</sub>	B <sub>2</sub>	A <sub>2</sub>	B <sub>1</sub>	A <sub>1</sub>	B <sub>0</sub>	A <sub>0</sub>
Dm	B <sub>7</sub>	B <sub>6</sub>	B <sub>5</sub>	B <sub>4</sub>	B <sub>3</sub>	B <sub>2</sub>	B <sub>1</sub>	B <sub>0</sub>	B <sub>7</sub>	A <sub>7</sub>	B <sub>6</sub>	A <sub>6</sub>	B <sub>5</sub>	A <sub>5</sub>	B <sub>4</sub>	A <sub>4</sub>

**Table A8-16 Operation of quadword VZIP.32**

	Register state before operation				Register state after operation			
Qd	A <sub>3</sub>	A <sub>2</sub>	A <sub>1</sub>	A <sub>0</sub>	B <sub>1</sub>	A <sub>1</sub>	B <sub>0</sub>	A <sub>0</sub>
Qm	B <sub>3</sub>	B <sub>2</sub>	B <sub>1</sub>	B <sub>0</sub>	B <sub>3</sub>	A <sub>3</sub>	B <sub>2</sub>	A <sub>2</sub>

## Assembler syntax

VZIP{<C>}{<q>}.<size> <Qd>, <Qm> Encoded as Q = 1  
VZIP{<C>}{<q>}.<size> <Dd>, <Dm> Encoded as Q = 0

where:

<C>, <q> See *Standard assembler syntax fields on page A8-287*. An ARM VZIP instruction must be unconditional. ARM strongly recommends that a Thumb VZIP instruction is unconditional, see *Conditional execution on page A8-288*.

<size> The data size for the elements of the vectors. It must be one of:  
8 Encoded as size = 0b00.  
16 Encoded as size = 0b01.  
32 Encoded as size = 0b10 for a quadword operation.  
Doubleword operation with <size> = 32 is a pseudo-instruction.

<Qd>, <Qm> The vectors for a quadword operation.  
<Dd>, <Dm> The vectors for a doubleword operation.

## Operation

```
if ConditionPassed() then
    EncodingSpecificOperations(); CheckAdvSIMDEnabled();
    if quadword_operation then
        if d == m then
            Q[d>>1] = bits(128) UNKNOWN; Q[m>>1] = bits(128) UNKNOWN;
        else
            bits(256) zipped_q;
            for e = 0 to (128 DIV esize) - 1
                Elem[zipped_q,2*e,esize] = Elem[Q[d>>1],e,esize];
                Elem[zipped_q,2*e+1,esize] = Elem[Q[m>>1],e,esize];
            Q[d>>1] = zipped_q<127:0>; Q[m>>1] = zipped_q<255:128>;
        else
            if d == m then
                D[d] = bits(64) UNKNOWN; D[m] = bits(64) UNKNOWN;
            else
                bits(128) zipped_d;
                for e = 0 to (64 DIV esize) - 1
                    Elem[zipped_d,2*e,esize] = Elem[D[d],e,esize];
                    Elem[zipped_d,2*e+1,esize] = Elem[D[m],e,esize];
                D[d] = zipped_d<63:0>; D[m] = zipped_d<127:64>;
```

## Exceptions

Undefined Instruction, Hyp Trap.

## Pseudo-instructions

VZIP.32 <Dd>, <Dm> is a synonym for VTRN.32 <Dd>, <Dm>. For details see *VTRN on page A8-1096*.

### A8.8.424 WFE

Wait For Event is a hint instruction that permits the processor to enter a low-power state until one of a number of events occurs, including events signaled by executing the SEV instruction on any processor in the multiprocessor system. For more information, see [Wait For Event and Send Event on page B1-1199](#).

In an implementation that includes the Virtualization Extensions, if HCR.TWE is set to 1, execution of a WFE instruction in a Non-secure mode other than Hyp mode generates a Hyp Trap exception if, ignoring the value of the HCR.TWE bit, conditions permit the processor to suspend execution. For more information see [Trapping use of the WFI and WFE instructions on page B1-1255](#).

**Encoding T1** ARMv7 (executes as NOP in ARMv6T2)

WFE<c>

15	14	13	12	11	10	9	8	7	6	5	4	3	2	1	0
1	0	1	1	1	1	1	1	0	0	1	0	0	0	0	0

// No additional decoding required

**Encoding T2** ARMv7 (executes as NOP in ARMv6T2)

WFE<c>.W

15	14	13	12	11	10	9	8	7	6	5	4	3	2	1	0	15	14	13	12	11	10	9	8	7	6	5	4	3	2	1	0
1	1	1	1	0	0	1	1	1	0	1	0	(1)	(1)	(1)	(1)	1	0	(0)	0	(0)	0	0	0	0	0	0	0	1	0		

// No additional decoding required

**Encoding A1** ARMv6K, ARMv7 (executes as NOP in ARMv6T2)

WFE<c>

31	30	29	28	27	26	25	24	23	22	21	20	19	18	17	16	15	14	13	12	11	10	9	8	7	6	5	4	3	2	1	0
cond				0	0	1	1	0	0	1	0	0	0	0	0	(1)	(1)	(1)	(1)	(0)	(0)	(0)	(0)	0	0	0	0	0	0	1	0

// No additional decoding required

## Assembler syntax

WFE{<c>}{<q>}

where:

<c>, <q> See *Standard assembler syntax fields* on page A8-287.

## Operation

```
if ConditionPassed() then
    EncodingSpecificOperations();
    if EventRegistered() then
        ClearEventRegister();
    else
        if HaveVirtExt() && !IsSecure() && !CurrentModeIsHyp() && HCR.TWE == '1' then
            HSRString = Zeros(25);
            HSRString<0> = '1';
            WriteHSR('000001', HSRString);
            TakeHypTrapException();
        else
            WaitForEvent();
```

## Exceptions

Hyp Trap.

### A8.8.425 WFI

Wait For Interrupt is a hint instruction that permits the processor to enter a low-power state until one of a number of asynchronous events occurs. For more information, see [Wait For Interrupt on page B1-1202](#).

In an implementation that includes the Virtualization Extensions, if HCR.TWI is set to 1, execution of a WFI instruction in a Non-secure mode other than Hyp mode generates a Hyp Trap exception if, ignoring the value of the HCR.TWI bit, conditions permit the processor to suspend execution. For more information see [Trapping use of the WFI and WFE instructions on page B1-1255](#).

**Encoding T1** ARMv7 (executes as NOP in ARMv6T2)

WFI<C>

15	14	13	12	11	10	9	8	7	6	5	4	3	2	1	0
1	0	1	1	1	1	1	1	0	0	1	1	0	0	0	0

// No additional decoding required

**Encoding T2** ARMv7 (executes as NOP in ARMv6T2)

WFI<C>.W

15	14	13	12	11	10	9	8	7	6	5	4	3	2	1	0	15	14	13	12	11	10	9	8	7	6	5	4	3	2	1	0
1	1	1	1	0	0	1	1	1	0	1	0	(1)	(1)	(1)	(1)	1	0	(0)	0	(0)	0	0	0	0	0	0	0	0	1	1	

// No additional decoding required

**Encoding A1** ARMv6K, ARMv7 (executes as NOP in ARMv6T2)

WFI<C>

31	30	29	28	27	26	25	24	23	22	21	20	19	18	17	16	15	14	13	12	11	10	9	8	7	6	5	4	3	2	1	0
cond	0	0	1	1	0	0	1	0	0	0	0	0	(1)	(1)	(1)	(1)	(0)	(0)	(0)	(0)	0	0	0	0	0	0	0	0	1	1	

// No additional decoding required

## Assembler syntax

WFI{<c>}{<q>}

where:

<c>, <q> See *Standard assembler syntax fields* on page A8-287.

## Operation

```
if ConditionPassed() then
    EncodingSpecificOperations();
    if HaveVirtExt() && !IsSecure() && !CurrentModeIsHyp() && HCR.TWI == '1' then
        HSRString = Zeros(25);
        HSRString<0> = '0';
        WriteHSR('000001', HSRString);
        TakeHypTrapException();
    else
        WaitForInterrupt();
```

## Exceptions

Hyp Trap.

### A8.8.426 YIELD

YIELD is a hint instruction. Software with a multithreading capability can use a YIELD instruction to indicate to the hardware that it is performing a task, for example a spin-lock, that could be swapped out to improve overall system performance. Hardware can use this hint to suspend and resume multiple software threads if it supports the capability.

For more information about the recommended use of this instruction see [The Yield instruction on page A4-178](#).

**Encoding T1** ARMv7 (executes as NOP in ARMv6T2)

YIELD<c>

15	14	13	12	11	10	9	8	7	6	5	4	3	2	1	0
1	0	1	1	1	1	1	1	0	0	0	1	0	0	0	0

// No additional decoding required

**Encoding T2** ARMv7 (executes as NOP in ARMv6T2)

YIELD<c>.W

15	14	13	12	11	10	9	8	7	6	5	4	3	2	1	0	15	14	13	12	11	10	9	8	7	6	5	4	3	2	1	0
1	1	1	1	0	0	1	1	1	0	1	0	(1)	(1)	(1)	(1)	1	0	(0)	0	(0)	0	0	0	0	0	0	0	0	0	1	

// No additional decoding required

**Encoding A1** ARMv6K, ARMv7 (executes as NOP in ARMv6T2)

YIELD<c>

31	30	29	28	27	26	25	24	23	22	21	20	19	18	17	16	15	14	13	12	11	10	9	8	7	6	5	4	3	2	1	0
cond	0	0	1	1	0	0	1	0	0	0	0	0	(1)	(1)	(1)	(1)	(0)	(0)	(0)	(0)	0	0	0	0	0	0	0	0	0	0	1

// No additional decoding required



## Assembler syntax

YIELD{<c>}{<q>}

where:

<c>, <q>     See *Standard assembler syntax fields* on page A8-287.

## Operation

```
if ConditionPassed() then
    EncodingSpecificOperations();
    Hint_Yield();
```

## Exceptions

None.



# Chapter A9

## The ThumbEE Instruction Set

This chapter describes the ThumbEE instruction set. It contains the following sections:

- *About the ThumbEE instruction set on page A9-1112*
- *ThumbEE instruction set encoding on page A9-1115*
- *Additional instructions in Thumb and ThumbEE instruction sets on page A9-1116*
- *ThumbEE instructions with modified behavior on page A9-1117*
- *Additional ThumbEE instructions on page A9-1123.*

## A9.1 About the ThumbEE instruction set

In general, instructions in ThumbEE are identical to Thumb instructions, with the following exceptions:

- A small number of instructions are affected by modifications to transitions from ThumbEE state. For more information, see [ThumbEE state transitions](#).
- A substantial number of instructions have a null check on the base register before any other operation takes place, but are identical (or almost identical) in all other respects. For more information, see [Null checking on page A9-1113](#).
- A small number of instructions are modified in additional ways. See [Instructions with modifications on page A9-1113](#).
- Three Thumb instructions, BLX (immediate), 16-bit LDM, and 16-bit STM, are removed in ThumbEE state. The encoding corresponding to BLX (immediate) in Thumb is UNDEFINED in ThumbEE state. 16-bit LDM and STM are replaced by new instructions, for details see [Additional ThumbEE instructions on page A9-1123](#).
- Two new 32-bit instructions, ENTERX and LEAVEX, are introduced in both the Thumb instruction set and the ThumbEE instruction set. See [Additional instructions in Thumb and ThumbEE instruction sets on page A9-1116](#). These instructions use previously UNDEFINED encodings.

Attempting to execute ThumbEE instructions at PL2 is UNPREDICTABLE.

From the publication of issue C.a of this manual, ARM deprecates any use of the ThumbEE instruction set.

### A9.1.1 ThumbEE state transitions

Instruction set state transitions to ThumbEE state can occur implicitly as part of a return from exception, or explicitly on execution of an ENTERX instruction.

Instruction set state transitions from ThumbEE state can only occur due to an exception, or due to a transition to Thumb state using the LEAVEX instruction. Return from exception instructions (RFE and SUBS PC, LR, #imm) are UNPREDICTABLE in ThumbEE state.

Any other Thumb instructions that can update the PC in ThumbEE state are UNPREDICTABLE if they attempt to change to ARM state. Interworking of ARM and Thumb instructions is not supported in ThumbEE state. The instructions affected are:

- LDR, LDM, and POP instructions that write to the PC, if bit[0] of the value loaded to the PC is 0
- BLX (register), BX, and BXJ, where Rm bit[0] == 0.

———— **Note** —————

SVC, BKPT, and UNDEFINED instructions cause an exception to occur.

If a BXJ <Rm> instruction is executed in ThumbEE state, with Rm bit[0] == 1, it does not enter Jazelle state. Instead, it behaves like the corresponding BX <Rm> instruction and remains in ThumbEE state.

Debug state is a special case. For the rules governing changes to CPSR state bits and Debug state, see [Executing instructions in Debug state on page C5-2096](#).

## A9.1.2 Null checking

A *null check* is performed for all load/store instructions when they are executed in ThumbEE state. If the value in the base register is zero, execution branches to the NullCheck handler at HandlerBase – 4.

For most load/store instructions, this is the only difference from normal Thumb operation. Exceptions to this rule are described in this chapter.

### ———— Note —————

- The null check examines the value in the base register, not any calculated value offset from the base register.
- If the base register is the SP or the PC, a zero value in the base register results in UNPREDICTABLE behavior.
- RFE and SRS instructions do not require null checking because they have UNPREDICTABLE behavior when executed in ThumbEE state.

The instructions affected by null checking are:

- all instructions whose mnemonic starts with LD, ST, VLD or VST
- POP, PUSH, TBB, TBH, VPOP, and VPUSH.

For each of these instructions, the pseudocode shown in the Operation section uses the following function:

```
// NullCheckIfThumbEE()
// =====

NullCheckIfThumbEE(integer n)
  if CurrentInstrSet() == InstrSet_ThumbEE then
    if n == 15 then
      if IsZero(Align(PC,4)) then UNPREDICTABLE;
    elseif n == 13 then
      if IsZero(SP) then UNPREDICTABLE;
    else
      if IsZero(R[n]) then
        LR = PC<31:1> : '1'; // PC holds this instruction's address plus 4
        ITSTATE.IT = '00000000';
        BranchWritePC(TEEHBR - 4);
        EndOfInstruction();
      return;
```

## A9.1.3 Instructions with modifications

In addition to the instructions described in [ThumbEE state transitions on page A9-1112](#) and [Null checking](#), [Table A9-1](#) shows other instructions that are modified in ThumbEE state. The pseudocode, including the null check if any, is given in [ThumbEE instructions with modified behavior on page A9-1117](#).

**Table A9-1 Modified instructions**

Instructions	Rbase	Modification
LDR (register)	Rn	Rm multiplied by 4, null check
LDRH (register)	Rn	Rm multiplied by 2, null check
LDRSH (register)	Rn	Rm multiplied by 2, null check
STR (register)	Rn	Rm multiplied by 4, null check
STRH (register)	Rn	Rm multiplied by 2, null check

#### **A9.1.4 IT block and check handlers**

CHKA, stores, and loads can occur anywhere in an IT block, except that a load to the PC is permitted only as the last instruction in the block. If one of these instructions results in a branch to the null pointer or array index handlers, the IT state bits in ITSTATE are cleared. This provides unconditional execution from the start of the handler.

The original IT state bits are not preserved.

## A9.2 ThumbEE instruction set encoding

In general, instructions in the ThumbEE instruction set are encoded in exactly the same way as Thumb instructions described in [Chapter A6 Thumb Instruction Set Encoding](#). The differences are as follows:

- There are no 16-bit LDM or STM instructions in the ThumbEE instruction set.
- The 16-bit encodings used for LDM and STM in the Thumb instruction set are used for different 16-bit instructions in the ThumbEE instruction set. For details, see [16-bit ThumbEE instructions](#).
- There are two new 32-bit instructions in both Thumb state and ThumbEE state. For details, see [Additional instructions in Thumb and ThumbEE instruction sets on page A9-1116](#).

### A9.2.1 16-bit ThumbEE instructions

The encoding of 16-bit ThumbEE instructions is:

15	14	13	12	11	10	9	8	7	6	5	4	3	2	1	0	
1	1	0	0	Opcode												

[Table A9-2](#) shows the allocation of encodings in this space.

**Table A9-2 16-bit ThumbEE instructions**

Opcode	Instruction	See
0000	Handler Branch with Parameter	<a href="#">HBP on page A9-1127</a>
0001	UNDEFINED	-
001x	Handler Branch, Handler Branch with Link	<a href="#">HB, HBL on page A9-1125</a>
01xx	Handler Branch with Link and Parameter	<a href="#">HBLP on page A9-1126</a>
100x	Load Register from a frame	<a href="#">LDR (immediate) on page A9-1128</a>
1010	Check Array	<a href="#">CHKA on page A9-1124</a>
1011	Load Register from a literal pool	<a href="#">LDR (immediate) on page A9-1128</a>
110x	Load Register (array operations)	<a href="#">LDR (immediate) on page A9-1128</a>
111x	Store Register to a frame	<a href="#">STR (immediate) on page A9-1130</a>

## A9.3 Additional instructions in Thumb and ThumbEE instruction sets

On a processor with the ThumbEE Extension, there are two additional 32-bit instructions, ENTERX and LEAVEX. These are available in both Thumb state and ThumbEE state.

### A9.3.1 ENTERX, LEAVEX

ENTERX causes a change from Thumb state to ThumbEE state, or has no effect in ThumbEE state.

ENTERX is UNDEFINED in Hyp mode.

LEAVEX causes a change from ThumbEE state to Thumb state, or has no effect in Thumb state.

#### Encoding T1 ThumbEE

ENTERX Not permitted in IT block.

LEAVEX Not permitted in IT block.

15	14	13	12	11	10	9	8	7	6	5	4	3	2	1	0	15	14	13	12	11	10	9	8	7	6	5	4	3	2	1	0
1	1	1	1	0	0	1	1	1	0	1	1	(1)	(1)	(1)	(1)	1	0	(0)	0	(1)	(1)	(1)	(1)	0	0	0	J	(1)	(1)	(1)	(1)

```
is_enterx = (J == '1');
if InITBlock() then UNPREDICTABLE;
```

#### Assembler syntax

ENTERX{<q>} Encoded as J = 1

LEAVEX{<q>} Encoded as J = 0

where:

<q> See [Standard assembler syntax fields on page A8-287](#). An ENTERX or LEAVEX instruction must be unconditional.

#### Operation

```
if is_enterx then
    if CurrentModeIsHyp() then
        UNDEFINED;
    else
        SelectInstrSet(InstrSet_ThumbEE);
else
    SelectInstrSet(InstrSet_Thumb);
```

#### Exceptions

None.



## A9.4 ThumbEE instructions with modified behavior

The 16-bit encodings of the following Thumb instructions have changed functionality in ThumbEE:

- [LDR \(register\) on page A9-1118](#)
- [LDRH \(register\) on page A9-1119](#)
- [LDRSH \(register\) on page A9-1120](#)
- [STR \(register\) on page A9-1121](#)
- [STRH \(register\) on page A9-1122](#).

In ThumbEE state there are the following changes in the behavior of instructions:

- All load/store instructions perform null checks on their base register values, as described in [Null checking on page A9-1113](#). The pseudocode for these instructions in [Chapter A8 Instruction Details](#) describes this by calling the `NullCheckIfThumbEE()` pseudocode procedure.
- Instructions that attempt to enter ARM state are UNPREDICTABLE, as described in [ThumbEE state transitions on page A9-1112](#). The pseudocode for these instructions in [Chapter A8 Instruction Details](#) describes this by calling the `SelectInstrSet()` or `BXWritePC()` pseudocode procedure.
- The `BXJ` instruction behaves like the `BX` instruction, as described in [ThumbEE state transitions on page A9-1112](#). The pseudocode for the instruction, in [BXJ on page A8-354](#), describes this directly.

### A9.4.1 LDR (register)

Load Register (register) calculates an address from a base register value and an offset register value, loads a word from memory, and writes it to a register. The offset register value is shifted left by 2 bits. For information about memory accesses see [Memory accesses on page A8-294](#).

The similar Thumb instruction does not have a left shift.

**Encoding T1** ThumbEE  
LDR<c> <Rt>, [<Rn>, <, <Rm>, LSL #2]

15	14	13	12	11	10	9	8	7	6	5	4	3	2	1	0
0	1	0	1	1	0	0	Rm			Rn			Rt		

t = UInt(Rt); n = UInt(Rn); m = UInt(Rm);

#### Assembler syntax

LDR{<c>}{<q>} <Rt>, [<Rn>, <Rm>, LSL #2]

where:

- <c>, <q> See [Standard assembler syntax fields on page A8-287](#).
- <Rt> The destination register.
- <Rn> The base register.
- <Rm> Contains the offset that is shifted and applied to the value of <Rn> to form the address.

#### Operation

```
if ConditionPassed() then
    EncodingSpecificOperations(); NullCheckIfThumbEE(n);
    address = R[n] + LSL(R[m],2);
    R[t] = MemU[address,4];
```

#### Exceptions and checks

Data Abort, NullCheck.

## A9.4.2 LDRH (register)

Load Register Halfword (register) calculates an address from a base register value and an offset register value, loads a halfword from memory, zero-extends it to form a 32-bit word, and writes it to a register. The offset register value is shifted left by 1 bit. For information about memory accesses see [Memory accesses on page A8-294](#).

The similar Thumb instruction does not have a left shift.

**Encoding T1** ThumbEE  
LDRH<c> <Rt>, [<Rn>, <, <Rm>, LSL #1]

15	14	13	12	11	10	9	8	7	6	5	4	3	2	1	0
0	1	0	1	1	0	1	Rm			Rn			Rt		

t = UInt(Rt); n = UInt(Rn); m = UInt(Rm);

### Assembler syntax

LDRH{<c>}{<q>} <Rt>, [<Rn>, <Rm>, LSL #1]

where:

- <c>, <q> See [Standard assembler syntax fields on page A8-287](#).
- <Rt> The destination register.
- <Rn> The base register.
- <Rm> Contains the offset that is shifted and applied to the value of <Rn> to form the address.

### Operation

```
if ConditionPassed() then
    EncodingSpecificOperations(); NullCheckIfThumbEE(n);
    address = R[n] + LSL(R[m],1);
    R[t] = ZeroExtend(MemU[address,2], 32);
```

### Exceptions and checks

Data Abort, NullCheck.

### A9.4.3 LDRSH (register)

Load Register Signed Halfword (register) calculates an address from a base register value and an offset register value, loads a halfword from memory, sign-extends it to form a 32-bit word, and writes it to a register. The offset register value is shifted left by 1 bit. For information about memory accesses see [Memory accesses on page A8-294](#).

The similar Thumb instruction does not have a left shift.

#### Encoding T1 ThumbEE

LDRSH<C> <Rt>, [<Rn>, <Rm>, LSL #1]

15	14	13	12	11	10	9	8	7	6	5	4	3	2	1	0
0	1	0	1	1	1	1	Rm			Rn			Rt		

t = UInt(Rt); n = UInt(Rn); m = UInt(Rm);

#### Assembler syntax

LDRSH{<C>}{<q>} <Rt>, [<Rn>, <Rm>, LSL #1]

where:

- <C>, <q> See [Standard assembler syntax fields on page A8-287](#).
- <Rt> The destination register.
- <Rn> The base register.
- <Rm> Contains the offset that is shifted and applied to the value of <Rn> to form the address.

#### Operation

```
if ConditionPassed() then
    EncodingSpecificOperations(); NullCheckIfThumbEE(n);
    address = R[n] + LSL(R[m],1);
    R[t] = SignExtend(MemU[address,2], 32);
```

#### Exceptions and checks

Data Abort, NullCheck.

## A9.4.4 STR (register)

Store Register (register) calculates an address from a base register value and an offset register value, and stores a word from a register to memory. The offset register value is shifted left by 2 bits. For information about memory accesses see [Memory accesses on page A8-294](#).

The similar Thumb instruction does not have a left shift.

**Encoding T1** ThumbEE  
STR<c> <Rt>, [<Rn>, <Rm>, LSL #2]

15	14	13	12	11	10	9	8	7	6	5	4	3	2	1	0
0	1	0	1	0	0	0	Rm			Rn			Rt		

t = UInt(Rt); n = UInt(Rn); m = UInt(Rm);

### Assembler syntax

STR{<c>}{<q>} <Rt>, [<Rn>, <Rm>, LSL #2]

where:

- <c>, <q> See [Standard assembler syntax fields on page A8-287](#).
- <Rt> The source register.
- <Rn> The base register.
- <Rm> Contains the offset that is shifted and applied to the value of <Rn> to form the address.

### Operation

```
if ConditionPassed() then
    EncodingSpecificOperations(); NullCheckIfThumbEE(n);
    address = R[n] + LSL(R[m],2);
    MemU[address,4] = R[t];
```

### Exceptions and checks

Data Abort, NullCheck.

### A9.4.5 STRH (register)

Store Register Halfword (register) calculates an address from a base register value and an offset register value, and stores a halfword from a register to memory. The offset register value is shifted left by 1 bit. For information about memory accesses see [Memory accesses on page A8-294](#).

The similar Thumb instruction does not have a left shift.

**Encoding T1** ThumbEE  
STRH<c> <Rt>, [<Rn>, <Rm>, LSL #1]

15	14	13	12	11	10	9	8	7	6	5	4	3	2	1	0
0	1	0	1	0	0	1	Rm			Rn			Rt		

t = UInt(Rt); n = UInt(Rn); m = UInt(Rm);

#### Assembler syntax

STRH{<c>}{<q>} <Rt>, [<Rn>, <Rm>, LSL #1]

where:

- <c>, <q> See [Standard assembler syntax fields on page A8-287](#).
- <Rt> The source register.
- <Rn> The base register.
- <Rm> Contains the offset that is shifted and applied to the value of <Rn> to form the address.

#### Operation

```
if ConditionPassed() then
    EncodingSpecificOperations(); NullCheckIfThumbEE(n);
    address = R[n] + LSL(R[m],1);
    MemU[address,2] = R[t]<15:0>;
```

#### Exceptions and checks

Data Abort, NullCheck.

## A9.5 Additional ThumbEE instructions

The following instructions are available in ThumbEE state, but not in Thumb state:

- [CHKA](#) on page A9-1124
- [HB, HBL](#) on page A9-1125
- [HBLP](#) on page A9-1126
- [HBP](#) on page A9-1127
- [LDR \(immediate\)](#) on page A9-1128
- [STR \(immediate\)](#) on page A9-1130.

These are 16-bit instructions. They occupy the instruction encoding space that STMIA and LDMIA occupy in Thumb state.

## A9.5.1 CHKA

CHKA (Check Array) compares the unsigned values in two registers. If the first is lower than, or the same as, the second, it copies the PC to the LR, and causes a branch to the IndexCheck handler.

### Encoding E1 ThumbEE

CHKA<c> <Rn>, <Rm>

15	14	13	12	11	10	9	8	7	6	5	4	3	2	1	0
1	1	0	0	1	0	1	0	N	Rm			Rn			

```
n = UInt(N:Rn); m = UInt(Rm);
if n == 15 || m IN {13,15} then UNPREDICTABLE;
```

### Assembler syntax

CHKA{<c>}{<q>} <Rn>, <Rm>

where:

- <c>, <q> See [Standard assembler syntax fields on page A8-287](#).
- <Rn> The first operand register. This contains the array size. Use of the SP is permitted.
- <Rm> The second operand register. This contains the array index.

### Operation

```
if ConditionPassed() then
    EncodingSpecificOperations();
    if UInt(R[n]) <= UInt(R[m]) then
        LR = PC<31:1> : '1'; // PC holds this instruction's address + 4
        ITSTATE.IT = '00000000';
        BranchWritePC(TEEHBR - 8);
```

### Exceptions and checks

IndexCheck.

### Usage

Use CHKA to check that an array index is in bounds.

CHKA does not modify the APSR condition flags.



## A9.5.2 HB, HBL

Handler Branch branches to a specified handler.

Handler Branch with Link saves a return address to the LR, and then branches to a specified handler.

### Encoding E1 ThumbEE

HB{L}<c> #<HandlerID> Outside or last in IT block

15	14	13	12	11	10	9	8	7	6	5	4	3	2	1	0
1	1	0	0	0	0	1	L	handler							

```
generate_link = (L == '1'); handler_offset = ZeroExtend(handler:'00000', 32);
if InITBlock() && !LastInITBlock() then UNPREDICTABLE;
```

### Assembler syntax

HB{<c>}{<q>} #<HandlerID> Encoded as L = 0

HBL{<c>}{<q>} #<HandlerID> Encoded as L = 1

where:

<c>, <q> See [Standard assembler syntax fields on page A8-287](#).

<HandlerID> The index number of the handler to be called, in the range 0-255.

### Operation

```
if ConditionPassed() then
    EncodingSpecificOperations();
    if generate_link then
        next_instr_addr = PC - 2;
        LR = next_instr_addr<31:1> : '1';
        BranchWritePC(TEEHBR + handler_offset);
```

### Exceptions

None.

### Usage

HB{L} makes a large number of handlers available.

### A9.5.3 HBLP

HBLP (Handler Branch with Link and Parameter) saves a return address to the LR, and then branches to a specified handler. It passes a 5-bit parameter to the handler in R8.

#### Encoding E1 ThumbEE

HBLP<c> #<imm>, #<HandlerID>

Outside or last in IT block

15	14	13	12	11	10	9	8	7	6	5	4	3	2	1	0
1	1	0	0	0	1	imm5					handler				

```
imm32 = ZeroExtend(imm5, 32); handler_offset = ZeroExtend(handler:'00000', 32);
if InITBlock() && !LastInITBlock() then UNPREDICTABLE;
```

#### Assembler syntax

HBLP{<c>}{<q>} #<imm>, #<HandlerID>

where:

- <c>, <q> See [Standard assembler syntax fields on page A8-287](#).
- <imm> The parameter to pass to the handler, in the range 0-31.
- <HandlerID> The index number of the handler to be called, in the range 0-31.

#### Operation

```
if ConditionPassed() then
    EncodingSpecificOperations();
    R[8] = imm32;
    next_instr_addr = PC - 2;
    LR = next_instr_addr<31:1> : '1';
    BranchWritePC(TEEHBR + handler_offset);
```

#### Exceptions

None.

## A9.5.4 HBP

HBP (Handler Branch with Parameter) causes a branch to a specified handler. It passes a 3-bit parameter to the handler in R8.

### Encoding E1

ThumbEE

HBP<c> #<imm>, #<HandlerID>

Outside or last in IT block

15	14	13	12	11	10	9	8	7	6	5	4	3	2	1	0
1	1	0	0	0	0	0	0	imm3			handler				

```
imm32 = ZeroExtend(imm3, 32); handler_offset = ZeroExtend(handler:'00000', 32);
if InITBlock() && !LastInITBlock() then UNPREDICTABLE;
```

### Assembler syntax

HBP{<c>}{<q>} #<imm>, #<HandlerID>

where:

- <c>, <q> See [Standard assembler syntax fields on page A8-287](#).
- <imm> The parameter to pass to the handler, in the range 0-7.
- <HandlerID> The index number of the handler to be called, in the range 0-31.

### Operation

```
if ConditionPassed() then
    EncodingSpecificOperations();
    R[8] = imm32;
    BranchWritePC(TEEHBR + handler_offset);
```

### Exceptions

None.

### A9.5.5 LDR (immediate)

Load Register (immediate) provides 16-bit instructions to load words using:

- R9 as base register, with a positive offset of up to 63 words, for loading from a frame
- R10 as base register, with a positive offset of up to 31 words, for loading from a literal pool
- R0-R7 as base register, with a negative offset of up to 7 words, for array operations.

#### Encoding E1 ThumbEE

LDR<c> <Rt>, [R9{, #<imm>}]

15	14	13	12	11	10	9	8	7	6	5	4	3	2	1	0
1	1	0	0	1	1	0	imm6						Rt		

t = UInt(Rt); n = 9; imm32 = ZeroExtend(imm6:'00', 32); add = TRUE;

#### Encoding E2 ThumbEE

LDR<c> <Rt>, [R10{, #<imm>}]

15	14	13	12	11	10	9	8	7	6	5	4	3	2	1	0
1	1	0	0	1	0	1	1	imm5				Rt			

t = UInt(Rt); n = 10; imm32 = ZeroExtend(imm5:'00', 32); add = TRUE;

#### Encoding E3 ThumbEE

LDR<c> <Rt>, [<Rn>{, #-<imm>}]

15	14	13	12	11	10	9	8	7	6	5	4	3	2	1	0
1	1	0	0	1	0	0	imm3		Rn		Rt				

t = UInt(Rt); n = UInt(Rn); imm32 = ZeroExtend(imm3:'00', 32); add = FALSE;

## Assembler syntax

LDR{<c>}{<q>} <Rt>, [<Rn>{, #<imm>}]

where:

<c>, <q> See *Standard assembler syntax fields* on page A8-287.

<Rt> The destination register.

<Rn> The base register. This register is:

- R9 for encoding E1
- R10 for encoding E2
- any of R0-R7 for encoding E3.

<imm> The immediate offset used for forming the address. Values are multiples of 4 in the range:

0-252	encoding E1
0-124	encoding E2
-28-0	encoding E3.

<imm> can be omitted, meaning an offset of 0.

## Operation

```
if ConditionPassed() then
    EncodingSpecificOperations(); NullCheckIfThumbEE(n);
    address = if add then (R[n] + imm32) else (R[n] - imm32);
    R[t] = MemU[address,4];
```

## Exceptions and checks

Data Abort, NullCheck.

## A9.5.6 STR (immediate)

Store Register (immediate) provides a 16-bit word store instruction using R9 as base register, with a positive offset of up to 63 words, for storing to a frame.

### Encoding E1 ThumbEE

STR<c> <Rt>, [R9, #<imm>]

15	14	13	12	11	10	9	8	7	6	5	4	3	2	1	0
1	1	0	0	1	1	1	imm6						Rt		

t = UInt(Rt); imm32 = ZeroExtend(imm6:'00', 32);

### Assembler syntax

STR{<c>}{<q>} <Rt>, [R9, #<imm>]

where:

<c>, <q> See [Standard assembler syntax fields on page A8-287](#).

<Rt> The source register.

<imm> The immediate offset applied to the value of R9 to form the address. Values are multiples of 4 in the range 0-252.

<imm> can be omitted, meaning an offset of 0.

### Operation

```
if ConditionPassed() then
    EncodingSpecificOperations(); NullCheckIfThumbEE(9);
    address = R[9] + imm32;
    MemU[address,4] = R[t];
```

### Exceptions and checks

Data Abort, NullCheck.

# Part B

## System Level Architecture





# Chapter B1

## The System Level Programmers' Model

This chapter provides a system level view of the programmers' model. It contains the following sections:

- *About the System level programmers' model* on page B1-1134
- *System level concepts and terminology* on page B1-1135
- *ARM processor modes and ARM core registers* on page B1-1139
- *Instruction set states* on page B1-1155
- *The Security Extensions* on page B1-1156
- *The Large Physical Address Extension* on page B1-1159
- *The Virtualization Extensions* on page B1-1161
- *Exception handling* on page B1-1164
- *Exception descriptions* on page B1-1204
- *Coprocessors and system control* on page B1-1225
- *Advanced SIMD and floating-point support* on page B1-1228
- *Thumb Execution Environment* on page B1-1239
- *Jazelle direct bytecode execution* on page B1-1240
- *Traps to the hypervisor* on page B1-1247.

---

### Note

---

In this chapter, system register names usually link to the description of the register in [Chapter B4 System Control Registers in a VMSA implementation](#), for example `SCTLR`. If the register is included in a PMSA implementation, then it is also described in [Chapter B6 System Control Registers in a PMSA implementation](#).

---

## B1.1 About the System level programmers' model

An application programmer has only a restricted view of the system. The System level programmers' model supports this application level view of the system, and includes features required for an operating system (OS) to provide the programming environment seen by an application.

The system level programmers' model includes all of the system features required to support operating systems and to handle hardware events.

[System level concepts and terminology](#) on page B1-1135 gives a system level introduction to the basic concepts of the ARM architecture, and the terminology used for describing the architecture. The rest of this chapter describes the system level programmers' model.

The other chapters in this part describe:

- The memory system architectures:
  - [Chapter B2 Common Memory System Architecture Features](#) describes common features of the memory system architectures
  - [Chapter B3 Virtual Memory System Architecture \(VMSA\)](#) describes the *Virtual Memory System Architecture* (VMSA) used in the ARMv7-A profile
  - [Chapter B5 Protected Memory System Architecture \(PMSA\)](#) describes the *Protected Memory System Architecture* (PMSA) used in the ARMv7-R profile.
- The CPUID mechanism, that an OS can use to determine the capabilities of the processor it is running on. See [Chapter B7 The CPUID Identification Scheme](#).
- The instructions that provide system level functionality, such as returning from an exception. See [Chapter B9 System Instructions](#).

## B1.2 System level concepts and terminology

The following sections introduce a number of concepts that are critical to understanding the system level description of the architecture:

- [Mode, state, and privilege level](#)
- [Exceptions on page B1-1136](#).

The Virtualization Extensions, described in [The Virtualization Extensions on page B1-1161](#), significantly affect some areas of ARM terminology. For consistency, this manual applies these changes across all ARMv7 implementations.

### B1.2.1 Mode, state, and privilege level

Mode, state, and privilege level are key concepts in the ARM architecture.

#### Mode

The ARM architecture A and R profiles provide a set of modes that support normal software execution and handle exceptions. The current mode determines:

- the set of registers that are available to the processor
- the privilege level of the executing software.

For more information, see [ARM processor modes and ARM core registers on page B1-1139](#).

#### State

In the ARM architecture, *state* describes the following distinct concepts:

##### Instruction set state

ARMv7 provides four instruction set states. The instruction set state determines the instruction set that is being executed, and is one of ARM state, Thumb state, Jazelle state, or ThumbEE state. [Instruction set state register, ISETSTATE on page A2-50](#) gives more information about these states.

##### Execution state

The execution state consists of the instruction set state and some control bits that modify how the instruction stream is decoded. For details, see [Execution state registers on page A2-50](#) and [Program Status Registers \(PSRs\) on page B1-1147](#).

**Security state** In the ARM architecture, the number of security states depends on whether an implementation includes the Security Extensions:

- An implementation that includes the Security Extensions provides two security states, Secure state and Non-secure state. Each security state has its own system registers and memory address space.

The security state is largely independent of the processor mode. The only exceptions to this independence of security state and processor mode are:

- Monitor mode, that exists only in the Secure state, and supports transitions between Secure and Non-secure state
- Hyp mode, part of the Virtualization Extensions, that exists only in the Non-secure state, because the Virtualization Extensions only support virtualization of the Non-secure state.

Some system control resources are only accessible from the Secure state.

For more information, see [The Security Extensions on page B1-1156](#).

- An implementation that does not include the Security Extensions provides only a single security state.

In this manual:

- *Secure software* means software running in Secure state
- *Non-secure software* means software running in Non-secure state.

**Debug state** Debug state refers to the processor being halted for debug purposes, because a debug event has occurred when the processor is configured to Halting debug-mode. See [Invasive debug on page C1-2021](#).

When the processor is not in Debug state it is described as being in Non-debug state.

Except where explicitly stated otherwise, parts A and B of this manual describe processor behavior and instruction execution in Non-debug state. [Chapter C5 Debug State](#) describes the differences in Debug state.

## Privilege level

Privilege level is an attribute of software execution, in a particular security state, determined by the processor mode, as follows:

**Secure state** In Secure state there are two privilege levels:

- PL0** Software executed in User mode executes at PL0.
- PL1** Software executed in any mode other than User mode executes at PL1.

**Non-secure state**

In Non-secure state there are two or three privilege levels:

- PL0** Software executed in User mode executes at PL0.
- PL1** Software executed in any mode other than User or Hyp mode executes at PL1.
- PL2** In an implementation that includes the Virtualization Extensions, software executed in Hyp mode executes at PL2.

Software execution at PL0 is sometimes described as unprivileged execution. A mode associated with a particular privilege level,  $PL_n$ , can be described as a  $PL_n$  mode.

### ———— Note ————

- The privilege level defines the ability to access resources in the current security state, and does not imply anything about the ability to access resources in the other security state.
- An implementation that does not include the Virtualization Extensions has no Non-secure resources that can be accessed only from the PL2 privilege level.

For more information see [Processor privilege levels, execution privilege, and access privilege on page A3-141](#).

## B1.2.2 Exceptions

An exception is a condition that changes the normal flow of control in a program. The change of flow switches execution to an exception handler, and the state of the system at the point where the exception occurred is presented to the exception handler. A key component of the state presented to the handler is the return address, that indicates the point in the instruction stream from which the exception was taken.

The ARM architecture provides a number of different exceptions as described in [Exception handling on page B1-1164](#). The architecture defines the mode each exception is taken to. The Security Extensions and Virtualization Extensions add configuration settings that can determine the mode to which an exception is taken.

## Terminology for describing exceptions

In this manual, a number of terms have specific meanings when describing exceptions:

- An exception is *generated* in one of the following ways:
  - Directly as a result of the execution or attempted execution of the instruction stream. For example, an exception is generated as a result of an undefined instruction.
  - Indirectly, as a result of something in the state of the system. For example, an exception is generated as a result of an interrupt signaled by a peripheral.
- An exception is *taken* by a processor at the point where it causes a change to the normal flow of control in the program.  
The mode in use immediately before an exception is taken is described as the mode the exception is *taken from*. The mode that is used on taking the exception is described as the mode the exception is *taken to*.  
The mode an exception is taken to is determined by:
  - the type of exception
  - the mode the exception is taken from
  - configuration settings in the Security Extensions and Virtualization Extensions.In an implementation that does not include the Security Extensions, the architecture defines the mode to which each exception is taken. This is called the *default mode* for that exception.
- An exception is described as *synchronous* if both of the following apply:
  - the exception is generated as a result of direct execution or attempted execution of the instruction stream
  - the return address presented to the exception handler is guaranteed to indicate the instruction that caused the exception.
- An exception is described as *asynchronous* if either of the following applies:
  - the exception is not generated as a result of direct execution or attempted execution of the instruction stream
  - the return address presented to the exception handler is not guaranteed to indicate the instruction that caused the exception.

### ———— **Note** ————

For a synchronous exception, the exception is taken from the mode in which it was generated. However, for an asynchronous exception, the processor mode might change after the exception is generated and before it is taken.

Asynchronous exceptions are classified as:

#### **Precise asynchronous exceptions**

The state presented to the exception handler is guaranteed to be consistent with the state at an identifiable instruction boundary in the execution stream from which the exception was taken.

#### **Imprecise asynchronous exceptions**

The state presented to the exception handler is not guaranteed to be consistent with any point in the execution stream from which the exception was taken.

## Exceptions, privilege, and security state

ARMv7 has the following security state and privilege requirements for exception handling:

- Exceptions must be taken to a mode with a privilege level of PL1 or higher.
- Within a particular security state:
  - an exception must be taken to a mode with a privilege level greater than or equal to the privilege level of the mode the exception is taken from
  - exception return must be made to a mode with a privilege level less than or equal to the privilege level at which the exception handler is executing.

In an implementation that does not include the Security Extensions, this requirement applies to the single security state of the processor.

- In an implementation that includes the Security Extensions:
  - An exception can be taken from any Non-secure mode, including Hyp mode, to Secure Monitor mode.

———— **Note** ————

In ARMv7, privilege levels are defined independently in each security state. Therefore, the rule about privilege levels is not relevant to taking an exception from a Non-secure mode to a Secure mode.

- An exception can never be taken from a Secure mode to a Non-secure mode.

One effect of these requirements is that an exception taken from Non-secure Hyp mode must be taken to either:

- Non-secure Hyp mode
- Secure Monitor mode.

## B1.3 ARM processor modes and ARM core registers

The following sections describe the ARM processor modes and the ARM core registers:

- [ARM processor modes](#)
- [ARM core registers on page B1-1143](#)
- [Program Status Registers \(PSRs\) on page B1-1147](#)
- [ELR\\_hyp on page B1-1154](#).

### B1.3.1 ARM processor modes

Table B1-1 shows the processor modes defined by the ARM architecture. In this table:

- the *Processor mode* column gives the name of each mode and the abbreviation used, for example, in the ARM core register name suffixes used in [ARM core registers on page B1-1143](#)
- the *Privilege level* column gives the privilege level of software executing in that mode, see [Privilege level on page B1-1136](#)
- the *Encoding* column gives the corresponding CPSR.M field
- the *Security state* column applies only to processors that implement the Security Extensions.

**Table B1-1 ARM processor modes**

Processor mode	Encoding	Privilege level	Implemented	Security state	
User	usr	10000	PL0	Always	Both
FIQ	fiq	10001	PL1	Always	Both
IRQ	irq	10010	PL1	Always	Both
Supervisor	svc	10011	PL1	Always	Both
Monitor	mon	10110	PL1	With Security Extensions	Secure only
Abort	abt	10111	PL1	Always	Both
Hyp	hyp	11010	PL2	With Virtualization Extensions	Non-secure only
Undefined	und	11011	PL1	Always	Both
System	sys	11111	PL1	Always	Both

Mode changes can be made under software control, or can be caused by an external or internal exception.

#### Notes on the ARM processor modes

**User mode** An operating system runs applications in User mode to restrict the use of system resources. Software executing in User mode executes at PL0. Execution in User mode is sometimes described as unprivileged execution. Application programs normally execute in User mode, and any program executed in User mode:

- makes only unprivileged accesses to system resources, meaning it cannot access protected system resources
- makes only unprivileged access to memory
- cannot change mode except by causing an exception, see [Exception handling on page B1-1164](#).

**System mode** Software executing in System mode executes at PL1. System mode has the same registers available as User mode, and is not entered by any exception.

### Supervisor mode

Supervisor mode is the default mode to which a Supervisor Call exception is taken.

Executing a SVC (Supervisor Call) instruction generates an Supervisor Call exception, that is taken to Supervisor mode.

A processor enters Supervisor mode on Reset.

**Abort mode** Abort mode is the default mode to which a Data Abort exception or Prefetch Abort exception is taken.

### Undefined mode

Undefined mode is the default mode to which an instruction-related exception, including any attempt to execute an UNDEFINED instruction, is taken.

**FIQ mode** FIQ mode is the default mode to which an FIQ interrupt is taken.

**IRQ mode** IRQ mode is the default mode to which an IRQ interrupt is taken.

**Hyp mode** Hyp mode is the Non-secure PL2 mode, implemented as part of the Virtualization Extensions. Hyp mode is entered on taking an exception from Non-secure state that must be taken to PL2

The Hypervisor Call exception and Hyp Trap exception are exceptions that are implemented as part of the Virtualization Extensions, and that are always taken in Hyp mode.

#### ———— **Note** —————

This means that Hypervisor Call exceptions and Hyp Trap exceptions cannot be taken from Secure state.

In a Non-secure PL1 mode, executing a HVC (Hypervisor Call) instruction generates a Hypervisor Call exception.

For more information, see [Hyp mode on page B1-1141](#).

### Monitor mode

Monitor mode is the mode to which a Secure Monitor Call exception is taken.

In a PL1 mode, executing an SMC (Secure Monitor Call) instruction generates a Secure Monitor Call exception.

Monitor mode is a Secure mode, meaning it is always in the Secure state, regardless of the value of the SCR.NS bit.

Software running in Monitor mode has access to both the Secure and Non-secure copies of system registers. This means Monitor mode provides the normal method of changing between the Secure and Non-secure security states.

#### ———— **Note** —————

It is important to distinguish between:

#### **Monitor mode**

This is a processor mode that is only available when an implementation includes the Security Extensions. It is used in normal operation, as a mechanism to transfer between Secure and Non-secure state, as described in this section.

#### **Monitor debug-mode**

This is a debug mode and is available regardless of whether the implementation includes the Security Extensions. For more information, see [About the ARM Debug architecture on page C1-2021](#).

Monitor mode is implemented only as part of the Security Extensions. For more information, see [The Security Extensions on page B1-1156](#).



## Secure and Non-secure modes

In a processor that implements the Security Extensions, most mode names can be qualified as Secure or Non-secure, to indicate whether the processor is also in Secure state or Non-secure state. For example:

- if a processor is in Supervisor mode and Secure state, it is in *Secure Supervisor mode*
- if a processor is in User mode and Non-secure state, it is in *Non-secure User mode*.

### ———— Note ————

As indicated in the appropriate Mode descriptions:

- Monitor mode is a Secure mode, meaning it is always in the Secure state
- Hyp mode is a Non-secure mode, meaning it is accessible only in Non-secure state.

Figure B1-1 shows the modes, privilege levels, and security states, for an implementation that includes the Security Extensions and the Virtualization Extensions.

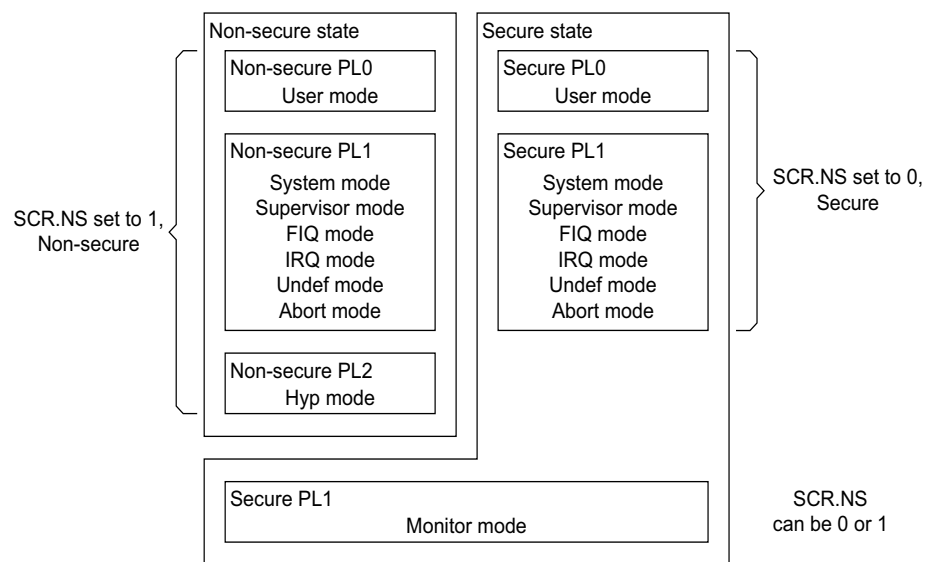

Figure B1-1 Modes, privilege levels, and security states

## Hyp mode

Hyp mode is a Non-secure mode, implemented only as part of the Virtualization Extensions. It provides the usual method of controlling almost all of the functionality of the Virtualization Extensions.

### ———— Note ————

The alternative method of controlling this functionality is by accessing the Hyp mode controls from Secure Monitor mode, with the `SCR.NS` bit set to 1.

This section summarizes how Hyp mode differs from the other modes, and references where the features of Hyp mode are described in more detail:

- Software executing in Hyp mode executes at PL2, see *Mode, state, and privilege level* on page B1-1135.
- Hyp mode is accessible only in Non-secure state. When the processor is in Secure state, setting `CPSR.M` to `0b11010`, the encoding for Hyp mode, has no meaning. Therefore, in Secure state, the effect of attempting to set `CPSR.M` to `0b11010` is UNPREDICTABLE. For more information see *The Current Program Status Register (CPSR)* on page B1-1147.

- In Non-debug state, the only mechanisms for changing to Hyp mode are:
  - an exception taken from a Non-secure PL1 or PL0 mode
  - an exception return from Secure Monitor mode.
- In Hyp mode, the only exception return is execution of an ERET instruction, see [ERET on page B9-1980](#).
- In Hyp mode, the CPACR has no effect on the execution of coprocessor, floating-point, or Advanced SIMD instructions. The HCPTR controls execution of these instructions in Hyp mode.
- If software running in Hyp mode executes an SVC instruction, the Supervisor Call exception generated by the instruction is taken to Hyp mode, see [SVC \(previously SWI\) on page A8-720](#).
- The effect of an exception return with the restored CPSR specifying Hyp mode is UNPREDICTABLE if either:
  - SCR.NS is set to 0
  - the return is from a Non-secure PL1 mode.
- The instructions described in the following sections are UNDEFINED if executed in Hyp mode:
  - [SRS \(Thumb\) on page B9-2002](#)
  - [SRS \(ARM\) on page B9-2004](#)
  - [RFE on page B9-1998](#)
  - [LDM \(exception return\) on page B9-1984](#)
  - [LDM \(User registers\) on page B9-1986](#)
  - [STM \(User registers\) on page B9-2006](#)
  - [SUBS PC, LR and related instructions \(ARM\) on page B9-2010](#).
  - [SUBS PC, LR \(Thumb\) on page B9-2008](#), when executed with a nonzero constant.

————— **Note** —————

In Thumb state, ERET is encoded as SUBS PC, LR, #0, and therefore this is a valid instruction.

- The unprivileged Load unprivileged and Store unprivileged instructions LDRT, LDRSHT, LDRHT, LDRBT, STRT, STRHT, and STRBT, are UNPREDICTABLE if executed in Hyp mode.

From reset, the HVC instruction is UNDEFINED in Non-secure PL1 modes, meaning entry to Hyp mode is disabled by default. To permit entry to Hyp mode using the Hypervisor Call exception, Secure software must enable use of the HVC instruction by setting the SCR.HCE bit to 1. In addition, when SCR.HCE is set to 0, HVC is UNPREDICTABLE in Hyp mode.

### Pseudocode details of mode operations

The BadMode() function tests whether a 5-bit mode number corresponds to one of the permitted modes:

```
// BadMode()
// =====

boolean BadMode(bits(5) mode)
    case mode of
        when '10000' result = FALSE;           // User mode
        when '10001' result = FALSE;           // FIQ mode
        when '10010' result = FALSE;           // IRQ mode
        when '10011' result = FALSE;           // Supervisor mode
        when '10110' result = !HaveSecurityExt(); // Monitor mode
        when '10111' result = FALSE;           // Abort mode
        when '11010' result = !HaveVirtExt();   // Hyp mode
        when '11011' result = FALSE;           // Undefined mode
        when '11111' result = FALSE;           // System mode
        otherwise   result = TRUE;
    return result;
```

The following pseudocode functions provide information about the current mode:

```
// CurrentModeIsNotUser()
// =====

boolean CurrentModeIsNotUser()
  if BadMode(CPSR.M) then UNPREDICTABLE;
  if CPSR.M == '10000' then return FALSE; // User mode
  return TRUE; // Other modes
// CurrentModeIsUserOrSystem()
// =====

boolean CurrentModeIsUserOrSystem()
  if BadMode(CPSR.M) then UNPREDICTABLE;
  if CPSR.M == '10000' then return TRUE; // User mode
  if CPSR.M == '11111' then return TRUE; // System mode
  return FALSE; // Other modes

// CurrentModeIsHyp()
// =====

boolean CurrentModeIsHyp()
  if BadMode(CPSR.M) then UNPREDICTABLE;
  if CPSR.M == '11010' then return TRUE; // Hyp mode
  return FALSE; // Other modes
```

### B1.3.2 ARM core registers

[ARM core registers on page A2-45](#) describes the application level view of the ARM core registers. This view provides 16 ARM core registers, R0 to R12, the *stack pointer* (SP), the *link register* (LR), and the *program counter* (PC). These registers are selected from a larger set of registers, that includes *Banked* copies of some registers, with the current register selected by the execution mode. The implementation and banking of the ARM core registers depends on whether or not the implementation includes the Security Extensions, or the Virtualization Extensions. [Figure B1-2 on page B1-1144](#) shows the full set of Banked ARM core registers, the Program Status Registers CPSR and SPSR, and the ELR\_hyp Special register.

———— **Note** —————

- The architecture uses system level register names, such as R0\_usr, R8\_usr, and R8\_fiq, when it must identify a specific register. The application level names refer to the registers for the current mode, and usually are sufficient to identify a register.
- The Security Extensions and Virtualization Extensions are supported only in the ARMv7-A architecture profile.
- The Virtualization Extensions require implementation of the Security Extensions.

Application level view		System level view							
	User	System	Hyp <sup>†</sup>	Supervisor	Abort	Undefined	Monitor <sup>‡</sup>	IRQ	FIQ
R0	R0_usr								
R1	R1_usr								
R2	R2_usr								
R3	R3_usr								
R4	R4_usr								
R5	R5_usr								
R6	R6_usr								
R7	R7_usr								
R8	R8_usr								R8_fiq
R9	R9_usr								R9_fiq
R10	R10_usr								R10_fiq
R11	R11_usr								R11_fiq
R12	R12_usr								R12_fiq
SP	SP_usr		SP_hyp	SP_svc	SP_abt	SP_und	SP_mon	SP_irq	SP_fiq
LR	LR_usr			LR_svc	LR_abt	LR_und	LR_mon	LR_irq	LR_fiq
PC	PC								
APSR	CPSR								
			SPSR_hyp	SPSR_svc	SPSR_abt	SPSR_und	SPSR_mon	SPSR_irq	SPSR_fiq
			ELR_hyp						

‡ Part of the Security Extensions. Exists only in Secure state.  
 † Part of the Virtualization Extensions. Exists only in Non-secure state.  
 Cells with no entry indicate that the User mode register is used.

**Figure B1-2 ARM core registers, PSRs, and ELR\_hyp, showing register banking**

As described in *Processor mode for taking exceptions on page B1-1172*, on taking an exception the processor changes mode, unless it is already in the mode to which it must take the exception. Each mode that the processor might enter in this way has:

- A Banked copy of the stack pointer, for example SP\_irq and SP\_hyp.
- A register that holds a preferred return address for the exception. This is:
  - for each PL1 mode, a Banked copy of the link register, for example LR\_und and LR\_mon
  - for the PL2 mode, Hyp mode, the special register [ELR\\_hyp](#).
- A saved copy of the [CPSR](#), made on exception entry, for example SPSR\_irq and SPSR\_hyp.

In addition FIQ mode has Banked copies of the ARM core registers R8 to R12.

User mode and System mode share the same ARM core registers.

User mode, System mode, and Hyp mode share the same LR.

For more information about the application level view of the SP, LR, and PC, and the alternative descriptions of them as R13, R14 and R15, see *ARM core registers on page A2-45*.

### Pseudocode details of ARM core register operations

The following pseudocode gives access to the ARM core registers:

```
// The names of the Banked core registers.

enumeration RName {RName_0usr, RName_1usr, RName_2usr, RName_3usr, RName_4usr, RName_5usr,
                  RName_6usr, RName_7usr, RName_8usr, RName_8fiq, RName_9usr, RName_9fiq,
                  RName_10usr, RName_10fiq, RName_11usr, RName_11fiq, RName_12usr, RName_12fiq,
                  RName_SPusr, RName_SPfiq, RName_SPirq, RName_SPsvc,
                  RName_SPabt, RName_SPund, RName_SPmon, RName_SPhyp,
                  RName_LRusr, RName_LRfiq, RName_LRirq, RName_LRsvc,
```

```

        RName_LRabt, RName_LRund, RName_LRmon,
        RName_PC};
// The physical array of Banked core registers.
//
// _R[RName_PC] is defined to be the address of the current instruction. The
// offset of 4 or 8 bytes is applied to it by the register access functions.

array bits(32) _R[RName];

// RBankSelect()
// =====

RName RBankSelect(bits(5) mode, RName usr, RName fiq, RName irq,
                  RName svc, RName abt, RName und, RName mon, RName hyp)
if BadMode(mode) then
    UNPREDICTABLE;
else
    case mode of
        when '10000' result = usr; // User mode
        when '10001' result = fiq; // FIQ mode
        when '10010' result = irq; // IRQ mode
        when '10011' result = svc; // Supervisor mode
        when '10110' result = mon; // Monitor mode
        when '10111' result = abt; // Abort mode
        when '11010' result = hyp; // Hyp mode
        when '11011' result = und; // Undefined mode
        when '11111' result = usr; // System mode uses User mode registers
    return result;

// RfiqBankSelect()
// =====

RName RfiqBankSelect(bits(5) mode, RName usr, RName fiq)
    return RBankSelect(mode, usr, fiq, usr, usr, usr, usr, usr, usr);

// LookUpRName()
// =====

RName LookUpRName(integer n, bits(5) mode)
    assert n >= 0 && n <= 14;
    case n of
        when 0 result = RName_0usr;
        when 1 result = RName_1usr;
        when 2 result = RName_2usr;
        when 3 result = RName_3usr;
        when 4 result = RName_4usr;
        when 5 result = RName_5usr;
        when 6 result = RName_6usr;
        when 7 result = RName_7usr;
        when 8 result = RfiqBankSelect(mode, RName_8usr, RName_8fiq);
        when 9 result = RfiqBankSelect(mode, RName_9usr, RName_9fiq);
        when 10 result = RfiqBankSelect(mode, RName_10usr, RName_10fiq);
        when 11 result = RfiqBankSelect(mode, RName_11usr, RName_11fiq);
        when 12 result = RfiqBankSelect(mode, RName_12usr, RName_12fiq);
        when 13 result = RBankSelect(mode, RName_SPusr, RName_SPfiq, RName_SPirq,
                                   RName_SPsvc, RName_SPabt, RName_SPund, RName_SPmon, RName_SPhyp);
        when 14 result = RBankSelect(mode, RName_LRusr, RName_LRfiq, RName_LRirq,
                                   RName_LRsvc, RName_LRabt, RName_LRund, RName_LRmon, RName_LRusr);
    return result;

```

```
// Rmode[] - non-assignment form
// =====

bits(32) Rmode[integer n, bits(5) mode]
    assert n >= 0 && n <= 14;

    // In Non-secure state, check for attempted use of Monitor mode ('10110'), or of FIQ
    // mode ('10001') when the Security Extensions are reserving the FIQ registers. The
    // definition of UNPREDICTABLE does not permit this to be a security hole.
    if !IsSecure() && mode == '10110' then UNPREDICTABLE;
    if !IsSecure() && mode == '10001' && NSACR.RFR == '1' then UNPREDICTABLE;

    return _R[LookUpRName(n,mode)];

// Rmode[] - assignment form
// =====

Rmode[integer n, bits(5) mode] = bits(32) value
    assert n >= 0 && n <= 14;

    // In Non-secure state, check for attempted use of Monitor mode ('10110'), or of FIQ
    // mode ('10001') when the Security Extensions are reserving the FIQ registers. The
    // definition of UNPREDICTABLE does not permit this to be a security hole.
    if !IsSecure() && mode == '10110' then UNPREDICTABLE;
    if !IsSecure() && mode == '10001' && NSACR.RFR == '1' then UNPREDICTABLE;

    // Writes of non word-aligned values to SP are only permitted in ARM state.
    if n == 13 && value<1:0> != '00' && CurrentInstrSet() != InstrSet_ARM then UNPREDICTABLE;

    _R[LookUpRName(n,mode)] = value;
    return;

// R[] - non-assignment form
// =====

bits(32) R[integer n]
    assert n >= 0 && n <= 15;
    if n == 15 then
        offset = if CurrentInstrSet() == InstrSet_ARM then 8 else 4;
        result = _R[RName_PC] + offset;
    else
        result = Rmode[n, CPSR.M];
    return result;

// R[] - assignment form
// =====

R[integer n] = bits(32) value
    assert n >= 0 && n <= 14;
    Rmode[n, CPSR.M] = value;
    return;

// SP - non-assignment form
// =====
bits(32) SP
    return R[13];

// SP - assignment form
// =====
SP = bits(32) value
    R[13] = value;

// LR - non-assignment form
// =====
bits(32) LR
    return R[14];
```

```
// LR - assignment form
// =====
LR = bits(32) value
    R[14] = value;

// PC - non-assignment form
// =====
bits(32) PC
    return R[15];

// BranchTo()
// =====

BranchTo(bits(32) address)
    _R[RName_PC] = address;
    return;
```

### B1.3.3 Program Status Registers (PSRs)

The Application level programmers' model provides the Application Program Status Register, see *The Application Program Status Register (APSR) on page A2-49*. This is an application level alias for the *Current Program Status Register (CPSR)*. The system level view of the *CPSR* extends the register, adding system level information.

Every mode that an exception can be taken to has its own saved copy of the *CPSR*, the *Saved Program Status Register (SPSR)*, as shown in *Figure B1-2 on page B1-1144*. For example, the *SPSR* for Monitor mode is called *SPSR\_mon*.

#### The Current Program Status Register (CPSR)

The *Current Program Status Register (CPSR)* holds processor status and control information:

- the *APSR*, see *The Application Program Status Register (APSR) on page A2-49*
- the current instruction set state, see *Instruction set state register; ISETSTATE on page A2-50*
- the execution state bits for the Thumb If-Then instruction, see *IT block state register; ITSTATE on page A2-51*
- the current endianness, see *Endianness mapping register; ENDIANSTATE on page A2-53*
- the current processor mode
- interrupt and asynchronous abort disable bits.

The non-*APSR* bits of the *CPSR* have defined reset values. These are shown in the *TakeReset()* pseudocode function, see *Reset on page B1-1204*.

Writes to the *CPSR* have side-effects on various aspects of processor operation. All of these side-effects, except for those on memory accesses associated with fetching instructions, are synchronous to the *CPSR* write. This means they are guaranteed:

- not to be visible to earlier instructions in the execution stream
- to be visible to later instructions in the execution stream.

The privilege level and address space of memory accesses associated with fetching instructions depend on the current privilege level and security state. Writes to *CPSR.M* can change one of both of the privilege level and security state. The effect, on memory accesses associated with fetching instructions, of a change of privilege level or security state is:

- Synchronous to the change of privilege level or security state, if that change is caused by an exception entry or exception return.
- Guaranteed not to be visible to any memory access caused by fetching an earlier instruction in the execution stream.
- Guaranteed to be visible to any memory access caused by fetching any instruction after the next context synchronization operation in the execution stream.

———— **Note** ————

See [Context synchronization operation](#) for the definition of this term.

- Might or might not affect memory accesses caused by fetching instructions between the mode change instruction and the point where the mode change is guaranteed to be visible.

See [Exception return on page B1-1193](#) for the definition of exception return instructions.

### The Saved Program Status Registers (SPSRs)

The purpose of an SPSR is to record the pre-exception value of the **CPSR**. On taking an exception, the **CPSR** is copied to the SPSR of the mode to which the exception is taken. Saving this value means the exception handler can:

- on exception return, restore the **CPSR** to the value it had immediately before the exception was taken
- examine the value that the **CPSR** had when the exception was taken, for example to determine the instruction set state and privilege level in which the instruction that caused an Undefined Instruction exception was executed.

[Figure B1-2 on page B1-1144](#) shows the banking of the SPSRs.

The SPSRs are UNKNOWN on reset. Any operation in a Non-secure PL1 or PL0 mode makes SPSR\_hyp UNKNOWN.

### Format of the CPSR and SPSRs

The CPSR and SPSR bit assignments are:

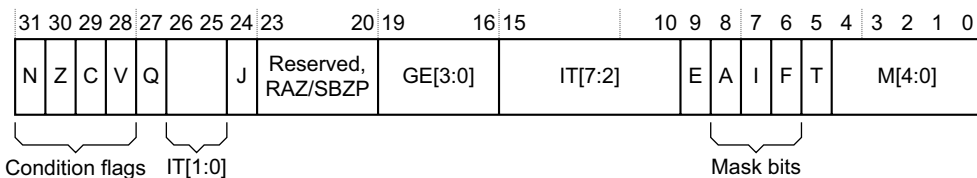

#### Condition flags, bits[31:28]

Set on the result of instruction execution. The flags are:

- N, bit[31]** Negative condition flag
- Z, bit[30]** Zero condition flag
- C, bit[29]** Carry condition flag
- V, bit[28]** Overflow condition flag.

The condition flags can be read or written in any mode, and are described in [The Application Program Status Register \(APSR\) on page A2-49](#).

**Q, bit[27]** Cumulative saturation bit. This bit can be read or written in any mode, and is described in [The Application Program Status Register \(APSR\) on page A2-49](#).

#### IT[7:0], bits[15:10, 26:25]

If-Then execution state bits for the Thumb IT (If-Then) instruction. [IT block state register, ITSTATE on page A2-51](#) describes the encoding of these bits. CPSR.IT[7:0] are the IT[7:0] bits described there. For more information, see [IT on page A8-390](#).

For details of how these bits can be accessed see [Accessing the execution state bits on page B1-1150](#).

**J, bit[24]** Jazelle bit, see the description of the T bit, bit[5].

**Bits[23:20]** Reserved. RAZ/SBZP.



### GE[3:0], bits[19:16]

Greater than or Equal flags, for the parallel addition and subtraction (SIMD) instructions described in [Parallel addition and subtraction instructions on page A4-171](#).

The GE[3:0] field can be read or written in any mode, and is described in [The Application Program Status Register \(APSR\) on page A2-49](#).

### E, bit[9]

Endianness execution state bit. Controls the load and store endianness for data accesses:

**0** Little-endian operation

**1** Big-endian operation.

Instruction fetches ignore this bit.

[Endianness mapping register, ENDIANSTATE on page A2-53](#) describes the encoding of this bit. CPSR.E is the ENDIANSTATE bit described there.

For details of how this bit can be accessed see [Accessing the execution state bits on page B1-1150](#).

When the reset value of the SCTLR.EE bit is defined by a configuration input signal, that value also applies to the CPSR.E bit on reset, and therefore applies to software execution from reset.

### Mask bits, bits[8:6]

These bits are:

**A, bit[8]** Asynchronous abort mask bit.

**I, bit[7]** IRQ mask bit.

**F, bit[6]** FIQ mask bit.

The possible values of each bit are:

**0** Exception not masked.

**1** Exception masked.

The A bit has no effect on any Data Abort exception generated by a Watchpoint debug event, even if that exception is asynchronous. For more information see [Debug exception on Watchpoint debug event on page C4-2089](#).

In an implementation that does not include the Security Extensions, setting a mask bit masks the corresponding exception, meaning it cannot be taken. However, the Security Extensions and Virtualization Extensions significantly alter the behavior and effect of these bits, see [Effects of the Security Extensions on the CPSR A and F bits on page B1-1151](#) and [Asynchronous exception masking on page B1-1183](#).

The mask bits can be written only at PL1 or higher. Their values can be read in any mode, but ARM deprecates any use of their values, or attempt to change them, by software executing at PL0.

Updates to the F bit are restricted if *Non-maskable FIQs* (NMFIs) are supported, see [Non-maskable FIQs on page B1-1151](#).

### T, bit[5]

Thumb execution state bit. This bit and the J execution state bit, bit[24], determine the instruction set state of the processor, ARM, Thumb, Jazelle, or ThumbEE. [Instruction set state register, ISETSTATE on page A2-50](#) describes the encoding of these bits. CPSR.J and CPSR.T are the same bits as ISETSTATE.J and ISETSTATE.T respectively. For more information, see [Instruction set states on page B1-1155](#).

For details of how these bits can be accessed see [Accessing the execution state bits on page B1-1150](#).

### M[4:0], bits[4:0]

Mode field. This field determines the current mode of the processor. The permitted values of this field are listed in [Table B1-1 on page B1-1139](#). All other values of M[4:0] are reserved. The effect of setting M[4:0] to a reserved value is UNPREDICTABLE.

#### Note

See the entry for *UNPREDICTABLE* in the Glossary for the restrictions on UNPREDICTABLE behavior. These restrictions mean that, for any CPSR.M value that is defined as UNPREDICTABLE in Non-secure state, the UNPREDICTABLE behavior must not cause entry to Secure state, or to any mode that the current configuration settings mean is not accessible in Non-secure state.

For more information about the processor modes see [ARM processor modes on page B1-1139](#). [Figure B1-2 on page B1-1144](#) shows the registers that can be accessed in each mode.

This field can be written only at PL1 or higher. Its value can be read in any mode, but ARM deprecates software executing at PL0 making any use of its value, or attempting to change it.

In an implementation that includes the Security Extensions, except as a result of an exception entry or exception return:

- Attempting to change CPSR.M to enter Monitor mode from Non-secure state is UNPREDICTABLE.
- When NSACR.RFR is set to 1, attempting to change CPSR.M to enter FIQ mode from Non-secure state is UNPREDICTABLE.  
From the introduction of the Virtualization Extensions, ARM deprecates any use of NSACR.RFR.

In an implementation that includes the Virtualization Extensions, except as a result of an exception entry or exception return:

- attempting to change CPSR.M to enter Hyp mode from any mode other than Hyp mode is UNPREDICTABLE
- attempting to change CPSR.M to enter any mode other than Hyp mode from Hyp mode is UNPREDICTABLE.

See [Exception return on page B1-1193](#) for more information about constraints on the CPSR.M value on an exception return.

### Accessing the execution state bits

The execution state bits are the IT[7:0], J, E, and T bits. If the current mode has an SPSR, software can read or write these bits in the SPSR.

In the CPSR, unless the processor is in Debug state:

- The execution state bits, other than the E bit, are RAZ when read by an MRS instruction.
- Writes to the execution state bits, other than the E bit, by an MSR instruction are:
  - For ARMv7 and ARMv6T2, ignored in all modes.
  - For architecture variants before ARMv6T2, ignored in User mode and required to write zeros in other modes. If a nonzero value is written at PL1, behavior is UNPREDICTABLE.

Instructions other than MRS and MSR that access the execution state bits can read and write them in any mode.

Unlike the other execution state bits in the CPSR, CPSR.E can be read by an MRS instruction and written by an MSR instruction. However, ARM deprecates:

- using the CPSR.E value read by an MRS instruction
- using an MSR instruction to change the value of CPSR.E.

---

**Note**

- Software can use the SETEND instruction to change the current endianness.
  - To determine the current endianness, software can use an LDR instruction to load a word of memory with a known value that differs if the endianness is reversed. For example, using an LDR (literal) instruction to load a word whose four bytes are 0x01, 0x00, 0x00, and 0x00 in ascending order of memory address loads the destination register with:
    - 0x00000001 if the current endianness is little-endian
    - 0x01000000 if the current endianness is big-endian.
- 

For more information about the behavior of these bits in Debug state see [Behavior of MRS and MSR instructions that access the CPSR in Debug state on page C5-2097](#).

### Non-maskable FIQs

Some ARMv7 implementations can be configured so that the CPSR.F bit cannot be set to 1 by an MSR or CPS instruction. This is defined as *Non-maskable FIQ* (NMFI) operation. In such an implementation, this configuration is controlled by a configuration input signal, that is asserted HIGH to enable NMFI operation.

---

**Note**

There is no software control of NMFI operation.

---

The Virtualization Extensions do not support NMFI. Otherwise, it is IMPLEMENTATION DEFINED whether an ARMv7 processor supports NMFI. In all cases, software can detect whether FIQs are maskable by reading the SCTL.NMFI bit:

**NMFI == 0** Software can mask FIQs by setting the CPSR.F bit to 1.

**NMFI == 1** Software cannot set the CPSR.F bit to 1. This means software cannot mask FIQs.

For more information see either:

- [SCTL, System Control Register; VMSA on page B4-1705](#)
- [SCTL, System Control Register; PMSA on page B6-1930](#).

When the SCTL.NMFI bit is 1:

- an instruction writing 0 to the CPSR.F bit clears it to 0, but an instruction attempting to write 1 to it leaves it unchanged.
- CPSR.F can be set to 1 only by exception entries, as described in [CPSR.{A, I, F, M} values on exception entry on page B1-1182](#).

In an implementation that includes the Security Extensions, this restriction on accessing CPSR.F interacts with the SCR.FW control, as described in [Effects of the Security Extensions on the CPSR A and F bits](#).

### Effects of the Security Extensions on the CPSR A and F bits

In an implementation that includes the Security Extensions:

- If the implementation does not include the Virtualization Extensions, when the processor is in Non-secure state:
  - the CPSR.F bit cannot be changed if the SCR.FW bit is set to 0
  - the CPSR.A bit cannot be changed if the SCR.AW bit is set to 0.
- If the implementation includes the Virtualization Extensions, clearing the SCR.FW and SCR.AW bits to 0 does not affect the ability to change the CPSR.F and CPSR.A bits, but does prevent those bit from masking exceptions in some situations.

For more information see [Asynchronous exception masking on page B1-1183](#).

**Note**

For an implementation that includes the Security Extensions but not the Virtualization Extensions, when the processor is in the Non-secure state, software executing at PL1 can change the `SPSR.F` and `SPSR.A` bits even if the corresponding bits in the `SCR` are set to 0. However, when the `SPSR` is copied to the `CPSR` the `CPSR.F` and `CPSR.A` bits are not updated if the corresponding bits in the `SCR` are set to 0.

For an implementation that includes the Security Extensions but not the Virtualization Extensions, [Table B1-2](#) shows how, in Non-secure state, `SCR.FW` interacts with `SCTLR.NMFI` to control possible updates to `CPSR.F` bit. The table includes the `SCTLR.NMFI` controls in Secure state.

**Table B1-2 NMFI behavior, Security Extensions implemented without the Virtualization Extensions**

Security state	SCR.FW bit	SCTLR.NMFI bit	CPSR.F bit properties	
Secure	x	0	F bit can be written to 0 or 1	
		1	F bit can be written to 0 but not to 1	
Non-secure	0	x	F bit cannot be written	
		1	0	F bit can be written to 0 or 1
			1	F bit can be written to 0 but not to 1

**Note**

The `SCTLR.NMFI` bit is common to the Secure and Non-secure versions of the `SCTLR`, because it is a read-only bit that reflects the value of a configuration input signal.

The Virtualization Extensions do not support NMFI. In an implementation that includes the Virtualization Extensions, `SCTLR.NMFI` is RAZ.

**Pseudocode details of PSR operations**

The following pseudocode gives access to the PSRs:

```
bits(32) CPSR, SPSR_fiq, SPSR_irq, SPSR_svc, SPSR_mon, SPSR_abt, SPSR_und, SPSR_hyp;
// SPSR[] - non-assignment form
// =====

bits(32) SPSR[]
    if BadMode(CPSR.M) then
        UNPREDICTABLE;
    else
        case CPSR.M of
            when '10001' result = SPSR_fiq; // FIQ mode
            when '10010' result = SPSR_irq; // IRQ mode
            when '10011' result = SPSR_svc; // Supervisor mode
            when '10110' result = SPSR_mon; // Monitor mode
            when '10111' result = SPSR_abt; // Abort mode
            when '11010' result = SPSR_hyp; // Hyp mode
            when '11011' result = SPSR_und; // Undefined mode
            otherwise UNPREDICTABLE;
        return result;

// SPSR[] - assignment form
// =====

SPSR[] = bits(32) value
    if BadMode(CPSR.M) then
        UNPREDICTABLE;
```

```

else
  case CPSR.M of
    when '10001' SPSR_fiq = value; // FIQ mode
    when '10010' SPSR_irq = value; // IRQ mode
    when '10011' SPSR_svc = value; // Supervisor mode
    when '10110' SPSR_mon = value; // Monitor mode
    when '10111' SPSR_abt = value; // Abort mode
    when '11010' SPSR_hyp = value; // Hyp mode
    when '11011' SPSR_und = value; // Undefined mode
    otherwise UNPREDICTABLE;
  return;

// CPSRWriteByInstr()
// =====

CPSRWriteByInstr(bits(32) value, bits(4) bytemask, boolean is_excpt_return)
  privileged = CurrentModeIsNotUser();
  nmfi = (SCTLR.NMFI == '1');

  if bytemask<3> == '1' then
    CPSR<31:27> = value<31:27>; // N,Z,C,V,Q flags
    if is_excpt_return then
      CPSR<26:24> = value<26:24>; // IT<1:0>,J execution state bits

  if bytemask<2> == '1' then
    // bits <23:20> are reserved SBZP bits
    CPSR<19:16> = value<19:16>; // GE<3:0> flags

  if bytemask<1> == '1' then
    if is_excpt_return then
      CPSR<15:10> = value<15:10>; // IT<7:2> execution state bits
    CPSR<9> = value<9>; // E bit is user-writable
    if privileged && (IsSecure() || SCR.AW == '1' || HaveVirtExt()) then
      CPSR<8> = value<8>; // A interrupt mask

  if bytemask<0> == '1' then
    if privileged then
      CPSR<7> = value<7>; // I interrupt mask
    if privileged && (!nmfi || value<6> == '0') &&
      (IsSecure() || SCR.FW == '1' || HaveVirtExt()) then
      CPSR<6> = value<6>; // F interrupt mask
    if is_excpt_return then
      CPSR<5> = value<5>; // T execution state bit
    if privileged then
      if BadMode(value<4:0>) then
        UNPREDICTABLE;
      else
        // Check for attempts to enter modes only permitted in Secure state from
        // Non-secure state. These are Monitor mode ('10110'), and FIQ mode ('10001')
        // if the Security Extensions have reserved it. The definition of UNPREDICTABLE
        // does not permit the resulting behavior to be a security hole.
        if !IsSecure() && value<4:0> == '10110' then UNPREDICTABLE;
        if !IsSecure() && value<4:0> == '10001' && NSACR.RFR == '1' then UNPREDICTABLE;
        // There is no Hyp mode ('11010') in Secure state, so that is UNPREDICTABLE
        if SCR.NS == '0' && value<4:0> == '11010' then UNPREDICTABLE;
        // Cannot move into Hyp mode directly from a Non-secure PL1 mode
        if !IsSecure() && CPSR.M != '11010' && value<4:0> == '11010' then
          UNPREDICTABLE;
        // Cannot move out of Hyp mode with this function except on an exception return
        if CPSR.M == '11010' && value<4:0> != '11010' && !is_excpt_return then
          UNPREDICTABLE;

    CPSR.M = value<4:0>; // CPSR<4:0>, mode bits

  return;

```

```
// SPSRWriteByInstr()
// =====

SPSRWriteByInstr(bits(32) value, bits(4) bytemask)

    if CurrentModeIsUserOrSystem() then UNPREDICTABLE;

    if bytemask<3> == '1' then
        SPSR[]<31:24> = value<31:24>; // N,Z,C,V,Q flags, IT<1:0>,J execution state bits

    if bytemask<2> == '1' then
        // bits <23:20> are reserved SBZP bits
        SPSR[]<19:16> = value<19:16>; // GE<3:0> flags

    if bytemask<1> == '1' then
        SPSR[]<15:8> = value<15:8>; // IT<7:2> execution state bits, E bit, A interrupt mask

    if bytemask<0> == '1' then
        SPSR[]<7:5> = value<7:5>; // I,F interrupt masks, T execution state bit
        if BadMode(value<4:0>) then // Mode bits
            UNPREDICTABLE;
        else
            SPSR[]<4:0> = value<4:0>;

    return;
```

#### B1.3.4 ELR\_hyp

Hyp mode does not provide its own Banked copy of LR. Instead, on taking an exception to Hyp mode, the preferred return address is stored in ELR\_hyp, a 32-bit Special register implemented for this purpose.

ELR\_hyp is implemented only as part of the Virtualization Extensions.

ELR\_hyp can be accessed explicitly only by executing:

- an MRS or MSR instruction that targets ELR\_hyp, see:
  - [MRS \(Banked register\) on page B9-1990](#)
  - [MSR \(Banked register\) on page B9-1992](#).

The ERET instruction uses the value in ELR\_hyp as the return address for the exception. For more information, see [ERET on page B9-1980](#).

Software execution in any Non-secure PL1 or PL0 mode makes ELR\_hyp UNKNOWN.

For more information about the use of ELR\_hyp see [Exceptions on page B1-1136](#).

## B1.4 Instruction set states

The instruction set states are described in [Chapter A2 Application Level Programmers' Model](#) and application level operations on them are described there. This section supplies more information about how they interact with system level functionality, in the sections:

- [Exceptions and instruction set state.](#)
- [Unimplemented instruction sets.](#)

### B1.4.1 Exceptions and instruction set state

If an exception is taken to a PL1 mode, the [SCTLR.TE](#) bit for the security state the exception is taken to determines the processor instruction set state that handles the exception, and if necessary, the processor changes to this instruction set state on exception entry.

If the exception is taken to Hyp mode, the [HSCTLR.TE](#) bit determines the processor instruction set state that handles the exception, and if necessary, the processor changes to this instruction set state on exception entry.

On coming out of reset, the processor starts execution in Supervisor mode, in the instruction set state determined by the reset value of [SCTLR.TE](#).

For more information see:

- for a VMSA implementation:
  - [SCTLR, System Control Register, VMSA on page B4-1705](#)
  - [HSCTLR, Hyp System Control Register, Virtualization Extensions on page B4-1590](#)
- for a PMSA implementation, [SCTLR, System Control Register, PMSA on page B6-1930](#).

For more information about exception entry see [Overview of exception entry on page B1-1170](#).

### B1.4.2 Unimplemented instruction sets

The [CPSR.J](#) and [CPSR.T](#) bits define the current instruction set state, see [Instruction set state register, ISETSTATE on page A2-50](#).

In the ARMv7 architecture:

- The Jazelle state:
  - Before the introduction of the Virtualization Extensions, is optional. ARM does not recommend support for Jazelle state in any ARMv7 implementation.
  - Is obsoleted by the introduction of the Virtualization Extensions. An ARMv7-A implementation that includes the Virtualization Extensions cannot support Jazelle state.
- The ThumbEE state is optional in the ARMv7-R architecture. ARM does not recommend support for ThumbEE state in any ARMv7-R implementation.

Some system instructions permit setting [CPSR.{J, T}](#) to values that select an unimplemented instruction set state, for example setting [CPSR.J](#) to 1 and [CPSR.T](#) to 0 on a processor that does not implement the Jazelle state. If such values are written to [CPSR.{J, T}](#), the implementation behaves in one of these ways:

- Sets [CPSR.{J, T}](#) to the requested values and causes the next instruction to generate an Undefined Instruction exception, as described in [Exception return to an unimplemented instruction set state on page B1-1196](#).
- Does not set [CPSR.{J, T}](#) to the requested values. The processor might change the value of one or both of the bits in such a way that the new values correspond to an implemented instruction set state. If this is done then the instruction set state changes to this new state. The detailed behavior of the attempt to change to an unimplemented state is IMPLEMENTATION DEFINED.

## B1.5 The Security Extensions

The Security Extensions are an OPTIONAL extension to the ARMv7-A architecture profile. When implemented, the Security Extensions integrate hardware security features into the architecture, to facilitate the development of secure applications. Many features of the architecture are extended to integrate with the Security Extensions, and because of this integration of the Security Extensions into the architecture, features of the Security Extensions are described in many sections of this manual.

———— **Note** —————

The Security Extensions are also permitted as an extension to the ARMv6K architecture. The resulting combination is sometimes called the ARMv6Z or ARMv6KZ architecture.

The following sections give general information about the Security Extensions:

- [Security states](#)
- [Impact of the Security Extensions on the modes and exception model](#) on page B1-1157
- [Security Extensions features added by the Virtualization Extensions](#) on page B1-1158
- [Classification of system control registers](#) on page B3-1451.

### B1.5.1 Security states

The Security Extensions define two security states, Secure state and Non-secure state. All instruction execution takes place either in Secure state or in Non-secure state:

- Each security state operates in its own virtual memory address space, with its own *translation regime*.

———— **Note** —————

[Figure B3-1 on page B3-1309](#) shows the different translation regimes.

- Many system controls can be set independently in each of the security states.
- All of the processor modes that are available in a system that does not implement the Security Extensions are available in each of the security states. However:
  - in any implementation that includes the Security Extensions, Monitor mode is available only in Secure state
  - in an implementation that also includes the Virtualization Extensions, Hyp mode is available only in Non-secure state.

The Security Extensions also define an additional processor mode, Monitor mode, that provides a bridge between software running in Non-secure state and software running in Secure state, see [Changing from Secure to Non-secure state](#) on page B1-1157.

The following features mean the two security states can provide more security than is typically provided by systems using the split between the different levels of execution privilege:

- the memory system provides mechanisms that prevent the Non-secure state accessing regions of the physical memory designated as Secure
- system controls that apply to the Secure state are not accessible from the Non-secure state
- entry to the Secure state from the Non-secure state is provided only by a small number of exceptions
- exit from the Secure state to the Non-secure state is provided only by a small number of mechanisms
- many operating system and hypervisor exceptions can be handled without changing security state.



The fundamental mechanism that determines the security state is the `SCR.NS` bit:

- For all modes other than Monitor mode and Hyp mode, the `SCR.NS` bit determines the security state for software execution.
- In an implementation that includes the Virtualization Extensions, Hyp mode is available only in Non-secure state, meaning it is available only when the `SCR.NS` bit is set to 1.
- Software executing in Monitor mode executes in the Secure state regardless of the value of the `SCR.NS` bit.

The ARM core registers and the processor status registers are not Banked between the Secure and the Non-secure states. ARM expects that, when switching execution between the Non-secure and Secure states, a kernel running mostly in Monitor mode will switch the values of these registers.

The registers `LR_mon` and `SPSR_mon` are UNKNOWN when executing in Non-secure state.

Many of the system registers referred to in *Coprocessors and system control* on page B1-1225 are Banked between the Secure and Non-secure security states. A Banked copy of a register applies only to execution in the appropriate security state. A small number of system registers are not Banked but apply to both the Secure and Non-secure security states. The registers that are not Banked relate to global system configuration options that ARM expects to be common to the two security states.

## Changing from Secure to Non-secure state

Monitor mode is provided to support switching between Secure and Non-secure states. Except in Monitor mode and Hyp mode, the security state is controlled by the `SCR.NS` bit. Software executing in a Secure PL1 mode can change the `SCR`, but ARM strongly recommends that software obeys the following rules for changing `SCR.NS`:

- To avoid security holes, software must not:
  - Change from Secure to Non-secure state by using an MSR or CPS instruction to switch from Monitor mode to some other mode while `SCR.NS` is 1.
  - Use an MCR instruction that writes `SCR.NS` to change from Secure to Non-secure state. This means ARM recommends that software does not alter `SCR.NS` in any mode except Monitor mode. ARM deprecates changing `SCR.NS` in any other mode.
- The usual mechanism for changing from Secure to Non-secure state is an exception return. To return to Non-secure state, software executing in Monitor mode sets `SCR.NS` to 1 and then performs the exception return.

## Pseudocode details of Secure state operations

The `HaveSecurityExt()` function returns TRUE if the implementation includes the Security Extensions, and FALSE otherwise.

The `IsSecure()` function returns TRUE if the processor is in Secure state, or if the implementation does not include the Security Extensions, and FALSE otherwise.

```
// IsSecure()
// =====

boolean IsSecure()
    return !HaveSecurityExt() || SCR.NS == '0' || CPSR.M == '10110'; // Monitor mode
```

## B1.5.2 Impact of the Security Extensions on the modes and exception model

This section gives an overview of the effect of the Security Extensions on the modes and exception model:

- Monitor mode is implemented only as part of the Security Extensions. For more information, see *ARM processor modes* on page B1-1139 and *Security states* on page B1-1156.
- The *Secure Monitor Call* (SMC) exception is implemented only as part of the Security Extensions. The SMC instruction generates this exception. For more information, see *Secure Monitor Call (SMC) exception* on page B1-1210 and *SMC (previously SMI)* on page B9-2000.

- For exceptions taken to any PL1 mode, because the **SCTLR** is Banked between the Secure and Non-secure states, the V and VE bits are defined independently for the Secure and Non-secure states. For each state:
  - the **SCTLR.V** bit controls whether the low or the high exception vectors are used
  - for the IRQ and FIQ exceptions, the **SCTLR.VE** bit controls whether the IRQ and FIQ vectors are IMPLEMENTATION DEFINED.For more information, see [Exception vectors and the exception base address on page B1-1164](#).
- For exceptions taken to any PL1 mode, the base address for the low exception vectors is held in a register that is Banked between the two security states, meaning this base address is defined independently for each security state.  
Another register holds the base address for exceptions taken to Monitor mode.  
For more information, see [Exception vectors and the exception base address on page B1-1164](#).
- Setting bits in the **SCR** to 1 causes one or more of external aborts, IRQs and FIQs to be taken to Monitor mode and to use the Monitor exception base address, see [Asynchronous exception routing controls on page B1-1174](#).
- When an exception is taken from Monitor mode in Non-debug state, **SCR.NS** is set to zero, to ensure that the exception is taken to Secure state. However, if an exception is taken from Monitor mode in Debug state, the exception entry does not change the value of **SCR.NS**.  
  
———— **Note** —————  
Many uses of the Security Extensions can be simplified if the system is designed so that exceptions cannot be taken from Monitor mode.  
—————
- Clearing bits in the **SCR** to 0 prevents software executing in Non-secure state from being able to mask one or both of asynchronous aborts and FIQs. The mechanism to do this depends on whether the implementation includes the Virtualization Extensions, see [Asynchronous exception masking on page B1-1183](#). With either mechanism:
  - clearing the **SCR.AW** bit to 0 prevents Non-secure masking of asynchronous aborts that are taken to Monitor mode
  - clearing the **SCR.FW** bit to 0 prevents Non-secure masking of FIQs that are taken to Monitor mode.

### B1.5.3 Security Extensions features added by the Virtualization Extensions

In an implementation that includes the Virtualization Extensions, the following features are added to the Security Extensions:

- When the **SCR.SIF** bit is set to 1, any instruction fetched from Non-secure physical memory cannot be executed in Secure state. For more information, see [Restriction on Secure instruction fetch on page B3-1361](#).
- **SCTLR** and **HSCTLR** include WXN bits that, when set to 1, prevent instruction execution from writable memory regions.  
Similarly, setting **SCTLR.UWXN** to 1 prevents instruction execution from any memory region that unprivileged software can write to.  
For more information see [Preventing execution from writable locations on page B3-1361](#).
- When the **SCR.SCD** bit is set to 1, entry to Secure state by taking a Secure Monitor Call exception is disabled. This means that, when **SCR.SCD** is set to 1:
  - an SMC instruction executed in Non-secure state, and not trapped by the **HCR.TSC** mechanism described in [Trapping use of the SMC instruction on page B1-1254](#), is UNDEFINED
  - an SMC instruction executed in a Secure PL1 mode is UNPREDICTABLE.For more information, see [SMC \(previously SMI\) on page B9-2000](#).

## B1.6 The Large Physical Address Extension

The Large Physical Address Extension is an OPTIONAL extension to the ARMv7-A architecture profile. Any implementation that includes the Large Physical Address Extension must also include the Multiprocessing Extensions.

The Large Physical Address Extension adds a new translation table format:

- the format used in an implementation that does not include the Large Physical Address Extension is now called the Short-descriptor format, see [Short-descriptor translation table format on page B3-1324](#)
- the format added by the Large Physical Address Extension is the Long-descriptor format, see [Long-descriptor translation table format on page B3-1338](#).

An implementation that includes the Large Physical Address Extension must support both translation table formats.

Other effects of the Large Physical Address Extension are described throughout this manual, and include:

- Changes to the permitted attributes for Device memory regions, see [Summary of ARMv7 memory attributes on page A3-126](#) and [Device and Strongly-ordered memory shareability, Large Physical Address Extension on page A3-137](#).

———— **Note** —————

The ordering requirements for Device accesses are identical to those for Strongly-ordered accesses, see [Ordering requirements for memory accesses on page A3-148](#).

- The addition of a requirement that LDRD and STRD accesses to 64-bit aligned locations are 64-bit single-copy atomic as seen by translation table walks and accesses to translation tables, see [Single-copy atomicity on page A3-127](#).
- Requiring the Short-descriptor translation table format to include the *Privileged execute-never* (PXN) attribute, see [Memory attributes in the Short-descriptor translation table format descriptors on page B3-1328](#).

———— **Note** —————

— In an implementation that does not include the Large Physical Address Extension, the inclusion of the PXN attribute in the Short-descriptor translation table format is OPTIONAL.

— The Long-descriptor translation table format always includes the PXN attribute.

- An implementation that includes the Large Physical Address Extension must implement the Multiprocessing Extensions and therefore cannot include the FCSE, see [Use of the Fast Context Switch Extension on page AppxI-2475](#).
- The Large Physical Address Extension:
  - Extends the [DBGDRAR](#) and [DBGDSAR](#) to 64 bits, to hold PAs of up to 40 bits.
  - Defines new formats for the [DFSR](#), [IFSR](#), and [TTBCR](#), for use with the Long-descriptor translation table format.
  - Adds bits to the [DFSR](#) and [IFSR](#) formats used with the Long-descriptor translation table format. [DFSR.CM](#) indicates when a fault is caused by a cache maintenance or address translation operation. [DFSR.LPAE](#) and [IFSR.LPAE](#) indicate the translation table format in use when the fault was generated.
  - Extends the [PAR](#) to 64 bits, to hold PAs of up to 40 bits.
  - Extends [TTBR0](#) and [TTBR1](#) to 64 bits, to support the Long-descriptor translation table format.
  - Defines two *Memory Attribute Indirection Registers*, [MAIR0](#) and [MAIR1](#), to replace [PRRR](#) and [NMRR](#) when using the Long-descriptor translation table format.
  - Provides two IMPLEMENTATION DEFINED Auxiliary Memory Attribute Indirection Registers 0 [AMAIR0](#) and [AMAIR1](#).

- The introduction of the Large Physical Address Extension changes:
  - some terminology used for MMU faults, see *VMSAv7 MMU fault terminology* on page B3-1398
  - the naming of the address translation operations, see *Naming of the address translation operations, and operation summary* on page B3-1438.

## B1.7 The Virtualization Extensions

The Virtualization Extensions are an OPTIONAL extension to the ARMv7-A architecture profile. Any implementation that includes the Virtualization Extensions must include the Security Extensions, the Large Physical Address Extension, and the Multiprocessing Extensions.

When implemented, the Virtualization Extensions provide a set of hardware features that support virtualizing the Non-secure state of an ARM VMSAv7 implementation. The basic model of a virtualized system involves:

- a hypervisor, running in Non-secure Hyp mode, that is responsible for switching Guest operating systems
- a number of Guest operating systems, each of which runs in the Non-secure PL1 and PL0 modes
- for each Guest operating system, applications, that usually run in User mode.

———— **Note** ————

A Guest OS runs on a *virtual machine*. However, its own view is that it is running on an ARM processor. Normally, a Guest OS is completely unaware:

- that it is running on a virtual machine
- of any other Guest OS.

Another way of describing virtualization is that:

- a Guest operating system, including all applications and tasks running under that operating system, runs on a virtual machine
- a hypervisor switches between virtual machines.

Each virtual machine is identified by a *virtual machine identifier* (VMID), assigned by the hypervisor.

Many features of the architecture are extended to integrate with the Virtualization Extensions, and because of this integration of the Virtualization Extensions into the architecture, features of the Virtualization Extensions are described in many sections of this manual. The key features are:

- Hyp mode is implemented only in Non-secure state, to support Guest OS management. Hyp mode operates in its own Non-secure virtual address space, that is different from the Non-secure virtual address space accessed from Non-secure PL0 and PL1 modes.
- The Virtualization Extensions provide controls to:
  - Define virtual values for a small number of identification registers. A read of the identification register by a Guest OS or its applications returns the virtual value.
  - Trap various other operations, including accesses to many other registers, and memory management operations. A trapped operation generates an exception that is taken to Hyp mode.

These controls are configured by software executing in Hyp mode.

- With the Security Extensions, the Virtualization Extensions control the routing of interrupts and asynchronous Data Abort exceptions to the appropriate one of:
  - the current Guest OS
  - a Guest OS that is not currently running
  - the hypervisor
  - the Secure monitor.
- When an implementation includes the Virtualization Extensions, it provides independent *translation regimes* for memory accesses from:
  - Secure modes, the Secure PL1&0 translation regime
  - Non-secure Hyp mode, the Non-secure PL2 translation regime
  - Non-secure PL1 and PL0 modes, the Non-secure PL1&0 translation regime.

[Figure B3-1 on page B3-1309](#) shows these translation regimes.

- In the Non-secure PL1&0 translation regime, address translation occurs in two stages:
  - Stage 1 maps the *Virtual Address* (VA) to an *Intermediate Physical Address* (IPA). Typically, the Guest OS configures and controls this stage, and believes that the IPA is the *Physical Address* (PA)
  - Stage 2 maps the IPA to the PA. Typically, the hypervisor controls this stage, and a Guest OS is completely unaware of this translation.

For more information, see [About address translation on page B3-1311](#).

[Impact of the Virtualization Extensions on the modes and exception model](#) gives more information about many of these features.

### B1.7.1 Impact of the Virtualization Extensions on the modes and exception model

This section summarizes the effect of the Virtualization Extensions on the modes and exception model. An implementation that includes the Virtualization Extensions:

- Implements a new Non-secure mode, Hyp mode. [Hyp mode on page B1-1141](#) summarizes how Hyp mode differs from the other processor modes.
- Implements new exceptions, see:
  - [Hypervisor Call \(HVC\) exception on page B1-1211](#)
  - [Hyp Trap exception on page B1-1208](#)
  - [Virtual IRQ exception on page B1-1220](#)
  - [Virtual FIQ exception on page B1-1222](#)
  - [Virtual Abort exception on page B1-1217](#).

The Hypervisor Call and Hyp Trap exceptions are always taken to Hyp mode. The virtual exceptions are taken to Non-secure IRQ, FIQ, or Abort mode, see [The virtual exceptions on page B1-1163](#).

- Implements a new register that holds the exception vector base address for exceptions taken to Hyp mode, the [HVBAR](#).
- Provides controls that can be used to route IRQs, FIQs, and asynchronous aborts, to Hyp mode. This is possible only if Secure software has not routed the exception to Monitor mode, and applies only to exceptions taken from a Non-secure mode.

For more information see [Asynchronous exception routing controls on page B1-1174](#).

- Provides controls that can be used to route some synchronous exceptions, taken from Non-secure modes, to Hyp mode. For more information see [Routing general exceptions to Hyp mode on page B1-1191](#) and [Routing Debug exceptions to Hyp mode on page B1-1193](#).
- Provide mechanisms to trap processor functions to Hyp mode, using the Hyp Trap exception, see [Traps to the hypervisor on page B1-1247](#).

When an operation is trapped to Hyp mode, the hypervisor typically either:

- emulates the required operation, so the application running in the Guest OS is unaware of the trap to Hyp mode
  - returns an error to the Guest OS.
- Implements enhanced exception reporting for exceptions taken to Hyp mode, see [Reporting exceptions taken to the Non-secure PL2 mode on page B3-1420](#). These exceptions are reported using the [HSR](#), see [Use of the HSR on page B3-1424](#),
  - Implements a new exception return instruction, ERET, for return from Hyp mode. For more information see [Hyp mode on page B1-1141](#).

## The virtual exceptions

The Virtualization Extensions introduce three virtual exceptions:

- the Virtual IRQ exception, that corresponds to the physical IRQ exception
- the Virtual FIQ exception, that corresponds to the physical FIQ exception
- the Virtual Abort exception, that corresponds to a physical Data Abort or Prefetch Abort exception.

Software executing in Hyp mode can use these to signal exceptions to the other Non-secure modes. A Non-secure PL1 or PL0 mode cannot distinguish a virtual exception from the corresponding physical exception.

A usage model for these exceptions is that physical IRQs, FIQs and asynchronous aborts that occur when the processor is in a Non-secure PL1 or PL0 mode are routed to Hyp mode. The exception handler, executing in Hyp mode, determines whether the exception can be handled in Hyp mode or requires routing to a Guest OS. When an exception requires handling by a Guest OS it is marked as pending for that Guest OS. When the hypervisor switches to a particular Guest OS, it uses the appropriate virtual exception to signal any pending virtual exception to that Guest OS.

For more information see [Virtual exceptions in the Virtualization Extensions](#) on page B1-1196.

## B1.8 Exception handling

An exception causes the processor to suspend program execution to handle an event, such as an externally generated interrupt or an attempt to execute an undefined instruction. Exceptions can be generated by internal and external sources.

Normally, when an exception is taken the processor state is preserved immediately, before handling the exception. This means that, when the event has been handled, the original state can be restored and program execution resumed from the point where the exception was taken.

More than one exception might be generated at the same time, and a new exception can be generated while the processor is handling an exception.

The following sections describe exception handling:

- [Exception vectors and the exception base address](#)
- [Exception priority order on page B1-1168](#)
- [Overview of exception entry on page B1-1170](#)
- [Processor mode for taking exceptions on page B1-1172](#)
- [Processor state on exception entry on page B1-1181](#)
- [Asynchronous exception masking on page B1-1183](#)
- [Summaries of asynchronous exception behavior on page B1-1185](#)
- [Routing general exceptions to Hyp mode on page B1-1191](#)
- [Routing Debug exceptions to Hyp mode on page B1-1193](#)
- [Exception return on page B1-1193](#)
- [Virtual exceptions in the Virtualization Extensions on page B1-1196](#)
- [Low interrupt latency configuration on page B1-1197](#)
- [Wait For Event and Send Event on page B1-1199](#)
- [Wait For Interrupt on page B1-1202](#)

[Exception descriptions on page B1-1204](#) then describes each exception.

### B1.8.1 Exception vectors and the exception base address

When an exception is taken, processor execution is forced to an address that corresponds to the type of exception. This address is called the *exception vector* for that exception.

A set of exception vectors comprises eight consecutive word-aligned memory addresses, starting at an *exception base address*. These eight vectors form a *vector table*. For the IRQ and FIQ exceptions only, when the exceptions are taken to IRQ mode and FIQ mode, software can change the exception vectors from the vector table values by setting the `SCTLR.VE` bit to 1, see [Vectored interrupt support on page B1-1167](#).

The number of possible exception base addresses, and therefore the number of vector tables, depends on the implemented architecture profile and extensions, as follows:

#### Implementation that does not include the Security Extensions

This section applied to all ARMv7-R implementations.

An implementation that does not include the Security Extensions has a single vector table, the base address of which is selected by `SCTLR.V`, see [SCTLR, System Control Register, VMSA on page B4-1705](#) or [SCTLR, System Control Register, PMSA on page B6-1930](#):

**V == 0** Exception base address = `0x00000000`. This setting is referred to as normal vectors, or as low vectors.

**V == 1** Exception base address = `0xFFFF0000`. This setting is referred to as high vectors, or *Hivecs*.

#### ———— Note —————

ARM deprecates using the *Hivecs* setting, `SCTLR.V == 1`, in ARMv7-R. ARM recommends that *Hivecs* is used only in ARMv7-A implementations.



### Implementation that includes the Security Extensions

Any implementation that includes the Security Extensions has the following vector tables:

- One for exceptions taken to Secure Monitor mode. This is the Monitor vector table, and is in the address space of the Secure PL1&0 translation regime.
- One for exceptions taken to Secure PL1 modes other than Monitor mode. This is the Secure vector table, and is in the address space of the Secure PL1&0 translation regime.
- One for exceptions taken to Non-secure PL1 modes. This is the Non-secure vector table, and is in the address space of the Non-secure PL1&0 translation regime.

For the Monitor vector table, [MVBAR](#) holds the Exception base address.

For the Secure vector table:

- the Secure [SCTLR.V](#) bit determines the Exception base address:
  - V == 0** The Secure [VBAR](#) holds the Exception base address.
  - V == 1** Exception base address = 0xFFFF0000, the Hivects setting.

For the Non-secure vector table:

- the Non-secure [SCTLR.V](#) bit determines the Exception base address:
  - V == 0** The Non-secure [VBAR](#) holds the Exception base address.
  - V == 1** Exception base address = 0xFFFF0000, the Hivects setting.

### Implementation that includes the Virtualization Extensions

An implementation that includes the Virtualization Extensions must include the Security Extensions, and also includes an additional vector table. Therefore, it has the following vector tables:

- One for exceptions taken to Secure Monitor mode. This is the Monitor vector table, and is in the address space of the Secure PL1&0 translation regime.
- One for exceptions taken to Secure PL1 modes other than Monitor mode. This is the Secure vector table, and is in the address space of the Secure PL1&0 translation regime.
- One for exceptions taken to Hyp mode, the Non-secure PL2 mode. This is the Hyp vector table, and is in the address space of the Non-secure PL2 translation regime.
- One for exceptions taken to Non-secure PL1 modes. This is the Non-secure vector table, and is in the address space of the Non-secure PL1&0 translation regime.

The Exception base addresses of the Monitor vector table, the Secure vector table, and the Non-secure vector table are determined in the same way as for an implementation that includes the Security extensions but not the Virtualization extensions.

For the Hyp vector table, [HVBAR](#) holds the Exception base address.

The following subsections give more information:

- [The vector tables and exception offsets](#)
- [Vectored interrupt support on page B1-1167](#)
- [Pseudocode determination of the exception base address on page B1-1167.](#)

### The vector tables and exception offsets

[Table B1-3 on page B1-1166](#) defines the vector table entries. In this table:

- The *Hyp mode* column defines the vector table entries for exceptions taken to Hyp mode.
- The *Monitor mode* column defines the vector table entries for exceptions taken to Monitor mode.
- The *Secure* and *Non-secure* columns define the Secure and Non-secure vector table entries, that are used for exceptions taken to PL1 modes other than Monitor mode. [Table B1-4 on page B1-1166](#) shows the mode to which each of these exceptions is taken. Each of these modes is described as the *default* mode for taking the corresponding exception.

For more information about determining the mode to which an exception is taken, see *Processor mode for taking exceptions* on page B1-1172.

The Virtualization Extensions provide a number of additional exceptions, some of which are not shown explicitly in the vector tables. For more information, see *Offsets of exceptions introduced by the Virtualization Extensions*.

**Table B1-3 The vector tables**

Offset	Vector tables			
	Hyp <sup>a</sup>	Monitor <sup>b</sup>	Secure	Non-secure
0x00	Not used	Not used	Reset	Not used
0x04	Undefined Instruction, from Hyp mode	Not used	Undefined Instruction	Undefined Instruction
0x08	Hypervisor Call, from Hyp mode	Secure Monitor Call	Supervisor Call	Supervisor Call
0x0C	Prefetch Abort, from Hyp mode	Prefetch Abort	Prefetch Abort	Prefetch Abort
0x10	Data Abort, from Hyp mode	Data Abort	Data Abort	Data Abort
0x14	Hyp Trap, or Hyp mode entry <sup>c</sup>	Not used	Not used	Not used
0x18	IRQ interrupt	IRQ interrupt	IRQ interrupt	IRQ interrupt
0x1C	FIQ interrupt	FIQ interrupt	FIQ interrupt	FIQ interrupt

- a. Non-secure state only. Implemented only if the implementation includes the Virtualization Extensions.
- b. Secure state only. Implemented only if the implementation includes the Security Extensions.
- c. See *Use of offset 0x14 in the Hyp vector table* on page B1-1167.

**Table B1-4 Modes for taking exceptions using the Secure or Non-secure vector table**

Exception	PL1 Mode taken to
Reset	Supervisor
Undefined Instruction	Undefined
Supervisor Call	Supervisor
Prefetch Abort	Abort
Data Abort	Abort
IRQ interrupt	IRQ
FIQ interrupt	FIQ

For more information about use of the vector tables see *Overview of exception entry* on page B1-1170.

**Offsets of exceptions introduced by the Virtualization Extensions**

The Virtualization Extensions introduce the following new exceptions. The processor enters the handlers for these exceptions using the following vector table entries shown in [Table B1-3](#):

**Hypervisor Call**

If taken from Hyp mode, shown explicitly in the Hyp mode vector table. Otherwise, see *Use of offset 0x14 in the Hyp vector table* on page B1-1167.

**Hyp Trap** Shown explicitly in the Hyp mode vector table.

**Virtual Abort** Entered through the Data Abort vector in the Non-secure vector table.

**Virtual IRQ** Entered through the IRQ vector in the Non-secure vector table.

**Virtual FIQ** Entered through the FIQ vector in the Non-secure vector table.

———— **Note** —————

*The virtual exceptions on page B1-1163 summarizes these exceptions, and [Virtual exceptions in the Virtualization Extensions on page B1-1196](#) gives more information.*

**Use of offset 0x14 in the Hyp vector table**

The vector at offset 0x14 in the Hyp vector table is used for exceptions that cause entry to Hyp mode. This means it is:

- Always used for the Hyp Trap exception.
- Used for the following exceptions, when the exception is not taken from Hyp mode:
  - Hypervisor Call
  - Supervisor Call, when caused by execution of an SVC instruction in Non-secure User mode when `HCR.TGE` is set to 1
  - Undefined Instruction
  - Prefetch Abort
  - Data Abort.

[Table B1-3 on page B1-1166](#) shows the offsets used for these exceptions when they are taken from Hyp mode.

- Never used for IRQ exceptions, Virtual IRQ exceptions, FIQ exceptions, or Virtual FIQ exceptions.

For more information, see [Processor mode for taking exceptions on page B1-1172](#).

**Pseudocode determination of the exception base address**

For an exception taken to a PL1 mode other than Monitor mode, the `ExcVectorBase()` function determines the exception base address:

```
// ExcVectorBase()
// =====

bits(32) ExcVectorBase()
  if SCTL.R.V == '1' then // Hivecs selected, base = 0xFFFF0000
    return Ones(16):Zeros(16);
  elsif HaveSecurityExt() then
    return VBAR;
  else
    return Zeros(32);
```

**Vectored interrupt support**

At reset, any implemented vectored interrupt mechanism is disabled, and the IRQ and FIQ exception vectors are at fixed offsets from the exception base address that is being used. With this configuration, an FIQ or IRQ handler typically starts with an instruction sequence that determines the cause of the interrupt and then branches to an appropriate routine to handle it.

If an implementation supports vectored interrupts, enabling this feature means an interrupt controller can prioritize interrupts and provide the address of the required interrupt handler directly to the processor, for use as the interrupt vector. For interrupts taken to PL1 modes other than Monitor mode, vectored interrupt behavior is enabled by setting the `SCTL.R.VE` bit to 1, see either:

- [SCTL.R, System Control Register; VMSA on page B4-1705](#)
- [SCTL.R, System Control Register; PMSA on page B6-1930](#).

The hardware that supports vectored interrupts is IMPLEMENTATION DEFINED, and an implementation might not include any support for this operation.

In an implementation that includes the Security Extensions:

- The **SCTLR.VE** bit is Banked between Secure and Non-secure states to provide independent control of whether vectored interrupt support is enabled.
- Interrupts can be routed to Monitor mode, by setting either or both of the **SCR.IRQ** and **SCR.FIQ** bits to 1. When an interrupt is routed to Monitor mode it uses the vector in the vector table at the Monitor exception base address held in **MVBAR**, regardless of the value of either Banked copy of the **SCTLR.VE** bit.

The Virtualization Extensions do not support this vectoring of the IRQ and FIQ exceptions when these exceptions are routed to Hyp mode. When an interrupt is routed to Hyp mode, it uses the vector in the vector table at the Hyp exception base address held in **HVBAR**, regardless of the value of either Banked copy of the **SCTLR.VE** bit.

From the introduction of the Virtualization Extensions, ARM deprecates any use of the **SCTLR.VE** bit.

## B1.8.2 Exception priority order

An instruction is not valid if it generates a synchronous Prefetch Abort exception. Therefore, if an instruction generates a Prefetch Abort exception, no other synchronous exception or debug event is generated on that instruction.

A Breakpoint debug event, or an address matching form of the Vector catch debug event, is associated with the instruction. This means the corresponding exception is taken before the instruction is executed. Therefore, when a Breakpoint or address matching Vector catch debug event occurs, no other synchronous exception or debug event, that might have occurred as a result of executing the instruction, can occur.

### ———— Note —————

- The Exception trapping form of the Vector catch debug event, introduced in v7.1 Debug, causes a debug event as a result of trapping an exception that has been prioritized as described in this section. This means it is outside the scope of the description in this section. For more information see [Vector catch debug events on page C3-2065](#).
- In v7 Debug, the only supported Vector catch debug events are address matching Vector catch debug events.

Otherwise:

- An instruction that generates an Undefined Instruction exception or a Hyp Trap exception cannot cause any memory access, and therefore cannot cause a Data Abort exception.
- If an instruction generates both an Undefined Instruction exception and a Hyp Trap exception then, unless this manual explicitly states otherwise, the Undefined Instruction exception has priority.
- If a system call is configured to generate an Undefined Instruction exception or a Hyp Trap exception, then the Undefined Instruction exception or the Hyp Trap exception has priority over the system call. The system calls are the SVC, HVC, and SMC instructions.
- A memory access that generates an MMU fault, an MPU fault, or a synchronous Watchpoint debug event must not generate an external abort.
- All other synchronous exceptions are mutually exclusive and are derived from a decode of the instruction.

For more information, see:

- [Debug event prioritization on page C3-2076](#) for information about the prioritization of debug events, including their prioritization relative to MMU faults, MPU faults, and synchronous external aborts
- [Prioritization of aborts on page B3-1407](#), for information about:
  - the prioritization of aborts on a single memory access in a VMSA implementation
  - the prioritization of exceptions generated during address translation

- [Prioritization of aborts on page B5-1766](#), for information about the prioritization of aborts on a single memory access in a PMSA implementation.

## Architectural requirements for taking asynchronous exceptions

The ARM architecture does not define when asynchronous exceptions are taken, but sets the following limits on when they are taken:

- An asynchronous exception that is pending before one of the following context synchronizing events is taken before the first instruction after the context synchronizing event completes its execution, provided that the pending asynchronous event is not masked after the context synchronizing event. The context synchronizing events are:
  - Execution of an ISB instruction.
  - Taking an exception.
  - Return from an exception.
  - Exit from Debug state.

The [ISR](#) identifies any pending asynchronous exceptions.

———— **Note** —————

If the first instruction after the context synchronizing event generates a synchronous exception, then the architecture does not define the order in which that synchronous exception and the asynchronous exception are taken.

- In the absence of an specific requirement to take an asynchronous exception, because of a context synchronizing event, the only requirement of the architecture is that an unmasked asynchronous exception is taken in finite time.

———— **Note** —————

The taking of an unmasked asynchronous exception in finite time must occur with all code sequences, including with a sequence that consists of unconditional loops.

Within these limits, the prioritization of asynchronous exceptions relative to other exceptions, both synchronous and asynchronous, is IMPLEMENTATION DEFINED.

———— **Note** —————

A special requirement applies to asynchronous watchpoints, see [Debug event prioritization on page C3-2076](#).

The [CPSR](#) includes a mask bit for each type of asynchronous exception. Setting one of these bits to 1 can prevent the corresponding asynchronous exception from being taken, see [Summaries of asynchronous exception behavior on page B1-1185](#).

Taking an exception sets an exception-dependent subset of these mask bits.

———— **Note** —————

The subset of the [CPSR](#) mask bits that is set on taking an exception can prioritize the execution of FIQ handlers over that of IRQ and asynchronous abort handlers.

### B1.8.3 Overview of exception entry

On taking an exception:

1. The hardware determines the mode to which the exception must be taken, see *Processor mode for taking exceptions* on page B1-1172.
2. A link value, indicating the *preferred return address* for the exception, is saved. This is a possible return address for the exception handler, and depends on:
  - the exception type
  - whether the exception is taken to a PL1 mode or a PL2 mode
  - for some exceptions taken to a PL1 mode, the instruction set state when the exception is taken.
 Where the link value is saved depends on whether the exception is taken to a PL1 mode or a PL2 mode. For more information see *Link values saved on exception entry* on page B1-1171.
3. The value of the **CPSR** is saved in the **SPSR** for the mode to which the exception must be taken. The value saved in **SPSR.IT[7:0]** is always correct for the preferred return address.
4. In an implementation that includes the Security Exceptions:
  - if the exception taken from Monitor mode, **SCR.NS** is cleared to 0
  - otherwise, taking the exception leaves **SCR.NS** unchanged.
5. The **CPSR** is updated with new context information for the exception handler. This includes:
  - Setting **CPSR.M** to the processor mode to which the exception is taken.
  - Setting the appropriate **CPSR** mask bits. This can disable the corresponding exceptions, preventing uncontrolled nesting of exception handlers.
  - Setting the instruction set state to the state required for exception entry.
  - Setting the endianness to the required value for exception entry.
  - Clearing the **CPSR.IT[7:0]** bits to 0.
 For more information, see *Processor state on exception entry* on page B1-1181.
6. The appropriate exception vector is loaded into the PC, see *Exception vectors and the exception base address* on page B1-1164.
7. Execution continues from the address held in the PC.

For an exception taken to a PL1 mode, on exception entry, the exception handler can use the SRS instruction to store the return state onto the stack of any mode at the same privilege level, and the CPS instruction to change mode. For more information about the instructions, see *SRS (Thumb)* on page B9-2002, *SRS (ARM)* on page B9-2004, *CPS (Thumb)* on page B9-1976, and *CPS (ARM)* on page B9-1978.

Later sections of this chapter describe each of the possible exceptions, and each of these descriptions includes a pseudocode description of the processor state changes when it takes that exception. Table B1-5 gives an index to these descriptions:

**Table B1-5 Pseudocode descriptions of exception entry**

Exception	Description of exception entry
Reset	<i>Pseudocode description of taking the Reset exception on page B1-1205</i>
Undefined Instruction	<i>Pseudocode description of taking the Undefined Instruction exception on page B1-1207</i>
Supervisor Call	<i>Pseudocode description of taking the Supervisor Call exception on page B1-1209</i>
Secure Monitor Call	<i>Pseudocode description of taking the Secure Monitor Call exception on page B1-1211</i>
Hypervisor Call	<i>Pseudocode description of taking the Hypervisor Call exception on page B1-1212</i>
Prefetch Abort	<i>Pseudocode description of taking the Prefetch Abort exception on page B1-1213</i>

**Table B1-5 Pseudocode descriptions of exception entry (continued)**

Exception	Description of exception entry
Data Abort	<i>Pseudocode description of taking the Data Abort exception on page B1-1215</i>
IRQ	<i>Pseudocode description of taking the IRQ exception on page B1-1219</i>
FIQ	<i>Pseudocode description of taking the FIQ exception on page B1-1221</i>
Hyp Trap	<i>Pseudocode description of taking the Hyp Trap exception on page B1-1209</i>
Virtual Abort	<i>Pseudocode description of taking the Virtual Abort exception on page B1-1217</i>
Virtual IRQ	<i>Pseudocode description of taking the Virtual IRQ exception on page B1-1220</i>
Virtual FIQ	<i>Pseudocode description of taking the Virtual FIQ exception on page B1-1223</i>

The following sections give more information about the processor state changes, for different architecture implementations. However, you must refer to the pseudocode for a full description of the state changes:

- *Processor mode for taking exceptions on page B1-1172*
- *Processor state on exception entry on page B1-1181.*

### Link values saved on exception entry

On exception entry, a link value for use on return from the exception, is saved. This link value is based on the preferred return address for the exception, as shown in [Table B1-6](#):

**Table B1-6 Exception return addresses**

Exception	Preferred return address	Taken to a mode at
Undefined Instruction	Address of the UNDEFINED instruction	PL1 <sup>a</sup> , or PL2 <sup>b</sup>
Supervisor Call	Address of the instruction after the SVC instruction	PL1 <sup>a</sup> or PL2 <sup>b</sup>
Secure Monitor Call	Address of the instruction after the SMC instruction	PL1, and only in Secure state
Hypervisor Call	Address of the instruction after the HVC instruction	PL2 only <sup>b</sup>
Prefetch Abort	Address of aborted instruction fetch	PL1 <sup>a</sup> or PL2 <sup>b</sup>
Data Abort	Address of instruction that generated the abort	PL1 <sup>a</sup> or PL2 <sup>b</sup>
Virtual Abort	Address of next instruction to execute	PL1, and only in Non-secure state
Hyp Trap	Address of the trapped instruction	PL2 only <sup>b</sup>
IRQ or FIQ	Address of next instruction to execute	PL1 <sup>a</sup> or PL2 <sup>b</sup>
Virtual IRQ or Virtual FIQ	Address of next instruction to execute	PL1, and only in Non-secure state

a. Secure or Non-secure.

b. PL2 is implemented only in Non-secure state. Therefore, an exception can be taken to PL2 mode only if it is taken from Non-secure state.

### ———— Note ————

- Although Reset is described as an exception, it differs significantly from other exceptions. The architecture has no concept of a return from a Reset and therefore it is not listed in this section.
- For each exception, the preferred return address is not affected by whether the exception is taken from a PL1 mode or from a PL0 mode.

However, the link value saved, and where it is saved, depend on whether the exception is taken to a PL1 mode, or to a PL2 mode, as follows:

**Exception taken to a PL1 mode**

The link value is saved in the LR for the mode to which the exception is taken.

The saved link value is the preferred return address for the exception, plus an offset that depends on the instruction set state when the exception was taken, as [Table B1-7](#) shows:

**Table B1-7 Offsets applied to Link value for exceptions taken to PL1 modes**

Exception	Offset, for processor state of:		
	ARM	Thumb <sup>a</sup>	Jazelle
Undefined Instruction	+4	+2	- <sup>b</sup>
Supervisor Call	None	None	- <sup>c</sup>
Secure Monitor Call	None	None	- <sup>c</sup>
Prefetch Abort	+4	+4	+4
Data Abort	+8	+8	+8
Virtual Abort	+8	+8	+8
IRQ or FIQ	+4	+4	+4
Virtual IRQ or Virtual FIQ	+4	+4	+4

- a. Thumb or ThumbEE state.
- b. See *Undefined Instruction exception in Jazelle state* on page B1-1207.
- c. Exception cannot occur in Jazelle state.

**Exception taken to a PL2 mode**

The link value is saved in the `ELR_hyp` Special register.

The saved link value is the preferred return address for the exception, as shown in [Table B1-6](#) on page B1-1171, with no offset.

**B1.8.4 Processor mode for taking exceptions**

The following principles determine the mode to which an exception is taken:

- An exception cannot be taken to a PL0 mode.
- An exception is taken either:
  - at the privilege level at which the processor was executing when it took the exception
  - at a higher privilege level.

This means that, in Secure state, an exception is always taken to a PL1 mode.

- Configuration options and other features provided by the Security Extensions and the Virtualization Extensions can determine the mode to which some exceptions are taken, as follows:

**In an implementation that does not include the Security Extensions**

An exception is always taken to the default mode for that exception.

**———— Note ————**

An implementation that includes the Virtualization Extensions must also include the Security Extensions.



### In an implementation that includes the Security Extensions

A Secure Monitor Call exception is always taken to Secure Monitor mode.

IRQ, FIQ, and External abort exceptions can be configured to be taken to Secure Monitor mode.

Any exception taken from Secure state that is not taken to Secure Monitor mode is taken to Secure state in the default mode for that exception.

If the implementation does not include the Virtualization Extensions, any exception taken from Non-secure state that is not taken to Secure Monitor mode is taken to Non-secure state in the default mode for that exception.

### In an implementation that includes the Virtualization Extensions

An exception taken from Non-secure state that is not taken to Secure Monitor mode is taken to Non-secure state and:

- if the exception is taken from Hyp mode then it is taken to Hyp mode
- otherwise, the exception is either taken to Hyp mode, as described in [Exceptions taken to Hyp mode](#), or taken to the default mode for the exception.

---

#### Note

---

The Virtualization Extensions have no effect on the handling of exceptions taken from Secure state.

---

Table B1-4 on page B1-1166 shows the default mode to which each exception is taken.

[Asynchronous exception routing controls](#) on page B1-1174 describes the exception routing controls provided by the Security Extensions and the Virtualization Extensions.

For a VMSA implementation, [Routing of aborts](#) on page B3-1396 gives more information about the modes to which memory aborts are taken.

[Summary of the possible modes for taking each exception](#) on page B1-1174 shows all modes to which each exception might be taken, in any implementation. That is, it applies to implementations:

- that include neither the Security Extensions, nor the Virtualization Extensions
- that include the Security Extensions, but not the Virtualization Extensions
- that include both the Security Extensions and the Virtualization Extensions.

## Exceptions taken to Hyp mode

In an implementation that includes the Virtualization Extensions:

- Any exception taken from Hyp mode, that is not routed to Secure Monitor Mode by the controls described in [Asynchronous exception routing controls](#) on page B1-1174, is taken to Hyp mode.
- The following exceptions, if taken from Non-secure state, are taken to Hyp mode:
  - An abort that [Routing of aborts](#) on page B3-1396 identifies as taken to Hyp mode.
  - A Hyp Trap exception, see [Traps to the hypervisor](#) on page B1-1247.
  - A Hypervisor Call exception. This is generated by executing a HVC instruction in a Non-secure mode.
  - An asynchronous abort, IRQ exception or FIQ exception that is not routed to Secure Monitor mode but is explicitly routed to Hyp mode, as described in [Asynchronous exception routing controls](#) on page B1-1174.
  - A synchronous external abort, Alignment fault, Undefined Instruction exception, or Supervisor Call exception taken from the Non-secure PL0 mode and explicitly routed to Hyp mode, as described in [Routing general exceptions to Hyp mode](#) on page B1-1191.

---

#### Note

---

A synchronous external abort can be routed to Hyp mode only if it not routed to Secure Monitor mode.

---

- A debug exception that is explicitly routed to Hyp mode as described in [Routing Debug exceptions to Hyp mode](#) on page B1-1193.

---

**Note**

The virtual exceptions cannot be taken to Hyp mode. They are always taken to a Non-secure PL1 mode.

---

### Asynchronous exception routing controls

In an implementation that includes the Security Extensions, the following bits in the **SCR** control the routing of asynchronous exceptions, and also the routing of synchronous external aborts:

**SCR.EA** When this bit is set to 1, any external abort is taken to Secure Monitor mode.

---

**Note**

- Unlike other controls described in this section, **SCR.EA** controls the routing of both synchronous and asynchronous external aborts.
  - The other classes of abort cannot be routed to Monitor mode. For more information about the classification of aborts, see *VMSA memory aborts* on page B3-1395 or *PMSA memory aborts* on page B5-1763.
- 

**SCR.FIQ** When this bit is set to 1, any FIQ exception is taken to Secure Monitor mode.

**SCR.IRQ** When this bit is set to 1, any IRQ exception is taken to Secure Monitor mode.

Only Secure software can change the values of these bits.

In an implementation that includes the Virtualization Extensions, the following bits in the **HCR** route asynchronous exceptions to Hyp mode, for exceptions that are both:

- taken from a Non-secure PL1 or PL0 mode
- not configured, by the **SCR**.{EA, FIQ, IRQ} controls, to be taken to Secure Monitor mode.

**HCR.AMO** If **SCR.EA** is set to 0, when this bit is set to 1, an asynchronous external abort taken from a Non-secure PL1 or PL0 mode is taken to Hyp mode, instead of to Non-secure Abort mode.

**HCR.FMO** If **SCR.FIQ** is set to 0, when this bit is set to 1, an FIQ exception taken from a Non-secure PL1 or PL0 mode is taken to Hyp mode, instead of to Non-secure FIQ mode.

**HCR.IMO** If **SCR.IRQ** is set to 0, when this bit is set to 1, an IRQ exceptions taken from a Non-secure PL1 or PL0 mode is taken to Hyp mode, instead of to Non-secure IRQ mode.

Only software executing in Hyp mode, or Secure software executing in Monitor mode when **SCR.NS** is set to 1, can change the values of these bits.

See also *Summaries of asynchronous exception behavior* on page B1-1185.

The **HCR**.{AMO, FMO, IMO} bits also affect the masking of asynchronous exceptions in Non-secure state, as described in *Asynchronous exception masking* on page B1-1183.

The **SCR**.{EA, FIQ, IRQ} and **HCR**.{AMO, FMO, IMO} bits have no effect on the routing of Virtual Abort, Virtual FIQ, and Virtual IRQ exceptions.

### Summary of the possible modes for taking each exception

The following subsections describe the modes to which each exception can be taken:

- *Determining the mode to which the Undefined Instruction exception is taken* on page B1-1175
- *Determining the mode to which the Supervisor Call exception is taken* on page B1-1176
- *The mode to which the Secure Monitor Call exception is taken* on page B1-1176
- *The mode to which the Hypervisor Call exception is taken* on page B1-1176
- *The mode to which the Hyp Trap exception is taken* on page B1-1177
- *Determining the mode to which the Prefetch Abort exception is taken* on page B1-1177
- *Determining the mode to which the Data Abort exception is taken* on page B1-1178

- [The mode to which the Virtual Abort exception is taken on page B1-1179](#)
- [Determining the mode to which the IRQ exception is taken on page B1-1179](#)
- [The mode to which the Virtual IRQ exception is taken on page B1-1179](#)
- [Determining the mode to which the FIQ exception is taken on page B1-1180](#)
- [The mode to which the Virtual FIQ exception is taken on page B1-1180.](#)

These descriptions also show the vector offset for the exception entry for each mode.

For more information about:

- vector offsets, see [Exception vectors and the exception base address on page B1-1164](#)
- the routing of external aborts, IRQ and FIQ exceptions, and the virtual exceptions, see [Asynchronous exception routing controls on page B1-1174.](#)

**Determining the mode to which the Undefined Instruction exception is taken**

Figure B1-3 shows how the implementation, state, and configuration options determine the mode to which an Undefined Instruction exception is taken.

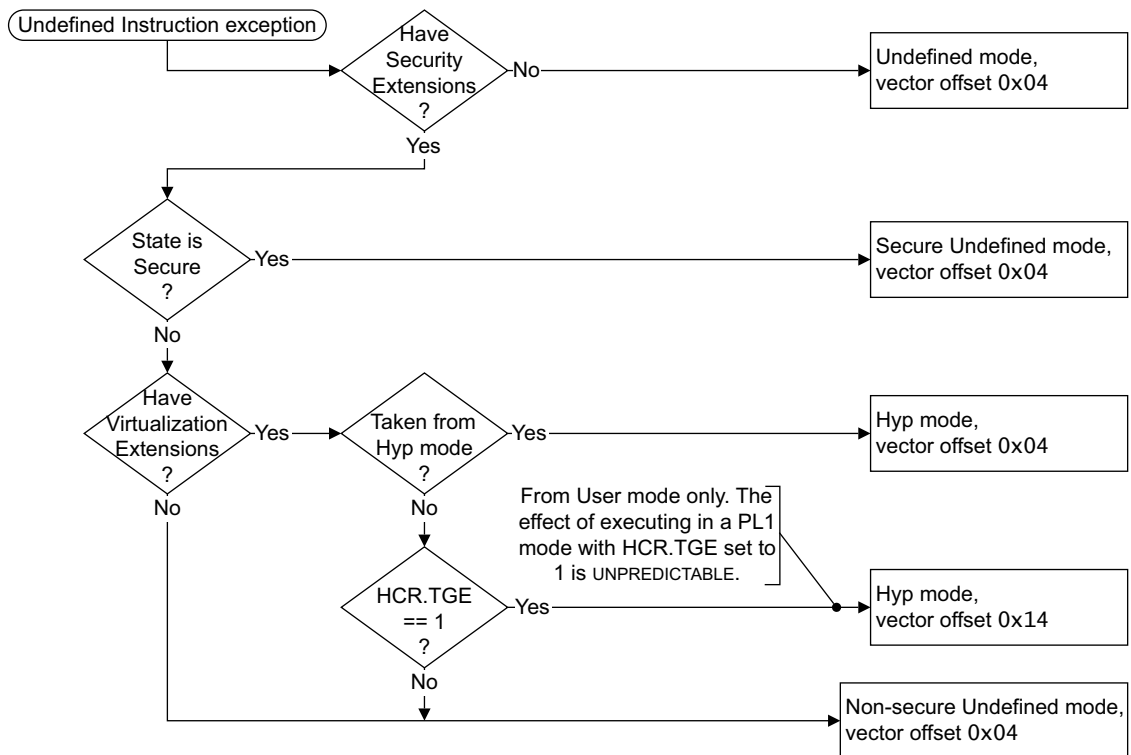

**Figure B1-3 The mode the Undefined Instruction exception is taken to**

**Determining the mode to which the Supervisor Call exception is taken**

Figure B1-4 shows how the implementation, state, and configuration options determine the mode to which a Supervisor Call exception is taken.

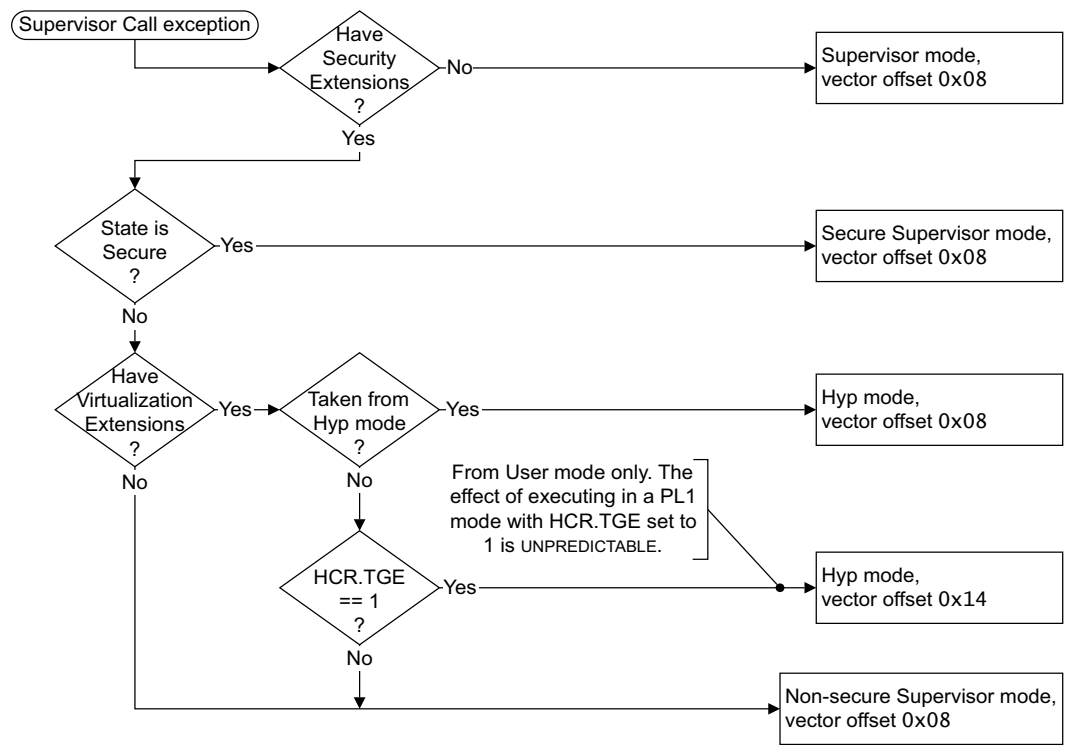

**Figure B1-4 The mode the Supervisor Call exception is taken to**

**The mode to which the Secure Monitor Call exception is taken**

The Secure Monitor Call exception is supported only as part of the Security Extensions. A Secure Monitor Call exception is taken to Monitor mode, using vector offset 0x08 from the Monitor exception base address.

**Note**

An SMC instruction that is trapped to Hyp mode because HCR.TSC is set to 1 generates a Hyp Trap exception, see [The mode to which the Hyp Trap exception is taken on page B1-1177](#).

**The mode to which the Hypervisor Call exception is taken**

The Hypervisor Call exception is supported only as part of the Virtualization Extensions. A Hypervisor Call exception is taken to Hyp mode, using a vector offset that depends on the mode from which the exception is taken, as [Figure B1-5](#) shows. This offset is from the Hyp exception base address.

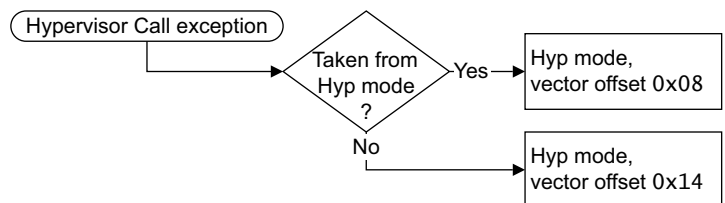

**Figure B1-5 The mode the Hypervisor Call exception is taken to**

**The mode to which the Hyp Trap exception is taken**

The Hyp Trap exception is supported only as part of the Virtualization Extensions. A Hyp Trap exception is taken to Hyp mode, using a vector offset of 0x14 from the Hyp exception base address.

**Determining the mode to which the Prefetch Abort exception is taken**

Figure B1-6 shows how the implementation, state, and configuration options determine the mode to which a Prefetch Abort exception is taken.

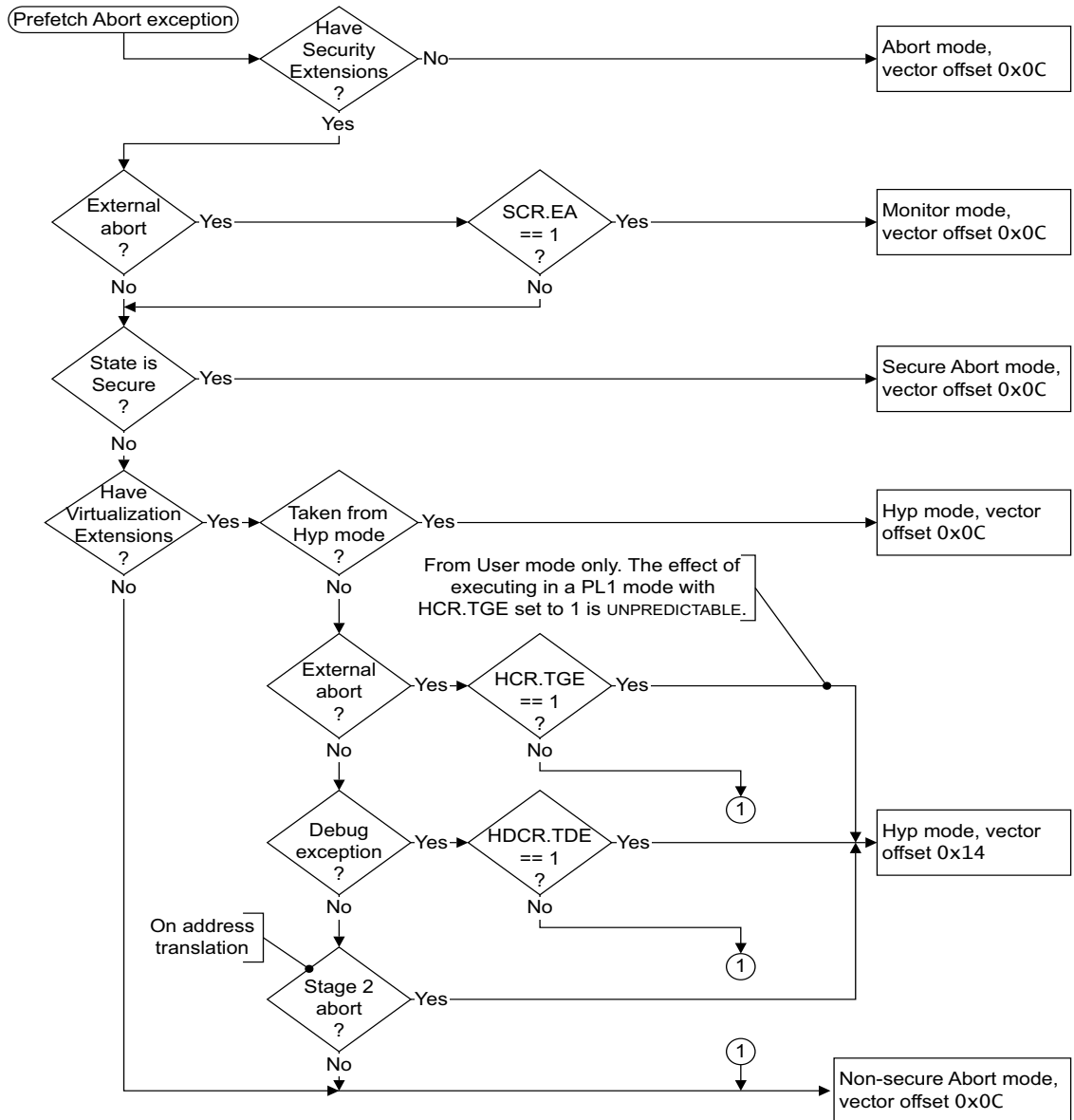

**Figure B1-6 The mode the Prefetch Abort exception is taken to**

**Determining the mode to which the Data Abort exception is taken**

Figure B1-7 shows how the implementation, state, and configuration options determine the mode to which a Data Abort exception is taken.

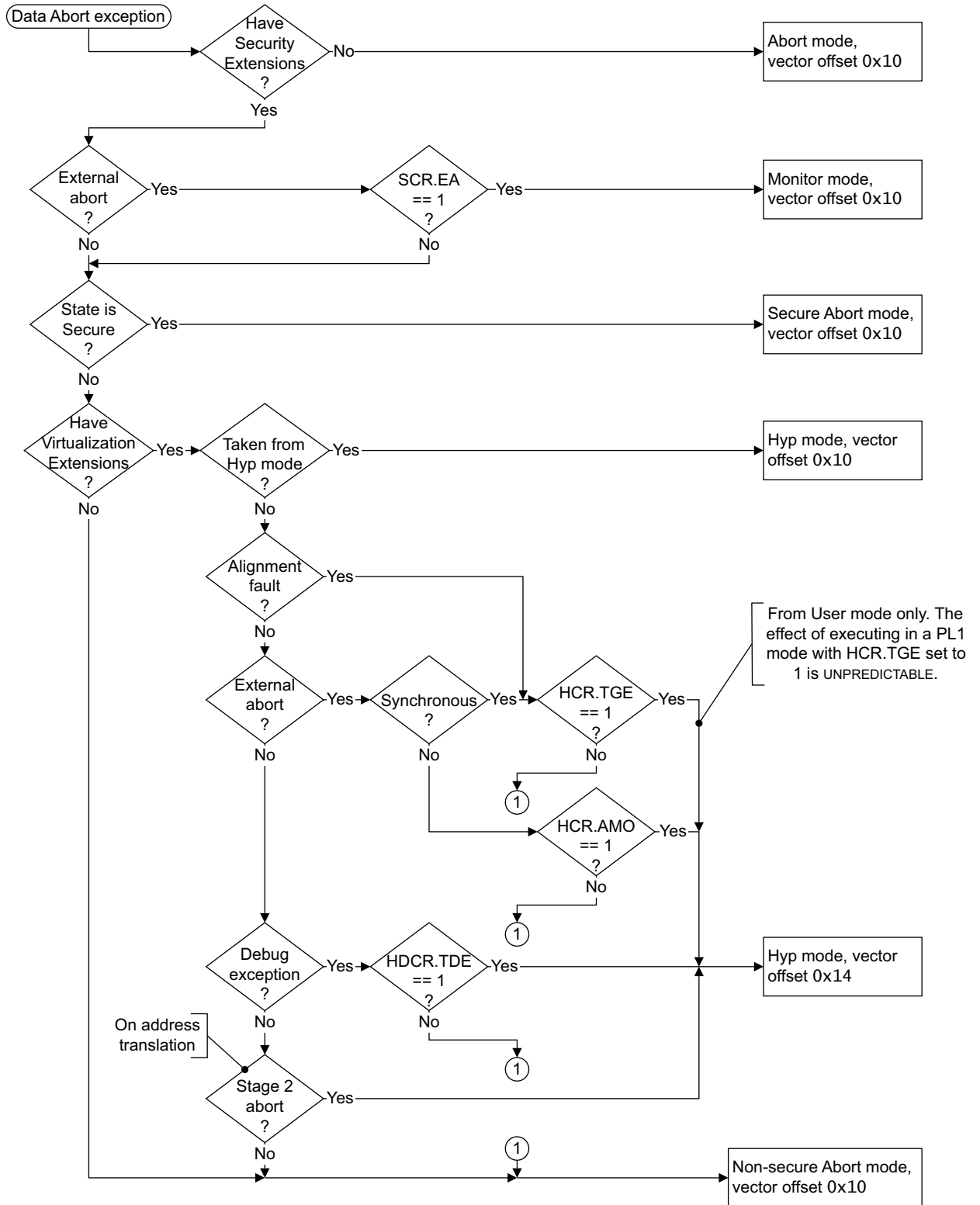

**Figure B1-7 The mode the Data Abort exception is taken to**

**The mode to which the Virtual Abort exception is taken**

The Virtual Abort exception is supported only as part of the Virtualization Extensions. A Virtual Abort exception is taken from a Non-secure PL1 or PL0 mode, and is taken to Non-secure Abort mode, using a vector offset of 0x10 from the Non-secure exception base address.

For more information about this exception see [Virtual exceptions in the Virtualization Extensions on page B1-1196](#).

**Determining the mode to which the IRQ exception is taken**

Figure B1-8 shows how the implementation, state, and configuration options determine the mode to which an IRQ exception is taken.

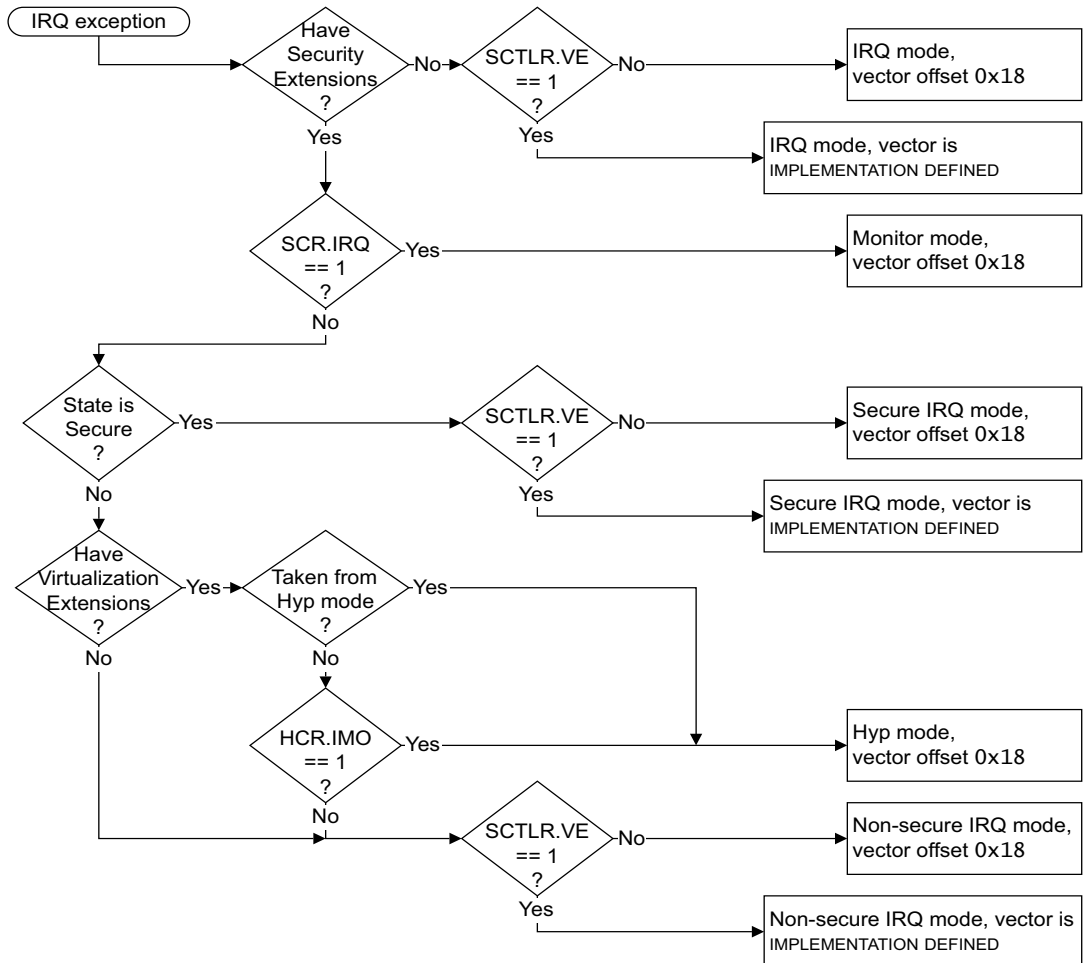

**Figure B1-8 The mode the IRQ exception is taken to**

**The mode to which the Virtual IRQ exception is taken**

The Virtual IRQ exception is supported only as part of the Virtualization Extensions. A Virtual IRQ exception is taken from a Non-secure PL1 or PL0 mode, and is taken to Non-secure IRQ mode, using a vector offset of 0x18 from the Non-secure exception base address.

For more information about this exception see [Virtual exceptions in the Virtualization Extensions on page B1-1196](#).

**Determining the mode to which the FIQ exception is taken**

Figure B1-8 on page B1-1179 shows how the implementation, state, and configuration options determine the mode to which an FIQ exception is taken.

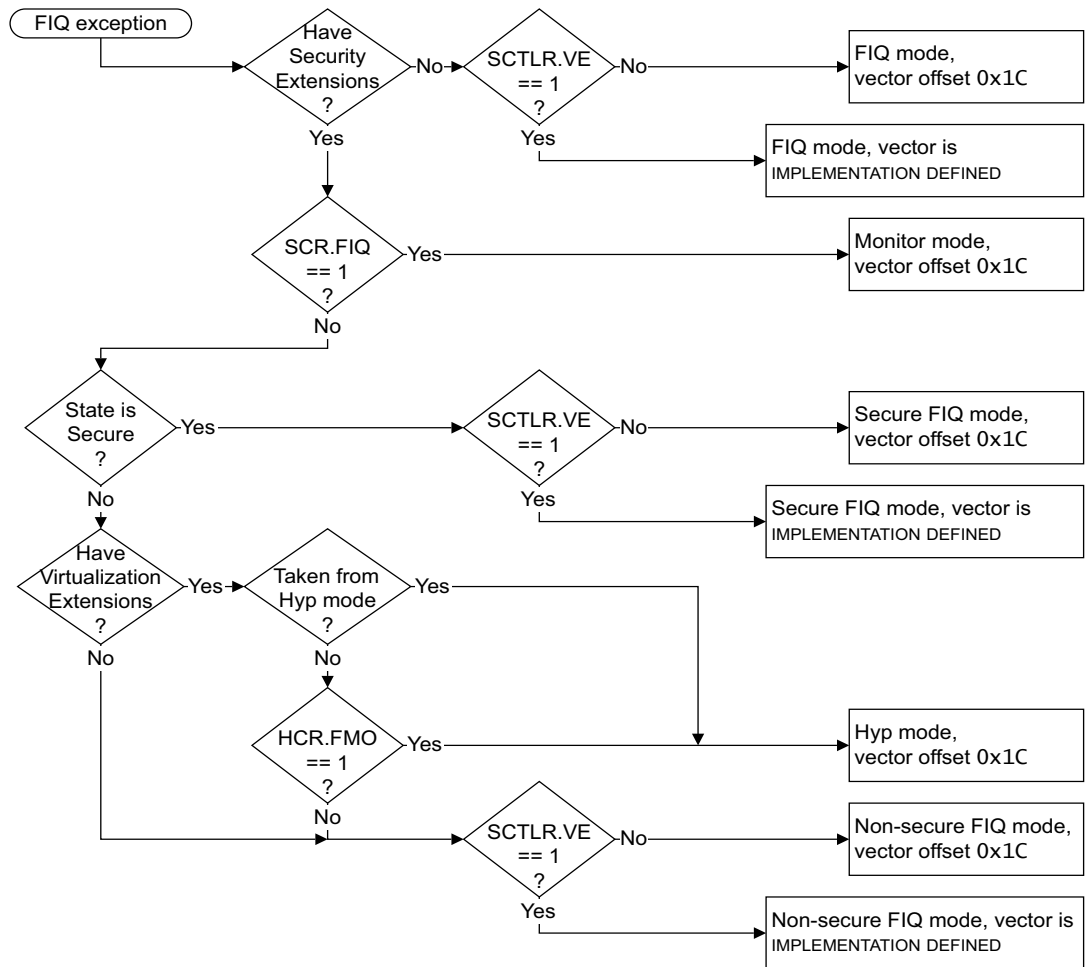

**Figure B1-9 The mode the FIQ exception is taken to**

**The mode to which the Virtual FIQ exception is taken**

The Virtual FIQ exception is supported only as part of the Virtualization Extensions. A Virtual FIQ exception is taken from a Non-secure PL1 or PL0 mode, and is taken to Non-secure FIQ mode, using a vector offset of 0x1C from the Non-secure exception base address.

For more information about this exception see [Virtual exceptions in the Virtualization Extensions](#) on page B1-1196.



## B1.8.5 Processor state on exception entry

The description of each exception includes a pseudocode description of entry to that exception, as [Table B1-5 on page B1-1170](#) shows. The following sections describe the processor state changes on entering an exception, for different processor implementations and operating states. However, you must always see the exception entry pseudocode for a full description of the state changes on exception entry:

- [Instruction set state on exception entry](#)
- [CPSR.E bit value on exception entry](#)
- [CPSR.{A, I, F, M} values on exception entry on page B1-1182.](#)

### Instruction set state on exception entry

Exception handlers always execute in either Thumb state or ARM state, as [Table B1-8](#) shows. On exception entry, [CPSR.{T, J}](#) are set to the values shown, with the [CPSR.T](#) value determined by [SCTLR.TE](#) or [HSCTLR.TE](#), depending on the mode the exception is taken to:

**Table B1-8 CPSR.J and CPSR.T bit values on exception entry**

Exception mode	HSCTLR.TE	SCTLR.TE	CPSR.J	CPSR.T	Exception handler state
Secure or Non-secure PL1	x	0	0	0	ARM
		1	0	1	Thumb
Hyp	0	x	0	0	ARM
		x	0	1	Thumb

When an implementation includes the Security Extensions, [SCTLR](#) is Banked for Secure and Non-secure states, and therefore the TE bit value might be different for Secure and Non-secure states. For an exception taken to a Secure or Non-secure PL1 mode, the [SCTLR.TE](#) bit for the security state to which the exception is taken determines the instruction set state for the exception handler. This means the PL1 exception handlers might run in different instruction set states, depending on the security state.

### CPSR.E bit value on exception entry

The [CPSR.E](#) bit controls the load and store endianness for data handling. On exception entry, this bit is set as [Table B1-9](#) shows:

**Table B1-9 CPSR.E bit value on exception entry**

Exception mode	HSCTLR.EE	SCTLR.EE	Endianness for data loads and stores	CPSR.E
Secure or Non-secure PL1	x	0	Little-endian	0
		1	Big-endian	1
Hyp	0	x	Little-endian	0
		x	Big-endian	1

For more information, see the bit description in [Format of the CPSR and SPSRs on page B1-1148](#).

### CPSR.{A, I, F, M} values on exception entry

On exception entry, **CPSR.M** is set to the value for the mode to which the exception is taken, as described in [Processor mode for taking exceptions on page B1-1172](#).

[Table B1-10](#) shows the cases where **CPSR.{A, I, F}** bits are set to 1 on an exception entry, and how this depends on the mode and security state to which an exception is taken. If the table entry for a particular mode and security state does not define a value for a **CPSR.{A, I, F}** bit then that bit is unchanged by the exception entry. In this table:

- The *Exception mode* column is the mode to which the exception is taken.
- The *Non-secure, no Virtualization Extensions* column applies to exceptions taken to Non-secure state in an implementation that includes the Security Extensions but not the Virtualization Extensions.
- The *All others* column applies to:
  - implementations that do not include the Security Extensions
  - exceptions taken to Secure state
  - exceptions taken to Non-secure state in an implementation that includes the Virtualization Extensions.

**Table B1-10 CPSR.{A, I, F} values on exception entry**

Exception mode	Security state and implementation	
	Non-secure, no Virtualization Extensions	All others
Hyp	-	If <b>SCR.EA</b> ==0 then <b>CPSR.A</b> is set to 1 If <b>SCR.IRQ</b> ==0 then <b>CPSR.I</b> is set to 1 If <b>SCR.FIQ</b> ==0 then <b>CPSR.F</b> is set to 1
Monitor	-	<b>CPSR.A</b> is set to 1 <b>CPSR.I</b> is set to 1 <b>CPSR.F</b> is set to 1
FIQ	If <b>SCR.AW</b> ==1 then <b>CPSR.A</b> is set to 1 <b>CPSR.I</b> is set to 1 If <b>SCR.FW</b> ==1 then <b>CPSR.F</b> is set to 1	<b>CPSR.A</b> is set to 1 <b>CPSR.I</b> is set to 1 <b>CPSR.F</b> is set to 1
IRQ, Abort	If <b>SCR.AW</b> ==1 then <b>CPSR.A</b> is set to 1 <b>CPSR.I</b> is set to 1	<b>CPSR.A</b> is set to 1 <b>CPSR.I</b> is set to 1
Undefined, Supervisor	<b>CPSR.I</b> is set to 1	<b>CPSR.I</b> is set to 1

———— **Note** —————

Compared to an implementation that includes only the Security Extensions, implementing the Virtualization Extensions changes both the effects of the **SCR.{AW, FW}** bits and the interpretation of the **CPSR.{A, F}** bits. [Asynchronous exception masking on page B1-1183](#) summarizes the behavior for both of these implementation options.

## B1.8.6 Asynchronous exception masking

The **CPSR**.{A, I, F} bits can mask the corresponding exceptions, as follows:

- **CPSR**.A can mask asynchronous aborts
- **CPSR**.I can mask IRQ exceptions
- **CPSR**.F can mask FIQ exceptions.

In an ARMv7 implementation that does not include the Security Extensions, setting one of these bits to 1 masks the corresponding exception, meaning the exception cannot be taken.

In an implementation that includes the Security Extensions, the **SCR**.{AW, FW} bits provide a mechanism to prevent use of the **CPSR**.{A, F} mask bits by Non-secure software. In an implementation that includes the Virtualization Extensions:

- **HCR**.{AMO, FMO} modify this mechanism
- **HCR**.IMO can prevent the masking, by **CPSR**.I, of IRQs taken from Non-secure state.

This means the asynchronous exception masking mechanism is as follows:

### Implementation that includes the Security Extensions but not the Virtualization Extensions

When an **SCR**.{AW, FW} bit is set to 0, Non-secure software cannot update the corresponding **CPSR** bit. This means:

- when **SCR**.AW is set to 0, **CPSR**.A cannot be updated in Non-secure state
- when **SCR**.FW is set to 0, **CPSR**.F cannot be updated in Non-secure state.

#### ———— Note ————

There is no control of updates to **CPSR**.I. **CPSR**.I can be updated in either security state.

The **CPSR**.{A, I, F} bits mask the corresponding exceptions. This means:

- when **CPSR**.A is set to 1, asynchronous aborts are masked
- when **CPSR**.I is set to 1, IRQs are masked
- when **CPSR**.F is set to 1, FIQs are masked.

### Implementation that includes the Security Extensions and the Virtualization Extensions

When an **HCR**.{AMO, IMO, FMO} mask override bit is set to 1, the value of the corresponding **CPSR**.{A, I, F} bit is ignored when both of the following apply:

- the exception is taken from Non-secure state
- either:
  - the corresponding **SCR**.{EA, IRQ, FIQ} bit routes the exception to Monitor mode
  - the exception is taken from a Non-secure mode other than Hyp mode.

In addition, when an **SCR**.{AW, FW} bit is set to 0, the value of the corresponding **CPSR**.{A, F} bit is ignored when all of the following apply:

- the exception is taken from Non-secure state
- the corresponding **SCR**.{EA, FIQ} bit routes the exception to Monitor mode
- the corresponding **HCR**.{AMO, FMO} mask override bit is set to 0.

This means that the controls on each of the **CPSR** mask bits, and the effect of those bits, are as shown in the following tables.

Table B1-11 shows the controls of the masking of asynchronous exceptions by CPSR.A.

**Table B1-11 Control of masking by CPSR.A**

Security state	HCR.AMO	SCR.EA	SCR.AW	Mode	CPSR.A
Secure	x	x	x	x	Masks asynchronous aborts, when set to 1
Non-secure	0	0	x	x	Masks asynchronous aborts, when set to 1
			1	0	x
		1	x	x	Not Hyp
	1	0	x	Hyp	Masks asynchronous aborts, when set to 1
			1	x	x

Table B1-12 shows the controls of the masking of FIQ exceptions by CPSR.F:

**Table B1-12 Control of masking by CPSR.I**

Security state	HCR.IMO	SCR.IRQ	Mode	CPSR.I
Secure	x	x	x	Masks IRQs, when set to 1
Non-secure	0	x	x	Masks IRQs, when set to 1
		1	x	Not Hyp
	1	0	Hyp	Masks IRQs, when set to 1
		1	x	Ignored

Table B1-13 shows the controls of the masking of FIQ exceptions by CPSR.F:

**Table B1-13 Control of masking by CPSR.F**

Security state	HCR.FMO	SCR.FIQ	SCR.FW	Mode	CPSR.F
Secure	x	x	x	x	Masks FIQs, when set to 1
Non-secure	0	0	x	x	Masks FIQs, when set to 1
			1	0	x
		1	x	x	Not Hyp
	1	0	x	Hyp	Masks FIQs, when set to 1
			1	x	x

The values of SCR.{AW, FW} do not affect whether CPSR.{A, F} can be updated in Non-secure state.

*Mask override bits in the Virtualization Extensions on page B1-1185* gives more information about the HCR.{AMO, IMO, FMO} bits.

## Mask override bits in the Virtualization Extensions

The Virtualization Extensions add a set of mask override bits to the **HCR**, that affect both:

- the masking of asynchronous exceptions taken from Non-secure state
- the enabling of the corresponding virtual exceptions.

These mask bits and their effects are:

- **HCR.AMO** can affect the masking of asynchronous aborts, and the enabling of Virtual Abort exceptions
- **HCR.IMO** can affect the masking of IRQ exceptions, and the enabling of Virtual IRQ exceptions
- **HCR.FMO** can affect the masking of FIQ exceptions, and the enabling of Virtual FIQ exceptions.

These bits can also affect the routing of the corresponding physical exceptions, see *Asynchronous exception routing controls* on page B1-1174.

The **HCR** mask override bits have no effect on exceptions taken to Secure state.

If an **HCR** mask override bit is set to 1, when the processor is in Non-secure state and not in Hyp mode:

- If the corresponding physical exception is not routed to Monitor mode, the physical exception is taken to Hyp mode.
- When the corresponding **CPSR** mask bit is set to 1 it:
  - masks the corresponding virtual exception
  - does not mask the corresponding physical exception.
- If the corresponding virtual exception bit in the **HCR** is set to 1, and the corresponding **CPSR** mask bit is not set to 1, the virtual exception is signaled to the processor.

When the processor is in Hyp mode, if an **HCR** mask override bit is set to 1 the corresponding **CPSR** mask bit cannot mask the corresponding physical exception if that exception is routed to Monitor mode.

### ———— Note —————

When the processor is in Hyp mode:

- physical asynchronous exceptions that are not routed to Monitor mode are taken to Hyp mode
- virtual exceptions are not signaled to the processor.

## B1.8.7 Summaries of asynchronous exception behavior

In an ARMv7 implementation that does not include the Security Extensions, the asynchronous exceptions behave as follows:

- an asynchronous abort is taken to Abort mode
- an IRQ exception is taken to IRQ mode
- an FIQ exception is taken to FIQ mode.

The Security Extensions and Virtualization Extensions introduce controls that affect:

- the routing of these exceptions, see *Asynchronous exception routing controls* on page B1-1174
- masking of these exceptions in Non-secure state, see *Asynchronous exception masking* on page B1-1183.

This section summarizes the effect of these controls, for each of the asynchronous exceptions. Because the Virtualization Extensions change the behavior of some of the Security Extensions controls, it gives separate summaries for implementations that include and do not include the Virtualization Extensions.

———— **Note** —————

- In an implementation that includes the Security Extensions but does not include the Virtualization Extensions, the following configurations permit the Non-secure state to deny service to the Secure state. Therefore, ARM recommends that, wherever possible, these configurations are not used:
  - Setting **SCR.IRQ** to 1. With this configuration, Non-secure PL1 software can set **CPSR.I** to 1, denying the required routing of IRQs to Monitor mode.
  - Setting **SCR.FW** to 1 when **SCR.FIQ** is set to 1. With this configuration, Non-secure PL1 software can set **CPSR.F** to 1, denying the required routing of FIQs to Monitor mode.
 The changes introduced by the Virtualization Extensions remove these possible denials of service.
- Interrupts driven by Secure peripherals are called Secure interrupts. When **SCR.FW** = 0 and **SCR.FIQ** = 1, FIQ exceptions can be used as Secure interrupts. These enter Secure state in a deterministic way.

The following subsections summarize the behavior of asynchronous exceptions:

- [Asynchronous exception behavior, Security Extensions only](#)
- [Asynchronous exception behavior, with the Virtualization Extensions on page B1-1187](#)

**Asynchronous exception behavior, Security Extensions only**

The following subsections describe the behavior of each of the asynchronous exceptions, in an implementation that includes the Security Extensions but not the Virtualization Extensions:

- [Behavior of asynchronous aborts, Virtualization Extensions not implemented](#)
- [Behavior of IRQ exceptions, Virtualization Extensions not implemented on page B1-1187](#)
- [Behavior of FIQ exceptions, Virtualization Extensions not implemented on page B1-1187.](#)

**Behavior of asynchronous aborts, Virtualization Extensions not implemented**

Table B1-14 shows how **SCR**.{AW, EA} control asynchronous abort behavior.

**Table B1-14 Behavior of asynchronous aborts, Virtualization Extensions not implemented**

<b>SCR.EA</b>	<b>SCR.AW</b>	<b>Effect on asynchronous abort behavior</b>
0	x	Asynchronous aborts are taken to Abort mode. If <b>CPSR.A</b> is set to 1 it masks asynchronous aborts in all states and modes. <b>CPSR.A</b> can be modified in Secure and Non-secure PL1 modes.
1	0	Asynchronous aborts are taken to Monitor mode. If <b>CPSR.A</b> is set to 1 it masks asynchronous aborts in all states and modes. <b>CPSR.A</b> can be modified in Secure PL1 modes, but cannot be modified in Non-secure PL1 modes.
1	1	Asynchronous aborts are taken to Monitor mode. If <b>CPSR.A</b> is set to 1 it masks asynchronous aborts in all states and modes. <b>CPSR.A</b> can be modified in Secure and Non-secure PL1 modes.

———— **Note** —————

The values of **SCR.EA** and **CPSR.A** have no effect on the behavior of asynchronous watchpoints.

### Behavior of IRQ exceptions, Virtualization Extensions not implemented

Table B1-15 shows how SCR.IRQ controls IRQ exception behavior.

**Table B1-15 Behavior of IRQ exceptions, Virtualization Extensions not implemented**

SCR.IRQ	Effect on IRQ exception behavior
0	IRQ exceptions are taken to IRQ mode. If CPSR.I is set to 1 it masks IRQs in all states and modes.
1	IRQ exceptions are taken to Monitor mode. If CPSR.I is set to 1 it masks IRQs in all states and modes.

### Behavior of FIQ exceptions, Virtualization Extensions not implemented

Table B1-16 shows how SCR.{FIQ, FW} control FIQ exception behavior.

**Table B1-16 Behavior of FIQ exceptions, Virtualization Extensions not implemented**

SCR.FIQ	SCR.FW	Effect on FIQ exception behavior
0	x	FIQ exceptions are taken to FIQ mode. If CPSR.F is set to 1 it masks FIQs in all states and modes. CPSR.F can be modified in Secure and Non-secure PL1 modes.
1	0	FIQ exceptions are taken to Monitor mode. If CPSR.F is set to 1 it masks FIQs in all states and modes. CPSR.F can be modified in Secure PL1 modes, but cannot be modified in Non-secure PL1 modes.
1	1	FIQ exceptions are taken to Monitor mode. If CPSR.F is set to 1 it masks FIQs in all states and modes. CPSR.F can be modified in Secure and Non-secure PL1 modes.

## Asynchronous exception behavior, with the Virtualization Extensions

The following subsections describe the behavior of each of the asynchronous exceptions, in an implementation that includes both the Security Extensions and the Virtualization Extensions:

- [Behavior of asynchronous aborts when an implementation includes the Virtualization Extensions on page B1-1188](#)
- [Behavior of IRQ exceptions when an implementation includes the Virtualization Extensions on page B1-1189](#)
- [Behavior of FIQ exceptions when an implementation includes the Virtualization Extensions on page B1-1190.](#)

These summaries include the behavior of the virtual exceptions. See [Virtual exceptions in the Virtualization Extensions on page B1-1196](#) for more information about these exceptions. To distinguish them from the virtual exceptions, the asynchronous aborts defined for an ARMv7 implementation that does not include the Virtualization Extensions are described as *physical* aborts. That is, they are described as physical asynchronous aborts, physical IRQs, and physical FIQs.

#### ————— Note —————

As stated in [Vectored interrupt support on page B1-1167](#), the Virtualization Extensions do not support the vectoring of IRQ or FIQ exceptions that are routed to Hyp mode. Therefore, if at least one of HCR.IMO and HCR.FMO is set to 1, the processor behaves as if the Non-secure SCTLR.VE bit is set to 0, regardless of the actual value of that bit.

**Behavior of asynchronous aborts when an implementation includes the Virtualization Extensions**

Table B1-17 shows how SCR.{AW, EA} and HCR.AMO control asynchronous abort behavior in an implementation that includes the Virtualization Extensions. In such an implementation, CPSR.A can be modified in Secure and Non-secure PL1 modes and in Hyp mode, regardless of the value of SCR.AW.

**Table B1-17 Behavior of asynchronous aborts, Virtualization Extensions implemented**

SCR.EA	SCR.AW	HCR.AMO	Effect on asynchronous abort behavior
0	x	0	Physical asynchronous aborts are taken to: <ul style="list-style-type: none"> <li>• Abort mode, if taken from a PL0 or PL1 mode</li> <li>• Hyp mode, if taken from Hyp mode.</li> </ul> HCR.VA, the Virtual asynchronous abort bit, has no effect, and Virtual asynchronous aborts are masked. If CPSR.A is set to 1 it masks physical asynchronous aborts in all states and modes.
0	x	1	Physical asynchronous aborts are taken to: <ul style="list-style-type: none"> <li>• Secure Abort mode if taken from a Secure mode</li> <li>• Hyp mode if taken from a Non-secure mode.</li> </ul> If HCR.VA is set to 1 and the processor is in a Non-secure PL1 or PL0 mode, a virtual asynchronous abort is signaled to the processor. If CPSR.A is set to 1: <ul style="list-style-type: none"> <li>• in Secure state or in Hyp mode, physical asynchronous aborts are masked</li> <li>• in a Non-secure PL1 or PL0 mode:               <ul style="list-style-type: none"> <li>— virtual asynchronous aborts are masked</li> <li>— physical asynchronous aborts are not masked.</li> </ul> </li> </ul>
1	0	0	Physical asynchronous aborts are taken to Monitor mode. HCR.VA, the Virtual asynchronous abort bit, has no effect, and Virtual asynchronous aborts are masked. If CPSR.A is set to 1: <ul style="list-style-type: none"> <li>• in Secure state, physical asynchronous aborts are masked</li> <li>• in Non-secure state, physical asynchronous aborts are not masked.</li> </ul>
1	x	1	Physical asynchronous aborts are taken to Monitor mode. If HCR.VA is set to 1 and the processor is in a Non-secure PL1 or PL0 mode, a virtual asynchronous abort is signaled to the processor. If CPSR.A is set to 1: <ul style="list-style-type: none"> <li>• in Secure state, physical asynchronous aborts are masked</li> <li>• in Non-secure state:               <ul style="list-style-type: none"> <li>— physical asynchronous aborts are not masked</li> <li>— in PL1 and PL0 modes, virtual asynchronous aborts are masked.</li> </ul> </li> </ul>
1	1	0	Physical asynchronous aborts are taken to Monitor mode. HCR.VA, the Virtual asynchronous abort bit, has no effect. If CPSR.A is set to 1 it masks physical asynchronous aborts in all states and modes.



**Behavior of IRQ exceptions when an implementation includes the Virtualization Extensions**

Table B1-18 shows how SCR.IRQ and HCR.IMO control IRQ exception behavior, in an implementation that includes the Virtualization Extensions.

**Table B1-18 Behavior of IRQ exceptions, Virtualization Extensions implemented**

SCR.IRQ	HCR.IMO	Effect on IRQ exception behavior
0	0	Physical IRQs are taken to: <ul style="list-style-type: none"> <li>• IRQ mode, if taken from a PL0 or PL1 mode</li> <li>• Hyp mode, if taken from Hyp mode.</li> </ul> HCR.VI, the Virtual IRQ bit, has no effect, and Virtual IRQs are masked. If CPSR.I is set to 1 it masks IRQs in all states and modes.
0	1	Physical IRQs are taken to: <ul style="list-style-type: none"> <li>• Secure IRQ mode if taken from a Secure mode</li> <li>• Hyp mode if taken from a Non-secure mode.</li> </ul> If HCR.VI is set to 1 and the processor is in a Non-secure PL1 or PL0 mode, a virtual IRQ is signaled to the processor. If CPSR.I is set to 1: <ul style="list-style-type: none"> <li>• in Secure state or in Hyp mode, physical IRQs are masked</li> <li>• in a Non-secure PL1 or PL0 mode:               <ul style="list-style-type: none"> <li>— virtual IRQs are masked</li> <li>— physical IRQs are not masked.</li> </ul> </li> </ul>
1	0	Physical IRQs are taken to Monitor mode. HCR.VI, the Virtual IRQ bit, has no effect, and Virtual IRQs are masked. If CPSR.I is set to 1 it masks physical IRQs in all states and modes.
1	1	Physical IRQs are taken to Monitor mode. If HCR.VI is set to 1 and the processor is in a Non-secure PL1 or PL0 mode, a virtual IRQ is signaled to the processor. If CPSR.I is set to 1: <ul style="list-style-type: none"> <li>• in Secure state, physical IRQs are masked</li> <li>• in Non-secure state:               <ul style="list-style-type: none"> <li>— physical IRQs are not masked</li> <li>— in PL1 and PL0 modes, virtual IRQs are masked.</li> </ul> </li> </ul>

**Behavior of FIQ exceptions when an implementation includes the Virtualization Extensions**

Table B1-19 shows how `SCR.FIQ`, `SCR.FW` and `HCR.FMO` control FIQ exception behavior, in an implementation that includes the Virtualization Extensions. In such an implementation, `CPSR.F` can be modified in Secure and Non-secure PL1 modes and in Hyp mode, regardless of the value of `SCR.FW`.

**Table B1-19 Behavior of FIQ exceptions, Virtualization Extensions implemented**

<code>SCR.FIQ</code>	<code>SCR.FW</code>	<code>HCR.FMO</code>	Effect on FIQ exception behavior
0	x	0	Physical FIQs are taken to: <ul style="list-style-type: none"> <li>• FIQ mode, if taken from a PL1 or PL0 mode</li> <li>• Hyp mode, if taken from Hyp mode.</li> </ul> <code>HCR.VF</code> , the Virtual FIQ bit, has no effect, and Virtual FIQs are masked. If <code>CPSR.F</code> is set to 1 it masks FIQs in all states and modes.
0	x	1 <sup>a</sup>	Physical FIQs are taken to: <ul style="list-style-type: none"> <li>• Secure FIQ mode if taken from a Secure mode</li> <li>• Hyp mode if taken from a Non-secure mode.</li> </ul> If <code>HCR.VF</code> is set to 1 and the processor is in a Non-secure PL1 or PL0 mode, a virtual FIQ is signaled to the processor. If <code>CPSR.F</code> is set to 1: <ul style="list-style-type: none"> <li>• in Secure state or in Hyp mode, physical FIQs are masked</li> <li>• in a Non-secure PL1 or PL0 mode:               <ul style="list-style-type: none"> <li>— virtual FIQs are masked</li> <li>— physical FIQs are not masked.</li> </ul> </li> </ul>
1	0	0	Physical FIQs are taken to Monitor mode. <code>HCR.VF</code> , the Virtual FIQ bit, has no effect, and Virtual FIQs are masked. If <code>CPSR.F</code> is set to 1: <ul style="list-style-type: none"> <li>• in Secure state, physical FIQs are masked</li> <li>• in Non-secure state, physical FIQs are not masked.</li> </ul>
1	x	1 <sup>a</sup>	Physical FIQs are taken to Monitor mode. If <code>HCR.VF</code> is set to 1 and the processor is in a Non-secure PL1 or PL0 mode, a virtual FIQ is signaled to the processor. If <code>CPSR.F</code> is set to 1: <ul style="list-style-type: none"> <li>• in Secure state, physical FIQs are masked</li> <li>• in Non-secure state:               <ul style="list-style-type: none"> <li>— physical FIQs are not masked</li> <li>— in PL1 and PL0 modes, virtual FIQs are masked.</li> </ul> </li> </ul>
1	1	0	Physical FIQs are taken to Monitor mode. <code>HCR.VF</code> , the Virtual FIQ bit, has no effect. If <code>CPSR.F</code> is set to 1 it masks physical FIQs in all states and modes.

a. Only if `NSACR.RFR` is set to 0. If `NSACR.RFR` is set to 1, the processor behaves as if `HCR.FMO` is set to 0.

## B1.8.8 Routing general exceptions to Hyp mode

### ———— Note ————

The routing provided by setting `HCR.TGE` to 1 permits applications that run in User mode to run on a hypervisor, in Hyp mode, without a Guest OS running in a Non-secure PL1 mode. Many UNPREDICTABLE definitions associated with setting `HCR.TGE` to 1 are based on this usage model.

When `HCR.TGE` is set to 1, and the processor is in Non-secure User mode, the following exceptions are taken to Hyp mode, instead of to the default Non-secure mode for handling the exception:

- Undefined Instruction exceptions.
- Supervisor Call exceptions.
- Synchronous External aborts.
- Any Alignment fault other than an alignment fault caused by the memory type when `SCTLR.M` is 1.

### ———— Note ————

If `SCTLR.M` and `HCR.TGE` are both 1 then behavior is UNPREDICTABLE.

The following sections give more information about the behavior when each of these exceptions is routed in this way:

- *Undefined Instruction exception, when `HCR.TGE` is set to 1*
- *Supervisor Call exception, when `HCR.TGE` is set to 1*
- *Synchronous external abort, when `HCR.TGE` is set to 1 on page B1-1192*
- *Alignment fault, when `HCR.TGE` is set to 1 on page B1-1192.*

The effect of executing in any of the following states with `HCR.TGE` set to 1 is UNPREDICTABLE:

- In a Non-secure PL1 mode.
- In Non-secure User mode if either:
  - `SCTLR.M` is set to 1.
  - One or more of `HDCR`.{TDE, TDA, TDRA, TDOSA} is set to 0.

### Undefined Instruction exception, when `HCR.TGE` is set to 1

When `HCR.TGE` is set to 1, if the processor is executing in Non-secure User mode and attempts to execute an UNDEFINED instruction, it takes the Hyp Trap exception, instead of an Undefined Instruction exception. On taking the Hyp Trap exception, the `HSR` reports an unknown reason for the exception, using the EC value 0x00. For more information see *Use of the HSR on page B3-1424*.

### Supervisor Call exception, when `HCR.TGE` is set to 1

When `HCR.TGE` is set to 1, if the processor executes an SVC instruction in Non-secure User mode, the Supervisor Call exception generated by the instruction is taken to Hyp mode.

The `HSR` reports that entry to Hyp mode was because of a Supervisor Call exception, and:

- If the SVC is unconditional, takes for the `imm16` value in the `HSR`:
  - A zero-extended 8-bit immediate value for the Thumb SVC instruction.

### ———— Note ————

The only Thumb encoding for SVC is a 16-bit instruction encoding.

- The bottom 16 bits of the immediate value for the ARM SVC instruction.
- If the SVC is conditional, the `imm16` value in the `HSR` is UNKNOWN.

If the SVC is conditional, the processor takes the exception only if it passes its condition code check.

The [HSR](#) reports the exception as a Supervisor Call exception taken to Hyp mode, using the EC value 0x11. For more information, see [Use of the HSR on page B3-1424](#).

———— **Note** —————

The effect of setting [HCR.TGE](#) to 1 is to route the Supervisor Call exception to Hyp mode, not to trap the execution of the SVC instruction. This means that the preferred return address for the exception, when routed to Hyp mode in this way, is the instruction after the SVC instruction.

---

### Synchronous external abort, when HCR.TGE is set to 1

When [HCR.TGE](#) is set to 1, and [SCR.EA](#) is set to 0, if the processor is executing in Non-secure User mode and attempts to execute an instruction that causes a synchronous external abort, it takes the Hyp Trap exception, instead of a Data Abort or Prefetch Abort exception. On taking the Hyp Trap exception, the [HSR](#) indicates whether a Data Abort exception or a Prefetch Abort exception caused the Hyp Trap exception entry, and presents a valid syndrome in the [HSR](#).

———— **Note** —————

When [SCR.EA](#) is set to 1, external aborts are routed to Secure Monitor mode, and this takes priority over the [HCR.TGE](#) routing. For more information, see [Asynchronous exception routing controls on page B1-1174](#). The [SCR.EA](#) control described in that section applies to both synchronous and asynchronous external aborts.

---

If an instruction that causes this exception is conditional, the processor takes the exception only if the instruction passes its condition code check.

The [HSR](#) reports the exception either:

- as a Prefetch Abort exception routed to Hyp mode, using the EC value 0x20
- as a Data Abort exception routed to Hyp mode, using the EC value 0x24.

For more information about the exception reporting, see [Use of the HSR on page B3-1424](#).

### Alignment fault, when HCR.TGE is set to 1

When [HCR.TGE](#) is set to 1, if the processor is executing in Non-secure User mode, this control applies to an attempt to execute an instruction that causes an Alignment fault because either:

- [SCTLR.A](#) is set to 1
- the instruction supports only aligned accesses, and is accessing an unaligned address.

[Unaligned data access on page A3-108](#) summarizes the Alignment faults that are trapped.

In these cases, the attempted execution generates a Hyp Trap exception, instead of a Data Abort exception. When the Hyp Trap exception is taken, the [HSR](#) reports that a Data Abort caused the Hyp Trap exception entry, and presents a valid syndrome.

When the Non-secure [SCTLR.M](#) bit is set to 1, enabling the Non-secure PL1&0 stage 1 MMU, an otherwise-permitted unaligned access to Device or Strongly-ordered memory generates an Alignment fault. However, having [HCR.TGE](#) set to 1 when [SCTLR.M](#) is set to 1 is generally UNPREDICTABLE.

If an instruction that causes this exception is conditional, the processor takes the exception only if the instruction passes its condition code check.

The [HSR](#) reports the exception as a Data Abort routed to Hyp mode, using the EC value 0x24, see [Use of the HSR on page B3-1424](#).

### B1.8.9 Routing Debug exceptions to Hyp mode

When `HDCR.TDE` is set to 1, if the processor is executing in a Non-secure mode other than Hyp mode, any Debug exception is routed to Hyp mode. This means it generates a Hyp Trap exception. This applies to:

- Debug exceptions associated with instruction fetch, that would otherwise generate a Prefetch Abort exception. These are exceptions generated by the Breakpoint, BKPT instruction, and Vector catch debug events, see [Debug exception on BKPT instruction, Breakpoint, or Vector catch debug events on page C4-2088](#).
- Debug exceptions associated with data accesses, that would otherwise generate a Data Abort exception. These are exceptions generated by the Watchpoint debug event, see [Debug exception on Watchpoint debug event on page C4-2089](#).

When `HDCR.TDE` is set to 1, the `HDCR.{TDRA, TDOSA, TDA}` bits must all be set to 1, otherwise behavior is UNPREDICTABLE. See also [Permitted combinations of HDCR.{TDRA, TDOSA, TDA, TDE} bits on page B1-1260](#).

———— **Note** ————

- A debug event generates a debug exception only when invasive debug is enabled and Monitor debug-mode is selected, see [About debug exceptions on page C4-2088](#). When Halting debug-mode is selected, a debug event causes Debug state entry and cannot be trapped to Hyp mode.
- When `HDCR.TDE` is set to 1, the Hyp Trap exception is generated instead of the Prefetch Abort exception or Data Abort exception that is otherwise generated by the Debug exception.
- Debug exceptions, other than the exception on the BKPT instruction, are not permitted in Hyp mode.

When a Hyp Trap exception is generated because `HDCR.TDE` is set to 1, The `HSR` reports the exception either:

- as a Prefetch Abort exception routed to Hyp mode, using the EC value `0x20`
- as a Data Abort exception routed to Hyp mode, using the EC value `0x24`.

For more information see [Use of the HSR on page B3-1424](#).

### B1.8.10 Exception return

In the ARM architecture, *exception return* requires the simultaneous restoration of the PC and `CPSR` to values that are consistent with the desired state of execution on returning from the exception. Typically, exception return involves returning to one of:

- the instruction after the instruction boundary at which an asynchronous exception was taken
- the instruction following an SVC, SMC, or HMC instruction, for an exception generated by one of those instructions
- the instruction that caused the exception, after the reason for the exception has been removed
- the subsequent instruction, if the instruction that caused the exception has been emulated in the exception handler.

The ARM architecture defines a *preferred return address* for each exception other than Reset, see [Link values saved on exception entry on page B1-1171](#). The values of the `SPSR.IT[7:0]` bits generated on exception entry are always correct for this preferred return address, but might require adjustment by the exception handler if returning elsewhere.

In some cases, to calculate the appropriate preferred return address, a subtraction must be performed on the link value saved on taking the exception. The description of each exception includes any value that must be subtracted from the link value, and other information about the required exception return.

On an exception return, the **CPSR** takes either:

- the value loaded by the RFE instruction
- if the exception return is not performed by executing an RFE instruction, the value of the current **SPSR** at the time of the exception return

Where the exception return is UNPREDICTABLE, the implementation can adjust the value loaded into the **CPSR**, to avoid a security hole, or other undesirable behavior. For example:

- In an implementation that includes the Security Extensions, if the processor is in a Non-secure PL1 mode, and one of the following applies:
  - The restored **CPSR.M** value is 0b10110, the value for Monitor mode.
  - **NSACR.RFR** is set to 1, and the restored **CPSR.M** value is 0b10001, the value for FIQ mode.

———— **Note** —————

When **NSACR.RFR** is set to 1, FIQ mode is reserved for Secure operation.

- If the implementation includes the Virtualization Extensions, and the restored **CPSR.M** value is 0b11010, the value for Hyp mode.

In this case, **CPSR.M** takes an UNKNOWN value that does not correspond to any of:

- Hyp mode
- Monitor mode
- if **NSACR.RFR** is set to 1, FIQ mode.

- In an implementation that includes the Virtualization Extensions, if the processor is in the Non-secure PL2 mode and one of the following applies:
  - the restored **CPSR.M** value is 0b10110, the value for Monitor mode
  - **NSACR.RFR** is set to 1 and the restored **CPSR.M** value is 0b10001, the value for FIQ mode.

In this case, **CPSR.M** takes an UNKNOWN value that does not correspond to either:

- Monitor mode
- if **NSACR.RFR** is set to 1, FIQ mode.

- In an implementation that includes the Virtualization Extensions, if **SCR.NS** is set to 0 and the restored **CPSR.M** value is 0b11010, the value for Hyp mode.

In this case, **CPSR.M** takes an UNKNOWN value that does not correspond to Hyp mode.

- If the new **CPSR.{J, T}** bits correspond to an unsupported instruction set, including an instruction set that is not supported in the mode of operation that applies immediately after the exception return, the **CPSR.{J, T}** bits might be set to values that correspond to a supported instruction set. For more information see [Exception return to an unimplemented instruction set state on page B1-1196](#).

An example of where this might happen is a return to Hyp mode with **CPSR.{J, T}** set to {1, 1}, the values for ThumbEE.

- If the new **CPSR.IT** bits correspond to a reserved value then **CPSR.IT** might be set to a permitted UNKNOWN value. For more information see [IT block state register, ITSTATE on page A2-51](#).

## Exception return instructions

The instructions that an exception handler can use to return from an exception depend on whether the exception was taken to a PL1 mode, or in a PL2 mode, see:

- [Return from an exception taken to a PL1 mode on page B1-1195](#)
- [Return from an exception taken to a PL2 mode on page B1-1195](#).

———— **Note** —————

The Thumb exception return instructions are all UNPREDICTABLE if executed in ThumbEE state.

### Return from an exception taken to a PL1 mode

For an exception taken to a PL1 mode, the ARM architecture provides the following *exception return instructions*:

- Data-processing instructions with the S bit set and the PC as a destination, see [SUBS PC, LR \(Thumb\)](#) on page B9-2008 and [SUBS PC, LR and related instructions \(ARM\)](#) on page B9-2010.  
Typically:
  - a return where no subtraction is required uses SUBS with an operand of 0, or the equivalent MOVS instruction
  - a return requiring subtraction uses SUBS with a nonzero operand.
- From ARMv6, the RFE instruction, see [RFE](#) on page B9-1998. If a subtraction is required, typically it is performed before saving the LR value to memory.
- In ARM state, a form of the LDM instruction, see [LDM \(exception return\)](#) on page B9-1984. If a subtraction is required, typically it is performed before saving the LR value to memory.

### Return from an exception taken to a PL2 mode

For an exception taken to a PL2 mode, the ARM architecture provides the ERET instruction, see [ERET](#) on page B9-1980. An exception handler executing in a PL2 mode must return using the ERET instruction.

Hyp mode is the only PL2 mode. Both Hyp mode and the ERET instruction are implemented only as part of the Virtualization Extensions.

### Alignment of exception returns

The {J, T} bits of the value transferred to the CPSR by an exception return control the target instruction set of that return. The behavior of the hardware for exception returns for different values of the {J, T} bits is as follows:

- {J, T} == 00** The target instruction set state is ARM state. Bits[1:0] of the address transferred to the PC are ignored by the hardware.
- {J, T} == 01** The target instruction set state is Thumb state:
  - bit[0] of the address transferred to the PC is ignored by the hardware
  - bit[1] of the address transferred to the PC is part of the instruction address.
- {J, T} == 10** The target instruction set state is Jazelle state. In a non-trivial implementation of the Jazelle extension, bits[1:0] of the address transferred to the PC are part of the instruction address. For the behavior in a trivial implementation of the Jazelle extension, see [Exception return to an unimplemented instruction set state](#) on page B1-1196. For details of the trivial implementation see [Trivial implementation of the Jazelle extension](#) on page B1-1244.
- {J, T} == 11** The target instruction set state is ThumbEE state:
  - bit[0] of the address transferred to the PC is ignored by the hardware
  - bit[1] of the address transferred to the PC is part of the instruction address.

ARM deprecates any dependence on the requirements that the hardware ignores bits of the address. ARM recommends that the address transferred to the PC for an exception return is correctly aligned for the target instruction set.

After an exception entry other than Reset, the LR value has the correct alignment for the instruction set indicated by the SPSR. {J, T} bits. This means that if exception return instructions are used with the LR and SPSR values produced by such an exception entry, the only precaution software needs to take to ensure correct alignment is that any subtraction is of a multiple of four if returning to ARM state, or a multiple of two if returning to Thumb state or to ThumbEE state.

## Exception return to an unimplemented instruction set state

An implementation that does not support one or both of Jazelle and ThumbEE states does not normally get into an unimplemented instruction set state, because:

- on a trivial Jazelle implementation, the BXJ instruction acts as a BX instruction
- on an implementation that does not include ThumbEE support, the ENTERX instruction is UNDEFINED
- normal exception entry and return preserves the instruction set state.

However, on some implementations, an exception return instruction might set `CPSR.{J, T}` to the values corresponding to an unimplemented instruction set state, see [Unimplemented instruction sets on page B1-1155](#). This is most likely to happen because a faulty exception handler restores the wrong value to the `CPSR`.

If the processor attempts to execute an instruction while the `CPSR.{J, T}` bits indicate an unimplemented instruction set state, an Undefined Instruction exception is taken. This happens if either:

- `CPSR.J == 1` and `CPSR.T == 1`, and the processor does not support ThumbEE state
- `CPSR.J == 1` and `CPSR.T == 0`, and the processor does not support Jazelle state.

The Undefined Instruction exception handler can detect the cause of this exception because on entry to the handler the `SPSR.{J, T}` bits indicate the unimplemented instruction set state. If the Undefined Instruction exception handler wants to return to a valid instruction set state it can change the values its exception return instruction writes to the `CPSR.{J, T}` bits.

If an exception return writes `CPSR.{J, T}` values that correspond to an unimplemented instruction set state, and also writes the address of an aborting memory location to the PC, it is IMPLEMENTATION DEFINED whether:

- the instruction fetch is attempted, and a Prefetch Abort exception is taken because the memory access aborts
- an Undefined Instruction exception is taken, without the instruction being fetched.

If an exception return writes `CPSR.{J, T}` values that correspond to an unimplemented instruction set, the width of the instruction fetch is an IMPLEMENTATION DEFINED value that is 1, 2 or 4 bytes.

An implementation that supports neither of the Jazelle and ThumbEE states can implement the J bits of the PSRs as RAZ/WI. On such an implementation, a return to an unimplemented instruction set state cannot occur.

### B1.8.11 Virtual exceptions in the Virtualization Extensions

The Virtualization Extensions introduce three virtual exceptions, that correspond to the physical asynchronous exceptions:

- Virtual Abort, that corresponds to a physical external asynchronous abort
- Virtual IRQ, that corresponds to a physical IRQ
- Virtual FIQ, that corresponds to a physical FIQ.

When the corresponding `HCR.{AMO, IMO, FMO}` bit is set to 1, a virtual exception is generated either:

- By setting a virtual interrupt pending, `HCR.{VA, VI, VF}`, to 1.
- For a Virtual IRQ or Virtual FIQ, by an IMPLEMENTATION DEFINED mechanism. This might be a signal from an interrupt controller, for example from a Virtual GIC, as defined by the *ARM Generic Interrupt Controller Architecture Specification*.

A virtual exception is taken only from a Non-secure PL1 or PL0 mode. In any other mode, if the exception is generated it is not taken.

A virtual exception is taken to Non-secure state in the default mode for the corresponding physical exception. This means:

- a Virtual Abort is taken to Non-secure Abort mode
- a Virtual IRQ is taken to Non-secure IRQ mode
- a Virtual FIQ is taken to Non-secure FIQ mode.



Table B1-20 summarizes the HCR bits that route asynchronous exceptions to Hyp mode, and the bits that generate the virtual exceptions.

**Table B1-20 HCR bits controlling asynchronous exceptions**

Exception	Routing the physical exception to Hyp mode	Generating the virtual exception
Asynchronous abort	HCR.AMO	HCR.VA
IRQ	HCR.IMO	HCR.VI
FIQ	HCR.FMO	HCR.VF

The HCR.{AMO, IMO, FMO} bits route the corresponding physical exception to Hyp mode only if the physical exception is not routed to Monitor mode by the SCR.{EA, IRQ, FIQ} bit. Similarly, the HCR.{VA, VI, VF} bits generate a virtual exception only if set to 1 when the corresponding HCR.{AMO, IMO, FMO} is set to 1. For more information, see *Asynchronous exception behavior, with the Virtualization Extensions* on page B1-1187.

When an HCR.{AMO, IMO, FMO} control bit is set to 1, the corresponding mask bit in the CPSR:

- does not mask the physical exception
- masks the virtual exception, if the processor is executing in a Non-secure PL1 or PL0 mode.

Taking a Virtual Abort exception clears HCR.VA to zero. Taking a Virtual IRQ exception or a Virtual FIQ exception does not affect the value of HCR.VI or HCR.VF.

———— **Note** —————

This means that the exception handler for a Virtual IRQ exception or a Virtual FIQ exception must cause software executing in Hyp mode, or in Monitor mode, to update the HCR to clear the appropriate virtual exception bit to 0.

See *WFE wake-up events* on page B1-1200 and *Wait For Interrupt* on page B1-1202 for information about how virtual exceptions affect wake up from power-saving states.

———— **Note** —————

A hypervisor can use virtual exceptions to signal exceptions to the current Guest OS. The Guest OS takes a virtual exception exactly as it would take the corresponding physical exception, and is unaware of any distinction between virtual exceptions and the corresponding physical exceptions.

### B1.8.12 Low interrupt latency configuration

Setting SCTLR.FI to 1 enables the low interrupt latency configuration of an implementation. This configuration can reduce the interrupt latency of the processor. The mechanisms implemented to achieve low interrupt latency are IMPLEMENTATION DEFINED. For the description of the SCTLR see either:

- *SCTLR, System Control Register, VMSA* on page B4-1705
- *SCTLR, System Control Register, PMSA* on page B6-1930.

In an implementation that includes the Virtualization Extensions, the HSCTLR.FI bit is a RO bit that indicates the current value of SCTLR.FI.

To ensure that a change between normal and low interrupt latency configurations is synchronized correctly, the SCTLR.FI bit must be changed only in IMPLEMENTATION DEFINED circumstances. The FI bit can be changed shortly after reset, with interrupts disabled, and before enabling any MMU, MPU, or cache, using the following sequence:

```

DSB
ISB
MCR p15, 0, Rx, c1, c0, c0 ; change FI bit in the SCTLR
DSB
ISB

```

An implementation can define other sequences and circumstances that permit the SCTLR.FI bit to be changed.

---

**Note**

- Examples of methods that might be implemented to reduce interrupt latency are:
    - disabling Hit-Under-Miss functionality in a processor
    - the abandoning of restartable external accesses.These choices permit the processor to react to a pending interrupt faster than would otherwise be the case.
  - Reducing interrupt latency can result in reduced performance overall.
- 

A low interrupt latency configuration might permit interrupts and asynchronous aborts to be taken during a sequence of memory transactions generated by a single load or store instruction. For details of what these sequences are and the consequences of taking interrupts and asynchronous aborts in this way see [Single-copy atomicity on page A3-127](#).

ARM deprecates any software reliance on the behavior that an interrupt or asynchronous abort cannot occur in a sequence of memory transactions generated by a single load or store instruction that accesses Normal memory.

---

**Note**

A particular case that has shown this reliance is load multiples that load the stack pointer from memory. In an implementation where an interrupt is taken during the LDM, this can corrupt the stack pointer.

---

### B1.8.13 Wait For Event and Send Event

ARMv7 and ARMv6K provide a mechanism, the Wait For Event mechanism, that permits a processor in a multiprocessor system to request entry to a low-power state, and, if the request succeeds, to remain in that state until it receives an event generated by a Send Event operation on another processor in the system. [Example B1-1](#) describes how a spinlock implementation might use this mechanism to save energy.

#### Example B1-1 Spinlock as an example of using Wait For Event and Send Event

---

A multiprocessor operating system requires locking mechanisms to protect data structures from being accessed simultaneously by multiple processors. These mechanisms prevent the data structures becoming inconsistent or corrupted if different processors try to make conflicting changes. If a lock is busy, because a data structure is being used by one processor, it might not be practical for another processor to do anything except wait for the lock to be released. For example, if a processor is handling an interrupt from a device it might need to add data received from the device to a queue. If another processor is removing data from the queue, it will have locked the memory area that holds the queue. The first processor cannot add the new data until the queue is in a consistent state and the lock has been released. It cannot return from the interrupt handler until the data has been added to the queue, so it must wait.

Typically, a spin-lock mechanism is used in these circumstances:

- A processor requiring access to the protected data attempts to obtain the lock using single-copy atomic synchronization primitives such as the Load-Exclusive and Store-Exclusive operations described in [Synchronization and semaphores on page A3-114](#).
- If the processor obtains the lock it performs its memory operation and releases the lock.
- If the processor cannot obtain the lock, it reads the lock value repeatedly in a tight loop until the lock becomes available. At this point it again attempts to obtain the lock.

A spin-lock mechanism is not ideal for all situations:

- in a low-power system the tight read loop is undesirable because it uses energy to no effect
- in a multi-threaded processor the execution of spin-locks by waiting threads can significantly degrade overall performance.

Using the Wait For Event and Send Event mechanism can improve the energy efficiency of a spinlock. In this situation, a processor that fails to obtain a lock can execute a Wait For Event instruction, WFE, to request entry to a low-power state. When a processor releases a lock, it must execute a Send Event instruction, SEV, causing any waiting processors to wake up. Then, these processors can attempt to gain the lock again.

---

The Virtualization Extensions provide a bit that traps to Hyp mode any attempt to enter a low-power state from a Non-secure PL1 or PL0 mode. For more information see [Trapping use of the WFI and WFE instructions on page B1-1255](#).

The architecture does not define the exact nature of the low power state, but the execution of a WFE instruction must not cause a loss of memory coherency.

———— **Note** —————

Although a complex operating system can contain thousands of distinct locks, the event sent by this mechanism does not indicate which lock has been released. If the event relates to a different lock, or if another processor acquires the lock more quickly, the processor fails to acquire the lock and can re-enter the low-power state waiting for the next event.

---

The Wait For Event system relies on hardware and software working together to achieve energy saving:

- the hardware provides the mechanism to enter the Wait For Event low-power state

- the operating system software is responsible for issuing:
  - a Wait For Event instruction, to request entry to the low-power state, used in the example when waiting for a spin-lock
  - a Send Event instruction, required in the example when releasing a spin-lock.

The mechanism depends on the interaction of:

- WFE wake-up events, see [WFE wake-up events](#)
- the Event Register, see [The Event Register](#)
- the Send Event instruction, see [The Send Event instruction on page B1-1201](#)
- the Wait For Event instruction, see [The Wait For Event instruction on page B1-1201](#).

## WFE wake-up events

The following events are *WFE wake-up events*:

- the execution of an SEV instruction on any processor in the multiprocessor system
- a physical IRQ interrupt, unless masked by the [CPSR.I](#) bit
- a physical FIQ interrupt, unless masked by the [CPSR.F](#) bit
- a physical asynchronous abort, unless masked by the [CPSR.A](#) bit
- in Non-secure state in any mode other than Hyp mode:
  - when [HCR.IMO](#) is set to 1, a virtual IRQ interrupt, unless masked by the [CPSR.I](#) bit
  - when [HCR.FMO](#) is set to 1, a virtual FIQ interrupt, unless masked by the [CPSR.F](#) bit
  - when [HCR.AMO](#) is set to 1, a virtual asynchronous abort, unless masked by the [CPSR.A](#) bit
- an asynchronous debug event, if invasive debug is enabled and the debug event is permitted
- an event sent by the timer event stream, see [Event streams on page B8-1962](#)
- an event sent by some IMPLEMENTATION DEFINED mechanism.

In addition to the possible masking of WFE wake-up events shown in this list, when invasive debug is enabled and [DBGDSCR\[15:14\]](#) is not set to `0b00`, [DBGDSCR.INTdis](#) can mask interrupts, including masking them acting as WFE wake-up events. For more information, see [DBGDSCR, Debug Status and Control Register on page C11-2241](#).

As shown in the list of wake-up events, an implementation can include IMPLEMENTATION DEFINED hardware mechanisms to generate wake-up events.

### ————— Note —————

For more information about [CPSR](#) masking see [Asynchronous exception masking on page B1-1183](#). If the configuration of the masking controls provided by the Security Extensions, or Virtualization Extensions, mean that a [CPSR](#) mask bit cannot mask the corresponding exception, then the physical exception is a WFE wake-up event, regardless of the value of the [CPSR](#) mask bit.

## The Event Register

The Event Register is a single bit register for each processor. When set, an event register indicates that an event has occurred, since the register was last cleared, that might require some action by the processor. Therefore, the processor must not suspend operation on issuing a WFE instruction.

The reset value of the Event Register is UNKNOWN.

The Event Register is set by:

- an SEV instruction
- an event sent by some IMPLEMENTATION DEFINED mechanism
- a debug event that causes entry into Debug state
- an exception return.

As shown in this list, the Event Register might be set by IMPLEMENTATION DEFINED mechanisms.

The Event Register is cleared only by a Wait For Event instruction.

Software cannot read or write the value of the Event Register directly.

### The Send Event instruction

The Send Event instruction, SEV, causes an event to be signaled to all processors in the multiprocessor system. The mechanism that signals the event to the processors is IMPLEMENTATION DEFINED. Hardware does not guarantee the ordering of this event with respect to the completion of memory accesses by instructions before the SEV instruction. Therefore, ARM recommends that software includes a DSB instruction before an SEV instruction.

#### ———— Note —————

A DSB instruction ensures that no instruction, including any SEV instruction, that appears in program order after the DSB instruction, can execute until the DSB instruction has completed. For more information, see [Data Synchronization Barrier \(DSB\) on page A3-152](#).

Execution of the Send Event instruction sets the Event Register.

The Send Event instruction is available at all privilege levels, see [SEV on page A8-606](#).

### The Wait For Event instruction

The action of the Wait For Event instruction depends on the state of the Event Register:

- If the Event Register is set, the instruction clears the register and completes immediately. Normally, if this happens the software makes another attempt to claim the lock.
- If the Event Register is clear the processor can suspend execution and enter a low-power state. It can remain in that state until the processor detects a WFE wake-up event or a reset. When the processor detects a WFE wake-up event, or earlier if the implementation chooses, the WFE instruction completes.

The Wait For Event instruction, WFE, is available at all privilege levels, see [WFE on page A8-1104](#).

Software using the Wait For Event mechanism must tolerate spurious wake-up events, including multiple wake ups.

The Virtualization Extensions provide a bit that traps to Hyp mode any attempt to enter a low-power state from a Non-secure PL1 or PL0 mode. For more information see [Trapping use of the WFI and WFE instructions on page B1-1255](#).

### Pseudocode details of the Wait For Event lock mechanism

This section defines pseudocode functions that describe the operation of the Wait For Event mechanism.

The ClearEventRegister() pseudocode procedure clears the Event Register of the current processor.

The EventRegistered() pseudocode function returns TRUE if the Event Register of the current processor is set and FALSE if it is clear:

```
boolean EventRegistered()
```

The WaitForEvent() pseudocode procedure optionally suspends execution until a WFE wake-up event or reset occurs, or until some earlier time if the implementation chooses. It is IMPLEMENTATION DEFINED whether restarting execution after the period of suspension causes a ClearEventRegister() to occur.

The SendEvent() pseudocode procedure sets the Event Register of every processor in the multiprocessor system.

## B1.8.14 Wait For Interrupt

ARMv7 supports Wait For Interrupt through an instruction, WFI, that is provided in the ARM and Thumb instruction sets. For more information, see [WFI on page A8-1106](#).

---

### Note

ARMv7 redefines the CP15 c7 encoding previously used for WFI as UNPREDICTABLE, see [Retired operations on page B3-1499](#) and [Retired operations on page B5-1802](#).

---

When a processor issues a WFI instruction it can suspend execution and enter a low-power state.

The Virtualization Extensions provide a bit that traps to Hyp mode any attempt to enter a low-power state from a Non-secure PL1 or PL0 mode. For more information see [Trapping use of the WFI and WFE instructions on page B1-1255](#).

The processor can remain in the WFI low-power state until it is reset, or it detects one of the following *WFI wake-up events*:

- a physical IRQ interrupt, regardless of the value of the [CPSR.I](#) bit
- a physical FIQ interrupt, regardless of the value of the [CPSR.F](#) bit
- a physical asynchronous abort, regardless of the value of the [CPSR.A](#) bit
- in Non-secure state in any mode other than Hyp mode:
  - when [HCR.IMO](#) is set to 1, a virtual IRQ interrupt, regardless of the value of the [CPSR.I](#) bit
  - when [HCR.FMO](#) is set to 1, a virtual FIQ interrupt, regardless of the value of the [CPSR.F](#) bit
  - when [HCR.AMO](#) is set to 1, a virtual asynchronous abort, regardless of the value of the [CPSR.A](#) bit
- an asynchronous debug event, when invasive debug is enabled and the debug event is permitted.

An implementation can include other IMPLEMENTATION DEFINED hardware mechanisms to generate WFI wake-up events.

When the hardware detects a WFI wake-up event, or earlier if the implementation chooses, the WFI instruction completes.

WFI wake-up events cannot be masked by the mask bits in the [CPSR](#).

The architecture does not define the exact nature of the low power state, but the execution of a WFI instruction must not cause a loss of memory coherency.

---

### Note

- Because debug events are WFI wake-up events, ARM strongly recommends that Wait For Interrupt is used as part of an idle loop rather than waiting for a single specific interrupt event to occur and then moving forward. This ensures the intervention of debug while waiting does not significantly change the function of the program being debugged.
  - In some previous implementations of Wait For Interrupt, the idle loop is followed by exit functions that must be executed before taking the interrupt. The operation of Wait For Interrupt remains consistent with this model, and therefore differs from the operation of Wait For Event.
  - Some implementations of Wait For Interrupt drain down any pending memory activity before suspending execution. This increases the power saving, by increasing the area over which clocks can be stopped. The ARM architecture does not require this operation, and software must not rely on Wait For Interrupt operating in this way.
-

## Using WFI to indicate an idle state on bus interfaces

A common implementation practice is to complete any entry into powerdown routines with a WFI instruction. Typically, the WFI instruction:

1. Forces the suspension of execution, and of all associated bus activity.
2. Suspends the execution of instructions by the processor.

The control logic required to do this tracks the activity of the bus interfaces of the processor. This means it can signal to an external power controller that there is no ongoing bus activity.

However, the processor must continue to process memory-mapped and external debug interface accesses to debug registers when in the WFI state. The indication of idle state to the system normally only applies to the functional interfaces of the processor, not the debug interfaces.

On an implementation that includes v7.1 Debug, when `DBGPRSR.DLK`, the OS Double Lock status bit, is set to 1, the processor must not signal this idle state to the processor unless it can guarantee, also, that the debug interface is idle. For more information about OS Double Lock, see [Permissions in relation to locks on page C6-2118](#).

---

### Note

In a processor that implements separate core and debug power domains, the debug interface referred to in this section is the interface between the core and debug power domains, since the signal to the power controller indicates that the core power domain is idle. For more information about the power domains see [Power domains and debug on page C7-2149](#).

---

The exact nature of this interface is IMPLEMENTATION DEFINED, but the use of Wait For Interrupt as the only architecturally-defined mechanism that completely suspends execution makes it very suitable as the preferred powerdown entry mechanism.

## Pseudocode details of Wait For Interrupt

The `WaitForInterrupt()` pseudocode procedure optionally suspends execution until a WFI wake-up event or reset occurs, or until some earlier time if the implementation chooses.

## B1.9 Exception descriptions

[Exception handling on page B1-1164](#) gives general information about exception handling. This section describes each of the exceptions, in the following subsections:

- [Reset](#)
- [Undefined Instruction exception on page B1-1205](#)
- [Hyp Trap exception on page B1-1208](#)
- [Supervisor Call \(SVC\) exception on page B1-1209](#)
- [Secure Monitor Call \(SMC\) exception on page B1-1210](#)
- [Hypervisor Call \(HVC\) exception on page B1-1211](#)
- [Prefetch Abort exception on page B1-1212](#)
- [Data Abort exception on page B1-1214](#)
- [Virtual Abort exception on page B1-1217](#)
- [IRQ exception on page B1-1218](#)
- [Virtual IRQ exception on page B1-1220](#)
- [FIQ exception on page B1-1221](#)
- [Virtual FIQ exception on page B1-1222](#).

[Additional pseudocode functions for exception handling on page B1-1223](#) gives additional pseudocode that is used in the pseudocode descriptions of a number of the exceptions.

### B1.9.1 Reset

On an ARM processor, when the Reset input is asserted the processor stops execution. When Reset is deasserted, the processor then starts executing instructions:

- in Secure state, if it implements the Security Extensions
- in Supervisor mode, with interrupts disabled.

Reset returns some processor state to architecturally-defined or IMPLEMENTATION DEFINED values, and makes other state UNKNOWN. For more information see:

- for a VMSAv7 implementation:
  - [Behavior of the caches at reset on page B2-1269](#)
  - [Enabling MMUs on page B3-1316](#)
  - [TLB behavior at reset on page B3-1379](#)
  - [Reset behavior of CP14 and CP15 registers on page B3-1450](#)
- For a PMSAv7 implementation:
  - [Behavior of the caches at reset on page B2-1269](#)
  - [Enabling and disabling the MPU on page B5-1756](#)
  - [Reset behavior of CP14 and CP15 registers on page B5-1776](#).

When reset is deasserted, execution starts either:

- From the low or high reset vector address, `0x00000000` or `0xFFFF0000`, as determined by the reset value of the `SCTLR.V` bit. This reset value can be determined by an IMPLEMENTATION DEFINED configuration input signal.
- From an IMPLEMENTATION DEFINED address.

When executions starts, system behavior depends on the reset value of the `CPSR`, as defined by the `TakeReset()` pseudocode function that is defined later in this section. See also [The Current Program Status Register \(CPSR\) on page B1-1147](#).

The ARM architecture does not define any way of returning to a previous execution state from a reset.



---

**Note**

- A Reset exception does not reset the value of all of the debug registers. For more information see [Reset and debug on page C7-2160](#).
  - The ARM architecture does not distinguish between multiple levels of reset. A system can provide multiple distinct levels of reset that reset different parts of the system. These all correspond to this single reset exception.
- 

### Pseudocode description of taking the Reset exception

The TakeReset() pseudocode procedure describes how the processor takes the exception:

```
// TakeReset()
// =====

TakeReset()
  // Enter Supervisor mode and (if relevant) Secure state, and reset CP15. This affects
  // the Banked versions and values of various registers accessed later in the code.
  // Also reset other system components.
  CPSR.M = '10011'; // Supervisor mode
  if HaveSecurityExt() then SCR.NS = '0';
  ResetControlRegisters();
  if HaveAdvSIMDorVFP() then FPEXC.EN = '0'; SUBARCHITECTURE_DEFINED further resetting;
  if HaveThumbEE() then TEECR.XED = '0';
  if HaveJazelle() then JMCR.JE = '0'; SUBARCHITECTURE_DEFINED further resetting;

  // Further CPSR changes: all interrupts disabled, IT state reset, instruction set
  // and endianness according to the SCTRLR values produced by the above call to
  // ResetControlRegisters().
  CPSR.I = '1'; CPSR.F = '1'; CPSR.A = '1';
  CPSR.IT = '00000000';
  CPSR.J = '0'; CPSR.T = SCTRLR.TE; // TE=0: ARM, TE=1: Thumb
  CPSR.E = SCTRLR.EE; // EE=0: little-endian, EE=1: big-endian

  // All registers, bits and fields not reset by the above pseudocode or by the
  // BranchTo() call below are UNKNOWN bitstrings after reset. In particular, the
  // return information registers R14_svc and SPSR_svc have UNKNOWN values, so that
  // it is impossible to return from a reset in an architecturally defined way.

  // Branch to Reset vector.
  BranchTo(ExcVectorBase() + 0);
```

### B1.9.2 Undefined Instruction exception

An Undefined Instruction exception might be caused by:

- A coprocessor instruction that is not accessible because of the settings in one or more of:
  - the CPACR, see [CPACR, Coprocessor Access Control Register, VMSA on page B4-1551](#), or [CPACR, Coprocessor Access Control Register, PMSA on page B6-1829](#)
  - in an implementation that includes the Security Extensions, the [NSACR](#)
  - in an implementation that includes the Virtualization Extensions, when the processor is in Hyp mode, the [HCPTR](#).
- A coprocessor instruction that is not implemented.
- A coprocessor instruction that causes an exception during execution, for example a trapped floating-point exception on a floating-point instruction, see [Floating-point exceptions on page A2-70](#).
- An instruction that is UNDEFINED.
- An attempt to execute an instruction in an unimplemented instruction set state, see [Exception return to an unimplemented instruction set state on page B1-1196](#).

- Division by zero in an SDIV or UDIV instruction, in an ARMv7-R implementation when the SCTL.R.DZ bit is set to 1.

———— **Note** —————

In an ARMv7-A implementation that includes the SDIV and UDIV instructions, division by zero always returns a result of zero, see *ARMv7 implementation requirements and options for the divide instructions on page A4-172*.

By default, an Undefined Instruction exception is taken to Undefined mode, but an Undefined Instruction exception can be taken to Hyp mode, see *Determining the mode to which the Undefined Instruction exception is taken on page B1-1175*.

The Undefined Instruction exception can provide:

- signaling of:
  - an illegal instruction execution
  - division by zero errors, in the ARMv7-R profile
- software emulation of a coprocessor in a system that does not have the physical coprocessor hardware
- *lazy context switching* of coprocessor registers
- general-purpose instruction set extension by software emulation.

In some coprocessor designs, an internal exceptional condition caused by one coprocessor instruction is signaled asynchronously by refusing to respond to a later coprocessor instruction that belongs to the same coprocessor. In these circumstances, the Undefined Instruction exception handler must take whatever action is needed to clear the exceptional condition, and then return to the second coprocessor instruction.

———— **Note** —————

The only mechanism to determine the cause of an Undefined Instruction exception that is taken to Undefined mode is analysis of the instruction indicated by the return link in the LR on exception entry. Therefore it is important that a coprocessor only reports exceptional conditions by generating Undefined Instruction exceptions on its own coprocessor instructions.

The preferred return address for an Undefined Instruction exception is the address of the instruction that generated the exception. This return is performed as follows:

- If returning from Secure or Non-secure Undefined mode, the exception return uses the SPSR and LR\_und values generated by the exception entry, as follows:
  - If SPSR.{J, T} are both 0, indicating that the exception occurred in ARM state, the return uses an exception return instruction with a subtraction of 4.
  - If SPSR.T is 1, indicating that the exception occurred in Thumb state or ThumbEE state, the return uses an exception return instruction with a subtraction of 2
  - If SPSR.J is 1 and SPSR.T is 0, indicating that the exception occurred in Jazelle state, then exception return is not possible. For more information see *Undefined Instruction exception in Jazelle state on page B1-1207*.
- If returning from Hyp mode, the exception return is performed by an ERET instruction, using the SPSR and ELR\_hyp values generated by the exception entry.

For more information, see *Exception return on page B1-1193*.

———— **Note** —————

If handling the Undefined Instruction exception requires instruction emulation, followed by return to the next instruction after the instruction that caused the exception, the instruction emulator must use the instruction length to calculate the correct return address, and to calculate the updated values of the IT bits if necessary.

## Pseudocode description of taking the Undefined Instruction exception

The TakeUndefInstrException() pseudocode procedure describes how the processor takes the exception:

```
// TakeUndefInstrException()
// =====

TakeUndefInstrException()
  // Determine return information. SPSR is to be the current CPSR, and LR is to be the
  // current PC minus 2 for Thumb or 4 for ARM, to change the PC offsets of 4 or 8
  // respectively from the address of the current instruction into the required return
  // address offsets of 2 or 4 respectively.
  new_lr_value = if CPSR.T == '1' then PC-2 else PC-4;
  new_spsr_value = CPSR;
  vect_offset = 4;

  // Check whether to take exception to Hyp mode
  // if in Hyp mode then stay in Hyp mode
  take_to_hyp = HaveVirtExt() && HaveSecurityExt() && SCR.NS == '1' && CPSR.M == '11010';
  // if HCR.TGE is set, take to Hyp mode through Hyp Trap vector
  route_to_hyp = (HaveVirtExt() && HaveSecurityExt() && !IsSecure() && HCR.TGE == '1'
    && CPSR.M == '10000'); // User mode
  // if HCR.TGE == '1' and in a Non-secure PL1 mode, the effect is UNPREDICTABLE

  return_offset = if CPSR.T == '1' then 2 else 4;
  preferred_exceptn_return = new_lr_value - return_offset;
  if take_to_hyp then
    // Note that whatever called TakeUndefInstrException() will have set the HSR
    EnterHypMode(new_spsr_value, preferred_exceptn_return, vect_offset);
  elseif route_to_hyp then
    // Note that whatever called TakeUndefInstrException() will have set the HSR
    EnterHypMode(new_spsr_value, preferred_exceptn_return, 20);
  else
    // Enter Undefined ('11011') mode, and ensure Secure state if initially in Monitor
    // ('10110') mode. This affects the Banked versions of various registers accessed later
    // in the code.
    if CPSR.M == '10110' then SCR.NS = '0';
    CPSR.M = '11011';

    // Write return information to registers, and make further CPSR changes:
    // IRQs disabled, IT state reset, instruction set and endianness set to
    // SCTLr-configured values.
    SPSR[] = new_spsr_value;
    R[14] = new_lr_value;
    CPSR.I = '1';
    CPSR.IT = '00000000';
    CPSR.J = '0'; CPSR.T = SCTLr.TE; // TE=0: ARM, TE=1: Thumb
    CPSR.E = SCTLr.EE; // EE=0: little-endian, EE=1: big-endian

    // Branch to Undefined Instruction vector.
    BranchTo(ExcVectorBase() + vect_offset);
```

*Additional pseudocode functions for exception handling on page B1-1223* defines the EnterHypMode() pseudocode procedure.

## Undefined Instruction exception in Jazelle state

The architecture does not define any behavior that requires a processor to take an Undefined Instruction exception when it is operating in Jazelle state. However, on some implementations the processor might take an Undefined Instruction exception as a result of UNPREDICTABLE behavior, for example attempting instruction execution in Jazelle state on a possible trivial implementation of the Jazelle extension, see *Exception return to an unimplemented instruction set state on page B1-1196*. If the processor takes such an Undefined Instruction exception in Jazelle state, exception entry sets the LR to an UNKNOWN value.

## Conditional execution of undefined instructions

The conditional execution rules described in [Conditional execution on page A8-288](#) apply to all instructions. This includes undefined instructions and other instructions that would cause entry to the Undefined Instruction exception.

If such an instruction fails its condition check, the behavior depends on the architecture profile and the potential cause of entry to the Undefined Instruction exception, as follows:

- In the ARMv7-A profile:
  - If the potential cause is the execution of the instruction itself and depends on data values used by the instruction, the instruction executes as a NOP and does not cause an Undefined Instruction exception.
  - If the potential cause is the execution of an earlier coprocessor instruction, or the execution of the instruction itself without dependence on the data values used by the instruction, it is IMPLEMENTATION DEFINED whether the instruction executes as a NOP or causes an Undefined Instruction exception. An implementation must handle all such cases in the same way.
- In the ARMv7-R profile, the instruction executes as a NOP and does not cause an Undefined Instruction exception.

### ———— Note ————

Before ARMv7, all implementations executed any instruction that failed its condition check as a NOP, even if it would otherwise have caused an Undefined Instruction exception. An Undefined Instruction handler written for these implementations might assume without checking that the undefined instruction passed its condition check. Such an Undefined Instruction handler is likely to need rewriting, to check the condition is passed, before it functions correctly on all ARMv7-A implementations.

## Interaction of UNPREDICTABLE and UNDEFINED instruction behavior

If this manual describes an instruction as both UNPREDICTABLE and UNDEFINED then the instruction is UNPREDICTABLE.

### ———— Note ————

An example of this is where both:

- an instruction, or instruction class, is made UNDEFINED by some general principle, or by a configuration field
- a particular encoding of that instruction or instruction class is specified as UNPREDICTABLE.

### B1.9.3 Hyp Trap exception

The Hyp Trap exception is implemented only as part of the Virtualization Extensions.

A Hyp Trap exception is generated if the processor is running in a Non-secure mode other than Hyp mode, and commits for execution an instruction that is trapped to Hyp mode. Instruction traps are enabled by setting bits to 1 in the [HCR](#), [HCPTR](#), [HDCR](#), or [HSTR](#). For more information see [Traps to the hypervisor on page B1-1247](#).

A Hyp Trap exception is taken to Hyp mode.

The preferred return address for a Hyp Trap exception is the address of the trapped instruction. The exception return is performed by an ERET instruction, using the [SPSR](#) and [ELR\\_hyp](#) values generated by the exception entry.

### ———— Note ————

The [SPSR](#) and [ELR\\_hyp](#) values generated on exception entry can be used, without modification, for an exception return to re-execute the trapped instruction. If the exception handler emulates the trapped instruction, and must return to the following instruction, the emulation of the instruction must include modifying [ELR\\_hyp](#), and possibly updating [SPSR\\_hyp](#).

For related information, see [General information about traps to the hypervisor on page B1-1248](#).

## Pseudocode description of taking the Hyp Trap exception

The TakeHypTrapException() pseudocode procedure describes how the processor takes the exception:

```
// TakeHypTrapException()
// =====

TakeHypTrapException()
// A Hyp Trap exception is caused by executing an instruction that is trapped to Hyp mode as
// a result of a trap set by a bit in the HCR, HCPTR, HSTR or HDCR. By definition, it can
// only be generated in a Non-secure mode other than Hyp mode.
// Note that, when a Supervisor Call exception is taken to Hyp mode because HCR.TGE==1, this
// is not a trap of the SVC instruction. See the TakeSVCEXception() pseudocode for this case.
preferred_exceptn_return = if CPSR.T == '1' then PC-4 else PC-8;
new_spsr_value = CPSR;
EnterHypMode(new_spsr_value, preferred_exceptn_return, 20);
```

*Additional pseudocode functions for exception handling on page B1-1223* defines the EnterHypMode() pseudocode procedure.

### B1.9.4 Supervisor Call (SVC) exception

The Supervisor Call instruction, SVC, requests a supervisor function, causing the processor to enter Supervisor mode. Typically, the SVC instruction is executed to request an operating system function. For more information, see *SVC (previously SWI) on page A8-720*.

#### ————— Note —————

- In previous versions of the ARM architecture, the SVC instruction was called SWI, Software Interrupt.
- In an implementation that includes the Virtualization Extensions:
  - When an SVC instruction is executed in Hyp mode, the Supervisor Call exception is taken to Hyp mode. For more information see *SVC (previously SWI) on page A8-720*.
  - When the HCR.TGE bit is set to 1, the Supervisor Call exception generated by execution of an SVC instruction in Non-secure User mode is routed to Hyp mode. For more information, see *Supervisor Call exception, when HCR.TGE is set to 1 on page B1-1191*.

By default, a Supervisor Call exception is taken to Supervisor mode, but a Supervisor Call exception can be taken to Hyp mode, see *Determining the mode to which the Supervisor Call exception is taken on page B1-1176*.

The preferred return address for a Supervisor Call exception is the address of the next instruction after the SVC instruction. This return is performed as follows:

- if returning from Secure or Non-secure Supervisor mode, the exception return uses the SPSR and LR\_svc values generated by the exception entry, in an exception return instruction without subtraction
- if returning from Hyp mode, the exception return is performed by an ERET instruction, using the SPSR and ELR\_hyp values generated by the exception entry.

For more information, see *Exception return on page B1-1193*.

## Pseudocode description of taking the Supervisor Call exception

The TakeSVCEXception() pseudocode procedure describes how the processor takes the exception:

```
// TakeSVCEXception()
// =====

TakeSVCEXception()
// Determine return information. SPSR is to be the current CPSR, after changing the IT[]
// bits to give them the correct values for the following instruction, and LR is to be
// the current PC minus 2 for Thumb or 4 for ARM, to change the PC offsets of 4 or 8
// respectively from the address of the current instruction into the required address of
// the next instruction, the SVC instruction having size 2bytes for Thumb or 4 bytes for ARM.
```

```
ITAdvance();
new_lr_value = if CPSR.T == '1' then PC-2 else PC-4;
new_spsr_value = CPSR;
vect_offset = 8;

// Check whether to take exception to Hyp mode
// if in Hyp mode then stay in Hyp mode
take_to_hyp = (HaveVirtExt() && HaveSecurityExt() && SCR.NS == '1' && CPSR.M == '11010');
// if HCR.TGE is set to 1, take to Hyp mode through Hyp Trap vector
route_to_hyp = (HaveVirtExt() && HaveSecurityExt() && !IsSecure() && HCR.TGE == '1'
    && CPSR.M == '10000'); // User mode
// if HCR.TGE == '1' and in a Non-secure PL1 mode, the effect is UNPREDICTABLE

preferred_exceptn_return = new_lr_value;
if take_to_hyp then
    EnterHypMode(new_spsr_value, preferred_exceptn_return, vect_offset);
elseif route_to_hyp then
    EnterHypMode(new_spsr_value, preferred_exceptn_return, 20);
else
    // Enter Supervisor ('10011') mode, and ensure Secure state if initially in Monitor
    // ('10110') mode. This affects the Banked versions of various registers accessed later
    // in the code.
    if CPSR.M == '10110' then SCR.NS = '0';
    CPSR.M = '10011';

    // Write return information to registers, and make further CPSR changes: IRQs disabled,
    // IT state reset, instruction set and endianness set to SCTLR-configured values.
    SPSR[] = new_spsr_value;
    R[14] = new_lr_value;
    CPSR.I = '1';
    CPSR.IT = '00000000';
    CPSR.J = '0'; CPSR.T = SCTLR.TE; // TE=0: ARM, TE=1: Thumb
    CPSR.E = SCTLR.EE; // EE=0: little-endian, EE=1: big-endian

    // Branch to SVC vector.
    BranchTo(ExcVectorBase() + vect_offset);
```

*Additional pseudocode functions for exception handling on page B1-1223* defines the `EnterHypMode()` pseudocode procedure.

### B1.9.5 Secure Monitor Call (SMC) exception

The Secure Monitor Call exception is implemented only as part of the Security Extensions.

The Secure Monitor Call instruction, SMC, requests a Secure Monitor function, causing the processor to enter Monitor mode. For more information, see *SMC (previously SMI) on page B9-2000*.

#### ————— Note —————

- In previous versions of the ARM architecture, the SMC instruction was called SMI, Software Monitor Interrupt.
- In an implementation that includes the Virtualization Extensions, when the `HCR.TSC` bit is set to 1, execution of an SMC instruction in a Non-secure PL1 mode is trapped to Hyp mode, and therefore generates a Hyp Trap Exception. For more information see *Trapping use of the SMC instruction on page B1-1254*.

A Secure Monitor Call exception is taken to Monitor mode.

The preferred return address for a Secure Monitor Call exception is the address of the next instruction after the SMC instruction. This return is performed using the `SPSR` and `LR_mon` values generated by the exception entry, using an exception return instruction without a subtraction.

For more information, see *Exception return on page B1-1193*.

———— **Note** ————

The exception handler can return to the SMC instruction itself by returning using a subtraction of 4, without any adjustment to the `SPSR.IT[7:0]` bits. If it does this, the return occurs, then interrupts or external aborts might occur and be handled, then the SMC instruction is re-executed and another Secure Monitor Call exception occurs.

This relies on:

- the SMC instruction being used correctly, either outside an IT block or as the last instruction in an IT block, so that the `SPSR.IT[7:0]` bits indicate unconditional execution
- the Secure Monitor Call handler not changing the result of the original conditional execution test for the SMC instruction.

**Pseudocode description of taking the Secure Monitor Call exception**

The `TakeSMCException()` pseudocode procedure describes how the processor takes the exception:

```
// TakeSMCException()
// =====

TakeSMCException()
  // Determine return information. SPSR is to be the current CPSR, after changing the IT[]
  // bits to give them the correct values for the following instruction, and LR is to be
  // the current PC minus 0 for Thumb or 4 for ARM, to change the PC offsets of 4 or 8
  // respectively from the address of the current instruction into the required address of
  // the next instruction (with the SMC instruction always being 4 bytes in length).
  ITAdvance();
  new_lr_value = if CPSR.T == '1' then PC else PC-4;
  new_spsr_value = CPSR;
  vect_offset = 8;

  // Ensure Secure state if initially in Monitor mode.
  // This affects the Banked versions of various registers accessed later in the code.
  if CPSR.M == '10110' then SCR.NS = '0';

  EnterMonitorMode(new_spsr_value, new_lr_value, vect_offset);
```

*Additional pseudocode functions for exception handling on page B1-1223* defines the `EnterMonitorMode()` pseudocode procedure.

**B1.9.6 Hypervisor Call (HVC) exception**

The Hypervisor Call exception is implemented only as part of the Virtualization Extensions.

The Hypervisor Call instruction, HVC, requests a hypervisor function, causing the processor to enter Hyp mode. For more information, see *HVC on page B9-1982*. The instruction generates a Hypervisor Call exception that is taken to Hyp mode.

The preferred return address for a Hypervisor Call exception is the address of the next instruction after the HVC instruction. The exception return is performed by an ERET instruction, using the `SPSR` and `ELR_hyp` values generated by the exception entry.

For more information, see *Exception return on page B1-1193*.

Executing an HVC instruction transfers the immediate argument of the instruction to the `HSR`. The exception handler retrieves the argument from the `HSR`, and therefore does not have to access the original HVC instruction. For more information see *Use of the HSR on page B3-1424*.

## Pseudocode description of taking the Hypervisor Call exception

The TakeHVCEXception() pseudocode procedure describes how the processor takes the exception:

```
// TakeHVCEXception()
// =====

TakeHVCEXception()
// Determine return information. SPSR is to be the current CPSR, after changing the IT[]
// bits to give them the correct values for the following instruction, and LR is to be
// the current PC minus 0 for Thumb or 4 for ARM, to change the PC offsets of 4 or 8
// respectively from the address of the current instruction into the required address of
// the next instruction (with the HVC instruction always being 4 bytes in length).
ITAdvance();
preferred_exceptn_return = if CPSR.T == '1' then PC else PC-4;
new_spsr_value = CPSR;

// Enter Hyp mode. HVC pseudocode has checked that use of HVC is valid.
// Required vector offset depends on whether current mode is Hyp mode.
if CPSR.M == '11010' then
    EnterHypMode(new_spsr_value, preferred_exceptn_return, 8);
else
    EnterHypMode(new_spsr_value, preferred_exceptn_return, 20);
```

[Additional pseudocode functions for exception handling on page B1-1223](#) defines the EnterHypMode() pseudocode procedure.

### B1.9.7 Prefetch Abort exception

A Prefetch Abort exception can be generated by:

- A synchronous memory abort on an instruction fetch.

———— **Note** —————

Asynchronous aborts on instruction fetches are reported using the Data Abort exception, see [Data Abort exception on page B1-1214](#).

Prefetch Abort exception entry is synchronous to the instruction whose fetch aborted.

For more information about memory aborts see:

- [VMSA memory aborts on page B3-1395](#)
- [PMSA memory aborts on page B5-1763](#).

- A Breakpoint, Vector catch or BKPT instruction debug event, see [Debug exception on BKPT instruction, Breakpoint, or Vector catch debug events on page C4-2088](#).

———— **Note** —————

If an implementation fetches instructions speculatively, it must handle a synchronous abort on such an instruction fetch by:

- generating a Prefetch Abort exception only if the instruction would be executed in a simple sequential execution of the program
- ignoring the abort if the instruction would not be executed in a simple sequential execution of the program.

By default, a Prefetch Abort exception is taken to Abort mode, but a Prefetch Abort exception can be taken to Monitor mode, or Hyp mode. For more information, see [Determining the mode to which the Prefetch Abort exception is taken on page B1-1177](#).



The preferred return address for a Prefetch Abort exception is the address of the aborted instruction. This return is performed as follows:

- If returning from a PL1 mode, using the [SPSR](#) and LR values generated by the exception entry, using an exception return instruction with a subtraction of 4. This means using:
  - SPSR\_abt and LR\_abt if returning from Abort mode
  - SPSR\_mon and LR\_mon if returning from Monitor mode.
- If returning from Hyp mode, using the SPSR\_hyp and [ELR\\_hyp](#) values generated by the exception entry, using an ERET instruction.

For more information, see [Exception return on page B1-1193](#).

## Pseudocode description of taking the Prefetch Abort exception

The TakePrefetchAbortException() pseudocode procedure describes how the processor takes the exception:

```
// TakePrefetchAbortException()
// =====

TakePrefetchAbortException()
  // Determine return information. SPSR is to be the current CPSR, and LR is to be the
  // current PC minus 0 for Thumb or 4 for ARM, to change the PC offsets of 4 or 8
  // respectively from the address of the current instruction into the required address
  // of the current instruction plus 4.
  new_lr_value = if CPSR.T == '1' then PC else PC-4;
  new_spsr_value = CPSR;
  vect_offset = 12;
  preferred_exceptn_return = new_lr_value - 4;

  // Determine whether this is an external abort to be routed to Monitor mode.
  route_to_monitor = HaveSecurityExt() && SCR.EA == '1' && IsExternalAbort();

  // Check whether to take exception to Hyp mode
  // if in Hyp mode then stay in Hyp mode
  take_to_hyp = HaveVirtExt() && HaveSecurityExt() && SCR.NS == '1' && CPSR.M == '11010';
  // otherwise, check whether to take to Hyp mode through Hyp Trap vector
  route_to_hyp = (HaveVirtExt() && HaveSecurityExt() && !IsSecure() &&
    (SecondStageAbort() ||
      (DebugException() && HDCR.TDE == '1' && CPSR.M != '11010') ||
      (IsExternalAbort() && !IsAsyncAbort() && HCR.TGE == '1'
        && CPSR.M == '10000'))); // User mode
  // if HCR.TGE == '1' and in a Non-secure PL1 mode, the effect is UNPREDICTABLE

  if route_to_monitor then
    // Ensure Secure state if initially in Monitor ('10110') mode. This affects
    // the Banked versions of various registers accessed later in the code.
    if CPSR.M == '10110' then SCR.NS = '0';
    EnterMonitorMode(new_spsr_value, new_lr_value, vect_offset);
  elseif take_to_hyp then
    // Note that whatever called TakePrefetchAbortException() will have set the HSR
    EnterHypMode(new_spsr_value, preferred_exceptn_return, vect_offset);
  elseif route_to_hyp then
    // Note that whatever called TakePrefetchAbortException() will have set the HSR
    EnterHypMode(new_spsr_value, preferred_exceptn_return, 20);
  else
    // Handle in Abort mode. Ensure Secure state if initially in Monitor mode. This
    // affects the Banked versions of various registers accessed later in the code.
    if HaveSecurityExt() && CPSR.M == '10110' then SCR.NS = '0';
    CPSR.M = '10111'; // Abort mode

    // Write return information to registers, and make further CPSR changes:
    // IRQs disabled, other interrupts disabled if appropriate, IT state reset,
    // instruction set and endianness set to SCTLR-configured values.
    SPSR[] = new_spsr_value;
    R[14] = new_lr_value;
```

```
CPSR.I = '1';  
if !HaveSecurityExt() || HaveVirtExt() || SCR.NS == '0' || SCR.AW == '1' then  
    CPSR.A = '1';  
CPSR.IT = '00000000';  
CPSR.J = '0'; CPSR.T = SCTL.R.TE;           // TE=0: ARM, TE=1: Thumb  
CPSR.E = SCTL.R.EE;                       // EE=0: little-endian, EE=1: big-endian  
BranchTo(ExcVectorBase() + vect_offset);
```

[Additional pseudocode functions for exception handling on page B1-1223](#) defines the `EnterMonitorMode()` and `EnterHypMode()` pseudocode procedures.

## B1.9.8 Data Abort exception

A Data Abort exception can be generated by:

- A synchronous abort on a data read or write memory access. Exception entry is synchronous to the instruction that generated the memory access.
- An asynchronous abort. The memory access that caused the abort can be any of:
  - a data read or write access
  - an instruction fetch
  - in a VMSA memory system, a translation table access.

Exception entry occurs asynchronously, and is similar to an interrupt.

As described in [Asynchronous exception masking on page B1-1183](#), asynchronous aborts can be masked. When this happens, a generated asynchronous abort is not taken until it is not masked.

### ———— Note —————

There are no asynchronous internal aborts in ARMv7 and earlier architecture versions, so asynchronous aborts are always asynchronous external aborts.

- A Watchpoint debug event, see [Debug exception on Watchpoint debug event on page C4-2089](#).

### ———— Note —————

Data Abort exceptions generated by Watchpoint debug events can be either asynchronous or synchronous. However, the `CPSR.A` bit has no effect on the taking of such an exception, regardless of whether it is asynchronous.

By default, a Data Abort exception is taken to Abort mode, but a Data Abort exception can be taken to Monitor mode, or to Hyp mode. For more information see [Determining the mode to which the Data Abort exception is taken on page B1-1178](#).

For more information about memory aborts see:

- [VMSA memory aborts on page B3-1395](#)
- [PMSA memory aborts on page B5-1763](#).

The preferred return address for a Data Abort exception is the address of the instruction that generated the aborting memory access, or the address of the instruction following the instruction boundary at which an asynchronous Data Abort exception was taken. This return is performed as follows:

- If returning from a PL1 mode, using the `SPSR` and `LR` values generated by the exception entry, using an exception return instruction with a subtraction of 8. This means using:
  - `SPSR_abt` and `LR_abt` if returning from Abort mode
  - `SPSR_mon` and `LR_mon` if returning from Monitor mode.
- If returning from Hyp mode, using the `SPSR_hyp` and `ELR_hyp` values generated by the exception entry, using an `ERET` instruction.

For more information, see [Exception return on page B1-1193](#).

## Pseudocode description of taking the Data Abort exception

The TakeDataAbortException() pseudocode procedure describes how the processor takes the exception:

```
// TakeDataAbortException()
// =====

TakeDataAbortException()
// Determine return information. SPSR is to be the current CPSR, and LR is to be the
// current PC plus 4 for Thumb or 0 for ARM, to change the PC offsets of 4 or 8
// respectively from the address of the current instruction into the required address
// of the current instruction plus 8. For an asynchronous abort, the PC and CPSR are
// considered to have already moved on to their values for the instruction following
// the instruction boundary at which the exception occurred.

new_lr_value = if CPSR.T == '1' then PC+4 else PC;
new_spsr_value = CPSR;
vect_offset = 16;
preferred_exceptn_return = new_lr_value - 8;

// Determine whether this is an external abort to be routed to Monitor mode.
route_to_monitor = HaveSecurityExt() && SCR.EA == '1' && IsExternalAbort();

// Check whether to take exception to Hyp mode
// if in Hyp mode then stay in Hyp mode
take_to_hyp = HaveVirtExt() && HaveSecurityExt() && SCR.NS == '1' && CPSR.M == '11010';
// otherwise, check whether to take to Hyp mode through Hyp Trap vector
route_to_hyp = (HaveVirtExt() && HaveSecurityExt() && !IsSecure() &&
  (SecondStageAbort() || (CPSR.M != '11010' &&
    (IsExternalAbort() && IsAsyncAbort() && HCR.AMO == '1') ||
    (DebugException() && HCR.TDE == '1')) ||
    (CPSR.M == '10000' && HCR.TGE == '1' &&
      (IsAlignmentFault() || (IsExternalAbort() && !IsAsyncAbort()))));
// if HCR.TGE == '1' and in a Non-secure PL1 mode, the effect is UNPREDICTABLE

if route_to_monitor then
  // Ensure Secure state if initially in Monitor mode. This affects the Banked
  // versions of various registers accessed later in the code
  if CPSR.M == '10110' then SCR.NS = '0';
  EnterMonitorMode(new_spsr_value, new_lr_value, vect_offset);
elseif take_to_hyp then
  EnterHypMode(new_spsr_value, preferred_exceptn_return, vect_offset);
elseif route_to_hyp then
  EnterHypMode(new_spsr_value, preferred_exceptn_return, 20);

else
  // Handle in Abort mode. Ensure Secure state if initially in Monitor mode. This
  // affects the Banked versions of various registers accessed later in the code
  if HaveSecurityExt() && CPSR.M == '10110' then SCR.NS = '0';

  CPSR.M = '10111'; // Abort mode

  // Write return information to registers, and make further CPSR changes:
  // IRQs disabled, other interrupts disabled if appropriate,
  // IT state reset, instruction set and endianness set to SCTLr-configured values.
  SPSR[] = new_spsr_value;
  R[14] = new_lr_value;
  CPSR.I = '1';
  if !HaveSecurityExt() || HaveVirtExt() || SCR.NS == '0' || SCR.AW == '1' then
    CPSR.A = '1';
  CPSR.IT = '00000000';
  CPSR.J = '0'; CPSR.T = SCTLr.TE; // TE=0: ARM, TE=1: Thumb
  CPSR.E = SCTLr.EE; // EE=0: little-endian, EE=1: big-endian
  BranchTo(ExcVectorBase() + vect_offset);
```

*Additional pseudocode functions for exception handling on page B1-1223* defines the EnterMonitorMode() and EnterHypMode() pseudocode procedures.

## Effects of data-aborted instructions

An instruction that accesses data memory can modify memory by storing one or more values. If the execution of such an instruction generates a Data Abort exception, or causes Debug state entry because of a watchpoint set on the instruction, the value of each memory location that the instruction stores to is:

- unchanged for any location for which one of the following applies:
  - an MMU fault is generated
  - a Watchpoint is generated
  - an external abort is generated, if that external abort is taken synchronously
- UNKNOWN for any location for which no exception is generated.

If the access to a memory location generates an external abort that is taken asynchronously, it is outside the scope of the architecture to define the effect of the store on that memory location, because this depends on the system-specific nature of the external abort. However, in general, ARM recommends that such locations are unchanged.

For external aborts and Watchpoints, where in principle faulting could be identified at byte or halfword granularity, the size of a location in this definition is the size for which a memory access is single-copy atomic.

Instructions that access data memory can modify registers in the following ways:

- By loading values into one or more of the ARM core registers. The registers loaded can include the PC.
- By specifying *base register writeback*, in which the base register used in the address calculation has a modified value written to it. All instructions that support base register writeback have UNPREDICTABLE results if base register writeback is specified with the PC as the base register. Only ARM core registers other than the PC can be modified reliably in this way.
- By changing the value of one or more coprocessor registers either directly or indirectly, for example:
  - Executing an LDC instruction loads a coprocessor register *directly* from memory.
  - Executing an STC instruction that accesses `DBGDTRRXint` can have a side effect of changing `DBGDSCR.RXfull`. This means the STC instruction changes the value of `DBGDSCR` *indirectly*.
- By modifying the `CPSR`.

If the execution of such an instruction generates a synchronous Data Abort exception, the following rules determine the values left in these registers:

- On entry to the Data Abort exception handler:
  - the PC value is the Data Abort vector address, see [Exception vectors and the exception base address on page B1-1164](#)
  - the `LR_abt` value is determined from the address of the aborted instruction.Neither value is affected by the results of any load specified by the instruction.
- The base register is restored to its original value if either:
  - the aborted instruction is a load and the list of registers to be loaded includes the base register
  - the base register is being written back.
- If the instruction only loads one ARM core register, the value in that register is unchanged.
- If the instruction loads more than one ARM core register, UNKNOWN values are left in destination registers other than the PC and the base register of the instruction.
- If the instruction affects any coprocessor registers, UNKNOWN values are left in the coprocessor registers that are affected.
- `CPSR` bits that are not defined as updated on exception entry retain their current value.
- If the instruction is a STREX, STREXB, STREXH, or STREXD, `<Rd>` is not updated.

After taking a Data Abort exception, the state of the exclusive monitors is UNKNOWN. Therefore, ARM strongly recommends that the abort handler performs a CLREX instruction, or a dummy STREX instruction, to clear the exclusive monitor state.

### The ARM abort model

The abort model used by an ARM processor implementation is described as a *Base Restored Abort Model*. This means that if a synchronous Data Abort exception is generated by executing an instruction that specifies base register writeback, the value in the base register is unchanged.

———— **Note** —————

In versions of the ARM architecture before ARMv6, it is IMPLEMENTATION DEFINED whether the abort model used is the *Base Restored Abort Model* or the *Base Updated Abort Model*. For more information, see [The ARM abort model on page AppxO-2602](#).

The abort model applies uniformly across all instructions.

## B1.9.9 Virtual Abort exception

The Virtual Abort exception is implemented only as part of the Virtualization Extensions.

A Virtual Abort exception is generated if all of the following apply:

- the processor is in a Non-secure mode other than Hyp mode
- [HCR.AMO](#) is set to 1
- [HCR.VA](#) is set to 1
- [CPSR.A](#) is set to 0.

The conditions for generating a Virtual Abort exception mean the exception is always:

- taken from a Non-secure PL1 or PL0 mode
- taken to Non-secure Abort mode.

For more information see [Virtual exceptions in the Virtualization Extensions on page B1-1196](#).

———— **Note** —————

Because the Virtual Abort exception is always taken to Non-secure Abort mode, on exception entry the preferred return address is always saved to LR\_abt.

The preferred return address for a Virtual Abort exception is the address of the instruction immediately after the instruction boundary where the exception was taken. This return is performed using the [SPSR](#) and LR\_abt values generated by the exception entry, using an exception return instruction without subtraction.

### Pseudocode description of taking the Virtual Abort exception

The TakeVirtualAbortException() pseudocode procedure describes how the processor takes the exception:

```
// TakeVirtualAbortException()
// =====
TakeVirtualAbortException()
  // Determine return information. SPSR is to be the current CPSR, and LR is to be the
  // current PC plus 4 for Thumb or 0 for ARM, to change the PC offsets of 4 or 8
  // respectively from the address of the current instruction into the required address
  // of the current instruction plus 8. For an asynchronous abort, the PC and CPSR are
  // considered to have already moved on to their values for the instruction following
  // the instruction boundary at which the exception occurred.
  new_lr_value = if CPSR.T == '1' then PC+4 else PC;
  new_spsr_value = CPSR;
  vect_offset = 16;
```

```
CPSR.M = '10111'; // Abort mode

// Write return information to registers, and make further CPSR changes:
// IRQs disabled, other interrupts disabled if appropriate,
// IT state reset, instruction set and endianness set to SCTLR-configured values.
HCR.VA = '0';
SPSR[] = new_spsr_value;
R[14] = new_lr_value;
CPSR.I = '1';
CPSR.A = '1';
CPSR.IT = '00000000';
CPSR.J = '0'; CPSR.T = SCTLR.TE; // TE=0: ARM, TE=1: Thumb
CPSR.E = SCTLR.EE; // EE=0: little-endian, EE=1: big-endian
BranchTo(ExcVectorBase() + vect_offset);
```

### B1.9.10 IRQ exception

The IRQ exception is generated by IMPLEMENTATION DEFINED means. Typically this is by asserting an IRQ interrupt request input to the processor.

How an IRQ exception is taken depends on [SCTLR.FI](#):

- If [SCTLR.FI](#) == 0, IRQ exception entry is precise to an instruction boundary.
- If [SCTLR.FI](#) == 1, IRQ exception entry is precise to an instruction boundary, except that some of the effects of the instruction that follows that boundary might have occurred. These effects are restricted to those that can be repeated idempotently and without breaking the rules in [Single-copy atomicity on page A3-127](#).

Examples of such effects are:

- changing the value of a register that the instruction writes to but does not read
- performing an access to Normal memory.

———— **Note** —————

This relaxation of the normal definition of a precise asynchronous exception permits interrupts to occur during the execution of instructions that change register or memory values, while only requiring the implementation to restore those register values that are needed to correctly re-execute the instruction after a return to the preferred return address. LDM and STM are examples of such instructions.

As described in [Asynchronous exception masking on page B1-1183](#), IRQ exceptions can be masked. When this happens, a generated IRQ exception is not taken until it is not masked.

By default, an IRQ exception is taken to IRQ mode, but an IRQ exception can be taken to Monitor mode, or Hyp mode. For more information, see [Determining the mode to which the IRQ exception is taken on page B1-1179](#).

The preferred return address for an IRQ exception is the address of the instruction following the instruction boundary at which the exception was taken. This return is performed as follows:

- If returning from a PL1 mode, using the [SPSR](#) and LR values generated by the exception entry, using an exception return instruction with a subtraction of 4. This means using:
  - [SPSR\\_irq](#) and [LR\\_irq](#) if returning from IRQ mode
  - [SPSR\\_mon](#) and [LR\\_mon](#) if returning from Monitor mode.
- If returning from Hyp mode, using the [SPSR\\_hyp](#) and [ELR\\_hyp](#) values generated by the exception entry, using an ERET instruction.

For more information, see [Exception return on page B1-1193](#).

## Pseudocode description of taking the IRQ exception

The TakePhysicalIRQException() pseudocode procedure describes how the processor takes the exception:

```
// TakePhysicalIRQException()
// =====

TakePhysicalIRQException()
  // Determine return information. SPSR is to be the current CPSR, and LR is to be the
  // current PC minus 0 for Thumb or 4 for ARM, to change the PC offsets of 4 or 8
  // respectively from the address of the current instruction into the required address
  // of the instruction boundary at which the interrupt occurred plus 4. For this
  // purpose, the PC and CPSR are considered to have already moved on to their values
  // for the instruction following that boundary.
  new_lr_value = if CPSR.T == '1' then PC else PC-4;
  new_spsr_value = CPSR;
  vect_offset = 24;

  // Determine whether IRQs are routed to Monitor mode.
  route_to_monitor = HaveSecurityExt() && SCR.IRQ == '1';

  // Determine whether IRQs are routed to Hyp mode.
  route_to_hyp = (HaveVirtExt() && HaveSecurityExt() && SCR.IRQ == '0' && HCR.IMO == '1'
    && !IsSecure()) || CPSR.M == '11010';

  if route_to_monitor then
    // Ensure Secure state if initially in Monitor ('10110') mode. This affects
    // the Banked versions of various registers accessed later in the code.
    if CPSR.M == '10110' then SCR.NS = '0';
    EnterMonitorMode(new_spsr_value, new_lr_value, vect_offset);
  elseif route_to_hyp then
    HSR = bits(32) UNKNOWN;
    preferred_exceptn_return = new_lr_value - 4;
    EnterHypMode(new_spsr_value, preferred_exceptn_return, vect_offset);

  else
    // Handle in IRQ mode. Ensure Secure state if initially in Monitor mode. This
    // affects the Banked versions of various registers accessed later in the code.
    if CPSR.M == '10110' then SCR.NS = '0';
    CPSR.M = '10010'; // IRQ mode

    // Write return information to registers, and make further CPSR changes:
    // IRQs disabled, IT state reset, instruction set and endianness set to
    // SCTLR-configured values.
    SPSR[] = new_spsr_value;
    R[14] = new_lr_value;
    CPSR.I = '1';
    if !HaveSecurityExt() || HaveVirtExt() || SCR.NS == '0' || SCR.AW == '1' then
      CPSR.A = '1';
    CPSR.IT = '00000000';
    CPSR.J = '0'; CPSR.T = SCTLR.TE; // TE=0: ARM, TE=1: Thumb
    CPSR.E = SCTLR.EE; // EE=0: little-endian, EE=1: big-endian

    // Branch to correct IRQ vector.
    if SCTLR.VE == '1' then
      IMPLEMENTATION_DEFINED branch to an IRQ vector;
    else
      BranchTo(ExcVectorBase() + vect_offset);
```

*Additional pseudocode functions for exception handling on page B1-1223* defines the EnterMonitorMode() and EnterHypMode() pseudocode procedures.

### B1.9.11 Virtual IRQ exception

The Virtual IRQ exception is implemented only as part of the Virtualization Extensions.

A Virtual IRQ exception is generated if all of the following apply:

- the processor is in a Non-secure mode other than Hyp mode
- `HCR.IMO` is set to 1
- `CPSR.I` is set to 0
- either:
  - `HCR.VI` is set to 1
  - a Virtual IRQ exception is generated by an IMPLEMENTATION DEFINED mechanism.

The conditions for generating a Virtual IRQ exception mean the exception is always:

- taken from a Non-secure PL1 or PL0 mode
- taken to Non-secure IRQ mode.

For more information see *Virtual exceptions in the Virtualization Extensions* on page B1-1196

The preferred return address for a Virtual IRQ exception is the address of the instruction immediately after the instruction boundary where the exception was taken. This return is performed using the `SPSR` and `LR_irq` values generated by the exception entry, using an exception return instruction with a subtraction of 4.

#### Pseudocode description of taking the Virtual IRQ exception

The `TakeVirtualIRQException()` pseudocode procedure describes how the processor takes the exception:

```
// TakeVirtualIRQException()
// =====

TakeVirtualIRQException()
// Determine return information. SPSR is to be the current CPSR, and LR is to be the
// current PC minus 0 for Thumb or 4 for ARM, to change the PC offsets of 4 or 8
// respectively from the address of the current instruction into the required address
// of the instruction boundary at which the interrupt occurred plus 4. For this
// purpose, the PC and CPSR are considered to have already moved on to their values
// for the instruction following that boundary.
new_lr_value = if CPSR.T == '1' then PC else PC-4;
new_spsr_value = CPSR;
vect_offset = 24;

CPSR.M = '10010'; // IRQ mode

// Write return information to registers, and make further CPSR changes:
// IRQs disabled, IT state reset, instruction set and endianness set to
// SCTLR-configured values.
SPSR[] = new_spsr_value;
R[14] = new_lr_value;
CPSR.I = '1';
CPSR.A = '1';
CPSR.IT = '00000000';
CPSR.J = '0'; CPSR.T = SCTLR.TE; // TE=0: ARM, TE=1: Thumb
CPSR.E = SCTLR.EE; // EE=0: little-endian, EE=1: big-endian

// Branch to correct IRQ vector.
if SCTLR.VE == '1' then
    IMPLEMENTATION_DEFINED branch to an IRQ vector;
else
    BranchTo(ExcVectorBase() + vect_offset);
```



## B1.9.12 FIQ exception

The FIQ exception is generated by IMPLEMENTATION DEFINED means. Typically this is by asserting an FIQ interrupt request input to the processor.

How an FIQ exception is taken depends on [SCTLR.FI](#):

- If [SCTLR.FI](#) == 0, FIQ exception entry is precise to an instruction boundary.
- If [SCTLR.FI](#) == 1, FIQ exception entry is precise to an instruction boundary, except that some of the effects of the instruction that follows that boundary might have occurred. These effects are restricted to those that can be repeated idempotently and without breaking the rules in [Single-copy atomicity on page A3-127](#).

Examples of such effects are:

- changing the value of a register that the instruction writes but does not read
- performing an access to Normal memory.

———— **Note** —————

This relaxation of the normal definition of a precise asynchronous exception permits interrupts to occur during the execution of instructions that change register or memory values, while only requiring the implementation to restore those register values that are needed to correctly re-execute the instruction after a return to the preferred return address. LDM and STM are examples of such instructions.

As described in [Asynchronous exception masking on page B1-1183](#), FIQ exceptions can be masked. When this happens, a generated FIQ exception is not taken until it is not masked.

By default, an FIQ exception is taken to FIQ mode, but an FIQ exception can be taken to Monitor mode, or to Hyp mode. For more information, see [Determining the mode to which the FIQ exception is taken on page B1-1180](#).

The preferred return address for an FIQ exception is the address of the instruction following the instruction boundary at which the exception was taken. This return is performed as follows:

- If returning from a PL1 mode, using the [SPSR](#) and LR values generated by the exception entry, using an exception return instruction with a subtraction of 4. This means using:
  - [SPSR\\_fiq](#) and [LR\\_fiq](#) if returning from FIQ mode
  - [SPSR\\_mon](#) and [LR\\_mon](#) if returning from Monitor mode.
- If returning from Hyp mode, using the [SPSR\\_hyp](#) and [ELR\\_hyp](#) values generated by the exception entry, using an ERET instruction.

For more information, see [Exception return on page B1-1193](#).

### Pseudocode description of taking the FIQ exception

The `TakePhysicalFIQException()` pseudocode procedure describes how the processor takes the exception:

```
// TakePhysicalFIQException()
// =====
TakePhysicalFIQException()
// Determine return information. SPSR is to be the current CPSR, and LR is to be the
// current PC minus 0 for Thumb or 4 for ARM, to change the PC offsets of 4 or 8
// respectively from the address of the current instruction into the required address
// of the instruction boundary at which the interrupt occurred plus 4. For this
// purpose, the PC and CPSR are considered to have already moved on to their values
// for the instruction following that boundary.
new_lr_value = if CPSR.T == '1' then PC else PC-4;
new_spsr_value = CPSR;
vect_offset = 28;

// Determine whether FIQs are routed to Monitor mode.
route_to_monitor = HaveSecurityExt() && SCR.FIQ == '1';

// Determine whether route FIQ to Hyp mode.
```

```
route_to_hyp = (HaveVirtExt() && HaveSecurityExt() && SCR.FIQ == '0' && HCR.FMO == '1'
               && !IsSecure()) || CPSR.M == '11010';

if route_to_monitor then
    // Ensure Secure state if initially in Monitor ('10110') mode. This affects
    // the Banked versions of various registers accessed later in the code.
    if CPSR.M == '10110' then SCR.NS = '0';
    EnterMonitorMode(new_spsr_value, new_lr_value, vect_offset);
elsif route_to_hyp then
    HSR = bits(32) UNKNOWN;
    preferred_exceptn_return = new_lr_value - 4;
    EnterHypMode(new_spsr_value, preferred_exceptn_return, vect_offset);
else
    // Handle in FIQ mode. Ensure Secure state if initially in Monitor mode. This
    // affects the Banked versions of various registers accessed later in the code.
    if CPSR.M == '10110' then SCR.NS = '0';
    CPSR.M = '10001'; // FIQ mode

    // Write return information to registers, and make further CPSR changes:
    // IRQs disabled, other interrupts disabled if appropriate, IT state reset,
    // instruction set and endianness set to SCTLr-configured values.
    SPSR[] = new_spsr_value;
    R[14] = new_lr_value;
    CPSR.I = '1';
    if !HaveSecurityExt() || HaveVirtExt() || SCR.NS == '0' || SCR.FW == '1' then
        CPSR.F = '1';
    if !HaveSecurityExt() || HaveVirtExt() || SCR.NS == '0' || SCR.AW == '1' then
        CPSR.A = '1';
    CPSR.IT = '00000000';
    CPSR.J = '0'; CPSR.T = SCTLr.TE; // TE=0: ARM, TE=1: Thumb
    CPSR.E = SCTLr.EE; // EE=0: little-endian, EE=1: big-endian

    // Branch to correct FIQ vector.
    if SCTLr.VE == '1' then
        IMPLEMENTATION_DEFINED branch to an FIQ vector;
    else
        BranchTo(ExcVectorBase() + vect_offset);
```

*Additional pseudocode functions for exception handling on page B1-1223* defines the EnterMonitorMode() and EnterHypMode() pseudocode procedures.

### B1.9.13 Virtual FIQ exception

The Virtual FIQ exception is implemented only as part of the Virtualization Extensions.

A Virtual FIQ exception is generated if all of the following apply:

- the processor is in a Non-secure mode other than Hyp mode
- **HCR.FMO** is set to 1
- **CPSR.F** is set to 0
- either:
  - **HCR.VF** is set to 1
  - a Virtual FIQ exception is generated by an IMPLEMENTATION DEFINED mechanism.

The conditions for generating a Virtual FIQ exception mean the exception is always:

- taken from a Non-secure PL1 or PL0 mode
- taken to Non-secure FIQ mode.

For more information see *Virtual exceptions in the Virtualization Extensions on page B1-1196*.

The preferred return address for a Virtual FIQ exception is the address of the instruction immediately after the instruction boundary where the exception was taken. This return is performed using the **SPSR** and **LR\_irq** values generated by the exception entry, using an exception return instruction with a subtraction of 4.

## Pseudocode description of taking the Virtual FIQ exception

The TakeVirtualFIQException() pseudocode procedure describes how the processor takes the exception:

```
// TakeVirtualFIQException()
// =====

TakeVirtualFIQException()
  // Determine return information. SPSR is to be the current CPSR, and LR is to be the
  // current PC minus 0 for Thumb or 4 for ARM, to change the PC offsets of 4 or 8
  // respectively from the address of the current instruction into the required address
  // of the instruction boundary at which the interrupt occurred plus 4. For this
  // purpose, the PC and CPSR are considered to have already moved on to their values
  // for the instruction following that boundary.
  new_lr_value = if CPSR.T == '1' then PC else PC-4;
  new_spsr_value = CPSR;
  vect_offset = 28;

  CPSR.M = '10001'; // FIQ mode

  // Write return information to registers, and make further CPSR changes:
  // IRQs disabled, other interrupts disabled if appropriate, IT state reset,
  // instruction set and endianness set to SCTLr-configured values.
  SPSR[] = new_spsr_value;
  R[14] = new_lr_value;
  CPSR.I = '1';
  CPSR.F = '1';
  CPSR.A = '1';
  CPSR.IT = '00000000';
  CPSR.J = '0'; CPSR.T = SCTLr.TE; // TE=0: ARM, TE=1: Thumb
  CPSR.E = SCTLr.EE; // EE=0: little-endian, EE=1: big-endian

  // Branch to correct FIQ vector.
  if SCTLr.VE == '1' then
    IMPLEMENTATION_DEFINED branch to an FIQ vector;
  else
    BranchTo(ExcVectorBase() + vect_offset);
```

### B1.9.14 Additional pseudocode functions for exception handling

The EnterMonitorMode() pseudocode function changes the processor mode to Monitor mode, with the required state changes:

```
// EnterMonitorMode()
// =====

EnterMonitorMode(bits(32) new_spsr_value, bits(32) new_lr_value, integer vect_offset)
  CPSR.M = '10110';
  SPSR[] = new_spsr_value;
  R[14] = new_lr_value;
  CPSR.J = '0';
  CPSR.T = SCTLr.TE;
  CPSR.E = SCTLr.EE;
  CPSR.A = '1';
  CPSR.F = '1';
  CPSR.I = '1';
  CPSR.IT = '00000000';
  BranchTo(MVBAR + vect_offset);
```

The EnterHypMode() pseudocode function changes the processor mode to Hyp mode, with the required state changes:

```
// EnterHypMode()
// =====

EnterHypMode(bits(32) new_spsr_value, bits(32) preferred_exceptn_return, integer vect_offset)
  CPSR.M = '11010';
  SPSR[] = new_spsr_value;
```

```
ELR_hyp = preferred_exceptn_return;
CPSR.J = '0';
CPSR.T = HSCTLR.TE;
CPSR.E = HSCTLR.EE;
if SCR.EA == '0' then CPSR.A = '1';
if SCR.FIQ == '0' then CPSR.F = '1';
if SCR.IRQ == '0' then CPSR.I = '1';
CPSR.IT = '00000000';
BranchTo(HVBAR + vect_offset);
```

## B1.10 Coprocessors and system control

The ARM architecture supports sixteen coprocessors, usually referred to as CP0 to CP15. [Coprocesor support on page A2-94](#) introduces these coprocessors. The architecture reserves two of these coprocessors, CP14 and CP15, for configuration and control related to the architecture:

- CP14 is reserved for the configuration and control of:
  - debug features, see [The CP14 debug register interface on page C6-2121](#)
  - trace features, see the [Embedded Trace Macrocell Architecture Specification](#) and the [CoreSight Program Flow Trace Architecture Specification](#)
  - the Thumb Execution Environment, see [Thumb Execution Environment on page B1-1239](#)
  - direct Java bytecode execution, see [Jazelle direct bytecode execution on page B1-1240](#).
- CP15 is called the System Control coprocessor, and is reserved for the control and configuration of the ARM processor system, including architecture and feature identification.

This section gives:

- an introduction to the CP14 and CP15 registers, see [CP14 and CP15 system control registers](#)
- information about access controls for coprocessors CP0 to CP13, see [Access controls on CP0 to CP13 on page B1-1226](#).

### B1.10.1 CP14 and CP15 system control registers

The implementation of the CP15 registers depends heavily on whether the ARMv7 implementation is:

- an ARMv7-A implementation with a *Virtual Memory System Architecture* (VMSA)
- an ARMv7-R implementation with a *Protected Memory System Architecture* (PMSA).

The implementation of the CP14 registers is generally similar in ARMv7-A and ARMv7-R implementation. However, CP14 provides both:

- The system control registers for ThumbEE and the Jazelle extension. These relate to the functionality described in parts A and B of this manual.
- An interface to the debug and trace registers. These relate to the functionality described in part C of this manual and in separate trace architecture specifications.

Therefore, part B of this manual provides separate register descriptions for VMSA and PMSA implementations. Both descriptions include general information about CP14 register accesses, including accesses to the Debug registers. In more detail:

- For a VMSA implementation:
  - [Chapter B3](#), starting at the section [About the system control registers for VMSA on page B3-1444](#), gives a general description of the system control registers, including the CP14 interface to the Debug registers
  - [Chapter B4 System Control Registers in a VMSA implementation](#) describes all of the non-debug system control registers, in order of their register names.
- For a PMSA implementation:
  - [Chapter B5](#), starting at the section [About the system control registers for PMSA on page B5-1772](#), gives a general description of the system control registers, including the CP14 interface to the Debug registers
  - [Chapter B6 System Control Registers in a PMSA implementation](#) describes all of the non-debug system control registers, in order of their register names.
- For all implementations:
  - [Chapter C6 Debug Register Interfaces](#) gives more information about CP14 accesses to the debug registers
  - [Chapter C11 The Debug Registers](#) describes all of the debug registers, in order of their register names.

Registers that are common to VMSA and PMSA implementations are described in both [Chapter B4](#) and [Chapter B6](#). Some registers are implemented differently in VMSA and PMSA implementations.

### Access to CP14 and CP15 registers

Most CP14 and CP15 registers are accessible only from PL1 or higher. For possible accesses from PL0:

- The register descriptions in [Chapter B4 System Control Registers in a VMSA implementation](#) and [Chapter B6 System Control Registers in a PMSA implementation](#) indicate whether a register is accessible from PL0.

———— **Note** —————

These chapters provide all of the CP14 and CP15 register descriptions in this manual, except for the CP14 debug registers, that are described in [Chapter C11 The Debug Registers](#).

- The descriptions of the CP14 interface in [Chapter C6 Debug Register Interfaces](#) include the permitted accesses to the debug registers from PL0.
- The following sections summarize the permitted accesses to CP15 registers from PL0:
  - for a VMSA implementation, [PL0 views of the CP15 registers on page B3-1488](#)
  - for a PMSA implementation, [PL0 views of the CP15 registers on page B5-1795](#).

### B1.10.2 Access controls on CP0 to CP13

Coprocessors CP0 to CP13 might be required for optional features of the ARMv7 implementation. In particular, CP10 and CP11 support the floating-point instructions provided by the Floating-point and Advanced SIMD Extensions to the architecture, see [Advanced SIMD and floating-point support on page B1-1228](#).

Coprocessors CP0 to CP7 can provide IMPLEMENTATION DEFINED vendor-specific features.

The [CPACR](#) controls access to coprocessors CP0 to CP13 from software executing at PL1 or PL0, see either:

- [CPACR, Coprocessor Access Control Register, VMSA on page B4-1551](#)
- [CPACR, Coprocessor Access Control Register, PMSA on page B6-1829](#).

Initially on powerup or reset, access to coprocessors CP0 to CP13 is disabled.

———— **Note** —————

The [CPACR](#) has no effect on accesses from Hyp mode.

If an implementation includes the Security Extensions, the [NSACR](#) determines which of the CP0 to CP13 coprocessors can be accessed from the Non-secure state.

If an implementation includes the Virtualization Extensions, the [HCPTR](#) provides additional controls on Non-secure accesses to coprocessors CP0 to CP13. For accesses that are otherwise permitted by the [CPACR](#) and [NSACR](#) settings, setting [HCPTR](#) bits to 1:

- traps otherwise-permitted accesses from PL1 or PL0 to Hyp mode
- makes accesses from Hyp mode UNDEFINED.

For more information, see [Trapping accesses to coprocessors on page B1-1256](#).

---

**Note**

- When an implementation includes either or both of the Floating-point and Advanced SIMD Extensions, the access settings for CP10 and CP11 must be identical. If these settings are not identical the behavior of the extensions is UNPREDICTABLE.
  - To check which coprocessors are implemented:
    1. If required, read the Coprocessor Access Control Register and save the value.
    2. Write the value 0x0FFFFFFF to the register, to write 0b11 to the access field for each of the coprocessors CP13 to CP0.
    3. Read the Coprocessor Access Control Register again and check the access field for each coprocessor:
      - if the access field value is 0b00 the coprocessor is not implemented
      - if the access field value is 0b11 the coprocessor is implemented.
    4. If required, write the value from stage 1 back to the register to restore the original value.
-

## B1.11 Advanced SIMD and floating-point support

[Advanced SIMD and Floating-point Extensions on page A2-54](#) introduces:

- the Floating-point (VFP) Extension, that adds scalar floating-point instructions to the ARM and Thumb instruction sets
- the Advanced SIMD Extension, that adds integer and floating-point vector instructions to the ARM and Thumb instruction sets
- the Advanced SIMD and Floating-point Extension registers D0 - D31 and their alternative views as S0 - S31 and Q0 - Q15.
- the *Floating-Point Status and Control Register (FPSCR)*.

For more information about the system registers for the Advanced SIMD and Floating-point Extensions see [Advanced SIMD and Floating-point Extension system registers on page B1-1235](#).

Software can interrogate the registers summarized in [Advanced SIMD and Floating-point Extension feature identification registers on page B7-1955](#) to discover the implemented Advanced SIMD and floating-point support.

The following subsections give more information about the Advanced SIMD and Floating-point Extensions:

- [Enabling Advanced SIMD and floating-point support](#)
- [Advanced SIMD and Floating-point Extension system registers on page B1-1235](#)
- [Context switching with the Advanced SIMD and Floating-point Extensions on page B1-1236](#)
- [Floating-point support code on page B1-1236](#)
- [VFP subarchitecture support on page B1-1238](#).

### B1.11.1 Enabling Advanced SIMD and floating-point support

If an ARMv7 implementation includes support for any Advanced SIMD or Floating-point features then software must ensure that the required access to these features is enabled:

- Any use of Advanced SIMD or floating-point features requires access to CP10 and CP11.
- Additional controls apply to the use of Advanced SIMD features, see [Additional controls on Advanced SIMD functionality on page B1-1232](#).

The controls of access to CP10 and CP11 are:

- **CPACR**. {cp10, cp11} control access from PL1 and PL0. The permitted values of these fields are:
  - 0b00** No access. Any access to the Advanced SIMD and Floating-point Extension features is UNDEFINED.
  - 0b01** Accessible at PL1 only. Any access to the Advanced SIMD and Floating-point Extension features from PL0 is UNDEFINED.
  - 0b11** Accessible from PL0 and PL1. However, additional controls apply to most accesses.These fields reset to 0b00, no access.
- In an implementation that includes the Security Extensions, **NSACR**. {cp10, cp11} control access from Non-secure state. The permitted values of these bits are:
  - 0** Accessible from Secure state only. Any access to the Advanced SIMD and Floating-point Extension features from Non-secure state is UNDEFINED.
  - 1** Accessible from both security states, subject to any other access controls that apply. These include:
    - For all accesses from PL1 or PL0, the **CPACR**. {cp10, cp11} controls.
    - If the implementation includes the Virtualization Extension, the **HCPTR**. {TCP10, TCP11} control, This applies to accesses from PL2, PL1, and PL0.



- In an implementation that includes the Virtualization Extensions, when **NSACR**.{cp10, cp11} are set to 1, to permit Non-secure accesses, **HCPTR**.{TCP10, TCP11} provide an additional control on those accesses. The permitted values of these bits are:
  - 0** Advanced SIMD and Floating-point Extension features are accessible from Non-secure state, subject to any other access controls that apply. The **CPACR**.{cp10, cp11} controls:
    - Apply to accesses from PL1 or PL0.
    - Have no effect on accesses from PL2, Hyp mode.
  - 1** Trap coprocessor accesses:
    - Accesses from PL1 or PL0 that are permitted by other controls, including the **CPACR**.{cp10, cp11} controls, generate an exception that is taken from Hyp mode.
    - Any access to Advanced SIMD and Floating-point Extension features from PL2, Hyp mode, is UNDEFINED.

When **NSACR**.{cp10, cp11} are set to 0, all accesses to Advanced SIMD and Floating-point Extension features from Non-secure state are UNDEFINED.

———— **Note** —————

The **HCPTR** can also trap to Hyp mode otherwise-permitted Non-secure PL1 and PL0 accesses to Advanced SIMD or Floating-point functionality. At reset, those traps are disabled.

In an implementation that includes at least one of the Advanced SIMD and Floating-point Extensions, access control bits for CP10 and CP11 must be programmed with the same values, otherwise operation of the controlled Advanced SIMD and Floating-point features is UNPREDICTABLE. This means that operation is UNPREDICTABLE:

- in any implementation, if the values of **CPACR**.cp10 and **CPACR**.cp11 are different
- in an implementation that includes the Security Extensions, in Non-secure state, if the values of **NSACR**.cp10 and **NSACR**.cp11 are different
- in an implementation that includes the Virtualization Extensions, in Non-secure state, if the values of **HCPTR**.TCP10 and **HCPTR**.TCP11 are different.

In addition, **FPEXC**.EN is an enable bit for most Advanced SIMD and Floating-point operations. When **FPEXC**.EN is 0, all Advanced SIMD and Floating-point instructions are treated as UNDEFINED except for:

- a VMSR to the **FPEXC** or **FPSID** register
- a VMRS from the **FPEXC**, **FPSID**, **MVFR0**, or **MVFR1** register.

These instructions can be executed only at PL1 or higher.

———— **Note** —————

- Although **FPSID** is a read-only register, software can perform a VMSR to the **FPSID** to force Floating-point serialization, as described in *Asynchronous bounces, serialization, and Floating-point exception barriers on page B1-1237*.
- When **FPEXC**.EN is 0, these operations are treated as UNDEFINED:
  - a VMSR to the **FPSCR**
  - a VMRS from the **FPSCR**
- If a Floating-point implementation contains system registers additional to the **FPSID**, **FPSCR**, **FPEXC**, **MVFR0**, and **MVFR1** registers, the behavior of VMSR instructions to them and VMRS instructions from them is SUBARCHITECTURE DEFINED.

These controls, summarized in *Summary of general controls of CP10 and CP11 functionality on page B1-1230*, apply to all functionality that depends on access to CP10 and CP11. That is, they apply equally to all implemented Advanced SIMD and floating-point functionality.

Additional controls apply to any implemented Advanced SIMD functionality, see *Additional controls on Advanced SIMD functionality on page B1-1232*.

[Pseudocode details of enabling the Advanced SIMD and Floating-point Extensions on page B1-1234](#) gives a pseudocode description of both sets of controls.

### Summary of general controls of CP10 and CP11 functionality

Table B1-21 summarizes the access controls for the implemented Advanced SIMD and floating-point functionality, that are based on controlling access to coprocessors CP10 and CP11, and on the `FPEXC.EN` enable bit. The following subsections give more information about the entries in this table:

- [Information about the general controls of CP10 and CP11 functionality on page B1-1231](#)
- [PL0 access to Advanced SIMD and floating-point functionality on page B1-1231](#).

In this table, and in [Table B1-23 on page B1-1232](#), an entry of:

- `UND` indicates that the Advanced SIMD or floating-point access generates an Undefined Instruction exception. For an access made from Hyp mode this exception is taken to Hyp mode, otherwise it is taken to Secure or Non-secure Undefined mode.
- `Trapped` indicates that accesses generate a Hyp Trap exception, that is taken to Hyp mode.

**Table B1-21 Summary of access controls for all CP10 and CP11 functionality**

Controls				Secure		Non-secure			
<code>CPACR.cpn<sup>a</sup></code>	<code>NSACR.cpn</code>	<code>HCPTR.TCP<sub>n</sub></code>	<code>FPEXC.EN</code>	<code>PL1</code>	<code>PL0</code>	<code>PL2</code>	<code>PL1</code>	<code>PL0</code>	
00	0	x <sup>b</sup>	x	UND	UND	UND	UND	UND	
			0	UND	UND	UND <sup>c</sup>	UND	UND	
	1	0	0	UND	UND	Enabled	UND	UND	
			1	UND	UND	UND	UND	UND	
01	0	x <sup>b</sup>	0	UND <sup>c</sup>	UND	UND	UND	UND	
			1	Enabled	UND	UND	UND	UND	
			0	UND <sup>c</sup>	UND	UND <sup>c</sup>	UND <sup>c</sup>	UND	
			1	Enabled	UND	Enabled	Enabled	UND	
	1	0	1	0	UND <sup>c</sup>	UND	UND	UND <sup>d</sup>	UND
				1	Enabled	UND	UND	Trapped	UND
				0	UND <sup>c</sup>	UND	UND	UND <sup>d</sup>	UND
				1	Enabled	Enabled	UND	Trapped	Trapped
11	0	x <sup>b</sup>	0	UND <sup>c</sup>	UND	UND	UND	UND	
			1	Enabled	Enabled	UND	UND	UND	
			0	UND <sup>c</sup>	UND	UND <sup>c</sup>	UND <sup>c</sup>	UND	
	1	0	1	0	UND <sup>c</sup>	UND	UND	UND <sup>d</sup>	UND
				1	Enabled	Enabled	Enabled	Enabled	Enabled
				0	UND <sup>c</sup>	UND	UND	UND <sup>d</sup>	UND

- When the corresponding `NSACR` bit is set to 0, for Non-secure accesses the `CPACR` field behaves as RAZ/WI. That is, when `NSACR.cp10` is set to 0, for Non-secure accesses `CPACR.cp10` ignores writes, and reads as `0b00`, regardless of its actual value.
- When the `NSACR` control bits are set to 0, for Non-secure accesses the `HCPTR` control bits behave as RAO/WI.
- Except for VMRS to the `FPEXC` or `FPSID` register, or a VMRS from the `FPEXC`, `FPSID`, `MVFR0`, or `MVFR1` register.
- Except for VMRS to the `FPEXC` or `FPSID` register, or a VMRS from the `FPEXC`, `FPSID`, `MVFR0`, or `MVFR1` register, that are Trapped.

———— **Note** —————

In [Table B1-21 on page B1-1230](#):

- the behavior of Secure accesses depends only on the [CPACR](#) and [FPEXC](#) control values
- the behavior of accesses from Hyp mode depends only on the [NSACR](#), [HCPTR](#), and [FPEXC](#) control values.

**Information about the general controls of CP10 and CP11 functionality**

In [Table B1-21 on page B1-1230](#), the values for each of the registers shown in the *Controls* columns are:

**CPACR** The value of the [CPACR.cp10](#) and [CPACR.cp11](#) fields. These fields must be programmed to the same value, otherwise behavior is UNPREDICTABLE. The table does not show the reserved value of 0b10.

In addition, when CP10 and CP11 functionality is otherwise enabled, if [CPACR.D32DIS](#) is set to 1, any operation that uses registers D16-D31 of the Floating-point register file is UNDEFINED.

These controls are part of any implementation that includes at least one of the Advanced SIMD Extension and the Floating-point Extension.

**NSACR** The value of the [NSACR.cp10](#) and [NSACR.cp11](#) bits. These fields must be programmed to the same value, otherwise behavior is UNPREDICTABLE.

These controls are implemented only as part of the Security Extensions. For the access controls for an implementation that does not include the Security Extensions, consider only:

- the Secure PL1 and PL0 columns
- the rows for which [NSACR](#) is 0, and [HCPTR](#) is 0 or x.

**HCPTR** The value of the [HCPTR.TCP10](#) and [HCPTR.TCP11](#) bits. These fields must be programmed to the same value, otherwise behavior is UNPREDICTABLE.

These controls are implemented only as part of the Virtualization Extensions. For the access controls for an implementation that does not include the Virtualization Extensions:

- ignore the Non-secure PL2 column
- consider only the rows for which [HCPTR](#) is 0 or x.

**FPEXC.EN** The value of [FPEXC.EN](#). As indicated in this section, and in the table footnote, when this bit is set to 0:

- most Advanced SIMD and floating-point functionality is disabled
- a limited number of register accesses are permitted at PL1 or higher.

When this bit is set to 1, Advanced SIMD and floating-point functionality is enabled, but subject to:

- the other access controls shown in the table
- the restrictions described in [PL0 access to Advanced SIMD and floating-point functionality](#).

This control is part of any implementation that includes at least one of the Advanced SIMD Extension and the Floating-point Extension.

**PL0 access to Advanced SIMD and floating-point functionality**

When [Table B1-21 on page B1-1230](#) shows that PL0 access to the Advanced SIMD and floating-point functionality is enabled, this applies only to the subset of functionality that is available at PL0. In particular, the only Advanced SIMD and Floating-point Extension system register that is accessible is the [FPSCR](#). However, the Advanced SIMD and floating-point instructions are available. Execution at PL0 corresponds to the application level view of the extensions, as described in [Advanced SIMD and Floating-point Extensions on page A2-54](#).

### Additional controls on Advanced SIMD functionality

If the general controls summarized in *Summary of general controls of CP10 and CP11 functionality on page B1-1230* permit access to CP10 and CP11 functionality, additional controls apply to any implemented Advanced SIMD functionality. The following controls apply to all Advanced SIMD instructions, that is, to all instruction encodings in *Alphabetical list of instructions on page A8-300* that are identified as Advanced SIMD encodings and are not also Floating-point encodings:

- when **CPACR.ASEDIS** is set to 1, all Advanced SIMD instructions are UNDEFINED
- in an implementation that includes the Security Extensions, when **CPACR.ASEDIS** is set to 0, if **NSACR.NSASEDIS** is set to 1 and the processor is in Non-secure state, **CPACR.ASEDIS** appears as RAO/WI and all Advanced SIMD instructions are UNDEFINED
- in an implementation that includes the Virtualization Extensions, when the **CPACR** and **NSACR** settings permit Non-secure use of the Advanced SIMD instructions, if **HCPTTR.TASE** is set to 1 any use of an Advanced SIMD instruction from:
  - a Non-secure PL1 or PL0 mode is trapped to Hyp mode
  - Hyp mode generates an Undefined Instruction exception that is taken to Hyp mode.

*Summary of access controls for Advanced SIMD functionality* summarizes these controls.

*Table B1-22* references the descriptions of the registers that control this functionality, and *Summary of access controls for Advanced SIMD functionality* shows these controls.

**Table B1-22 Registers that control access to Advanced SIMD and floating-point functionality**

Description	VMSA	PMSA	Note
Coprocessor Access Control Register	<b>CPACR</b>	<b>CPACR</b>	-
Floating-Point Exception Control register	<b>FPEXC</b>	<b>FPEXC</b>	-
Non-Secure Access Control Register	<b>NSACR</b>	-	Security Extensions, therefore VMSA only
Hyp Coprocessor Trap Register	<b>HCPTTR</b>	-	Virtualization Extensions, therefore VMSA only

### Summary of access controls for Advanced SIMD functionality

*Table B1-23* summarizes the access controls for the use of Advanced SIMD instructions. In this table:

- Entries of UND and Enabled have the meanings defined in *Summary of general controls of CP10 and CP11 functionality on page B1-1230*
- Table entries apply only if the settings of **CPACR**, **NSACR**, **HCPTTR**, and **FPEXC.EN** shown in *Table B1-21 on page B1-1230* permit the access, otherwise the behavior shown in *Table B1-21 on page B1-1230* applies.

**Table B1-23 Summary of additional access controls for Advanced SIMD functionality**

Controls			Secure		Non-secure		
<b>CPACR.ASEDIS</b>	<b>NSACR.NSASEDIS</b>	<b>HCPTTR.TASE</b>	<b>PL1</b>	<b>PL0</b>	<b>PL2</b>	<b>PL1</b>	<b>PL0</b>
0 <sup>a</sup>	0	0	Enabled	Enabled	Enabled	Enabled	Enabled
		1	Enabled	Enabled	UND	Trapped	Trapped
	1	x <sup>a</sup>	Enabled	Enabled	UND	UND	UND

Table B1-23 Summary of additional access controls for Advanced SIMD functionality (continued)

Controls			Secure		Non-secure		
CPACR.ASEDIS	NSACR.NSASEDIS	HCPTR.TASE	PL1	PL0	PL2	PL1	PL0
1	0	0	UND	UND	Enabled	UND	UND
		1	UND	UND	UND	UND	UND
	1	x <sup>a</sup>	UND	UND	UND	UND	UND

- a. When NSACR.NSASEDIS is set to 1, for Non-secure accesses:
- to CPACR, the ASEDIS bit behaves as RAO/WI
  - to HCPTR, the TSAE bit behaves as RAO/WI.

When interpreting Table B1-23 on page B1-1232:

- The NSACR is implemented only as part of the Security Extensions. For an implementation that does not include the Security Extensions, use of the Advanced SIMD instructions:
  - is enabled when CPACR.ASEDIS is set to 0
  - is disabled when CPACR.ASEDIS is set to 1.
- The HCPTR is implemented only as part of the Virtualization Extensions. For an implementation that does not include the Virtualization Extensions, when the controls shown in Table B1-24 on page B1-1235 permit Non-secure use of the CP10 and CP11 functionality, use of the Advanced SIMD instructions from Non-secure state:
  - is enabled when CPACR.ASEDIS and NSACR.NSASEDIS are both set to 0
  - is disabled otherwise.

## Pseudocode details of enabling the Advanced SIMD and Floating-point Extensions

The following pseudocode takes appropriate action if an Advanced SIMD or Floating-point instruction is used when the extensions are not enabled:

```
// CheckAdvSIMDOrVFPEEnabled()
// =====

CheckAdvSIMDOrVFPEEnabled(boolean include_fpxc_check, boolean advsimd)

    // In Non-secure state, Non-secure view of CPACR and HCPTR determines behavior
    // Copy register values
    cpacr_cp10 = CPACR.cp10;
    cpacr_cp11 = CPACR.cp11;
    cpacr_asedis = CPACR.ASEDIS;
    if HaveVirtExt() then
        hcptr_cp10 = HCPTR.TCP10;
        hcptr_cp11 = HCPTR.TCP11;
        hcptr_tase = HCPTR.TASE;

    if HaveSecurityExt() then
        // Check Non-Secure Access Control Register for permission to use CP10/11.
        if NSACR.cp10 != NSACR.cp11 then UNPREDICTABLE;

        if !IsSecure() then
            // Modify register values to the Non-secure view
            if NSACR.cp10 == '0' then
                cpacr_cp10 = '00';
                cpacr_cp11 = '00';
                if HaveVirtExt() then
                    hcptr_cp10 = '1';
                    hcptr_cp11 = '1';
            if NSACR.NSASEDIS == '1' then
                cpacr_asedis = '1';
                if HaveVirtExt() then
                    hcptr_tase = '1';

    // Check Coprocessor Access Control Register for permission to use CP10/11.
    if !HaveVirtExt() || !CurrentModeIsHyp() then
        if cpacr_cp10 != cpacr_cp11 then UNPREDICTABLE;
        case cpacr_cp10 of
            when '00' UNDEFINED;
            when '01' if !CurrentModeIsNotUser() then UNDEFINED;
                // else CPACR permits access
            when '10' UNPREDICTABLE;
            when '11' // CPACR permits access

        // If the Advanced SIMD extension is specified, check whether it is disabled.
        if advsimd && cpacr_asedis == '1' then UNDEFINED;

    // If required, check FPEXC enabled bit.
    if include_fpxc_check && FPEXC.EN == '0' then UNDEFINED;

    if HaveSecurityExt() && HaveVirtExt() && !IsSecure() then
        if hcptr_cp10 != hcptr_cp11 then UNPREDICTABLE;
        if hcptr_cp10 == '1' || (advsimd && hcptr_tase == '1') then
            HSRString = Zeros(25);
            if advsimd && hcptr_tase == '1' then
                HSRString<5> = '1';
            else
                HSRString<5> = '0';
                HSRString<3:0> = '1010';
            WriteHSR('000111', HSRString);
            if !CurrentModeIsHyp() then
                TakeHypTrapException();
            else
                UNDEFINED;
```

```

    return;

// CheckAdvSIMDEnabled()
// =====

CheckAdvSIMDEnabled()
    CheckAdvSIMDOrVFPEEnabled(TRUE, TRUE);
    // Return from CheckAdvSIMDOrVFPEEnabled() occurs only if Advanced SIMD access is permitted

    // Make temporary copy of D registers
    // _Dclone[] is used as input data for instruction pseudocode
    for i = 0 to 31
        _Dclone[i] = _D[i];

    return;

// CheckVFPEEnabled()
// =====

CheckVFPEEnabled(boolean include_fpxc_check)
    CheckAdvSIMDOrVFPEEnabled(include_fpxc_check, FALSE);
    // Return from CheckAdvSIMDOrVFPEEnabled() occurs only if VFP access is permitted
    return;

```

## B1.11.2 Advanced SIMD and Floating-point Extension system registers

The Advanced SIMD and Floating-point Extensions share a common set of system registers. Any ARMv7 implementation that includes either or both of these extensions must implement these registers. This section gives general information about this set of registers, and indicates where each register is described in detail. It contains the following subsections:

- [Register map of the Advanced SIMD and Floating-point Extension system registers](#)
- [Accessing the Advanced SIMD and Floating-point Extension system registers on page B1-1236.](#)

### Register map of the Advanced SIMD and Floating-point Extension system registers

Table B1-24 shows the register map of the Advanced SIMD and Floating-point registers. Each register is 32 bits wide. In an implementation that includes the Security Extensions, the Advanced SIMD and Floating-point registers are common registers, see [Common system control registers on page B3-1457](#).

**Table B1-24 Advanced SIMD and Floating-point common register block**

Name, VMSA <sup>a</sup>	Name, PMSA <sup>a</sup>	System register	Width	Type	Description
FPSID	FPSID	0b0000	32-bit	RO	Floating-point System ID Register
FPSCR	FPSCR	0b0001	32-bit	RW	Floating-point Status and Control Register
-	-	0b0010- 0b0101	32-bit	-	All accesses are UNPREDICTABLE
MVFR1	MVFR1	0b0110	32-bit	RO	Media and VFP Feature Register 1
MVFR0	MVFR0	0b0111	32-bit	RO	Media and VFP Feature Register 0
FPEXC	FPEXC	0b1000	32-bit	RW	Floating-Point Exception Register
-	-	0b1001-0b1111	32-bit	SUBARCHITECTURE DEFINED	

a. VMSA and PMSA definitions of the register fields are identical. These columns link to the descriptions in [Chapter B4](#) and [Chapter B6](#).

---

**Note**

[Appendix F Common VFP Subarchitecture Specification](#) includes examples of how a Floating-point subarchitecture might define additional registers, in the SUBARCHITECTURE DEFINED register space using addresses in the 0b1001 to 0b1111 range. [Appendix F](#) is not part of the ARMv7 architecture. It is included as an example of how a Floating-point subarchitecture might be defined.

---

### Accessing the Advanced SIMD and Floating-point Extension system registers

Software accesses the Advanced SIMD and Floating-point Extension system registers using the VMRS and VMSR instructions, see:

- [VMRS on page B9-2012](#)
- [VMSR on page B9-2014](#).

For example:

```
VMRS <Rt>, FPSID    ; Read Floating-Point System ID Register
VMRS <Rt>, MVFR1    ; Read Media and VFP Feature Register 1
VMSR FPSCR, <Rt>    ; Write Floating-Point System Control Register
```

Software can access the Advanced SIMD and Floating-point Extension system registers only if the access controls for the extensions permit the access, see [Enabling Advanced SIMD and floating-point support on page B1-1228](#).

---

**Note**

All hardware ID information can be accessed only from PL1 or higher. This means:

**The FPSID is accessible only from PL1 or higher.**

This is a change introduced in VFPv3. In VFPv2 implementations the FPSID register can be accessed in all modes.

**The MVFR registers are accessible only from PL1 or higher.**

Unprivileged software must issue a system call to determine what features are supported.

---

### B1.11.3 Context switching with the Advanced SIMD and Floating-point Extensions

In an implementation that includes one or both of the Advanced SIMD and Floating-point Extensions, if the Floating-point registers are used by only a subset of processes, the operating system might implement lazy context switching of the extension registers and extension system registers.

In the simplest lazy context switch implementation, the primary context switch software disables the Advanced SIMD and Floating-point Extensions, by disabling access to coprocessors CP10 and CP11 in the Coprocessor Access Control Register, see [Enabling Advanced SIMD and floating-point support on page B1-1228](#). Subsequently, when a process or thread attempts to use an Advanced SIMD or Floating-point instruction, it triggers an Undefined Instruction exception. The operating system responds by saving and restoring the extension registers and extension system registers. Typically, it then re-executes the Advanced SIMD or Floating-point instruction that generated the Undefined Instruction exception.

### B1.11.4 Floating-point support code

A complete Floating-point implementation might require a software component, called the *support code*. For example, if an implementation includes VFPv3U or VFPv4U, support code must handle the trapped floating-point exceptions. The interface to the support code is called the *VFP subarchitecture*. ARM has defined a subarchitecture that is suitable for use with implementations of the ARM Floating-point Extension, see [Appendix F Common VFP Subarchitecture Specification](#).



---

**Note**

The Common VFP Subarchitecture is not part of the ARMv7 architecture specification, see [VFP subarchitecture support on page B1-1238](#).

---

If the Floating-point Extension hardware does not respond to a Floating-point instruction, the support code is entered through the ARM Undefined Instruction vector. This software entry is called a *bounce*.

When an implementation includes VFPv3U or VFPv4U, the bounce mechanism also supports trapped floating-point exceptions. Trapped floating-point exceptions, called *traps*, are floating-point exceptions that an implementation passes back to application software to resolve, see [Floating-point exceptions on page A2-70](#). The support code must catch a trapped exception and convert it into a trap handler call.

Support code can perform other tasks, as determined by the implementation. For example, it might be used for rare conditions, such as operations that are difficult to implement in hardware, or operations that are gate-intensive in hardware. However, in ARMv7, ARM:

- deprecates any such use of support code
- strongly recommends that all floating-point functionality, except for short vector support, is fully implemented in hardware.

The division of labor between the hardware and software components of an implementation, and details of the interface between the support code and hardware are SUBARCHITECTURE DEFINED.

### Asynchronous bounces, serialization, and Floating-point exception barriers

---

**Note**

Asynchronous bounces were commonly used in ARMv6 implementations. For ARMv7 implementations, ARM strongly recommends that any bounces are synchronous.

---

A Floating-point implementation can produce an *asynchronous bounce*, in which a Floating-point instruction takes the Undefined Instruction exception because support code processing is required for an earlier Floating-point instruction. The mechanism by which the support code determines the nature of the required processing is SUBARCHITECTURE DEFINED. Typically, it involves:

- using the SUBARCHITECTURE DEFINED bits of the [FPEXC](#)
- using the SUBARCHITECTURE DEFINED extension system registers, see [Advanced SIMD and Floating-point Extension system registers on page B1-1235](#)
- setting [FPEXC.EX](#) == 1, to indicate that the SUBARCHITECTURE DEFINED extension system registers must be saved on a context switch.

An asynchronous bounce might not relate to the last Floating-point instruction executed before the one that generated the Undefined Instruction exception. Another Floating-point instruction might have been issued and retired before the asynchronous bounce occurs. This is possible only if this intervening instruction has no register dependencies on the Floating-point instruction that requires support code processing. In addition, a subarchitecture can provide SUBARCHITECTURE DEFINED mechanisms for handling an intervening Floating-point instruction that has issued but not retired. The common VFP subarchitecture defined in [Appendix F](#) includes such mechanisms.

However, VMRS and VMSR instructions that access the [FPSID](#), [FPSCR](#), or [FPEXC](#) registers are *serializing* instructions. This means that, before they perform any required register transfer, they ensure that any exceptional condition that requires support code processing, from any preceding Floating-point instruction, has been detected and reflected in the extension system registers. A VMSR instruction to the read-only [FPSID](#) register is a serializing NOP.

In addition:

- A VMRS or VMSR instruction that accesses the [FPSCR](#) acts as a *Floating-point exception barrier*. This means that, before it performs the register transfer, it ensures that any outstanding exceptional conditions in preceding Floating-point instructions have been detected and processed by the support code. If necessary, the VMRS or VMSR instruction takes an asynchronous bounce to force the processing of any outstanding exceptional conditions.
- VMRS and VMSR instructions that access the [FPSID](#) or [FPEXC](#) do not take asynchronous bounces.

In pseudocode, Floating-point serialization and the Floating-point exception barriers are described by the `SerializeVFP()` and `VFPExcBarrier()` functions respectively.

### B1.11.5 VFP subarchitecture support

In the ARMv7 specification of the Floating-point Extension, some features are identified as `SUBARCHITECTURE DEFINED`. ARMv7 is compatible with the *ARM Common VFP subarchitecture*, that is used by several Floating-point implementations. However, ARMv7 does not require or specifically recommend the use of the ARM Common VFP subarchitecture.

[Appendix F Common VFP Subarchitecture Specification](#) is the specification of the *ARM Common VFP subarchitecture*. The subarchitecture is not part of the ARMv7 architecture specification. For details of the status of the subarchitecture specification see the *Note* on the cover page of [Appendix F](#).

## B1.12 Thumb Execution Environment

[Thumb Execution Environment on page A2-95](#) introduces the *Thumb Execution Environment* (ThumbEE), and includes:

- an application level view of the execution environment
- a summary of its system control registers.

[Chapter A9 The ThumbEE Instruction Set](#) describes the ThumbEE instruction set.

This section describes the system level programmers' model for ThumbEE.

From the publication of issue C.a of this manual, ARM deprecates any use of the ThumbEE instruction set.

The ThumbEE Configuration Register can be read at PL0, but can be written only at PL1 or higher, see [TEECR, ThumbEE Configuration Register, VMSA on page B4-1714](#) or [TEECR, ThumbEE Configuration Register, PMSA on page B6-1937](#).

Access to the ThumbEE Handler Base Register depends on the value held in the TEECR and the current privilege level, see [TEEHBR, ThumbEE Handler Base Register, VMSA on page B4-1715](#) or [TEEHBR, ThumbEE Handler Base Register, PMSA on page B6-1938](#).

The processor executes ThumbEE instructions when it is in ThumbEE state.

The processor instruction set state is indicated by the [CPSR.{J, T}](#) bits, see [Program Status Registers \(PSRs\) on page B1-1147](#). [CPSR.{J, T} == 0b11](#) when the processor is in ThumbEE state.

During normal execution, not involving exception entries and returns:

- ThumbEE state can only be entered from Thumb state, using the [ENTERX](#) instruction
- exit from ThumbEE state always occurs using the [LEAVEX](#) instruction and returns execution to Thumb state.

For details of these instructions see [ENTERX, LEAVEX on page A9-1116](#).

When an exception occurs in ThumbEE state, exception entry goes to either ARM state or Thumb state as usual, depending on the value of [SCTLR.TE](#). When the exception handler returns, the exception return instruction restores [CPSR.{J, T}](#) as usual, causing a return to ThumbEE state.

In ThumbEE state, execution of the exception return instructions described in [Exception return on page B1-1193](#) is UNPREDICTABLE.

### B1.12.1 ThumbEE and the Security Extensions and Virtualization Extensions

When an implementation that includes ThumbEE support also includes the Security Extensions, the ThumbEE registers are common registers, see [Common system control registers on page B3-1457](#).

When an implementation that includes ThumbEE support also includes the Virtualization Extensions, accesses to the ThumbEE registers from Non-secure PL1 and PL0 modes can be trapped to Hyp mode, see [Trapping accesses to the ThumbEE configuration registers on page B1-1255](#).

### B1.12.2 Aborts, exceptions, and checks

Aborts and exceptions are unchanged in ThumbEE. A null check takes priority over an abort or watchpoint on the same memory access. For more information, see [Null checking on page A9-1113](#).

The IT state bits in the [CPSR](#) are always cleared on entry to a NullCheck or IndexCheck handler. For more information, see [IT block and check handlers on page A9-1114](#).

## B1.13 Jazelle direct bytecode execution

In Jazelle state the processor executes bytecode programs, as described in *Jazelle state* on page A2-98. The CPSR.{J, T} bits indicate the processor instruction set state, see *Program Status Registers (PSRs)* on page B1-1147. CPSR.{J, T} == 0b10 when the processor is in Jazelle state. Because the Virtualization Extensions require an implementation to include only a trivial Jazelle implementation, an implementation that includes the Virtualization Extensions cannot execute in Jazelle state.

For more information about entering and exiting Jazelle state see *Jazelle state* on page B1-1245.

### B1.13.1 Extension of the PC to 32 bits

In a non-trivial Jazelle implementation, all 32 bits of the PC are defined. This means the PC can point to an arbitrary bytecode instruction. In the PC, bit[0] always reads as zero when in ARM, Thumb, or ThumbEE state.

———— **Note** ————

The existence of bit[0] as a valid address bit in the PC is visible in ARM, Thumb, or ThumbEE states only when an exception occurs in Jazelle state and the exception return address is odd-byte aligned.

### B1.13.2 Exception handling in the Jazelle extension

*Exception handling on page B1-1164* describes exception entry for an exception that occurs while the processor is executing in Jazelle state. This section gives more information about how exceptions in Jazelle state are taken and handled. Because an implementation that includes the Virtualization Extensions cannot include a non-trivial Jazelle implementation, exceptions taken from Jazelle state are always taken to and handled in a PL1 mode.

#### IRQ and FIQ interrupts

To ensure the standard mechanism for handling interrupts works correctly, a Jazelle hardware implementation must ensure that one of the following applies at the point where execution of a Java bytecode instruction might be interrupted by an IRQ or FIQ:

- Execution has reached a bytecode instruction boundary. That is:
  - all operations required to implement one bytecode instruction have completed
  - no operation required to implement the next bytecode instruction has completed.The LR value on entry to the interrupt handler must be (address of the next bytecode instruction) + 4.
- The sequence of operations performed from the start of execution of the current bytecode instruction, up to the point where the interrupt occurs, is idempotent. This means that the sequence can be repeated from its start without changing the overall result of executing the bytecode instruction.  
The LR value on entry to the interrupt handler must be (address of the current bytecode instruction) + 4.
- Corrective action is taken either:
  - directly by the Jazelle extension hardware
  - indirectly, by calling a SUBARCHITECTURE DEFINED handler in the EJVM.The corrective action must re-create a situation where the bytecode instruction can be re-executed from its start.  
The LR value on entry to the interrupt handler must be (address of the interrupted bytecode instruction) + 4.

In an implementation that includes the Virtualization Extensions, these options apply, also, to the point where execution might be interrupted by a virtual IRQ or virtual FIQ:

## Data Abort exceptions

The standard mechanism for handling a Data Abort exception is:

- read the Fault Status and Fault Address registers
- fix the reason for the abort
- return using SUBS PC, LR, #8 or its equivalent.

The abort handler must be able to do this without looking at the instruction that caused the abort, and without knowing the instruction set state it was executed in.

---

### Note

- This assumes that the intention is to return to and retry the bytecode instruction that caused the Data Abort exception. If the intention is instead to return to the bytecode instruction after the one that caused the abort, then the return address must be modified by the length of the bytecode instruction that caused the abort.
  - For details of the exception reporting, see:
    - [Exception reporting in a VMSA implementation on page B3-1409](#), for a VMSA implementation
    - [Exception reporting in a PMSA implementation on page B5-1767](#), for a PMSA implementation.
- 

To ensure the standard mechanism for handling Data Abort exceptions works correctly, a Jazelle hardware implementation must ensure that one of the following applies at any point where a Java bytecode instruction can generate a Data Abort exception:

- The sequence of operations performed from the start of execution of the bytecode instruction, up to the point where the Data Abort exception is generated, is idempotent. This means that the sequence can be repeated from its start without changing the overall result of executing the bytecode instruction.
- If the Data Abort exception is generated during execution of a bytecode instruction, corrective action is taken either:
  - directly by the Jazelle extension hardware
  - indirectly, by calling a SUBARCHITECTURE DEFINED handler in the EJVM.

The corrective action must re-create a situation where the bytecode instruction can be re-executed from its start.

---

### Note

From ARMv6, the ARM architecture does not support the Base Updated Abort Model. This removes a potential obstacle to the first of these solutions. For information about the Base Updated Abort Model in earlier versions of the ARM architecture see [The ARM abort model on page AppxO-2602](#).

---

## Prefetch Abort exceptions

On taking a Prefetch Abort exception, the Prefetch Abort exception handler can use the value saved in LR\_abt to locate the start of the instruction that caused the abort, without knowing the instruction set state in which its execution was attempted. The start of this instruction is always at address (LR\_abt – 4).

A multi-byte bytecode instruction can cross a page boundary. In this case the Prefetch Abort exception handler cannot use LR\_abt to determine which of the two pages caused the abort. Instead, in an ARMv7 implementation, for any exception taken to a PL1 mode, the IFAR indicates the faulting address.

## Supervisor Call and Secure Monitor Call exceptions

Supervisor Call and Secure Monitor Call exceptions cannot be generated during Jazelle state execution. To generate one of these exceptions, a Jazelle implementation must exit to a software handler that executes an SVC or SMC instruction.

## Undefined Instruction exceptions

The Undefined Instruction exception cannot be taken during Jazelle state execution, except that on a trivial implementation of the Jazelle extension, the UNPREDICTABLE behavior described in *Exception return to an unimplemented instruction set state* on page B1-1196 might include taking the Undefined Instruction exception.

### B1.13.3 Jazelle state configuration and control

For details of the configuration and control of Jazelle state from the application level, see *Application level configuration and control of the Jazelle extension* on page A2-99. That section includes a summary of the Jazelle extension registers. For descriptions of the registers see:

- for a VMSA implementation, [JIDR](#), [JMCR](#), and [JOSCR](#)
- for a PMSA implementation, [JIDR](#), [JMCR](#), and [JOSCR](#).

[JIDR](#) and [JMCR](#) can be accessed from PL0. [JOSCR](#) is accessible only from PL1 or higher.

---

#### Note

VMSA and PMSA implementations of the Jazelle registers are identical. The registers are described both in [Chapter B4 System Control Registers in a VMSA implementation](#) and in [Chapter B6 System Control Registers in a PMSA implementation](#).

In an implementation that includes the Security Extensions, the Jazelle registers are Common registers, see [Common system control registers](#) on page B3-1457. Each register has the same access permissions in both security states. For more information, see the register descriptions.

---

#### Note

- Normally, an EJVM never accesses the [JOSCR](#).
- An EJVM that runs in User mode must not attempt to access the [JOSCR](#).

The [JOSCR](#) provides a control mechanism that is independent of the subarchitecture of the Jazelle extension. An operating system can use this mechanism to control access to the Jazelle extension. The [JOSCR.CV](#) and [JOSCR.CD](#) are both set to 0 on reset. This ensures that, subject to some conditions, an EJVM can operate under an OS that does not support the Jazelle extension. The main condition required to ensure an EJVM can operate under an OS that does not support the Jazelle extension is that the operating system never swaps between two EJVM processes that require different settings of the Jazelle configuration registers.

Two examples of how this condition can be met in a system are:

- if there is only ever one process or thread using the EJVM
- if all of the processes or threads that use the EJVM use the same static settings of the configuration registers.

## Controlling entry to Jazelle state

The normal method of entering Jazelle state is using the [BXJ](#) instruction, see *Jazelle state entry instruction, BXJ* on page A2-98. The operation of this instruction depends on the values of both [JMCR.JE](#) and [JOSCR.CV](#).

When the [JMCR.JE](#) bit is 0, the [JOSCR](#) has no effect on the execution of [BXJ](#) instructions. They always execute as [BX](#) instructions, and there is no attempt to enter Jazelle state.

When the [JMCR.JE](#) bit is 1, the [JOSCR.CV](#) bit controls the operation of [BXJ](#) instructions:

**If CV == 1** The Jazelle extension hardware configuration is valid and enabled. A [BXJ](#) instruction causes the processor to enter Jazelle state in SUBARCHITECTURE DEFINED circumstances, and execute bytecode instructions as described in *Executing BXJ with Jazelle extension enabled* on page A2-98.

**If CV == 0** The Jazelle extension hardware configuration is not valid and therefore entry to Jazelle state is disabled.

In all SUBARCHITECTURE DEFINED circumstances where, if CV had been 1 the BXJ instruction would have caused the Jazelle extension hardware to enter Jazelle state, it instead:

- enters a Configuration Invalid handler
- sets CV to 1.

A Configuration Invalid handler is a sequence of instructions that:

- includes MCR instructions to write the configuration required by the EJVM
- ends with a BXJ instruction to re-attempt execution of the required bytecode instruction.

The following are SUBARCHITECTURE DEFINED:

- how the address of the Configuration Invalid handler is determined
- the entry and exit conditions of the Configuration Invalid handler.

In circumstances in which the Jazelle extension hardware would not have entered Jazelle state if CV had been 1, it is IMPLEMENTATION DEFINED whether:

- the Configuration Invalid handler is entered
- a SUBARCHITECTURE DEFINED handler is entered, as described in [Executing BXJ with Jazelle extension enabled on page A2-98](#).

In ARMv7, the JOSCVR.CV bit is set to 0 on exception entry for all implementations other than a trivial implementation of the Jazelle extension.

The intended use of the JOSCR.CV bit is:

1. When a context switch occurs, JOSCR.CV is set to 0. This is done by the operating system or, in ARMv7, as the result of an exception.
2. When the new process or thread performs a BXJ instruction to start executing bytecode instructions, the Configuration Invalid handler is entered and JOSCR.CV is set to 1.
3. The Configuration Invalid handler:
  - writes the configuration required by the EJVM to the Jazelle configuration registers
  - retries the BXJ instruction to execute the bytecode instruction.

This ensures that the Jazelle extension configuration registers are set up correctly for the EJVM concerned before any bytecode instructions are executed. It successfully handles cases where a context switch occurs during execution of the Configuration Invalid handler.

In an implementation that includes the Virtualization Exceptions, accesses to the Jazelle system control registers from Non-secure PL1 and PL0 modes can be trapped to Hyp mode, see [Trapping accesses to Jazelle functionality on page B1-1255](#).

## Monitoring and controlling User mode access to the Jazelle extension

The system can use the JOSCR.CD bit in different ways to monitor and control User mode access to the Jazelle extension hardware. Possible uses include:

- An OS can set JOSCR.CD to 1 and JMCR.JE to 0, to prevent all User mode access to the Jazelle extension hardware. With these settings any use of the BXJ instruction has the same result as a BX instruction, and any attempt to configure the hardware, including any attempt to set the JMCR.JE bit to 1, results in an Undefined Instruction exception.

- A simple mechanism for the OS to provide User mode access to the Jazelle extension hardware, while protecting EJVMs from conflicting use of the hardware by other processes, is:
  - Set the `JOSCR.CD` bit to 0.
  - Preserve and restore the `JMCR` on context switches, initializing its value to 0 for new processes.
  - The `JOSCR.CV` bit is set to 0 on each context switch, either by the operating system or, in ARMv7, as the result of an exception. This ensures that EJVMs reconfigure the Jazelle extension hardware to match their requirements when necessary.

The context switch mechanism is described in [Controlling entry to Jazelle state on page B1-1242](#).

#### B1.13.4 EJVM operation

[EJVM operation on page A2-100](#) described the architectural requirements for an EJVM at the Application level. Because the EJVM is provided for use by applications, the system level description of the architecture does not require significant additional information about the EJVM.

[Initialization on page A2-100](#) stated that, if the EJVM is compatible with the subarchitecture, the EJVM must write its required configuration to the `JMCR` and any other configuration registers. The EJVM must not omit this step on the assumption that the `JOSCR.CV` bit is 0. In other words, the EJVM must not assume that `JOSCR.CV` is set to 0, and that this will trigger entry to the Configuration Invalid handler before any bytecode instruction is executed by the Jazelle extension hardware.

#### B1.13.5 Trivial implementation of the Jazelle extension

[Jazelle direct bytecode execution support on page A2-97](#) introduced the possible trivial implementation of the Jazelle extension, and summarized the application level requirements of a trivial implementation. This section gives the system level description of a trivial implementation of the Jazelle extension.

The Virtualization Extensions require that the Jazelle implementation is the trivial Jazelle implementation.

A trivial implementation of the Jazelle extension must:

- Implement the `JIDR` with the implementer and subarchitecture fields set to zero. The register can be implemented so that the whole register is RAZ.
- Implement the `JMCR` as RAZ/WI.
- Implement the `JOSCR` either:
  - so that it can be read and written, but its effects are ignored
  - as RAZ/WI.

This ensures that operating systems that support an EJVM execute correctly.

- Implement the `BXJ` instruction to behave identically to the `BX` instruction in all circumstances, as required by the fact that the `JMCR.JE` bit is always zero. This means that, with a trivial implementation of the Jazelle extension, Jazelle state can never be entered normally.

———— **Note** —————

As described in [Trapping accesses to Jazelle functionality on page B1-1255](#), if `HSTR.TJDBX` is set to 1, an otherwise-valid execution of a `BXJ` instruction is trapped to Hyp mode, but execution of a `BX` instruction is not trapped. In this respect only, `BXJ` and `BX` behave differently.

- Treat Jazelle state as an unimplemented instruction set state, as described in [Exception return to an unimplemented instruction set state on page B1-1196](#).

A trivial implementation does not have to extend the PC to 32 bits, that is, it can implement `PC[0]` as RAZ/WI. This is because the only way that `PC[0]` is visible in ARM or Thumb state is as a result of a processor exception occurring during Jazelle state execution, and Jazelle state execution cannot occur on a trivial implementation.



## B1.13.6 Jazelle state

All processor state information that can be modified by Jazelle state execution is held in registers that are visible at the application level, as described in *ARM core registers* on page B1-1143 and *The Application Program Status Register (APSR)* on page A2-49. Configuration information can be kept either in these application level registers or in Jazelle configuration registers that are accessible at the Application level, see *Application level configuration and control of the Jazelle extension* on page A2-99. This might include configuration registers that are Jazelle SUBARCHITECTURE DEFINED. This ensures that the processor configuration information is preserved and restored correctly when processor exceptions and context switches occur. In this context, configuration information is information that affects Jazelle state execution but is not modified by it.

An EJVM implementation must check whether the implemented Jazelle extension is compatible with its use of the application level registers. If the implementation is compatible, the EJVM sets `JMCR.JE` to 1. If the implementation is not compatible, the EJVM sets `JMCR.JE` to 0, and executes without hardware acceleration.

### Jazelle state exit

The processor exits Jazelle state in IMPLEMENTATION DEFINED circumstances. Typically, this is due to attempted execution of a bytecode instruction that the implementation cannot handle in hardware, or that generates one of the Java exceptions described in *The Java Virtual Machine Specification*. On exit from Jazelle state, various processor registers contain SUBARCHITECTURE DEFINED values, enabling the EJVM to resume software execution of the bytecode program correctly.

The processor also exits Jazelle state if it takes an exception. In this case, the `CPSR` is copied to the Banked `SPSR` for the mode to which the exception is taken, so the Banked `SPSR` contains `J == 1` and `T == 0`. This means re-enters Jazelle state on return from the exception, when the `SPSR` is copied back into the `CPSR`. With the restriction that Jazelle state execution can modify only application level registers, this ensures that all registers are correctly preserved and can be restored by the exception handlers. Configuration and control registers can be modified in the exception handler itself as described in *Jazelle state configuration and control* on page B1-1242.

Specific considerations apply to the processor taking an exception from Jazelle state, see *Exception handling in the Jazelle extension* on page B1-1240.

It is IMPLEMENTATION DEFINED whether Jazelle extension hardware contains state that is both:

- modified during Jazelle state execution
- held outside the application level registers during Jazelle state execution.

If such state exists, the implementation must:

- Initialize the state from one or more of the application level registers whenever Jazelle state is entered, whether as the result of:
  - the execution of a `BXJ` instruction
  - the processor returning from taking an exception.
- Write the state into one or more of the application level registers whenever Jazelle state is exited, whether as a result of the processor taking an exception, or of IMPLEMENTATION DEFINED circumstances.
- Ensure that the mechanism for writing the state into application level registers on the processor taking an exception, and initializing the state from application level registers on returning from that exception, ensures that the state is correctly preserved and restored over the exception.

### Additional Jazelle state restrictions

The Virtualization Extensions require that the Jazelle implementation is the trivial Jazelle implementation. Therefore a processor that implements the Virtualization Extensions cannot enter Jazelle state.

Execution in Jazelle state is UNPREDICTABLE in FIQ mode.

Otherwise, the Jazelle extension hardware must obey the following restrictions:

- It must not change processor mode other than by taking one of the processor exceptions described in [Exception descriptions on page B1-1204](#).
- It must not access Banked copies of registers other than the ones belonging to the processor mode in which it is entered.
- It must not do anything that is illegal for an UNPREDICTABLE instruction, see [UNPREDICTABLE](#).

As a result of these requirements, Jazelle state can be entered from PL0 without risking a breach of OS security.

## B1.14 Traps to the hypervisor

This section describes the traps the Virtualization Extensions provide, that software executing at PL2 can use to trap Non-secure operations performed at PL1 or PL0.

In a similar way, software executing at PL2 can route a number of exceptions to be taken to Hyp mode. Therefore, the trapping and related mechanisms provided by the Virtualization Extensions include:

- Trapping attempted execution of certain instructions to Hyp mode, so a hypervisor can emulate the instruction. This section describes these traps.
- Routing certain synchronous exceptions to Hyp mode, see:
  - [Routing general exceptions to Hyp mode on page B1-1191](#)
  - [Routing Debug exceptions to Hyp mode on page B1-1193](#).

———— **Note** —————

- These controls for routing synchronous exceptions to Hyp mode are similar to the controls for the traps described in this section, and [Summary of trap controls on page B1-1261](#) includes these trap controls.
- In addition, a hypervisor can route interrupts and asynchronous external aborts to itself. For more information see [Asynchronous exception routing controls on page B1-1174](#).

- Providing aliased versions of some system control registers, see [Trapping ID mechanisms on page B1-1250](#).

Because of the wide range of usage models for virtualization, the Virtualization Extensions provide many trapping options, support different levels of granularity of the trapping. The following sections describe these trapping options:

- [General information about traps to the hypervisor on page B1-1248](#)
- [Trapping ID mechanisms on page B1-1250](#)
- [Trapping accesses to lockdown, DMA, and TCM operations on page B1-1252](#)
- [Trapping accesses to cache maintenance operations on page B1-1253](#)
- [Trapping accesses to TLB maintenance operations on page B1-1253](#)
- [Trapping accesses to the Auxiliary Control Register on page B1-1253](#)
- [Trapping accesses to the Performance Monitors Extension on page B1-1254](#)
- [Trapping use of the SMC instruction on page B1-1254](#)
- [Trapping use of the WFI and WFE instructions on page B1-1255](#)
- [Trapping accesses to Jazelle functionality on page B1-1255](#)
- [Trapping accesses to the ThumbEE configuration registers on page B1-1255](#)
- [Trapping accesses to coprocessors on page B1-1256](#)
- [Trapping writes to virtual memory control registers on page B1-1257](#)
- [Generic trapping of accesses to CP15 system control registers on page B1-1258](#)
- [Trapping CP14 accesses to debug registers on page B1-1259](#)
- [Trapping CP14 accesses to trace registers on page B1-1260](#)
- [Summary of trap controls on page B1-1261](#).

———— **Note** —————

Many of these sections include a Note that indicates when or why a hypervisor might use the traps described in that section. This information is not part of the architecture specification.

These sections include descriptions of trapping Debug configuration options that can generate traps when the processor is in Non-debug state. The Virtualization Extensions do not provide any trapping in Debug state.

## B1.14.1 General information about traps to the hypervisor

The Hyp Trap exception provides the standard mechanism for trapping Guest OS functions to the hypervisor. The processor always takes a Hyp Trap exception to Hyp mode, and enters the exception handler using the vector at offset 0x14 from the Hyp vector base address. For more information see [Exception handling on page B1-1164](#).

When the processor enters the handler for a Hyp Trap exception, the HSR holds syndrome information for the exception. For more information see [Use of the HSR on page B3-1424](#).

A Hyp Trap exception can be generated only when all of the following apply:

- The processor is both:
  - not in Debug state
  - in a Non-secure PL1 or PL0 mode.
- The trapped instruction is not UNPREDICTABLE in the mode in which it is executed. UNPREDICTABLE instructions can generate a Hyp Trap exception, but the architecture does not require them to do so, see [UNPREDICTABLE](#).
- The trapped instruction is not UNDEFINED in the mode in which it is executed, except for the following cases in which an UNDEFINED instruction might cause a Hyp Trap exception:
  - a trapped conditional UNDEFINED instruction that, if it was not trapped, would generate an Undefined Instruction exception, see [Hyp traps on instructions that fail their condition code check on page B1-1249](#)
  - a PL0 mode access to IMPLEMENTATION DEFINED CP15 features in primary CP15 register c9-c11, see [Trapping accesses to lockdown, DMA, and TCM operations on page B1-1252](#)
  - a PL0 mode access to an IMPLEMENTATION DEFINED CP15 register for which there is a generic Hyp trap, see [Generic trapping of accesses to CP15 system control registers on page B1-1258](#)
  - when HCR.TGE is set to 1, any instruction executed in a Non-secure PL1 or PL0 mode that generates an Undefined Instruction exception, see [Undefined Instruction exception, when HCR.TGE is set to 1 on page B1-1191](#).

### ———— Note —————

- These rules mean that, for traps on system control register accesses, unless the specific trap description states otherwise:
  - If the register description in this manual describes the register as not being accessible from User mode in Non-secure state, the Virtualization Extensions do not change this behavior. User mode accesses to the register cannot be trapped.
  - If the register description in this manual describes the register as being accessible from User mode in Non-secure state, when accesses to the register are trapped to Hyp mode the trap applies to accesses from both Non-secure PL1 modes and from the Non-secure PL0 mode.
- Traps to Hyp mode never apply in Secure state, regardless of the value of the SCR.NS bit.
- Although a Hyp Trap exception cannot be generated when the processor is in Hyp mode, the HCPTR restricts coprocessor accesses in Hyp mode, as well as in the Non-secure PL1 modes. If the HCPTR settings generate an exception when the processor is in Hyp mode, that exception is taken using the Hyp mode Undefined Instruction vector, not the Hyp Trap vector.
- PL0 mode is a synonym for User mode.

Many instructions that can be trapped by a Hyp trap are UNDEFINED in User mode. For one of these instructions, enabling a Hyp trap on the instruction has no effect on operation in Non-secure User mode. A small number of traps also apply to operations in Non-secure User mode. This means they trap operations at PL0 and at PL1.

## Hyp traps on instructions that fail their condition code check

If the processor executes an instruction that has a Hyp trap set, and that instruction fails its condition code check, unless the specific trap description states otherwise, it is IMPLEMENTATION DEFINED which of the following occurs:

- the instruction generates a Hyp Trap exception
- the instruction executes as a NOP.

### ———— Note ————

The architecture requires that a Hyp trap on a conditional SMC instruction generates an exception only if the instruction passes its condition code check, see *Trapping use of the SMC instruction on page B1-1254*.

This is consistent with the treatment of conditional undefined instructions, as described in *Conditional execution of undefined instructions on page B1-1208*. Any implementation must be consistent in its handling of instructions that fail their condition code check, meaning that whenever a Hyp trap is set on such an instruction it must either:

- always generate a Hyp Trap exception
- always treat the instruction as a NOP.

This requirement that an implementation is consistent in its handling of instructions that fail their condition code check also means that the IMPLEMENTATION DEFINED part of the requirements of *Conditional execution of undefined instructions on page B1-1208* must be consistent with the handling of Hyp traps on instructions that fail their condition code check, as *Table B1-25* shows:

**Table B1-25 Consistent handling of instructions that fail their condition code check**

Behavior of conditional UNDEFINED instruction <sup>a</sup>	Hyp trap on instruction that fails its condition code check <sup>b</sup>
Executes as a NOP	Executes as a NOP
Generates an Undefined Instruction exception	Generates a Hyp Trap exception

- a. As defined in *Conditional execution of undefined instructions on page B1-1208*. In Non-secure PL1 and PL0 modes, applies only if no Hyp trap is set for the instruction, otherwise see the behavior in the other column of the table.
- b. For a trapped instruction executed in a Non-secure PL1 or PL0 mode.

## Hyp traps on instructions that are UNPREDICTABLE

For an instruction that is UNPREDICTABLE, but is in a class that has a Hyp trap, the behavior of the instruction when the Hyp trap is enabled is UNPREDICTABLE. The architecture permits such an instruction to generate a Hyp Trap exception, but does not require it to do so.

### ———— Note ————

UNPREDICTABLE behavior must not perform any function that cannot be performed at the current or lower level of privilege using instructions that are not UNPREDICTABLE. This means that setting a Hyp trap on an instruction changes the set of instructions that might be executed in Non-secure state at PL1 or PL0. This affects, indirectly, the permitted behavior of UNPREDICTABLE instructions.

If no instructions are configured to generate Hyp traps, then the attempted execution of an UNPREDICTABLE instruction in a Non-secure PL1 or PL0 mode cannot generate a Hyp Trap exception.

## Hyp traps on instructions that are UNDEFINED

Except where explicitly stated in this manual, if an enabled Hyp trap is associated with an instruction that would otherwise be UNDEFINED, attempting to execute that instruction from a Non-secure PL1 or PL0 mode generates an Undefined Instruction exception, not a Hyp Trap exception.

## Traps of register access instructions

When an attempt to execute an instruction is trapped to Hyp mode, the trap is taken before execution of the instruction. This means that, if the trapped instruction is a register access instruction, before taking the Hyp Trap exception:

- no register access is made
- no side-effects normally associated with the register access occur.

### B1.14.2 Trapping ID mechanisms

---

#### Note

---

The processor ID registers that can be accessed from Non-secure state can present a virtualization hole, since system software can use them to determine information about the physical hardware that a hypervisor might want to conceal. However, many uses of virtualization do not require the hypervisor to disguise the identity of the physical processor.

For a small number of frequently-accessed ID registers, the Virtualization Extensions provide read/write aliases of the registers, accessible only from Hyp mode, or from Secure state. A read of the original ID register from a Non-secure PL1 mode actually returns the value of the read/write alias register. This register substitution is invisible to the software reading the register.

**Table B1-26 ID register substitution by the Virtualization Extensions**

Physical ID register	RW alias register
MIDR	VPIDR
MPIDR	VMPIDR

A reset sets [VPIDR](#) to the [MIDR](#) value, and [VMPIDR](#) to the [MPIDR](#) value.

Reads of [MIDR](#) or [MPIDR](#) from Hyp mode or from Secure state are unchanged by the Virtualization Extensions, and access the physical registers. This also applies to accesses from Monitor mode with [SCR.NS](#) set to 1.

---

#### Note

---

A hypervisor often has to virtualize one or both of the [MIDR](#) and [MPIDR](#) because:

- the [MIDR](#) provides information about the implementer, the processor name, and revision information
- in a multiprocessor implementation, the [MPIDR](#) defines the processor position within a cluster.

The Virtualization Extensions divide the remaining ID registers into a number of groups, and provide a bit for each group in the [HCR](#), to control trapping of accesses to that group of registers. Setting one of these [HCR](#) bits to 1 means that any attempt to read a register in that group from a Non-secure mode other than Hyp mode generates a Hyp Trap exception, unless the register description indicates that the attempted access is UNDEFINED. This trap has no effect on writes to these registers.

---

#### Note

---

Most but not all of the ID registers are RO registers, and write accesses to these registers behave as described in [Read-only and write-only register encodings](#) on page B3-1449. Each register description identifies whether the register is RO.

Table B1-27 shows the HCR trap bits, and references the subsections that define the registers in each group. Each group description also indicates how the trap is reported to the exception handler.

**Table B1-27 ID register groups for Hyp Trap exceptions**

Trap bit	Register group definition
HCR.TID0	ID group 0, Primary device identification registers
HCR.TID1	ID group 1, Implementation identification registers
HCR.TID2	ID group 2, Cache identification registers
HCR.TID3	ID group 3, Detailed feature identification registers on page B1-1252

### ID group 0, Primary device identification registers

———— **Note** —————

With [MIDR](#) and [MPIDR](#), these registers provide the coarse-grained identification mechanisms that software is likely to access.

The registers that are in ID group 0 for Hyp traps are the [FPSID](#) register and the [JIDR](#).

When an exception is taken because [HCR.TID0](#) is set to 1, the [HSR](#) reports the exception:

- using EC value 0x05, trapped CP14 access, for a read of [JIDR](#)
- using EC value 0x08, trapped CP10 access, for a read of [FPSID](#).

If the [HCPTR](#) traps accesses to CP10 and CP11, then for a read of [FPSID](#) that trap has priority over the ID group 0 trap. For more information, see [Trapping accesses to coprocessors on page B1-1256](#).

For more information about the exception reporting, see [Use of the HSR on page B3-1424](#).

### ID group 1, Implementation identification registers

———— **Note** —————

In ARMv7, these registers often provide coarse-grained identification mechanisms for implementation-specific features.

The registers that are in ID group 1 for Hyp traps are the [TCMTR](#), [TLBTR](#), [REVIDR](#), and [AIDR](#).

When an exception is taken because [HCR.TID1](#) is set to 1, the [HSR](#) reports the exception as a trapped CP15 access, using the EC value 0x03, see [Use of the HSR on page B3-1424](#).

### ID group 2, Cache identification registers

———— **Note** —————

These are the registers that describe and control the cache implementation.

The registers that are in ID group 2 for Hyp traps are the [CTR](#), [CCSIDR](#), [CLIDR](#), and [CSSELR](#).

When an exception is taken because [HCR.TID2](#) is set to 1, the [HSR](#) reports the exception as a trapped CP15 access, using the EC value 0x03, see [Use of the HSR on page B3-1424](#).

## ID group 3, Detailed feature identification registers

### Note

These are the CUID registers, that provide detailed information about the features of the processor implementation. In many implementations of virtualization the hypervisor will not trap accesses to registers in this group. The architecture only requires this trap to apply to the registers listed in this section. There is no requirement for the trap to apply to the registers that [Chapter B7 The CUID Identification Scheme](#) defines as reserved.

The registers that are in ID group 3 for Hyp traps are the [ID\\_PFR0](#), [ID\\_PFR1](#), [ID\\_DFR0](#), [ID\\_AFR0](#), [ID\\_MMFR0](#), [ID\\_MMFR1](#), [ID\\_MMFR2](#), [ID\\_MMFR3](#), [ID\\_ISAR0](#), [ID\\_ISAR1](#), [ID\\_ISAR2](#), [ID\\_ISAR3](#), [ID\\_ISAR4](#), [ID\\_ISAR5](#), [MVFR0](#), and [MVFR1](#).

When an exception is taken because [HCR.TID3](#) is set to 1, the [HCR](#) reports the exception:

- using EC value `0x08`, trapped CP10 access, for a read of [MVFR0](#) or [MVFR1](#)
- using EC value `0x03`, trapped CP15 access, for a read of any other register in the group.

If the [HCPTR](#) traps accesses to CP10 and CP11, then for reads of [MVFR0](#) and [MVFR1](#), that trap has priority over the ID group 3 trap. For more information, see [Trapping accesses to coprocessors on page B1-1256](#).

For more information about the exception reporting, see [Use of the HSR on page B3-1424](#).

### B1.14.3 Trapping accesses to lockdown, DMA, and TCM operations

The lockdown, DMA, and TCM features of the ARM architecture are IMPLEMENTATION DEFINED. However, the architecture reserves the following CP 15 register encodings for control of these features:

- $CRn=c9$ ,  $opc1=\{0-7\}$ ,  $CRm=\{c0-c2, c5-c8\}$ ,  $opc2=\{0-7\}$ , see [Cache and TCM lockdown registers, VMSA on page B4-1750](#)
- $CRn=c10$ ,  $opc1=\{0-7\}$ ,  $CRm=\{c0, c1, c4, c8\}$ ,  $opc2=\{0-7\}$ , see [VMSA CP15 c10 register summary, memory remapping and TLB control registers on page B3-1478](#)
- $CRn=c11$ ,  $opc1=\{0-7\}$ ,  $CRm=\{c0-c8, c15\}$ ,  $opc2=\{0-7\}$ , see [VMSA CP15 c11 register summary, reserved for TCM DMA registers on page B3-1478](#).

Setting [HCR.TIDCP](#) to 1 means:

- any attempt to use an MCR or MRC instruction with one of these encodings from a Non-secure PL1 mode generates a Hyp Trap exception
- on an attempt to use an MCR or MRC instruction with one of these encodings from Non-secure PL0 mode, it is IMPLEMENTATION DEFINED which of the following occurs:
  - the processor takes the Hyp Trap exception
  - the processor treats the instruction as UNDEFINED, and takes the Undefined Instruction exception to Non-secure Undefined mode
- any lockdown fault in the memory system caused by the use of these operations in Non-secure state generates a Data Abort exception that is taken to Hyp mode.

An implementation can include IMPLEMENTATION DEFINED registers that provide additional controls, to give finer-grained control of the trapping of IMPLEMENTATION DEFINED features.

When an exception is taken because [HCR.TIDCP](#) is set to 1, the [HSR](#) reports the exception as a trapped CP15 access, using the EC value `0x03`, see [Use of the HSR on page B3-1424](#).

### Note

- ARM expects the trapping of Non-secure User mode access to these functions to Hyp mode to be unusual, and used only when the hypervisor is virtualizing User mode operation. ARM strongly recommends that, unless the hypervisor must virtualize User mode operation, a Non-secure User mode access to any of these functions generates an Undefined Instruction exception, as it would if the implementation did not include the Virtualization Extensions. The processor then takes this exception to Non-secure Undefined mode.



- The trapping of all attempted accesses to these registers from Non-secure PL1 modes overrides the general behavior described in *Hyp traps on instructions that are UNDEFINED* on page B1-1249.

#### B1.14.4 Trapping accesses to cache maintenance operations

———— **Note** —————

Virtualizing a uniprocessor system within an MP system, permitting a virtual machine to move between different physical processors, makes cache maintenance by set/way difficult. This is because a set/way operation might be interrupted part way through its operation, and therefore the hypervisor must reproduce the effect of the maintenance on both physical processors

Table B1-28 shows the HCR trap bits that trap cache maintenance operations to the hypervisor. When one of these bits is set to 1, any attempt to access one of the corresponding CP15 c7 operations from a Non-secure PL1 mode generates a Hyp Trap exception.

**Table B1-28 Control of Hyp traps for cache maintenance operations**

Trap bit	Traps	Trapped operations
HCR.TSW	Data cache maintenance by set/way	DCISW, DCCSW, DCCISW
HCR.TPC	Data cache maintenance to point of coherency	DCIMVAC, DCCIMVAC, DCCMVAC
HCR.TPU	Cache maintenance to point of unification	ICIMVAU, ICIALLU, ICIALLUIS, DCCMVAU

For any of these traps, when the exception is taken, the HSR reports the exception as a trapped CP15 access, using the EC value 0x03, see *Use of the HSR* on page B3-1424.

For more information about these operations, see *Cache and branch predictor maintenance operations, VMSA* on page B4-1740.

#### B1.14.5 Trapping accesses to TLB maintenance operations

Setting HCR.TTLB to 1 means that any attempt to access one of the CP15 c8 maintenance operations from a Non-secure PL1 mode generates a Hyp Trap exception. The trapped operations are TLBIALLIS, TLBIMVAIS, TLBIASIDIS, TLBIMVAAIS, DTLBIALL, ITLBIALL, DTLBIMVA, ITLBIMVA, DTLBIASID, ITLBIASID, TLBIMVAA

When an exception is taken because HCR.TTLB is set to 1, the HSR reports the exception as a trapped CP15 access, using the EC value 0x03, see *Use of the HSR* on page B3-1424.

For more information about these operations, see *TLB maintenance operations, not in Hyp mode* on page B4-1743.

#### B1.14.6 Trapping accesses to the Auxiliary Control Register

———— **Note** —————

The ACTLR is an IMPLEMENTATION DEFINED register that might implement global control bits for the processor. An attempt by a Guest OS to access the ACTLR is a potential virtualization problem. Trapping these accesses to the hypervisor means the hypervisor can react, typically by emulating the required function or signaling a virtualization error.

Setting HCR.TAC to 1 means that any attempt to access the ACTLR from Non-secure state other than from Hyp mode generates a Hyp Trap exception, unless the IMPLEMENTATION DEFINED register description indicates that the attempted access is UNDEFINED.

When an exception is taken because HCR.TAC is set to 1, the HSR reports the exception as a trapped CP15 access, using the EC value 0x03, see *Use of the HSR* on page B3-1424.

## B1.14.7 Trapping accesses to the Performance Monitors Extension

### ———— Note —————

A hypervisor might assign Performance Monitors functionality to a particular Guest OS, or might virtualize performance monitoring. The Virtualization Extensions provide a trap bit that, when set to 1, traps all CP15 accesses to the Performance Monitors to the Hyp Trap exception. A hypervisor might use this as part of a lazy context switch that assigns the Performance Monitors to a particular Guest OS, or might use it as part of a virtualization approach. A second trap bit traps accesses to the [PMCR](#). The hypervisor can use this in emulating the Performance Monitors identification bits.

The Performance Monitors Extension is an OPTIONAL extension to an ARMv7 implementation. The processor accesses the Performance Monitors Extension registers through the CP15 c9 registers with  $opc1 == \{0-7\}$ ,  $CRm == \{c12-c15\}$ ,  $opc2 == \{0-7\}$ .

In an implementation that includes the Performance Monitors Extension:

- Setting [HDCR.TPM](#) to 1 traps accesses to the Performance Monitors Extension registers to Hyp mode. When this bit is set to 1, any attempt to access these registers from a Non-secure PL1 or PL0 mode generates a Hyp Trap exception, unless the register description in [Performance Monitors registers on page C12-2326](#) indicates that the attempted access is UNDEFINED.
- Setting [HDCR.TPMCR](#) to 1 traps CP15 accesses to the [PMCR](#) to Hyp mode. The conditions for this trap are identical to those for the trap controlled by [HDCR.TPM](#).

For either of these traps, when the exception is taken, the [HSR](#) reports the exception as a trapped CP15 access, using the EC value 0x03, see [Use of the HSR on page B3-1424](#).

## B1.14.8 Trapping use of the SMC instruction

### ———— Note —————

Typically, a hypervisor determines whether a Guest OS can access Secure state directly. If the hypervisor does not permit a particular Guest OS to access Secure state directly, and that Guest OS attempts to change to Secure state, then the hypervisor must either report a virtualization error or emulate the required Secure state operation. To support this, the [HCR](#) includes a bit that traps use of the SMC instruction to the Hyp Trap exception.

When [HCR.TSC](#) is set to 1, an attempt to execute an SMC instruction from a Non-secure PL1 mode generates a Hyp Trap exception, regardless of the value of [SCR.SCD](#).

### ———— Note —————

When [HCR.TSC](#) is set to 0, [SCR.SCD](#) controls whether SMC instructions can be executed from Non-secure state:

- when [SCR.SCD](#) is set to 0, the SMC instruction executes normally in Non-secure state
- when [SCR.SCD](#) is set to 1, the SMC instruction is UNDEFINED in Non-secure state.

The [HCR.TSC](#) trap mechanism traps the attempted execution of a conditional SMC instruction only if the instruction passes its condition code check.

When an exception is taken because [HCR.TSC](#) is set to 1, the [HSR](#) reports the exception as a trapped SMC instruction, using the EC value 0x13, see [Use of the HSR on page B3-1424](#).

## B1.14.9 Trapping use of the WFI and WFE instructions

### ———— Note ————

An operating system can use the WFI mechanism to signal to the processor that it can suspend operation until it receives an interrupt. In a virtualized system, the hypervisor might use this signal as an indication that it can switch to another Guest OS. Therefore, the [HCR](#) includes a bit that traps attempted execution of a WFI instruction to the Hyp Trap exception.

Software can use the WFE mechanism to signal to the processor that it can suspend execution during polling of a variable, such as a spinlock. In a virtualized system, WFE might indicate an opportunity for the hypervisor to reschedule. However, WFE generally requires a shorter wait than WFI, and therefore there might be situations where rescheduling on WFE is not appropriate.

For this reason, the [HCR](#) includes separate bits for trapping WFI and WFE to the Hyp Trap exception.

When [HCR.TWI](#) is set to 1, and the processor is in a Non-secure mode other than Hyp mode, execution of a WFI instruction generates a Hyp Trap exception if, ignoring the value of the [HCR.TWI](#) bit, conditions permit the processor to suspend execution. For more information about when a WFI instruction can cause the processor to suspend execution, see [Wait For Interrupt on page B1-1202](#).

When [HCR.TWE](#) is set to 1, and the processor is in a Non-secure mode other than Hyp mode, execution of a WFE instruction generates a Hyp Trap exception if, ignoring the value of the [HCR.TWE](#) bit, conditions permit the processor to suspend execution. For more information about when a WFE instruction can cause the processor to suspend execution, see [Wait For Event and Send Event on page B1-1199](#).

For either of these traps, when the exception is taken, the [HSR](#) reports the exception as a trapped WFI or WFE instruction, using the EC value 0x01, see [Use of the HSR on page B3-1424](#).

## B1.14.10 Trapping accesses to Jazelle functionality

Setting [HSTR.TJDBX](#) to 1 means that, when the processor is in a Non-secure mode other than Hyp mode, the following generate a Hyp Trap exception:

- any access to the [JOSCR](#), [JMCR](#), or a Jazelle SUBARCHITECTURE DEFINED configuration register, that this reference manual or the Jazelle subarchitecture description does not describe as UNDEFINED
- any attempt to execute a BXJ instruction.

### ———— Note ————

- An implementation that includes the Virtualization Extensions must include only a trivial Jazelle implementation. These traps apply to the trivial Jazelle implementation.
- The [HSTR.TJDBX](#) trap does not trap accesses to the [JIDR](#). See, instead, [ID group 0, Primary device identification registers on page B1-1251](#).

When an exception is taken because [HSTR.TJDBX](#) is set to 1, the [HSR](#) reports the exception as:

- a trapped CP14 access, using EC value 0x05, for an access to a Jazelle register
- a trapped BXJ instruction, using EC value 0x0A, for execution of a BXJ instruction.

For more information about the exception reporting, see [Use of the HSR on page B3-1424](#).

## B1.14.11 Trapping accesses to the ThumbEE configuration registers

Setting [HSTR.TTEE](#) to 1 means that, when the processor is in a Non-secure mode other than Hyp mode, any access to the ThumbEE configuration registers [TEECR](#) and [TEEHBR](#) that this reference manual does not describe as UNDEFINED, generates a Hyp Trap exception.

When an exception is taken because [HSTR.TTEE](#) is set to 1, the [HSR](#) reports the exception as a trapped CP14 access, using the EC value 0x05, see [Use of the HSR on page B3-1424](#).

## B1.14.12 Trapping accesses to coprocessors

---

### Note

- A hypervisor might use the coprocessor access trapping mechanism as part of an implementation of lazy switching of Guest OSs.
- One function of the **CPACR** is as an ID register that identifies what coprocessor functionality is implemented. A hypervisor can trap **CPACR** accesses, to emulate this ID mechanism.

---

The **HCPTR** provides bits that trap coprocessor operations, to coprocessors other than CP14 and CP15, to Hyp mode. The traps controlled by the **HCPTR** apply regardless of whether the processor is in Debug state.

As described in *Access controls on CP0 to CP13 on page B1-1226*, the **HCPTR** traps are secondary to the controls provided by the **CPACR** and **NSACR**. Only if those controls permit a Non-secure access to a coprocessor can the **HCPTR** setting trap that access to Hyp mode.

If the **NSACR.cpn** control bit is set to 1, prohibiting Non-secure accesses to coprocessor *n*, then:

- Non-secure accesses to the coprocessor behave as if **HCPTR.TCn** is set to 1, regardless of the value of that bit
- Non-secure writes to the corresponding **HCPTR.TCn** bit are ignored
- Non-secure reads of **HCPTR.TCn** return 1, regardless of the actual value of that bit.

In addition, for the **HCPTR** traps on coprocessor accesses, and on the use of Advanced SIMD functionality, if a trap bit is set to 1, an attempt to access the trapped functionality from Hyp mode generates an Undefined Instruction exception, that is taken to Hyp mode.

The following subsections give more information about the **HCPTR** traps:

- *Trapping of Advanced SIMD functionality*
- *General trapping of coprocessor accesses on page B1-1257*
- *Trapping CPACR accesses on page B1-1257.*

*Trapping CP14 accesses to trace registers on page B1-1260* describes an additional **HCPTR** trap.

### Trapping of Advanced SIMD functionality

When the settings in the **CPACR** and **NSACR** permit Non-secure accesses to Advanced SIMD functionality, and **HCPTR.{TCP10, TCP11}** are set to 0, if **HCPTR.TASE** is set to 1, execution of any Advanced SIMD instruction:

- From a Non-secure mode other than Hyp mode generates a Hyp Trap exception.

---

### Note

If the **CPACR.ASEDIS** is set to 1, the **CPACR.ASEDIS** setting takes priority. This means any execution of an Advanced SIMD instruction by Non-secure software executing at PL1 or PL0 generates an Undefined Instruction exception, taken to Non-secure Undefined mode, and is not trapped to Hyp mode.

- From Hyp mode generates an Undefined Instruction exception, taken to Hyp mode, with the **HSR** holding a syndrome for the instruction.

---

### Note

When **HCPTR.TASE** is set to 0, if the **NSACR** settings permit Non-secure use of the Advanced SIMD functionality then Hyp mode can access that functionality, regardless of any settings in the **CPACR**.

---

When an exception is taken because **HCPTR.TASE** is set to 1, the **HSR** reports the exception as a **HCPTR**-trapped coprocessor access, using the EC value 0x07, see *Use of the HSR on page B3-1424*.

## General trapping of coprocessor accesses

The **HCPTR** defines a set of trap bits, TCP0 to TCP13, for trapping accesses to coprocessors CP0 to CP13. Setting **HCPTR.TCP $n$**  to 1 means that an access to coprocessor CP $n$  that is otherwise permitted:

- From a Non-secure mode other than Hyp mode, generates a Hyp Trap exception.

———— **Note** —————

If the **CPACR.cpn** field does not permit the PL1 or PL0 access, then the **CPACR.cpn** setting takes priority. This means the access generates an Undefined Instruction exception, taken to Non-secure Undefined mode, and is not trapped to Hyp mode.

- From Hyp mode, generates an Undefined Instruction exception, taken to Hyp mode, with the **HSR** holding a syndrome for the instruction.

———— **Note** —————

When **HCPTR.TCP $n$**  is set to 0, if the **NSACR** settings permit Non-secure use of coprocessor CP $n$  then Hyp mode can access that coprocessor, regardless of any settings in the **CPACR**.

When an exception is taken because an **HCPTR.TCP $n$**  bit is set to 1, the **HSR** reports the exception as a **HCPTR**-trapped coprocessor access, using the EC value 0x07, see [Use of the HSR on page B3-1424](#).

## Trapping CPACR accesses

When **HCPTR.TCPAC** is set to 1, any access to **CPACR** from a Non-secure PL1 mode generates a Hyp Trap exception.

When an exception is taken because **HCPTR.TCPAC** is set to 1, the **HSR** reports the exception as a trapped CP15 access, using the EC value 0x03, see [Use of the HSR on page B3-1424](#).

### B1.14.13 Trapping writes to virtual memory control registers

———— **Note** —————

The Virtualization Extensions provide a second stage of address translation, that a hypervisor can use to remap the address map defined by a Guest OS. In addition, a hypervisor can trap attempts by the Guest OS to write to the registers that control the Non-secure memory system. A hypervisor might use this trap as part of its virtualization of memory management.

Setting **HCR.TVM** to 1 means that any attempt, to write to a Non-secure memory control register from a Non-secure PL1 or PL0 mode, that this reference manual does not describe as UNDEFINED, generates a Hyp Trap exception. This trap applies to accesses to the **SCTLR**, **TTBR0**, **TTBR1**, **TTBCR**, **DACR**, **DFSR**, **IFSR**, **DFAR**, **IFAR**, **AxFSRs**, **PRRR**, **NMRR**, **MAIRs**, and the **CONTEXTIDR**.

When an exception is taken because **HCR.TVM** is set to 1, the **HSR** reports the exception:

- as a trapped MCR or MRC CP15 access, using the EC value 0x03, if the access is to a 32-bit register
- as a trapped MCRR or MRRC CP15 access, using the EC value 0x04, if the access is to a 64-bit register.

For more information about the exception reporting, see [Use of the HSR on page B3-1424](#).

## B1.14.14 Generic trapping of accesses to CP15 system control registers

---

### Note

---

- Many of the hypervisor traps described in the section [Traps to the hypervisor on page B1-1247](#) trap specific CP15 system control register operations to Hyp mode. However, because of the large number of possible usage models for virtualization, the traps on specific functions might not meet all possible requirements. Therefore, the Virtualization Extensions also provide a set of generic traps for trapping CP15 accesses to Hyp mode, as described in this subsection.
- ARM expects that trapping of Non-secure User mode accesses to CP15 to Hyp mode will be unusual, and used only when the hypervisor must virtualize User mode operation. ARM recommends that, whenever possible, Non-secure User mode accesses to CP15 behave as they would if the processor did not implement the Virtualization Extensions, generating an Undefined Instruction exception taken to Non-secure Undefined mode if the architecture does not support the User mode access.

---

The **HSTR** provides trap bits {T0-T3, T5-T13, T15}, for trapping accesses to each implemented primary CP15 register, {c0-c3, c5-c13, c15}. When a trap bit is set to 0, it has no effect on accesses to the CP15 registers. When a trap bit is set to 1, the trap applies as follows:

- In MCR and MRC instructions, CRn specifies the primary CP15 register. The trap applies if the value of CRn corresponds to the trapped primary CP15 register.
- In MCRR and MRRC instructions, CRm specifies the primary CP15 register. The trap applies if the value of CRm corresponds to the trapped primary CP15 register.

For a trapped primary CP15 register:

- Any MCR, MRC, MCRR, or MRRC access from a Non-secure PL1 mode, generates a Hyp Trap exception.
  - Any MCR, MRC, MCRR, or MRRC access from Non-secure User mode:
    - generates a Hyp Trap exception if the access would not be UNDEFINED if the corresponding trap bit was set to 0
    - otherwise, generates an Undefined Instruction exception, taken to Non-secure Undefined mode.
- If it is IMPLEMENTATION DEFINED whether, when the corresponding trap bit is set to 0, an access from Non-secure User mode is UNDEFINED, then, when the corresponding trap bit is set to 1, it is IMPLEMENTATION DEFINED whether an access from Non-secure User mode generates:
- a Hyp trap exception
  - an Undefined Instruction exception, taken to Non-secure Undefined mode.

This behavior is an exception to the general trapping behavior described in [Hyp traps on instructions that are UNDEFINED on page B1-1249](#).

---

### Note

---

- The definition of this trap means that, when **HSTR.Tx** is set to 1, the trap applies to accesses from Non-secure PL1 or PL0 modes:
    - using an MCR or MRC instruction with CRn set to *x*
    - using an MCRR or MRRC instruction with CRm set to *x*.
  - An implementation might provide additional controls, in IMPLEMENTATION DEFINED registers, to provide finer-grained control of control of trapping of IMPLEMENTATION DEFINED features.
  - HSTR bit[14] is reserved, UNK/SBZP regardless of whether the implementation includes the Generic Timer, that has its control registers in CP15 c14. The HSTR does not provide a trap on accesses to the Generic Timer CP15 registers.
-

For example, when `HSTR.T7` is set to 1:

- any 32-bit CP15 access from a Non-secure PL1 mode, using an MRC or MCR instruction with `CRn` set to `c7`, is trapped to Hyp mode
- any 64-bit CP15 access from a Non-secure PL1 mode, using an MRRC or MCRR instructions with `CRm` set to `c7`, is trapped to Hyp mode.

When an exception is taken because an `HSTR.Tn` bit is set to 1, the HSR reports the exception:

- as a trapped MCR or MRC CP15 access, using the EC value `0x03`, if the access uses an MCR or MRC instruction
- as a trapped MCRR or MRRC CP15 access, using the EC value `0x04`, if the access uses an MCRR or MRRC instruction.

For more information about the exception reporting, see [Use of the HSR on page B3-1424](#).

### B1.14.15 Trapping CP14 accesses to debug registers

Bits in `HDCR` control the trapping of Non-secure CP14 accesses to Hyp mode. When a `HDCR` control bit is set to 1, and the processor is executing in a Non-secure mode other than Hyp mode and is in Non-debug state, any access to an associated debug register through the CP14 interface generates a Hyp Trap exception.

CP14 register accesses can have side-effects. When a CP14 register access is trapped to Hyp mode, no side-effects occur before the exception is taken, see [Traps of register access instructions on page B1-1250](#).

For more information about the reporting of the exceptions see [Use of the HSR on page B3-1424](#).

The following sections summarize the `HDCR` control bits, the associated debug registers, and the HSR reporting of the Hyp Trap exception:

- [Trapping CP14 accesses to Debug ROM registers](#)
- [Trapping CP14 accesses to OS-related debug registers](#)
- [Trapping general CP14 accesses to debug registers on page B1-1260](#)
- [Permitted combinations of `HDCR.{TDRA, TDOSA, TDA, TDE}` bits on page B1-1260](#).

#### Trapping CP14 accesses to Debug ROM registers

When `HDCR.TDRA` is set to 1, if the processor is executing in a Non-secure mode other than Hyp mode, and is in Non-debug state, any CP14 access to `DBGDRAR` or `DBGDSAR` generates a Hyp Trap exception.

If `HDCR.TDE` is set to 1, or `HDCR.TDA` is set to 1, `HDCR.TDRA` must be set to 1, otherwise behavior is UNPREDICTABLE. For more information about `HDCR.TDE`, see [Routing Debug exceptions to Hyp mode on page B1-1193](#).

The HSR reports the exception as a trapped MCR or MRC access to CP14, using the EC value `0x05`.

#### Trapping CP14 accesses to OS-related debug registers

When `HDCR.TDOSA` is set to 1, if the processor is executing in a Non-secure mode other than Hyp mode, and is in Non-debug state, any CP14 access to an OS-related debug register generates a Hyp Trap exception.

If `HDCR.TDE` is set to 1, or `HDCR.TDA` is set to 1, `HDCR.TDOSA` must be set to 1, otherwise behavior is UNPREDICTABLE. For more information about `HDCR.TDE`, see [Routing Debug exceptions to Hyp mode on page B1-1193](#).

The OS-related debug registers are:

- `DBGOSLSR`, `DBGOSLAR`, `DBGOSDLR`, and `DBGPRCR`
- any IMPLEMENTATION DEFINED integration registers, including `DBGITCTRL`
- any IMPLEMENTATION DEFINED register with similar functionality, that the implementation specifies is trapped by `HDCR.TDOSA`.



Depending on the instruction used for the attempted register access, the [HSR](#) reports the exception:

- for an access to a 32-bit CP14 register, as a trapped MCR or MRC access to CP14, using the EC value 0x05
- for an access to a 64-bit register, as a trapped MRRC access to CP14, using the EC value 0x0C.

### Trapping general CP14 accesses to debug registers

When [HDCR.TDA](#) is set to 1, if the processor is executing in a Non-secure mode other than Hyp mode, and is in Non-debug state, any CP14 access to a Debug register generates a Hyp Trap exception, except for:

- Any access that this reference manual describes as UNPREDICTABLE or as causing an Undefined Instruction exception. Accesses described as UNPREDICTABLE can generate a Hyp Trap exception, but the architecture does not require them to do so, see [UNPREDICTABLE](#).
- Any access to [DBGDRAR](#) or [DBGDSAR](#). For more information about trapping accesses to these registers see [Trapping CP14 accesses to Debug ROM registers on page B1-1259](#).
- Any access to an OS-related debug register. For a list of these registers, and more information about trapping accesses to them, see [Trapping CP14 accesses to OS-related debug registers on page B1-1259](#).

Accesses trapped to Hyp mode by setting [HDCR.TDA](#) to 1 to 1 include STC accesses to [DBGDTRRXint](#), and LDC accesses to [DBGDTRTXint](#).

When [HDCR.TDA](#) is set to 1, both of [HDCR.{TDRA, TDOSA}](#) must be set to 1, otherwise behavior is UNPREDICTABLE.

If [HDCR.TDE](#) is set to 1, [HDCR.TDA](#) must be set to 1, otherwise behavior is UNPREDICTABLE. For more information about [HDCR.TDE](#), see [Routing Debug exceptions to Hyp mode on page B1-1193](#).

Depending on the instruction used for the attempted register access, the [HSR](#) reports the exception:

- as a trapped MCR or MRC access to CP14, using the EC value 0x05
- as a trapped LDC or STC access to CP14, using the EC value 0x06.

### Permitted combinations of [HDCR.{TDRA, TDOSA, TDA, TDE}](#) bits

The permitted values of the [HDCR.{TDRA, TDOSA, TDA, TDE}](#) bits are 0b0000, 0b0100, 0b1000, 0b1100, 0b1110, and 0b1111. If these bits are set to any other values, behavior is UNPREDICTABLE.

#### B1.14.16 Trapping CP14 accesses to trace registers

When [HCPTR.TTA](#) is set to 1, any access to a CP14 Trace register through the CP14 interface, except for accesses that the appropriate Trace Architecture Specification describes as UNPREDICTABLE or as causing an Undefined Instruction exception:

- if made from a Non-secure PL1 or PL0 mode, generates a Hyp Trap exception
- if made from Hyp mode, generates an Undefined Instruction exception, taken to Hyp mode, with the [HSR](#) holding a syndrome for the instruction.

#### ———— Note —————

Accesses described as UNPREDICTABLE can generate a Hyp Trap or Undefined Instruction exception, but the architecture does not require them to do so. See [UNPREDICTABLE](#).

CP14 register accesses can have side-effects. When a CP14 register access is trapped to Hyp mode, or generates an Undefined Instruction exception, because of the value of [HCPTR.TTA](#), no side-effects occur before the exception is taken, see [Traps of register access instructions on page B1-1250](#).

When the processor is in Debug state, these register accesses do not generate Hyp Trap exceptions, regardless of the value of [HCPTR.TTA](#).

[Trapping accesses to coprocessors on page B1-1256](#) describes other traps controlled by [HCPTR](#).



When a Hyp Trap exception is generated because HCPTR.TTA is set to 1, the HSR reports the exception as a trapped MCR or MRC access to CP14, using the EC value 0x05. For more information see [Use of the HSR on page B3-1424](#).

## B1.14.17 Summary of trap controls

Table B1-29 summarizes the hypervisor trap controls, and the associated trap bits. To provide a single summary of all the controls that can cause entry to Hyp mode, it also includes the exception routing controls described in [Routing general exceptions to Hyp mode on page B1-1191](#) and [Routing Debug exceptions to Hyp mode on page B1-1193](#).

**Table B1-29 Summary of Hyp trap controls**

Trap description	Controlled by
<a href="#">Trapping ID mechanisms on page B1-1250</a>	HCR.{TID0, TID1, TID2, TID3}
<a href="#">Trapping accesses to lockdown, DMA, and TCM operations on page B1-1252</a>	HCR.TIDCP
<a href="#">Trapping accesses to cache maintenance operations on page B1-1253</a>	HCR.{TSW, TPC, TPU}
<a href="#">Trapping accesses to TLB maintenance operations on page B1-1253</a>	HCR.TTLB
<a href="#">Trapping accesses to the Auxiliary Control Register on page B1-1253</a>	HCR.TAC
<a href="#">Trapping accesses to the Performance Monitors Extension on page B1-1254</a>	HDCR.{TPM, TPMCR}
<a href="#">Trapping use of the SMC instruction on page B1-1254</a>	HCR.TSC
<a href="#">Trapping use of the WFI and WFE instructions on page B1-1255</a>	HCR.{TWI, TWE}
<a href="#">Trapping accesses to Jazelle functionality on page B1-1255</a>	HSTR.TJDBX
<a href="#">Trapping accesses to the ThumbEE configuration registers on page B1-1255</a>	HSTR.TTEE
<a href="#">Trapping of Advanced SIMD functionality on page B1-1256</a>	HCPTR.TASE
<a href="#">General trapping of coprocessor accesses on page B1-1257</a>	HCPTR.{TCP0-TCP13}
<a href="#">Trapping CPACR accesses on page B1-1257</a>	HCPTR.TCPAC
<a href="#">Trapping writes to virtual memory control registers on page B1-1257</a>	HCR.TVM
<a href="#">Generic trapping of accesses to CP15 system control registers on page B1-1258</a>	HSTR.{T0-T3, T5-T13, T15}
<a href="#">Trapping CP14 accesses to Debug ROM registers on page B1-1259</a>	HDCR.TDRA
<a href="#">Trapping CP14 accesses to OS-related debug registers on page B1-1259</a>	HDCR.TDOSA
<a href="#">Trapping general CP14 accesses to debug registers on page B1-1260</a>	HDCR.TDA
<a href="#">Trapping CP14 accesses to trace registers on page B1-1260</a>	HCPTR.TTA
<a href="#">Routing general exceptions to Hyp mode on page B1-1191</a>	HCR.TGE
<a href="#">Routing Debug exceptions to Hyp mode on page B1-1193</a>	HDCR.TDE



# Chapter B2

## Common Memory System Architecture Features

This chapter provides a system level view of the general features of the memory system. It contains the following sections:

- *About the memory system architecture on page B2-1264*
- *Caches and branch predictors on page B2-1266*
- *IMPLEMENTATION DEFINED memory system features on page B2-1291*
- *Pseudocode details of general memory system operations on page B2-1292.*

## B2.1 About the memory system architecture

The ARM architecture supports different implementation choices for the memory system microarchitecture and memory hierarchy, depending on the requirements of the system being implemented. In this respect, the memory system architecture describes a design space in which an implementation is made. The architecture does not prescribe a particular form for the memory systems. Key concepts are abstracted in a way that permits implementation choices to be made while enabling the development of common software routines that do not have to be specific to a particular microarchitectural form of the memory system. For more information about the concept of a hierarchical memory system see [Memory hierarchy on page A3-155](#).

### B2.1.1 Form of the memory system architecture

ARMv7 supports different forms of the memory system architecture, that map onto the different architecture profiles. Two of these are described in this manual:

- ARMv7-A, the A profile, requires the inclusion of a *Virtual Memory System Architecture* (VMSA), as described in [Chapter B3 Virtual Memory System Architecture \(VMSA\)](#).
- ARMv7-R, the R profile, requires the inclusion of a *Protected Memory System Architecture* (PMSA), as described in [Chapter B5 Protected Memory System Architecture \(PMSA\)](#).

Both of these memory system architectures provide mechanisms to split memory into different regions. Each region has specific memory types and attributes. The two memory system architectures have different capabilities and programmers' models.

The memory system architecture model required by ARMv7-M, the M profile, is outside the scope of this manual. It is described in the *ARMv7-M Architecture Reference Manual*.

### B2.1.2 Memory attributes

[Summary of ARMv7 memory attributes on page A3-126](#) summarizes the memory attributes, including how different memory types have different attributes. Each region of memory has a set of memory attributes:

- In a VMSA implementation, the translation tables define the virtual memory regions, and the attributes for each region.

———— **Note** —————

Depending on its *translation regime*, an access is subject to one or two stages of translation. For an access that requires two stages of translation, the attributes from each stage of translation are combined to obtain the final region attribute. [About the VMSA on page B3-1308](#) defines the translation regimes.

For more information, see [Translation tables on page B3-1318](#).

- In a PMSA implementation the attributes are part of each MPU memory region definition, see [Memory region attributes on page B5-1760](#).

#### Cacheability and cache allocation hint attributes

As described in [Summary of ARMv7 memory attributes on page A3-126](#), the ARMv7 memory attributes include cacheability and cache allocation hint attributes. In most implementations, these are combined into a single attribute, that is one of:

- Non-cacheable
- Write-Through Cacheable
- Write-Back Write-Allocate Cacheable
- Write-Back no Write-Allocate Cacheable.

The exception to this is an ARMv7-A implementation that includes the Large Physical Address Extension and is using the Long-descriptor translation table format. In this case, the translation table entry for any Cacheable region assigns that region both a Read-Allocate and a Write-Allocate hint. Each hint is either *Allocate* or *Do not allocate*. For more information see [Long-descriptor format memory region attributes on page B3-1372](#).

---

**Note**

A Cacheable region with both no Read-Allocate and no Write-Allocate hints is not the same as a Non-cacheable region. A Non-cacheable region has coherency guarantees for observers outside its Shareability domains, that do not apply for a region that is Cacheable, no Read-Allocate, no Write-Allocate.

---

The architecture does not require an implementation to make any use of cache allocation hints. This means an implementation might not make any distinction between memory regions with attributes that differ only in their cache allocation hint.

### B2.1.3 Levels of cache

In ARMv7, the architecturally-defined cache control mechanism covers multiple levels of cache, as described in [Caches and branch predictors on page B2-1266](#). Also, it permits levels of cache beyond the scope of these cache control mechanisms, see [System level caches on page B2-1290](#).

---

**Note**

Before ARMv7, the architecturally-defined cache control mechanism covers only a single level of cache, and any support for other levels of cache is IMPLEMENTATION DEFINED.

---

## B2.2 Caches and branch predictors

The concept of caches is described in *Caches and memory hierarchy* on page A3-155. This section describes the ARMv7 cache identification and control mechanisms, and the cache maintenance operations, in the following sections:

- [Cache identification](#)
- [Cache behavior](#) on page B2-1267
- [Cache enabling and disabling](#) on page B2-1270
- [Branch predictors](#) on page B2-1271
- [Multiprocessor considerations for cache and similar maintenance operations](#) on page B2-1273
- [About ARMv7 cache and branch predictor maintenance functionality](#) on page B2-1273
- [Cache and branch predictor maintenance operations](#) on page B2-1277
- [The interaction of cache lockdown with cache maintenance operations](#) on page B2-1287
- [Ordering of cache and branch predictor maintenance operations](#) on page B2-1289
- [System level caches](#) on page B2-1290.

---

### Note

- Branch predictors typically use a form of cache to hold branch target data. Therefore, they are included in this section.
  - The following sections describe the cache identification and control mechanisms in previous versions of the ARM architecture:
    - [Cache support](#) on page AppxL-2517, for ARMv6
    - [Cache support](#) on page AppxO-2604, for the ARMv4 and ARMv5 architectures.
- 

### B2.2.1 Cache identification

The ARMv7 cache identification consists of a set of registers that describe the implemented caches that are under the control of the processor:

- A single Cache Type Register defines:
  - the minimum line length of any of the instruction caches
  - the minimum line length of any of the data or unified caches
  - the cache indexing and tagging policy of the Level 1 instruction cache.For more information, see:
  - [CTR, Cache Type Register, VMSA](#) on page B4-1556, for a VMSA implementation
  - [CTR, Cache Type Register, PMSA](#) on page B6-1833, for a PMSA implementation.
- A single Cache Level ID Register defines:
  - the type of cache implemented at a each cache level, up to the maximum of seven levels
  - the Level of Coherence for the caches
  - the Level of Unification for the caches.For more information, see:
  - [CLIDR, Cache Level ID Register, VMSA](#) on page B4-1530, for a VMSA implementation
  - [CLIDR, Cache Level ID Register, PMSA](#) on page B6-1814, for a PMSA implementation.
- A single Cache Size Selection Register selects the cache level and cache type of the current Cache Size Identification Register, see:
  - [CSSELR, Cache Size Selection Register, VMSA](#) on page B4-1555, for a VMSA implementation
  - [CSSELR, Cache Size Selection Register, PMSA](#) on page B6-1832, for a PMSA implementation.
- For each implemented cache, across all the levels of caching, a Cache Size Identification Register defines:
  - whether the cache supports Write-Through, Write-Back, Read-Allocate and Write-Allocate
  - the number of sets, associativity and line length of the cache.

For more information, see:

- [CCSIDR, Cache Size ID Registers, VMSA on page B4-1528](#), for a VMSA implementation
- [CCSIDR, Cache Size ID Registers, PMSA on page B6-1812](#), for a PMSA implementation.

## Identifying the cache resources in ARMv7

In ARMv7 the architecture defines support for multiple levels of cache, up to a maximum of seven levels. This complicates the process of identifying the cache resources available to an ARMv7 processor. To obtain this information, software must:

1. Read the Cache Type Register to find the indexing and tagging policy used for the Level 1 instruction cache. This register also provides the size of the smallest cache lines used for the instruction caches, and for the data and unified caches. These values are used in cache maintenance operations.
2. Read the Cache Level ID Register to find what caches are implemented. The register includes seven Cache type fields, for cache levels 1 to 7. Scanning these fields, starting from Level 1, identifies the instruction, data or unified caches implemented at each level. This scan ends when it reaches a level at which no caches are defined. The Cache Level ID Register also provides the Level of Unification and the Level of Coherency for the cache implementation.
3. For each cache identified at stage 2:
  - Write to the Cache Size Selection Register to select the required cache. A cache is identified by its level, and whether it is:
    - an instruction cache
    - a data or unified cache.
  - Read the Cache Size ID Register to find details of the cache.

### ————— **Note** —————

In ARMv6, only the Level 1 caches are architecturally defined, and the Cache Type Register holds details of the caches. For more information, see [Cache support on page AppxL-2517](#).

## **B2.2.2 Cache behavior**

The following subsections summarize the behavior of caches in an ARMv7 implementation:

- [General behavior of the caches](#)
- [Behavior of the caches at reset on page B2-1269](#)
- [Behavior of Preload Data \(PLD, PLDW\) and Preload Instruction \(PLI\) with caches on page B2-1269.](#)

### **General behavior of the caches**

When a memory location is marked with a Normal Cacheable memory attribute, determining whether a copy of the memory location is held in a cache still depends on many aspects of the implementation. The following non-exhaustive list of factors might be involved:

- the size, line length, and associativity of the cache
- the cache allocation algorithm
- activity by other elements of the system that can access the memory
- speculative instruction fetching algorithms
- speculative data fetching algorithms
- interrupt behaviors.

Given this range of factors, and the large variety of cache systems that might be implemented, the architecture cannot guarantee whether:

- a memory location present in the cache remains in the cache
- a memory location not present in the cache is brought into the cache.

Instead, the following principles apply to the behavior of caches:

- The architecture has a concept of an entry locked down in the cache. How lockdown is achieved is IMPLEMENTATION DEFINED, and lockdown might not be supported by:
  - a particular implementation
  - some memory attributes.
- An unlocked entry in the cache cannot be relied upon to remain in the cache. If an unlocked entry does remain in the cache, it cannot be relied upon to remain incoherent with the rest of memory. In other words, software must not assume that an unlocked item that remains in the cache remains dirty.
- A locked entry in the cache can be relied upon to remain in the cache. A locked entry in the cache cannot be relied upon to remain incoherent with the rest of memory, that is, it cannot be relied on to remain dirty.

———— **Note** —————

For more information, see [The interaction of cache lockdown with cache maintenance operations on page B2-1287](#).

- If a memory location both has permissions that mean it can be accessed, either by reads or by writes, for the translation scheme at either the current level of privilege or at a higher level of privilege, and is marked as Cacheable for that translation regime, then there is no mechanism that can guarantee that the memory location cannot be allocated to an enabled cache at any time.  
Any application must assume that any memory location with such access permissions and cacheability attributes can be allocated to any enabled cache at any time.
- If the cache is disabled, it is guaranteed that no new allocation of memory locations into the cache occurs.
- If the cache is enabled, it is guaranteed that no memory location that does not have a Cacheable attribute is allocated into the cache.
- If the cache is enabled, it is guaranteed that no memory location is allocated to the cache if the access permissions for that location are such that the location cannot be accessed by reads and cannot be accessed by writes in both:
  - the translation regime at the current level of privilege
  - the translation regime at a higher level of privilege.
- For data accesses, any memory location that is marked as Normal Shareable is guaranteed to be coherent with all masters in that shareability domain.
- Any memory location is not guaranteed to remain incoherent with the rest of memory.
- The eviction of a cache entry from a cache level can overwrite memory that has been written by another observer only if the entry contains a memory location that has been written to by an observer in the shareability domain of that memory location. The maximum size of the memory that can be overwritten is called the *Cache Write-back Granule*. In some implementations the CTR identifies the Cache Write-back Granule, see:
  - [CTR, Cache Type Register, VMSA on page B4-1556](#) for a VMSA implementation
  - [CTR, Cache Type Register, PMSA on page B6-1833](#) for a PMSA implementation.
- The allocation of a memory location into a cache cannot cause the most recent value of that memory location to become invisible to an observer, if it had previously been visible to that observer.

For the purpose of these principles, a cache entry covers at least 16 bytes and no more than 2KB of contiguous address space, aligned to its size.

In ARMv7, in the following situations it is UNPREDICTABLE whether the location is returned from cache or from memory:

- The location is not marked as Cacheable but is contained in the cache. This situation can occur if a location is marked as Non-cacheable after it has been allocated into the cache.
- The location is marked as Cacheable and might be contained in the cache, but the cache is disabled.



## Behavior of the caches at reset

In ARMv7:

- All caches are disabled at reset.
- An implementation can require the use of a specific cache initialization routine to invalidate its storage array before it is enabled. The exact form of any required initialization routine is IMPLEMENTATION DEFINED, and the routine must be documented clearly as part of the documentation of the device.
- It is IMPLEMENTATION DEFINED whether an access can generate a cache hit when the cache is disabled. If an implementation permits cache hits when the cache is disabled the cache initialization routine must:
  - provide a mechanism to ensure the correct initialization of the caches
  - be documented clearly as part of the documentation of the device.

In particular, if an implementation permits cache hits when the cache is disabled and the cache contents are not invalidated at reset, the initialization routine must avoid any possibility of running from an uninitialized cache. It is acceptable for an initialization routine to require a fixed instruction sequence to be placed in a restricted range of memory.

- ARM recommends that whenever an invalidation routine is required, it is based on the ARMv7 cache maintenance operations.

When it is enabled, the state of a cache is UNPREDICTABLE if the appropriate initialization routine has not been performed.

Similar rules apply:

- to branch predictor behavior, see [Behavior of the branch predictors at reset on page B2-1272](#)
- on an ARMv7-A implementation, to TLB behavior, see [TLB behavior at reset on page B3-1379](#).

### ————— Note —————

Before ARMv7, caches are invalidated by the assertion of reset, see [Cache behavior at reset on page AppxL-2518](#).

## Behavior of Preload Data (PLD, PLDW) and Preload Instruction (PLI) with caches

The PLD and PLI instructions provide Preload Data and Preload Instruction operations. These instructions are implemented in the ARM and Thumb instruction sets. The Multiprocessing Extensions add the PLDW instruction. These instructions are memory system hints, and the effect of each instruction is IMPLEMENTATION DEFINED, see [Preloading caches on page A3-157](#).

Because they are hints to the memory system, the operation of a PLD, PLDW, or PLI instruction does not cause a synchronous abort to occur. However, a memory operation performed as a result of one of these memory system hints might trigger an asynchronous event, so influencing the execution of the processor. Examples of the asynchronous events that might be triggered are asynchronous aborts and interrupts.

A PLD or PLDW instruction is guaranteed not to cause any effect to the caches, or TLB, or memory other than the effects that, for permission or other reasons, can be caused by the equivalent load from the same location with the same context and at the same privilege level.

A PLD or PLDW instruction is guaranteed not to access Strongly-ordered or Device memory.

A PLI instruction is guaranteed not to cause any effect to the caches, or TLB, or memory, other than the effects that, for permission or other reasons, can be caused by the fetch resulting from changing the PC to the location specified by the PLI instruction with the same context and at the same privilege level.

A PLI instruction must not perform any access that might be performed by a speculative instruction fetch by the processor. Therefore:

- A PLI instruction cannot access memory that has the Strongly-ordered or Device attribute.
- In a VMSA implementation, if all associated MMUs are disabled, a PLI instruction cannot access any memory location that cannot be accessed by instruction fetches.

---

**Note**

In ARMv6, a speculative instruction fetch is provided by the optional Prefetch instruction cache line operation in CP15 c7, with encoding <opc1> == 0, <CRm> == c13, <opc2> == 1, see [CP15 c7, Cache and branch predictor operations on page AppxL-2531](#).

---

### Cache lockdown

Cache lockdown requirements can conflict with the management of hardware coherency. For this reason, ARMv7 introduces significant changes in this area, compared to previous versions of the ARM architecture. These changes recognize that, in many systems, cache lockdown is inappropriate.

For an ARMv7 implementation:

- There is no requirement to support cache lockdown.
- If cache lockdown is supported, the lockdown mechanism is IMPLEMENTATION DEFINED. However key properties of the interaction of lockdown with the architecture must be described in the implementation documentation.
- The Cache Type Register does not hold information about lockdown. This is a change from ARMv6. However some CP15 c9 encodings are available for IMPLEMENTATION DEFINED cache lockdown features, see [IMPLEMENTATION DEFINED memory system features on page B2-1291](#).

---

**Note**

For details of cache lockdown in ARMv6 see [CP15 c9, Cache lockdown support on page AppxL-2537](#).

---

## B2.2.3 Cache enabling and disabling

[Levels of cache on page B2-1265](#) indicates that:

- In ARMv7 the architecture defines the control of multiple levels of cache.
- Before ARMv7 the architecture defines the control of only one level of cache.

This means the mechanism for cache enabling and disabling caches changes in ARMv7. In ARMv6, and in earlier versions of the architecture, [SCTLR.C](#) and [SCTLR.I](#) control enabling and disabling of caches, see:

- [SCTLR, System Control Register, VMSA on page B4-1705](#), for a VMSA implementation
- [SCTLR, System Control Register, PMSA on page B6-1930](#), for a PMSA implementation.

In ARMv7:

- [SCTLR.C](#) enables or disables all data and unified caches, across all levels of cache visible to the processor.
- [SCTLR.I](#) enables or disables all instruction caches, across all levels of cache visible to the processor.
- If an implementation requires finer-grained control of cache enabling it can implement control bits in the Auxiliary Control Register for this purpose. For example, an implementation might define control bits to enable and disable the caches at a particular level. For more information about the Auxiliary Control Register see:
  - [ACTLR, IMPLEMENTATION DEFINED Auxiliary Control Register, VMSA on page B4-1522](#), for a VMSA implementation
  - [ACTLR, IMPLEMENTATION DEFINED Auxiliary Control Register, PMSA on page B6-1808](#), for a PMSA implementation.

---

**Note**

In ARMv6, the [SCTLR I](#), [C](#), and [W](#) bits provide separate enables for the level 1 instruction cache, if implemented, the level 1 data or unified cache, and write buffering.

---

When a cache is disabled, for a particular translation regime:

- it is IMPLEMENTATION DEFINED whether a cache hit occurs if a location that is held in the cache is accessed
- any location that is not held in the cache is not brought into the cache as a result of a memory access.

———— **Note** ————

When interpreting this requirement for a PMSA implementation, all memory accesses belong to a single translation regime that provides a flat mapping from input address to output address.

It is IMPLEMENTATION DEFINED whether the following bits affect the memory attributes generated by an enabled MMU or MPU:

- for execution in Hyp mode, [HSCTLR](#). {C, I}
- for execution in any other mode, [SCTLR](#). {C, I}.

In an implementation where the {C, I} bits can affect the generated memory attributes:

- If the implementation is a VMSAv7 implementation that includes the Virtualization Extensions, [HCR.DC](#) is set to 1, and [SCTLR.M](#) is set to 0, then for execution using a PL1&0 translation regime the {C, I} bits have no effect on cacheability.
- Otherwise:
  - When a C bit is set to 0, disabling the data or unified cache for the corresponding translation regime, data accesses and translation table walks from that translation regime to any Normal memory region behave as Non-cacheable for all levels of data or unified cache.

———— **Note** ————

Setting a C bit to 0 has no effect on the behavior of instruction accesses.

- When an I bit is set to 0, disabling the instruction cache for the corresponding translation regime, instruction accesses from that translation regime to any Normal memory region behave as Non-cacheable for all levels of instruction cache.

For implementations where the {C, I} bits can affect the generated memory attributes, this *otherwise* case applies to all PMSA implementations, and to a VMSA implementation where any of the following applies:

- The implementation does not include the Virtualization Extensions.
- [HCR.DC](#) is set to 0, or [SCTLR.M](#) is set to 1.
- Execution is not using a PL1&0 translation regime.

———— **Note** ————

Regardless of whether the {C, I} bits affect the memory attributes, when a cache is disabled, a memory location that is not held in the cache is never brought into the cache as a result of a memory access.

If the MMU or MPU is disabled, the following sections describe the effects of [SCTLR](#). {C, I} on the memory attributes:

- [The effects of disabling MMUs on VMSA behavior on page B3-1314](#) for the MMU
- [Behavior when the MPU is disabled on page B5-1756](#) for the MPU.

## B2.2.4 Branch predictors

Branch predictor hardware typically uses a form of cache to hold branch information. The ARM architecture permits this branch predictor hardware to be visible to software, and so the branch predictor is not architecturally invisible. This means that under some circumstances software must perform branch predictor maintenance to avoid incorrect execution caused by out-of-date entries in the branch predictor. For example, to ensure correct operation it might be necessary to invalidate branch predictor entries on a change to instruction memory, or a change of instruction address mapping. For more information, see [Requirements for branch predictor maintenance operations on page B2-1272](#).

An invalidate all operation on the branch predictor ensures that any location held in the branch predictor has no functional effect on execution. An invalidate branch predictor by MVA operation operates on the address of the branch instruction, but can affect other branch predictor entries.

---

**Note**

The architecture does not make visible the range of addresses in a branch predictor to which the invalidate operation applies. This means the address used in the invalidate by MVA operation must be the address of the branch to be invalidated.

---

If branch prediction is architecturally visible, an instruction cache invalidate all operation also invalidates all branch predictors.

### Requirements for branch predictor maintenance operations

If, for a given translation regime and a given ASID and VMID as appropriate, the instructions at any virtual address change, then branch predictor maintenance operations must be performed to invalidate entries in the branch predictor, to ensure that the change is visible to subsequent execution. This maintenance is required when writing new values to instruction locations. It can also be required as a result of any of the following situations that change the translation of a virtual address to a physical address, if, as a result of the change to the translation, the instructions at the virtual addresses change:

- enabling or disabling the MMU
- writing new mappings to the translation tables
- any change to the [TTBR0](#), [TTBR1](#), or [TTBCR](#) registers, unless accompanied by a change to the ContextID, or a change to the VMID
- changes to the [VTTBR](#) or [VTCR](#) registers, unless accompanied by a change to the VMID.

---

**Note**

Invalidation is not required if the changes to the translations are such that the instructions associated with the non-faulting translations of a virtual address, for a given translation regime and a given ASID and VMID, as appropriate, remain unchanged throughout the sequence of changes to the translations. Examples of translation changes to which this applies are:

- changing a valid translation to a translation that generates a MMU fault
- changing a translation that generates a MMU fault to a valid translation.

---

Failure to invalidate entries might give UNPREDICTABLE results, caused by the execution of old branches. For more information, see [Ordering of cache and branch predictor maintenance operations on page B2-1289](#).

---

**Note**

- In ARMv7, there is no requirement to use the branch predictor maintenance operations to invalidate the branch predictor after:
  - changing the ContextID or VMID, or changing the FCSE ProcessID in an implementation that includes the FCSE
  - a cache operation that is identified as also flushing the branch predictors, see [Cache and branch predictor maintenance operations on page B2-1277](#).
- In ARMv6, the branch predictor must be invalidated after a change to the ContextID or FCSE ProcessID, see [CP15 c13, Context ID support on page AppxL-2545](#).

---

### Behavior of the branch predictors at reset

In ARMv7:

- If branch predictors are not architecturally invisible the branch prediction logic is disabled at reset.

- An implementation can require the use of a specific branch predictor initialization routine to invalidate the branch predictor storage array before it is enabled. The exact form of any required initialization routine is IMPLEMENTATION DEFINED, but the routine must be documented clearly as part of the documentation of the device.
- ARM recommends that whenever an invalidation routine is required, it is based on the ARMv7 branch predictor maintenance operations.

When it is enabled, the state of the branch predictor logic is UNPREDICTABLE if the appropriate initialization routine has not been performed.

Similar rules apply:

- to cache behavior, see [Behavior of the caches at reset on page B2-1269](#)
- on an ARMv7-A implementation, to TLB behavior, see [TLB behavior at reset on page B3-1379](#).

## B2.2.5 Multiprocessor considerations for cache and similar maintenance operations

The ARMv7 architecture defines maintenance operations for:

- caches,
- branch predictors
- on a VMSA implementation, TLBs.

For an implementation that does not include the Multiprocessing Extensions, the ARMv7 architecture defines these operations as applying only to resources directly attached to the processor on which the operation is executed. This means there is no requirement for maintenance operations to influence other processors with which data can be shared. If porting an architecturally-portable multiprocessor operating system to an implementation of the ARMv7 architecture that does not include the Multiprocessing Extensions, when a maintenance operation is performed, the operating system must use *Inter-Processor Interrupts* (IPIs) to inform other processors in a multiprocessor configuration that they must perform the equivalent operation.

The ARMv7 Multiprocessing Extensions provide enhanced support for multiprocessor implementations, including extending the maintenance operations, so that some maintenance operations affect other processors in the system. The Multiprocessing Extensions both:

- change the effect of some existing maintenance operations
- add new maintenance operations.

The following sections include descriptions of the extensions to the maintenance operations:

- [Cache and branch predictor maintenance operations on page B2-1277](#)
- [TLB maintenance requirements on page B3-1381](#).

When a uniprocessor implementation with no hardware support for cache coherency includes the Multiprocessing Extensions, the Inner Shareable and Outer Shareable domains apply only to the single processor, and all instructions defined to apply to the Inner Shareable domain behave as aliases of the local operations.

## B2.2.6 About ARMv7 cache and branch predictor maintenance functionality

This chapter describes cache and branch predictor maintenance for ARMv7. For details of maintenance operations in previous versions of the ARM architecture see:

- [CP15 c7, Cache and branch predictor operations on page AppxL-2531](#) for ARMv6
- [CP15 c7, Cache and branch predictor operations on page AppxO-2628](#) for the ARMv4 and ARMv5 architectures.

The following sections give general information about the ARMv7 cache and branch prediction maintenance functionality:

- [Terms used in describing the maintenance operations on page B2-1274](#)
- [The ARMv7 abstraction of the cache hierarchy on page B2-1276](#).

[Cache and branch predictor maintenance operations on page B2-1277](#) describes the maintenance operations.

## Terms used in describing the maintenance operations

Cache maintenance operations are defined to act on particular memory locations. Operations can be defined:

- by the address of the memory location to be maintained, referred to as operating *by MVA*
- by a mechanism that describes the location in the hardware of the cache, referred to as operating *by set/way*.

In addition, for instruction caches and branch predictors, there are operations that invalidate all entries.

The following subsections define the terms used in the descriptions of the cache operations:

- [Terminology for operations by MVA](#)
- [Terminology for operations by set/way](#)
- [Terminology for Clean, Invalidate, and Clean and Invalidate operations on page B2-1275.](#)

### Terminology for operations by MVA

The term *Modified Virtual Address* (MVA) relates to the *Fast Context Switch Extension* (FCSE) mechanism, described in [Appendix J Fast Context Switch Extension \(FCSE\)](#). When the FCSE is absent or disabled, the MVA and VA have the same value. However the term MVA is used throughout this section, and elsewhere in this manual, for cache and TLB operations. This is consistent with previous issues of the *ARM Architecture Reference Manual*.

#### ———— Note —————

From ARMv6, ARM deprecates any use of the FCSE. The FCSE is OPTIONAL and deprecated in an ARMv7 implementation that does not include the Multiprocessing Extensions, and is not supported by any implementation that includes the Multiprocessing Extensions. That is, the Multiprocessing Extensions make the FCSE obsolete.

Virtual addresses only exist in systems with a MMU. When no MMU is implemented, or all applicable MMUs are disabled, the MVA and VA are identical to the PA.

#### ———— Note —————

For more information about memory system behavior when MMUs are disabled, see [The effects of disabling MMUs on VMSA behavior on page B3-1314.](#)

### Terminology for operations by set/way

Cache maintenance operations by set/way refer to the particular structures in a cache. Three parameters describe the location in a cache hierarchy that an operation works on. These parameters are:

- Level**      The cache *level* of the hierarchy. The number of levels of cache is IMPLEMENTATION DEFINED, and can be determined from the Cache Level ID Register, see:
- [CLIDR, Cache Level ID Register; VMSA on page B4-1530](#) for a VMSA implementation
  - [CLIDR, Cache Level ID Register; PMSA on page B6-1814](#) for a PMSA implementation.
- In the ARM architecture, the lower numbered levels are those closest to the processor, see [Memory hierarchy on page A3-155](#).
- Set**            Each level of a cache is split up into a number of *sets*. Each set is a set of locations in a cache level to which an address can be assigned. Usually, the set number is an IMPLEMENTATION DEFINED function of an address.
- In the ARM architecture, sets are numbered from 0.
- Way**            The *Associativity* of a cache defines the number of locations in a set to which an address can be assigned. The *way* number specifies a location in a set.
- In the ARM architecture, ways are numbered from 0.

### Terminology for Clean, Invalidate, and Clean and Invalidate operations

Caches introduce coherency problems in two possible directions:

1. An update to a memory location by a processor that accesses a cache might not be visible to other observers that can access memory. This can occur because new updates are still in the cache and are not visible yet to the other observers that do not access that cache.
2. Updates to memory locations by other observers that can access memory might not be visible to a processor that accesses a cache. This can occur when the cache contains an old, or *stale*, copy of the memory location that has been updated.

The *Clean* and *Invalidate* operations address these two issues. The definitions of these operations are:

**Clean** A cache clean operation ensures that updates made by an observer that controls the cache are made visible to other observers that can access memory at the point to which the operation is performed. Once the Clean has completed, the new memory values are guaranteed to be visible to the point to which the operation is performed, for example to the point of unification.

The cleaning of a cache entry from a cache can overwrite memory that has been written by another observer only if the entry contains a location that has been written to by an observer in the shareability domain of that memory location.

**Invalidate** A cache invalidate operation ensures that updates made visible by observers that access memory at the point to which the invalidate is defined are made visible to an observer that controls the cache. This might result in the loss of updates to the locations affected by the invalidate operation that have been written by observers that access the cache.

If the address of an entry on which the invalidate operates does not have a Normal Cacheable attribute, or if the cache is disabled, then an invalidate operation also ensures that this address is not present in the cache.

———— **Note** —————

Entries for addresses with a Normal Cacheable attribute can be allocated to an enabled cache at any time, and so the cache invalidate operation cannot ensure that the address is not present in an enabled cache.

### Clean and Invalidate

A cache *clean and invalidate* operation behaves as the execution of a clean operation followed immediately by an invalidate operation. Both operations are performed to the same location.

The points to which a cache maintenance operation can be defined differ depending on whether the operation is by MVA or by set/way:

- For set/way operations, and for *All* (entire cache) operations, the point is defined to be to the next level of caching.
- For MVA operations, two conceptual points are defined:

#### Point of coherency (PoC)

For a particular MVA, the PoC is the point at which all agents that can access memory are guaranteed to see the same copy of a memory location. In many cases, this is effectively the main system memory, although the architecture does not prohibit the implementation of caches beyond the PoC that have no effect on the coherence between memory system agents.

#### Point of unification (PoU)

The PoU for a processor is the point by which the instruction and data caches and the translation table walks of that processor are guaranteed to see the same copy of a memory location. In many cases, the point of unification is the point in a uniprocessor memory system by which the instruction and data caches and the translation table walks have merged.

The PoU for an Inner Shareable shareability domain is the point by which the instruction and data caches and the translation table walks of all the processors in that Inner Shareable shareability domain are guaranteed to see the same copy of a memory location. Defining this point permits self-modifying software to ensure future instruction fetches are associated with the modified version of the software by using the standard correctness policy of:

1. clean data cache entry by address
2. invalidate instruction cache entry by address.

The PoU also permits a uniprocessor system that does not implement the Multiprocessing Extensions to use the clean data cache entry operation to ensure that all writes to the translation tables are visible to the translation table walk hardware.

The following fields in the [CLIDR](#) relate to these conceptual points:

#### **LoC, Level of coherence**

This field defines the last level of cache that must be cleaned or invalidated when cleaning or invalidating to the point of coherency. The LoC value is a cache level, so, for example, if LoC contains the value 3:

- A clean to the point of coherency operation requires the level 1, level 2 and level 3 caches to be cleaned.
- Level 4 cache is the first level that does not have to be maintained.

If the LoC field value is  $0x0$ , this means that no levels of cache need to be cleaned or invalidated when cleaning or invalidating to the point of coherency.

If the LoC field value is a nonzero value that corresponds to a level that is not implemented, this indicates that all implemented caches are before the point of coherency.

#### **LoUU, Level of unification, uniprocessor**

This field defines the last level of cache that must be cleaned or invalidated when cleaning or invalidating to the point of unification for the processor. As with LoC, the LoUU value is a cache level.

If the LoUU field value is  $0x0$ , this means that no levels of cache need to be cleaned or invalidated when cleaning or invalidating to the point of unification.

If the LoUU field value is a nonzero value that corresponds to a level that is not implemented, this indicates that all implemented caches are before the point of unification.

#### **LoUIS, Level of unification, Inner Shareable**

This field is defined only as part of the Multiprocessing Extensions. If an implementation does not include the Multiprocessing Extensions then this field is RAZ.

In an implementation that includes the Multiprocessing Extensions:

- This field defines the last level of cache that must be cleaned or invalidated when cleaning or invalidating to the point of unification for the Inner Shareable shareability domain. As with LoC, the LoUIS value is a cache level.
- If the LoUIS field value is  $0x0$ , this means that no levels of cache need to be cleaned or invalidated when cleaning or invalidating to the point of unification for the Inner Shareable shareability domain.
- If the LoUIS field value is a nonzero value that corresponds to a level that is not implemented, this indicates that all implemented caches are before the point of unification.

For more information, see:

- [CLIDR, Cache Level ID Register, VMSA on page B4-1530](#) for a VMSA implementation
- [CLIDR, Cache Level ID Register, PMSA on page B6-1814](#) for a PMSA implementation.

### **The ARMv7 abstraction of the cache hierarchy**

The following subsections describe the ARMv7 abstraction of the cache hierarchy:

- [Cache hierarchy abstraction for address-based operations on page B2-1277](#)
- [Cache hierarchy abstraction for set/way-based operations on page B2-1277.](#)



[Performing cache maintenance operations on page B2-1286](#) gives more information about the cache maintenance operations, including an example of cache maintenance code, that can be adapted for other cache operations.

### **Cache hierarchy abstraction for address-based operations**

The address-based cache operations are described as operating by MVA. Each of these operations is always qualified as being one of:

- performed to the point of coherency
- performed to the point of unification.

See [Terms used in describing the maintenance operations on page B2-1274](#) for definitions of point of coherency and point of unification, and more information about possible meanings of MVA.

[Summary of cache and branch predictor maintenance operations](#) lists the address-based maintenance operations.

The CTR holds minimum line length values for:

- the instruction caches
- the data and unified caches.

These values support efficient invalidation of a range of addresses, because this value is the most efficient address stride to use to apply a sequence of address-based maintenance operations to a range of addresses.

For the Invalidate data or unified cache line by MVA operation, the Cache Write-back Granule field of the CTR defines the maximum granule that a single invalidate instruction can invalidate. This meaning of the Cache Write-back Granule is in addition to its defining the maximum size that can be written back.

For details of the CTR see:

- [CTR, Cache Type Register, VMSA on page B4-1556](#) for a VMSA implementation
- [CTR, Cache Type Register, PMSA on page B6-1833](#) for a PMSA implementation.

### **Cache hierarchy abstraction for set/way-based operations**

[Summary of cache and branch predictor maintenance operations](#) lists the set/way-based maintenance operations. The CP15 c7 encodings of these operations include a required field that specifies the cache level for the operation:

- a clean operation cleans from the level of cache specified through to at least the next level of cache, moving further from the processor
- an invalidate operation invalidates only at the level specified.

## **B2.2.7 Cache and branch predictor maintenance operations**

Cache and branch predictor maintenance operations are performed using accesses to CP15 c7. The following sections define the encodings for these operations:

- [Cache and branch predictor maintenance operations, VMSA on page B4-1740](#), for a VMSA implementation
- [Cache and branch predictor maintenance operations, PMSA on page B6-1941](#), for a PMSA implementation.

The following sections describe the operations:

- [Summary of cache and branch predictor maintenance operations](#)
- [Requirements for cache and branch predictor maintenance operations on page B2-1280](#)
- [Scope of cache and branch predictor maintenance operations on page B2-1280](#)
- [Virtualization Extensions upgrading of maintenance operations on page B2-1286](#)
- [Performing cache maintenance operations on page B2-1286](#).

### **Summary of cache and branch predictor maintenance operations**

The following subsections summarize the required cache and branch predictor maintenance operations:

- [Data cache and unified cache operations on page B2-1278](#)
- [Instruction cache operations on page B2-1279](#)

- [Branch predictor operations on page B2-1279](#).

———— **Note** ————

Other cache maintenance operations specified in ARMv6 are not supported in ARMv7. Their associated encodings in CP15 c7 are UNPREDICTABLE.

An ARMv7 implementation can add additional IMPLEMENTATION DEFINED cache maintenance functionality using CP15 c15 operations, if this is required.

In a VMSA implementation, some maintenance operations that take an MVA as an argument can generate an MMU fault. The fault descriptions in [MMU faults on page B3-1403](#) identify these cases.

[General requirements for the scope of maintenance operations on page B2-1280](#) gives information that applies to all of these operations. Where appropriate, the operation summaries give cross-references to subsections that give additional information that is relevant to that operation.

### **Data cache and unified cache operations**

Any of these operations can be applied to any data cache, or to any unified cache. The supported operations, grouped by the argument required for the operation, are:

#### **Operations by MVA**

The data and unified cache operations by MVA are:

<b>DCIMVAC</b>	Invalidate, to point of coherency.
<b>DCCMVAC</b>	Clean, to point of coherency.
<b>DCCMVAU</b>	Clean, to point of unification.
<b>DCCIMVAC</b>	Clean and invalidate, to point of coherency.

These operations invalidate, clean, or clean and invalidate a data or unified cache line based on the address it contains. For more information see:

- [Requirements for operations by MVA on page B2-1280](#)
- for an implementation that includes the Multiprocessing Extensions:
  - for the operations to the point of coherency, [Effect of the Multiprocessing Extensions on operations to the point of coherency on page B2-1281](#)
  - for DCCMVAU, [Effect of the Multiprocessing Extensions on operations not to the point of coherency on page B2-1282](#).

For a data or unified cache operation by MVA, the operation cannot generate a Data Abort exception for a Domain fault or a Permission fault, except for the Permission fault cases described in:

- [Virtualization Extensions upgrading of maintenance operations on page B2-1286](#)
- [Stage 2 fault on a stage 1 translation table walk, Virtualization Extensions on page B3-1402](#).

For more information about these faults see [MMU faults on page B3-1403](#).

#### **Operations by set/way**

The data and unified cache operations by set/way are:

<b>DCISW</b>	Invalidate.
<b>DCCSW</b>	Clean.
<b>DCCISW</b>	Clean and invalidate, to point of coherency.

These operations invalidate, clean, or clean and invalidate a data or unified cache line based on its location in the cache hierarchy. For more information see:

- [Requirements for operations by set/way on page B2-1280](#)
- for an implementation that includes the Multiprocessing Extensions, [Effect of the Multiprocessing Extensions on All and set/way maintenance operations on page B2-1283](#).

### **Instruction cache operations**

The supported operations, grouped by the operation type, are:

#### **Operation by MVA**

**ICIMVAU** Invalidate, to point of unification.

This instruction invalidates an instruction cache line based on the address it contains. For more information see:

- [Requirements for operations by MVA on page B2-1280.](#)
- for an implementation that includes the Multiprocessing Extensions, [Effect of the Multiprocessing Extensions on operations not to the point of coherency on page B2-1282.](#)

For an instruction cache operation by MVA:

- it is IMPLEMENTATION DEFINED whether the operation can generate a Data Abort exception for a Translation fault or an Access flag fault
- the operation cannot generate a Data Abort exception for a Domain fault or a Permission fault, except for the Permission fault case described in [Stage 2 fault on a stage 1 translation table walk, Virtualization Extensions on page B3-1402.](#)

For more information about these faults see [MMU faults on page B3-1403.](#)

#### **Operations on all entries**

The instruction cache operations that operate on all entries are:

**ICIALLU** Invalidate all, to point of unification.

**ICIALLUIS** Invalidate all, to point of unification, Inner Shareable.

These instructions invalidate the entire instruction cache or caches, and, if branch predictors are architecturally-visible, all branch predictors. **ICIALLUIS** operates on all processors in the Inner Shareable domain of the processor that performs the operation.

For more information about these instructions on an implementation that includes the Multiprocessing Extensions, see [Effect of the Multiprocessing Extensions on All and set/way maintenance operations on page B2-1283.](#)

### **Branch predictor operations**

The supported operations, grouped by the operation type, are:

#### **Operation by MVA**

**BPIMVA** Invalidate.

Invalidates the branch predictor based on a branch address. For more information see:

- [Requirements for operations by MVA on page B2-1280.](#)
- for an implementation that includes the Multiprocessing Extensions, [Effect of the Multiprocessing Extensions on operations not to the point of coherency on page B2-1282.](#)

#### **Operations on all entries**

The instruction cache operations that operate on all entries are:

**BPIALL** Invalidate all.

**BPIALLIS** Invalidate all, Inner Shareable.

These instructions invalidate all branch predictors. **BPIALLIS** operates on all processors in the Inner Shareable domain of the processor that performs the operation.

For more information about these instructions on an implementation that includes the Multiprocessing Extensions, see [Effect of the Multiprocessing Extensions on All and set/way maintenance operations on page B2-1283.](#)

## Requirements for cache and branch predictor maintenance operations

The following subsections give information about the requirements for the cache and branch predictor operations that take arguments that define their target:

- [Requirements for operations by MVA](#)
- [Requirements for operations by set/way.](#)

### Requirements for operations by MVA

In the cache operations, any operation described as operating by MVA includes as part of any required MVA to PA translation:

- for an operation performed at PL1, the current system *Address Space Identifier* (ASID)
- if the implementation includes the Security Extensions, the current security state
- if the implementation includes the Virtualization Extensions:
  - whether the operation was performed from Hyp mode, or from a Non-secure PL1 mode
  - for an operation performed from a Non-secure PL1 mode, the *virtual machine identifier* (VMID).

### Requirements for operations by set/way

Cache maintenance operations that work by set/way use the level, set and way values to determine the location acted on by the operation. The address in memory that corresponds to this cache location is determined by the cache.

#### ———— Note —————

Because the allocation of a memory address to a cache location is entirely IMPLEMENTATION DEFINED, ARM expects that most portable software will use only the set/way operations as single steps in a routine to perform maintenance on the entire cache.

## Scope of cache and branch predictor maintenance operations

The following subsections describe the general architectural requirements for the scope of cache and branch predictor maintenance operations, and how the Multiprocessing Extensions affect the scope of different operations:

- [General requirements for the scope of maintenance operations](#)
- [Effect of the Multiprocessing Extensions on operations to the point of coherency on page B2-1281](#)
- [Effect of the Multiprocessing Extensions on operations not to the point of coherency on page B2-1282](#)
- [Effect of the Multiprocessing Extensions on All and set/way maintenance operations on page B2-1283](#)
- [Effects of the Security and Virtualization Extensions on the maintenance operations on page B2-1284](#)
- [Additional requirements of the Virtualization Extensions on page B2-1285.](#)

### General requirements for the scope of maintenance operations

The ARMv7 specification of the cache maintenance operations describes what each operation is guaranteed to do in a system. It does not limit other behaviors that might occur, provided they are consistent with the requirements described in [Cache behavior on page B2-1267](#) and in [Branch predictors on page B2-1271](#).

This means that:

- as a side-effect of a cache maintenance operation:
  - any location in the cache might be cleaned
  - any unlocked location in the cache might be cleaned and invalidated.
- as a side-effect of a branch predictor maintenance operation, any entry in the branch predictor might be invalidated.

———— **Note** —————

ARM recommends that, for best performance, such side-effects are kept to a minimum. In particular, in an implementation that includes the Security Extensions, ARM strongly recommends that the side-effects of operations performed in Non-secure state do not have a significant performance impact on execution in Secure state.

In addition, on a VMSAv7 implementation:

- if the implementation includes the Security Extensions, each security state has its own physical address space, affecting the required and permitted scope of cache maintenance operations
- the Virtualization Extensions add additional requirements for the cache maintenance operations.

*Effects of the Security and Virtualization Extensions on the maintenance operations on page B2-1284* describes these effects.

**Effect of the Multiprocessing Extensions on operations to the point of coherency**

The Multiprocessing Extensions add requirements for the scope of the following operations, that affect data and unified caches to the point of coherency:

- invalidate data, or unified, cache line by MVA to the point of coherency, [DCIMVAC](#)
- clean data, or unified, cache line by MVA to the point of coherency, [DCCMVAC](#)
- clean and invalidate data, or unified, cache line by MVA to the point of coherency, [DCCIMVAC](#).

For Normal memory that is not Inner Non-cacheable, Outer Non-cacheable, these instructions must affect the caches of other processors in the shareability domain described by the shareability attributes of the MVA supplied with the operation.

In the following cases, these operations must affect the caches of all processors in the Outer Shareable shareability domain of the processor on which the operation is performed:

- For Strongly-ordered memory
- In an implementation that includes the Large Physical Address Extension, for Device memory. When using the Short-descriptor translation table format this requirement applies regardless of any shareability attribute applied to the region. This means that any [PRRR.NOS](#) bit that applies to the Device memory region has no effect on the scope of the operation.

On an implementation that does not include the Large Physical Address Extension, for Device memory it is IMPLEMENTATION DEFINED which of the following applies:

- these operations affect the caches of other processors in the Outer Shareable shareability domain
- these operations affect the caches of other processors in the shareability domain defined by the shareability attributes of the MVA passed with the instruction.

On an implementation that includes the Large Physical Address Extension and is using the Short-descriptor translation table format, for Normal memory that is Inner Non-cacheable, Outer Non-cacheable, it is IMPLEMENTATION DEFINED which of the following applies:

- these operations affect the caches of other processors in the Outer Shareable shareability domain
- these operations affect the caches of other processors in the shareability domain defined by the shareability attributes of the MVA passed with the instruction.

In all cases, for any affected processor, these operations affect all data and unified caches to the point of coherency.

For the cases where the shareability attribute of the MVA supplied with the operation determines the scope of the operation, [Table B2-1](#) shows how this attribute determines the minimum set of processors affected, and the point to which the operation must be effective.

**Table B2-1 Processors affected by Data and Unified cache operations**

Shareability	Processors affected	Effective to
Non-shareable	The processor performing the operation	Point of coherency of the entire system
Inner Shareable	All processors in the same Inner Shareable shareability domain as the processor performing the operation	Point of coherency of the entire system
Outer Shareable	All processors in the same Outer Shareable shareability domain as the processor performing the operation	Point of coherency of the entire system

***Effect of the Multiprocessing Extensions on operations not to the point of coherency***

The Multiprocessing Extensions add requirements for the scope of the following operations, that operate by MVA but not to the point of coherency:

- Clean data, or unified, cache line by MVA to the point of unification, [DCCMVAU](#)
- Invalidate instruction cache line by MVA to point of unification, [ICIMVAU](#)
- Invalidate MVA from branch predictors, [BPIMVA](#).

On an implementation that includes the Large Physical Address Extension:

- For an MVA in a Strongly-ordered or Device memory region, then these operations apply to all processors in the Outer Shareable shareability domain.

———— **Note** —————

For Device memory, this requirement applies regardless of the current translation table format. When using the Short-descriptor format, the shareability attribute of a Device memory region has no effect on the scope of these operations. This means that any [PRRR.NOS](#) bit that applies to the Device memory region has no effect on the scope of the operation.

- When the implementation is using the Short-descriptor translation table format, for Normal memory that is Inner Non-cacheable, Outer Non-cacheable, it is IMPLEMENTATION DEFINED which of the following applies:
  - these operations affect the caches of other processors in the Outer Shareable shareability domain
  - these operations affect the caches of other processors in the shareability domain defined by the shareability attributes of the MVA passed with the instruction.

Otherwise, for these operations:

- [Table B2-2 on page B2-1283](#) shows how, for an MVA in a Normal or Device memory region, the shareability attribute of the MVA determines the minimum set of processors affected, and the point to which the operation must be effective.

- The scope of an operation using an MVA in a Strongly-Ordered memory region is the same as that shown, in Table B2-2, for an address with an *Inner Shareable* or *Outer Shareable* attribute.

**Table B2-2 Processors affected by Address-based cache maintenance operations**

Shareability	Processors affected	Effective to
Non-shareable	The processor performing the operation	Point of unification of instruction cache fills, data cache fills and write-backs, and translation table walks, on the processor performing the operation
Inner Shareable or Outer Shareable	All processors in the same Inner Shareable shareability domain as the processor performing the operation	To the point of unification of instruction cache fills, data cache fills and write-backs, and translation table walks, of all processors in the same Inner Shareable shareability domain as the processor performing the operation

———— **Note** ————

The set of processors guaranteed to be affected is never greater than the processors in the Inner Shareable shareability domain containing the processor performing the operation.

**Effect of the Multiprocessing Extensions on All and set/way maintenance operations**

For an implementation that includes the Multiprocessing Extension, this section describes the architecturally-required effect of local and Inner Shareable instructions for cache and branch predictor maintenance operations that operate on all entries, or operate by set/way:

**Local instructions**

The only architectural guarantee for the following instructions is that they apply to the caches or branch predictors of the processor that performs the operation:

- Invalidate entire instruction cache, [ICIALLU](#)
- Invalidate all branch predictors, [BPIALL](#)
- Clean and Invalidate data or unified cache line by set/way, [DCCISW](#)
- Clean data or unified cache line by set/way, [DCCSW](#)
- Invalidate data or unified cache line by set/way, [DCISW](#).

That is, these operations have an effect only on the processor that performs the operation.

If the branch predictors are architecturally-visible, [ICIALLU](#) also performs a [BPIALL](#) operation.

These operations are functionally unchanged from their operation in an ARMv7 implementation that does not include the Multiprocessing Extensions.

**Inner Shareable instructions**

The following instructions can affect the caches or branch predictors of all processors in the same Inner Shareable shareability domain as the processor that performs the operation:

- Invalidate all branch predictors Inner Shareable, [BPIALLIS](#)
- Invalidate entire instruction cache Inner Shareable, [ICIALLUIS](#).

If the branch predictors are architecturally-visible, [ICIALLUIS](#) also performs a [BPIALLIS](#) operation.

These operations have an effect to the point of unification of instruction cache fills, data cache fills and write-backs, and translation table walks, of all processors in the same Inner Shareable shareability domain.

**Effects of the Security and Virtualization Extensions on the maintenance operations**

In an implementation that includes the Security Extensions, each security state has its own physical address space, and therefore cache and branch predictor entries are associated with a physical address space. In addition, in an implementation that includes the Virtualization Extensions, cache and branch predictor maintenance operations performed in Non-secure state have to take account of:

- whether the operation was performed at PL1 or at PL2
- for operations by MVA, the current VMID.

Table B2-3 shows the effect of the Security and Virtualization Extensions on these maintenance operations.

**Table B2-3 Effect of the Security and Virtualization Extensions on the maintenance operations**

Cache operation	Security state	Targeted entry
Data or unified cache operations		
Invalidate, Clean, or Clean and Invalidate by MVA: DCIMVAC, DCCMVAC, DCCMVAU, DCCIMVAC	Either	All Lines that hold the PA that, in the current security state, is mapped to by the combination of all of <sup>a</sup> : <ul style="list-style-type: none"> <li>• the specified MVA</li> <li>• the current ASID</li> <li>• in an implementation that includes the Virtualization Extensions, for an operation performed in a Non-secure PL1 mode, the current VMID<sup>c</sup>.</li> </ul>
Invalidate, Clean, or Clean and Invalidate by set/way: DCISW, DCCSW, DCCISW	Non-secure	Line specified by set/way provided that the entry comes from the Non-secure PA space. <sup>a</sup>
	Secure	Line specified by set/way regardless of the PA space that the entry has come from.
Instruction cache operations		
Invalidate by MVA: ICIMVAU	Either	Implementation without the IVIPT Extension: <sup>b</sup>
		All Lines that match the specified MVA and the current ASID, and come from the same VA space as the current security state. In an implementation that includes the Virtualization Extensions, for an operation performed in Non-secure state, lines are invalidated only if they also match the current VMID <sup>c</sup> and security level, PL1 or PL2.
		Implementation with the IVIPT Extension: <sup>b</sup>
		All Lines that hold the PA that, in the current security state, is mapped to by the combination of all of: <ul style="list-style-type: none"> <li>• the specified MVA</li> <li>• the current ASID</li> <li>• in an implementation that includes the Virtualization Extensions, for an operation performed in a Non-secure PL1 mode, the current VMID<sup>c</sup>.</li> </ul>
Invalidate All: ICIALLU, ICIALLUIS	<ul style="list-style-type: none"> <li>• Can invalidate any unlocked entry in the instruction cache.</li> <li>• Are required to invalidate any entries relevant to the software component that executed it. The Non-secure and Secure descriptions give more information.</li> </ul>	
		Non-secure
	Secure	Must invalidate all instruction cache lines



**Table B2-3 Effect of the Security and Virtualization Extensions on the maintenance operations (continued)**

Cache operation	Security state	Targeted entry
Branch predictor operations		
Invalidate by MVA: BPIMVA	Either	All entries that match the specified MVA and the current ASID, and come from the same VA space as the current security state. In an implementation that includes the Virtualization Extensions, for an operation performed in Non-secure state, entries are invalidated only if they also match the current VMID <sup>c</sup> and security level, PL1 or PL2.
Invalidate all: BPIALL, BPIALLIS	<ul style="list-style-type: none"> <li>Can invalidate any unlocked entry in the instruction cache.</li> <li>Are required to invalidate any entries relevant to the software component that executed it. The Non-secure and Secure descriptions give more information.</li> </ul>	
	Non-secure	In an implementation that includes the Virtualization Extensions, an operation performed at PL1 must apply to all entries associated with the current virtual machine, meaning any entry with the current VMID <sup>c</sup> .  Otherwise, an operation must apply to all entries that can be accessed from Non-secure state.
	Secure	Must invalidate all entries.

- See also [Additional requirements of the Virtualization Extensions](#).
- See [IVIPT architecture extension on page B3-1394](#).
- Dependencies on the VMID apply even when HCR.VM is set to 0. However, VTTBR.VMID resets to zero, meaning there is a valid VMID from reset.

For locked entries and entries that might be locked, the behavior of cache maintenance operations described in [The interaction of cache lockdown with cache maintenance operations on page B2-1287](#) applies. This behavior is not affected by either the Security Extensions or the Virtualization Extensions.

With an implementation that generates aborts if entries are locked or might be locked in the cache, when the use of lockdown aborts is enabled, these aborts can occur on any cache maintenance operation regardless of the Security Extensions.

For more information about the cache maintenance operations see [About ARMv7 cache and branch predictor maintenance functionality on page B2-1273](#) and [Cache and branch predictor maintenance operations, VMSA on page B4-1740](#).

### **Additional requirements of the Virtualization Extensions**

An implementation that includes the Virtualization Extensions has the following additional requirements for cache maintenance:

- The architecture does not require cache cleaning when switching between virtual machines. Cache invalidation by set/way must not present an opportunity for one virtual machine to corrupt state associated with a second virtual machine. To ensure this requirement is met, Non-secure clean by set/way operations can be upgraded to clean and invalidate by set/way.
- A data or unified clean by MVA operation performed in a Non-secure PL1 mode must not cause a change to a data location for which the stage 2 translation properties do not permit write access.

For more information about these cases, see [Virtualization Extensions upgrading of maintenance operations on page B2-1286](#).

## Virtualization Extensions upgrading of maintenance operations

In an implementation that includes the Virtualization Extensions:

- When `HCR.FB` is set to 1, for maintenance operations performed in a Non-secure PL1 mode:
  - An `ICIALLU` is broadcast across the Inner Shareable domain. This means it is *upgraded to* `ICIALUIS`.
  - A `BPIALL` is broadcast across the Inner Shareable domain. This means it is upgraded to `BPIALLIS`.
- When `HCR.SWIO` is set to 1, an invalidate by set/way performed in a Non-secure PL1 mode is treated as a clean and invalidate by set/way. This means `DCISW` is upgraded to `DCCISW`.

As indicated in *Additional requirements of the Virtualization Extensions on page B2-1285*, a Data or unified cache invalidation by MVA operation performed in a Non-secure PL1 mode must not cause a change to data in a location for which the stage 2 translation permissions do not permit write access. Where such a permission violation occurs, it is IMPLEMENTATION DEFINED whether:

- a stage 2 Permission fault is generated for the `DCIMVAC` operation
- the `DCIMVAC` operation is upgraded to `DCCIMVAC`.

### Note

Functionally, upgrading `DCIMVAC` to `DCCIMVAC` is acceptable for any data invalidate by MVA executed in a Non-secure PL1 mode. Therefore, the implementation documentation might not specify the exact conditions in which this upgrade occurs. Possible approaches are to upgrade `DCIMVAC` to `DCCIMVAC`:

- for any Non-secure PL1 operation when the stage 2 MMU is enabled
- only if a stage 2 Permission fault is detected.

## Performing cache maintenance operations

To ensure all cache lines in a block of address space are maintained through all levels of cache, ARM strongly recommends that software:

- for data or unified cache maintenance, uses the `CTR.DMINLINE` value to determine the loop increment size for a loop of data cache maintenance by MVA operations
- for instruction cache maintenance, uses the `CTR.IMINLINE` value to determine the loop increment size for a loop of instruction cache maintenance by MVA operations.

### Example code for cache maintenance operations

The code sequence given in this subsection illustrates a generic mechanism for cleaning the entire data or unified cache to the point of coherency.

### Note

In a multiprocessor implementation where multiple processors share a cache before the point of coherency, running this sequence on multiple processors results in the operations being repeated on the shared cache.

```
MRC p15, 1, R0, c0, c0, 1 ; Read CLIDR into R0
ANDS R3, R0, #0x07000000
MOV R3, R3, LSR #23 ; Cache level value (naturally aligned)
BEQ Finished
MOV R10, #0
Loop1
ADD R2, R10, R10, LSR #1 ; Work out 3 x cachelevel
MOV R1, R0, LSR R2 ; bottom 3 bits are the Cache type for this level
AND R1, R1, #7 ; get those 3 bits alone
CMP R1, #2
BLT Skip ; no cache or only instruction cache at this level
MCR p15, 2, R10, c0, c0, 0 ; write CSSELR from R10
ISB ; ISB to sync the change to the CCSIDR
MRC p15, 1, R1, c0, c0, 0 ; read current CCSIDR to R1
```

```

AND R2, R1, #7           ; extract the line length field
ADD R2, R2, #4           ; add 4 for the line length offset (log2 16 bytes)
LDR R4, =0x3FF
ANDS R4, R4, R1, LSR #3  ; R4 is the max number on the way size (right aligned)
CLZ R5, R4                ; R5 is the bit position of the way size increment
MOV R9, R4                ; R9 working copy of the max way size (right aligned)
Loop2
LDR R7, =0x00007FFF
ANDS R7, R7, R1, LSR #13 ; R7 is the max number of the index size (right aligned)
Loop3
ORR R11, R10, R9, LSL R5 ; factor in the way number and cache number into R11
ORR R11, R11, R7, LSL R2 ; factor in the index number
MCR p15, 0, R11, c7, c10, 2 ; DCCSW, clean by set/way
SUBS R7, R7, #1          ; decrement the index
BGE Loop3
SUBS R9, R9, #1          ; decrement the way number
BGE Loop2

Skip
ADD R10, R10, #2         ; increment the cache number
CMP R3, R10
BGT Loop1
DSB
Finished
  
```

Similar approaches can be used for all cache maintenance operations.

### **Boundary conditions for cache maintenance operations**

Cache maintenance operations operate on the caches when the caches are enabled or when they are disabled.

For the address-based cache maintenance operations, the operations operate on the caches regardless of the memory type and cacheability attributes marked for the memory address in the VMSA translation table entries or in the PMSA section attributes. This means that the cache operations can apply regardless of:

- whether the address accessed:
  - is Strongly-ordered, Device or Normal memory
  - has a Cacheable attribute, or the Non-cacheable attribute
- any applicable domain control of the address accessed
- the access permissions for the address accessed.

## **B2.2.8 The interaction of cache lockdown with cache maintenance operations**

The interaction of cache lockdown and cache maintenance operations is IMPLEMENTATION DEFINED. However, an architecturally-defined cache maintenance operation on a locked cache line must comply with the following general rules:

- The effect of the following operations on locked cache entries is IMPLEMENTATION DEFINED:
  - cache clean by set/way, [DCCSW](#)
  - cache invalidate by set/way, [DCISW](#)
  - cache clean and invalidate by set/way, [DCCISW](#)
  - instruction cache invalidate all, [ICIALLU](#) and [ICIALUIS](#).

However, one of the following approaches must be adopted in all these cases:

1. If the operation specified an invalidation, a locked entry is not invalidated from the cache. If the operation specified a clean it is IMPLEMENTATION DEFINED whether locked entries are cleaned.
2. If an entry is locked down, or could be locked down, an IMPLEMENTATION DEFINED Data Abort exception is generated, using the fault status code defined for this purpose in CP15 c5, see either:
  - [Exception reporting in a VMSA implementation on page B3-1409](#)
  - [Exception reporting in a PMSA implementation on page B5-1767](#).

This permits a usage model for cache invalidate routines to operate on a large range of addresses by performing the required operation on the entire cache, without having to consider whether any cache entries are locked. The operation performed is either an invalidate, or a clean and invalidate.

- The effect of the following operations is IMPLEMENTATION DEFINED:
  - cache clean by MVA, [DCCMVAC](#) and [DCCMVAU](#)
  - cache invalidate by MVA, [DCIMVAC](#)
  - cache clean and invalidate by MVA, [DCCIMVAC](#).

However, one of the following approaches must be adopted in all these cases:

1. If the operation specified an invalidation, a locked entry is invalidated from the cache. For the clean and invalidate operation, the entry must be cleaned before it is invalidated.
2. If the operation specified an invalidation, a locked entry is not invalidated from the cache. If the operation specified a clean it is IMPLEMENTATION DEFINED whether locked entries are cleaned.
3. If an entry is locked down, or could be locked down, an IMPLEMENTATION DEFINED Data Abort exception is generated, using the fault status code defined for this purpose in CP15 c5, see either:
  - [Exception reporting in a VMSA implementation on page B3-1409](#)
  - [Exception reporting in a PMSA implementation on page B5-1767](#).

In an implementation that includes the Virtualization Extensions, if HCR.TIDCP is set to 1, any such exception taken from a Non-secure PL1 mode is routed to Hyp mode, see [Trapping accesses to lockdown, DMA, and TCM operations on page B1-1252](#).

#### ———— Note —————

An implementation that uses an abort mechanisms for entries that can be locked down but are not actually locked down must:

- document the IMPLEMENTATION DEFINED instruction sequences that perform the required operations on entries that are not locked down
- implement one of the other permitted alternatives for the locked entries.

ARM recommends that, when possible, such IMPLEMENTATION DEFINED instruction sequences use architecturally-defined operations. This minimizes the number of customized operations required.

In addition, an implementation that uses an abort mechanism for handling cache maintenance operations on entries that can be locked down but are not actually locked down, must provide a mechanism that ensures that no cache entries are locked. The reset setting of the cache must be that no cache entries are locked.

On an ARMv7-A implementation, similar rules apply to TLB lockdown, see [The interaction of TLB lockdown with TLB maintenance operations on page B3-1382](#).

### **Additional cache functions for the implementation of lockdown**

An implementation can add additional cache maintenance functions for the handling of lockdown in the IMPLEMENTATION DEFINED spaces reserved for Cache Lockdown. Examples of possible functions are:

- Operations that unlock all cache entries.
- Operations that preload into specific levels of cache. These operations might be provided for instruction caches, data caches, or both.

An implementation can add other functions as required.

## B2.2.9 Ordering of cache and branch predictor maintenance operations

The following rules describe the effect of the memory order model on the cache and branch predictor maintenance operations:

- All cache and branch predictor maintenance operations that do not specify an address execute, relative to each other, in program order.  
All cache and branch predictor operations that specify an address:
  - execute in program order relative to all cache and branch predictor operations that do not specify an address
  - execute in program order relative to all cache and branch predictor operations that specify the same address
  - can execute in any order relative to cache and branch predictor operations that specify a different address.
- On an ARMv7-A implementation:
  - where a cache or branch predictor maintenance operation appears in program order before a change to the translation tables, the architecture guarantees that the cache or branch predictor maintenance operation uses the translations that were visible before the change to the translation tables
  - where a change of the translation tables appears in program order before a cache or branch predictor maintenance operation, software must execute the sequence outlined in [TLB maintenance operations and the memory order model on page B3-1383](#) before performing the cache or branch predictor maintenance operation, to ensure that the maintenance operation uses the new translations.
- A DMB instruction causes the effect of all data or unified cache maintenance operations appearing in program order before the DMB to be visible to all explicit load and store operations appearing in program order after the DMB.  
Also, a DMB instruction ensures that the effects of any data or unified cache maintenance operations appearing in program order before the DMB are observable by any observer in the same required shareability domain before any data or unified cache maintenance or explicit memory operations appearing in program order after the DMB are observed by the same observer. Completion of the DMB does not guarantee the visibility of all data to other observers. For example, all data might not be visible to a translation table walk, or to instruction fetches.
- A DSB is required to guarantee the completion of all cache maintenance operations that appear in program order before the DSB instruction.
- A context synchronization operation is required to guarantee the effects of any branch predictor maintenance operation. This means a context synchronization operation causes the effect of all completed branch predictor maintenance operations appearing in program order before the context synchronization operation to be visible to all instructions after the context synchronization operation.

———— **Note** ————

See [Context synchronization operation](#) in the [Glossary](#) for the definition of this term.

This means that, if a branch instruction appears after an invalidate branch predictor operation and before any context synchronization operation, it is UNPREDICTABLE whether the branch instruction is affected by the invalidate. Software must avoid this ordering of instructions, because it might cause UNPREDICTABLE behavior.

- Any data or unified cache maintenance operation by MVA must be executed in program order relative to any explicit load or store on the same processor to an address covered by the MVA of the cache operation if that load or store is to Normal Cacheable memory. The order of memory accesses that result from the cache maintenance operation, relative to any other memory accesses to Normal Cacheable memory, are subject to the memory ordering rules. For more information, see [Ordering requirements for memory accesses on page A3-148](#).

Any data or unified cache maintenance operation by MVA can be executed in any order relative to any explicit load or store on the same processor to an address covered by the MVA of the cache operation if that load or store is not to Normal Cacheable memory.

- There is no restriction on the ordering of data or unified cache maintenance operations by MVA relative to any explicit load or store on the same processor where the address of the explicit load or store is not covered by the MVA of the cache operation. Where the ordering must be restricted, a DMB instruction must be inserted to enforce ordering.
- There is no restriction on the ordering of a data or unified cache maintenance operation by set/way relative to any explicit load or store on the same processor. Where the ordering must be restricted, a DMB instruction must be inserted to enforce ordering.
- Software must execute a context synchronization operation after the completion of an instruction cache maintenance operation, to guarantee that the effect of the maintenance operation is visible to any instruction fetch.

In a VMSAv7 implementation, the scope of instruction cache maintenance depends on the type of the instruction cache. For more information see [Instruction caches on page B3-1392](#).

### Example B2-1 Cache cleaning operations for self-modifying code

---

The sequence of cache cleaning operations for a line of self-modifying code on a uniprocessor system is:

```
; Enter this code with <Rx> containing the new 32-bit instruction. Use STRH in the first
; line instead of STR for a 16-bit instruction.
STR    <Rx>, [instruction location]
DCCMVAU [instruction location] ; Clean data cache by MVA to point of unification
DSB    ; Ensure visibility of the data cleaned from the cache
ICIMVAU [instruction location] ; Invalidate instruction cache by MVA to PoU
BPIMVAU [instruction location] ; Invalidate branch predictor by MVA to PoU
DSB    ; Ensure completion of the invalidations
ISB    ; Synchronize fetched instruction stream
```

---

## B2.2.10 System level caches

The system level architecture might define further aspects of the software view of caches and the memory model that are not defined by the ARMv7 processor architecture. These aspects of the system level architecture can affect the requirements for software management of caches and coherency. For example, a system design might introduce additional levels of caching that cannot be managed using the CP15 maintenance operations defined by the ARMv7 architecture. Such caches are referred to as *system caches* and are managed through the use of memory-mapped operations. The ARMv7 architecture does not forbid the presence of system caches that are outside the scope of the architecture, but ARM strongly recommends that such caches are always placed after the point of coherency for all memory locations that might be held in the cache. Placing such system caches after the point of coherency means that coherency management does not require maintenance of these system caches.

ARM also strongly recommends:

- For the maintenance of any such system cache:
  - physical, rather than virtual, addresses are used for address-based cache maintenance operations.
  - any IMPLEMENTATION DEFINED system cache maintenance operations include at least the set of functions defined by [Cache and branch predictor maintenance operations on page B2-1277](#), with the number of levels of system cache operated on by these cache maintenance operations being IMPLEMENTATION DEFINED.
- Wherever possible, all caches that require maintenance to ensure coherency are included in the caches affected by the architecturally-defined CP15 cache maintenance operations, so that the architecturally-defined software sequences for managing the memory model and coherency are sufficient for managing all caches in the system.

## B2.3 IMPLEMENTATION DEFINED memory system features

ARMv7 reserves space in the [SCTLR](#) for use with IMPLEMENTATION DEFINED features of the cache, and other IMPLEMENTATION DEFINED features of the memory system architecture.

In particular, in ARMv7 the following memory system features are IMPLEMENTATION DEFINED:

- Cache lockdown, see [Cache lockdown on page B2-1270](#).
- In VMSAv7, TLB lockdown, see [TLB lockdown on page B3-1379](#).
- *Tightly Coupled Memory* (TCM) support, including any associated DMA scheme. The TCM Type Register, [TCMTR](#) is required in all implementations, and if no TCMs are implemented this must be indicated by the value of this register.

———— **Note** —————

For details of the optional TCMs and associated DMA scheme in ARMv6 see [TCM support on page AppxL-2518](#).

### B2.3.1 ARMv7 CP15 register support for IMPLEMENTATION DEFINED features

The ARMv7 CP15 registers implementation includes the following support for IMPLEMENTATION DEFINED features of the memory system:

- The TCM Type Register, [TCMTR](#), in CP15 c0, must be implemented. The following conditions apply to this register:
  - If no TCMs are implemented, the [TCMTR](#) indicates zero-size TCMs. For more information see [TCMTR, TCM Type Register, VMSA on page B4-1713](#) or [TCMTR, TCM Type Register, PMSA on page B6-1936](#).
  - If bits[31:29] are 0b100, the format of the rest of the register format is IMPLEMENTATION DEFINED. This value indicates that the implementation includes TCMs that do not follow the ARMv6 usage model. Other fields in the register might give more information about the TCMs.
- The CP15 c9 encoding space with  $\langle CRm \rangle = \{0-2, 5-7\}$  is IMPLEMENTATION DEFINED for all values of  $\langle opc2 \rangle$  and  $\langle opc1 \rangle$ . This space is reserved for branch predictor, cache and TCM functionality, for example maintenance, override behaviors and lockdown. It permits:
  - ARMv6 backwards compatible schemes
  - alternative schemes.

For more information, see:

- [Cache and TCM lockdown registers, VMSA on page B4-1750](#), for a VMSA implementation
- [Cache and TCM lockdown registers, PMSA on page B6-1944](#), for a PMSA implementation.

- In a VMSAv7 implementation, part of the CP15 c10 encoding space is IMPLEMENTATION DEFINED and reserved for TLB functionality, see [TLB lockdown on page B3-1379](#).
- The CP15 c11 encoding space with  $\langle CRm \rangle = \{0-8, 15\}$  is IMPLEMENTATION DEFINED for all values of  $\langle opc2 \rangle$  and  $\langle opc1 \rangle$ . This space is reserved for DMA operations to and from the TCMs It permits:
  - an ARMv6 backwards compatible scheme
  - an alternative scheme.

For more information, see:

- [VMSA CP15 c11 register summary, reserved for TCM DMA registers on page B3-1478](#), for a VMSA implementation
- [PMSA CP15 c11 register summary, reserved for TCM DMA registers on page B5-1790](#), for a PMSA implementation.



## B2.4 Pseudocode details of general memory system operations

This section contains pseudocode describing general memory operations, in the subsections:

- [Memory data type definitions](#).
- [Basic memory accesses on page B2-1293](#).
- [Interfaces to memory system specific pseudocode on page B2-1293](#).
- [Aligned memory accesses on page B2-1294](#)
- [Unaligned memory accesses on page B2-1295](#)
- [Reverse endianness on page B2-1296](#)
- [Exclusive monitors operations on page B2-1297](#)
- [Access permission checking on page B2-1298](#)
- [Default memory access decode on page B2-1299](#)
- [Data Abort exception on page B2-1300](#).

The pseudocode in this section applies to both VMSA and PMSA implementations. Additional pseudocode for memory operations is given in:

- [Pseudocode details of VMSA memory system operations on page B3-1503](#)
- [Pseudocode details of PMSA memory system operations on page B5-1804](#).

### B2.4.1 Memory data type definitions

The following data type definitions are used by the memory system pseudocode functions:

```
// Types of memory

enumeration MemType {MemType_Normal, MemType_Device, MemType_StronglyOrdered};
// Memory attributes descriptor

type MemoryAttributes is (
    MemType type,
    bits(2) innerattrs, // The possible encodings for each attributes field are as follows:
    bits(2) outerattrs, // '00' = Non-cacheable; '10' = Write-Through
                        // '11' = Write-Back; '01' = RESERVED
    bits(2) innerhints, // the possible encodings for the hints are as follows
    bits(2) outerhints, // '00' = No-Allocate; '01' = Write-Allocate
                        // '10' = Read-Allocate; ;'11' = Read-Allocate and Write-Allocate

    boolean innertransient,
    boolean outertransient,

    boolean shareable,
    boolean outershareable
)

// Physical address type, with extra bits used by some VMSA features

type FullAddress is (
    bits(40) physicaladdress,
    bit      NS                // '0' = Secure, '1' = Non-secure
)

// Descriptor used to access the underlying memory array

type AddressDescriptor is (
    MemoryAttributes memattrs,
    FullAddress      paddress
)
```



```
// Access permissions descriptor

type Permissions is (
  bits(3) ap, // Access permission bits
  bit xn, // Execute-never bit
  bit pxn // Privileged execute-never bit
)
```

## B2.4.2 Basic memory accesses

The `_Mem[]` function performs single-copy atomic, aligned, little-endian memory accesses to the underlying physical memory array of bytes:

```
bits(8*size) _Mem[AddressDescriptor memaddrdesc, integer size]
  assert size == 1 || size == 2 || size == 4 || size == 8;

_Mem[AddressDescriptor memaddrdesc, integer size] = bits(8*size) value
  assert size == 1 || size == 2 || size == 4 || size == 8;
```

This function addresses the array using `memaddrdesc.address`, that supplies:

- A 32-bit physical address.
- An 8-bit physical address extension, that is treated as additional high-order bits of the physical address. This extension is always `0b00000000` in the PMSA.
- A single NS bit to select between Secure and Non-secure parts of the array. This bit is always 0 if the Security Extensions are not implemented.

The actual implemented array of memory might be smaller than the  $2^{41}$  bytes implied. In this case, the scheme for aliasing is IMPLEMENTATION DEFINED, or some parts of the address space might give rise to external aborts. For more information, see:

- [External aborts on page B3-1405](#) for a VMSA implementation
- [External aborts on page B5-1765](#) for a PMSA implementation.

Implementations might generate synchronous or asynchronous external aborts as a result of memory accesses, for a variety of IMPLEMENTATION DEFINED reasons. The handling and reporting of these aborts is outside the scope of the pseudocode.

The attributes in `memaddrdesc.memattr`s are used by the memory system to determine caching and ordering behaviors as described in [Memory types and attributes and the memory order model on page A3-125](#).

## B2.4.3 Interfaces to memory system specific pseudocode

The following functions call the VMSA-specific or PMSA-specific functions to handle Alignment faults and perform address translation.

```
// AlignmentFault()
// =====

AlignmentFault(bits(32) address, boolean iswrite)
  case MemorySystemArchitecture() of
    when MemArch_VMSA AlignmentFaultV(address, iswrite,
      CurrentModeIsHyp() || HCR.TGE == '1');
    when MemArch_PMSA AlignmentFaultP(address, iswrite);

// TranslateAddress()
// =====

AddressDescriptor TranslateAddress(bits(32) VA, boolean ispriv, boolean iswrite,
  integer size)
  case MemorySystemArchitecture() of
    when MemArch_VMSA return TranslateAddressV(VA, ispriv, iswrite, size);
    when MemArch_PMSA return TranslateAddressP(VA, ispriv, iswrite);
```

## B2.4.4 Aligned memory accesses

The MemA[] function performs a memory access at the current privilege level, and the MemA\_unpriv[] function performs an access that is always unprivileged. In both cases the architecture requires the access to be aligned, and in ARMv7 the function generates an Alignment fault if it is not.

———— **Note** —————

In versions of the architecture before ARMv7, if the SCTLR.A and SCTLR.U bits are both 0, an unaligned access is forced to be aligned by replacing the low-order address bits with zeros.

```
// MemA[]
// =====

bits(8*size) MemA[bits(32) address, integer size]
    return MemA_with_priv[address, size, CurrentModeIsNotUser()];

MemA[bits(32) address, integer size] = bits(8*size) value
    MemA_with_priv[address, size, CurrentModeIsNotUser()] = value;
    return;

// MemA_unpriv[]
// =====

bits(8*size) MemA_unpriv[bits(32) address, integer size]
    return MemA_with_priv[address, size, FALSE];

MemA_unpriv[bits(32) address, integer size] = bits(8*size) value
    MemA_with_priv[address, size, FALSE] = value;
    return;

// MemA_with_priv[]
// =====

// Non-assignment form
bits(8*size) MemA_with_priv[bits(32) address, integer size, boolean privileged]

    // Sort out alignment
    if address == Align(address, size) then
        VA = address;
    elsif SCTLR.A == '1' || SCTLR.U == '1' then
        AlignmentFault(address, FALSE);
    else // if legacy non alignment-checking configuration
        VA = Align(address, size);

    // MMU or MPU
    memaddrdesc = TranslateAddress(VA, privileged, FALSE, size);

    // Memory array access, and sort out endianness
    value = _Mem[memaddrdesc, size];
    if CPSR.E == '1' then
        value = BigEndianReverse(value, size);

    return value;

// Assignment form
MemA_with_priv[bits(32) address, integer size, boolean privileged] = bits(8*size) value

    // Sort out alignment
    if address == Align(address, size) then
        VA = address;
    elsif SCTLR.A == '1' || SCTLR.U == '1' then
        AlignmentFault(address, FALSE);
    else // if legacy non alignment-checking configuration
        VA = Align(address, size);

    // MMU or MPU
```

```

memaddrdesc = TranslateAddress(VA, privileged, TRUE, size);

// Effect on exclusives
if memaddrdesc.memattrs.shareable then
    ClearExclusiveByAddress(memaddrdesc.physicaladdress, ProcessorID(), size);

// Sort out endianness, then memory array access
if CPSR.E == '1' then
    value = BigEndianReverse(value, size);
_Mem[memaddrdesc,size] = value;

return;

```

## B2.4.5 Unaligned memory accesses

The MemU[] function performs a memory access at the current privilege level, and the MemU\_unpriv[] function performs an access that is always unprivileged.

In both cases:

- if the SCTL.R.A bit is 0, unaligned accesses are supported
- if the SCTL.R.A bit is 1, unaligned accesses produce Alignment faults.

### ———— Note ————

In versions of the architecture before ARMv7, if the SCTL.R.A and SCTL.R.U bits are both 0, an unaligned access is forced to be aligned by replacing the low-order address bits with zeros.

```

// MemU[]
// =====

bits(8*size) MemU[bits(32) address, integer size]
    return MemU_with_priv[address, size, CurrentModeIsNotUser()];

MemU[bits(32) address, integer size] = bits(8*size) value
    MemU_with_priv[address, size, CurrentModeIsNotUser()] = value;
    return;

// MemU_unpriv[]
// =====

bits(8*size) MemU_unpriv[bits(32) address, integer size]
    return MemU_with_priv[address, size, FALSE];

MemU_unpriv[bits(32) address, integer size] = bits(8*size) value
    MemU_with_priv[address, size, FALSE] = value;
    return;

// MemU_with_priv[]
// =====
//
// Due to single-copy atomicity constraints, the aligned accesses are distinguished from
// the unaligned accesses:
// * aligned accesses are performed at their size
// * unaligned accesses are expressed as a set of bytes.

// Non-assignment form

bits(8*size) MemU_with_priv[bits(32) address, integer size, boolean privileged]

    bits(8*size) value;

// Legacy non alignment-checking configuration forces access to be aligned
if SCTL.R.A == '0' && SCTL.R.U == '0' then address = Align(address, size);

// Do aligned access, take alignment fault, or do sequence of bytes
if address == Align(address, size) then

```

```

    value = MemA_with_priv[address, size, privileged];
  elseif SCTL.R.A == '1' then
    AlignmentFault(address, FALSE);
  else // if unaligned access, SCTL.R.A == '0', and SCTL.R.U == '1'
    for i = 0 to size-1
      value<8*i+7:8*i> = MemA_with_priv[address+i, 1, privileged];
      if CPSR.E == '1' then
        value = BigEndianReverse(value, size);

    return value;

// Assignment form
MemU_with_priv[bits(32) address, integer size, boolean privileged] = bits(8*size) value

// Legacy non alignment-checking configuration forces access to be aligned
if SCTL.R.A == '0' && SCTL.R.U == '0' then address = Align(address, size);

// Do aligned access, take alignment fault, or do sequence of bytes
if address == Align(address, size) then
  MemA_with_priv[address, value, privileged] = value;
elseif SCTL.R.A == '1' then
  AlignmentFault(address, TRUE);
else // if unaligned access, SCTL.R.A == '0', and SCTL.R.U == '1'
  if CPSR.E == '1' then
    value = BigEndianReverse(value, size);
  for i = 0 to size-1
    MemA_with_priv[address+i, 1, privileged] = value<8*i+7:8*i>;

return;

```

## B2.4.6 Reverse endianness

The following pseudocode describes the operation to reverse endianness:

```

// BigEndianReverse()
// =====

bits(8*N) BigEndianReverse (bits(8*N) value, integer N)
assert N == 1 || N == 2 || N == 4 || N == 8;
bits(8*N) result;
case N of
  when 1
    result<7:0> = value<7:0>;
  when 2
    result<15:8> = value<7:0>;
    result<7:0> = value<15:8>;
  when 4
    result<31:24> = value<7:0>;
    result<23:16> = value<15:8>;
    result<15:8> = value<23:16>;
    result<7:0> = value<31:24>;
  when 8
    result<63:56> = value<7:0>;
    result<55:48> = value<15:8>;
    result<47:40> = value<23:16>;
    result<39:32> = value<31:24>;
    result<31:24> = value<39:32>;
    result<23:16> = value<47:40>;
    result<15:8> = value<55:48>;
    result<7:0> = value<63:56>;
return result;

```

## B2.4.7 Exclusive monitors operations

The `SetExclusiveMonitors()` function sets the exclusive monitors for a Load-Exclusive instruction. The `ExclusiveMonitorsPass()` function checks whether a Store-Exclusive instruction still has possession of the exclusive monitors and therefore completes successfully.

```
// SetExclusiveMonitors()
// =====

SetExclusiveMonitors(bits(32) address, integer size)
    memaddrdesc = TranslateAddress(address, CurrentModeIsNotUser(), FALSE);

    if memaddrdesc.memattrs.shareable then
        MarkExclusiveGlobal(memaddrdesc.physicaladdress, ProcessorID(), size);

        MarkExclusiveLocal(memaddrdesc.physicaladdress, ProcessorID(), size);
// ExclusiveMonitorsPass()
// =====

boolean ExclusiveMonitorsPass(bits(32) address, integer size)
    // It is IMPLEMENTATION DEFINED whether the detection of memory aborts happens
    // before or after the check on the local Exclusive Monitor. As a result a failure
    // of the local monitor can occur on some implementations even if the memory
    // access would give an memory abort.

    if address != Align(address, size) then
        AlignmentFault(address, TRUE);
    else
        memaddrdesc = TranslateAddress(address, CurrentModeIsNotUser(), TRUE, size);

        passed = IsExclusiveLocal(memaddrdesc.paddress, ProcessorID(), size);
        if memaddrdesc.memattrs.shareable then
            passed = passed && IsExclusiveGlobal(memaddrdesc.paddress, ProcessorID(), size);

        if passed then
            ClearExclusiveLocal(ProcessorID());

    return passed;
```

The `MarkExclusiveGlobal()` procedure takes as arguments a `FullAddress` `address`, the processor identifier `processorid` and the size of the transfer. The procedure records that processor `processorid` has requested exclusive access covering at least `size` bytes from address `address`. The size of region marked as exclusive is IMPLEMENTATION DEFINED, up to a limit of 2KB, and no smaller than two words, and aligned in the address space to the size of the region. It is UNPREDICTABLE whether this causes any previous request for exclusive access to any other address by the same processor to be cleared.

```
MarkExclusiveGlobal(FullAddress address, integer processorid, integer size)
```

The `MarkExclusiveLocal()` procedure takes as arguments a `FullAddress` `address`, the processor identifier `processorid` and the size of the transfer. The procedure records in a local record that processor `processorid` has requested exclusive access to an address covering at least `size` bytes from address `address`. The size of the region marked as exclusive is IMPLEMENTATION DEFINED, and can at its largest cover the whole of memory, but is no smaller than two words, and is aligned in the address space to the size of the region. It is IMPLEMENTATION DEFINED whether this procedure also performs a `MarkExclusiveGlobal()` using the same parameters.

```
MarkExclusiveLocal(FullAddress address, integer processorid, integer size)
```

The `IsExclusiveGlobal()` function takes as arguments a `FullAddress` `address`, the processor identifier `processorid` and the size of the transfer. The function returns `TRUE` if the processor `processorid` has marked in a global record an address range as exclusive access requested that covers at least the `size` bytes from address `address`. It is IMPLEMENTATION DEFINED whether it returns `TRUE` or `FALSE` if a global record has marked a different address as exclusive access requested. If no address is marked in a global record as exclusive access, `IsExclusiveGlobal()` returns `FALSE`.

```
boolean IsExclusiveGlobal(FullAddress address, integer processorid, integer size)
```

The `IsExclusiveLocal()` function takes as arguments a `FullAddress` address, the processor identifier `processorid` and the size of the transfer. The function returns `TRUE` if the processor `processorid` has marked an address range as exclusive access requested that covers at least the size bytes from address `address`. It is `IMPLEMENTATION DEFINED` whether this function returns `TRUE` or `FALSE` if the address marked as exclusive access requested does not cover all of the size bytes from address `address`. If no address is marked as exclusive access requested, then this function returns `FALSE`. It is `IMPLEMENTATION DEFINED` whether this result is `ANDed` with the result of `IsExclusiveGlobal()` with the same parameters.

```
boolean IsExclusiveLocal(FullAddress address, integer processorid, integer size)
```

The `ClearExclusiveByAddress()` procedure takes as arguments a `FullAddress` address, the processor identifier `processorid` and the size of the transfer. The procedure clears the global records of all processors, other than `processorid`, for which an address region including any of the size bytes starting from `address` has had a request for an exclusive access. It is `IMPLEMENTATION DEFINED` whether the equivalent global record of the processor `processorid` is also cleared if any of the size bytes starting from `address` has had a request for an exclusive access, or if any other address has had a request for an exclusive access.

```
ClearExclusiveByAddress(FullAddress address, integer processorid, integer size)
```

The `ClearExclusiveLocal()` procedure takes as arguments the processor identifier `processorid`. The procedure clears the local record of processor `processorid` for which an address has had a request for an exclusive access. It is `IMPLEMENTATION DEFINED` whether this operation also clears the global record of processor `processorid` that an address has had a request for an exclusive access.

```
ClearExclusiveLocal(integer processorid)
```

## B2.4.8 Access permission checking

The function `CheckPermission()` is used by both the `VMSA` and `PMSA` architectures to perform access permission checking based on attributes derived from the translation tables or region descriptors. The `domain` and `sectionnotpage` arguments are only relevant for the `VMSA` architecture.

The interpretation of the access permissions is shown in:

- [Access permissions on page B3-1356](#), for a `VMSA` implementation
- [Access permissions on page B5-1759](#), for a `PMSA` implementation.

The following pseudocode describes the checking of the access permission:

```
// CheckPermission()
// =====
// Function used for permission checking at stage 1 of the translation process
// for the:
//   VMSA Long-descriptor format
//   VMSA Short-descriptor format
//   PMSA format.

CheckPermission(Permissions perms, bits(32) mva, integer level, bits(4) domain, boolean iswrite,
                boolean ispriv, boolean taketohypmode, boolean LDFSRformat)

// variable for the DataAbort function with fixed values

secondstageabort = FALSE;
ipavalid = FALSE;
s2fs1walk = FALSE;
ipa = bits(40) UNKNOWN;

if SCTL.AFE == '1' then
    perms.ap<0> = '1';

case perms.ap of
    when '000' abort = TRUE;
    when '001' abort = !ispriv;
    when '010' abort = !ispriv && iswrite;
    when '011' abort = FALSE;
```

```

when '100' UNPREDICTABLE;
when '101' abort = !ispriv || iswrite;
when '110' abort = iswrite;
when '111'
  if MemorySystemArchitecture() == MemArch_VMSA then
    abort = iswrite;
  else
    UNPREDICTABLE;

if abort then
  DataAbort(mva, ipa, domain, level, iswrite, DAbort_Permission, taketohypmode,
    secondstageabort, ipavalid, LDFSRformat, s2fslwalk);

return;

```

## B2.4.9 Default memory access decode

The function DefaultTEXDecode() is used by both the VMSA and PMSA architectures to decode the texcb and S attributes derived from the translation tables or region descriptors.

The following sections show the interpretation of the arguments:

- for a VMSA implementation:
  - [Short-descriptor format memory region attributes, without TEX remap on page B3-1367](#)
  - [Long-descriptor format memory region attributes on page B3-1372](#)
- for a PMSA implementation, [C, B, and TEX\[2:0\] encodings on page B5-1760](#).

The following pseudocode describes the default memory access decoding for a PMSA implementation, and for a VMSA implementation when TEX remap is not enabled:

```

// DefaultTEXDecode()
// =====

MemoryAttributes DefaultTEXDecode(bits(5) texcb, bit S)

MemoryAttributes memattrs;

case texcb of
  when '00000' // Strongly-ordered
    memattrs.type = MemType_StronglyOrdered;
    memattrs.innerattrs = bits(2) UNKNOWN;
    memattrs.innerhints = bits(2) UNKNOWN;
    memattrs.outerattrs = bits(2) UNKNOWN;
    memattrs.outerhints = bits(2) UNKNOWN;
    memattrs.shareable = TRUE;
  when '00001' // Shareable Device
    memattrs.type = MemType_Device;
    memattrs.innerattrs = bits(2) UNKNOWN;
    memattrs.innerhints = bits(2) UNKNOWN;
    memattrs.outerattrs = bits(2) UNKNOWN;
    memattrs.outerhints = bits(2) UNKNOWN;
    memattrs.shareable = TRUE;
  when '00010' // Outer and Inner Write-Through, no Write-Allocate
    memattrs.type = MemType_Normal;
    memattrs.innerattrs = '10';
    memattrs.innerhints = '10';
    memattrs.outerattrs = '10';
    memattrs.outerhints = '10';
    memattrs.shareable = (S == '1');
  when '00011' // Outer and Inner Write-Back, no Write-Allocate
    memattrs.type = MemType_Normal;
    memattrs.innerattrs = '11';
    memattrs.innerhints = '10';
    memattrs.outerattrs = '11';
    memattrs.outerhints = '10';
    memattrs.shareable = (S == '1');
  when '00100' // Outer and Inner Non-cacheable

```

```
        memattrs.type = MemType_Normal;
        memattrs.innerattrs = '00';
        memattrs.innerhints = '00';
        memattrs.outerattrs = '00';
        memattrs.outerhints = '00';
        memattrs.shareable = (S == '1');
    when '00110'
        IMPLEMENTATION_DEFINED setting of memattrs;
    when '00111' // Outer and Inner Write-Back, Write-Allocate
        memattrs.type = MemType_Normal;
        memattrs.innerattrs = '11';
        memattrs.innerhints = '11';
        memattrs.outerattrs = '11';
        memattrs.outerhints = '11';
        memattrs.shareable = (S == '1');
    when '01000' // Non-shareable Device
        memattrs.type = MemType_Device;
        memattrs.innerattrs = bits(2) UNKNOWN;
        memattrs.innerhints = bits(2) UNKNOWN;
        memattrs.outerattrs = bits(2) UNKNOWN;
        memattrs.outerhints = bits(2) UNKNOWN;
        memattrs.shareable = TRUE;
    when "1xxx" // Cacheable, <3:2> = Outer attrs, <1:0> = Inner attrs
        memattrs.type = MemType_Normal;
        hintsattrs = ConvertAttrsHints(texcb<1:0>);
        memattrs.innerattrs = hintsattrs<1:0>;
        memattrs.innerhints = hintsattrs<3:2>;
        hintsattrs = ConvertAttrsHints(texcb<3:2>);
        memattrs.outerattrs = hintsattrs<1:0>;
        memattrs.outerhints = hintsattrs<3:2>;

    otherwise
        UNPREDICTABLE;

    memattrs.outershareable = memattrs.shareable;

    return memattrs;
```

## B2.4.10 Data Abort exception

The DataAbort() function generates a Data Abort exception, and is used by both the VMSA and PMSA architectures to set the fault-reporting registers to indicate:

- the type of the abort, including the distinction between section and page on a VMSA implementation
- on a VMSA implementation that is using the Short-descriptor translation table format, the domain, if appropriate
- whether the access was a read or write.

For a synchronous abort it also sets the DFAR to the MVA of the abort.

For details of the fault encoding values see:

- for a VMSA implementation:
  - [PL1 fault reporting with the Short-descriptor translation table format](#) on page B3-1414
  - [Fault reporting with the Long-descriptor translation table format](#) on page B3-1416
- for a PMSA implementation, [Fault Status Register encodings for the PMSA](#) on page B5-1769.

An implementation might also set any IMPLEMENTATION DEFINED auxiliary fault reporting registers.

// Data Abort types.

```
enumeration DAbort {DAabort_AccessFlag,
                    DAbort_Alignment,
                    DAbort_Background,
                    DAbort_Domain,
                    DAbort_Permission,
                    DAbort_Translation,
```



```
DAbort_SyncExternal,  
DAbort_SyncExternalonWalk,  
DAbort_SyncParity,  
DAbort_SyncParityonWalk,  
DAbort_AsyncParity,  
DAbort_AsyncExternal,  
DAbort_DebugEvent,  
DAbort_TLBConflict,  
DAbort_Lockdown,  
DAbort_Coproc,  
DAbort_ICacheMaint};
```

```

// DataAbort()
// =====

DataAbort(bits(32) vaddress, bits(40) ipaddress, bits(4) domain, integer level, boolean iswrite,
          DAbort type, boolean taketohypmode, boolean secondstageabort, boolean ipavalid,
          boolean LDFSRformat, boolean s2fs1walk)
// Data Abort handling for Memory Management generated aborts

if MemorySystemArchitecture() == MemArch_VMSA then
  if !taketohypmode then
    DFSR = bits(32) UNKNOWN;
    DFAR = bits(32) UNKNOWN;
    if !(type IN {DAbort_AsyncParity, DAbort_AsyncExternal, DAbort_DebugEvent}) then
      DFAR = vaddress;
    elseif type == DAbort_DebugEvent then // Watchpoint
      // DFAR is updated only for synchronous watchpoints in v7.1 Debug. Otherwise
      // it is explicitly UNKNOWN.
      DFAR = IMPLEMENTATION_DEFINED bits(32) UNKNOWN or vaddress;
    if LDFSRformat then
      // new format
      DFSR<13> = TLBLookupCameFromCacheMaintenance();
      if type IN {DAbort_AsyncExternal, DAbort_SyncExternal} then
        DFSR<12> = IMPLEMENTATION_DEFINED;
      else
        DFSR<12> = '0';
        DFSR<11> = if iswrite then '1' else '0';
        DFSR<10> = bit UNKNOWN;
        DFSR<9> = '1';
        DFSR<8:6> = bits(3) UNKNOWN;
        DFSR<5:0> = EncodeLDFSR(type, level);
      else
        DFSR<13> = TLBLookupCameFromCacheMaintenance();
        if type IN {DAbort_AsyncExternal, DAbort_SyncExternal} then
          DFSR<12> = IMPLEMENTATION_DEFINED;
        else
          DFSR<12> = '0';
          DFSR<11> = if iswrite then '1' else '0';
          DFSR<9> = '0';
          DFSR<8> = bit UNKNOWN;
          domain_valid = ((type == DAbort_Domain) ||
                        ((level == 2) &&
                         (type IN {DAbort_Translation, DAbort_AccessFlag,
                                   DAbort_SyncExternalonWalk, DAbort_SyncParityonWalk})) ||
                        (!HaveLPAE() && (type == DAbort_Permission)));

          if domain_valid then
            DFSR<7:4> = domain;
          else
            DFSR<7:4> = bits(4) UNKNOWN;
            DFSR<10,3:0> = EncodeSDFSR(type, level);
        else
          bits(25) HSRString = Zeros(25);
          bits(6) ec;
          HDFAR = vaddress;
          if ipavalid then
            HPFAR<31:4> = ipaddress<39:12>;
          if secondstageabort then
            ec = '100100';
            HSRString<24:16> = LSInstructionSyndrome();
          else
            ec = '100101';
            HSRString<24> = '0'; // Instruction syndrome not valid
          if type IN {DAbort_AsyncExternal, DAbort_SyncExternal} then
            HSRString<9> = IMPLEMENTATION_DEFINED;
          else
            HSRString<9> = '0';
          HSRString<8> = TLBLookupCameFromCacheMaintenance();
          HSRString<7> = if s2fs1walk then '1' else '0';

```

```

    HSRString<6> = if iswrite then '1' else '0';
    HSRString<5:0> = EncodeLDFSR(type, level);
    WriteHSR(ec, HSRString);
else
    // PMSA
    DFAR = bits(32) UNKNOWN;
    DFAR = bits(32) UNKNOWN;
    if !(type IN {DAbort_AsyncParity,DAbort_AsyncExternal,
                DAbort_DebugEvent,DAbort_SyncParity}) then
        DFAR = vaddress;
    elsif type == DAbort_SyncParity then
        DFAR = IMPLEMENTATION_DEFINED;
    elsif type == DAbort_DebugEvent then // Watchpoint
        DFAR = IMPLEMENTATION_DEFINED bits(32) UNKNOWN or vaddress;

    if type IN {DAbort_AsyncExternal,DAbort_SyncExternal} then
        DFSR<12> = IMPLEMENTATION_DEFINED;
    else
        DFSR<12> = '0';

    DFSR<11> = if iswrite then '1' else '0';
    DFSR<10,3:0> = EncodePMSAFSR(type);

    TakeDataAbortException();

    return;

```

For a VMSA implementation, the EncodeSDFSR() pseudocode function returns the required fault code for a fault status register that is reporting a Data Abort when using the Short-descriptor translation table format:

```

// EncodeSDFSR()
// =====
// Function that gives the Short-descriptor FSR code for
// different types of Data Abort

```

bits(5) EncodeSDFSR(DAbort type, integer level)

```

bits(5) result;

case type of
  when DAbort_AccessFlag
    if level == 1 then
      result<4:0> = '00011';
    else
      result<4:0> = '00110';
  when DAbort_Alignment
    result<4:0> = '00001';
  when DAbort_Permission
    result<4:2> = '011';
    result<0> = '1';
    result<1> = level<1>;
  when DAbort_Domain
    result<4:2> = '010';
    result<0> = '1';
    result<1> = level<1>;
  when DAbort_Translation
    result<4:2> = '001';
    result<0> = '1';
    result<1> = level<1>;
  when DAbort_SyncExternal
    result<4:0> = '01000';
  when DAbort_SyncExternalonWalk
    result<4:2> = '011';
    result<0> = '0';
    result<1> = level<1>;
  when DAbort_SyncParity
    result<4:0> = '11001';
  when DAbort_SyncParityonWalk

```

```
        result<4:2> = '111';  
        result<0> = '0';  
        result<1> = level<1>;  
    when DAbort_AsyncParity  
        result<4:0> = '11000';  
    when DAbort_AsyncExternal  
        result<4:0> = '10110';  
    when DAbort_DebugEvent  
        result<4:0> = '00010';  
    when DAbort_TLBConflict  
        result<4:0> = '10000';  
    when DAbort_Lockdown  
        result<4:0> = '10100';  
    when DAbort_Coproc  
        result<4:0> = '11010';  
    when DAbort_ICacheMaint  
        result<4:0> = '00100';  
    otherwise  
        result<4:0> = bits(5) UNKNOWN;
```

```
    return result;
```

For a VMVA implementation, the EncodeLDFSR() pseudocode function returns the required fault code for a fault status register that is reporting a Data Abort when using the Long-descriptor translation table format:

```
// EncodeLDFSR()  
// =====  
// Function that gives the Long-descriptor FSR code for  
// different types of Data Abort
```

```
bits(6) EncodeLDFSR(DAbort type, integer level)
```

```
    bits(6) result;  
  
    case type of  
        when DAbort_AccessFlag  
            result<5:2> = '0010';  
            result<1:0> = level<1:0>;  
        when DAbort_Alignment  
            result<5:0> = '100001';  
        when DAbort_Permission  
            result<5:2> = '0011';  
            result<1:0> = level<1:0>;  
        when DAbort_Translation  
            result<5:2> = '0001';  
            result<1:0> = level<1:0>;  
        when DAbort_SyncExternal  
            result<5:0> = '010000';  
        when DAbort_SyncExternalonWalk  
            result<5:2> = '0101';  
            result<1:0> = level<1:0>;  
        when DAbort_SyncParity  
            result<5:0> = '011000';  
        when DAbort_SyncParityonWalk  
            result<5:2> = '0111';  
            result<1:0> = level<1:0>;  
        when DAbort_AsyncParity  
            result<5:0> = '011001';  
        when DAbort_AsyncExternal  
            result<5:0> = '010001';  
        when DAbort_DebugEvent  
            result<5:0> = '100010';  
        when DAbort_TLBConflict  
            result<5:0> = '110000';  
        when DAbort_Lockdown  
            result<5:0> = '110100';  
        when DAbort_Coproc  
            result<5:0> = '111010';
```

```
        otherwise
            result<5:0> = bits(6) UNKNOWN;

    return result;
```

For a PMSA implementation, the EncodePMSAFSR() pseudocode function returns the required fault code for a fault status register that is reporting a Data Abort:

```
// EncodePMSAFSR()
// =====
// Function that gives the PMSA FSR code for
// different types of Data Abort
```

```
bits(5) EncodePMSAFSR(DAbort type)
```

```
    bits(5) result;

    case type of
        when DAbort_Alignment
            result<4:0> = '00001';
        when DAbort_Permission
            result<4:0> = '01101';
        when DAbort_SyncExternal
            result<4:0> = '01000';
        when DAbort_SyncParity
            result<4:0> = '11001';
        when DAbort_AsyncParity
            result<4:0> = '11000';
        when DAbort_AsyncExternal
            result<4:0> = '10110';
        when DAbort_DebugEvent
            result<4:0> = '00010';
        when DAbort_Background
            result<4:0> = '00000';
        when DAbort_Lockdown
            result<4:0> = '10100';
        when DAbort_Coproc
            result<4:0> = '11010';
        otherwise
            result<4:0> = bits(5) UNKNOWN;

    return result;
```



# Chapter B3

## Virtual Memory System Architecture (VMSA)

This chapter provides a system level view of the Virtual Memory System Architecture (VMSA), the memory system architecture of an ARMv7-A implementation. It contains the following sections:

- *About the VMSA* on page B3-1308
- *The effects of disabling MMUs on VMSA behavior* on page B3-1314
- *Translation tables* on page B3-1318
- *Secure and Non-secure address spaces* on page B3-1323
- *Short-descriptor translation table format* on page B3-1324
- *Long-descriptor translation table format* on page B3-1338
- *Memory access control* on page B3-1356
- *Memory region attributes* on page B3-1366
- *Translation Lookaside Buffers (TLBs)* on page B3-1378
- *TLB maintenance requirements* on page B3-1381
- *Caches in a VMSA implementation* on page B3-1392
- *VMSA memory aborts* on page B3-1395
- *Exception reporting in a VMSA implementation* on page B3-1409
- *Virtual Address to Physical Address translation operations* on page B3-1438
- *About the system control registers for VMSA* on page B3-1444
- *Organization of the CP14 registers in a VMSA implementation* on page B3-1468
- *Organization of the CP15 registers in a VMSA implementation* on page B3-1469
- *Functional grouping of VMSAv7 system control registers* on page B3-1491
- *Pseudocode details of VMSA memory system operations* on page B3-1503.

---

**Note**

For an ARMv7-A implementation, this chapter must be read with [Chapter B2 Common Memory System Architecture Features](#).

---

## B3.1 About the VMSA

---

### Note

---

- This chapter describes the ARMv7 VMSA, including the Security Extensions, the Multiprocessing Extensions, the *Large Physical Address Extension* (LPAE), and the Virtualization Extensions. This is referred to as the Extended VMSAv7. This chapter also describes the differences in VMSAv7 implementations that do not include some or all of these extensions.
- For details of the VMSA differences in previous versions of the ARM architecture see:
  - [VMSA support on page AppxL-2519](#) for ARMv6
  - [Virtual memory support on page AppxO-2604](#) for the ARMv4 and ARMv5 architectures.

---

In VMSAv7, a *Memory Management Unit* (MMU) controls address translation, access permissions, and memory attribute determination and checking, for memory accesses made by the processor. The MMU is controlled by system control registers, that can also disable the MMU. This chapter includes a definition the behavior of the memory system when the MMU is disabled.

The Extended VMSAv7 provides multiple stages of memory system control, as follows:

- for operation in Secure state, a single stage of memory system control
- for operation in Non-secure state, up to two stages of memory system control:
  - when executing at PL2, a single stage of memory system control
  - when executing at PL1 or PL0, two stages of memory system control.

Each supported stage of memory system control is provided by an MMU, with its own independent set of controls. Therefore, the Extended VMSAv7 provides the following MMUs:

- Secure PL1&0 stage 1 MMU
- Non-secure PL2 stage 1 MMU
- Non-secure PL1&0 stage 1 MMU
- Non-secure PL1&0 stage 2 MMU.

---

### Note

---

The model of having a separate MMU for each stage of memory control is an architectural abstraction. It does not indicate any specific hardware requirements for an Extended VMSAv7 processor implementation. The architecture requires only that the behavior of any VMSAv7 processor matches the behavior described in this manual.

---

These features mean the Extended VMSAv7 can support a hierarchy of software supervision, for example an Operating System and a hypervisor.

Each MMU uses a set of address translations and associated memory properties held in memory mapped tables called *translation tables*.

If an implementation does not include the Security Extensions, it has only a single security state, with a single MMU with controls equivalent to the Secure state MMU controls.

If an implementation does not include the Virtualization Extensions then:

- it does not support execution at PL2
- it Non-secure state, it provides only the Non-secure PL1&0 stage 1 MMU.

For an MMU, the translation tables define the following properties:

#### Access to the Secure or Non-secure address map

If an implementation includes the Security Extensions, the translation table entries determine whether an access from Secure state accesses the Secure or the Non-secure address map. Any access from Non-secure state accesses the Non-secure address map.



### Memory access permission control

This controls whether a program is permitted to access a memory region. For instruction and data access, the possible settings are:

- no access
- read-only
- write-only
- read/write.

For instruction accesses, additional controls determine whether instructions can be fetched and executed from the memory region.

If a processor attempts an access that is not permitted, a memory fault is signaled to the processor.

### Memory region attributes

These describe the properties of a memory region. The top-level attribute, the Memory type, is one of Strongly-ordered, Device, or Normal. Device and Normal memory regions can have additional attributes, see [Summary of ARMv7 memory attributes on page A3-126](#).

### Address translation mappings

An address translation maps an *input address* to an *output address*.

A stage 1 translation takes the address of an explicit data access or instruction fetch, a *virtual address* (VA), as the input address, and translates it to a different output address:

- if only one stage of translation is provided, this output address is the *physical address* (PA)
- if two stages of address translation are provided, the output address of the stage 1 translation is an *intermediate physical address* (IPA).

———— **Note** ————

In the ARMv7 architecture, a software agent, such as an Operating System, that uses or defines stage 1 memory translations, might be unaware of the distinction between IPA and PA.

A stage 2 translation translates the IPA to a PA.

The possible security states and privilege levels of memory accesses define a set of *translation regimes*. [Figure B3-1](#) shows the VMSA translation regimes, and their associated translation stages and MMUs.

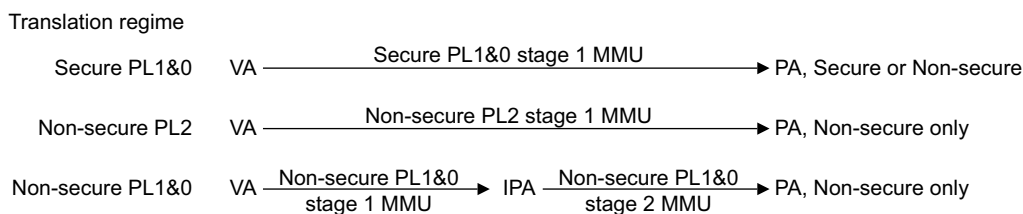

**Figure B3-1 VMSA translation regimes, and associated MMUs**

———— **Note** ————

Conceptually, a translation regime that has only a stage 1 MMU is equivalent to a regime with a fixed, flat stage 2 mapping from IPA to PA.

System Control coprocessor (CP15) registers control the VMSA, including defining the location of the translation tables, and enabling and configuring the MMUs. Also, they report any faults that occur on a memory access. For more information, see [Functional grouping of VMSAv7 system control registers on page B3-1491](#).

The following sections give an overview of the VMSA, and of the implementation options for VMSAv7:

- [Address types used in a VMSA description on page B3-1310](#)
- [Address spaces in a VMSA implementation on page B3-1311](#)
- [About address translation on page B3-1311](#).

The remainder of the chapter fully describes the VMSA, including the different implementation options, as summarized in [Organization of this chapter on page B3-1313](#).

### B3.1.1 Address types used in a VMSA description

A description of VMSAv7 refers to the following address types.

———— **Note** ————

These descriptions relate to a VMSAv7 description and therefore sometimes differ from the generic definitions given in the Glossary.

---

#### Virtual Address (VA)

An address used in an instruction, as a data or instruction address, is a Virtual Address (VA).

An address held in the PC, LR, or SP, is a VA.

The VA map runs from zero to the size of the VA space. For ARMv7, the maximum VA space is 4GB, giving a maximum VA range of 0x00000000-0xFFFFFFFF.

#### Modified Virtual Address (MVA)

On an implementation that implements and uses the FCSE, the FCSE takes a VA and transforms it to an MVA. This is a preliminary address translation, performed before the address translation described in this chapter.

Otherwise, MVA is a synonym for VA.

———— **Note** ————

[Appendix J Fast Context Switch Extension \(FCSE\)](#) describes the FCSE. From ARMv6, ARM deprecates any use of the FCSE. The FCSE is:

- OPTIONAL and deprecated in an ARMv7 implementation that does not include the Multiprocessing Extensions.
- Obsolete from the introduction of the Multiprocessing Extensions.

---

#### Intermediate Physical Address (IPA)

In a translation regime that provides two stages of address translation, the IPA is the address after the stage 1 translation, and is the input address for the stage 2 translation.

In a translation regime that provides only one stage of address translation, the IPA is identical to the PA.

In ARM VMSA implementations, only one stage of address translation is provided:

- if the implementation does not include the Virtualization Extensions
- when executing in Secure state
- when executing in Hyp mode.

#### Physical Address (PA)

The address of a location in the Secure or Non-secure memory map. That is, an output address from the processor to the memory system.

## B3.1.2 Address spaces in a VMSA implementation

The ARMv7 architecture supports:

- A VA address space of up to 32 bits. The actual width is IMPLEMENTATION DEFINED.
- An IPA address space of up to 40 bits. The translation tables and associated system control registers define the width of the implemented address space.

### ————— **Note** —————

The Large Physical Address Extension defines two translation table formats. The *Long-descriptor* format gives access to the full 40-bit IPA or PA address space at a granularity of 4KB. The *Short-descriptor* format:

- Gives access to a 32-bit PA address space at 4KB granularity.
- Optionally, gives access to a 40-bit PA address space, but only at 16MB granularity.

If an implementation includes the Security Extensions, the address maps are defined independently for Secure and Non-secure operation, providing two independent 40-bit address spaces, where:

- a VA accessed from Non-secure state can only be translated to the Non-secure address map
- a VA accessed from Secure state can be translated to either the Secure or the Non-secure address map.

## B3.1.3 About address translation

Address translation is the process of mapping one address type to another, for example, mapping VAs to IPAs, or mapping VAs to PAs. A *translation table* defines the mapping from one address type to another, and a *Translation table base register* indicates the start of a translation table. Each implemented MMU shown in *VMSA translation regimes, and associated MMUs on page B3-1309* requires its own set of translation tables.

For PL1&0 stage 1 translations, the mapping can be split between two tables, one controlling the lower part of the VA space, and the other controlling the upper part of the VA space. This can be used, for example, so that:

- one table defines the mapping for operating system and I/O addresses, that do not change on a context switch
- a second table defines the mapping for application-specific addresses, and therefore might require updating on a context switch.

The VMSAv7 implementation options determine the supported MMUs, and therefore the supported address translations:

### **VMSAv7 without the Security Extensions**

Supports only a single PL1&0 stage 1 MMU. Operation of this MMU can be split between two sets of translation tables, defined by [TTBR0](#) and [TTBR1](#), and controlled by [TTBCR](#).

### **VMSAv7 with the Security Extensions but without the Virtualization Extensions**

Supports only the Secure PL1&0 stage 1 MMU and the Non-secure PL1&0 stage 1 MMU. Operation of each of these MMUs can be split between two sets of translation tables, defined by the Secure and Non-secure copies of [TTBR0](#) and [TTBR1](#), and controlled by the Secure and Non-secure copies of [TTBCR](#).

### **VMSAv7 with Virtualization Extensions**

The implementation supports all of the MMUs, as follows:

#### **Secure PL1&0 stage 1 MMU**

Operation of this MMU can be split between two sets of translation tables, defined by the Secure copies of [TTBR0](#) and [TTBR1](#), and controlled by the Secure copy of [TTBCR](#).

#### **Non-secure PL2 stage 1 MMU**

The [HTTBR](#) defines the translation table for this MMU, controlled by [HTCR](#).

**Non-secure PL1&0 stage 1 MMU**

Operation of this MMU can be split between two sets of translation tables, defined by the Non-secure copies of **TTBR0** and **TTBR1** and controlled by the Non-secure copy of **TTBCR**.

**Non-secure PL1&0 stage 2 control**

The **VTTBR** defines the translation table for this MMU, controlled by **VTCR**.

**Figure B3-2** shows the possible memory translations in a VMSAv7 implementation that includes the Virtualization Extensions, and indicates the required privilege level to define each set of translation tables:

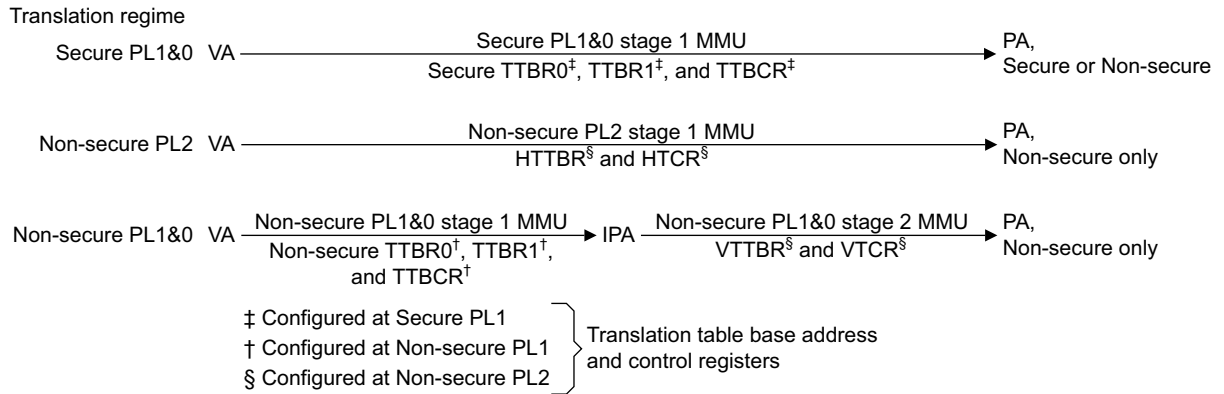

**Figure B3-2 Memory translation summary, with Virtualization Extensions**

In general:

- the translation from VA to PA can require multiple *stages* of address translation, as **Figure B3-2** shows
- a single stage of address translation takes an *input address* and translates it to an *output address*.

A full translation table lookup is called a *translation table walk*. It is performed automatically by hardware, and can have a significant cost in execution time. To support fine granularity of the VA to PA mapping, a single input address to output address translation can require multiple accesses to the translation tables, with each access giving finer granularity. Each access is described as a *level* of address lookup. The final level of the lookup defines:

- the required output address
- the *attributes* and *access permissions* of the addressed memory.

*Translation Lookaside Buffers* (TLBs) reduce the average cost of a memory access by caching the results of translation table walks. TLBs behave as caches of the translation table information, and the VMSA provides TLB maintenance operations for the management of TLB contents.

**Note**

The ARM architecture permits TLBs to hold any translation table entry that does not directly cause a Translation fault or an Access flag fault.

To reduce the software overhead of TLB maintenance, the VMSA distinguishes between *Global pages* and *Process-specific pages*. The *Address Space Identifier* (ASID) identifies pages associated with a specific process and provides a mechanism for changing process-specific tables without having to maintain the TLB structures.

If an implementation includes the Virtualization Extensions, the *virtual machine identifier* (VMID) identifies the current virtual machine, with its own independent ASID space. The TLB entries include this VMID information, meaning TLBs do not require explicit invalidation when changing from one virtual machine to another, if the virtual machines have different VMIDs. For stage 2 translations, all translations are associated with the current VMID, and there is no concept of global entries.

## B3.1.4 Organization of this chapter

The remainder of this chapter is organized as follows.

The first part of the chapter describes address translation and the associated memory properties held in the translation table entries, in the following sections:

- *The effects of disabling MMUs on VMSA behavior* on page B3-1314
- *Translation tables* on page B3-1318
- *Secure and Non-secure address spaces* on page B3-1323
- *Short-descriptor translation table format* on page B3-1324
- *Long-descriptor translation table format* on page B3-1338
- *Memory access control* on page B3-1356
- *Memory region attributes* on page B3-1366
- *Translation Lookaside Buffers (TLBs)* on page B3-1378
- *TLB maintenance requirements* on page B3-1381.

*Caches in a VMSA implementation* on page B3-1392 describes VMSA-specific cache requirements.

The following sections describe aborts on VMSA memory accesses, and how these and other faults are reported in a VMSA implementation:

- *VMSA memory aborts* on page B3-1395
- *Exception reporting in a VMSA implementation* on page B3-1409.

*Virtual Address to Physical Address translation operations* on page B3-1438 describes these operations, and how they relate to address translation.

A number of sections then describe the control registers in a VMSA implementation. The following sections give general information about the control registers, and the organization of the registers in the two coprocessors, CP14 and CP15, that provide the interface to these registers:

- *About the system control registers for VMSA* on page B3-1444
- *Organization of the CP14 registers in a VMSA implementation* on page B3-1468
- *Organization of the CP15 registers in a VMSA implementation* on page B3-1469
- *Functional grouping of VMSAv7 system control registers* on page B3-1491.

The following sections then describe each of the functional groups of CP15 registers, including a full description of each register in the group:

- *Identification registers, functional group* on page B3-1492
- *Virtual memory control registers, functional group* on page B3-1493
- *PL1 Fault handling registers, functional group* on page B3-1494
- *Other system control registers, functional group* on page B3-1494
- *Lockdown, DMA, and TCM features, functional group, VMSA* on page B3-1495
- *Cache maintenance operations, functional group, VMSA* on page B3-1496
- *TLB maintenance operations, functional group* on page B3-1497
- *Address translation operations, functional group* on page B3-1498
- *Miscellaneous operations, functional group* on page B3-1499
- *Performance Monitors, functional group* on page B3-1500
- *Security Extensions registers, functional group* on page B3-1500
- *Virtualization Extensions registers, functional group* on page B3-1501
- *IMPLEMENTATION DEFINED registers, functional group* on page B3-1502.

*Pseudocode details of VMSA memory system operations* on page B3-1503 then describes many feature of VMSA operation.

## B3.2 The effects of disabling MMUs on VMSA behavior

[About the VMSA on page B3-1308](#) defines the translation regimes and the associated MMUs. The VMSA includes an enable bit for each MMU, as follows:

- **SCTLR.M**, in the Secure copy of the register, controls Secure PL1&0 stage 1 MMU
- **SCTLR.M**, in the Non-secure copy of the register, controls Non-secure PL1&0 stage 1 MMU
- **HCR.VM** controls Non-secure PL1&0 stage 2 MMU
- **HSCTLR.M** controls Non-secure PL2 stage 1 MMU.

The following sections describe the effect on VMSAv7 behavior of disabling each stage of translation:

- [VMSA behavior when a stage 1 MMU is disabled](#)
- [VMSA behavior when the stage 2 MMU is disabled on page B3-1316](#)
- [Behavior of instruction fetches when all associated MMUs are disabled on page B3-1316.](#)

[Enabling MMUs on page B3-1316](#) gives information about enabling MMUs, in particular after a reset on an implementation that includes the Security Extensions.

### B3.2.1 VMSA behavior when a stage 1 MMU is disabled

When a stage 1 MMU is disabled, memory accesses that would otherwise be translated by that MMU are treated as follows:

#### Non-secure PL1 and PL0 accesses when **HCR.DC** is set to 1, Virtualization Extensions

In an implementation that includes the Virtualization Extensions, for an access from a Non-secure PL1 or PL0 mode when **HCR.DC** is set to 1, the stage 1 translation assigns the Normal Non-shareable, Inner Write-Back Write-Allocate, Outer Write-Back Write-Allocate memory attributes.

#### All other accesses

For all other accesses, when a stage 1 MMU is disabled, the assigned attributes depend on whether the access is a data access or an instruction access, as follows:

##### Data access

The stage 1 translation assigns the Strongly-Ordered memory type.

##### Note

This means the access is Non-cacheable. Unexpected data cache hit behavior is IMPLEMENTATION DEFINED.

##### Instruction access

The stage 1 translation assigns Normal memory attribute, with the cacheability and shareability attributes determined by the value of:

- the Secure copy of **SCTLR.I** for the Secure PL1&0 translation regime
- the Non-secure copy of **SCTLR.I** for the Non-secure PL1&0 translation regime
- **HSCTLR.I** for the Non-secure PL2 translation regime.

In these cases, the meaning of the I bit is as follows:

##### When I is set to 0

The stage 1 translation assigns the Non-cacheable attribute. If the implementation includes the Large Physical Address Extension, the Outer Shareable attribute is assigned, otherwise the shareability attribute is IMPLEMENTATION DEFINED.

##### When I is set to 1

The stage 1 translation assigns the Cacheable, Inner Write-Through no Write-Allocate, Outer Write-Through no Write-Allocate attribute.

---

**Note**

- An implementation that includes the Virtualization Extensions must include the Large Physical Address Extension, and therefore if the stage 1 MMU is disabled and `HSCTLR.I` is set to 0, the Outer Shareable attribute is assigned.
- On some implementations, if the `SCTLR.TRE` bit is set to 0 then this behavior can be changed by the remap settings in the memory remap registers, see [VMSA CP15 c10 register summary, memory remapping and TLB control registers on page B3-1478](#). The details of TEX remap when `SCTLR.TRE` is set to 0 are IMPLEMENTATION DEFINED, see [SCTLR.TRE, SCTLR.M, and the effect of the TEX remap registers on page B3-1371](#).

---

These rules apply in the following cases:

- the implementation does not include the Virtualization Extensions
- the implementation includes the Virtualization Extensions and any of the following applies:
  - the access is from Secure state
  - the access is from Hyp mode
  - the access is from a Non-secure PL1 or PL0 mode and `HCR.DC` is set to 0.

For this stage of translation, no memory access permission checks are performed, and therefore no MMU faults relating to this stage of translation can be generated.

---

**Note**

Alignment checking is performed, and therefore Alignment faults can occur.

---

For every access, the output address of the stage 1 translation is equal to the input address. This is called a flat address mapping. If the implementation supports output addresses of more than 32 bits then the output address bits above bit[31] are zero. For example, for a VA to PA translation on an implementation that supports 40-bit PAs, PA[39:32] is 0x00.

For a Non-secure PL1 or PL0 access, if the PL1&0 stage 2 MMU is enabled, the stage 1 memory attribute assignments and output address can be modified by the stage 2 translation.

The effect of executing in a Non-secure PL1 or PL0 mode with `HCR.DC` set to 1 is UNPREDICTABLE if one or more of the following applies:

- the Non-secure `SCTLR.M` bit is set to 1, enabling the Non-secure PL1&0 stage 1 MMU
- the `HCR.VM` bit is set to 0, disabling the Non-secure PL1&0 stage 2 MMU.

The effect of `HCR.DC` might be held in TLB entries associated with a particular VMID. Therefore, if software executing at PL2 changes the `HCR.DC` value without also changing the current VMID, it must also invalidate all TLB entries associated with the current VMID. Otherwise, the behavior of Non-secure software executing at PL1 or PL0 is UNPREDICTABLE.

See also [Behavior of instruction fetches when all associated MMUs are disabled on page B3-1316](#).

## Effect of disabling the MMU on maintenance and address translation operations

CP15 cache maintenance operations act on the target cache whether the MMU is enabled or not, and regardless of the values of the memory attributes. However, if the MMU is disabled, they use the flat address mapping, and all mappings are considered global.

CP15 TLB invalidate operations act on the target TLB whether the MMU is enabled or not.

When the Non-secure PL1&0 stage 1 MMU is disabled, any AT51C\*\* or AT512NSO\*\* address translation operation that accesses the Non-secure state translation reflects the effect of the `HCR.DC` bit. For more information about these operations see [Virtual Address to Physical Address translation operations on page B3-1438](#).



### B3.2.2 VMSA behavior when the stage 2 MMU is disabled

When the stage 2 MMU is disabled:

- the IPA output from the stage 1 translation maps flat to the PA
- the memory attributes and permissions from the stage 1 translation apply to the PA.

If the stage 1 MMU and the stage 2 MMU are both disabled, see [Behavior of instruction fetches when all associated MMUs are disabled](#).

### B3.2.3 Behavior of instruction fetches when all associated MMUs are disabled

The information in this section applies to memory accesses:

- from Secure PL1 and PL0 modes, when the Secure PL1&0 stage 1 MMU is disabled
- from the Non-secure PL2 mode, when the Non-secure PL2 stage 1 MMU is disabled
- from Non-secure PL1 and PL0 modes, when all of the following apply:
  - the Non-secure PL1&0 stage 1 MMU is disabled
  - the Non-secure PL1&0 stage 2 MMU is disabled
  - [HCR.DC](#) is set to 0.

In these cases, a memory location might be accessed as a result of an instruction fetch if one of the following conditions is met:

- The memory location is in the same 4KB block of memory (aligned to 4KB) as an instruction that a simple sequential execution of the program requires to be fetched, or is in the 4KB block of memory immediately following such a block.
- The memory location is in the same 4KB block of memory (aligned to 4KB) from which a simple sequential execution of the program with all associated MMUs disabled has previously required an instruction to be fetched, or is in the 4KB block immediately following such a block.

These accesses can be caused by speculative instruction fetches, regardless of whether the prefetched instruction is committed for execution.

#### ———— **Note** —————

To ensure architectural compliance, software must ensure that both of the following apply:

- instructions that will be executed when an MMU is disabled are located in 4KB blocks of the address space that contain only memory that is tolerant to speculative accesses
- each 4KB block of the address space that immediately follows a 4KB block that holds instructions that will be executed when an MMU is disabled also contains only memory which is tolerant to speculative accesses.

### B3.2.4 Enabling MMUs

An implementation that does not include the Security Extensions has a single MMU, controlled by [SCTLR.M](#). On startup or reset, [SCTLR.M](#) bit resets to 0, meaning the MMU is disabled.

In an implementation that includes the Security Extensions:

- The PL1&0 stage 1 MMU enable bit, [SCTLR.M](#), is Banked, meaning there are separate enables for operation in Secure and Non-secure state
- On startup or reset, only the Secure copy of the [SCTLR.M](#) bit resets to 0, disabling the Secure state PL1&0 stage 1 MMU. The reset value of the Non-secure copy of [SCTLR.M](#) is UNKNOWN.

In an implementation that includes the Virtualization Extensions, on startup or reset, the [HSCTLR.M](#) bit, that controls the Non-secure PL2 stage 1 MMU, is UNKNOWN.



———— **Note** —————

If the PA of the software that enables or disables an MMU differs from its VA, speculative instruction fetching can cause complications. ARM strongly recommends that the PA and VA of any software that enables or disables an MMU are identical if that MMU controls address translations that apply to the software currently being executed.

---

## B3.3 Translation tables

VMSAv7 defines two alternative translation table formats:

### Short-descriptor format

This is the original format defined in issue A of this Architecture Reference Manual, and is the only format supported on implementations that do not include the Large Physical Address Extension. It uses 32-bit descriptor entries in the translation tables, and provides:

- Up to two levels of address lookup.
- 32-bit input addresses.
- Output addresses of up to 40 bits.
- Support for PAs of more than 32 bits by use of supersections, with 16MB granularity.
- Support for No access, Client, and Manager domains.
- 32-bit table entries.

### Long-descriptor format

The Large Physical Address Extension adds support for this format. It uses 64-bit descriptor entries in the translation tables, and provides:

- Up to three levels of address lookup.
- Input addresses of up to 40 bits, when used for stage 2 translations.
- Output addresses of up to 40 bits.
- 4KB assignment granularity across the entire PA range.
- No support for domains, all memory regions are treated as in a Client domain.
- 64-bit table entries.
- Fixed 4KB table size, unless truncated by the size of the input address space.

————— **Note** —————

Translation with a 40-bit input address range requires two concatenated 4KB top-level tables, aligned to 8KB.

—————

The Large Physical Address Extension is an OPTIONAL extension, but an implementation that includes the Virtualization Extensions must also include the Large Physical Address Extension.

In an implementation that includes the Large Physical Address Extension, but not the Virtualization Extensions, the [TTBCR.EAE](#) bit indicates the current translation table format.

In an implementation that includes the Virtualization Extensions, of the possible address translations shown in [Figure B3-2 on page B3-1312](#):

- the translation tables for the Secure PL1&0 stage 1 translations, and for the Non-secure PL1&0 stage 1 translations, can use either translation table format, and the [TTBCR.EAE](#) bit indicates the current translation table format
- the translation tables for the Non-secure PL2 stage 1 translations, and for the Non-secure PL1&0 stage 2 translations, must use the Long-descriptor translation table format.

Many aspects of performing a translation table walk depend on the current translation table format. Therefore, the following sections describe the two formats, including how the MMU performs a translation table walk for each format:

- [Short-descriptor translation table format on page B3-1324](#)
- [Long-descriptor translation table format on page B3-1338](#).

The following subsections describe aspects of the translation tables and translation table walks that are independent of the translation table format:

- [Translation table walks on page B3-1319](#)
- [Information returned by a translation table lookup on page B3-1320](#)
- [Determining the translation table base address on page B3-1320](#)

- [Security Extensions control of translation table walks on page B3-1321](#)
- [Access to the Secure or Non-secure physical address map on page B3-1321.](#)

See also [TLB maintenance requirements on page B3-1381](#).

### B3.3.1 Translation table walks

A translation table walk occurs as the result of a TLB miss, and starts with a read of the appropriate starting-level translation table. The result of that read determines whether additional translation table reads are required, for this stage of translation, as described in either:

- [Translation table walks, when using the Short-descriptor translation table format on page B3-1331](#)
- [Translation table walks, when using the Long-descriptor translation table format on page B3-1350.](#)

#### ———— Note —————

When using the Short-descriptor translation table format, the starting level for a translation table walk is always a first-level lookup. However, with the Long-descriptor translation table format, the starting-level can be either a first-level or a second-level lookup.

For the PL1&0 stage 1 translations, [SCTLR.EE](#) determines the endianness of the translation table lookups. In an implementation that includes the Security Extensions, [SCTLR](#) is Banked, and therefore the endianness is determined independently for the Secure and Non-secure PL1&0 stage 1 translations.

If an implementation includes the Virtualization Extensions, [HSCTLR.EE](#) defines the endianness for the Non-secure PL2 stage 1 and Non-secure PL1&0 stage 2 translations.

#### ———— Note —————

##### **Dynamically changing translation table endianness**

Because any change to [SCTLR.EE](#) or [HSCTLR.EE](#) requires synchronization before it is visible to subsequent operations, ARM strongly recommends that:

- [SCTLR.EE](#) is changed only when either:
  - executing in a mode that does not use the translation tables affected by [SCTLR.EE](#)
  - executing with [SCTLR.M](#) set to 0.
- [HSCTLR.EE](#) is changed only when either:
  - executing in a mode that does not use the translation tables affected by [HSCTLR.EE](#)
  - executing with [HSCTLR.M](#) set to 0.

The physical address of the base of the starting-level translation table is determined from the appropriate *Translation table base register* (TTBR), see [Determining the translation table base address on page B3-1320](#).

In an ARMv7 implementation that does not include the Multiprocessing Extensions, and in implementations of architecture versions before ARMv7, it is IMPLEMENTATION DEFINED whether a hardware translation table walk can cause a read from the L1 unified or data cache. If an implementation does not support translation table accesses from L1 cache then software must ensure coherency between translation table walks and data updates. This involves one of:

- storing translation tables in Normal memory that is Write-Through Cacheable for all cacheability regions to the PoU
- storing translation tables in Inner Write-Back Cacheable Normal memory and ensuring the appropriate cache entries are cleaned after modification
- storing translation tables in Non-cacheable memory.

For more information, see [TLB maintenance operations and the memory order model on page B3-1383](#).

If an implementation includes the Multiprocessing Extensions, translation table walks must access data or unified caches, or data and unified caches, of other agents participating in the coherency protocol, according to the shareability attributes described in the TTBR. These shareability attributes must be consistent with the shareability attributes for the translation tables themselves.

### B3.3.2 Information returned by a translation table lookup

In a VMSA implementation, when an associated MMU is enabled, a memory access requires one or more translation table lookups. If the required translation table descriptor is not held in a TLB, a translation table walk is performed to obtain the descriptor. A lookup, whether from the TLB or as the result of a translation table walk, returns both:

- an output address that corresponds to the input address for the lookup
- a set of properties that correspond to that output address.

The returned properties are classified as providing *address map control*, *access controls*, or *region attributes*. This classification determines how the descriptions of the properties are grouped. The classification is based on the following model:

#### Address map control

Memory accesses from Secure state can access either the Secure or the Non-secure address map, as summarized in [Access to the Secure or Non-secure physical address map on page B3-1321](#).

Memory accesses from Non-secure state can only access the Non-secure address map.

#### Access controls

Determine whether the processor, in its current state, can access the output address that corresponds to the given input address. If not, an MMU fault is generated and there is no memory access.

[Memory access control on page B3-1356](#) describes the properties in this group.

**Attributes** Are valid only for an output address that the processor, in its current state, can access. The attributes define aspects of the required behavior of accesses to the target memory region.

[Memory region attributes on page B3-1366](#) describes the properties in this group.

### B3.3.3 Determining the translation table base address

On a TLB miss, the VMSA must perform a translation table walk, and therefore must find the base address of the translation table to use for its lookup. A TTBR holds this address. As [Figure B3-2 on page B3-1312](#) shows:

- For a Non-secure PL2 stage 1 translation, the [HTTBR](#) holds the required base address. The [HTCR](#) is the control register for these translations.
- For a Non-secure PL1&0 stage 2 translation, the [VTTBR](#) holds the required base address. The [VTTCR](#) is the control register for these translations.
- For a Non-secure PL1&0 stage 1 translation, or for a Secure PL1&0 stage 1 translation, either [TTBR0](#) or [TTBR1](#) holds the required base address. The [TTBCR](#) is the control register for these translations.

The Non-secure copies of [TTBR0](#), [TTBR1](#), and [TTBCR](#), relate to the Non-secure PL1&0 stage 1 translation. The Secure copies of [TTBR0](#), [TTBR1](#), and [TTBCR](#), relate to the Secure PL1&0 stage 1 translation.

For Secure or Non-secure PL1&0 translation table walks:

- [TTBR0](#) can be configured to describe the translation of VAs in the entire address map, or to describe only the translation of VAs in the lower part of the address map
- If [TTBR0](#) is configured to describe the translation of VAs in the lower part of the address map, [TTBR1](#) is configured to describe the translation of VAs in the upper part of the address map.

The contents of the appropriate copy of the **TTBCR** determine whether the address map is separated into two parts, and where the separation occurs. The details of the separation depend on the current translation table format, see:

- [Selecting between TTBR0 and TTBR1, Short-descriptor translation table format on page B3-1330](#)
- [Selecting between TTBR0 and TTBR1, Long-descriptor translation table format on page B3-1345](#).

### Example B3-1 Example use of TTBR0 and TTBR1

An example of using the two TTBRs is:

**TTBR0** Used for process-specific addresses.

Each process maintains a separate first-level translation table. On a context switch:

- **TTBR0** is updated to point to the first-level translation table for the new context
- **TTBCR** is updated if this change changes the size of the translation table
- the **CONTEXTIDR** is updated.

**TTBCR** can be programmed so that all translations use **TTBR0** in a manner compatible with architecture versions before ARMv6.

**TTBR1** Used for operating system and I/O addresses, that do not change on a context switch.

### B3.3.4 Security Extensions control of translation table walks

When an implementation includes the Security Extensions, two bits in the **TTBCR** for the current security state control whether a translation table walk is performed on a TLB miss. These two bits are the:

- PD0 and PD1 bits, on a processor using the Short-descriptor translation table format
- EPD0 and EPD1 bits, on a processor using the Long-descriptor translation table format.

———— **Note** —————

The different bit names are because the bits are in different positions in **TTBCR**, depending on the translation table format.

The effect of these bits is:

**{E}PDx == 0** If a TLB miss occurs based on TTBRx, a translation table walk is performed. The current security state determines whether the memory access is Secure or Non-secure.

**{E}PDx == 1** If a TLB miss occurs based on TTBRx, a First level Translation fault is returned, and no translation table walk is performed.

### B3.3.5 Access to the Secure or Non-secure physical address map

As stated in [Address spaces in a VMSA implementation on page B3-1311](#), a processor that implements the Security Extensions implements independent Secure and Non-secure address maps. These are defined by the translation tables identified by the Secure **TTBR0** and **TTBR1**. In both translation table formats:

- In the Secure translation tables, the NS bit in a descriptor indicates whether the descriptor refers to the Secure or the Non-secure address map:
  - NS == 0** Access the Secure physical address space.
  - NS == 1** Access the Non-secure physical address space.
- In the Non-secure translation tables, the corresponding bit is SBZ. Non-secure accesses always access the Non-secure physical address space, regardless of the value of this bit.

The Long-descriptor translation table format extends this control, adding an NSTable bit to the Secure translation tables, as described in *Hierarchical control of Secure or Non-secure memory accesses, Long-descriptor format* on page B3-1344. In the Non-secure translation tables, the corresponding bit is SBZ, and Non-secure accesses ignore the value of this bit.

The following sections describe the address map controls in the two implementations:

- *Control of Secure or Non-secure memory access, Short-descriptor format* on page B3-1330
- *Control of Secure or Non-secure memory access, Long-descriptor format* on page B3-1344.

For more information, see *Secure and Non-secure address spaces* on page B3-1323.

## B3.4 Secure and Non-secure address spaces

When implemented, the Security Extensions provide two physical address spaces, a Secure physical address space and a Non-secure physical address space.

As described in [Access to the Secure or Non-secure physical address map on page B3-1321](#), for Secure and Non-secure PL1&0 stage 1 translations, the translation table base registers, `TTBR0`, `TTBR1`, and `TTBCR` are Banked between Secure and Non-secure versions, and the security state of the processor when it performs a memory access selects the corresponding version of the registers. This means there are independent Secure and Non-secure versions of these translation tables, and translation table walks are made to the physical address space corresponding to the security state of the translation tables used.

For a translation table walk caused by a memory access from Non-secure state, all memory accesses are to the Non-secure address space.

For a translation table walk caused by a memory access from Secure state:

- In an implementation that includes the Large Physical Address Extension, when address translation is using the Long-descriptor translation table format:
  - the first lookup performed must access the Secure address space
  - if a table descriptor read from the Secure address space has the `NSTable` bit set to 0, then the next level of lookup is from the Secure address space
  - if a table descriptor read from the Secure address space has the `NSTable` bit set to 1, then the next level of lookup, and any subsequent level of lookup, is from the Non-secure address space.

For more information, see [Control of Secure or Non-secure memory access, Long-descriptor format on page B3-1344](#).

- Otherwise, all memory accesses are to the Secure address space.

---

### Note

- An ARMv7 implementation that includes the Virtualization Extensions, when executing in Non-secure state, supports additional translations:
  - Non-secure PL2 stage 1 translation
  - Non-secure PL1&0 stage 2 translation.

These translations can access only the Non-secure address space.

- A system implementation can alias parts of the Secure physical address space to the Non-secure physical address space in an implementation-specific way. As with any other aliasing of physical memory, the use of aliases in this way can require the use of cache maintenance operations to ensure that changes to memory made using one alias of the physical memory are visible to accesses to the other alias of the physical memory.
-

## B3.5 Short-descriptor translation table format

The Short-descriptor translation table format supports a memory map based on memory sections or pages:

**Supersections** Consist of 16MB blocks of memory. Support for Supersections is optional, except that an implementation that includes the Large Physical Address Extension and supports more than 32 bits of Physical Address must also support Supersections to provide access to the entire Physical Address space.

**Sections** Consist of 1MB blocks of memory.

**Large pages** Consist of 64KB blocks of memory.

**Small pages** Consist of 4KB blocks of memory.

Supersections, Sections and Large pages map large regions of memory using only a single TLB entry.

———— **Note** —————

Whether a VMSAv7 implementation of the Short-descriptor format translation tables supports supersections is IMPLEMENTATION DEFINED.

When using the Short-descriptor translation table format, two levels of translation tables are held in memory:

**First-level table**

Holds *first-level descriptors* that contain the base address and

- translation properties for a Section and Supersection
- translation properties and pointers to a second-level table for a Large page or a Small page.

**Second-level tables**

Hold *second-level descriptors* that contain the base address and translation properties for a Small page or a Large page. With the Short-descriptor format, second-level tables can be referred to as *Page tables*.

A second-level table requires 1KByte of memory.

In the translation tables, in general, a descriptor is one of:

- an invalid or fault entry
- a page table entry, that points to a next-level translation table
- a page or section entry, that defines the memory properties for the access
- a reserved format.

Bits[1:0] of the descriptor give the primary indication of the descriptor type.



Figure B3-3 gives a general view of address translation when using the Short-descriptor translation table format.

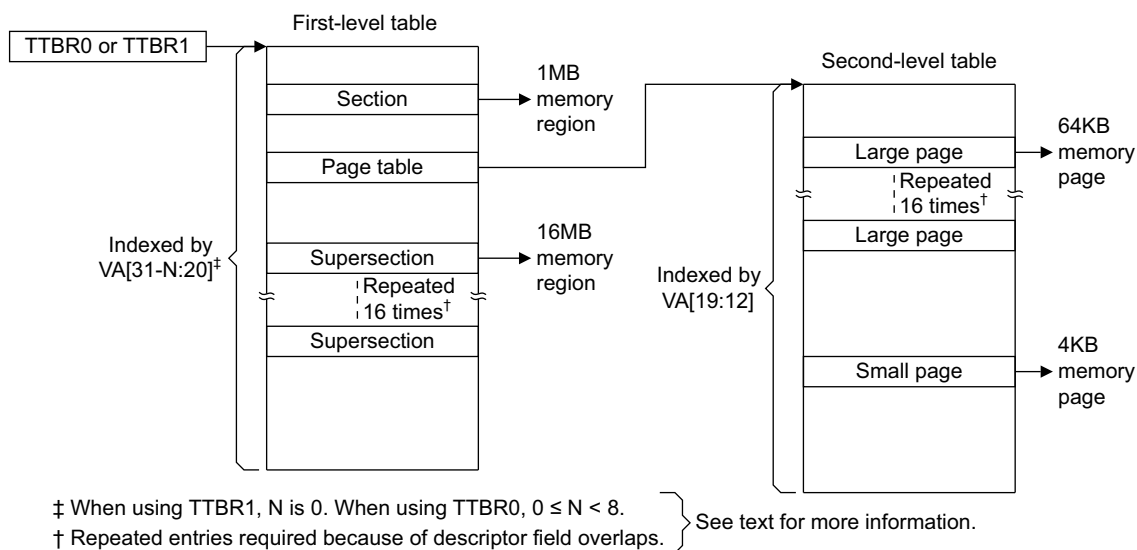

**Figure B3-3 General view of address translation using Short-descriptor format translation tables**

*Additional requirements for Short-descriptor format translation tables on page B3-1328* describes why, when using the Short-descriptor format, Supersection and Large page entries must be repeated 16 times, as shown in Figure B3-3.

*Short-descriptor translation table format descriptors, Memory attributes in the Short-descriptor translation table format descriptors on page B3-1328, and Control of Secure or Non-secure memory access, Short-descriptor format on page B3-1330* describe the format of the descriptors in the Short-descriptor format translation tables.

The following sections then describe the use of this translation table format:

- *Selecting between TTBR0 and TTBR1, Short-descriptor translation table format on page B3-1330*
- *Translation table walks, when using the Short-descriptor translation table format on page B3-1331.*

### B3.5.1 Short-descriptor translation table format descriptors

The following sections describe the formats of the entries in the Short-descriptor translation tables:

- *Short-descriptor translation table first-level descriptor formats on page B3-1326*
- *Short-descriptor translation table second-level descriptor formats on page B3-1327.*

For more information about second-level translation tables see *Additional requirements for Short-descriptor format translation tables on page B3-1328.*

———— **Note** —————

Previous versions of the *ARM Architecture Reference Manual*, and some other documentation, describes the AP[2] bit in the translation table entries as the APX bit.

*Information returned by a translation table lookup on page B3-1320* describes the classification of the non-address fields in the descriptors as address map control, access control, or attribute fields.

### Short-descriptor translation table first-level descriptor formats

Each entry in the first-level table describes the mapping of the associated 1MB MVA range.

Figure B3-4 shows the possible first-level descriptor formats.

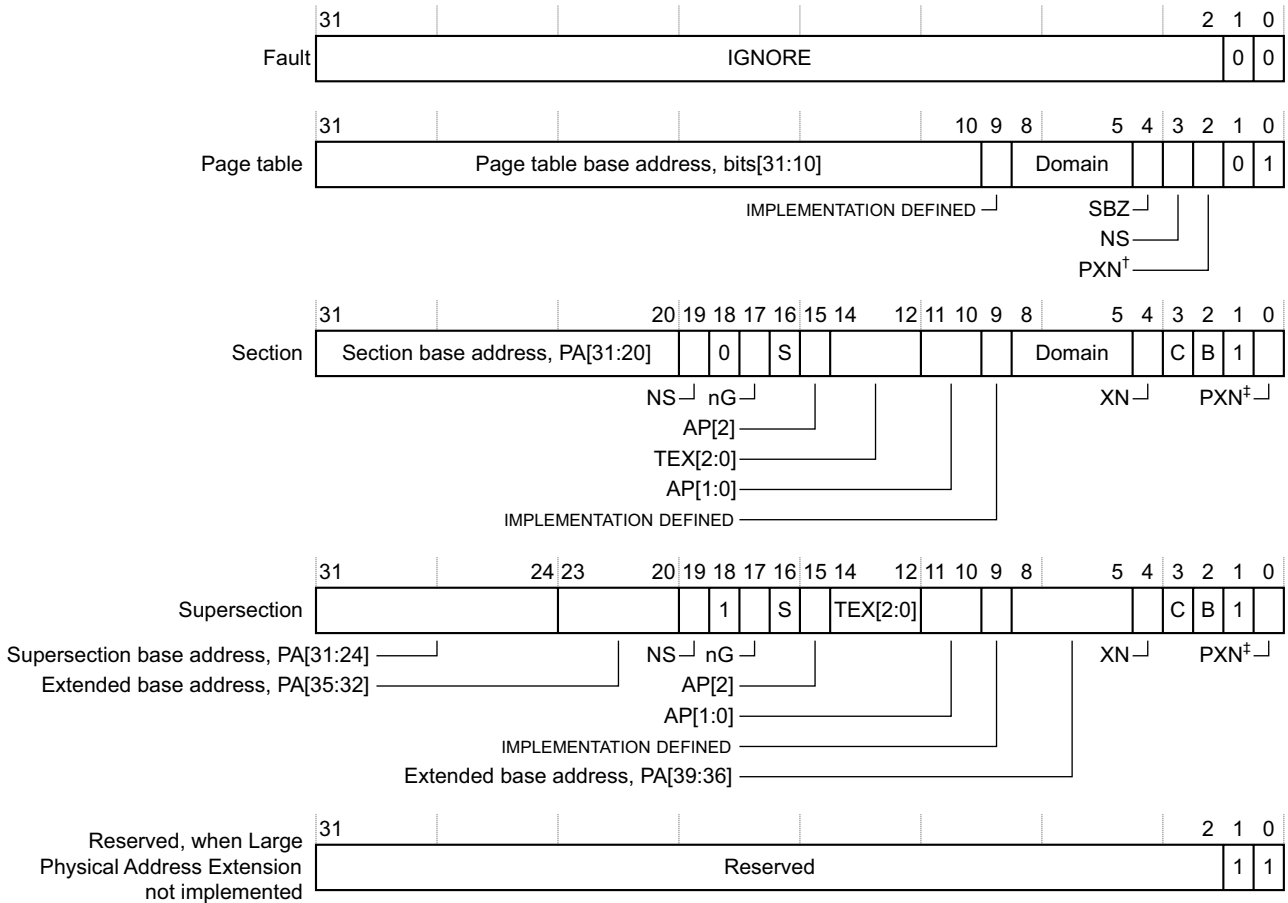

† If the implementation does not support the PXN attribute this bit is SBZ. } An implementation that includes the Large Physical Address Extension must support the PXN attribute.  
 ‡ If the implementation does not support the PXN attribute these bits must be 0. }

**Figure B3-4 Short-descriptor first-level descriptor formats**

Inclusion of the PXN attribute in the Short-descriptor translation table formats is:

- OPTIONAL in an implementation that does not include the Large Physical Address Extension
- required in an implementation includes the Large Physical Address Extension.

Descriptor bits[1:0] identify the descriptor type. On an implementation that supports the PXN attribute, for the Section and Supersection entries, bit[0] also defines the PXN value. The encoding of these bits is:

#### 0b00, Invalid or fault entry

The associated VA is unmapped, and any attempt to access it generates a Translation fault.

Software can use bits[31:2] of the descriptor for its own purposes, because the hardware ignores these bits.

#### 0b01, Page table

The descriptor gives the address of a second-level translation table, that specifies the mapping of the associated 1MByte VA range.

**0b10, Section or Supersection**

The descriptor gives the base address of the Section or Supersection. Bit[18] determines whether the entry describes a Section or a Supersection.

If the implementation supports the PXN attribute, this encoding also defines the PXN bit as 0.

**0b11, Section or Supersection, if the implementation supports the PXN attribute**

If an implementation supports the PXN attribute, this encoding is identical to 0b10, except that it defines the PXN bit as 1.

**0b11, Reserved, if the implementation does not support the PXN attribute**

An attempt to access the associated VA generates a Translation fault.

On an implementation that does not support the PXN attribute, this encoding must not be used.

———— **Note** ————

- Issues A and B of this manual did not include the OPTIONAL support of the PXN attribute. The addition of support for this attribute is backwards-compatible with software written to use the original VMSAv7 definition of the Short-descriptor translation table formats.
- A VMSAv7 implementation that implements the Large Physical Address Extension can use the Short-descriptor translation table format for the Secure or Non-secure PL1&0 stage 1 translations, by setting **TTBCR.EAE** to 0.

The address information in the first-level descriptors is:

**Page table** Bits[31:10] of the descriptor are bits[31:10] of the address of a Page table.

**Section** Bits[31:20] of the descriptor are bits[31:20] of the address of the Section.

**Supersection** Bits[31:24] of the descriptor are bits[31:24] of the address of the Supersection.

Optionally, bits[8:5, 23:20] of the descriptor are bits[39:32] of the extended Supersection address.

On an implementation that includes the Virtualization Extensions, for the Non-secure translation tables, the address in the descriptor is the IPA of the Page table, Section, or Supersection. Otherwise, the address is the PA of the Page table, Section, or Supersection.

For descriptions of the other fields in the descriptors, see *Memory attributes in the Short-descriptor translation table format descriptors* on page B3-1328.

**Short-descriptor translation table second-level descriptor formats**

Figure B3-5 shows the possible formats of a second-level descriptor.

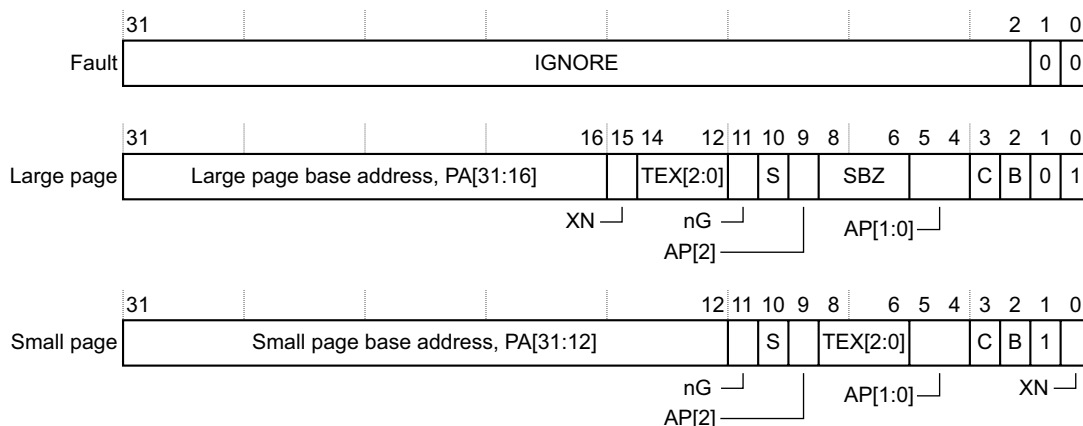

**Figure B3-5 Short-descriptor second-level descriptor formats**

Descriptor bits[1:0] identify the descriptor type. The encoding of these bits is:

**0b00, Invalid or fault entry**

The associated VA is unmapped, and attempting to access it generates a Translation fault.

Software can use bits[31:2] of the descriptor for its own purposes, because the hardware ignores these bits.

**0b01, Large page**

The descriptor gives the base address and properties of the Large page.

**0b1x, Small page**

The descriptor gives the base address and properties of the Small page.

In this descriptor format, bit[0] of the descriptor is the XN bit.

The address information in the second-level descriptors is:

**Large page** Bits[31:16] of the descriptor are bits[31:16] of the address of the Large page.

**Small page** Bits[31:12] of the descriptor are bits[31:12] of the address of the Small page.

On an implementation that includes the Virtualization Extensions, for the Non-secure translation tables, the address in the descriptor is the IPA of the Page table, Section, or Supersection. Otherwise, the address is the PA of the Page table, Section, or Supersection.

For descriptions of the other fields in the descriptors, see [Memory attributes in the Short-descriptor translation table format descriptors](#).

### Additional requirements for Short-descriptor format translation tables

When using Supersection or Large page descriptors in the Short-descriptor translation table format, the input address field that defines the Supersection or Large page descriptor address overlaps the table address field. In each case, the size of the overlap is 4 bits. The following diagrams show these overlaps:

- [Figure B3-8 on page B3-1334](#) for the first-level translation table Supersection entry
- [Figure B3-10 on page B3-1336](#) for the second-level translation table Large page table entry.

Considering the case of using Large page table descriptors in a second-level translation table, this overlap means that for any specific Large page, the bottom four bits of the second-level translation table entry might take any value from 0b0000 to 0b1111. Therefore, each of these sixteen index values must point to a separate copy of the same descriptor.

This means that each Large page or Supersection descriptor must:

- occur first on a sixteen-word boundary
- be repeated in 16 consecutive memory locations.

## B3.5.2 Memory attributes in the Short-descriptor translation table format descriptors

This section describes the descriptor fields other than the descriptor type field and the address field:

**TEX[2:0], C, B**

Memory region attribute bits, see [Memory region attributes on page B3-1366](#).

These bits are not present in a Page table entry.

**XN bit**

The Execute-never bit. Determines whether the processor can execute software from the addressed region, see [Execute-never restrictions on instruction fetching on page B3-1359](#).

This bit is not present in a Page table entry.

### PXN bit, when supported

The Privileged execute-never bit:

- On an implementation that does not include the Large Physical Address Extension, support for the PXN bit in the Short-descriptor translation table format is OPTIONAL.
- On an implementation that includes the Large Physical Address Extension, the Short-descriptor translation table format must include the PXN bit.

When supported, the PXN bit determines whether the processor can execute software from the region when executing at PL1, see [Execute-never restrictions on instruction fetching on page B3-1359](#).

#### ———— Note —————

Memory accesses by software executing at PL2 always use the Long-descriptor translation table format.

When this bit is set to 1 in the Page table descriptor, it indicates that all memory pages described in the corresponding page table are Privileged execute-never.

### NS bit

Non-secure bit. If an implementation includes the Security Extensions, for memory accesses from Secure state, this bit specifies whether the translated PA is in the Secure or Non-secure address map, see [Control of Secure or Non-secure memory access, Short-descriptor format on page B3-1330](#).

This bit is not present in second-level descriptors. The value of the NS bit in the first level Page table descriptor applies to all entries in the corresponding second-level translation table.

### Domain

Domain field, see [Domains, Short-descriptor format only on page B3-1362](#).

This field is not present in a Supersection entry. Memory described by Supersections is in domain 0.

This bit is not present in second-level descriptors. The value of the Domain field in the first level Page table descriptor applies to all entries in the corresponding second-level translation table.

### An IMPLEMENTATION DEFINED bit

This bit is not present in second-level descriptors.

### AP[2], AP[1:0]

Access Permissions bits, see [Memory access control on page B3-1356](#).

AP[0] can be configured as the *Access flag*, see [The Access flag on page B3-1362](#).

These bits are not present in a Page table entry.

### S bit

The Shareable bit. Determines whether the addressed region is Shareable memory, see [Memory region attributes on page B3-1366](#).

This bit is not present in a Page table entry.

### nG bit

The not global bit. Determines how the translation is marked in the TLB, see [Global and process-specific translation table entries on page B3-1378](#).

This bit is not present in a Page table entry.

### Bit[18], when bits[1:0] indicate a *Section or Supersection* descriptor

- |   |                                   |
|---|-----------------------------------|
| 0 | Descriptor is for a Section       |
| 1 | Descriptor is for a Supersection. |

### B3.5.3 Control of Secure or Non-secure memory access, Short-descriptor format

[Access to the Secure or Non-secure physical address map on page B3-1321](#) describes how the NS bit in the translation table entries:

- for accesses from Secure state, determines whether the access is to Secure or Non-secure memory
- is ignored by accesses from Non-secure state.

In the Short-descriptor translation table format, the NS bit is defined only in the first-level translation tables. This means that, in a first-level Page table descriptor, the NS bit defines the physical address space, Secure or Non-secure, for all of the Large pages and Small pages of memory described by that table.

The NS bit of a first-level Page table descriptor has no effect on the physical address space in which that translation table is held. As stated in [Secure and Non-secure address spaces on page B3-1323](#), the physical address of that translation table is in:

- the Secure address space if the translation table walk is in Secure state
- the Non-secure address space if the translation table walk is in Non-secure state.

This means the granularity of the Secure and Non-secure memory spaces is 1MB. However, in these memory spaces, table entries can define physical memory regions with a granularity of 4KB.

### B3.5.4 Selecting between TTBR0 and TTBR1, Short-descriptor translation table format

As described in [Determining the translation table base address on page B3-1320](#), two sets of translation tables can be defined for each of the PL1&0 stage 1 translations, and [TTBR0](#) and [TTBR1](#) hold the base addresses for the two sets of tables. When using the Short-descriptor translation table format, the value of [TTBCR.N](#) indicates the number of most significant bits of the input VA that determine whether [TTBR0](#) or [TTBR1](#) holds the required translation table base address, as follows:

- If  $N == 0$  then use [TTBR0](#). Setting [TTBCR.N](#) to zero disables use of a second set of translation tables.
- if  $N > 0$  then:
  - if bits[31:32-N] of the input VA are all zero then use [TTBR0](#)
  - otherwise use [TTBR1](#).

[Table B3-1](#) shows how the value of N determines the lowest address translated using [TTBR1](#), and the size of the first-level translation table addressed by [TTBR0](#).

**Table B3-1 Effect of TTBCR.N on address translation, Short-descriptor format**

TTBCR.N	First address translated with TTBR1	TTBR0 table	
		Size	Index range
0b000	<a href="#">TTBR1</a> not used	16KB	VA[31:20]
0b001	0x80000000	8KB	VA[30:20]
0b010	0x40000000	4KB	VA[29:20]
0b011	0x20000000	2KB	VA[28:20]
0b100	0x10000000	1KB	VA[27:20]
0b101	0x08000000	512 bytes	VA[26:20]
0b110	0x04000000	256 bytes	VA[25:20]
0b111	0x02000000	128 bytes	VA[24:20]

Whenever [TTBCR.N](#) is nonzero, the size of the translation table addressed by [TTBR1](#) is 16KB.

[Figure B3-6 on page B3-1331](#) shows how the value of [TTBCR.N](#) controls the boundary between VAs that are translated using [TTBR0](#), and VAs that are translated using [TTBR1](#).

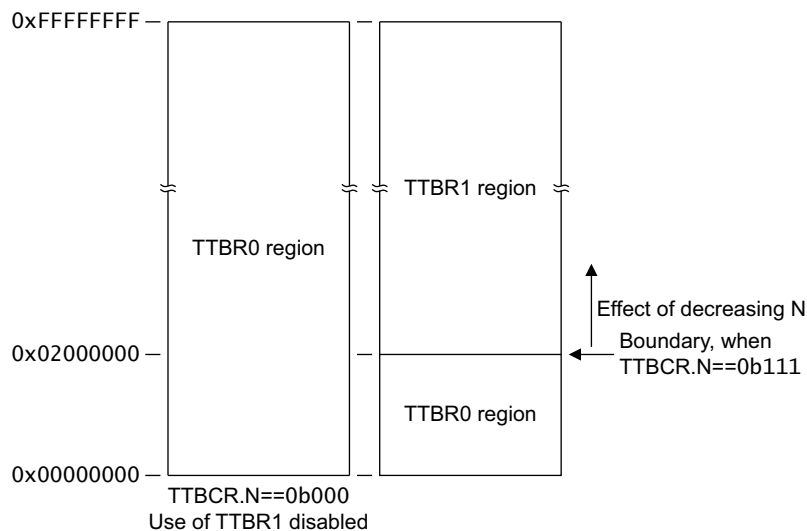

**Figure B3-6 How TTBCR.N controls the boundary between the TTBRs, Short-descriptor format**

In the selected TTBR, the following bits define the memory region attributes for the translation table walk:

- the RGN, S and C bits, in an implementation that does not include the Multiprocessing Extensions
- the RGN, S, and IRGN[1:0] bits, in an implementation that includes the Multiprocessing Extensions.

For more information, see *TTBCR, Translation Table Base Control Register, VMSA on page B4-1721*, *TTBR0, Translation Table Base Register 0, VMSA on page B4-1726* and *TTBR1, Translation Table Base Register 1, VMSA on page B4-1730*.

*Translation table walks, when using the Short-descriptor translation table format* describes the translation.

### B3.5.5 Translation table walks, when using the Short-descriptor translation table format

When using the Short-descriptor translation table format, and a memory access requires a translation table walk:

- a section-mapped access only requires a read of the first-level translation table
- a page-mapped access also requires a read of the second-level translation table.

*Reading a first-level translation table* describes how either *TTBR1* or *TTBR0* is used, with the accessed VA, to determine the address of the first-level descriptor.

*Reading a first-level translation table* shows the output address as A[39:0]:

- On an implementation that includes the Virtualization Extensions, for a Non-secure PL1&0 stage 1 translation, this is the IPA of the required descriptor. A Non-secure PL1&0 stage 2 translation of this address is performed to obtain the PA of the descriptor.
- Otherwise, this address is the PA of the required descriptor.

*The full translation flow for Sections, Supersections, Small pages and Large pages on page B3-1332* then shows the complete translation flow for each valid memory access.

#### Reading a first-level translation table

When performing a fetch based on *TTBR0*:

- the address bits taken from *TTBR0* vary between bits[31:14] and bits[31:7]
- the address bits taken from the VA, that is the input address for the translation, vary between bits[31:20] and bits[24:20].

The width of the *TTBR0* and VA fields depend on the value of *TTBCR.N*, as *Figure B3-7 on page B3-1332* shows.

When performing a fetch based on **TTBR1**, Bits **TTBR1**[31:14] are concatenated with bits[31:20] of the VA. This makes the fetch equivalent to that shown in [Figure B3-7](#), with  $N=0$ .

**Note**

See [The address and Properties fields shown in the translation flows on page B3-1333](#) for more information about the *Properties* label used in this and other figures.

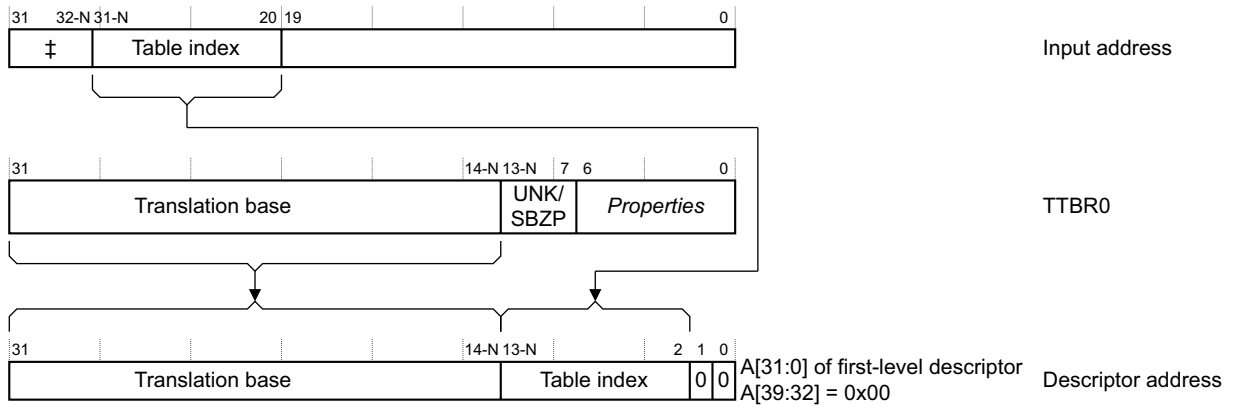

‡ This field is absent if N is 0  
 N is the value of TTBCR.N  
 For details of the *Properties* field, see the register description

**Figure B3-7 Accessing first-level translation table based on TTBR0, Short-descriptor format**

Regardless of which register is used as the base for the fetch, the resulting output address selects a four-byte translation table entry that is one of:

- A first-level descriptor for a Section or Supersection.
- A *Page table* descriptor that points to a second-level translation table. In this case:
  - a second fetch is performed to retrieve a second-level descriptor
  - the descriptor also contains some attributes for the access, see [Figure B3-4 on page B3-1326](#).
- A faulting entry.

**The full translation flow for Sections, Supersections, Small pages and Large pages**

In a translation table walk, only the first lookup uses the translation table base address from the appropriate Translation table base register. Subsequent lookups use a combination of address information from:

- the table descriptor read in the previous lookup
- the input address.

This section summarizes how each of the memory section and page options is described in the translation tables, and has a subsection summarizing the full translation flow for each of the options.

As described in [Short-descriptor translation table format descriptors on page B3-1325](#), the four options are:

**Supersection** A 16MB memory region, see [Translation flow for a Supersection on page B3-1334](#).

**Section** A 1MB memory region, see [Translation flow for a Section on page B3-1335](#).

**Large page** A 64KB memory region, described by the combination of:

- a first-level translation table entry that indicates a second-level Page table address
- a second-level descriptor that indicates a Large page.

See [Translation flow for a Large page on page B3-1336](#).



**Small page** A 4KB memory region, described by the combination of:

- a first-level translation table entry that indicates a second-level Page table address
- a second-level descriptor that indicates a Small page.

See [Translation flow for a Small page on page B3-1337](#).

**The address and Properties fields shown in the translation flows**

On an implementation that includes the Virtualization Extensions, for the Non-secure translation tables:

- any descriptor address is the IPA of the required descriptor
- the final output address is the IPA of the Section, Supersection, Large page, or Small page.

In these cases, a PL1&0 stage 2 translation is performed to translate the IPA to the required PA.

Otherwise, the address is the PA of the descriptor, Section, Supersection, Large page, or Small page.

*Properties* indicates register or translation table fields that return information, other than address information, about the translation or the targeted memory region. For more information see [Information returned by a translation table lookup on page B3-1320](#), and the description of the register or translation table descriptor.

For translations using the Short-descriptor translation table format, [Short-descriptor translation table format descriptors on page B3-1325](#) describes the descriptors formats.

**Translation flow for a Supersection**

Figure B3-8 shows the complete translation flow for a Supersection. For more information about the fields shown in this figure see *The address and Properties fields shown in the translation flows* on page B3-1333.

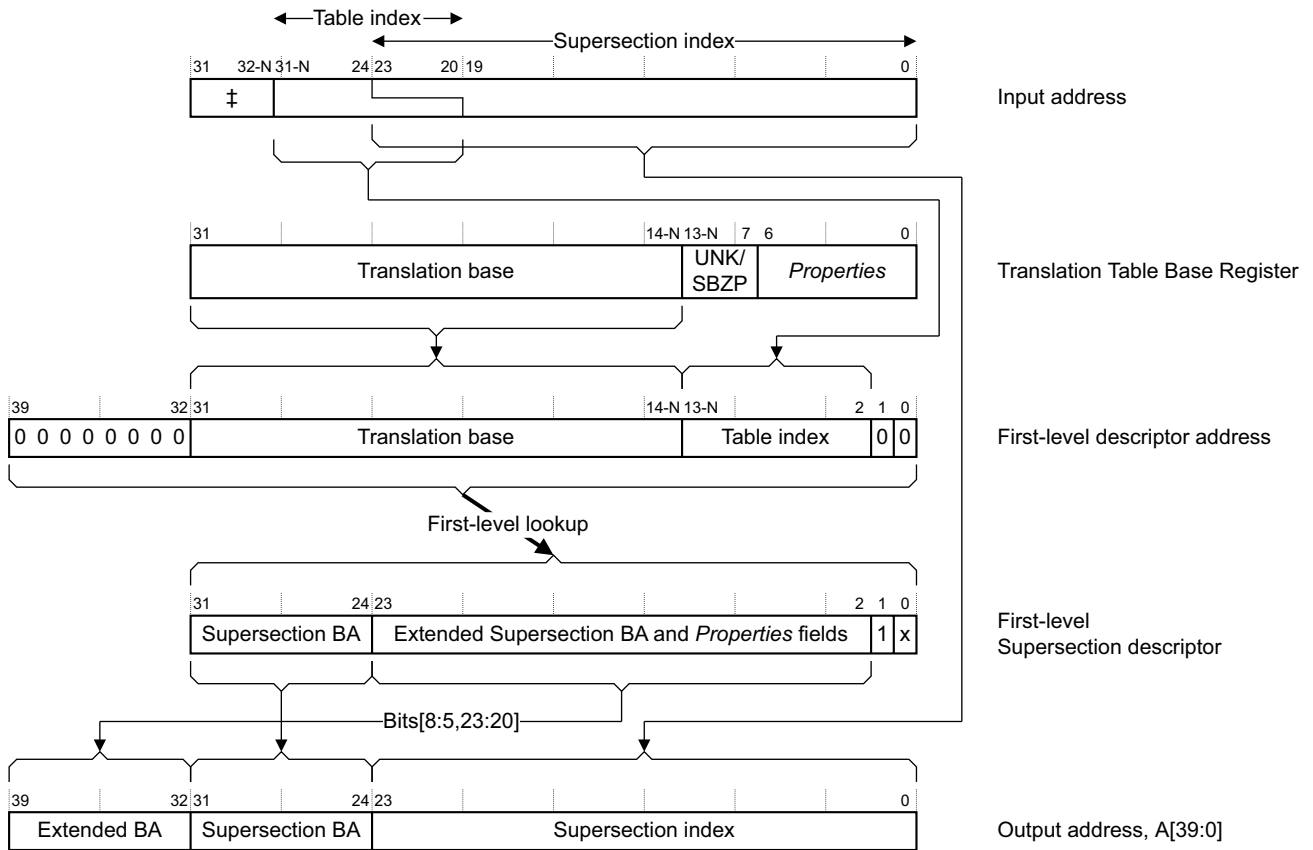

‡ This field is absent if N is 0  
 BA = Base address  
 For a translation based on TTBR0, N is the value of TTBCR.N  
 For a translation based on TTBR1, N is 0  
 For details of *Properties* fields, see the register or descriptor description

**Figure B3-8 Supersection address translation**

**Note**

Figure B3-8 shows how, when the input address, the VA, addresses a Supersection, the top four bits of the *Supersection index* bits of the address overlap the bottom four bits of the *Table index* bits. For more information, see *Additional requirements for Short-descriptor format translation tables* on page B3-1328.

**Translation flow for a Section**

Figure B3-9 shows the complete translation flow for a Section. For more information about the fields shown in this figure see *The address and Properties fields shown in the translation flows* on page B3-1333.

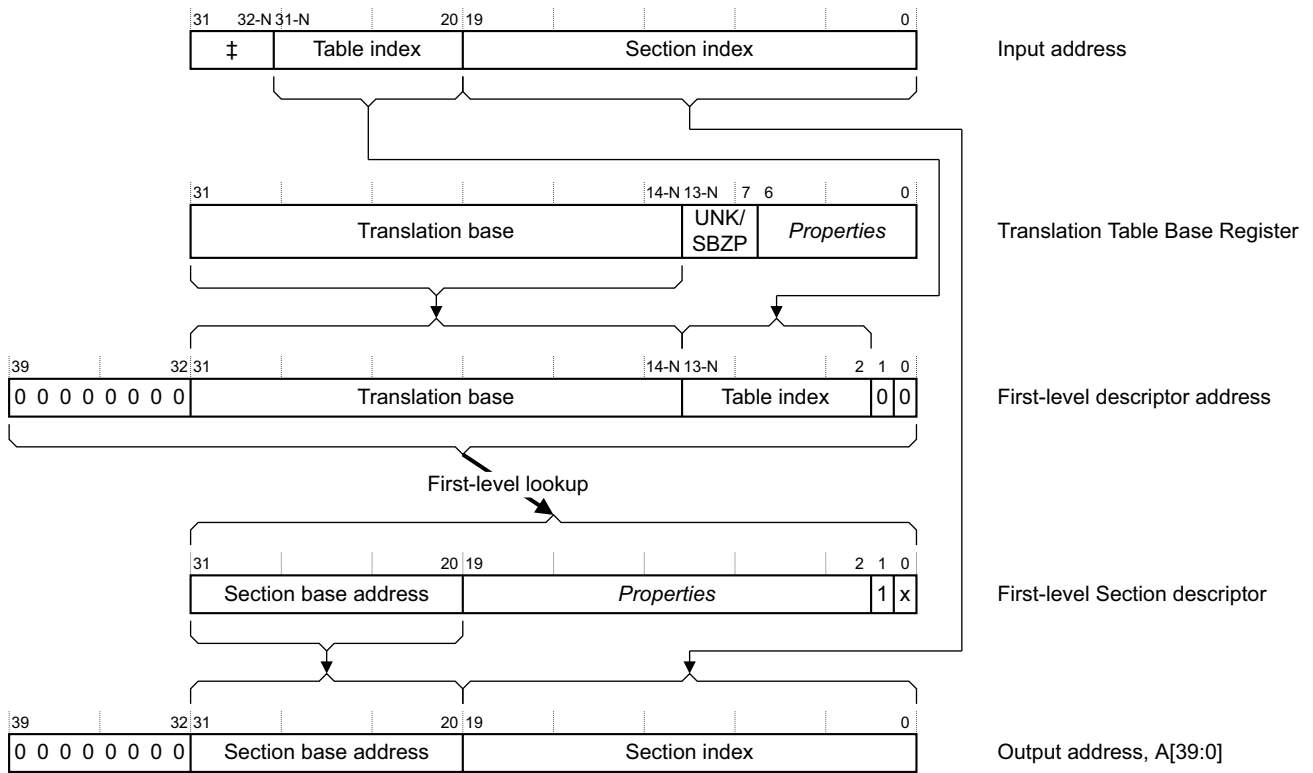

‡ This field is absent if N is 0  
 For a translation based on TTBR0, N is the value of TTBCR.N  
 For a translation based on TTBR1, N is 0  
 For details of *Properties* fields, see the register or descriptor description.

**Figure B3-9 Section address translation**

**Translation flow for a Large page**

Figure B3-10 shows the complete translation flow for a Large page. For more information about the fields shown in this figure see *The address and Properties fields shown in the translation flows on page B3-1333*.

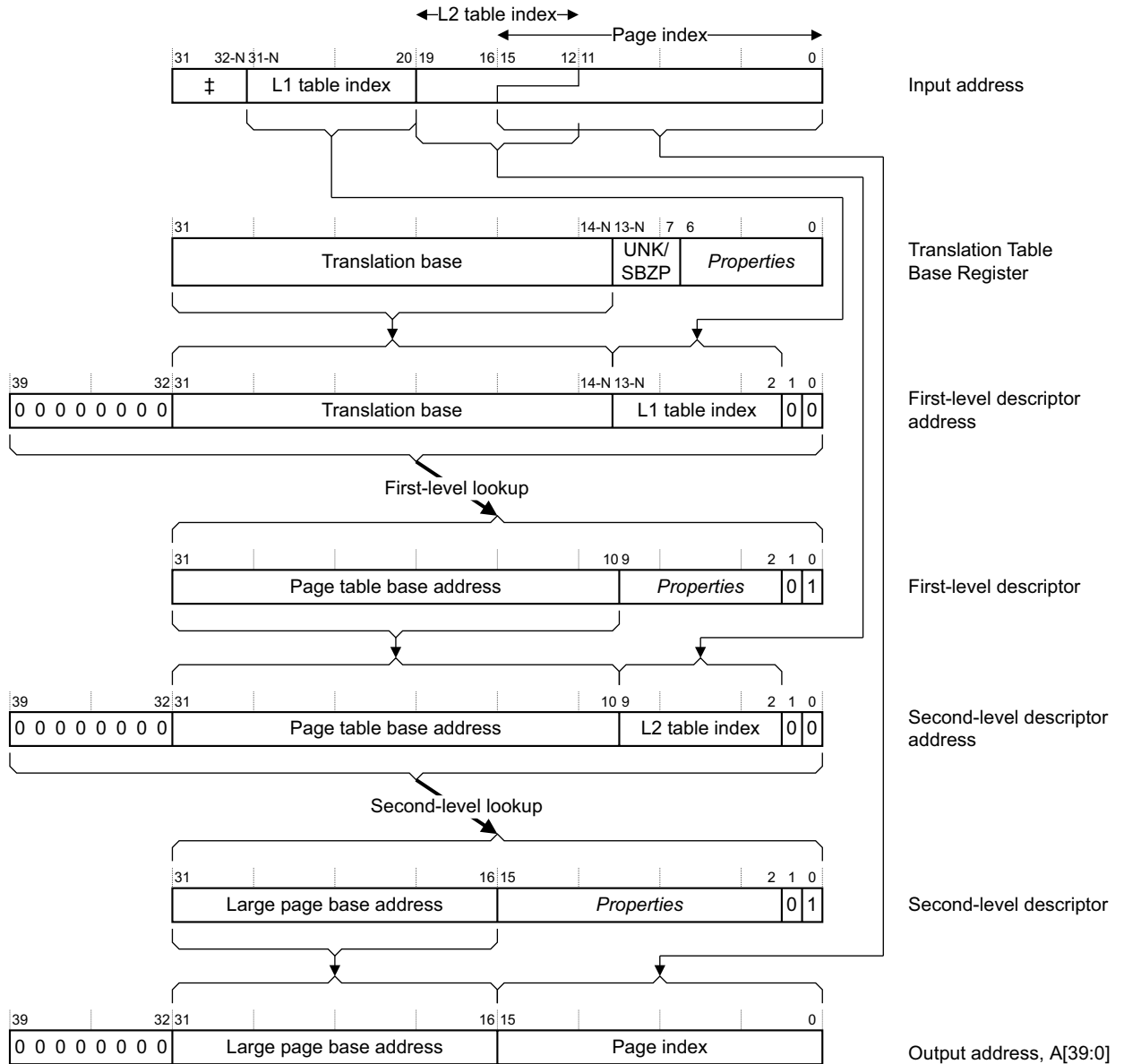

‡ This field is absent if N is 0  
 L1 = First-level, L2 = Second-level  
 For a translation based on TTBR0, N is the value of TTBCR.N  
 For a translation based on TTBR1, N is 0  
 For details of *Properties* fields, see the register or descriptor description

**Figure B3-10 Large page address translation**

**Note**

Figure B3-10 shows how, when the input address, the VA, addresses a Large page, the top four bits of the *page index* bits of the address overlap the bottom four bits of the *First-level table index* bits. For more information, see *Additional requirements for Short-descriptor format translation tables on page B3-1328*.

**Translation flow for a Small page**

Figure B3-11 shows the complete translation flow for a Small page. For more information about the fields shown in this figure see *The address and Properties fields shown in the translation flows* on page B3-1333.

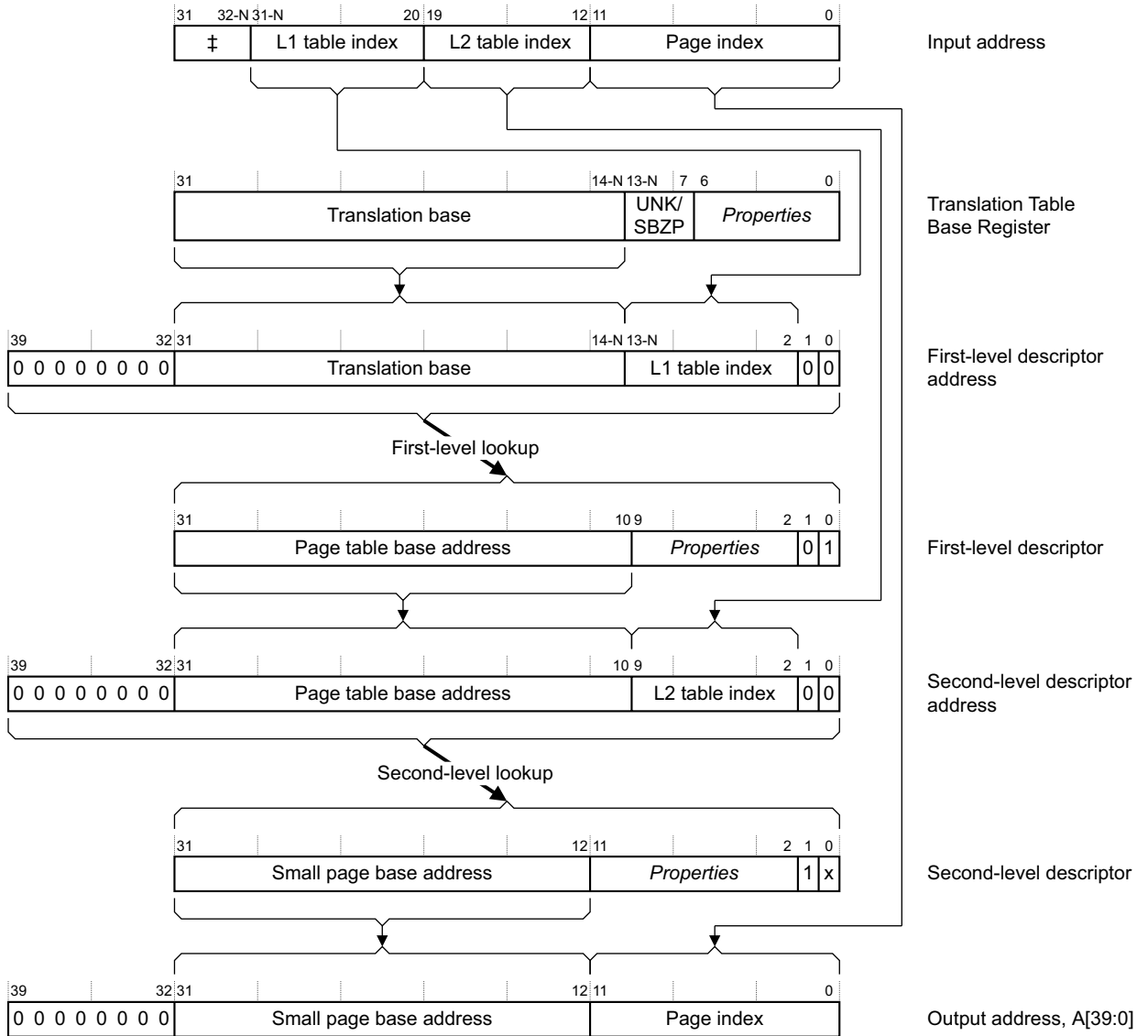

‡ This field is absent if N is 0  
 L1 = First-level, L2 = Second-level  
 For a translation based on TTBR0, N is the value of TTBCR.N  
 For a translation based on TTBR1, N is 0  
 For details of *Properties* fields, see the register or descriptor description.

**Figure B3-11 Small page address translation**

## B3.6 Long-descriptor translation table format

The Long-descriptor translation table format is implemented only as part of the Large Physical Address Extension. It supports the assignment of memory attributes to memory *Pages*, at a granularity of 4KB, across the complete input address range. It also supports the assignment of memory attributes to *blocks* of memory, where a block can be 2MB or 1GB.

———— **Note** ————

- While the current implementation is limited to three levels of address lookup, its design and naming conventions support extension to additional levels, to support a larger input address range.
- Similarly, while the current implementation limits the output address range to 40 bits, its design supports extension to a larger output address range.

In a VMSAv7 implementation that does not include the Virtualization Extensions, the Long-descriptor translation table format can be used for either or both the Secure and Non-secure address translations.

In an implementation that includes the Virtualization Extensions, [Figure B3-2 on page B3-1312](#) shows the different address translation stages, and the Long-descriptor translation table format:

- is used for:
  - the Non-secure PL2 stage 1 translation
  - the Non-secure PL1&0 stage 2 translation
- can be used for the Secure and Non-secure PL1&0 stage 1 translations.

When used for a stage 1 translation, the translation tables support an input address of up to 32 bits, corresponding to the VA address range of the processor. [Figure B3-12](#) gives a general view of stage 1 address translation when using the Long-descriptor translation table format.

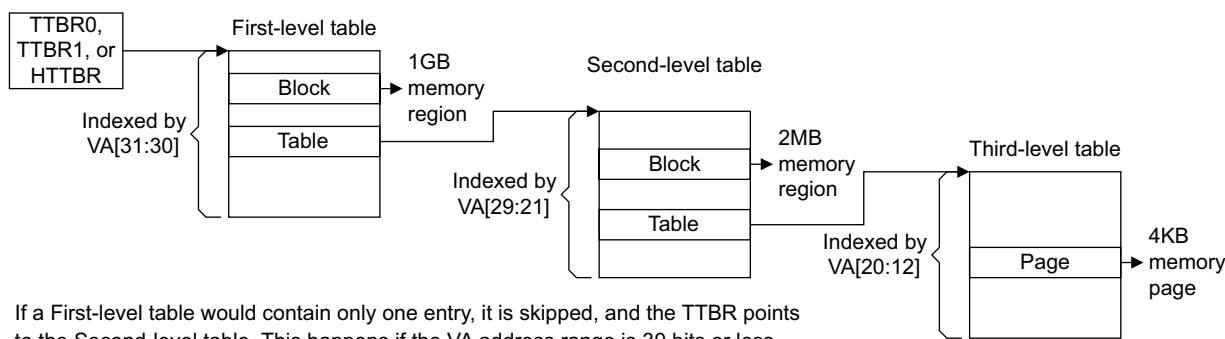

**Figure B3-12 General view of stage 1 address translation using Long-descriptor format**

When used for a stage 2 translation, the translation tables support an input address range of up to 40 bits, to support the translation from IPA to PA. If the input address for the stage 2 translation is a 32-bit address then this address is zero-extended to 40 bits.

———— **Note** ————

When the Short-descriptor translation table format is used for the Non-secure stage 1 translations, this generates 32-bit IPAs. These are zero-extended to 40 bits to provide the input address for the stage 2 translation.

Figure B3-13 gives a general view of stage 2 address translation. Stage 2 translation always uses the Long-descriptor translation table format.

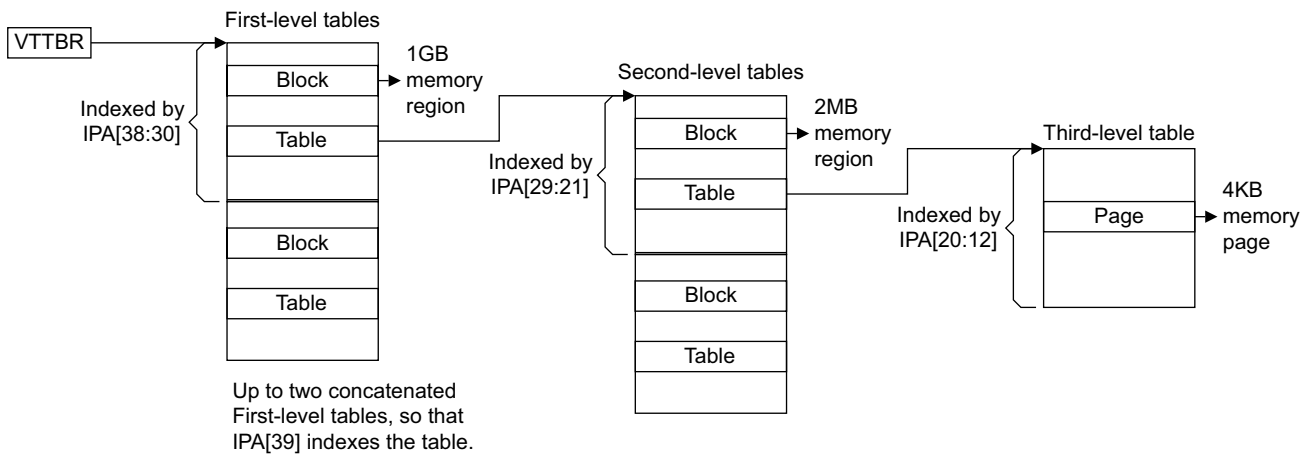

If a First-level table would contain 16 entries or fewer, first-level lookup can be omitted. If so, VTTBR points to the start of a block of concatenated Second-level tables. See text for more information.

**Figure B3-13 General view of stage 2 address translation, Long-descriptor translation table format**

*Use of concatenated translation tables for stage 2 translations on page B3-1348* describes how using concatenated Second-level tables means lookup can start at the Second level, as referred to in Figure B3-13.

*Long-descriptor translation table format descriptors, Memory attributes in the Long-descriptor translation table format descriptors on page B3-1342, and Control of Secure or Non-secure memory access, Long-descriptor format on page B3-1344* describe the format of the descriptors in the Long-descriptor format translation tables.

The following sections then describe the use of this translation table format:

- *Selecting between TTBR0 and TTBR1, Long-descriptor translation table format on page B3-1345*
- *Long-descriptor translation table format address lookup levels on page B3-1348*
- *Translation table walks, when using the Long-descriptor translation table format on page B3-1350.*

### B3.6.1 Long-descriptor translation table format descriptors

As described in *Long-descriptor translation table format address lookup levels on page B3-1348*, the Long-descriptor translation table format provides up to three levels of address lookup. A translation table walk starts either at the first level or the second level of address lookup.

In general, a descriptor is one of:

- an invalid or fault entry
- a table entry, that points to the next-level translation table
- a block entry, that defines the memory properties for the access
- a reserved format.

Bit[1] of the descriptor indicates the descriptor type, and bit[0] indicates whether the descriptor is valid.

The following sections describe the Long-descriptor translation table descriptor formats:

- *Long-descriptor translation table first-level and second-level descriptor formats on page B3-1340*
- *Long-descriptor translation table third-level descriptor formats on page B3-1341.*

*Information returned by a translation table lookup on page B3-1320* describes the classification of the non-address fields in the descriptors between *address map control*, *access controls*, and *region attributes*.

### Long-descriptor translation table first-level and second-level descriptor formats

In the Long-descriptor translation tables, the formats of the first-level and second-level descriptors differ only in the size of the block of memory addressed by the block descriptor. A block entry:

- in a first-level table describes the mapping of the associated 1GB input address range
- in a second-level table describes the mapping of the associated 2MB input address range.

Figure B3-14 shows the Long-descriptor first-level and second-level descriptor formats:

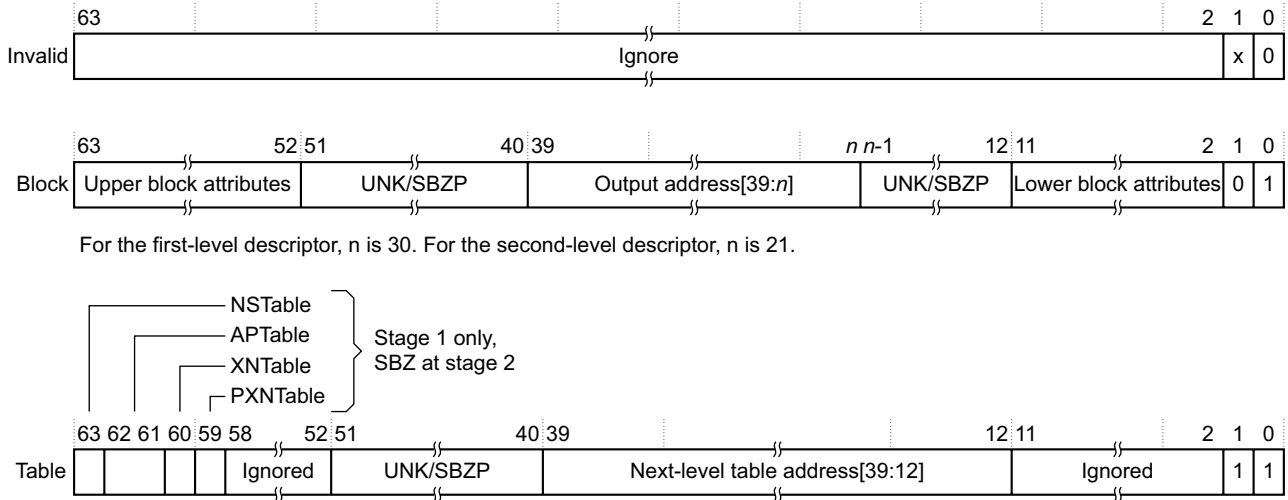

For the first-level descriptor, n is 30. For the second-level descriptor, n is 21.

The first-level descriptor returns the address of the second-level table.  
 The second-level descriptor returns the address of the third-level table.

**Figure B3-14 Long-descriptor first-level and second-level descriptor formats**

#### Descriptor encodings, Long-descriptor first-level and second-level formats

In the Long-descriptor translation tables, the formats of the first-level and second-level descriptors differ only in the size of the block of memory addressed by the block descriptor.

Descriptor bit[0] identifies whether the descriptor is valid, and is 1 for a valid descriptor. If a lookup returns an invalid descriptor, the associated input address is unmapped, and any attempt to access it generates a Translation fault.

Descriptor bit[1] identifies the descriptor type, and is encoded as:

- 0, Block** The descriptor gives the base address of a block of memory, and the attributes for that memory region.
- 1, Table** The descriptor gives the address of the next level of translation table, and for a stage 1 translation, some attributes for that translation.

The other fields in the valid descriptors are:

#### Block descriptor

Gives the base address and attributes of a block of memory:

- for a first-level Block descriptor, bits[39:30] are bits[39:30] of the output address that specifies a 1GB block of memory
- for a second-level Block descriptor, bits[39:21] are bits[39:21] of the output address that specifies a 2MB block of memory.

Bits[63:52, 11:2] provide attributes for the target memory block, see [Memory attributes in the Long-descriptor translation table format descriptors on page B3-1342](#). The position and contents of these bits are identical in the second-level block descriptor and in the third-level page descriptor.



### Table descriptor

Bits[39:12] are bits[39:12] of the address of the required next-level table. Bits[11:0] of the table address are zero:

- for a first-level Table descriptor, this is the address of a second-level table
- for a second-level Table descriptor, this is the address of a third-level table.

For a stage 1 translation only, bits[63:59] provide attributes for the next-level lookup, see [Memory attributes in the Long-descriptor translation table format descriptors on page B3-1342](#).

If the implementation includes the Virtualization Extensions and the translation table defines the Non-secure PL1&0 stage 1 translations, then the output address in the descriptor is the IPA of the target block or table. Otherwise, it is the PA of the target block or table.

### Long-descriptor translation table third-level descriptor formats

Each entry in a third-level table describes the mapping of the associated 4KB input address range.

Figure B3-15 shows the Long-descriptor third-level descriptor formats.

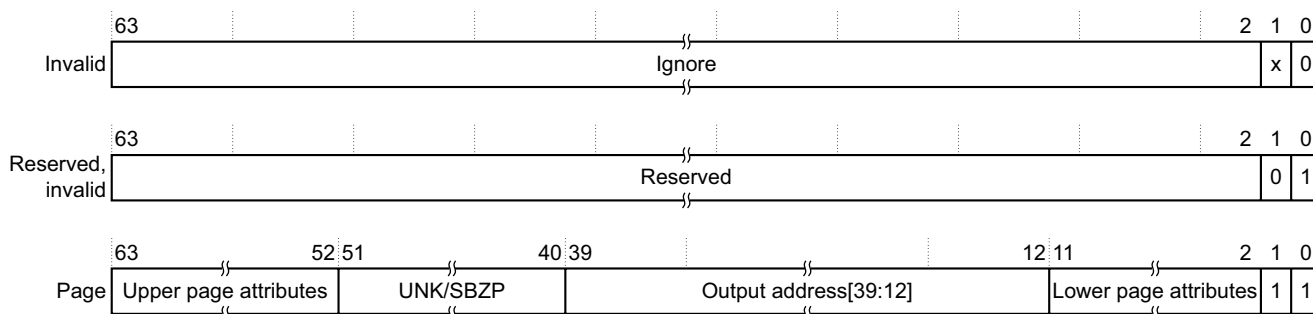

**Figure B3-15 Long-descriptor third-level descriptor formats**

Descriptor bit[0] identifies whether the descriptor is valid, and is 1 for a valid descriptor. If a lookup returns an invalid descriptor, the associated input address is unmapped, and any attempt to access it generates a Translation fault.

Descriptor bit[1] identifies the descriptor type, and is encoded as:

#### 0, Reserved, invalid

Behaves identically to encodings with bit[0] set to 0.

This encoding must not be used in third-level translation tables.

#### 1, Page

Gives the address and attributes of a 4KB page of memory.

At this level, the only valid format is the Page descriptor. The other fields in the Page descriptor are:

#### Page descriptor

Bits[39:12] are bits[39:12] of the output address for a page of memory.

Bits[63:52, 11:2] provide attributes for the target memory page, see [Memory attributes in the Long-descriptor translation table format descriptors on page B3-1342](#). The position and contents of these bits are identical in the first-level block descriptor and in the second-level block descriptor.

If the implementation includes the Virtualization Extensions and the translation table defines the Non-secure PL1&0 stage 1 translations, then the output address in the descriptor is the IPA of the target page. Otherwise, it is the PA of the target page.

### B3.6.2 Memory attributes in the Long-descriptor translation table format descriptors

The memory attributes in the Long-descriptor translation tables are based on those in the Short-descriptor translation table format, with some extensions. *Memory region attributes* on page B3-1366 describes these attributes. In the Long-descriptor translation table format:

- Table entries for stage 1 translations define attributes for the next level of lookup, see *Next-level attributes in stage 1 Long-descriptor Table descriptors*
- Block and page entries define memory attributes for the target block or page of memory. Stage 1 and stage 2 translations have some differences in these attributes, see:
  - *Attribute fields in stage 1 Long-descriptor Block and Page descriptors*
  - *Attribute fields in stage 2 Long-descriptor Block and Page descriptors* on page B3-1343.

#### Next-level attributes in stage 1 Long-descriptor Table descriptors

In a Table descriptor for a stage 1 translation, bits[63:59] of the descriptor define the following attributes for the next-level translation table access:

- NSTable, bit[63]** For memory accesses from Secure state, specifies the security level for subsequent levels of lookup, see *Hierarchical control of Secure or Non-secure memory accesses, Long-descriptor format* on page B3-1344.  
 For memory accesses from Non-secure state, this bit is ignored.
- APTable, bits[62:61]** Access permissions limit for subsequent levels of lookup, see *Hierarchical control of access permissions, Long-descriptor format* on page B3-1357.  
 APTable[0] is reserved, SBZ, in the Non-secure PL2 stage 1 translation tables.
- XNTable, bit[60]** XN limit for subsequent levels of lookup, see *Hierarchical control of instruction fetching, Long-descriptor format* on page B3-1360.
- PXNTable, bit[59]** PXN limit for subsequent levels of lookup, see *Hierarchical control of instruction fetching, Long-descriptor format* on page B3-1360.  
 This bit is reserved, SBZ, in the Non-secure PL2 stage 1 translation tables.

#### Attribute fields in stage 1 Long-descriptor Block and Page descriptors

Block and Page descriptors split the memory attributes into an upper block and a lower block. Figure B3-16 shows the memory attribute fields in these blocks, for a stage 1 translation:

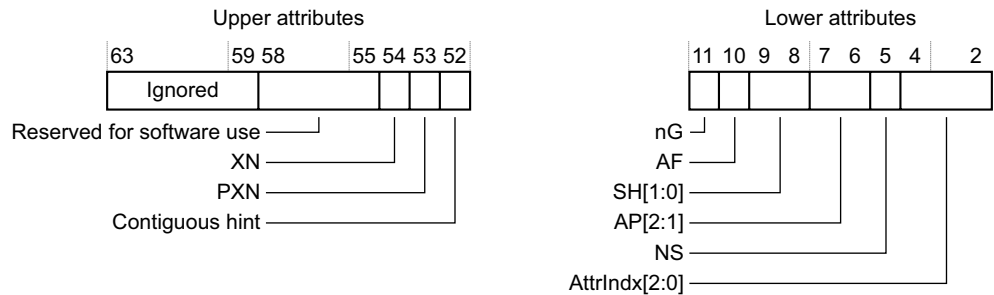

**Figure B3-16** Memory attribute fields in Long-descriptor stage 1 Block and Page descriptors

For a stage 1 descriptor, the attributes are:

- XN, bit[54]** The Execute-never bit. Determines whether the region is executable, see *Execute-never restrictions on instruction fetching* on page B3-1359.

**PXN, bit[53]** The Privileged execute-never bit. Determines whether the region is executable at PL1, see [Execute-never restrictions on instruction fetching on page B3-1359](#).  
 This bit is reserved, SBZ, in the Non-secure PL2 stage 1 translation tables.

**Contiguous hint, bit[52]**

A hint bit indicating that 16 adjacent translation table entries point to contiguous memory regions, see [Contiguous hint on page B3-1373](#).

**nG, bit[11]** The not global bit. Determines how the translation is marked in the TLB, see [Global and process-specific translation table entries on page B3-1378](#).  
 This bit is reserved, SBZ, in the Non-secure PL2 stage 1 translation tables.

**AF, bit[10]** The Access flag, see [The Access flag on page B3-1362](#).

**SH, bits[9:8]** Shareability field, see [Memory region attributes on page B3-1366](#).

**AP[2:1], bits[7:6]**

Access Permissions bits, see [Memory access control on page B3-1356](#).

———— **Note** —————

For consistency with the Short-descriptor translation table formats, the Long-descriptor format defines AP[2:1] as the Access Permissions bits, and does not define an AP[0] bit.

AP[1] is reserved, SBO, in the Non-secure PL2 stage 1 translation tables.

**NS, bit[5]** Non-secure bit. For memory accesses from Secure state, specifies whether the output address is in Secure or Non-secure memory, see [Control of Secure or Non-secure memory access, Long-descriptor format on page B3-1344](#).  
 For memory accesses from Non-secure state, this bit is ignored.

**AttrIndx[2:0], bits[4:2]**

Stage 1 memory attributes index field, for the indicated Memory Attribute Indirection Register, see [Long-descriptor format memory region attributes on page B3-1372](#).

In the upper attributes block, the architecture guarantees that hardware does not alter the fields marked as *Ignored* and *Reserved for software use*. For more information see [Other fields in the Long-descriptor translation table format descriptors on page B3-1373](#).

**Attribute fields in stage 2 Long-descriptor Block and Page descriptors**

Block and Page descriptors split the memory attributes into an upper block and a lower block. [Figure B3-17](#) shows the memory attribute fields in these blocks, for a stage 2 translation:

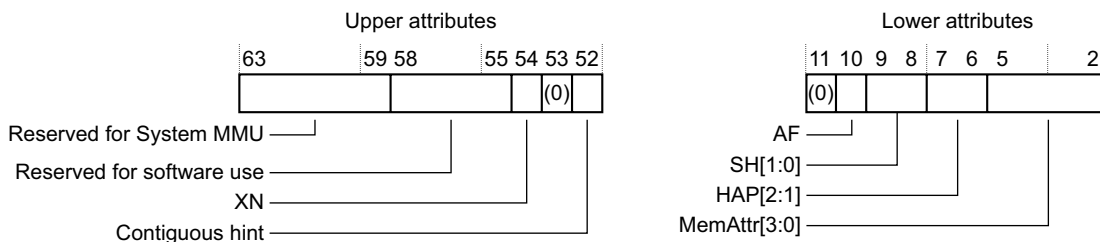

**Figure B3-17 Memory attribute fields in Long-descriptor stage 2 Block and Page descriptors**

For a stage 2 descriptor, the attributes are:

**XN, bit[54]** The Execute-never bit. Determines whether the region is executable, see [Execute-never restrictions on instruction fetching on page B3-1359](#).

**Contiguous hint, bit[52]**

A hint bit indicating that 16 adjacent translation table entries point to contiguous memory regions, see [Contiguous hint on page B3-1373](#).

**AF, bit[10]** The Access flag, see [The Access flag on page B3-1362](#).

**SH, bits[9:8]** Shareability field, see [PL2 control of Non-secure memory region attributes on page B3-1374](#).

**HAP[2:1], bits[7:6]**

Stage 2 Access Permissions bits, see [PL2 control of Non-secure access permissions on page B3-1364](#).

———— **Note** —————

For consistency with the AP[2:1] field, the Long-descriptor format defines HAP[2:1] as the Stage 2 Access Permissions bits, and does not define an HAP[0] bit.

**MemAttr[3:0], bits[5:2]**

Stage 2 memory attributes, see [PL2 control of Non-secure memory region attributes on page B3-1374](#).

In the upper attributes block:

- The field marked as *Reserved for System MMU use* is ignored by a processor that is using the Large Physical Address Extension. When a processor is using this extension, the architecture guarantees that the hardware does not alter this field.
- The architecture guarantees that hardware does not alter the fields marked as *Ignored* and *Reserved for software use*.

For more information see [Other fields in the Long-descriptor translation table format descriptors on page B3-1373](#).

### B3.6.3 Control of Secure or Non-secure memory access, Long-descriptor format

[Access to the Secure or Non-secure physical address map on page B3-1321](#) describes how the NS bit in the translation table entries:

- for accesses from Secure state, determines whether the access is to Secure or Non-secure memory
- is ignored by accesses from Non-secure state.

In the Long-descriptor format:

- the NS bit relates only to the memory block or page at the output address defined by the descriptor
- the descriptors also include an NSTable bit, see [Hierarchical control of Secure or Non-secure memory accesses, Long-descriptor format](#).

The NS and NSTable bits are valid only for memory accesses from Secure state. Memory accesses from Non-secure state ignore the values of these bits.

#### Hierarchical control of Secure or Non-secure memory accesses, Long-descriptor format

For Long-descriptor format table descriptors for stage 1 translations, the descriptor includes an NSTable bit, that indicates whether the table identified in the descriptor is in Secure or Non-secure memory. For accesses from Secure state, the meaning of the NSTable bit is:

**NSTable == 0** The defined table address is in the Secure physical address space. In the descriptors in that translation table, NS bits and NSTable bits have their defined meanings.

**NSTable == 1** The defined table address is in the Non-secure physical address space. Because this table is fetched from the Non-secure address space, the NS and NSTable bits in the descriptors in this table must be ignored. This means that, for this table:

- The value of the NS bit in any block or page descriptor is ignored. The block or page address is refers to Non-secure memory.
- The value of the NSTable bit in any table descriptor is ignored, and the table address refers to Non-secure memory. When this table is accessed, the NS bit in any block or page descriptor is ignored, and all descriptors in the table refer to Non-secure memory.

In addition, an entry fetched in Secure state is treated as non-global if either:

- NSTable is set to 1
- the fetch ignores the values of NS and NSTable, because of a higher-level fetch with NSTable set to 1.

That is, these entries must be treated as if nG==1, regardless of the value of the nG bit. For more information about the nG bit, see [Global and process-specific translation table entries on page B3-1378](#).

———— **Note** —————

- When using the Long-descriptor format, table descriptors are defined only for the first level and second level of lookup.
- Stage 2 translations are performed only for operations in Non-secure state, that can access only the Non-secure address space. Therefore, the stage 2 descriptors do not include NS or NSTable bits.

### B3.6.4 Selecting between TTBR0 and TTBR1, Long-descriptor translation table format

As described in [Determining the translation table base address on page B3-1320](#), two sets of translation tables can be defined for each of the PL1&0 stage 1 translations, and **TTBR0** and **TTBR1** hold the base addresses for the two sets of tables. The Long-descriptor translation table format provides more flexibility in defining the boundary between using **TTBR0** and using **TTBR1**. When a PL1&0 stage 1 MMU is enabled, **TTBR0** is always used. If **TTBR1** is also used then:

- **TTBR1** is used for the top part of the input address range
- **TTBR0** is used for the bottom part of the input address range.

The **TTBCR.T0SZ** and **TTBCR.T1SZ** size fields control the use of **TTBR0** and **TTBR1**, as [Table B3-2](#) shows.

**Table B3-2 Use of TTBR0 and TTBR1, Long-descriptor format**

TTBCR		Input address range using:	
T0SZ	T1SZ	TTBR0	TTBR1
0b000	0b000	All addresses	Not used
$M^a$	0b000	Zero to $(2^{(32-M)}-1)$	$2^{32-M}$ to maximum input address
0b000	$N^a$	Zero to $(2^{32-2(32-N)}-1)$	$2^{32-2(32-N)}$ to maximum input address
$M^a$	$N^a$	Zero to $(2^{(32-M)}-1)$	$2^{32-2(32-N)}$ to maximum input address

a.  $M, N$  must be greater than 0. The maximum possible value for each of T0SZ and T1SZ is 7.

For stage 1 translations, the input address is always a VA, and the maximum possible VA is  $(2^{32}-1)$ .

When address translation is using the Long-descriptor translation table format:

- [Figure B3-18 on page B3-1346](#) shows how, when **TTBCR.T1SZ** is zero, the value of **TTBCR.T0SZ** controls the boundary between VAs that are translated using **TTBR0**, and VAs that are translated using **TTBR1**.

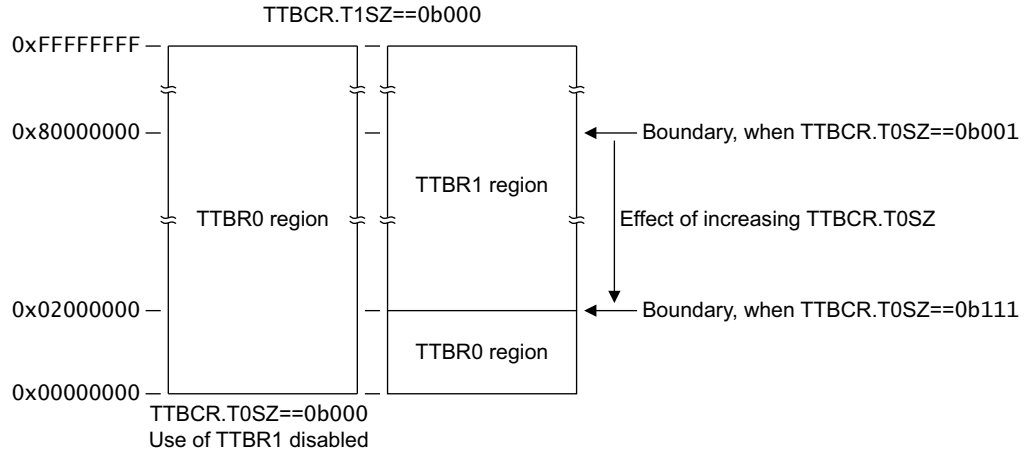

**Figure B3-18 Control of TTBR boundary, when TTBCR.T1SZ is zero**

- [Figure B3-19](#) shows how, when TTBCR.T1SZ is nonzero, the values of TTBCR.T0SZ and TTBCR.T1SZ control the boundaries between VAs that are translated using TTBR0, and VAs that are translated using TTBR1.

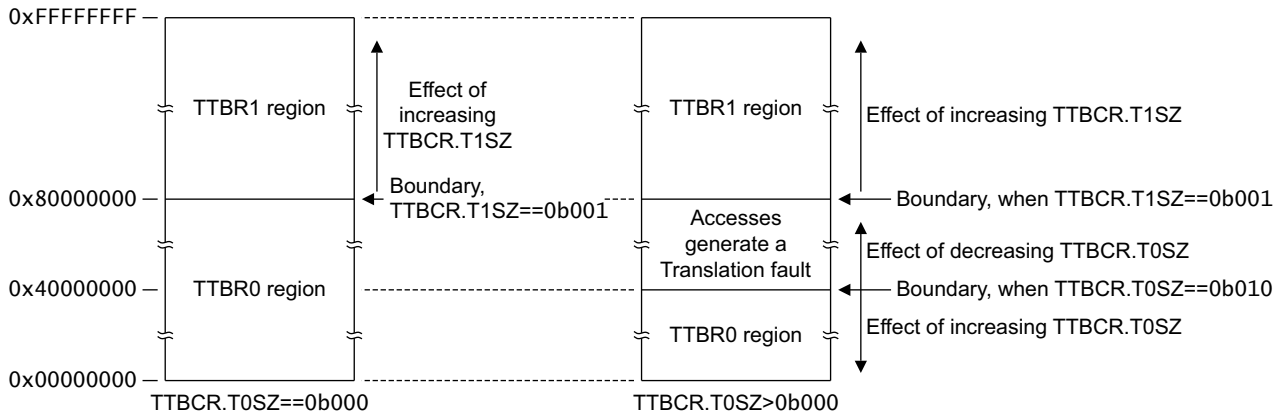

**Figure B3-19 Control of TTBR boundaries, when TTBCR.T1SZ is nonzero**

When T0SZ and T1SZ are both nonzero:

- If both fields are set to 0b001, the boundary between the two regions is 0x80000000. This is identical to having T0SZ set to 0b000 and T1SZ set to 0b001.
- Otherwise, the TTBR0 and TTBR1 regions are non-contiguous. In this case, any attempt to access an address that is in that gap between the TTBR0 and TTBR1 regions generates a Translation fault.

When using the Long-descriptor translation table format:

- The TTBCR contains fields that define memory region attributes for the translation table walk, for each TTBR. These are the SH0, ORGN0, IRGN0, SH1, ORGN1, and IRGN1 bits.
- Each TTBR contains an ASID field, and the TTBCR.A1 field selects which ASID to use.

For this translation table format, [Long-descriptor translation table format address lookup levels on page B3-1348](#) summarizes the lookup levels, and [Translation table walks, when using the Long-descriptor translation table format on page B3-1350](#) describes the possible translations.

## Possible translation table registers programming errors

In all the descriptions in this subsection, the *size of the input address* supported for a PL1&0 stage 1 translation refers to the size specified by a [TTBCR.TxSZ](#) field.

---

### Note

For a PL1&0 stage 1 translation, the input address range can be split so that the lower addresses are translated by [TTBR0](#) and the higher addresses are translated by [TTBR1](#). In this case, each of input address sizes specified by [TTBCR.{T0SZ, T1SZ}](#) is smaller than the total address size supported by the stage of translation.

---

The following are possible errors in the programming of [TTBR0](#), [TTBR1](#), and [TTBCR](#). For the translation of a particular address at a particular stage of translation, either:

- The block size being used to translate the address is larger than the size of the input address supported at a stage of translation used in performing the required translation. This can occur only for the stage 1 translation of the PL1&0 translation regime, and only when either [TTBCR.T0SZ](#) or [TTBCR.T1SZ](#) is zero, meaning there is no gap between the address range translated by [TTBR0](#) and the range translated by [TTBR1](#). In this case, this programming error occurs if a block translated from the region that has [TxSZ](#) set to zero straddles the boundary between the two address ranges. [Example B3-2](#) shows an example of this mis-programming.
- The address range translated by a set of blocks marked as contiguous, by use of the contiguous bit, is larger than the size of the input address supported at a stage of translation used in performing the required translation.

### Example B3-2 Translation table programming error

---

If [TTBCR.T0SZ](#) is programmed to 0 and [TTBCR.T1SZ](#) is programmed to 7, this means:

- [TTBR0](#) translates addresses in the range `0x00000000-0xFDFDFDFD`.
- [TTBR1](#) translates addresses in the range `0xFE000000-0xFFFFFFFF`.

The translation table indicated by [TTBR0](#) might be programmed with a block entry for a 1GB region starting at `0xC0000000`. This covers the address range `0xC0000000-0xFFFFFFFF`, that overlaps the [TTBR1](#) address range. This means this block size is larger than the input address size supported for translations using [TTBR0](#), and therefore this is a programming error.

To understand why this must be a programming error, consider a memory access to address `0xFFFF0000`. According to the [TTBCR.{T0SZ, T1SZ}](#) values, this must be translated using [TTBR1](#). However, the access matches a TLB entry for the translation, using [TTBR0](#), of the block at `0xC0000000`. Hardware is not required to detect that the access to `0xFFFF0000` is being translated incorrectly.

---

In these cases, an implementation might use one of the following approaches:

- Treat such a block, that might be a block within a contiguous set of blocks, as causing a Translation fault, even though the block is valid, and the address accessed within that block is within the size of the input address supported at a stage of translation.
- Treat such a block, that might be a block within a contiguous set of blocks, as not causing a Translation fault, even though the address accessed within that block is outside the size of the input address supported at a stage of translation, provided that both of the following apply:
  - The block is valid.
  - At least one address within the block, or contiguous set of blocks, is within the size of the input address supported at a stage of translation.

### B3.6.5 Long-descriptor translation table format address lookup levels

As stated at the start of this section, because the Long-descriptor translation table format is used for the PL1&0 stage 2 translations, the format must support input addresses of up to 40 bits.

Table B3-3 summarizes the properties of the three levels of address lookup when using this format.

**Table B3-3 Properties of the three levels of address lookup with Long-descriptor translation tables**

Level	Input address		Output address <sup>a</sup>		Number of entries
	Size	Address range <sup>b</sup>	Size	Address range	
First	Up to 512GB	Up to Address[38:0]	1GB	Address[39:30]	Up to 512
Second	Up to 1GB	Up to Address[30:0]	2MB	Address[39:21]	Up to 512
Third	2MB	Address[21:0]	4KB	Address[39:12]	512

- a. Output address when an entry addresses a block of memory or a memory page. If an entry addresses the next level of address lookup it specifies Address[39:12] for the next-level translation table.
- b. Input address range for the translation table. See *Use of concatenated first-level translation tables on page B3-1349* for details of support for a 40-bit input address range.

For first-level and second-level tables, reducing the input address range reduces the number of addresses in the table and therefore reduces the table size. The appropriate Translation Table Control Register specifies the input address range.

Stage 1 translations require an input address range of up to 32 bits, corresponding to VA[31:0]. For these translations:

- for a memory access from a mode other than Hyp mode, the Secure or Non-secure **TTBR0** or **TTBR1** holds the translation table base address, and the Secure or Non-secure **TTBCR** is the control register
- for a memory access from Hyp mode, **HTTBR** holds the translation table base address, and **HTCR** is the control register.

———— **Note** —————

For translations controlled by **TTBR0** and **TTBR1**, if neither Translation Table Base Register has an input address range larger than 1GB, then translation starts at the second level. Together, **TTBR0** and **TTBR1** can still cover the 32-bit VA input address range.

Stage 2 translations require an input address range of up to 40 bits, corresponding to IPA[39:0], and the supported input address size is configurable in the range 25-40 bits. Table B3-3 indicates a requirement for the translation mechanism to support a 39-bit input address range, Address[38:0]. *Use of concatenated translation tables for stage 2 translations* describes how a 40-bit IPA address range is supported. For stage 2 translations:

- **VTBTR** holds the translation table base address, and **VTCCR** is the control register.
- if a supplied input address is larger than the configured input address size, a Translation fault is generated.

#### Use of concatenated translation tables for stage 2 translations

If a stage 2 translation requires 16 entries or fewer in its top-level translation table, it can instead:

- require the corresponding number of concatenated translation tables at the next translation level, aligned to the size of the block of concatenated translation tables
- start the translation at that next translation level.

———— **Note** —————

Stage 2 translations always use the Long-descriptor translation table format.



Use of this translation scheme is:

- Required when the stage 2 translation supports a 40-bit input address range, see [Use of concatenated first-level translation tables](#)
- Supported for a stage 2 translation with an input address range of 31-34 bits, see [Use of concatenated second-level translation tables](#).

———— **Note** —————

This translation scheme:

- avoids the overhead of an additional level of translation
- requires the software that is defining the translation to:
  - define the concatenated translation tables with the required overall alignment
  - program [VTTBR](#) to hold the address of the first of the concatenated translation tables
  - program [VTCR](#) to indicate the required input address range and first lookup level.

**Use of concatenated first-level translation tables**

The Long-descriptor format translation tables provide 9 bits of address resolution at each level of lookup. However, a 40-bit input address range with a translation granularity of 4KB requires a total of 28 bits of address resolution. Therefore, a stage 2 translation that supports a 40-bit input address range requires two concatenated first-level translation tables, together aligned to 8KB, where:

- the table at the address with  $PA[12:0] = 0b000000000000$  defines the translations for input addresses with  $bit[39] = 0$
- the table at the address with  $PA[12:0] = 0b100000000000$  defines the translations for input addresses with  $bit[39] = 1$
- the 8KB alignment requirement means that both table have the same value for  $PA[39:13]$ .

**Use of concatenated second-level translation tables**

A stage 2 translation with an input address range of 31-34 bits can start the translation either:

- with a first-level lookup, accessing a first-level translation table with 2-16 entries
- with a second-level lookup, accessing a set of concatenated second-level translation tables.

[Table B3-4](#) shows these options, for each of the input address ranges that can use this scheme.

———— **Note** —————

Because these are stage 2 translations, the input address range is an IPA range.

**Table B3-4 Possible uses of concatenated translation tables for second-level lookup**

Input address range		Lookup starts at first level	Lookup starts at second level	
IPA range	Size	Required first-level entries	Number of concatenated tables	Required alignment <sup>a</sup>
IPA[30:0]	2 <sup>31</sup> bytes	2	2	8KB
IPA[31:0]	2 <sup>32</sup> bytes	4	4	16KB
IPA[32:0]	2 <sup>33</sup> bytes	8	8	32KB
IPA[33:0]	2 <sup>34</sup> bytes	16	16	64KB

a. Required alignment of the set of concatenated second-level tables.

See also [Determining the required first lookup level for stage 2 translations on page B3-1352](#).

## B3.6.6 Translation table walks, when using the Long-descriptor translation table format

[Figure B3-2 on page B3-1312](#) shows the possible address translations in an Large Physical Address Extension implementation. These are:

### Stage 1 translations

For all stage 1 translations:

- the input address range is up to 32 bits, as determined by either:
  - [TTBCR.T0SZ](#) or [TTBCR.T1SZ](#), for a PL1&0 stage 1 translation
  - [HTCR.T0SZ](#), for a PL2 stage 1 translation
- the output address range is 40 bits.

The stage 1 translations are:

#### Non-secure PL1&0 stage 1 translation

The stage 1 translation for memory accesses from Non-secure modes other than Hyp mode. In an implementation that includes the Virtualization Extensions, this translates a VA to an IPA, otherwise it translates a VA to a PA. For this translation:

- Non-secure [TTBR0](#) or [TTBR1](#) holds the translation table base address
- Non-secure [TTBCR](#) determines which TTBR is used.

#### Non-secure PL2 stage 1 translation

The stage 1 translation for memory accesses from Hyp mode. Supported only if the implementation includes the Virtualization Extensions, and translates a VA to a PA. For this translation, [HTTBR](#) holds the translation table base address.

#### Secure PL1&0 stage 1 translation

The stage 1 translation for memory accesses from Secure modes, translates a VA to a PA. For this translation:

- Secure [TTBR0](#) or [TTBR1](#) holds the translation table base address
- Secure [TTBCR](#) determines which TTBR is used.

### Stage 2 translation

#### Non-secure PL1&0 stage 2 translation

The stage 2 translation for memory accesses from Non-secure modes other than Hyp mode. Supported only if the implementation includes the Virtualization Extensions, and translates an IPA to a PA. For this translation:

- the input address range is 40 bits, as determined by [VTCR.T0SZ](#)
- the output address range depends on the implemented memory system, and is up to 40 bits
- [VTTBR](#) holds the translation table base address
- [VTCR](#) specifies the required input address range, and whether the first lookup is at the first level or at the second level.

The Long-descriptor translation table format provides up to three levels of address lookup, as described in [Long-descriptor translation table format address lookup levels on page B3-1348](#), and the first lookup, in which the MMU reads the translation table base address, is at either the first level or the second level. The following determines the level of the first lookup:

- For a stage 1 translation, the required input address range. For more information see [Determining the required first lookup level for stage 1 translations on page B3-1352](#).
- For a stage 2 translation, the level specified by the [VTCR.SL0](#) field. For more information see [Determining the required first lookup level for stage 2 translations on page B3-1352](#).

**Note**

For a stage 2 translation, the size of the required input address range constrains the `VTCCR.SL0` value.

Figure B3-20 shows how the descriptor address for the first lookup for a translation using the Long-descriptor translation table format is determined from the input address and the translation table base register value. This figure shows the lookup for a translation that starts with a first-level lookup, that translates bits[39:30] of the input address, zero extended if necessary.

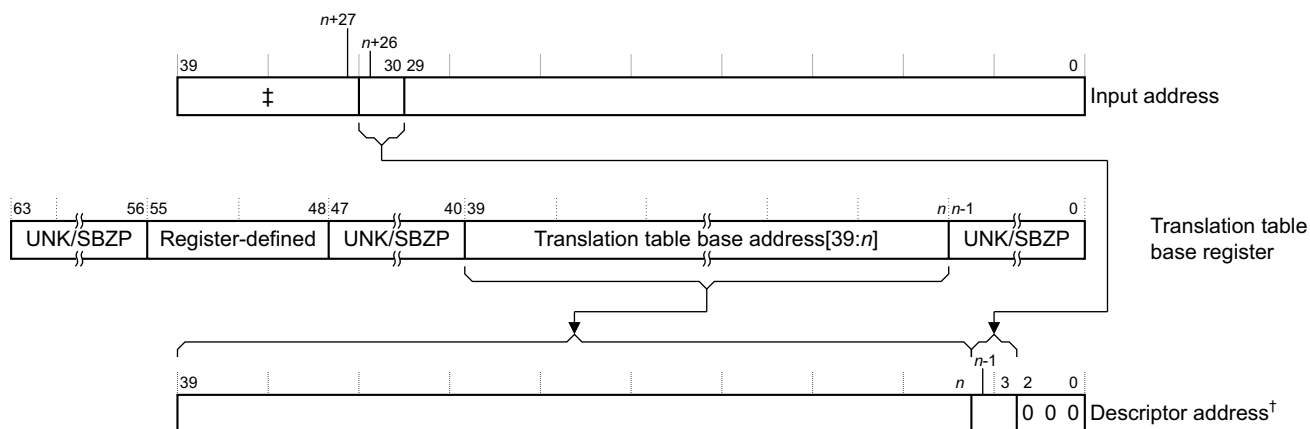

See text for more information about the translation table base register used, and the value of  $n$ .

‡ This field is absent if  $n$  is 13.

† For a Non-secure PL1&0 stage 1 translation, the IPA of the descriptor. Otherwise, the PA of the descriptor.

**Figure B3-20 Long-descriptor first lookup, starting at first level**

For a translation that starts with a first-level lookup, as shown in Figure B3-20:

**For a stage 1 translation**

$n$  is in the range 4-5 and:

- for a memory access from Hyp mode:
  - `HTTBR` is the translation table base register
  - $n=5-HTCR.T0SZ$
- for other accesses:
  - the Secure or Non-secure copy of `TTBR0` or `TTBR1` is the translation table base register
  - $n=5-TTBCR.TxSZ$ , where  $x$  is 0 when using `TTBR0`, and 1 when using `TTBR1`.

**For a stage 2 translation**

$n$  is in the range 4-13 and:

- `VTTBR` is the translation table base register
- $n=5-VTCCR.T0SZ$ .

For a translation that starts with a second-level lookup, the descriptor address is obtained in the same way, except that bits[( $n+17$ ):21] of the input address provide bits[( $n-1$ ):3] of the descriptor address, where:

**For a stage 1 translation**

$n$  is in the range 7-12. As *Determining the required first lookup level for stage 1 translations* on page B3-1352 shows, for a stage 1 translation to start with a second-level lookup, the corresponding `T0SZ` or `T1SZ` field must be 2 or more. This means:

- for a memory access from Hyp mode,  $n=14-HTCR.T0SZ$
- for other memory accesses,  $n=14-TTBCR.TxSZ$ , where  $x$  is 0 when using `TTBR0`, and 1 when using `TTBR1`.

### For a stage 2 translation

$n$  is in the range 7-16. For a stage 2 translation to start with a second-level lookup, `VTCR.SL0` is `0b00`, and  $n=14-VTCR.TOSZ$ .

### Determining the required first lookup level for stage 1 translations

For a stage 1 translation, the required input address range, indicated by a `T0SZ` or `T1SZ` field in a translation table control register, determines the first lookup level. The size of this input address region is  $2^{(32-TxSZ)}$  bytes, and if this size is:

- Less than or equal to  $2^{30}$  bytes, the required start is at the second level, and translation requires two levels of table to map to 4KB pages. This corresponds to a `TxSZ` value of 2 or more.
- More than  $2^{30}$  bytes, the required start is at the first level, and translation requires three levels of table to map to 4KB pages. This corresponds to a `TxSZ` value that is less than 2.

For translations not in Hyp mode, the `TTBCR`:

- splits the 32-bit VA input address range between `TTBR0` and `TTBR1`, see [Selecting between TTBR0 and TTBR1, Long-descriptor translation table format on page B3-1345](#)
- holds the input address range sizes for `TTBR0` and `TTBR1`, in the `TTBCR.T0SZ` and `TTBCR.T1SZ` fields.

For translations in Hyp mode, `HTCR.T0SZ` indicates the size of the required input address range. For example, if this field is `0b000`, it indicates a 32-bit VA input address range, and translation lookup must start at the first level.

### Determining the required first lookup level for stage 2 translations

For a stage 2 translation, the output address range from the stage 1 translations determines the required input address range for the stage 2 translation. The permitted values of `VTCR.SL0` are:

- `0b00` Stage 2 translation lookup must start at the second level.
- `0b01` Stage 2 translation lookup must start at the first level.

`VTCR.T0SZ` must indicate the required input address range. The size of the input address region is  $2^{(32-T0SZ)}$  bytes.

#### ———— Note —————

`VTCR.T0SZ` holds a four-bit signed integer value, meaning it supports values from -8 to 7. This is different from the other translation control registers, where `TnSZ` holds a three-bit unsigned integer, supporting values from 0 to 7.

The programming of `VTCR` must follow the constraints shown in [Table B3-5](#), otherwise behavior is UNPREDICTABLE. The table also shows how the `VTCR.SL0` and `VTCR.T0SZ` values determine the `VTTBR.BADDR` field width.

**Table B3-5 Input address range constraints on programming `VTCR`**

<code>VTCR.SL0</code>	<code>VTCR.T0SZ</code>	Input address range, R	First lookup level	<code>BADDR[39:x]</code> width <sup>a</sup>
<code>0b00</code>	2 to 7	$R \leq 2^{30}$ bytes	Second	[39:12] to [39:7]
<code>0b00</code>	-2 to 1	$2^{30} < R \leq 2^{34}$ bytes	Second	[39:16] to [39:13]
<code>0b01</code>	-2 to 1		First	[39:7] to [39:4]
<code>0b01</code>	-8 to -3	$2^{34} < R$	First	[39:13] to [39:8]

a. The first range corresponds to the first `T0SZ` value, the second range to the second `T0SZ` value.

Where necessary, the first lookup level provides multiple concatenated translation tables, as described in [Use of concatenated second-level translation tables on page B3-1349](#). This section also gives more information about the alternatives, shown in [Table B3-5](#), when R is in the range  $2^{31}-2^{34}$ .

## Full translation flows for Long-descriptor format translation tables

In a translation table walk, only the first lookup uses the translation table base address from the appropriate Translation table base register. Subsequent lookups use a combination of address information from:

- the table descriptor read in the previous lookup
- the input address.

The following sections describe full Long-descriptor format translation flows, down to an entry for a 4KB page:

- [The address and Properties fields shown in the translation flows](#)
- [Full translation flow, starting at first-level lookup on page B3-1354](#)
- [Full translation flow, starting at second-level lookup on page B3-1355.](#)

### **The address and Properties fields shown in the translation flows**

On an implementation that includes the Virtualization Extensions, for the Non-secure PL1&0 stage 1 translation:

- any descriptor address is the IPA of the required descriptor
- the final output address is the IPA of the block or page.

In these cases, a PL1&0 stage 2 translation is performed to translate the IPA to the required PA.

For all other translations, the final output address is the PA of the block or page, and any descriptor address is the PA of the descriptor.

*Properties* indicates register or translation table fields that return information, other than address information, about the translation or the targeted memory region. For more information see [Information returned by a translation table lookup on page B3-1320](#), and the description of the register or translation table descriptor.

For translations using the Long-descriptor translation table format, [Long-descriptor translation table format descriptors on page B3-1339](#) describes the descriptors formats.

**Full translation flow, starting at first-level lookup**

Figure B3-21 shows the complete translation flow for a stage 1 translation table walk that starts at a first-level lookup. For more information about the fields shown in the figure see *The address and Properties fields shown in the translation flows on page B3-1353.*

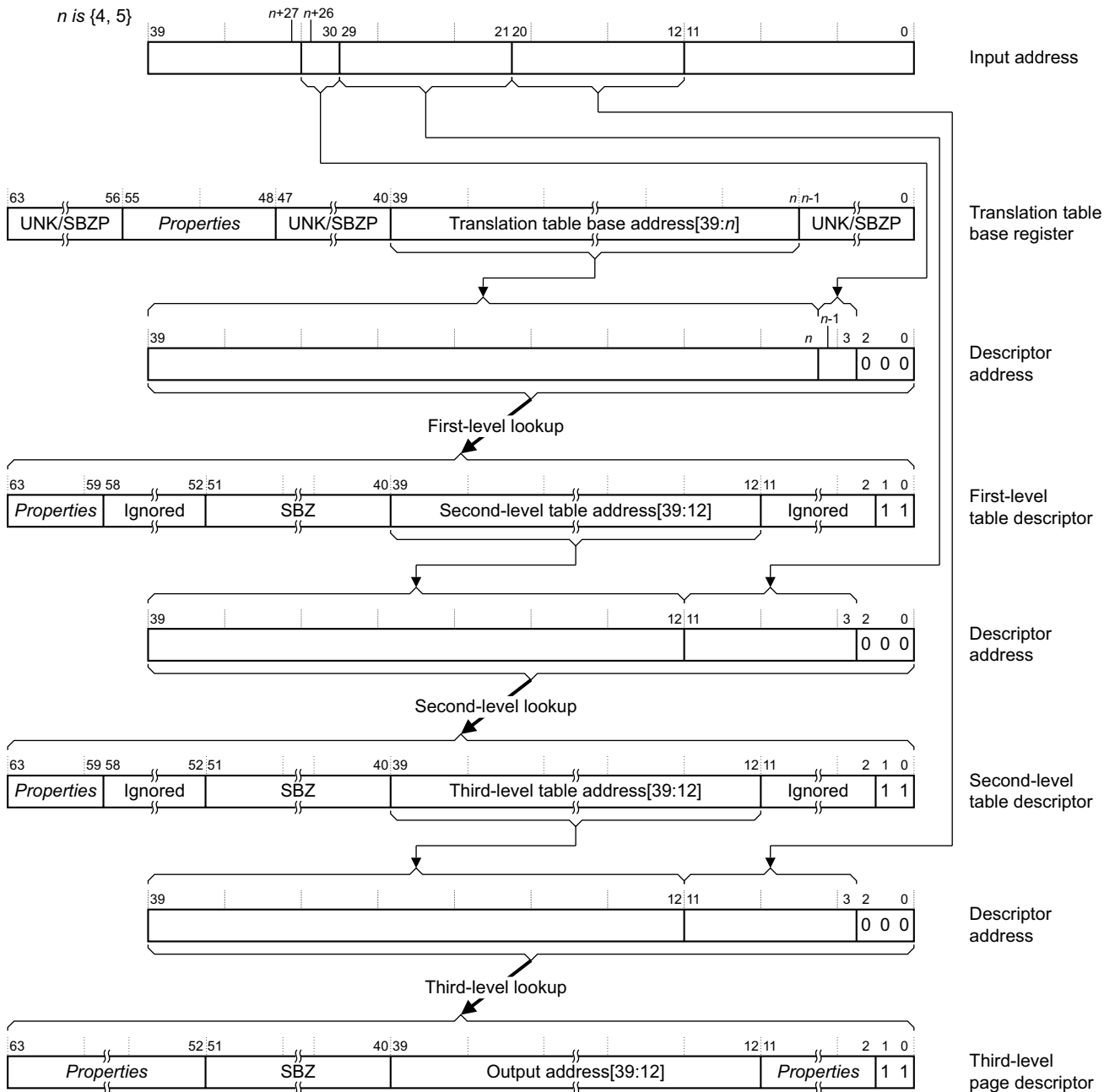

For details of *Properties* fields, see the register or descriptor description.

**Figure B3-21 Complete Long-descriptor format stage 1 translation, starting at first level**

If the first-level lookup or second-level lookup returns a block descriptor then the translation table walk completes at that level.

A stage 2 translation that starts at a first-level lookup differs from the translation shown in [Figure B3-21](#) on [page B3-1354](#) only as follows:

- the possible values of  $n$  are 4-13, to support an input address of between 31 and 40 bits
- a descriptor and output addresses are always the PAs.

**Full translation flow, starting at second-level lookup**

[Figure B3-22](#) shows the complete translation flow for a stage 1 translation table walk that starts at a second-level lookup. For more information about the fields shown in the figure see [The address and Properties fields shown in the translation flows](#) on [page B3-1353](#).

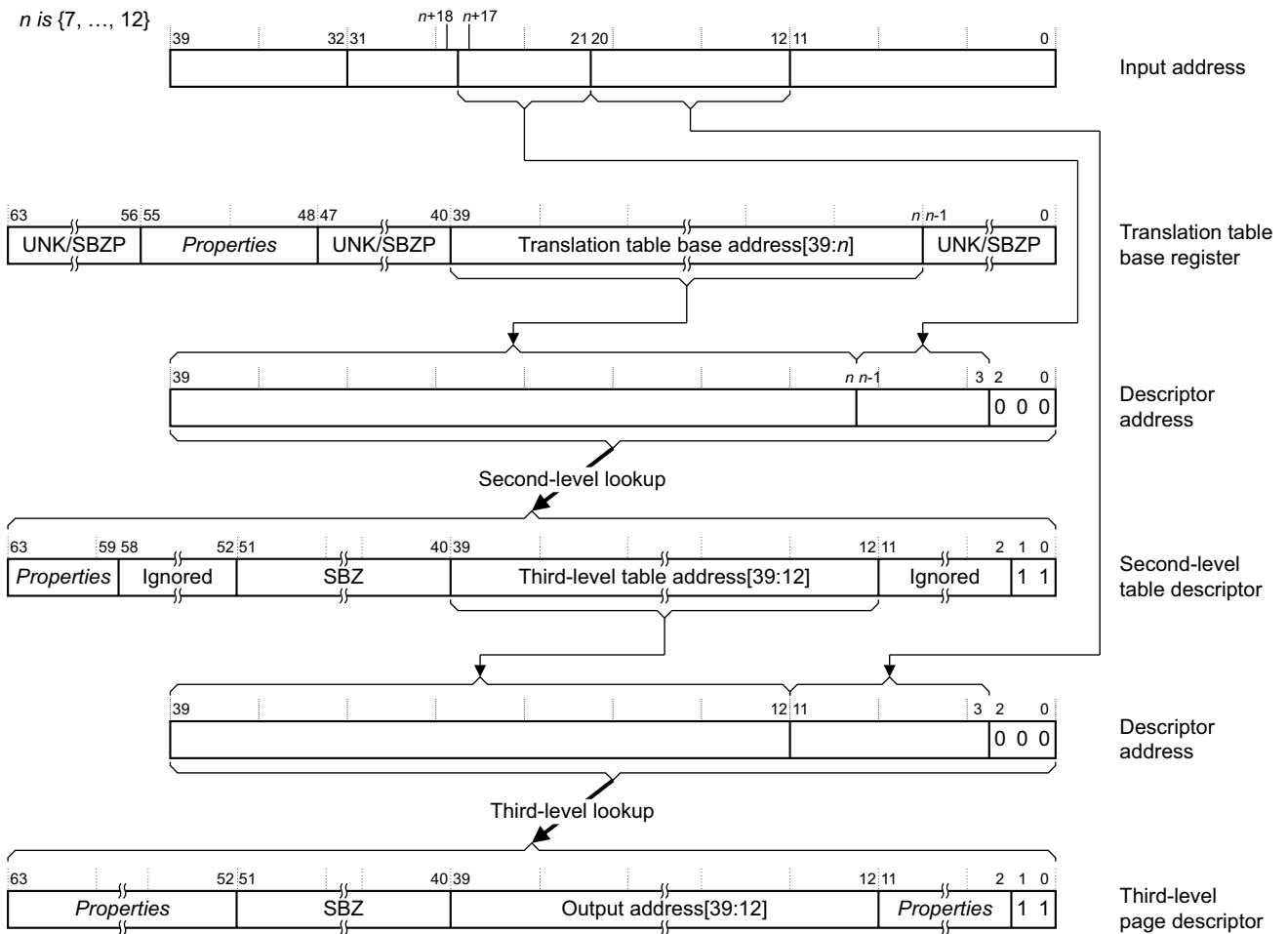

For details of *Properties* fields, see the register or descriptor description.

**Figure B3-22 Complete Long-descriptor format stage 1 translation, starting at second level**

If the second-level lookup returns a block descriptor then the translation table walk completes at that level.

A stage 2 translation that starts at a second-level lookup differs from the translation shown in [Figure B3-22](#) only as follows:

- the possible values of  $n$  are 7-16, to support an input address of up to 34 bits
- the descriptor and output addresses are always PAs.

## B3.7 Memory access control

In addition to an output address, a translation table entry that refers to page or region of memory includes fields that define properties of the target memory region. *Information returned by a translation table lookup on page B3-1320* describes the classification of those fields as address map control, access control, and memory attribute fields. The access control fields, described in this section, determine whether the processor, in its current state, is permitted to perform the required access to the output address given in the translation table descriptor. If a translation stage does not permit the access then an MMU fault is generated for that translation stage, and no memory access is performed.

The following sections describe the memory access controls:

- [Access permissions](#)
- [Execute-never restrictions on instruction fetching on page B3-1359](#)
- [Domains, Short-descriptor format only on page B3-1362](#)
- [The Access flag on page B3-1362](#)
- [PL2 control of Non-secure access permissions on page B3-1364.](#)

### B3.7.1 Access permissions

#### ———— Note ————

This section gives a general description of memory access permissions. In an implementation that includes the Virtualization Extensions, software executing at PL1 in Non-secure state can see only the access permissions defined by the Non-secure PL1&0 stage 1 translations. However, software executing at PL2 can modify these permissions, as described in [PL2 control of Non-secure access permissions on page B3-1364](#). This modification is invisible to Non-secure software executing at PL1 or PL0.

Access permission bits in a translation table descriptor control access to the corresponding memory region. The Short-descriptor translation table format supports two options for defining the access permissions:

- three bits, AP[2:0], define the access permissions
- two bits, AP[2:1], define the access permissions, and AP[0] can be used as an Access flag.

SCTLR.AFE selects the access permissions option. Setting this bit to 1, to enable the Access flag, also selects use of AP[2:1] to define access permissions.

The Long-descriptor translation table format uses only AP[2:1] to control the access permissions, and provides an AF bit for use as an Access flag. This means the VMSA behaves as if SCTLR.AFE is set to 1, regardless of the value that software has written to this bit.

#### ———— Note ————

When use of the Long-descriptor format is enabled, SCTLR.AFE is UNK/SBOP.

From the introduction of the Large Physical Address Extension, ARM deprecates any use of the AP[2:0] scheme for defining access permissions, see [Deprecations relating to using the AP\[2:0\] scheme for defining MMU access permissions on page AppxI-2476](#).

[The Access flag on page B3-1362](#) describes the Access flag, for both translation table formats.

The XN and PXN bits provide additional access controls for instruction fetches, see [Execute-never restrictions on instruction fetching on page B3-1359](#).

An attempt to perform a memory access that the translation table access permission bits do not permit generates a Permission fault, for the corresponding stage of translation. However, when using the Short-descriptor translation table format, it generates the fault only if the access is to memory in the Client domain, see [Domains, Short-descriptor format only on page B3-1362](#).



———— **Note** ————

In an implementation that includes the Virtualization Extensions, memory accesses made in Non-secure state at PL1 or PL0 are subject to two stages of translation. Each stage of translation has its own, independent, fault checking. Fault handling is different for the two stages, see [Exception reporting in a VMSA implementation on page B3-1409](#).

The following sections describe the two access permissions models:

- [AP\[2:1\] access permissions model](#)
- [AP\[2:0\] access permissions control, Short-descriptor format only on page B3-1358](#). This section includes some information on access permission control in earlier versions of the ARM VMSA.

### AP[2:1] access permissions model

———— **Note** ————

Some documentation describes this as the *simplified access permissions* model.

This access permissions model is used if the translation is either:

- using the Long-descriptor translation table format
- using Short-descriptor translation table format, and the `SCTLR.AFE` bit is set to 1.

In this model:

- One bit, AP[2], selects between read-only and read/write access.
- A second bit, AP[1], selects between Application level (PL0) and System level (PL1) control. For the Non-secure PL2 stage 1 translations, AP[1] is SBO.

In the ARM architecture, this model permits four access combinations:

- read-only at all privilege levels
- read/write at all privilege levels
- read-only at PL1, no access by software executing at PL0
- read/write at PL1, no access by software executing at PL0.

[Table B3-6](#) shows this access control model.

**Table B3-6 VMSAv7 AP[2:1] access permissions model**

AP[2], disable write access	AP[1], enable unprivileged access	Access
0	0 <sup>a</sup>	Read/write, only at PL1
0	1	Read/write, at any privilege level
1	0 <sup>a</sup>	Read-only, only at PL1
1	1	Read-only, at any privilege level

a. Not valid for Non-secure PL2 stage 1 translation tables. AP[1] is SBO in these tables.

#### **Hierarchical control of access permissions, Long-descriptor format**

The Long-descriptor translation table format introduces a mechanism that entries at one level of translation table lookup can use to set limits on the permitted entries at subsequent levels of lookup. This applies to the access permissions, and also to the restrictions on instruction fetching described in [Hierarchical control of instruction fetching, Long-descriptor format on page B3-1360](#).

The restrictions apply only to subsequent levels of lookup at the same stage of translation. The `APTable[1:0]` field restricts the access permissions, as [Table B3-7 on page B3-1358](#) shows.

As stated in the table footnote, for the Non-secure PL2 stage 1 translation tables, `APTable[0]` is reserved, SBZ.

**Table B3-7 Effect of APTable[1:0] on subsequent levels of lookup**

APTable[1:0]	Effect
00	No effect on permissions in subsequent levels of lookup.
01 <sup>a</sup>	Access at PL0 not permitted, regardless of permissions in subsequent levels of lookup.
10	Write access not permitted, at any privilege level, regardless of permissions in subsequent levels of lookup.
11 <sup>a</sup>	Regardless of permissions in subsequent levels of lookup: <ul style="list-style-type: none"> <li>• write access not permitted, at any privilege level</li> <li>• read access not permitted at PL0.</li> </ul>

a. Not valid for the Non-secure PL2 stage 1 translation tables. In those tables, APTable[0] is SBZ.

**Note**

The APTable[1:0] settings are combined with the translation table access permissions in the translation tables descriptors accessed in subsequent levels of lookup. They do not restrict or change the values entered in those descriptors.

The Long-descriptor format provides APTable[1:0] control only for the stage 1 translations. The corresponding bits are SBZ in the stage 2 translation table descriptors.

When APTable[1:0] is not set to 0b00, its effects might be held in one or more TLB entries. Therefore, a change to APTable[1:0] might require coarse-grained invalidation of the TLB to ensure that the effect of the change is visible to subsequent memory transactions.

**AP[2:0] access permissions control, Short-descriptor format only**

This access permissions model applies when using the Short-descriptor translation tables format, and the SCTLR.AFE bit is set to 0. Table B3-8 shows this access permissions model.

When SCTLR.AFE is set to 0, ensuring that the AP[0] bit is always set to 1 effectively changes the access model to the simpler model described in AP[2:1] access permissions model on page B3-1357.

Table B3-8 shows the full AP[2:0] access permissions model:

**Table B3-8 VMSAv7 MMU access permissions**

AP[2]	AP[1:0]	PL1 and PL2 access	Unprivileged access	Description
0	00	No access	No access	All accesses generate Permission faults
	01	Read/write	No access	Access only at PL1 or higher
	10	Read/write	Read-only	Writes at PL0 generate Permission faults
	11	Read/write	Read/write	Full access
1	00	-	-	Reserved
	01	Read-only	No access	Read-only, only at PL1 or higher
	10	Read-only	Read-only	Read-only at any privilege level, deprecated <sup>a</sup>
	11	Read-only	Read-only	Read-only at any privilege level <sup>b</sup>

a. From VMSAv7, ARM strongly recommends use of the 0b11 encoding for Read-only at any privilege level.  
 b. This mapping is introduced in VMSAv7, and is reserved in VMSAv6.

---

**Note**

- Before VMSAv7, the [SCTLR.S](#) and [SCTLR.R](#) bits also affect the access permissions. For more information, see [Translation attributes on page AppxO-2605](#).
  - VMSAv7 supports the full set of access permissions shown in [Table B3-8 on page B3-1358](#) only when [SCTLR.AFE](#) is set to 0. When [SCTLR.AFE](#) is set to 1, the only supported access permissions are those described in [AP\[2:1\] access permissions model on page B3-1357](#).
  - Some documentation describes the AP[2] bit in the translation table entries as the APX bit.
- 

## B3.7.2 Execute-never restrictions on instruction fetching

Execute-never (XN) controls provide an additional level of control on memory accesses permitted by the access permissions settings. These controls are:

### XN, Execute-never

When the XN bit is 1, a Permission fault is generated if the processor attempts to execute an instruction fetched from the corresponding memory region. However, when using the Short-descriptor translation table format, the fault is generated only if the access is to memory in the Client domain, see [Domains, Short-descriptor format only on page B3-1362](#). A processor can execute instructions from a memory region only if the access permissions for its current state permit read access, and the XN bit is set to 0.

### PXN, Privileged execute-never

When the PXN bit is 1, a Permission fault is generated if the processor is executing at PL1 and attempts to execute an instruction fetched from the corresponding memory region. As with the XN bit, when using the Short-descriptor translation table format, the fault is generated only if the access is to memory in the Client domain.

In both the Short-descriptor format and the Long-descriptor format translation tables, all descriptors for memory blocks and pages always include an XN bit.

Support for the PXN bit is as follows:

- The Long-descriptor translation table formats always include the PXN bit.
- An implementation that includes the Large Physical Address Extension must:
  - support the use of the PXN bit
  - use the Short-descriptor translation table formats that include the PXN bit.
- On an implementation that does not include the Large Physical Address Extension, support for use of the PXN bit is OPTIONAL, and:
  - if use of the PXN bit is supported, the Short-descriptor translation table formats include the PXN bit
  - otherwise, the Short-descriptor translation table formats do not include the PXN bit.

[Short-descriptor translation table first-level descriptor formats on page B3-1326](#) describes how support for the PXN bit affects the Short-descriptor translation table formats.

---

**Note**

An implementation that does not include the Large Physical Address Extension always uses the Short-descriptor translation table formats.

---

In the Non-secure PL2 stage 1 translation tables, the PXN bit is reserved, SBZ.

In addition, the Virtualization Extensions provide controls that enforce execute-never restrictions, regardless of the settings in the translation tables. [Execute-never controls provided by the Virtualization Extensions on page B3-1361](#) describes these controls.

The execute-never controls apply also to speculative instruction fetching. This means a speculative instruction fetch from a memory region that is execute-never at the current level of privilege is prohibited.

The XN control means that, when the MMU is enabled, the processor can fetch, or speculatively fetch, an instruction from a memory location only if all of the following apply:

- If using the Short-descriptor translation table format, the translation table descriptor for the location does not indicate that it is in a No access domain.
- If using the Long-descriptor translation table format, or using the Short descriptor format and the descriptor indicates that the location is in a Client domain, in the descriptor for the location the following apply:
  - XN is set to 0
  - the access permissions permit a read access from the current processor mode
- No other Prefetch Abort condition exists.

---

**Note**

- The PXN control applies to the processor privilege when it attempts to execute the instruction. In an implementation that fetches instructions speculatively, this might not be the privilege when the instruction was prefetched. Therefore, the architecture does not require the PXN control to prevent instruction fetching.
- Although the execute-never controls apply to speculative fetching, on a speculative instruction fetch from an execute-never location, no Permission fault is generated unless the processor attempts to execute the instruction fetched from that location. This means that, if a speculative fetch from an execute-never location is attempted, but there is no attempt to execute the corresponding instruction, a Permission fault is not generated.
- The software that defines a translation table must mark any region of memory that is read-sensitive as execute-never, to avoid the possibility of a speculative fetch accessing the memory region. For example, it must mark any memory region that corresponds to a read-sensitive peripheral as Execute-never.
- When using the Short-descriptor translation table format, the XN attribute is not checked for domains marked as Manager. Therefore, the system must not include read-sensitive memory in domains marked as Manager, because the XN bit does not prevent speculative fetches from a Manager domain.

---

When no MMU for the translation regime is enabled, memory regions cannot have XN or PXN attributes assigned. [Behavior of instruction fetches when all associated MMUs are disabled on page B3-1316](#) describes how disabling all MMUs affects instruction fetching.

### Hierarchical control of instruction fetching, Long-descriptor format

The Long-descriptor translation table format introduces a mechanism that entries at one level of translation tables lookup can use to set limits on the permitted entries at subsequent levels of lookup. This applies to the restrictions on instruction fetching, and also to the access permissions described in [Hierarchical control of access permissions, Long-descriptor format on page B3-1357](#).

The restrictions apply only to subsequent levels of lookup at the same stage of translation, and:

- XNTable restricts the XN control:
  - when XNTable is set to 1, the XN bit is treated as 1 in all subsequent levels of lookup, regardless of the actual value of the bit
  - when XNTable is set to 0 it has no effect.
- PXNTable restricts the PXN control:
  - when PXNTable is set to 1, the PXN bit is treated as 1 in all subsequent levels of lookup, regardless of the actual value of the bit
  - when PXNTable is set to 0 it has no effect.

———— **Note** ————

The XNTable and PXNTable settings are combined with the XN and PXN bits in the translation table descriptors accessed at subsequent levels of lookup. They do not restrict or change the values entered in those descriptors.

The XNTable and PXNTable controls are provided only in the Long-descriptor translation table format, and only for stage 1 translations. The corresponding bits are SBZ in the stage 2 translation table descriptors.

When XNTable, or PXNTable, is set to 1, its effects might be held in one or more TLB entries. Therefore, a change to XNTable or PXNTable might require coarse-grained invalidation of the TLB to ensure that the effect of the change is visible to subsequent memory transactions.

### Execute-never controls provided by the Virtualization Extensions

The Virtualization Extensions provide additional controls that force memory regions to be treated as execute-never, regardless of the settings in the appropriate translation table descriptors. The following subsections describe these controls:

- [Restriction on Secure instruction fetch](#)
- [Preventing execution from writable locations](#).

#### Restriction on Secure instruction fetch

The Virtualization Extensions add a Secure instruction fetch bit, `SCR.SIF`. When this bit is set to 1, any attempt in Secure state to execute an instruction fetched from Non-secure physical memory causes a Permission fault. As with all Permission fault checking, when using the Short-descriptor format translation tables the check applies only to Client domains, see [Access permissions on page B3-1356](#).

ARM expects `SCR.SIF` to be static during normal operation. In particular, whether the TLB holds the effect of the `SIF` bit is IMPLEMENTATION DEFINED. The generic sequence to ensure visibility of a change to the `SIF` bit is:

```

Change the SCR.SIF bit
ISB          ; This ensures synchronization of the change
Invalidate entire TLB
DSB          ; This completes the TLB Invalidation
ISB          ; This ensures instruction synchronization
  
```

#### Preventing execution from writable locations

The Virtualization Extensions add control bits that, when the corresponding stage 1 MMU is enabled, force writable memory to be treated as XN, regardless of the setting of the XN bit:

- For Secure and Non-secure PL1&0 stage 1 translations, when `SCTLR.WXN` is set to 1, all regions that are writable at stage 1 of the address translation are treated as XN.
- For Non-secure PL2 stage 1 translations, when `HSCTLR.WXN` is set to 1, all regions that are writable at stage 1 of the address translation are treated as XN.
- For Secure and Non-secure PL1&0 stage 1 translations, when `SCTLR.UWXN` is set to 1, an instruction fetch is treated as accessing a PXN region if it accesses a region that software executing at PL0 can write to.

For more information about the control bits see [SCTLR, System Control Register; VMSA on page B4-1705](#) and [HSCTLR, Hyp System Control Register; Virtualization Extensions on page B4-1590](#).

———— **Note** ————

Setting a `WXN` or `UWXN` bit to 1 changes the interpretation of the translation table entry, overriding a zero value of an XN or PXN field. It does not cause any change to the translation table entry.

For any given virtual machine, ARM expects `WXN` and `UWXN` to remain static in normal operation. In particular, it is IMPLEMENTATION DEFINED whether TLB entries associated with a particular VMID reflect the effect of the values of these bits. A generic sequence to ensure synchronization of a change to these bits, when that change is made without a corresponding change of VMID, is:

Change the WXN or UWXN bit  
ISB ; This ensures synchronization of the change  
Invalidate entire TLB of associated entries  
DSB ; This completes the TLB Invalidation  
ISB ; This ensures instruction synchronization

As with all Permission fault checking, if the stage 1 translation is using the Short-descriptor translation table format, the permission checks are performed only for Client domains. For more information see [Access permissions on page B3-1356](#).

For more information about address translation see [About address translation on page B3-1311](#).

### B3.7.3 Domains, Short-descriptor format only

A domain is a collection of memory regions. The Short-descriptor translation table format supports 16 domains, and requires the software that defines a translation table to assign each VMSA memory region to a domain. When using the Short-descriptor format:

- First-level translation table entries for Page tables and Sections include a domain field.
- Translation table entries for Supersections do not include a domain field. The Short-descriptor format defines Supersections as being in domain 0.
- Second-level translation table entries inherit a domain setting from the parent first-level Page table entry.
- Each TLB entry includes a domain field.

The domain field specifies which of the 16 domains the entry is in, and a two-bit field in the [DACR](#) defines the permitted access for each domain. The possible settings for each domain are:

- No access** Any access using the translation table descriptor generates a Domain fault.
- Clients** On an access using the translation table descriptor, the access permission attributes are checked. Therefore, the access might generate a Permission fault.
- Managers** On an access using the translation table descriptor, the access permission attributes are not checked. Therefore, the access cannot generate a Permission fault.

See [The MMU fault-checking sequence on page B3-1398](#) for more information about how, when using the Short-descriptor translation table format, the Domain attribute affects the checking of the other attributes in the translation table descriptor.

#### ———— Note ————

A single program might:

- be a Client of some domains
- be a Manager of some other domains
- have no access to the remaining domains.

The Long-descriptor translation table format does not support domains. When a stage of translation is using this format, all memory is treated as being in a Client domain, and the settings in the [DACR](#) are ignored.

### B3.7.4 The Access flag

The Access flag indicates when a page or section of memory is accessed for the first time since the Access flag in the corresponding translation table descriptor was set to 0:

- If address translation is using the Short-descriptor translation table format, it must set [SCTLR.AFE](#) to 1 to enable use of the Access flag, see [SCTLR, System Control Register, VMSA on page B4-1705](#). Setting this bit to 1 redefines the AP[0] bit in the translation table descriptors as an Access flag, and limits the access permissions information in the translation table descriptors to AP[2:1], as described in [AP\[2:1\] access permissions model on page B3-1357](#).

---

**Note**

ARMv6K introduces the Access flag mechanism. In earlier versions of the architecture, the `SCTLR.AFE` bit is `RAZ/WI`. For more information see *CP15 c1, System Control Register, SCTLR* on page `AppxL-2528`.

---

- The Long-descriptor format always supports an Access flag bit in the translation table descriptors, and address translation using this format behaves as if `SCTLR.AFE` is set to 1, regardless of the value of that bit.

The Access flag can be managed by software or by hardware. However, support for hardware management of the Access flag is `OPTIONAL` and deprecated. The following subsections describe the management options:

- *Software management of the Access flag*
- *Hardware management of the Access flag.*

### Software management of the Access flag

An implementation that requires software to manage the Access flag generates an Access flag fault whenever a translation table entry with the Access flag set to 0 is read into the TLB

---

**Note**

When using the Short-descriptor translation table format, Access flag faults are generated only if `SCTLR.AFE` is set to 1, to enable use of a translation table descriptor bit as an Access flag.

---

The Access flag mechanism expects that, when an Access flag fault occurs, software resets the Access flag to 1 in the translation table entry that caused the fault. This prevents the fault occurring the next time that memory location is accessed. Entries with the Access flag set to 0 are never held in the TLB, meaning software does not have to flush the entry from the TLB after setting the flag.

### Hardware management of the Access flag

For the Secure and Non-secure PL1&0 stage 1 translations, an implementation can provide hardware management of the Access flag. In this case, if a translation table entry with the Access flag set to 0 is read into the TLB, the hardware writes 1 to the Access flag bit of the translation table entry in memory.

An implementation that provides hardware management of the Access flag for the Secure and Non-secure PL1&0 stage 1 translations:

- Uses the HW Access flag field, `ID_MMFR2[31:28]`, to indicate this implementation choice.
- Implements the `SCTLR.HA` bit. This bit must be set to 1 to enable hardware management of the Access flag.

---

**Note**

When using the Short-descriptor translation table format, hardware management of the Access flag is performed only if both:

- `SCTLR.AFE` is set to 1, to enable use of an Access flag
- `SCTLR.HA` is set to 1, to enable hardware management of the Access flag.

The Banking of `SCTLR` means that these bits are defined independently for the Secure and Non-secure address translations.

---

When hardware management of the Access flag, is enabled for a stage of address translation, no Access flag faults are generated for the corresponding translations.

Any implementation of hardware management of the Access flag must ensure that any software changes to the translation table are not overwritten. The architecture does not require software that changes translation table entries to use interlocked operations. The hardware management mechanisms for the Access flag must prevent any loss of data written to translation table entries that might occur when, for example, a write by another processor occurs between the read and write phases of a translation table walk that updates the Access flag.



Architecturally, an operating system that uses the Access flag must support the software faulting option that generates Access flag faults. This provides compatibility between systems that include a hardware implementation of the Access flag and those systems that do not implement this feature.

ARM deprecates any use of the `SCTLR.HA` bit. That is, in an implementation where this bit is RW, it deprecates setting this bit to 1 to enable hardware management of the Access flag.

Hardware management of the Access flag is never supported for:

- Non-secure PL1&0 stage 2 translations
- Non-secure PL2 stage 1 translations.

### B3.7.5 PL2 control of Non-secure access permissions

Non-secure software executing at PL2 controls two sets of translation tables, both of which use the Long-descriptor translation table format:

- The translation tables that control the Non-secure PL2 stage 1 translations. These map VAs to PAs, for memory accesses made when executing in Non-secure state at PL2, and are indicated and controlled by the `HTTBR` and `HTCR`.

These translations have similar access controls to other Non-secure stage 1 translations using the Long-descriptor translation table format, as described in:

- [AP\[2:1\] access permissions model on page B3-1357](#)
- [Execute-never restrictions on instruction fetching on page B3-1359](#).

The differences from the Non-secure stage 1 translations are that:

- the `APTable[0]`, `PXNTable`, and `PXN` bits are reserved, `SBZ`
- `AP[1]` is reserved, `SBO`.

- The translation tables that control the Non-secure PL1&0 stage 2 translations. These map the IPAs from the stage 1 translation onto PAs, for memory accesses made when executing in Non-secure state at PL1 or PL0, and are indicated and controlled by the `VTTBR` and `VTCR`.

The descriptors in the virtualization translation tables define a second level of access permissions, that are overlaid onto the permissions defined in the stage 1 translation. This section describes this overlaying of access permissions.

#### ————— **Note** —————

In an implementation of virtualization, the second-level access permissions mean a hypervisor can define additional access restrictions to those defined by a Guest OS in the stage 1 translation tables. For a particular access, the actual access permission is the more restrictive of the permissions defined by:

- the Guest OS, in the stage 1 translation tables
- the hypervisor, in the stage 2 translation tables.

The stage 2 access controls defined at PL2:

- affect only the Non-secure stage 1 access permissions settings
- take no account of whether the accesses are from a PL1 mode or a PL0 mode
- permit software executing at PL2 to assign a write-only attribute to a memory region.

The `HAP[2:1]` field in the stage 2 descriptors define the stage 2 access permissions, as [Table B3-9 on page B3-1365](#) shows:



**Table B3-9 Stage 2 control of access permissions**

HAP[2:1]	Access permission
00	No access permitted
01	Read-only. Writes to the region are not permitted, regardless of the stage 1 permissions.
10	Write-only. Reads from the region are not permitted, regardless of the stage 1 permissions.
11	Read/write. The stage 1 permissions determine the access permissions for the region.

For more information about the HAP[2:1] field see [Attribute fields in stage 2 Long-descriptor Block and Page descriptors on page B3-1343](#).

If the stage 2 permissions cause a Permission fault, this is a stage 2 MMU fault. Stage 2 MMU faults are taken to Hyp mode, and reported in the [HSR](#) using an EC code of 0x20 or 0x24. For more information, see [Use of the HSR on page B3-1424](#).

———— **Note** —————

The combination of the EC code and the STATUS value in the [HSR](#) indicate that the fault is a stage 2 MMU fault.

The stage 2 permissions include an XN attribute. If this is set to 1, execution from the region is not permitted, regardless of the value of the XN attribute in the stage 1 translation. If a Permission fault is generated because the stage 2 XN bit is set to 1, this is reported as a stage 2 MMU fault.

[Prioritization of aborts on page B3-1407](#) describes the abort prioritization if both stages of a translation generate a fault.

## B3.8 Memory region attributes

In addition to an output address, a translation table entry that refers to a page or region of memory includes fields that define properties of that target memory region. [Information returned by a translation table lookup on page B3-1320](#) describes the classification of those fields as address map control, access control, and memory attribute fields. The memory region attribute fields control the memory type, accesses to the caches, and whether the memory region is Shareable and therefore is coherent.

The following sections describe the assignment of memory region attributes for stage 1 translations:

- [Overview of memory region attributes for stage 1 translations](#)
- [Short-descriptor format memory region attributes, without TEX remap on page B3-1367](#)
- [Short-descriptor format memory region attributes, with TEX remap on page B3-1368](#)
- [Long-descriptor format memory region attributes on page B3-1372.](#)

For an implementation that does not include the Virtualization Extensions, and for an implementation that includes the Virtualization Extensions and is operating in Secure state, or in Hyp mode, these assignments define the memory attributes of the accessed region.

For an implementation that includes the Virtualization Extensions and is operating in a Non-secure PL1 or PL0 mode, the Non-secure PL1&0 stage 2 translation can modify the memory attributes assigned by the stage 1 translation. [PL2 control of Non-secure memory region attributes on page B3-1374](#) describes these stage 2 assignments.

### B3.8.1 Overview of memory region attributes for stage 1 translations

The description of the memory region attributes in a translation descriptor divides into:

#### Memory type and attributes

These are described either:

- Directly, by bits in the translation table descriptor.
- Indirectly, by registers referenced by bits in the table descriptor. This is described as *remapping* the memory type and attribute description.

The Short-descriptor translation table format can use either of these approaches, selected by the `SCTLR.TRE` bit:

**TRE == 0** Remap disabled. The `TEX[2:0]`, `C`, and `B` bits in the translation table descriptor define the memory region attributes. [Short-descriptor format memory region attributes, without TEX remap on page B3-1367](#) describes this encoding.

#### ————— Note —————

With the Short-descriptor format, remapping is called *TEX remap*, and the `SCTLR.TRE` bit is the *TEX remap enabled* bit.

The description of the `TRE == 0` encoding includes information about the encoding in previous versions of the architecture.

**TRE == 1** Remap enabled. The `TEX[0]`, `C`, and `B` bits in the translation table descriptor are index bits to the MMU remap registers, that define the memory region attributes:

- the Primary Region Remap Register, `PRRR`
- the Normal Memory Remap Register, `NMRR`.

[Short-descriptor format memory region attributes, with TEX remap on page B3-1368](#) describes this encoding scheme.

This scheme reassigns translation table descriptor bits `TEX[2:1]` for use as bits managed by the operating system.

The Long-descriptor translation table format always uses remapping. This means the VMSA behaves as if `SCTLR.TRE` is set to 1, regardless of the value that software has written to this bit.

———— **Note** —————

When use of the Long-descriptor format is enabled, `SCTLR.TRE` is UNK/SBOP.

*Long-descriptor format memory region attributes* on page B3-1372 describes this encoding.

**Shareability** In the Short-descriptor translation table format, the S bit in the translation table descriptor encodes whether the region is shareable. Enabling TEX remap extends the shareability description. For more information see:

- *Shareability and the S bit, without TEX remap* on page B3-1368
- *Shareability and the S bit, with TEX remap* on page B3-1370.

In the Long-descriptor translation table format, the SH[1:0] field in the translation table descriptor encodes shareability information. For more information see *Shareability, Long-descriptor format* on page B3-1373.

### B3.8.2 Short-descriptor format memory region attributes, without TEX remap

When using the Short-descriptor translation table formats, TEX remap is disabled when `SCTLR.TRE` is set to 0.

———— **Note** —————

- The Short-descriptor format scheme without TEX remap is the scheme used in VMSAv6.
- The B (Bufferable), C (Cacheable), and TEX (Type extension) bit names are inherited from earlier versions of the architecture. These names no longer adequately describe the function of the B, C, and TEX bits.

Table B3-10 shows the C, B, and TEX[2:0] encodings when TEX remap is disabled:

**Table B3-10 TEX, C, and B encodings when TRE == 0**

TEX[2:0]	C	B	Description	Memory type	Page Shareable
000	0	0	Strongly-ordered	Strongly-ordered	Shareable
		1	Shareable Device <sup>a</sup>	Device	Shareable <sup>a</sup>
	1	0	Outer and Inner Write-Through, no Write-Allocate	Normal	S bit <sup>b</sup>
		1	Outer and Inner Write-Back, no Write-Allocate	Normal	S bit <sup>b</sup>
001	0	0	Outer and Inner Non-cacheable	Normal	S bit <sup>b</sup>
		1	Reserved	-	-
	1	0	IMPLEMENTATION DEFINED	IMPLEMENTATION DEFINED	IMPLEMENTATION DEFINED
		1	Outer and Inner Write-Back, Write-Allocate	Normal	S bit <sup>b</sup>
010	0	0	Non-shareable Device <sup>a</sup>	Device	Non-shareable <sup>a</sup>
		1	Reserved	-	-
	1	x	Reserved	-	-

Table B3-10 TEX, C, and B encodings when TRE == 0 (continued)

TEX[2:0]	C	B	Description	Memory type	Page Shareable
011	x	x	Reserved	-	-
1BB	A	A	Cacheable memory: AA = Inner attribute <sup>c</sup> BB = Outer attribute	Normal	S bit <sup>b</sup>

- For more information, see *Shareable attribute for Device memory regions* on page A3-136. Some implementations make no distinction between Shareable Device memory and Non-shareable Device memory, and refer to both memory types as Shareable Device memory.
- For more information, see *Shareability and the S bit, without TEX remap*.
- For more information, see *Cacheable memory attributes, without TEX remap*.

See *Memory types and attributes and the memory order model* on page A3-125 for an explanation of Normal, Strongly-ordered and Device memory types, and of the shareability attribute.

### Cacheable memory attributes, without TEX remap

When TEX[2] == 1, the translation table entry describes Cacheable memory, and the rest of the encoding defines the Inner and Outer cache attributes:

- TEX[1:0] Define the Outer cache attribute.
- C, B Define the Inner cache attribute.

The translation table entries use the same encoding for the Outer and Inner cache attributes, as Table B3-11 shows.

Table B3-11 Inner and Outer cache attribute encoding

Encoding	Cache attribute
00	Non-cacheable
01	Write-Back, Write-Allocate
10	Write-Through, no Write-Allocate
11	Write-Back, no Write-Allocate

### Shareability and the S bit, without TEX remap

The translation table entries also include an S bit. This bit:

- Is ignored if the entry refers to Device or Strongly-ordered memory.
- For Normal memory, determines whether the memory region is Shareable or Non-shareable:
  - S == 0 Normal memory region is Non-shareable.
  - S == 1 Normal memory region is Shareable.

### B3.8.3 Short-descriptor format memory region attributes, with TEX remap

When using the Short-descriptor translation table formats, TEX remap is enabled when SCTLR.TRE is set to 1. In this configuration:

- The software that defines the translation tables must program the PRRR and NMRR to define seven possible memory region attributes.
- The TEX[0], C, and B bits of the translation table descriptors define the memory region attributes, by indexing PRRR and NMRR.
- Hardware makes no use TEX[2:1], see *The OS managed translation table bits* on page B3-1372.

When TEX remap is enabled:

- for seven of the eight possible combinations of the TEX[0], C and B bits, fields in the [PRRR](#) and [NMRR](#) define the region attributes, as described in this section:
- the meaning of the eighth combination for the TEX[0], C and B bits is IMPLEMENTATION DEFINED
- four bits in the [PRRR](#) define whether the region is shareable, as described in [Shareability and the S bit, with TEX remap on page B3-1370](#).

For each of the possible encodings of the TEX[0], C, and B bits in a translation table entry, [Table B3-12](#) shows which fields of the [PRRR](#) and [NMRR](#) registers describe the memory region attributes.

**Table B3-12 TEX, C, and B encodings when TRE == 1**

Encoding			Cache attributes <sup>a, b</sup> :			
TEX[0]	C	B	Memory type <sup>a</sup>	Inner cacheability	Outer cacheability	Outer Shareable attribute <sup>a, c</sup>
0	0	0	<a href="#">PRRR</a> [1:0]	<a href="#">NMRR</a> [1:0]	<a href="#">NMRR</a> [17:16]	NOT( <a href="#">PRRR</a> [24])
		1	<a href="#">PRRR</a> [3:2]	<a href="#">NMRR</a> [3:2]	<a href="#">NMRR</a> [19:18]	NOT( <a href="#">PRRR</a> [25])
	1	0	<a href="#">PRRR</a> [5:4]	<a href="#">NMRR</a> [5:4]	<a href="#">NMRR</a> [21:20]	NOT( <a href="#">PRRR</a> [26])
		1	<a href="#">PRRR</a> [7:6]	<a href="#">NMRR</a> [7:6]	<a href="#">NMRR</a> [23:22]	NOT( <a href="#">PRRR</a> [27])
1	0	0	<a href="#">PRRR</a> [9:8]	<a href="#">NMRR</a> [9:8]	<a href="#">NMRR</a> [25:24]	NOT( <a href="#">PRRR</a> [28])
		1	<a href="#">PRRR</a> [11:10]	<a href="#">NMRR</a> [11:10]	<a href="#">NMRR</a> [27:26]	NOT( <a href="#">PRRR</a> [29])
	1	0	IMPLEMENTATION DEFINED			
		1	<a href="#">PRRR</a> [15:14]	<a href="#">NMRR</a> [15:14]	<a href="#">NMRR</a> [31:30]	NOT( <a href="#">PRRR</a> [31])

- a. For details of the *Memory type* and *Outer Shareable* encodings see [PRRR, Primary Region Remap Register, VMSA on page B4-1698](#). For details of the *Cache attributes* encodings see [Table B3-11 on page B3-1368](#).
- b. Applies only if the memory type for the region is mapped as Normal memory.
- c. Applies only if the memory type for the region is mapped as Normal or Device memory and the region is Shareable.

If an implementation includes the Security Extensions, the TEX remap registers and the [SCTLR.TRE](#) bit are Banked between the Secure and Non-secure security states. For more information, see [The effect of the Security Extensions on TEX remap on page B3-1372](#).

When TEX remap is enabled, the mappings specified by the [PRRR](#) and [NMRR](#) determine the mapping of the TEX[0], C and B bits in the translation tables to memory type and cacheability attributes:

1. The primary mapping, indicated by a field in the [PRRR](#) as shown in the Memory region column of [Table B3-12](#), takes precedence.
2. For any region that the [PRRR](#) maps as Normal memory, the [NMRR](#) determines the Inner cacheability and Outer cacheability attributes.
3. If it is supported, the Outer Shareable mapping identifies Shareable memory as either Inner Shareable or Outer Shareable, see [Interpretation of the NOSn fields in the PRRR, with TEX remap on page B3-1371](#).

The TEX remap registers must be static during normal operation. In particular, when the remap registers are changed:

- it is IMPLEMENTATION DEFINED when the changes take effect
- it is UNPREDICTABLE whether the TLB caches the effect of the TEX remap on translation tables.

The software sequence to ensure the synchronization of changes to the TEX remap registers is:

1. Perform a DSB. This ensures any memory accesses using the old mapping have completed.
2. Write the TEX remap registers or [SCTLR.TRE](#) bit.

3. Perform an ISB. This ensures synchronization of the register updates.
4. Invalidate the entire TLB.
5. Perform a DSB. This ensures completion of the entire TLB operation.
6. Clean and invalidate all caches. This removes any cached information associated with the old mapping.
7. Perform a DSB. This ensures completion of the cache maintenance.
8. Perform an ISB. This ensures instruction synchronization.

This extends the standard rules for the synchronization of changes to CP15 registers described in [Synchronization of changes to system control registers on page B3-1461](#), and provides implementation freedom as to whether or not the effect of the TEX remap is cached.

### Shareability and the S bit, with TEX remap

The memory type of a region, as indicated in the *Memory type* column of [Table B3-12 on page B3-1369](#), provides the first level of control of whether the region is shareable:

- If the memory type is Strongly-ordered then the region is Shareable
- If the memory type is Device then:
  - if the implementation includes the Large Physical Address Extension, then no distinction is made between Shareable and Non-shareable Device memory, and effectively the region is Shareable
  - otherwise, the shareability is determined by using the value of the S bit in the translation table descriptor to index bits in the [PRRR](#).

Some implementations make no distinction between Shareable Device memory and Non-shareable Device memory, and refer to both memory types as Shareable Device memory.

- If the memory type is Normal then the shareability is determined by using the value of the S bit in the translation table descriptor to index bits in the [PRRR](#).

[Table B3-13](#) shows this determination:

**Table B3-13 Determining shareability, with TEX remap**

Memory type	LPAA <sup>a</sup> implemented	Remapping when S == 0	Remapping when S == 1
Strongly-ordered	-	Shareable	Shareable
Device	No	<a href="#">PRRR[16]</a>	<a href="#">PRRR[17]</a>
	Yes	Shareable	Shareable
Normal	-	<a href="#">PRRR[18]</a>	<a href="#">PRRR[19]</a>

a. LPAA is an abbreviation for the Large Physical Address Extension.

In the cases where the shareability is remapped, the appropriate bit of the [PRRR](#) indicates whether the region is Shareable or Non-shareable, as follows:

**PRRR[n] == 0**      Not shareable.

**PRRR[n] == 1**      Shareable.

———— **Note** —————

When TEX remap is enabled, a translation table entry with S == 0 can be mapped as Shareable memory.

## Interpretation of the NOSn fields in the PRRR, with TEX remap

When all of the following apply, the NOSn fields in the PRRR distinguish between Inner Shareable and Outer Shareable memory regions:

- the SCTLR.TRE bit is set to 1
- the region is mapped as Normal memory, or the implementation does not include the Large Physical Address Extension and the region is mapped as Device memory
- the Normal memory remapping or Device memory remapping of the S bit value for the entry makes the region Shareable
- the implementation supports the distinction between Inner Shareable and Outer Shareable.

If the SCTLR.TRE bit is set to 0, an implementation can provide an IMPLEMENTATION DEFINED mechanism to interpret the NOSn fields in the PRRR, see *SCTLR.TRE, SCTLR.M, and the effect of the TEX remap registers*.

The values of the NOSn fields in the PRRR have no effect if any of the following apply:

- the SCTLR.TRE bit is set to 0 and the IMPLEMENTATION DEFINED mechanism has not been invoked
- the region is mapped as Strongly-ordered memory
- the implementation includes the Large Physical Address Extension, and the region is mapped as Device memory
- the Normal memory remapping or Device memory remapping of the S bit value for the entry makes the region Non-shareable.

The NOSn fields in the PRRR are RAZ/WI if the implementation does not support the distinction between Inner Shareable and Outer Shareable memory regions.

### ———— Note —————

The meaning of shareability attributes for Device memory is IMPLEMENTATION DEFINED for an implementation that does not include the Large Physical Address Extension, and otherwise has no meaning. For more information, see *Shareable attribute for Device memory regions on page A3-136*.

## SCTLR.TRE, SCTLR.M, and the effect of the TEX remap registers

When TEX remap is disabled, because the SCTLR.TRE bit is set to 0:

- the effect of the MMU remap registers can be IMPLEMENTATION DEFINED
- the interpretation of the fields of the PRRR and NMRR registers can differ from the description given earlier in this section.

VMSAv7 requires that the effect of these registers is limited to remapping the attributes of memory locations. These registers must not change whether any cache hardware or MMUs are enabled. The mechanism by which the TEX remap registers have an effect when the SCTLR.TRE bit is set to 0 is IMPLEMENTATION DEFINED. The ARMv7 architecture requires that from reset, if the IMPLEMENTATION DEFINED mechanism has not been invoked:

- If the PL1&0 stage 1 MMU is enabled and is using the Short-descriptor format translation tables, the architecturally-defined behavior of the TEX[2:0], C, and B bits must apply, without reference to the TEX remap functionality. In other words, memory attribute assignment must comply with the scheme described in *Short-descriptor format memory region attributes, without TEX remap on page B3-1367*.
- If the PL1&0 stage 1 MMU is disabled, then the architecturally-defined behavior of the VMSA with MMUs disabled must apply, without reference to the TEX remap functionality. See *The effects of disabling MMUs on VMSA behavior on page B3-1314*.

Possible mechanisms for enabling the IMPLEMENTATION DEFINED effect of the TEX remap registers when `SCTLR.TRE` is set to 0 include:

- a control bit in the `ACTLR`, or in a CP15 c15 register
- changing the behavior when the `PRRR` and `NMRR` registers are changed from their IMPLEMENTATION DEFINED reset values.

In addition, if the MMU is disabled and the `SCTLR.TRE` bit is set to 1, the architecturally-defined behavior of the VMSA with the MMU disabled must apply without reference to the TEX remap functionality.

In an implementation that includes the Security Extensions, the IMPLEMENTATION DEFINED effect of these registers must only take effect in the security state of the registers. See also *The effect of the Security Extensions on TEX remap*.

### The OS managed translation table bits

When TEX remap is enabled, the TEX[2:1] bits in the translation table descriptors are available as two bits that can be managed by the operating system. In VMSAv7, as long as the `SCTLR.TRE` bit is set to 1, the values of the TEX[2:1] bits are ignored by the memory management hardware. Software can write any value to these bits in the translation tables.

———— **Note** —————

In a system that implements hardware management of the Access flag, a hardware Access flag update never changes these bits.

### The effect of the Security Extensions on TEX remap

In an implementation that includes the Security Extensions, the TEX remap registers are Banked in the Secure and Non-secure security states. The register versions for the current security state apply to all PL1&0 stage 1 translation table lookups in that state. The `SCTLR.TRE` bit is Banked in the Secure and Non-secure copies of the register, and the appropriate version of this bit determines whether TEX remap is applied to translation table lookups in the current security state.

Write accesses to the Secure copies of the TEX remap registers are disabled when the `CP15SDISABLE` input is asserted HIGH, meaning the MCR operations to access these registers are UNDEFINED. For more information, see *The CP15SDISABLE input on page B3-1458*.

## B3.8.4 Long-descriptor format memory region attributes

When a processor is using the Long-descriptor translation table format, the `AttrIdx[2:0]` field in a block or page translation table descriptor for a stage 1 translation indicates the 8-bit field in the appropriate `MAIR`, that specifies the attributes for the corresponding memory region:

- `AttrIdx[2]` indicates the value of  $n$  in `MAIR $n$` :  
**AttrIdx[2] == 0**     Use `MAIR0`.  
**AttrIdx[2] == 1**     Use `MAIR1`.
- `AttrIdx[2:0]` indicates the required Attr field, `Attr $n$` , where  $n = \text{AttrIdx}[2:0].$

Each `AttrIdx` field defines, for the corresponding memory region:

- The memory type, Strongly-ordered, Device, or Normal.
- For Normal memory:
  - the inner and outer cacheability, Non-cacheable, Write-Through, or Write-Back
  - for Write-Through Cacheable and Write-Back Cacheable regions, the Read-Allocate and Write-Allocate policy hints, each of which is *Allocate* or *Do not allocate*.



For more information about the AttrIdx[2:0] descriptor field, see [Attribute fields in stage 1 Long-descriptor Block and Page descriptors](#) on page B3-1342.

### Shareability, Long-descriptor format

When a processor is using the Long-descriptor translation table format, the SH[1:0] field in a block or page translation table descriptor specifies the Shareability attributes of the corresponding memory region, if the MAIR entry for that region identifies it as Normal memory. [Table B3-14](#) shows the encoding of this field.

**Table B3-14 SH[1:0] field encoding for Normal memory, Long-descriptor format**

SH[1:0]	Normal memory
00	Non-shareable
01	UNPREDICTABLE
10	Outer Shareable
11	Inner Shareable

See [Overlaying the shareability attribute on page B3-1376](#) for constraints on the Shareability attributes of a Normal memory region that is Inner Non-cacheable, Outer Non-cacheable.

For a Device or Strongly-ordered memory region, the value of the SH[1:0] field of the translation table descriptor is ignored.

### Other fields in the Long-descriptor translation table format descriptors

The following subsections describe the other fields in the translation table block and page descriptors when a processor is using the Long-descriptor translation table format:

- [Contiguous hint](#)
- [Field reserved for software use on page B3-1374](#)
- [Ignored fields on page B3-1374](#).

#### Contiguous hint

The Long-descriptor translation table format descriptors contain a Contiguous hint bit. Setting this bit to 1 indicates that 16 adjacent translation table entries point to a *contiguous output address range*. These 16 entries must be aligned in the translation table so that the top 5 bits of their input addresses, that index their position in the translation table, are the same. For example, referring to [Figure B3-21 on page B3-1354](#), to use this hint for a block of 16 entries in the third-level translation table, bits[20:16] of the input addresses for the 16 entries must be the same.

The contiguous output address range must be aligned to size of 16 translation table entries at the same translation table level.

Use of this hint means that the TLB can cache a single entry to cover the 16 translation table entries.

This bit is only a hint bit. The architecture does not require a processor to cache TLB entries in this way. To avoid TLB coherency issues, any TLB maintenance by address must not assume any optimization of the TLB tables that might result from use of the hint bit.

#### ————— Note —————

This hint capability is similar to the approach used, in the Short-descriptor translation table format, for optimized caching of Large Pages and Supersections in the TLB. However, an important difference in the hint capability is that TLB maintenance must be performed based on the size of the underlying translation table entries, to avoid TLB coherency issues

**Field reserved for software use**

The architecture reserves a 4-bit field in the Block and Page table descriptors for software use. In considering migration from using the Short-descriptor format to the Long-descriptor format, this field is an extension of the Short-descriptor field described in [The OS managed translation table bits on page B3-1372](#).

**Ignored fields**

For stage 1 translation descriptors, the architecture defines a 4-bit Ignored field in the Block and Page table descriptors, bit[63:59], and guarantees that hardware will not alter the value of this field. For stage 2 translation descriptors, the corresponding field is reserved for use by a System MMU. In a processor that is using the Large Physical Address Extension, this field is an ignored field and the architecture guarantees that the processor hardware does not update the field.

**B3.8.5 PL2 control of Non-secure memory region attributes**

Software executing at PL2 controls two sets of translation tables, both of which use the Long-descriptor translation table format:

- The translation tables that control Non-secure PL2 stage 1 translations. These map VAs to PAs, and are indicated and controlled by the [HTTBR](#) and [HTCR](#).  
 These translations have exactly the same memory region attribute controls as any other stage 1 translations, as described in [Long-descriptor format memory region attributes on page B3-1372](#).
- The translation tables that control Non-secure PL1&0 stage 2 translations. These map the IPAs from the stage 1 translation onto PAs, and are indicated and controlled by the [VTTBR](#) and [VTCR](#).  
 The descriptors in the virtualization translation tables define a second level of memory region attributes, that are overlaid onto the attributes defined in the stage 1 translation. This section describes this overlaying of attributes.

[Long-descriptor translation table format descriptors on page B3-1339](#) describes the format of the entries in these tables.

———— **Note** —————

In a virtualization implementation, a hypervisor might usefully:

- reduce the permitted cacheability of a region
- increase the required shareability of a region.

The overlaying of attributes from stage 1 and stage 2 translations supports both of these options.

In the stage 2 translation table descriptors for memory regions and pages, the MemAttr[3:0] and SH[1:0] fields describe the stage 2 memory region attributes:

- The definition of the stage 2 SH[1:0] field is identical to the same field for a stage 1 translation, see [Shareability, Long-descriptor format on page B3-1373](#).
- MemAttr[3:2] give a top-level definition of the memory type, and of the cacheability of a Normal memory region, as [Table B3-15](#) shows:

**Table B3-15 Long-descriptor MemAttr[3:2] encoding, stage 2 translation**

MemAttr[3:2]	Memory type	Cacheability
00	Strongly-ordered or Device, determined by MemAttr[1:0]	Not applicable
01	Normal	Outer Non-cacheable
10		Outer Write-Through Cacheable
11		Outer Write-Back Cacheable

The encoding of MemAttr[1:0] depends on the Memory type indicated by MemAttr[3:2]:

- When MemAttr[3:2]==0b00, indicating Strongly-ordered or Device memory, [Table B3-16](#) shows the encoding of MemAttr[1:0]:

**Table B3-16 MemAttr[1:0] encoding for Strongly-ordered or Device memory**

MemAttr[1:0]	Meaning when MemAttr[3:2] == 0b00
00	Region is Strongly-ordered memory
01	Region is Device memory
10	UNPREDICTABLE
11	UNPREDICTABLE

- When MemAttr[3:2]!=0b00, indicating Normal memory, [Table B3-17](#) shows the encoding of MemAttr[1:0]:

**Table B3-17 MemAttr[1:0] encoding for Normal memory**

MemAttr[1:0]	Meaning when MemAttr[3:2] != 0b00
00	UNPREDICTABLE
01	Inner Non-cacheable
10	Inner Write-Through Cacheable
11	Inner Write-Back Cacheable

**Note**

The stage 2 translation does not assign any allocation hints.

The following sections describe how the memory type attributes assigned at stage 2 of the translation are overlaid onto those assigned at stage 1:

- [Overlaying the memory type attribute on page B3-1376](#)
- [Overlaying the cacheability attribute on page B3-1376](#)
- [Overlaying the shareability attribute on page B3-1376.](#)

**Note**

The following stage 2 translation table attribute settings leave the stage 1 settings unchanged:

- MemAttr[3:2] == 0b11, Normal memory, Outer Write-Back Cacheable
- MemAttr[1:0] == 0b11, Inner Write-Back Cacheable.

## Overlaying the memory type attribute

Table B3-18 shows how the stage 1 and stage 2 memory type assignments are combined:

**Table B3-18 Combining the stage 1 and stage 2 memory type assignments**

Assignment in stage 1	Assignment in stage 2	Resultant type
Strongly-ordered	Any	Strongly-ordered
Any	Strongly-ordered	Strongly-ordered
Device	Normal or Device	Device
Normal or Device	Device	Device
Normal	Normal	Normal

See *Overlaying the shareability attribute* for information about:

- the shareability of a region for which the resultant type is Strongly-ordered or Device
- the shareability requirements of a region with a resultant type of Normal for which the resultant cacheability, described in *Overlaying the cacheability attribute*, is Inner Non-cacheable, Outer Non-cacheable.

The overlaying of the memory type attribute means a translation table walk for a stage 1 translation can be made to Strongly-ordered or Device memory. This is likely to indicate a Guest OS error, and setting the HCR.PTW bit to 1 causes such an access to generate a Translation fault, see *Stage 2 fault on a stage 1 translation table walk, Virtualization Extensions* on page B3-1402.

## Overlaying the cacheability attribute

For a Normal memory region, Table B3-19 shows how the stage 1 and stage 2 cacheability assignments are combined. This combination applies, independently, for the Inner cacheability and Outer cacheability attributes:

**Table B3-19 Combining the stage 1 and stage 2 cacheability assignments**

Assignment in stage 1	Assignment in stage 2	Resultant cacheability
Non-cacheable	Any	Non-cacheable
Any	Non-cacheable	Non-cacheable
Write-Through Cacheable	Write-Through or Write-Back Cacheable	Write-Through Cacheable
Write-Through or Write-Back Cacheable	Write-Through Cacheable	Write-Through Cacheable
Write-Back Cacheable	Write-Back Cacheable	Write-Back Cacheable

———— **Note** —————

Only Normal memory has a cacheability attribute.

## Overlaying the shareability attribute

A memory region for which the resultant memory type attribute, described in *Overlaying the memory type attribute*, is Strongly-ordered or Device, is treated as Outer Shareable, regardless of any shareability assignments at either stage of translation. For more information about the effect of the Large Physical Address Extension on the shareability of Device and Strongly-ordered memory, see *Device and Strongly-ordered memory shareability, Large Physical Address Extension* on page A3-137.

For a memory region with a resultant memory type attribute of Normal, [Table B3-20](#) shows how the stage 1 and stage 2 shareability assignments are combined:

**Table B3-20 Combining the stage 1 and stage 2 shareability assignments**

Assignment in stage 1	Assignment in stage 2	Resultant shareability
Outer Shareable	Any	Outer Shareable
Inner Shareable	Outer Shareable	Outer Shareable
Inner Shareable	Inner Shareable	Inner Shareable
Inner Shareable	Non-shareable	Inner Shareable
Non-shareable	Outer Shareable	Outer Shareable
Non-shareable	Inner Shareable	Inner Shareable
Non-shareable	Non-shareable	Non-shareable

A memory region with a resultant memory type attribute of Normal, and a resultant cacheability attribute of Inner Non-cacheable, Outer Non-cacheable, must have a resultant shareability attribute of Outer Shareable, otherwise shareability is UNPREDICTABLE.

## B3.9 Translation Lookaside Buffers (TLBs)

*Translation Lookaside Buffers* (TLBs) are an implementation technique that caches translations or translation table entries. TLBs avoid the requirement for every memory access to perform a translation table walk in memory. The ARM architecture does not specify the exact form of the TLB structures for any design. In a similar way to the requirements for caches, the architecture only defines certain principles for TLBs:

- The architecture has a concept of an entry locked down in the TLB. The method by which lockdown is achieved is IMPLEMENTATION DEFINED, and an implementation might not support lockdown.
- The architecture does not guarantee that an unlocked TLB entry remains in the TLB.
- The architecture guarantees that a locked TLB entry remains in the TLB. However, a locked TLB entry might be updated by subsequent updates to the translation tables. Therefore, when a change is made to the translation tables, the architecture does not guarantee that a locked TLB entry remains incoherent with an entry in the translation table.
- The architecture guarantees that a translation table entry that generates a Translation fault or an Access flag fault is not held in the TLB. However a translation table entry that generates a Domain fault or a Permission fault might be held in the TLB.
- Any translation table entry that does not generate a Translation or Access flag fault and is not out of context might be allocated to an enabled TLB at any time. The only translation table entries guaranteed not to be held in the TLB are those that generate a Translation or Access flag fault.

———— **Note** —————

An enabled TLB can hold translation table entries that do not generate a Translation fault but point to subsequent tables in the translation table walk. This can be referred to as *intermediate caching* of TLB entries.

- Software can rely on the fact that between disabling and re-enabling a stage of address translation, entries in the TLB relating to that stage of translation have not have been corrupted to give incorrect translations.

The following sections give more information about TLB implementation:

- [Global and process-specific translation table entries](#)
- [TLB matching on page B3-1379](#)
- [TLB behavior at reset on page B3-1379](#)
- [TLB lockdown on page B3-1379](#)
- [TLB conflict aborts on page B3-1380](#).

See also [TLB maintenance requirements on page B3-1381](#).

### B3.9.1 Global and process-specific translation table entries

In a VMSA implementation, system software can divide a virtual memory map used by memory accesses at PL1 and PL0 into global and non-global regions, indicated by the nG bit in the translation table descriptors:

**nG == 0**      The translation is global, meaning the region is available for all processes.

**nG == 1**      The translation is non-global, or process-specific, meaning it relates to the current ASID, as defined by the [CONTEXTIDR](#).

Each non-global region has an associated *Address Space Identifier* (ASID). These identifiers mean different translation table mappings can co-exist in a caching structure such as a TLB. This means that software can create a new mapping of a non-global memory region without removing previous mappings.

For a symmetric multiprocessor cluster where a single operating system is running on the set of processing elements, ARMv7 requires all ASID values to be assigned uniquely within any single Inner Shareable domain. In other words, each ASID value must have the same meaning to all processing elements in the system.

The translation regime used for accesses made at PL2 does not support ASIDs, and all pages are treated as global.

When a processor is using the Long-descriptor translation table format, and is in Secure state, a translation must be treated as non-global, regardless of the value of the nG bit, if NSTable is set to 1 at any level of the translation table walk.

For more information see [Control of Secure or Non-secure memory access, Long-descriptor format on page B3-1344](#).

### B3.9.2 TLB matching

A TLB is a hardware caching structure for translation table information. Like other hardware caching structures, it is mostly invisible to software. However, there are some situations where it can become visible. These are associated with coherency problems caused by an update to the translation table that has not been reflected in the TLB. Use of the TLB maintenance operations described in [TLB maintenance requirements on page B3-1381](#) can prevent any TLB incoherency becoming a problem.

A particular case where the presence of the TLB can become visible is if the translation table entries that are in use under a particular ASID and VMID are changed without suitable invalidation of the TLB. This is an issue regardless of whether or not the translation table entries are global. In some cases, the TLB can hold two mappings for the same address, and this might lead to UNPREDICTABLE behavior

### B3.9.3 TLB behavior at reset

The ARMv7 architecture does not require a reset to invalidate the TLBs. ARMv7 recognizes that an implementation might require caches, including TLBs, to maintain context over a system reset. Possible reasons for doing so include power management and debug requirements.

For ARMv7:

- All TLBs are disabled from reset. All MMUs are disabled from reset, and the contents of the TLBs have no effect on address translation. For more information see [Enabling MMUs on page B3-1316](#).
- An implementation can require the use of a specific TLB *invalidation routine*, to invalidate the TLB arrays before they are enabled after a reset. The exact form of this routine is IMPLEMENTATION DEFINED, but if an invalidation routine is required it must be documented clearly as part of the documentation of the device.  
ARM recommends that if an invalidation routine is required for this purpose, the routine is based on the ARMv7 TLB maintenance operations described in [TLB maintenance operations, not in Hyp mode on page B4-1743](#).
- When TLBs that have not been invalidated by some mechanism since reset are enabled, the state of those TLBs is UNPREDICTABLE.

Similar rules apply:

- to cache behavior, see [Behavior of the caches at reset on page B2-1269](#)
- to branch predictor behavior, see [Behavior of the branch predictors at reset on page B2-1272](#).

### B3.9.4 TLB lockdown

ARMv7 recognizes that any TLB lockdown scheme is heavily dependent on the microarchitecture, making it inappropriate to define a common mechanism across all implementations. This means that:

- ARMv7 does not require TLB lockdown support.
- If TLB lockdown support is implemented, the lockdown mechanism is IMPLEMENTATION DEFINED. However, key properties of the interaction of lockdown with the architecture must be documented as part of the implementation documentation.

This means that:

- In ARMv7, the TLB Type Register, [TLBTR](#), does not define the lockdown scheme in use.

———— **Note** ————

This is a change from previous versions of the architecture, see [CP15 c0, TLB Type ID Register, TLBTR, ARMv6 on page AppxL-2527](#).

- A region of the CP15 c10 encodings is reserved for IMPLEMENTATION DEFINED TLB functions, such as TLB lockdown functions. The reserved encodings are those with:
  - $\langle CRm \rangle == \{c0, c1, c4, c8\}$
  - all values of  $\langle opc2 \rangle$  and  $\langle opc1 \rangle$ .

See also [IMPLEMENTATION DEFINED TLB control operations, VMSA on page B4-1750](#).

An implementation might use some of the CP15 c10 encodings that are reserved for IMPLEMENTATION DEFINED TLB functions to implement additional TLB control functions. These functions might include:

- Unlock all locked TLB entries.
- Preload into a specific level of TLB. This is beyond the scope of the PLI and PLD hint instructions.

The Virtualization Extensions do not affect the TLB lockdown requirements. However, in a processor that implements the Virtualization Extensions, exceptions generated by problems related to TLB lockdown, in a Non-secure PL1 mode, can be routed to either:

- Non-secure Abort mode, using the Non-secure Data Abort exception vector
- Hyp mode, using the Hyp Trap exception vector.

For more information, see [Trapping accesses to lockdown, DMA, and TCM operations on page B1-1252](#).

### B3.9.5 TLB conflict aborts

The Large Physical Address Extension introduces the concept of a TLB conflict abort, and adds fault status encodings for such an abort, for both the Short-descriptor and Long-descriptor translation table formats, see:

- [PL1 fault reporting with the Short-descriptor translation table format on page B3-1414](#)
- [Fault reporting with the Long-descriptor translation table format on page B3-1416](#).

An implementation can generate a TLB conflict abort if it detects that the address being looked up in the TLB hits multiple entries. This can happen if the TLB has been invalidated inappropriately, for example if TLB invalidation required by this manual has not been performed. If it happens, the resulting behavior is UNPREDICTABLE, but must not permit access to regions of memory with permissions or attributes that mean they cannot be accessed in the current Security state at the current privilege level.

In some implementations, multiple hits in the TLB can generate a synchronous Data Abort or Prefetch Abort exception. In any case where this is possible it is IMPLEMENTATION DEFINED whether the abort is a stage 1 abort or a stage 2 abort.

———— **Note** ————

A stage 2 abort cannot be generated if the Non-secure PL1&0 stage 2 MMU is disabled.

The priority of the TLB conflict abort is IMPLEMENTATION DEFINED, because it depends on the form of any TLB that can generate the abort.

———— **Note** ————

The TLB conflict abort must have higher priority than any abort that depends on a value held in the TLB.

An implementation can generate TLB conflict aborts on either or both instruction fetches and data accesses.

On a TLB conflict abort, the fault address register returns the address that generated the fault. That is, it returns the address that was being looked up in the TLB.



## B3.10 TLB maintenance requirements

*Translation Lookaside Buffers (TLBs)* are an implementation mechanism that caches translations or translation table entries. The ARM architecture does not specify the form of any TLB structures, but defines the mechanisms by which TLBs can be maintained. The following sections describe the VMSAv7 TLB maintenance operations:

- [General TLB maintenance requirements](#)
- [Maintenance requirements on changing system control register values on page B3-1384](#)
- [Atomicity of register changes on changing virtual machine on page B3-1385](#)
- [Synchronization of changes of ASID and TTBR on page B3-1386](#)
- [Multiprocessor effects on TLB maintenance operations on page B3-1388](#)
- [The scope of TLB maintenance operations on page B3-1388.](#)

### B3.10.1 General TLB maintenance requirements

TLB maintenance operations provide a mechanism to invalidate entries from a TLB. As stated at the start of [Translation Lookaside Buffers \(TLBs\) on page B3-1378](#), any translation table entry that does not generate a Translation fault or an Access flag fault might be allocated to an enabled TLB at any time. This means that software must perform TLB maintenance between updating translation table entries that apply in a particular context and accessing memory locations whose translation is determined by those entries in that context.

———— **Note** ————

This requirement applies to any translation table entry at any level of the translation tables, including an entry that points to further levels of the tables, provided that the entry in that level of the tables does not cause a Translation fault or Access flag fault

In addition to any TLB maintenance requirement, when changing the cacheability attributes of an area of memory, software must ensure that any cached copies of affected locations are removed from the caches. For more information see [Cache maintenance requirement created by changing translation table attributes on page B3-1394](#).

Because a TLB never holds any translation table entry that generates a Translation fault or an Access Flag fault, a change from a translation table entry that causes a Translation or Access flag fault to one that does not fault, does not require any TLB or branch predictor invalidation.

In addition, software must perform TLB maintenance after updating the system control registers if the updates mean that the TLB might hold information that applies to a current translation context, but is no longer valid for that context. [Maintenance requirements on changing system control register values on page B3-1384](#) gives more information about this maintenance requirement.

Each of the translation regimes defined in [Figure B3-1 on page B3-1309](#) is a different context, and:

- For the Non-secure PL1&0 regime, a change in the VMID or ASID value changes the context.
- For the Secure PL1&0 regime, a change in the ASID value changes the context.

For operation in Non-secure PL1&0 modes, a change of [HCR.VM](#), unless made at the same time as a change of VMID, requires the invalidation of all TLB entries for the Non-secure PL1&0 translation regime that apply to the current VMID. Otherwise, there is no guarantee that the effect of the change of [HCR.VM](#) is visible to software executing in the Non-secure PL1&0 modes.

Any TLB operation can affect any other TLB entries that are not locked down.

The architecture defines CP15 c8 functions for TLB maintenance operations, and supports the following operations:

- invalidate all unlocked entries in the TLB
- invalidate a single TLB entry, by MVA, or MVA and ASID for a non-global entry
- invalidate all TLB entries that match a specified ASID.

A TLB maintenance operation that specifies a virtual address that would generate any MMU abort, including a virtual address that is not in the range of virtual addresses that can be translated, does not generate an abort.

The Multiprocessing Extensions add the following operations:

- invalidate all TLB entries that match a specified MVA, regardless of the ASID
- operations that apply across multiprocessors in the same Inner Shareable domain, see [Multiprocessor effects on TLB maintenance operations on page B3-1388](#).

———— **Note** —————

An address-based TLB maintenance operation that applies to the Inner Shareable domain does so regardless of the Shareability attributes of the address supplied as an argument to the operation.

The Virtualization Extensions include additional TLB maintenance operations for use at PL2, and have some implications for the effect of the other TLB maintenance operations, see [The scope of TLB maintenance operations on page B3-1388](#).

In an implementation that includes the Security Extensions, the TLB operations take account of the current security state, as part of the address translation required for the TLB operation.

Some TLB operations are defined as operating only on instruction TLBs, or only on data TLBs. ARMv7 includes these operations for backwards compatibility, and more recent TLB operations do not support this distinction. From the introduction of ARMv7, ARM deprecates any use of Instruction TLB operations, or of Data TLB operations, and developers must not rely on this distinction being maintained in future versions of the ARM architecture.

The ARM architecture does not dictate the form in which the TLB stores translation table entries. However, for TLB invalidate operations, the minimum size of the table entry that is invalidated from the TLB must be at least the size that appears in the translation table entry.

———— **Note** —————

In an implementation that includes the Large Physical Address Extension and is using the Long-descriptor translation table format, the Contiguous hint bit does not affect the minimum size of entry that must be invalidated from the TLB

[TLB maintenance operations, not in Hyp mode on page B4-1743](#) describes these operations.

## The interaction of TLB lockdown with TLB maintenance operations

The precise interaction of TLB lockdown with the TLB maintenance operations is IMPLEMENTATION DEFINED. However, the architecturally-defined TLB maintenance operations must comply with these rules:

- The effect on locked entries of the TLB invalidate all unlocked entries and TLB invalidate by MVA all ASID operations is IMPLEMENTATION DEFINED. However, these operations must implement one of the following options:
  - Have no effect on entries that are locked down.
  - Generate an IMPLEMENTATION DEFINED Data Abort exception if an entry is locked down, or might be locked down. The CP15 c5 fault status register definitions include a fault code for cache and TLB lockdown faults, see [Table B3-23 on page B3-1415](#) for the codes used with the Short-descriptor translation table formats, or [Table B3-24 on page B3-1416](#) for the codes used with the Long-descriptor translation table formats.

In an implementation that includes the Virtualization Extensions, if HCR.TIDCP is set to 1, any such exceptions taken from a Non-secure PL1 mode are routed to Hyp mode, see [Trapping accesses to lockdown, DMA, and TCM operations on page B1-1252](#).

This permits a usage model for TLB invalidate routines, where the routine invalidates a large range of addresses, without considering whether any entries are locked in the TLB.

- The effect on locked entries of the TLB invalidate by MVA and invalidate by ASID match operations is IMPLEMENTATION DEFINED. However, the implementation must be one of the following:
  - A locked entry is invalidated in the TLB.
  - The operation has no effect on a locked entry in the TLB. In the case of the Invalidate single entry by MVA, this means the processor treats the operation as a NOP.
  - The operation generates an IMPLEMENTATION DEFINED Data Abort exception if it operates on an entry that is locked down, or might be locked down. The CP15 c5 fault status register definitions include a fault code for cache and TLB lockdown faults, see [Table B3-23 on page B3-1415](#) and [Table B3-24 on page B3-1416](#).

———— **Note** —————

Any implementation that uses an abort mechanism for entries that can be locked down but are not actually locked down must:

- document the IMPLEMENTATION DEFINED instruction sequences that perform the required operations on entries that are not locked down
- implement one of the other specified alternatives for the locked entries.

ARM recommends that, when possible, such IMPLEMENTATION DEFINED instruction sequences use the architecturally-defined operations. This minimizes the number of customized operations required.

In addition, an implementation that uses an abort mechanism for handling TLB maintenance operations on entries that can be locked down but are not actually locked down must also must provide a mechanism that ensures that no TLB entries are locked.

Similar rules apply to cache lockdown, see [The interaction of cache lockdown with cache maintenance operations on page B2-1287](#).

The architecture does not guarantee that any unlocked entry in the TLB remains in the TLB. This means that, as a side-effect of a TLB maintenance operation, any unlocked entry in the TLB might be invalidated.

## TLB maintenance operations and the memory order model

The following rules describe the relations between the memory order model and the TLB maintenance operations:

- A TLB invalidate operation is complete when all memory accesses using the invalidated TLB entries have been observed by all observers, to the extent that those accesses must be observed. The shareability and cacheability of the accessed memory locations determine the extent to which the accesses must be observed.  
In addition, once the TLB invalidate operation is complete, no new memory accesses that can be observed by those observers will be performed using the invalidated TLB entries.  
For a TLB invalidate operation that affects other processors, the set of memory accesses that have been observed when the TLB maintenance operation is complete must include the memory accesses from those processes that used the invalidated TLB entries.
- A TLB maintenance operation is only guaranteed to be complete after the execution of a DSB instruction.
- An ISB instruction, or a return from an exception, causes the effect of all completed TLB maintenance operations that appear in program order before the ISB or return from exception to be visible to all subsequent instructions, including the instruction fetches for those instructions.
- An exception causes all completed TLB maintenance operations, that appear in the instruction stream before the point where the exception was taken, to be visible to all subsequent instructions, including the instruction fetches for those instructions.
- All TLB Maintenance operations are executed in program order relative to each other.

- The execution of a Data or Unified TLB maintenance operation is only guaranteed to be visible to a subsequent explicit load or store operation after both:
  - the execution of a DSB instruction to ensure the completion of the TLB operation
  - execution of a subsequent context synchronization operation.
- The execution of an Instruction or Unified TLB maintenance operation is only guaranteed to be visible to a subsequent instruction fetch after both:
  - the execution of a DSB instruction to ensure the completion of the TLB operation
  - execution of a subsequent context synchronization operation.

The following rules apply when writing translation table entries. They ensure that the updated entries are visible to subsequent accesses and cache maintenance operations.

For TLB maintenance, the translation table walk is treated as a separate observer. This means:

- A write to the translation tables, after it has been cleaned from the cache if appropriate, is only guaranteed to be seen by a translation table walk caused by an explicit load or store after the execution of both a DSB and an ISB.  
However, the architecture guarantees that any writes to the translation tables are not seen by any explicit memory access that occurs in program order before the write to the translation tables.
- For an ARMv7 implementation that does not include the Large Physical Address Extension, and in implementations of architecture versions before ARMv7, if the translation tables are held in Write-Back Cacheable memory, the caches must be cleaned to the point of unification after writing to the translation tables and before the DSB instruction. This ensures that the updated translation table are visible to a hardware translation table walk.
- A write to the translation tables, after it has been cleaned from the cache if appropriate, is only guaranteed to be seen by a translation table walk caused by the instruction fetch of an instruction that follows the write to the translation tables after both a DSB and an ISB.

Therefore, an example instruction sequence for writing a translation table entry, covering changes to the instruction or data mappings in a uniprocessor system is:

```
STR rx, [Translation table entry] ; write new entry to the translation table
Clean cache line [Translation table entry] : This operation is not required with the
                                           ; Multiprocessing Extensions.
DSB ; ensures visibility of the data cleaned from the D Cache
Invalidate TLB entry by MVA (and ASID if non-global) [page address]
Invalidate BTC
DSB ; ensure completion of the Invalidate TLB operation
ISB ; ensure table changes visible to instruction fetch
```

### B3.10.2 Maintenance requirements on changing system control register values

The TLB contents can be influenced by control bits in a number of system control registers. This means the TLB must be invalidated after any changes to these bits, unless the changes are accompanied by a change to the VMID or ASID that defines the context to which the bits apply. The general form of the required invalidation sequence is as follows:

```
; Change control bits in system control registers
ISB ; Synchronize changes to the control bits
; Perform TLB invalidation of all entries that might be affected by the changed control bits
```

The system control register changes that this applies to are:

- any change to the [NMRR](#), [PRRR](#), [MAIR<sub>n</sub>](#), or [HMAIR<sub>n</sub>](#) registers
- any change to the [SCTLR.AFE](#) bit, see [Changing the Access flag enable on page B3-1385](#)
- any change to the [SCTLR.TRE](#) bit

- in an implementation that includes the Virtualization Extensions:
  - any change to the [SCTLR](#).{WXN, UWXN} bits
  - any change to the [SCR](#).SIF bit
  - any change to the [HCR](#).VM bit
  - any change to [HCR](#).PTW bit, see *Changing HCR.PTW*
- in an implementation that includes the Large Physical Address Extension, changing [TTBCR](#).EAE, see *Changing the current Translation table format*
- when using the Short-descriptor translation table format:
  - any change to the RGN, IRGN, S, or NOS fields in [TTBR0](#) or [TTBR1](#)
  - any change to the PD0 or PD1 fields in [TTBCR](#)
- when using the Long-descriptor translation table format:
  - any change to the TnSZ, ORGNn, IRGNn, SHn, or EPDn fields in the [TTBCR](#), where n is 0 or 1
  - any change to the T0SZ, ORGN0, IRGN0, or SH0 fields in the [HTCR](#)
  - any change to the T0SZ, ORGN0, IRGN0, or SH0 fields in the [VTCR](#).

### Changing the Access flag enable

In a processor that is using the Short-descriptor translation table format, it is UNPREDICTABLE whether the TLB caches the effect of the [SCTLR](#).AFE bit on translation tables. This means that, after changing the [SCTLR](#).AFE bit software must invalidate the TLB before it relies on the effect of the new value of the [SCTLR](#).AFE bit.

———— **Note** —————

There is no enable bit for use of the Access flag when using the Long-descriptor translation table format.

### Changing HCR.PTW

When the Protected table walk bit, [HCR](#).PTW, is set to 1, a stage 1 translation table access in the Non-secure PL1&0 translation regime, to an address that is mapped to Device or Strongly-ordered memory by its stage 2 translation, generates a stage 2 Permission fault. A TLB associated with a particular VMID might hold entries that depend on the effect of [HCR](#).PTW. Therefore, if the value of [HCR](#).PTW is changed without a change to the VMID value, all TLB entries associated with the current VMID must be invalidated before executing software in a Non-secure PL1 or PL0 mode. If this is not done, behavior is UNPREDICTABLE.

### Changing the current Translation table format

In an implementation that includes the Large Physical Address Extension, the effect of changing [TTBCR](#).EAE when executing in the translation regime affected by [TTBCR](#).EAE with any MMU for that translation regime enabled is UNPREDICTABLE. When [TTBCR](#).EAE is changed for a given context, the TLB must be invalidated before resuming execution in that context, otherwise the effect is UNPREDICTABLE.

## B3.10.3 Atomicity of register changes on changing virtual machine

From the viewpoint of software executing in a Non-secure PL1 or PL0 mode, when there is a switch from one virtual machine to another, the registers that control or affect address translation must be changed atomically. This applies to the registers for:

- Non-secure PL1&0 stage 1 address translations. This means that all of the following registers must change atomically:
  - [PRRR](#) and [NMRR](#), if using the Short-descriptor translation table format
  - [MAIR0](#) and [MAIR1](#), if using the Long-descriptor translation table format
  - [TTBR0](#), [TTBR1](#), [TTBCR](#), [DACR](#), and [CONTEXTIDR](#)
  - the [SCTLR](#).

- Non-secure PL1&0 stage 2 address translations. This means that all of the following registers and register fields must change atomically:
  - VTTBR and VTCR
  - HMAIR0 and HMAIR1
  - the HSCTLR.

———— **Note** —————

Only some bits of **SCTLR** affect the stage 1 translation, and only some bits of **HSCTLR** affect the stage 2 translation. However, in each case, changing these bits requires a write to the register, and that write must be atomic with the other register updates.

These registers apply to execution in Non-secure PL1&0 modes. However, when updated as part of a switch of virtual machines they are updated by software executing in Hyp mode. This means the registers are *out of context* when they are updated, and no synchronization precautions are required.

———— **Note** —————

By contrast, a translation table change associated with a change of ASID, made by software executing at PL1, can require changes to registers that are *in context*. [Synchronization of changes of ASID and TTBR](#) describes appropriate precautions for such a change.

The Virtualization Extensions require that software executing in Hyp mode, or in Secure state, must not use the registers associated with the Non-secure PL1&0 translation regime for speculative memory accesses.

#### B3.10.4 Synchronization of changes of ASID and TTBR

A common virtual memory management requirement is to change the ASID and Translation Table Base Registers together to associate the new ASID with different translation tables, without any change to the current translation regime. When using the Short-descriptor translation table format, different registers hold the ASID and the translation table base address, meaning these two values cannot be updated atomically. Since a processor can perform a speculative memory access at any time, this lack of atomicity is a problem that software must address. Such a change is complicated by:

- the depth of speculative fetch being IMPLEMENTATION DEFINED
- the use of branch prediction.

When using the Short-descriptor translation table format, the virtual memory management operations must ensure the synchronization of changes of the ContextID and the translation table registers. For example, some or all of the TLBs, branch predictors, and other caching of ASID and translation information might become corrupt with invalid translations. Synchronization is necessary to avoid either:

- the old ASID being associated with translation table walks from the new translation tables
- the new ASID being associated with translation table walks from the old translation tables.

There are a number of possible solutions to this problem, and the most appropriate approach depends on the system. [Example B3-3 on page B3-1387](#), [Example B3-4 on page B3-1387](#), and [Example B3-5 on page B3-1387](#) describe three possible approaches.

———— **Note** —————

Another instance of the synchronization problem occurs if a branch is encountered between changing the ASID and performing the synchronization. In this case the value in the branch predictor might be associated with the incorrect ASID. Software can address this possibility using any of these approaches, but might, instead, be written to avoid such branches.

---

### Example B3-3 Using a reserved ASID to synchronize ASID and TTBR changes

---

In this approach, a particular ASID value is reserved for use by the operating system, and is used only for the synchronization of the ASID and Translation Table Base Register. This example uses the value of 0 for this purpose, but any value could be used.

This approach can be used only when the size of the mapping for any given virtual address is the same in the old and new translation tables.

The maintenance software uses the following sequence, that must be executed from memory marked as global:

```
Change ASID to 0
ISB
Change Translation Table Base Register
ISB
Change ASID to new value
```

This approach ensures that any non-global pages fetched at a time when it is uncertain whether the old or new translation tables are being accessed are associated with the unused ASID value of 0. Since the ASID value of 0 is not used for any normal operations these entries cannot cause corruption of execution.

---

### Example B3-4 Using translation tables containing only global mappings when changing the ASID

---

A second approach involves switching the translation tables to a set of translation tables that only contain global mappings while switching the ASID.

The maintenance software uses the following sequence, that must be executed from memory marked as global:

```
Change Translation Table Base Register to the global-only mappings
ISB
Change ASID to new value
ISB
Change Translation Table Base Register to new value
```

This approach ensures that no non-global pages can be fetched at a time when it is uncertain whether the old or new ASID value will be used.

---

### Example B3-5 Disabling non-global mappings when changing the ASID

---

In systems where only the translation tables indexed by **TTBR0** hold non-global mappings, maintenance software can use the **TTBCR.PD0** field to disable use of **TTBR0** during the change of ASID. This means the system does not require a set of global-only mappings.

The maintenance software uses the following sequence, that must be executed from a memory region with a translation that is accessed using the base address in the **TTBR1** register, and is marked as global:

```
Set TTBCR.PD0 = 1
ISB
Change ASID to new value
Change Translation Table Base Register to new value
ISB
Set TTBCR.PD0 = 0
```

This approach ensures that no non-global pages can be fetched at a time when it is uncertain whether the old or new ASID value will be used.

---



When using the Long-descriptor translation table format, **TTBCR.A1** holds the number, 0 or 1, of the TTBR that holds the current ASID. This means the current Translation Table Base Register can also hold the current ASID, and the current translation table base address and ASID can be updated atomically when:

- **TTBR0** is the only Translation Table Base Register being used. **TTBCR.A1** must be set to 0.
- **TTBR0** points to the only translation tables that hold non-global entries, and **TTBCR.A1** is set to 0.
- **TTBR1** points to the only translation tables that hold non-global entries, and **TTBCR.A1** is set to 1.

In these cases, software can update the current translation table base address and ASID atomically, by updating the appropriate TTBR, and does not require a specific routine to ensure synchronization of the change of ASID and base address.

However, in all other cases using the Long-descriptor format, the synchronization requirements are identical to those when using the Short-descriptor formats, and the examples in this section indicate how synchronization might be achieved.

———— **Note** —————

When using the Long-descriptor translation table format, **CONTEXTIDR.ASID** has no significance for address translation, and is only an extension of **CONTEXTIDR**.

### B3.10.5 Multiprocessor effects on TLB maintenance operations

For an ARMv7 implementation that does not include the Multiprocessing Extensions, the architecture defines that a TLB maintenance operation applies only to any TLBs that are used in translating memory accesses made by the processor performing the maintenance operation.

The ARMv7 Multiprocessing Extensions are an OPTIONAL set of extensions that improve the implementation of a multiprocessor system. These extensions provide additional TLB maintenance operations that apply to the TLBs of processors in the same Inner Shareable domain.

———— **Note** —————

The Multiprocessing Extensions can be implemented in a uniprocessor system with no hardware support for cache coherency. In such a system, the Inner Shareable domain applies only to the single processor, and all instructions defined to apply to the Inner Shareable domain behave as aliases of the local operations.

### B3.10.6 The scope of TLB maintenance operations

TLB maintenance operations provide a mechanism for invalidating entries from TLB caching structures, to ensure that changes to the translation tables are reflected correctly in the TLB caching structures.

The architecture permits the caching of any translation table entry that has been returned from memory without a fault and that does not, itself, cause a Translation Fault or an Access Flag fault. This means the TLB:

- Cannot hold an entry that, when used for a translation table lookup, causes a Translation Fault or an Access Flag fault.
- Can hold an entry for a translation table lookup for a translation that causes a Translation Fault or an Access Flag fault at a subsequent level of translation table lookup. For example, it can hold an entry for the first level lookup of a translation that causes a Translation Fault or an Access Flag fault at the second or third level of lookup.

This means that entries cached in the TLB can include:

- translation table entries that point to a subsequent table to be used in the current stage of translation
- in an implementation that includes the Virtualization Extensions:
  - stage 2 translation table entries that are used as part of a stage 1 translation table walk
  - stage 2 translation table entries for translating the output address of a stage 1 translation.



Such entries might be held in intermediate TLB caching structures that are distinct from the data caches, in that they are not required to be invalidated as the result of writes of the data. The architecture makes no restriction on the form of these intermediate TLB caching structures.

The architecture does not intend to restrict the form of TLB caching structures used for holding translation table entries, and in particular for translation regimes that involve two stages of translation, it recognizes that such caching structures might contain:

- at any level of the translation table walk, entries containing information from stage 1 translation table entries
- in an implementation that includes the Virtualization Extensions:
  - at any level of the translation table walk, entries containing information from stage 2 translation table entries
  - at any level of the translation table walk, entries combining information from both stage 1 and stage 2 translation table entries.

Where a TLB maintenance operation is required to apply to stage 1 entries, then it must apply to any cached entry in the caching structures that includes any stage 1 information that would be used to translate the address being invalidated, including any entry that combines information from both stage 1 and stage 2 translation table entries.

Where a TLB maintenance operation is required to apply to stage 2 entries it must apply to any cached entry in the caching structures that includes any information from stage 2 translation table entries, including any entry that combines information from both stage 1 and stage 2 translation table entries.

[Table B3-21 on page B3-1390](#) summarizes the required effect of the preferred TLB operations that operate only on TLBs on the processor that executes the instruction. Additional TLB operations:

- In an implementation that includes the Multiprocessing Extensions, apply across all processors in the same Inner Shareable domain. In such an implementation, each operation shown in the table has an Inner Shareable equivalent, identified by an IS suffix. For example, the Inner Shareable equivalent of [TLBIALL](#) is [TLBIALLIS](#). See also [Virtualization Extensions upgrading of TLB maintenance operations on page B3-1391](#).
- Can apply to separate Instruction or Data TLBs, as indicated by a footnote to the table. ARM deprecates any use of these operations.

———— **Note** —————

- The architecture permits a TLB invalidation operation to affect any unlocked entry in the TLB. [Table B3-21 on page B3-1390](#) defines only the entries that each operation must invalidate.
- All TLB operations, including those that operate on an MVA match, operate regardless of the value of [SCTLR.M](#).

When interpreting the table:

<b>Related operations</b>	Each operation description applies also to any equivalent operation that either: <ul style="list-style-type: none"> <li>• applies to all processors in the same Inner Shareable domain</li> <li>• applies only to a data TLB, or only to an instruction TLB.</li> </ul> So, for example, the <a href="#">TLBIALL</a> description applies also to <a href="#">TLBIALLIS</a> , <a href="#">ITLBIALL</a> , and <a href="#">DTLBIALL</a> .
<b>Matches the MVA</b>	Means the MVA argument for the operation must match the MVA value in the TLB entry.
<b>Matches the ASID</b>	Means the ASID argument for the operation must match the ASID in use when the TLB entry was assigned.

**Matches the current VMID**

Means the current VMID must match the VMID in use when the TLB entry was assigned. This condition applies only on implementations that include the Virtualization Extensions. The dependency on the VMID applies even when [HCR.VM](#) is set to 0, including situations where there is no use of virtualization. However, [VTTBR.VMID](#) resets to zero, meaning there is a valid VMID from reset.

**Execution at PL2** Descriptions of operations at PL2 apply only to an implementation that includes the Virtualization Extensions.

For the definitions of the translation regimes referred to in the table see [About the VMSA on page B3-1308](#).

**Table B3-21 Effect of the TLB maintenance operations**

Operation	Executed from		Effect, must invalidate any entry that matches all stated conditions
	State	Mode	
TLBIALL <sup>a, b</sup>	Secure	PL1	All entries for the Secure PL1&0 translation regime. That is, any entry that was allocated in Secure state.
	Non-secure	PL1	All entries for stage 1 of the Non-secure PL1&0 translation regime that match the current VMID.
		PL2	All entries for stage 1 or stage 2 of the Non-secure PL1&0 translation regime that match the current VMID.
TLBIMVA <sup>a, b</sup>	Secure	PL1	Any entry for the Secure PL1&0 translation regime that both: <ul style="list-style-type: none"> <li>• matches the MVA argument</li> <li>• matches the ASID argument, or is global.</li> </ul>
	Non-secure	PL1 or PL2	Any entry for stage 1 of the Non-secure PL1&0 translation regime for which all of the following apply. The entry: <ul style="list-style-type: none"> <li>• matches the MVA argument</li> <li>• matches the ASID argument, or is global</li> <li>• matches the current VMID.</li> </ul>
TLBIASID <sup>a, b</sup>	Secure	PL1	Any entry for the Secure PL1&0 translation regime that matches the ASID argument.
	Non-secure	PL1 or PL2	Any entry for stage 1 of the Non-secure PL1&0 translation regime that both: <ul style="list-style-type: none"> <li>• is not global and matches the ASID argument</li> <li>• matches the current VMID.</li> </ul>
TLBIMVAA <sup>a</sup>	Secure	PL1	Any entry for the Secure PL1&0 translation regime that matches the MVA argument.
	Non-secure	PL1 or PL2	Any entry for stage 1 of the Non-secure PL1&0 translation regime that both: <ul style="list-style-type: none"> <li>• matches the MVA argument</li> <li>• matches the current VMID.</li> </ul>
TLBIALLNSNH <sup>c</sup>	Secure	Monitor	All entries for stage 1 or stage 2 of the Non-secure PL1&0 translation regime, regardless of the associated VMID.
	Non-secure	PL2	
TLBIALLH <sup>c</sup>	Secure	Monitor	All entries for the Non-secure PL2 translation regime. That is, any entry that was allocated in Non-secure state at PL2.
	Non-secure	PL2	

**Table B3-21 Effect of the TLB maintenance operations (continued)**

Operation	Executed from		Effect, must invalidate any entry that matches all stated conditions
	State	Mode	
TLBIMVAH <sup>c</sup>	Secure	Monitor	Any entry for the Non-secure PL2 translation regime that matches the MVA argument.
	Non-secure	PL2	

- a. See *TLB maintenance operations, not in Hyp mode* on page B4-1743.
- b. The architecture defines variants of these operations that apply only to instruction TLBs, and only to data TLBs. ARM deprecates any use of these variants. For more information, see the referenced description of the operation.
- c. Available only in an implementation that includes the Virtualization Extensions, see *Hyp mode TLB maintenance operations, Virtualization Extensions* on page B4-1746.

### Virtualization Extensions upgrading of TLB maintenance operations

In an implementation that includes the Virtualization Extensions, when `HCR.FB` is set to 1, the TLB maintenance operations that are not broadcast across the Inner Shareable domain are upgraded to operate across the Inner Shareable domain when performed in a Non-secure PL1 mode. For example, when `HCR.FB` is set to 1, a `TLBIMVA` operation performed in a Non-secure PL1 mode operates as a `TLBIMVAIS` operation,

## B3.11 Caches in a VMSA implementation

The ARM architecture describes the required behavior of an implementation of the architecture. As far as possible it does not restrict the implemented microarchitecture, or the implementation techniques that might achieve the required behavior.

Maintaining this level of abstraction is difficult when describing the relationship between memory address translation and caches, especially regarding the indexing and tagging policy of caches. This section:

- summarizes the architectural requirements for the interaction between caches and memory translation
- gives some information about the likely implementation impact of the required behavior.

The following sections give this information:

- [Data and unified caches](#)
- [Instruction caches](#)

In addition, [Cache maintenance requirement created by changing translation table attributes on page B3-1394](#) describes the cache maintenance required after updating the translation tables to change the attributes of an area of memory.

For more information about cache maintenance see:

- [About ARMv7 cache and branch predictor maintenance functionality on page B2-1273](#). This section describes the ARMv7 cache maintenance operations, that apply to both PMSA and VMSA implementations.
- [Cache maintenance operations, functional group, VMSA on page B3-1496](#). This section summarizes the CP15 encodings used for these operations.

### B3.11.1 Data and unified caches

For data and unified caches, the use of memory address translation is entirely transparent to any data access that is not UNPREDICTABLE.

This means that the behavior of accesses from the same observer to different VAs, that are translated to the same PA with the same memory attributes, is fully coherent. This means these accesses behave as follows, regardless of which VA is accessed:

- two writes to the same PA occur in program order
- a read of a PA returns the value of the last successful write to that PA
- a write to a PA that occurs, in program order, after a read of that PA, has no effect on the value returned by that read.

The memory system behaves in this way without any requirement to use barrier or cache maintenance operations.

In addition, if cache maintenance is performed on a memory location, the effect of that cache maintenance is visible to all aliases of that physical memory location.

These properties are consistent with implementing all caches that can handle data accesses as *Physically-indexed, physically-tagged* (PIPT) caches.

### B3.11.2 Instruction caches

In the ARM architecture, an instruction cache is a cache that is accessed only as a result of an instruction fetch. Therefore, an instruction cache is never written to by any load or store instruction executed by the processor.

The ARMv7 architecture supports three different behaviors for instruction caches. For ease of reference and description these are identified by descriptions of the associated expected implementation, as follows:

- PIPT instruction caches
- *Virtually-indexed, physically-tagged* (VIPT) instruction caches
- ASID and VMID tagged *Virtually-indexed, virtually-tagged* (VIVT) instruction caches.

The CTR identifies the form of the instruction caches, see [CTR, Cache Type Register, VMSA on page B4-1556](#).

The following subsections describe the behavior associated with these cache types, including any occasions where explicit cache maintenance is required to make the use of memory address translation transparent to the instruction cache:

- [PIPT instruction caches](#)
- [VIPT instruction caches](#)
- [ASID and VMID tagged VIVT instruction caches](#).

---

**Note**

---

For software to be portable between implementations that might use any of PIPT instruction caches, VIPT instruction caches, or ASID and VMID tagged VIVT instruction caches, the software must invalidate the instruction cache whenever any condition occurs that would require instruction cache maintenance for at least one of the instruction cache types.

---

### PIPT instruction caches

For PIPT instruction caches, the use of memory address translation is entirely transparent to all instruction fetches that are not UNPREDICTABLE.

If cache maintenance is performed on a memory location, the effect of that cache maintenance is visible to all aliases of that physical memory location.

An implementation that provides PIPT instruction caches implements the IVIPT extension, see [IVIPT architecture extension on page B3-1394](#).

### VIPT instruction caches

For VIPT instruction caches, the use of memory address translation is transparent to all instruction fetches that are not UNPREDICTABLE, except for the effect of memory address translation on instruction cache invalidate by address operations.

---

**Note**

---

Cache invalidation is the only cache maintenance operation that can be performed on an instruction cache.

---

If instruction cache invalidation by address is performed on a memory location, the effect of that invalidation is visible only to the virtual address supplied with the operation. The effect of the invalidation might not be visible to any other aliases of that physical memory location.

The only architecturally-guaranteed way to invalidate all aliases of a physical address from a VIPT instruction cache is to invalidate the entire instruction cache.

An implementation that provides VIPT instruction caches implements the IVIPT extension, see [IVIPT architecture extension on page B3-1394](#).

### ASID and VMID tagged VIVT instruction caches

For ASID and VMID tagged VIVT instruction caches, if the instructions at any virtual address change, for a given translation regime and a given ASID and VMID, as appropriate, then instruction cache maintenance is required to ensure that the change is visible to subsequent execution. This maintenance is required when writing new values to instruction locations. It can also be required as a result of any of the following situations that change the translation of a virtual address to a physical address, if, as a result of the change to the translation, the instructions at the virtual addresses change:

- enabling or disabling the MMU
- writing new mappings to the translation tables

- any change to the [TTBR0](#), [TTBR1](#), or [TTBCR](#) registers, unless accompanied by a change to the ContextID, or a change to the VMID
- changes to the [VTTBR](#) or [VTCR](#) registers, unless accompanied by a change to the VMID.

———— **Note** —————

For ASID and VMID tagged VIVT instruction caches only, invalidation is not required if the changes to the translations are such that the instructions associated with the non-faulting translations of a virtual address, for a given translation regime and a given ASID and VMID, as appropriate, remain unchanged, through the sequence of changes to the translations. Examples of translation changes to which this applies are:

- changing a valid translation to a translation that generates a MMU fault
- changing a translation that generates a MMU fault to a valid translation.

This does not apply for VIPT or PIPT instruction caches.

If instruction cache invalidation by address is performed on a memory location, the effect of that invalidation is visible only to the virtual address supplied with the operation. The effect of the invalidation might not be visible to any other aliases of that physical memory location.

The only architecturally-guaranteed way to invalidate all aliases of a physical address from an ASID and VMID tagged VIVT instruction cache is to invalidate the entire instruction cache.

### IVIPT architecture extension

An implementation in which the instruction cache exhibits the behaviors described in [PIPT instruction caches on page B3-1393](#), or those described in [VIPT instruction caches on page B3-1393](#), is said to implement the *IVIPT Extension* to the ARMv7 architecture.

The formal definition of the IVIPT extension to the ARMv7 architecture is that it reduces the instruction cache maintenance requirement to the following condition:

- instruction cache maintenance is required only after writing new data to a physical address that holds an instruction.

### B3.11.3 Cache maintenance requirement created by changing translation table attributes

Any change to the translation tables to change the attributes of an area of memory can require maintenance of the translation tables, as described in [General TLB maintenance requirements on page B3-1381](#). If the change affects the cacheability attributes of the area of memory, including any change between Write-Through and Write-Back attributes, software must ensure that any cached copies of affected locations are removed from the caches, typically by cleaning and invalidating the locations from the levels of cache that might hold copies of the locations affected by the attribute change. Any of the following changes to the inner cacheability or outer cacheability attribute creates this maintenance requirement:

- Write-Back to Write-Through
- Write-Back to Non-cacheable
- Write-Through to Non-cacheable
- Write-Through to Write-Back.

The cache clean and invalidate avoids any possible coherency errors caused by mismatched memory attributes.

Similarly, to avoid possible coherency errors caused by mismatched memory attributes, the following sequence must be followed when changing the shareability attributes of a cacheable memory location:

1. Make the memory location Non-cacheable, Outer Shareable.
2. Clean and invalidate the location from them cache.
3. Change the shareability attributes to the required new values.

## B3.12 VMSA memory aborts

In a VMSAv7 implementation, the following mechanisms cause a processor to take an exception on a failed memory access:

<b>Debug exception</b>	An exception caused by the debug configuration, see <a href="#">About debug exceptions on page C4-2088</a> .
<b>Alignment fault</b>	An Alignment fault is generated if the address used for a memory access does not have the required alignment for the operation. For more information see <a href="#">Unaligned data access on page A3-108</a> and <a href="#">Alignment faults on page B3-1402</a> .
<b>MMU fault</b>	An MMU fault is a fault generated by the fault checking sequence for the current translation regime.
<b>External abort</b>	Any memory system fault other than a Debug exception, an Alignment fault, or an MMU fault.

Collectively, these mechanisms are called *aborts*. [Chapter C4 Debug Exceptions](#) describes Debug exceptions, and the remainder of this section describes Alignment faults, MMU faults, and External aborts.

The exception generated on a synchronous memory abort:

- on an instruction fetch is called the Prefetch Abort exception
- on a data access is called the Data Abort exception.

———— **Note** —————

The Prefetch Abort exception applies to any synchronous memory abort on an instruction fetch. It is not restricted to speculative instruction fetches.

In the ARM architecture, asynchronous memory aborts are a type of External abort, and are treated as a special type of Data Abort exception.

The following sections describe the abort mechanisms:

- [Routing of aborts on page B3-1396](#).
- [VMSAv7 MMU fault terminology on page B3-1398](#)
- [The MMU fault-checking sequence on page B3-1398](#)
- [Alignment faults on page B3-1402](#)
- [MMU faults on page B3-1403](#)
- [External aborts on page B3-1405](#)
- [Prioritization of aborts on page B3-1407](#).

———— **Note** —————

The introduction of the Large Physical Address Extension changes some aspects of the terminology used for describing MMU faults, and this section uses the new terminology throughout. For more information, see [VMSAv7 MMU fault terminology on page B3-1398](#).

An access that causes an abort is said to be aborted, and uses the *Fault Address Registers* (FARs) and *Fault Status Registers* (FSRs) to record context information. For more information about the FARs and FSRs, see [Exception reporting in a VMSA implementation on page B3-1409](#).

### B3.12.1 Routing of aborts

A memory abort is either a Data Abort exception or a Prefetch Abort exception. The mode to which a memory abort is taken depends on the reason for the exception, the mode the processor is in when it takes the exception, and configuration settings, as follows:

#### Memory aborts taken to Monitor mode

If an implementation includes the Security Extensions, when `SCR.EA` is set to 1, all External aborts are taken to Monitor mode. This applies to aborts taken from Secure modes and from Non-secure modes. For more information see [Asynchronous exception routing controls on page B1-1174](#).

———— **Note** —————

- Although the referenced section mostly describes the routing of asynchronous exceptions, it includes the `SCR.EA` control that applies to both synchronous and asynchronous external aborts.
- The `SCR` is implemented only as part of the Security Extensions.

#### Memory aborts taken to Secure Abort mode

If an implementation includes the Security Extensions, when the processor is executing in Secure state, all memory aborts that are not routed to Monitor mode are taken to Secure Abort mode.

———— **Note** —————

The only memory aborts that can be routed to Monitor mode are External aborts.

#### Memory aborts taken to Hyp mode

If an implementation includes the Virtualization Extensions, when the processor is executing in Non-secure state, the following aborts are taken to Hyp mode:

- Alignment faults taken:
  - When the processor is in Hyp mode.
  - When the processor is in a PL1 or PL0 mode and the exception is generated because the Non-secure PL1&0 stage 2 translation identifies the target of an unaligned access as Device or Strongly-ordered memory.
  - When the processor is in the PL0 mode and `HCR.TGE` is set to 1. For more information see [Synchronous external abort, when HCR.TGE is set to 1 on page B1-1192](#).
- When the processor is using the Non-secure PL1&0 translation regime:
  - MMU faults from stage 2 translations, for which the stage 1 translation did not cause an MMU fault.
  - Any abort taken during the stage 2 translation of an address accessed in a stage 1 translation table walk that is not routed to Secure Monitor mode, see [Stage 2 fault on a stage 1 translation table walk, Virtualization Extensions on page B3-1402](#).
- When the processor is using the Non-secure PL2 translation regime, MMU faults from stage 1 translations.

———— **Note** —————

The Non-secure PL2 translation regime has only one stage of translation.

- External aborts, if `SCR.EA` is set to 0 and any of the following applies:
  - The processor was executing in Hyp mode when it took the exception.
  - The processor was executing in a Non-secure PL0 or PL1 mode when it took the exception, the abort is asynchronous, and `HCR.AMO` is set to 1. For more information see [Asynchronous exception routing controls on page B1-1174](#).



- The processor was executing in the Non-secure PL0 mode when it took the exception, the abort is synchronous, and `HCR.TGE` is set to 1. For more information see [Synchronous external abort, when HCR.TGE is set to 1 on page B1-1192](#).
- The abort occurred on a stage 2 translation table walk.
- Debug exceptions, if `HDCR.TDE` is set to 1. For more information, see [Routing Debug exceptions to Hyp mode on page B1-1193](#).

### Memory aborts taken to Non-secure Abort mode

In an implementation that does not include the Security Extensions, all memory aborts are taken to Abort mode.

Otherwise, when the processor is executing in Non-secure state, the following aborts are taken to Non-secure Abort mode:

- When the processor is in a Non-secure PL1 or PL0 mode, Alignment faults taken for any of the following reasons:
  - `SCTLR.A` is set to 1.
  - An instruction that does not support unaligned accesses is committed for execution, and the instruction accesses an unaligned address.
  - The implementation includes the Virtualization Extensions, and the PL1&0 stage 1 translation identifies the target of an unaligned access as Device or Strongly-ordered memory.

#### ———— Note —————

In an implementation that does not include the Virtualization Extensions, this case results in an UNPREDICTABLE memory access, see [Cases where unaligned accesses are UNPREDICTABLE on page A3-109](#).

In an implementation includes the Virtualization Extensions and is in the Non-secure PL0 mode, these exceptions are taken to Abort mode only if `HCR.TGE` is set to 0.

- When the processor is using the Non-secure PL1&0 translation regime, MMU faults from stage 1 translations.
- External aborts, if all of the following apply:
  - the abort is not on a stage 2 translation table walk
  - the processor is not in Hyp mode
  - `SCR.EA` is set to 0
  - the abort is asynchronous, and `HCR.AMO` is set to 0
  - the abort is synchronous, and `HCR.TGE` is set to 0.
- Virtual Aborts, see [Virtual exceptions in the Virtualization Extensions on page B1-1196](#).
- When `HDCR.TDE` is set to 0, Debug exceptions. For more information, see [Routing Debug exceptions to Hyp mode on page B1-1193](#).

### Memory aborts with IMPLEMENTATION DEFINED behavior

In addition, a processor can generate an abort for an IMPLEMENTATION DEFINED reason associated with lockdown, or with a coprocessor. In an implementation that includes the Virtualization Extensions, whether such an abort is taken to Non-secure Abort mode or taken to Hyp mode is IMPLEMENTATION DEFINED, and an implementation might include a mechanism to select whether the abort is routed to Non-secure Abort mode or to Hyp mode.

When the processor is in a Non-secure mode other than Hyp mode, if multiple factors cause an Alignment fault, the abort is taken to Non-secure Abort mode if any of the factors require the abort to be taken to Abort mode. For example, if the `SCTLR.A` bit is set to 1, and the access is an unaligned access to an address that the stage 2 translation tables mark as Strongly-ordered, then the abort is taken to Non-secure Abort mode.

For more information see [Exception handling on page B1-1164](#).

### B3.12.2 VMSAv7 MMU fault terminology

The Large Physical Address Extension introduce new terminology for MMU faults, to provide consistent terminology across all VMSAv7 implementations. [Table B3-22](#) shows the terminology used in this manual for MMU faults, compared with older ARM documentation. The current terms are the same for faults that occur with the Short-descriptor translation table format and with the Long-descriptor format, and also applies to faults in a third-level lookup when using the Long-descriptor translation table format.

**Table B3-22 Changes in MMU fault terminology**

Current term	Old term	Note
First level Translation fault	Section Translation fault	-
Second level Translation fault	Page Translation fault	-
Third level Translation fault	-	Long-descriptor translation table format only.
First level Access flag fault	Section Access flag fault	-
Second level Access flag fault	Page Access flag fault	-
Third level Access flag fault	-	Long-descriptor translation table format only.
First level Domain fault	Section Domain fault	Short-descriptor translation table format only, except for reporting faults on address translation operations in the 64-bit PAR, see <a href="#">Determining the PAR format, Large Physical Address Extension</a> on page B3-1441. Cannot occur at third level.
Second level Domain fault	Page Domain fault	
First level Permission fault	Section Permission fault	-
Second level Permission fault	Page Permission fault	-
Third level Permission fault	-	Long-descriptor translation table format only.

In an implementation that includes the Virtualization Extensions, MMU faults are also classified by the translation stage at which the fault is generated. This means that a memory access from a Non-secure PL1 or PL0 mode can generate:

- a stage 1 MMU fault, for example, a stage 1 Translation fault
- a stage 2 MMU fault, for example, a stage 2 Translation fault.

### B3.12.3 The MMU fault-checking sequence

This section describes the MMU checks made for the memory accesses required for instruction fetches and for explicit memory accesses:

- if an instruction fetch faults it generates a Prefetch Abort exception
- if an data memory access faults it generates a Data Abort exception.

For more information about Prefetch Abort exceptions and Data Abort exceptions see [Exception handling on page B1-1164](#).

In a VMSA implementation, all memory accesses require VA to PA translation. Therefore, when a corresponding MMU is enabled, each access requires a lookup of the translation table descriptor for the accessed VA. For more information, see [Translation tables on page B3-1318](#) and subsequent sections of this chapter. MMU fault checking is performed for each level of translation table lookup. If an implementation includes the Virtualization Extensions and is operating in Non-secure state, MMU fault checking is performed for each stage of address translation.

---

**Note**

For a processor that includes the Virtualization Extensions, operating in Non-secure state, the operating system or similar Non-secure system software defines the stage 1 translation tables in the IPA address space, and typically is unaware of the stage 2 translation, from IPA to PA. However, each Non-secure translation table access is subject to stage 2 address translation, and might be faulted at that stage.

---

The MMU fault checking sequence is largely independent of the translation table format, as the figures in this section show. The differences are:

**When using the Short-descriptor format**

- There are one or two levels of lookup.
- Lookup always starts at the first level.
- The final level of lookup checks the Domain field of the descriptor and:
  - faults if there is no access to the Domain
  - checks the access permissions only for Client domains.

**When using the Long-descriptor format**

- There are one, two, or three levels of lookup.
- Lookup starts at either the first level or the second level.
- Domains are not supported. All accesses are treated as Client domain accesses.

The fault-checking sequence shows a translation from an Input address to an Output address. For more information about this terminology, see [About address translation on page B3-1311](#).

---

**Note**

The descriptions in this section do not include the possibility that the attempted address translation generates a TLB conflict abort, as described in [TLB conflict aborts on page B3-1380](#).

---

[MMU faults on page B3-1403](#) describes the faults that a MMU fault-checking sequence can report.

[Figure B3-23 on page B3-1400](#) shows the process of fetching a descriptor from the translation table. For the top-level fetch for any translation, the descriptor is fetched only if the input address passes any required alignment check. As the figure shows, in an implementation that includes the Virtualization Extensions, if the translation is stage 1 of the Non-secure PL1&0 translation regime, then the descriptor address is in the IPA address space, and is subject to a stage 2 translation to obtain the required PA. This stage 2 translation requires a recursive entry to the fault checking sequence.

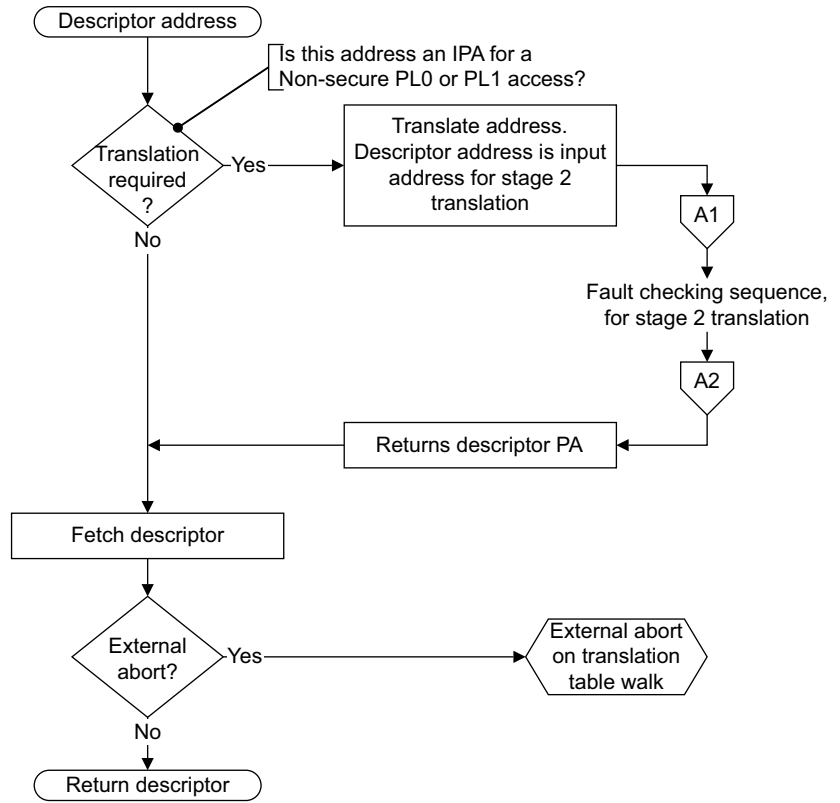

Figure B3-23 Fetching the descriptor in a translation table walk

Figure B3-24 shows the full VMSA fault checking sequence, including the alignment check on the initial access.

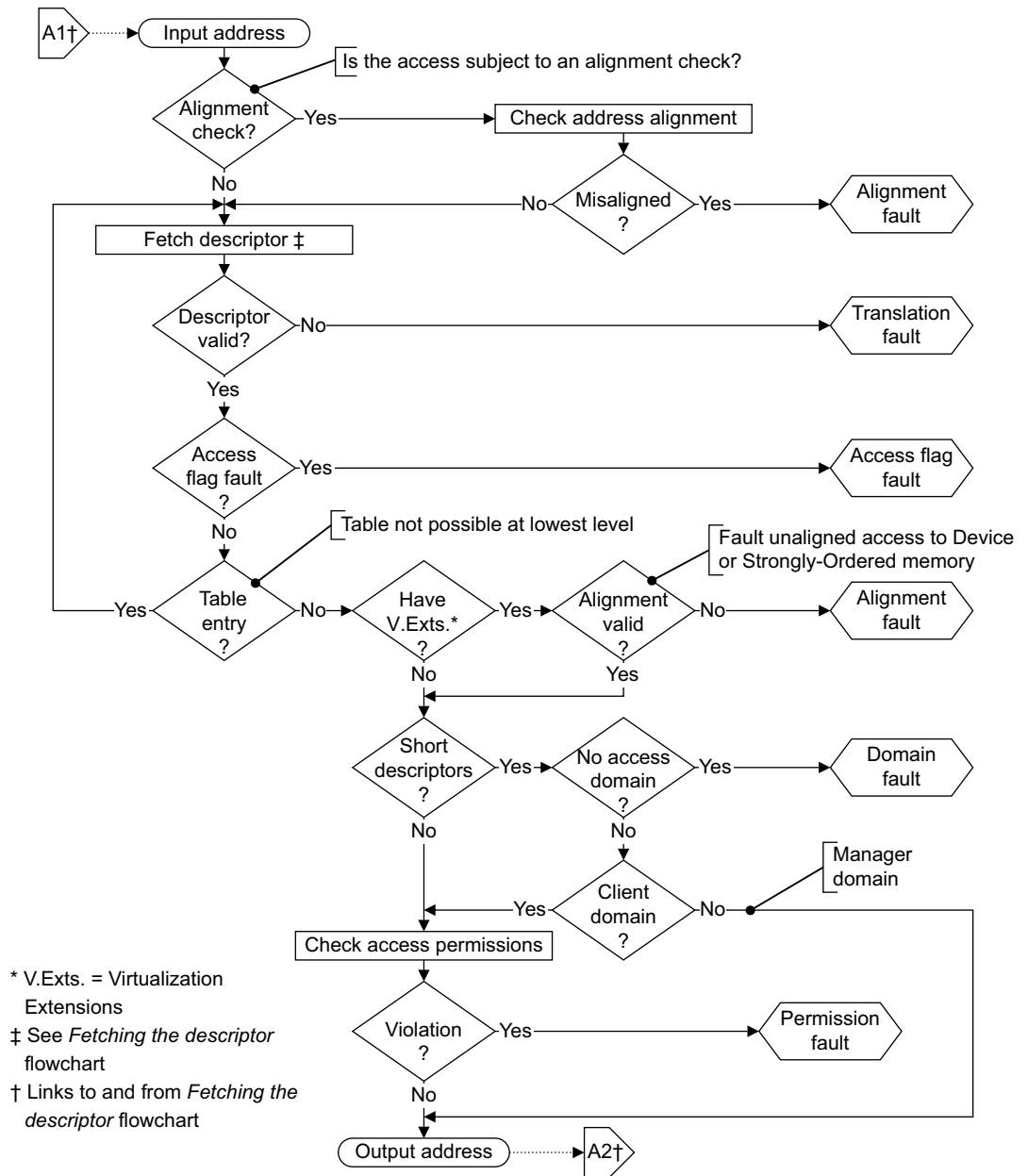

Figure B3-24 VMSA fault checking sequence

## Stage 2 fault on a stage 1 translation table walk, Virtualization Extensions

When an implementation that includes the Virtualization Extensions is operating in a Non-secure PL1 or PL0 mode, any memory access goes through two stages of translation:

- stage 1, from VA to IPA
- stage 2, from IPA to PA.

---

### Note

In a virtualized system, typically, a Guest OS operating in a Non-secure PL1 mode defines the translation tables and translation table register entries controlling the Non-secure PL1&0 stage 1 translations. A Guest OS has no awareness of the stage 2 address translation, and therefore believes it is specifying translation table addresses in the physical address space. However, it actually specifies these addresses in its IPA space. Therefore, to support virtualization, translation table addresses for the Non-secure PL1&0 stage 1 translations are always defined in the IPA address space.

---

On performing a translation table walk for the stage 1 translations, the descriptor addresses must be translated from IPA to PA, using a stage 2 translation. This means that a memory access made as part of a stage 1 translation table lookup might generate, on a stage 2 translation:

- a Translation fault, Access flag fault, or Permission fault
- a synchronous external abort on the memory access.

If `SCR.EA` is set to 1, a synchronous external abort is taken to Secure Monitor mode. Otherwise, these faults are reported as stage 2 memory aborts. `HSR.ISS[7]` is set to 1, to indicate a stage 2 fault during a stage 1 translation table walk, and the part of the ISS field that might contain details of the instruction is invalid. For more information see [Use of the HSR on page B3-1424](#).

Alternatively, a memory access made as part of a stage 1 translation table lookup might target an area of memory with the Device or Strongly-ordered attribute assigned on the stage 2 translation of the address accessed. When the `HCR.PTW` bit is set to 1, such an access generates a stage 2 Permission fault.

---

### Note

- On most systems, such a mapping to Strongly-ordered or Device memory on the stage 2 translation is likely to indicate a Guest OS error, where the stage 1 translation table is corrupted. Therefore, it is appropriate to trap this access to the hypervisor.

---

A TLB might hold entries that depend on the effect of `HCR.PTW`. Therefore, if `HCR.PTW` is changed without changing the current VMID, the TLBs must be invalidated before executing in a Non-secure PL1 or PL0 mode. For more information see [Changing HCR.PTW on page B3-1385](#).

A cache maintenance operation performed from a Non-secure PL1 mode can cause a stage 1 translation table walk that might generate a stage 2 Permission fault, as described in this section. This is an exception to the general rule that a cache maintenance operation cannot generate a Permission fault.

### B3.12.4 Alignment faults

The ARMv7 memory architecture requires support for strict alignment checking. This checking is controlled by `SCTLR.A`. In addition, some instructions do not support unaligned accesses, regardless of the value of `SCTLR.A`. [Unaligned data access on page A3-108](#) defines when Alignment faults are generated, for both values of `SCTLR.A`.

An Alignment fault can occur on an access for which the MMU is disabled.

In an implementation that includes the Virtualization Extensions, any unaligned access to memory region with the Device or Strongly-ordered memory type attribute generates an Alignment fault.

---

**Note**

- In versions of the ARMv7 architecture before the introduction of the Virtualization extensions, the behavior of an unaligned access to Device or Strongly-ordered memory is architecturally UNPREDICTABLE. Most implementations generate an abort on such an access.
- In some documentation, including issues A and B of this manual, Alignment faults are classified as a type of MMU fault. However, the behavior of Alignment faults differs, in a number of ways, from the behavior of MMU faults. This change in the classification of Alignment faults has no effect on their behavior.

---

*Routing of aborts on page B3-1396* defines the mode to which an Alignment fault is taken.

In an implementation that includes the Virtualization Extensions, the prioritization of Alignment faults depends on whether the fault was generated because of an access to Device or Strongly-ordered memory, or for another reason. For more information see *Prioritization of aborts on page B3-1407*.

### B3.12.5 MMU faults

This section describes the faults that might be detected during one of the fault-checking sequences described in *The MMU fault-checking sequence on page B3-1398*. Unless indicated otherwise, information in this section applies to the fault checking sequences for both the Short-descriptor translation table format and the Long-descriptor translation table format.

MMU faults are always synchronous. For more information, see *Terminology for describing exceptions on page B1-1137*.

When an MMU fault generates an abort for a region of memory, no memory access is made if that region is or could be marked as Strongly-ordered or Device.

The following subsections describe the MMU faults that might be detected during a fault checking sequence:

- *External abort on a translation table walk*
- *Translation fault*
- *Access flag fault on page B3-1404*
- *Domain fault, Short-descriptor format translation tables only on page B3-1404*
- *Permission fault on page B3-1405*.

#### External abort on a translation table walk

The section *External aborts on page B3-1405* describes this abort. See, in particular, *External abort on a translation table walk on page B3-1406*.

#### Translation fault

A Translation fault can be generated at any level of lookup, and the reported fault code identifies the lookup level. A Translation fault is generated if bits[1:0] of a translation table descriptor identify the descriptor as either a Fault encoding or a reserved encoding. For more information see:

- *Short-descriptor translation table format descriptors on page B3-1325*
- *Long-descriptor translation table format descriptors on page B3-1339*.

In addition, if an implementation includes the Virtualization Extensions, then a Translation fault is generated if the input address for a translation either does not map on to an address range of a Translation Table Base Register, or the Translation Table Base Register range that it maps on to is disabled. In these cases the fault is reported as a first level Translation fault on the translation stage at which the mapping to a region described by a Translation Table Base Register failed.

The architecture guarantees that any translation table entry that causes a Translation fault is not cached, meaning the TLB never holds such an entry. Therefore, when a Translation fault occurs, the fault handler does not have to perform any TLB maintenance operations to remove the faulting entry.

A data or unified cache maintenance operation by MVA can generate a Translation fault. Whether an instruction cache invalidate by MVA operation can generate a Translation fault is IMPLEMENTATION DEFINED, because it is IMPLEMENTATION DEFINED whether the operation requires an address translation. If the instruction cache invalidate by MVA operation requires an address translation then the operation can generate a Translation fault, otherwise it cannot generate a Translation fault.

Whether branch predictor maintenance operations can generate Translation faults is IMPLEMENTATION DEFINED, because it is IMPLEMENTATION DEFINED whether the operation requires an address translation. If the branch predictor maintenance operation requires an address translation then the operation can generate a Translation fault, otherwise it cannot generate a Translation fault.

### Access flag fault

An Access flag fault can be generated at any level of lookup, and the reported fault code identifies the lookup level. An Access flag fault is generated only if all of the following apply:

- The translation tables support an Access flag bit:
  - the Short-descriptor format supports an Access flag only when `SCTLR.AFE` is set to 1
  - the Long-descriptor format always supports an Access flag.
- For the relevant stage of address translation, the processor is not performing hardware management of the Access flag. Support for hardware management of the Access flag is OPTIONAL and deprecated, but `SCTLR.HA` is set to 1 when hardware management is supported and enabled.

———— **Note** —————

Hardware management of the Access flag cannot be supported for either:

- Non-secure PL2 stage 1 address translation
- Non-secure PL1&0 stage 2 address translation.

- A translation table descriptor with the Access flag bit set to 0 is loaded.

For more information about the Access flag bit see:

- [Short-descriptor translation table format descriptors on page B3-1325](#)
- [Long-descriptor translation table format descriptors on page B3-1339](#).

The architecture guarantees that any translation table entry that causes an Access flag fault is not cached, meaning the TLB never holds such an entry. Therefore, when an Access flag fault occurs, the fault handler does not have to perform any TLB maintenance operations to remove the faulting entry.

Whether any cache maintenance operations by MVA can generate Access flag faults is IMPLEMENTATION DEFINED.

Whether branch predictor invalidate by MVA operations can generate Access flag faults is IMPLEMENTATION DEFINED.

For more information, see [The Access flag on page B3-1362](#).

### Domain fault, Short-descriptor format translation tables only

When using the Short-descriptor translation table format, a Domain fault can be generated at the first level or second level of lookup. The reported fault code identifies the lookup level. The conditions for generating a Domain fault are:

**First level** When a first-level descriptor fetch returns a valid Section first-level descriptor, the domain field of that descriptor is checked against the `DACR`. A first-level Domain fault is generated if this check fails.

**Second level** When a second-level descriptor fetch returns a valid second-level descriptor, the domain field of the first-level descriptor that required the second-level fetch is checked against the `DACR`, and a second-level Domain fault is generated if this check fails.

For more information, see [Domains, Short-descriptor format only on page B3-1362](#).



Domain faults cannot occur on cache or branch predictor maintenance operations.

A TLB might hold a translation table entry that cause a Domain fault. Therefore, if the handling of a Domain fault results in an update to the associated translation tables, the software that updates the translation tables must invalidate the appropriate TLB entry, to prevent the stale information in the TLB being used on a subsequent memory access. For more information, see the translation table entry update examples in [TLB maintenance operations and the memory order model on page B3-1383](#).

Any change to the [DACR](#) must be synchronized by a context synchronization operation. For more information see [Synchronization of changes to system control registers on page B3-1461](#).

### Permission fault

A Permission fault can be generated at any level of lookup, and the reported fault code identifies the lookup level. See [Access permissions on page B3-1356](#) for information about conditions that cause a Permission fault.

———— **Note** —————

When using the Short-descriptor translation table format, the translation table descriptors are checked for Permission faults only for accesses to memory regions in Client domains.

A TLB might hold a translation table entry that cause a Permission fault. Therefore, if the handling of a Permission fault results in an update to the associated translation tables, the software that updates the translation tables must invalidate the appropriate TLB entry, to prevent the stale information in the TLB being used on a subsequent memory access. For more information, see the translation table entry update examples in [TLB maintenance operations and the memory order model on page B3-1383](#).

———— **Note** —————

In an implementation that includes the Virtualization Extensions, this maintenance requirement applies to Permission faults in both stage 1 and stage 2 translations.

Cache or branch predictor maintenance operations cannot cause a Permission fault, except that:

- a stage 1 translation table walk performed as part of a cache or branch predictor maintenance operation can generate a stage 2 Permission fault as described in [Stage 2 fault on a stage 1 translation table walk, Virtualization Extensions on page B3-1402](#).
- a [DCIMVAC](#) issued in Non-secure state that attempts to update data in a location for which it does not have stage 2 write access can generate a stage 2 Permission fault, as described in [Virtualization Extensions upgrading of maintenance operations on page B2-1286](#).

### B3.12.6 External aborts

The ARM architecture defines external aborts as errors that occur in the memory system, other than those that are detected by the MMU or Debug hardware. External aborts include parity errors detected by the caches or other parts of the memory system. An external abort is one of:

- synchronous
- precise asynchronous
- imprecise asynchronous.

For more information, see [Terminology for describing exceptions on page B1-1137](#).

The ARM architecture does not provide any method to distinguish between precise asynchronous and imprecise asynchronous aborts.

The ARM architecture handles asynchronous aborts in a similar way to interrupts, except that they are reported to the processor using the Data Abort exception. Setting the [CPSR.A](#) bit to 1 masks asynchronous aborts, see [Program Status Registers \(PSRs\) on page B1-1147](#).

Normally, external aborts are rare. An imprecise asynchronous external abort is likely to be fatal to the process that is running. An example of an event that might cause an external abort is an uncorrectable parity or ECC failure on a Level 2 Memory structure.

It is IMPLEMENTATION DEFINED which external aborts, if any, are supported.

VMSAv7 permits external aborts on data accesses, translation table walks, and instruction fetches to be either synchronous or asynchronous. The reported fault code identifies whether the external abort is synchronous or asynchronous.

———— **Note** —————

Because imprecise asynchronous external aborts are normally fatal to the process that caused them, ARM recommends that implementations make external aborts precise wherever possible.

The following subsections give more information about possible external aborts:

- [External abort on instruction fetch](#)
- [External abort on data read or write](#)
- [External abort on a translation table walk](#)
- [Behavior of external aborts on a translation table walk caused by address translation on page B3-1407](#)
- [Provision for classification of external aborts on page B3-1407](#)
- [Parity error reporting on page B3-1407](#).

The section [Exception reporting in a VMSA implementation on page B3-1409](#) describes the reporting of external aborts.

### External abort on instruction fetch

An external abort on an instruction fetch can be either synchronous or asynchronous. A synchronous external abort on an instruction fetch is taken precisely.

An implementation can report the external abort asynchronously from the instruction that it applies to. In such an implementation these aborts behave essentially as interrupts. The aborts are masked when [CPSR.A](#) is set to 1, otherwise they are reported using the Data Abort exception.

### External abort on data read or write

Externally-generated errors during a data read or write can be either synchronous or asynchronous.

An implementation can report the external abort asynchronously from the instruction that generated the access. In such an implementation these aborts behave essentially as interrupts. The aborts are masked when [CPSR.A](#) is set to 1, otherwise they are reported using the Data Abort exception.

### External abort on a translation table walk

An external abort on a translation table walk can be either synchronous or asynchronous. An external abort on a translation table walk is reported:

- if the external abort is synchronous, using:
  - a synchronous Prefetch Abort exception if the translation table walk is for an instruction fetch
  - a synchronous Data Abort exception if the translation table walk is for a data access
- if the external abort is asynchronous, using an asynchronous Data Abort exception.

If an implementation reports the error in the translation table walk asynchronously from executing the instruction whose instruction fetch or memory access caused the translation table walk, these aborts behave essentially as interrupts. The aborts are masked when [CPSR.A](#) is set to 1, otherwise they are reported using the Data Abort exception.

### **Behavior of external aborts on a translation table walk caused by address translation**

The address translation operations summarized in [Address translation operations, functional group on page B3-1498](#) require translation table walks. An external abort can occur in the translation table walk. The abort generates a Data Abort exception, and can be synchronous or asynchronous. For more information, see [Handling of faults and aborts during an address translation operation on page B3-1441](#).

### **Provision for classification of external aborts**

An implementation can use the `DFSR.ExT` and `IFSR.ExT` bits to provide more information about external aborts:

- `DFSR.ExT` can provide an IMPLEMENTATION DEFINED classification of external aborts on data accesses
- `IFSR.ExT` can provide an IMPLEMENTATION DEFINED classification of external aborts on instruction accesses.

For all aborts other than external aborts these bits return a value of 0.

### **Parity error reporting**

The ARM architecture supports the reporting of both synchronous and asynchronous parity errors from the cache systems. It is IMPLEMENTATION DEFINED what parity errors in the cache systems, if any, result in synchronous or asynchronous parity errors.

A fault code is defined for reporting parity errors, see [Exception reporting in a VMSA implementation on page B3-1409](#). However when parity error reporting is implemented it is IMPLEMENTATION DEFINED whether a parity error is reported using the assigned fault code, or using another appropriate encoding.

For all purposes other than the fault status encoding, parity errors are treated as external aborts.

## **B3.12.7 Prioritization of aborts**

This section describes the abort prioritization that applies to a single memory access that might generate multiple aborts:

On a single memory access, the following rules apply:

- If a memory access generates an Alignment fault because `SCTLR.A` is set to 1, or because it is an unaligned access by an instruction that does not support unaligned accesses, then that access cannot generate any of:
  - an MMU fault, on either the stage 1 translation or the stage 2 translation
  - an external abort
  - a Watchpoint debug event.
- In an implementation that includes the Virtualization Extensions, an Alignment fault generated by an unaligned access to Device or Strongly-ordered memory is prioritized as an MMU fault. For more information see [Alignment faults caused by accessing Device or Strongly-ordered memory on page B3-1408](#).
- If a memory access generates an MMU fault on its stage 1 translation, and also generates an abort on its stage 2 translation, the fault from the stage 1 translation has priority:
  - if a memory access made as part of a stage 1 translation table walk generates an MMU fault on its stage 2 translation, as described in [Stage 2 fault on a stage 1 translation table walk, Virtualization Extensions on page B3-1402](#), the stage 1 translation table walk does not generate an MMU fault on the stage 1 translation
  - a fault on a particular stage of translation might be a synchronous external abort on a translation table walk made at that stage of translation.
- If a memory access generates an MMU fault on either its stage 1 translation or on its stage 2 translation, then the processor cannot generate a Watchpoint debug event on that access.
- If a memory access generates an MMU fault on either its stage 1 translation or on its stage 2 translation, or generates a synchronous Watchpoint debug event, then the memory access cannot generate an external abort.
- Except as defined in this list, the architecture does not define any prioritization of asynchronous external aborts relative to any other asynchronous aborts.

If a single instruction generates aborts on more than one memory access, the architecture does not define any prioritization between those aborts.

In general, the ARM architecture does not define when asynchronous events are taken, and therefore the prioritization of asynchronous events is IMPLEMENTATION DEFINED.

———— **Note** —————

*Debug event prioritization on page C3-2076* describes:

- the relationship between debug events, MMU faults, and external aborts, for synchronous aborts generated by the same memory access
- the special requirement that applies to asynchronous watchpoints.

---

### **Alignment faults caused by accessing Device or Strongly-ordered memory**

In an implementation that includes the Virtualization Extensions, any unaligned access to Device or Strongly-ordered memory generates an Alignment fault. When applying the prioritization rules, this fault is prioritized as an MMU fault. The priority of this Alignment fault relative to possible MMU faults is as follows:

- the Alignment fault has lower priority than an Access flag fault
- if the translation stage that generates the Access flag fault:
  - can generate Domain faults, the Alignment fault has higher priority than a Domain fault
  - cannot generate Domain faults, the Alignment fault has higher priority than a Permission fault.

The MMU fault checking sequence in [Figure B3-24 on page B3-1401](#) shows this prioritization.

## B3.13 Exception reporting in a VMSA implementation

This section describes exception reporting in a VMSA implementation. The Virtualization Extensions introduce an enhanced reporting mechanism for exceptions taken to the Non-secure PL2 mode, Hyp mode. This means that, for a VMSA implementation, the exception reporting depends on the mode to which the exception is taken.

*About exception reporting* introduces the general approach to exception reporting, and the following sections then describe exception reporting at different privilege levels:

- [Reporting exceptions taken to PL1 modes on page B3-1410.](#)
- [Fault reporting in PL1 modes on page B3-1413](#)
- [Summary of register updates on faults taken to PL1 modes on page B3-1418](#)
- [Reporting exceptions taken to the Non-secure PL2 mode on page B3-1420](#)
- [Use of the HSR on page B3-1424](#)
- [Summary of register updates on exceptions taken to the PL2 mode on page B3-1435.](#)

---

### Note

The registers used for exception reporting also report information about debug exceptions. For more information see:

- [Data Abort exceptions, taken to a PL1 mode on page B3-1411](#)
  - [Prefetch Abort exceptions, taken to a PL1 mode on page B3-1413](#)
  - [Reporting exceptions taken to the Non-secure PL2 mode on page B3-1420.](#)
- 

### B3.13.1 About exception reporting

In an implementation that includes the Virtualization Extensions, exceptions can be taken to:

- a Secure or Non-secure PL1 mode
- the Non-secure PL2 mode, Hyp mode.

Otherwise, they are taken to a PL1 mode. Exception reporting in the PL2 mode differs significantly from that in the PL1 modes, but in general, exception reporting returns

- information about the exception:
  - on taking an exception to the PL2 mode, the *Hyp Syndrome Register*, [HSR](#), returns syndrome information
  - on taking an exception to a PL1 mode, a *Fault Status Register* (FSR) returns status information
- for synchronous exceptions, one or more addresses associated with the exceptions, returned in *Fault Address Registers* (FARs)

In both PL1 modes and the PL2 mode, additional IMPLEMENTATION DEFINED registers can provide additional information about exceptions.

---

### Note

- [Processor mode for taking exceptions on page B1-1172](#) describes how the mode to which an exception is taken is determined.
- The Virtualization Extensions introduce:
  - new exception types, that can only be taken from Non-secure PL1 and PL0 modes, and are always taken to Hyp mode
  - new routing controls that can route some exceptions from Non-secure PL1 and PL0 modes to Hyp mode.

These exceptions are reported using the same mechanism as the PL2 reporting of VMSA memory aborts, as described in this section.

---

Memory system faults generate either a Data Abort exception or a Prefetch Abort exception, as summarized in:

- [Reporting exceptions taken to PL1 modes](#)
- [Memory fault reporting at PL2 on page B3-1422.](#)

On an access that might have multiple aborts, the MMU fault checking sequence and the prioritization of aborts determine which abort occurs. For more information, see [The MMU fault-checking sequence on page B3-1398](#) and [Prioritization of aborts on page B3-1407.](#)

### B3.13.2 Reporting exceptions taken to PL1 modes

The following sections give general information about the reporting of exceptions when they are taken to a PL1 mode:

- [Registers used for reporting exceptions taken to a PL1 mode](#)
- [Data Abort exceptions, taken to a PL1 mode on page B3-1411](#)
- [Prefetch Abort exceptions, taken to a PL1 mode on page B3-1413.](#)

[Fault reporting in PL1 modes on page B3-1413](#) then describes the fault reporting in these modes, including the encodings used for reporting the faults.

#### Registers used for reporting exceptions taken to a PL1 mode

ARMv7 defines the following registers, and register encodings, for exceptions taken to PL1 modes:

- the [DFSR](#) holds information about a Data Abort exception
- the [DFAR](#) holds the faulting address for some synchronous Data Abort exceptions
- the [IFSR](#) holds information about a Prefetch Abort exception
- the [IFAR](#) holds the faulting address of a Prefetch Abort exception
- on a Watchpoint debug exception, the [DBGWFER](#) can hold fault information.

#### ————— Note —————

Before ARMv7, the *Data Fault Address Register (DFAR)* was called the *Fault Address Register (FAR)*.

In addition, if implemented, the optional [ADFSR](#) and [AIFSR](#) can provide additional fault information, see [Auxiliary Fault Status Registers](#).

#### Auxiliary Fault Status Registers

The ARMv7 architecture defines the following Auxiliary Fault Status Registers:

- the Auxiliary Data Fault Status Register, [ADFSR](#)
- the Auxiliary Instruction Fault Status Register, [AIFSR](#).

The position of these registers is architecturally-defined, but the content and use of the registers is IMPLEMENTATION DEFINED. An implementation can use these registers to return additional fault status information. An example use of these registers is to return more information for diagnosing parity errors.

An implementation that does not need to report additional fault information must implement these registers as UNK/SBZP. This ensures that an attempt to access these registers from software executing at PL1 does not cause an Undefined Instruction exception.

For more information, see [ADFSR and AIFSR, Auxiliary Data and Instruction Fault Status Registers, VMSA on page B4-1523](#)

## Data Abort exceptions, taken to a PL1 mode

On taking a Data Abort exception to a PL1 mode:

- If the exception is on an instruction cache or branch predictor maintenance operation by MVA, its reporting depends on the current translation table format. For more information about the registers used when reporting the exception, see *Data Abort on an instruction cache maintenance operation by MVA*.
- If the exception is generated by a Watchpoint debug event, then its reporting depends on whether the Watchpoint debug event is synchronous or asynchronous, and on the Debug architecture version. For more information, see *Data Abort on a Watchpoint debug event* on page B3-1412.

Otherwise:

- The **DFSR** is updated with details of the fault, including the appropriate fault status code.  
If the Data Abort exception is synchronous, **DFSR.WnR** is updated to indicate whether the faulted access was a read or a write. However, if the fault is:
  - on a cache maintenance operation, or on a CP15 address translation operation, **WnR** is set to 1, to indicate a write access fault, and if the implementation includes the Large Physical Address Extension, the **CM** bit is set to 1
  - generated by an **SWP** or **SWPB** instruction, **WnR** is set to 0 if a read of the location would have generated a fault, otherwise it is set to 1.**DFSR.WnR** is UNKNOWN on an asynchronous Data Abort exception.  
See the register description for more information about the returned fault information.
- If the Data Abort exception is
  - synchronous, the **DFAR** is updated with the VA that caused the exception
  - asynchronous, the **DFAR** becomes UNKNOWN.

For all Data Abort exceptions, if the implementation includes the Security Extensions, the security state of the processor in the mode to which the Data Abort exception is taken determines whether the Secure or Non-secure **DFSR** and **DFAR** are updated.

### Data Abort on an instruction cache maintenance operation by MVA

If an instruction cache or branch predictor invalidation by MVA operation generates a Data Abort exception that is taken to a PL1 mode, the **DFAR** is updated to hold the faulting VA. However, the reporting of the fault depends on the current translation table format:

#### Short-descriptor format

It is IMPLEMENTATION DEFINED which of the following is used when reporting the fault:

- The **DFSR** indicates an Instruction cache maintenance operation fault, and the **IFSR** is valid and indicates the cause of the fault, a Translation fault or Access flag fault.
- The **DFSR** indicates the cause of the fault, a Translation fault or Access flag fault. The **IFSR** is UNKNOWN.

In either case:

- **DFSR.WnR** is set to 1
- if the implementation includes the Large Physical Address Extension, **DFSR.CM** is set to 1, to indicate a fault on a cache maintenance operation.

#### Long-descriptor format

- **DFSR.CM** is set to 1, to indicate a fault on a cache maintenance operation
- **DFSR.STATUS** indicates the cause of the fault, a Translation or Access flag fault
- **DFSR.WnR** is set to 1
- the **IFSR** is UNKNOWN.

### Data Abort on a Watchpoint debug event

On taking a Data Abort exception caused by a Watchpoint debug event, **DFSR.FS** is updated to indicate a debug event, and **DFSR.{WnR, Domain}** are UNKNOWN.

The remaining register updates depend on the Debug architecture version, and in v7.1 debug, on whether the Watchpoint debug event is synchronous or asynchronous:

#### v7 Debug, and for an asynchronous Watchpoint debug event in v7.1 Debug

- **DFAR** is UNKNOWN
- **DBGWFAR** is set to the VA of the instruction that caused the watchpointed access, plus an offset that depends on the instruction set state of the processor for that instruction, as follows:
  - 8 for ARM state
  - 4 for Thumb or ThumbEE state
  - IMPLEMENTATION DEFINED for Jazelle state.

#### v7.1 Debug, for a synchronous Watchpoint debug event

- **DFAR** is set to the address that generated the watchpoint
- **DBGWFAR** is UNKNOWN.

A watchpointed address can be any byte-aligned address. The address reported in **DFAR** might not be the watchpointed address, and can be any address between and including:

- the lowest address accessed by the instruction that triggered the watchpoint
- the highest watchpointed address accessed by that instruction.

If multiple watchpoints are set in this range, there is no guarantee of which watchpoint is generated.

#### ———— Note —————

In particular, there is no guarantee of generating the watchpoint with the lowest address in the range.

In addition, it is IMPLEMENTATION DEFINED whether there is an additional restriction on the lowest value that might be reported in the **DFAR**, see *Synchronous Watchpoint debug event additional restriction on DFAR or HDFAR reporting, v7.1 Debug*.

#### ———— Note —————

For a synchronous Watchpoint debug event:

- in v7 Debug, both **LR\_abt** and **DBGWFAR** indicate the address of the instruction that triggered the watchpoint, and ARM deprecates using **DBGWFAR** to determine the address of this instruction.
- in v7.1 Debug, only **LR\_abt** indicates the address of the instruction that triggered the watchpoint

### Synchronous Watchpoint debug event additional restriction on DFAR or HDFAR reporting, v7.1 Debug

In v7.1 Debug, when reporting a synchronous Watchpoint debug event triggered by a Load or Store instruction, it is IMPLEMENTATION DEFINED whether there is an additional restriction on the lower value of the permitted range of values that might be reported in the **DFAR** or **HDFAR**. ARM recommends that implementations define such a restriction, and that the restriction requires that:

- For a Watchpoint debug event triggered by a Load or Store instruction, the lowest address that is reported in the **DFAR** or **HDFAR** is both:
  - no lower than the address of the watchpointed location rounded down to a multiple of an IMPLEMENTATION DEFINED number of bytes
  - no lower than the lowest address accessed by the instruction that triggered the watchpoint.
- The IMPLEMENTATION DEFINED number of bytes that defines this lowest address is a power of two, and less than or equal to the cache line size specified in **CCSIDR.LineSize**.



This additional restriction does not apply to any watchpoint generated by a cache maintenance instruction. For these instructions, the lowest address accessed by the instruction can be less than the address passed to the operation, because the operation acts on a whole cache line.

———— **Note** ————

A debugger can choose to ignore this restriction. However, a debugger can use this restriction to refine its interpretation of the value returned in the [DFAR](#) or [HDFAR](#).

There is no mechanism by which software can discover whether this restriction is implementation. The documentation of any implementation that includes this restriction must include a full description of its implementation of the restriction.

### **Prefetch Abort exceptions, taken to a PL1 mode**

For a Prefetch Abort exception generated by an instruction fetch, the Prefetch Abort exception is taken synchronously with the instruction that the abort is reported on. This means:

- If the processor attempts to execute the instruction a Prefetch Abort exception is generated.
- If an instruction fetch is issued but the processor does not attempt to execute the prefetched instruction, no Prefetch Abort exception is generated for that instruction. For example, if the execution flow branches round a prefetched instruction, no Prefetch Abort exception is generated.

In addition, debug exceptions caused by a BKPT instruction, Breakpoint, or a Vector catch debug event, generate a Prefetch Abort exception, see [Debug exception on BKPT instruction, Breakpoint, or Vector catch debug events on page C4-2088](#).

On taking a Prefetch Abort exception to PL1:

- The [IFSR](#) is updated with details of the fault, including the appropriate fault code. If appropriate, the fault code indicates that the exception was generated by a debug exception.  
See the register description for more information about the returned fault information.
- For a Prefetch Abort exception generated by an instruction fetch, the [IFAR](#) is updated with the VA that caused the exception.
- For a Prefetch Abort exception generated by a debug exception, the [IFAR](#) is UNKNOWN.

If the implementation includes the Security Extensions, the security state of the processor in the mode to which it takes the Prefetch Abort exception determines whether the exception updates the Secure or Non-secure [IFSR](#) and [IFAR](#).

### **B3.13.3 Fault reporting in PL1 modes**

The FSRs provide fault information, including an indication of the fault that occurred. The Large Physical Address Extension introduces:

- an alternative translation table format, the Long-descriptor format
- an alternative FSR format, used with the Long-descriptor translation tables
- an additional bit in the FSR format used with the Short-descriptor translation tables, [FSR.CM](#).

Therefore, the following subsections describe fault reporting in PL1 modes for each of the translation table formats:

- [PL1 fault reporting with the Short-descriptor translation table format on page B3-1414](#)
- [Fault reporting with the Long-descriptor translation table format on page B3-1416](#).

[Reserved encodings in the IFSR and DFSR encodings tables on page B3-1417](#) gives some additional information about the encodings for both formats.

[Summary of register updates on faults taken to PL1 modes on page B3-1418](#) shows which registers are updated on each of the reported faults.

*Reporting of External aborts taken from Non-secure state to Monitor mode* describes how the fault status register format is determined for those aborts. For all other aborts, the current translation table format determines the format of the fault status registers.

———— **Note** ————

Previous ARM documentation classified faults using the terms precise and imprecise instead of synchronous and asynchronous. For details of the more exact terminology introduced in this manual see *Terminology for describing exceptions* on page B1-1137.

## Reporting of External aborts taken from Non-secure state to Monitor mode

When an External abort is taken from Non-secure state to Monitor mode:

- for a Data Abort exception, the Secure **DFSR** and **DFAR** hold information about the abort
- for a Prefetch Abort exception, the Secure **IFSR** and **IFAR** hold information about the abort
- the abort does not affect the contents of the Non-secure copies of the fault reporting registers.

Normally, the current translation table format determines the format of the **DFSR** and **IFSR**. However, when **SCR.EA** is set to 1, to route external aborts to Monitor mode, and an external abort is taken from Non-secure state, this section defines the **DFSR** and **IFSR** format.

For an External abort taken from Non-secure state to Monitor mode, the **DFSR** or **IFSR** uses the format associated with the Long-descriptor translation table format, as described in *Fault reporting with the Long-descriptor translation table format* on page B3-1416, if any of the following applies:

- the Secure **TTBCR.EAE** bit is set to 1
- the External abort is synchronous and either:
  - it is taken from Hyp mode
  - it is taken from a Non-secure PL1 or PL0 mode, and the Non-secure **TTBCR.EAE** bit is set to 1.

Otherwise, the **DFSR** or **IFSR** uses the format associated with the Short-descriptor translation table format, as described in *PL1 fault reporting with the Short-descriptor translation table format*.

## PL1 fault reporting with the Short-descriptor translation table format

This subsection describes the fault reporting for a fault taken to a PL1 mode when either:

- the implementation does not include the Large Physical Address Extension
- the implementation includes the Large Physical Address Extension, and address translation is using the Short-descriptor translation table format.

On taking an exception, bit[9] of the FSR is RAZ, or set to 0, if the processor is using this FSR format.

An FSR encodes the fault in a 5-bit FS field, that comprises FSR[10, 3:0]. [Table B3-23 on page B3-1415](#) shows the encoding of that field. [Summary of register updates on faults taken to PL1 modes on page B3-1418](#) shows:

- Whether the corresponding FAR is updated on the fault. That is:
  - for a fault reported in the **IFSR**, whether the **IFAR** holds a valid address
  - for a fault reported in the **DFSR**, whether the **DFAR** holds a valid address
- For faults that update **DFSR**, whether **DFSR.Domain** is valid

When reading [Table B3-23 on page B3-1415](#):

- FS values not shown in the table are reserved
- FS values shown as **DFSR** only are reserved for the **IFSR**
- LPAE is an abbreviation for the Large Physical Address Extension.

**Table B3-23 Short-descriptor format FSR encodings**

FS	Source		Notes
00001	Alignment fault		DFSR only. Fault on first lookup
00100	Fault on instruction cache maintenance		DFSR only
01100 01110	Synchronous external abort on translation table walk	First level Second level	-
11100 11110	Synchronous parity error on translation table walk	First level Second level	-
00101 00111	Translation fault	First level Second level	MMU fault
00011 <sup>a</sup> 00110	Access flag fault	First level Second level	MMU fault
01001 01011	Domain fault	First level Second level	MMU fault
01101 01111	Permission fault	First level Second level	MMU fault
00010	Debug event		See <i>About debug events</i> on page C3-2036
01000	Synchronous external abort		-
10000	TLB conflict abort		See <i>TLB conflict aborts</i> on page B3-1380
10100	IMPLEMENTATION DEFINED		Lockdown
11010	IMPLEMENTATION DEFINED		Coprocessor abort
11001	Synchronous parity error on memory access		-
10110	Asynchronous external abort <sup>b</sup>		DFSR only
11000	Asynchronous parity error on memory access <sup>c</sup>		DFSR only

- a. Previously, this encoding was a deprecated encoding for Alignment fault. The extensive changes in the memory model in VMSAv7 mean there should be no possibility of confusing the new use of this encoding with its previous use
- b. Including asynchronous data external abort on translation table walk or instruction fetch.
- c. Including asynchronous parity error on translation table walk.

### **The Domain field in the DFSR**

The DFSR includes a Domain field. This is inherited from previous versions of the VMSA. The IFSR does not include a Domain field. *Summary of register updates on faults taken to PL1 modes* on page B3-1418 describes when DFSR.Domain is valid.

ARM deprecates any use of the Domain field in the DFSR. The Long-descriptor translation table format does not support a Domain field, and future versions of the ARM architecture might not support a Domain field in the Short-descriptor translation table format. ARM strongly recommends that new software does not use this field.

For both Data Abort exceptions and Prefetch Abort exceptions, software can find the domain information by performing a translation table read for the faulting address and extracting the Domain field from the translation table entry.

### Fault reporting with the Long-descriptor translation table format

This subsection describes the fault reporting for a fault taken to a PL1 mode in an implementation that includes the Large Physical Address Extension, when address translation is using the Long-descriptor translation table format.

When the processor takes an exception, bit[9] of the FSR is set to 1 if the processor is using this FSR format.

The FSRs encode the fault in a 6-bit STATUS field, that comprises FSR[5:0]. Table B3-24 shows the encoding of that field. In addition:

- For a fault taken to a PL1 mode, *Summary of register updates on faults taken to PL1 modes on page B3-1418* shows whether the corresponding FAR is updated on the fault. That is:
  - for a fault reported in the IFSR, whether the IFAR holds a valid address
  - for a fault reported in the DFSR, whether the DFAR holds a valid address
- For a fault taken to the PL2 mode, *Summary of register updates on exceptions taken to the PL2 mode on page B3-1435* shows what registers are updated on the fault

**Table B3-24 Long-descriptor format FSR encodings**

STATUS <sup>a</sup>	Source	Notes
0001LL	Translation fault. LL bits indicate level <sup>b</sup> .	MMU fault
0010LL	Access flag fault. LL bits indicate level <sup>b</sup> .	MMU fault
0011LL	Permission fault. LL bits indicate level <sup>b</sup> .	MMU fault
010000	Synchronous external abort.	-
011000	Synchronous parity error on memory access.	-
010001	Asynchronous external abort.	DFSR only
011001	Asynchronous parity error on memory access.	DFSR only
0101LL	Synchronous external abort on translation table walk. LL bits indicate level <sup>b</sup> .	-
0111LL	Synchronous parity error on memory access on translation table walk. LL bits indicate level <sup>b</sup> .	-
100001	Alignment fault.	Fault on first lookup
100010	Debug event.	See <i>About debug events on page C3-2036</i>
110000	TLB conflict abort.	See <i>TLB conflict aborts on page B3-1380</i>
110100	IMPLEMENTATION DEFINED.	Lockdown, DFSR only
111010	IMPLEMENTATION DEFINED.	Coprocessor abort, DFSR only
1111LL	Domain fault. LL bits indicate level <sup>b</sup> .	MMU fault. 64-bit PAR only, First or second level only. Never used in DFSR, IFSR, or HSR <sup>c</sup>

- STATUS values not shown in this table are reserved. STATUS values not supported in the IFSR or DFSR are reserved for the register or registers in which they are not supported.
- See *The level associated with MMU faults on page B3-1417*.
- A Domain fault can be reported using the Long-descriptor STATUS encodings only as a result of a fault on an address translation operation. For more information see *MMU fault on an address translation operation on page B3-1442*.

### The level associated with MMU faults

For MMU faults, Table B3-25 shows how the LL bits in the xFSR.STATUS field encode the lookup level associated with the fault.

**Table B3-25 Use of LL bits to encode the lookup level at which the fault occurred**

LL bits	Meaning
00	Reserved.
01	First level.
10	Second level.
11	Third level. When xFSR.STATUS indicates a Domain fault, this value is reserved.

The lookup level associated with a fault is:

- For a fault generated on a translation table walk, the lookup level of the walk being performed.
- For a Translation fault, the lookup level of the translation table that gave the fault. If a fault occurs because an MMU is disabled, or because the input address is outside the range specified by the appropriate base address register or registers, the fault is reported as a First level fault.
- For an Access flag fault, the lookup level of the translation table that gave the fault.
- For a Permission fault, including a Permission fault caused by hierarchical permissions, the lookup level of the final level of translation table accessed for the translation. That is, the lookup level of the translation table that returned a Block or Page descriptor.

### Reserved encodings in the IFSR and DFSR encodings tables

With both the Short-descriptor and the Long-descriptor FSR format, the fault encodings reserve a single encoding for each of:

- Cache and TLB lockdown faults. The details of these faults and any associated subsidiary registers are IMPLEMENTATION DEFINED.
- Aborts associated with coprocessors. The details of these faults are IMPLEMENTATION DEFINED.

### B3.13.4 Summary of register updates on faults taken to PL1 modes

For faults that generate exceptions that are taken to a PL1 mode, [Table B3-26](#) shows the registers affected by each fault. In this table:

- Yes indicates that the register is updated
- UNK indicates that the fault makes the register value UNKNOWN
- a null entry, -, indicates that the fault does not affect the register.

For faults that update the [DFSR](#) using the Short-descriptor format FSR encodings, [Table B3-27 on page B3-1419](#) shows whether [DFSR.Domain](#) is valid.

**Table B3-26 Effect of a fault taken to a PL1 mode on the reporting registers**

Fault	IFSR	IFAR	DFSR	DFAR	DBGWFSR	
Faults reported as Prefetch Abort exceptions:						
MMU fault, always synchronous.	Yes	Yes	-	-	-	
Synchronous external abort on translation table walk.	Yes	Yes	-	-	-	
Synchronous parity error on translation table walk.	Yes	Yes	-	-	-	
Synchronous external abort.	Yes	Yes	-	-	-	
Synchronous parity error on memory access.	Yes	Yes	-	-	-	
TLB conflict abort.	Yes	Yes	-	-	-	
Fault reported as Data Abort exception:						
Alignment fault, always synchronous.	-	-	Yes	Yes	-	
MMU fault, always synchronous.	-	-	Yes	Yes	-	
Fault on instruction cache maintenance, when using Long-descriptor translation table format <sup>a</sup> .	UNK	-	Yes	Yes	-	
Fault on instruction cache maintenance, when using Short descriptor translation table format <sup>b</sup> .	<i>either</i>	Yes	-	Yes	Yes	-
	<i>or</i>	UNK	-	Yes	Yes	-
Synchronous external abort on translation table walk.	-	-	Yes	Yes	-	
Synchronous parity error on translation table walk.	-	-	Yes	Yes	-	
Synchronous external abort.	-	-	Yes	Yes	-	
Synchronous parity error on memory access.	-	-	Yes	Yes	-	
Asynchronous external abort.	-	-	Yes	UNK	-	
Asynchronous parity error on memory access.	-	-	Yes	UNK	-	
TLB conflict abort.	-	-	Yes	Yes	-	

**Table B3-26 Effect of a fault taken to a PL1 mode on the reporting registers (continued)**

Fault		IFSR	IFAR	DFSR	DFAR	DBGWFR
Debug exceptions:						
Breakpoint, BKPT instruction, or Vector catch debug event <sup>c</sup> .		Yes	UNK	-	-	-
Synchronous Watchpoint debug event <sup>d</sup> .	v7 Debug	-	-	Yes	UNK	Yes
	v7.1 Debug	-	-	Yes	Yes	UNK
Asynchronous Watchpoint debug event <sup>d</sup> .		-	-	Yes	UNK	Yes

- a. When using the Long-descriptor translation table format, there is not a specific fault code for a fault on an instruction cache maintenance operation. For more information see [Data Abort on an instruction cache maintenance operation by MVA on page B3-1411](#).
- b. The two lines of this entry show the alternative ways of reporting the fault when using the Short-descriptor translation table format. It is IMPLEMENTATION DEFINED which methods is used, see [Data Abort on an instruction cache maintenance operation by MVA on page B3-1411](#).
- c. Generates a Prefetch Abort exception.
- d. Generates a Data Abort exception.

For those faults for which [Table B3-26 on page B3-1418](#) shows that the **DFSR** is updated, if the fault is reported using the Short-descriptor FSR encodings, [Table B3-27](#) shows whether **DFSR.Domain** is valid. In this table, UNK indicates that the fault makes **DFSR.Domain** UNKNOWN.

**Table B3-27 Validity of Domain field on faults that update the **DFSR** using the Short-descriptor encodings**

DFSR.FS	Source		DFSR.Domain	Notes
00001	Alignment fault		UNK	-
00100	Fault on instruction cache maintenance operation		UNK	-
01100 01110	Synchronous external abort on translation table walk	First level	UNK	-
		Second level	Valid	
11100 11110	Synchronous parity error on translation table walk	First level	UNK	-
		Second level	Valid	
00101 00111	Translation fault	First level	UNK	MMU fault
		Second level	Valid	
00011 <sup>a</sup> 00110	Access flag fault	First level	UNK	MMU fault
		Second level	Valid	
01001 01011	Domain fault	First level	Valid	MMU fault
		Second level	Valid	
01101	Permission fault	No LPAAE	First level	MMU fault
		With LPAAE	First level	
01111		No LPAAE	Second level	Valid
		With LPAAE	Second level	
01000	Synchronous external abort		UNK	-
10000	TLB conflict abort		UNK	-
11001	Synchronous parity error on memory access		UNK	-

**Table B3-27 Validity of Domain field on faults that update the DFSR using the Short-descriptor encodings (continued)**

DFSR.FS	Source	DFSR.Domain	Notes
10110	Asynchronous external abort <sup>b</sup>	UNK	-
11000	Asynchronous parity error on memory access <sup>c</sup>	UNK	-
00010	Watchpoint debug event, synchronous or asynchronous	UNK	

- a. Previously, this encoding was a deprecated encoding for Alignment fault. The extensive changes in the memory model in VMSAv7 mean there should be no possibility of confusing the new use of this encoding with its previous use
- b. Including asynchronous data external abort on translation table walk or instruction fetch.
- c. Including asynchronous parity error on translation table walk.

**Note**

As [Table B3-27 on page B3-1419](#) shows, if an implementation includes the Large Physical Address Extension, and address translation is using the Short-descriptor translation table format, on a Permission fault that causes a Data Abort exception, the DFSR.Domain field is UNKNOWN. This is a change from the architecturally-required behavior on an implementation that does not include the Large Physical Address Extension.

### B3.13.5 Reporting exceptions taken to the Non-secure PL2 mode

The Virtualization Extensions introduce Hyp mode as the Non-secure PL2 mode. Hyp mode is entered by taking an exception to Hyp mode.

**Note**

Software executing in Monitor mode can perform an exception return to Hyp mode. This means Hyp mode is entered either by taking an exception, or by a permitted exception return.

The following exceptions are taken to Hyp mode:

- Asynchronous external aborts, IRQ exceptions, and FIQ exceptions, from Non-secure PL0 and PL1 modes, if not routed to Secure Monitor mode, can each be routed to Hyp mode. For more information see [Asynchronous exception routing controls on page B1-1174](#).
- If HCR.TGE is set to 1, the following exceptions, if taken from the Non-secure PL0 mode, are routed to Hyp mode:
  - Undefined Instruction exceptions
  - Supervisor Call exception
  - synchronous external aborts
  - Alignment faults.
 For more information, see [Routing general exceptions to Hyp mode on page B1-1191](#).
- If HCR.TDE is set to 1, any Debug exception take from a Non-secure PL1 or PL0 mode, is routed to Hyp mode. For more information, see [Routing Debug exceptions to Hyp mode on page B1-1193](#).
- The privilege rules for taking exceptions mean that any exception taken from Hyp mode, if not routed to Secure Monitor mode, must be taken to Hyp mode. See [Exceptions, privilege, and security state on page B1-1138](#). This includes a Prefetch Abort exception generated by a Debug exception on a BKPT instruction.

**Note**

Debug exceptions other than the exception on a BKPT instruction are not permitted in Hyp mode.



- Hypervisor Call exceptions, and Hyp Trap exceptions, are always taken to Hyp mode. These exceptions are supported only as part of the Virtualization Extensions.  
In an implementation that includes the Virtualization Extensions, various operations from Non-secure PL0 and PL1 modes can be *trapped* to Hyp mode, using the Hyp Trap exception. For more information, see [Traps to the hypervisor on page B1-1247](#).

These exceptions include any memory system fault that occurs:

- on a memory access from Hyp mode
- on memory access from a Non-secure PL0 or PL1 mode:
  - on a stage 2 translation, from IPA to PA
  - on the stage 2 translation of an address accessed in performing a stage 1 translation table walk.

[Memory fault reporting at PL2 on page B3-1422](#) gives more information about these faults.

The following exceptions provide syndrome information *syndrome* information in the HSR:

- Any synchronous exception taken to Hyp mode.
- Some exceptions taken from Debug state that would be taken to Hyp mode if the processor was not in Debug state, see [Exceptions in Debug state on page C5-2105](#).

———— **Note** —————

- In Debug state, the processor does not change mode on taking an exception.
- As [Exceptions in Debug state on page C5-2105](#) describes, some other exceptions taken from Debug state make the HSR UNKNOWN.

The syndrome information in the HSR includes the fault status code otherwise provided by the fault status register, and greatly extends the fault reporting. For more information, see [Use of the HSR on page B3-1424](#).

In addition, for a Debug exception taken to Hyp mode, `DBGDSCR.MOE` shows what caused the Debug exception. This bit is valid regardless of whether the Debug exception was taken from Hyp mode or from another Non-secure mode.

[Registers used for reporting exceptions taken to Hyp mode](#) lists all of the registers used for exception reporting at PL2.

## Registers used for reporting exceptions taken to Hyp mode

The Virtualization Extensions define the following registers for exceptions taken to Hyp mode:

- the HSR holds syndrome information for the exception
- the HDFAR holds the VA associated with a Data Abort exception
- the HIFAR holds the VA associated with a Prefetch Abort exception
- the HPFAR holds bits[39:12] of the IPA associated with a Prefetch Abort exception.

In addition, if implemented, the optional HADFSR and HAIFSR can provide additional fault information, see [Hyp Auxiliary Fault Syndrome Registers](#).

### Hyp Auxiliary Fault Syndrome Registers

The Virtualization Extensions define the following Hyp Auxiliary Fault Syndrome Registers:

- the Hyp Auxiliary Data Fault Syndrome Register, HADFSR
- the Hyp Auxiliary Instruction Fault Syndrome Register, HAIFSR.

An implementation can use these registers to return additional fault status information for aborts taken to Hyp mode. They are the Hyp mode equivalents of the registers described in [Auxiliary Fault Status Registers on page B3-1410](#). An example use of these registers is to return more information for diagnosing parity errors.

The architectural requirements for the HADFSR and HAIFSR are:

- The position of these registers is architecturally-defined, but the content and use of the registers is IMPLEMENTATION DEFINED.
- An implementation with no requirement for additional fault reporting can implement these registers as UNK/SBZP, but the architecture does not require it to do so.

For more information, see *HADFSR and HAIFSR, Hyp Auxiliary Fault Syndrome Registers, Virtualization Extensions* on page B4-1575.

### Memory fault reporting at PL2

Prefetch Abort and Data Abort exceptions taken to Hyp mode report memory faults. For these aborts, the HSR contains the following fault status information:

- The HSR.EC field indicates the type of abort, as Table B3-28 shows.
- The HSR.ISS field holds more information about the abort. In particular:
  - bits[5:0] of this field hold the STATUS field for the abort, using the encodings defined in *Fault reporting with the Long-descriptor translation table format* on page B3-1416
  - other subfields of the ISS give more information about the exception, equivalent to the information returned in the FSR for a memory fault reported at PL1.

See the descriptions of the ISS fields for the memory faults, referenced from the *Syndrome description* column of Table B3-28, for information about the returned fault information.

**Table B3-28 HSR.EC encodings for aborts taken to Hyp mode**

HSR.EC	Abort	Syndrome description
0x20	Prefetch Abort taken from Non-secure PL0 or PL1 mode	<i>ISS encoding for Prefetch Abort exceptions taken to Hyp mode</i> on page B3-1431
0x21	Prefetch Abort taken from Hyp mode	
0x24	Data Abort taken from Non-secure PL0 or PL1 mode	<i>ISS encoding for Data Abort exceptions taken to Hyp mode</i> on page B3-1433
0x25	Data Abort taken from Hyp mode	

For more information, see *Use of the HSR* on page B3-1424.

A Prefetch Abort exception is taken synchronously with the instruction that the abort is reported on. This means:

- If the processor attempts to execute the instruction a Prefetch Abort exception is generated.
- If an instruction fetch is issued but the processor does not attempt to execute the prefetched instruction, no Prefetch Abort exception is generated for that instruction. For example, if the execution flow branches round a prefetched instruction, no Prefetch Abort exception is generated.

### Register updates on exception reporting at PL2

The use of the HSR, and of the other registers listed in *Registers used for reporting exceptions taken to Hyp mode* on page B3-1421, depends on the cause of the Abort. In reporting these faults, in general:

- If the fault generates a synchronous Data Abort exception, the HDFAR holds the associated VA.
- If the fault generates a Prefetch Abort exception, the HIFAR holds the associated VA.
- In the following cases, the HPFAR holds the faulting IPA:
  - a Translation or Access flag fault on a stage 2 translation
  - a fault on the stage 2 translation of an address accessed in a stage 1 translation table walk.

In all other cases, the HPFAR is UNKNOWN.

- On a Data Abort exception that is taken to Hyp mode, the **HIFAR** is UNKNOWN.
- On a Prefetch Abort exception that is taken to Hyp mode, the **HDFAR** is UNKNOWN.

In addition, the reporting of particular aborts is as follows:

#### **Abort on the stage 1 translation for a memory access from Hyp mode**

The **HDFAR** or **HIFAR** holds the VA that caused the fault. The STATUS subfield of **HSR.ISS** indicates the type of fault, Translation, Access flag, or Permission. The **HPFAR** is UNKNOWN.

#### **Abort on the stage 2 translation for a memory access from a Non-secure PL1 or PL0 mode**

This includes aborts on the stage 2 translation of a memory access made as part of a translation table walk for a stage 1 translation. The **HDFAR** or **HIFAR** holds the VA that caused the fault. The STATUS subfield of **HSR.ISS** indicates the type of fault, Translation, Access flag, or Permission.

For any Access flag fault or Translation fault, and also for any Permission fault on the stage 2 translation of a memory access made as part of a translation table walk for a stage 1 translation, the **HPFAR** holds the IPA that caused the fault. Otherwise, the **HPFAR** is UNKNOWN.

#### **Abort caused by a synchronous external abort, or synchronous parity error, and taken to Hyp mode**

The **HDFAR** or **HIFAR** holds the VA that caused the fault. The **HPFAR** is UNKNOWN.

#### **Abort caused by a Watchpoint debug event and routed to Hyp mode because HDCR.TDE is set to 1**

When **HDCR.TDE** is set to 1, a debug exception on a Watchpoint debug event, generated in a Non-secure PL1 or PL0 mode, that would otherwise generate a Data Abort exception, is routed to Hyp mode and generates a Hyp Trap exception.

The reporting of the exception depends on whether the Watchpoint debug event is synchronous or asynchronous:

##### **Synchronous Watchpoint debug event**

**HDFAR** is set to the address that generated the watchpoint, and **DBGWFAR** is UNKNOWN.

A watchpointed address can be any byte-aligned address. The address reported in **HDFAR** might not be the watchpointed address, and can be any address between and including:

- the lowest address accessed by the instruction that triggered the watchpoint
- the highest watchpointed address accessed by that instruction.

If multiple watchpoints are set in this range, there is no guarantee of which watchpoint is generated.

##### **Note**

In particular, there is no guarantee of generating the watchpoint with the lowest address in the range.

In addition, it is IMPLEMENTATION DEFINED whether there is an additional restriction on the lowest value that might be reported in the **HDFAR**. It is IMPLEMENTATION DEFINED whether this restriction, described in *Synchronous Watchpoint debug event additional restriction on DFAR or HDFAR reporting, v7.1 Debug on page B3-1412*:

- is implemented
- applies to both **DFAR** and **HDFAR**, if it is implemented.

##### **Asynchronous Watchpoint debug event**

**HDFAR** is UNKNOWN, and **DBGWFAR** is set to the VA of the instruction that caused the watchpointed access, plus an offset that depends on the instruction set state of the processor for that instruction, as follows:

- 8 for ARM state
- 4 for Thumb or ThumbEE state
- IMPLEMENTATION DEFINED for Jazelle state.

See also *Debug exception on Watchpoint debug event* on page C4-2089.

In all cases, **HPFAR** is UNKNOWN.

#### **Prefetch Abort caused by a Debug exception on a BKPT instruction debug event and taken to Hyp mode**

This abort is generated if a BKPT instruction is executed in Hyp mode. The abort leaves the **HIFAR** and **HPFAR** UNKNOWN.

See also *Debug exception on BKPT instruction, Breakpoint, or Vector catch debug events* on page C4-2088.

#### **Abort caused by a BKPT instruction, Breakpoint, or Vector catch debug event, and routed to Hyp mode because HDCR.TDE is set to 1**

When **HDCR.TDE** is set to 1, a debug exception, generated in a Non-secure PL1 or PL0 mode, that would otherwise generate a Prefetch Abort exception, is routed to Hyp mode and generates a Hyp Trap exception.

The abort leaves the **HIFAR** and **HPFAR** UNKNOWN. This is identical to the reporting of a Prefetch Abort exception caused by a Debug exception on a BKPT instruction that is executed in Hyp mode.

#### **Note**

The difference between these two cases is:

- the Debug exception on a BKPT instruction executed in Hyp mode generates a Prefetch Abort exception, taken to Hyp mode, and reported in the **HSR** using EC value 0x21.
- aborts generated because **HDCR.TDE** is set to 1 generate a Hyp Trap exception, and are reported in the **HSR** using EC value 0x20.

### **B3.13.6 Use of the HSR**

The **HSR** holds syndrome information for any synchronous exception taken to Hyp mode. Compared with the reporting of exceptions taken to PL1 modes, the **HSR**:

- Always provides details of the fault. The **DFSR** and **IFSR** are not used.
- Provides more extensive information, for a wider range of exceptions.

#### **Note**

IRQ and FIQ exceptions taken to Hyp mode do not report any syndrome information in the **HSR**.

The general format of the **HSR** is that it comprises:

- A 6-bit exception class field, EC, that indicates the cause of the exception.
- An instruction length bit, IL. When an exception is caused by trapping an instruction to Hyp mode, this bit indicates the length of the trapped instruction, as follows:
  - 0** 16-bit instruction trapped.
  - 1** 32-bit instruction trapped.

This field is not valid for the following cases:

- when the EC field is 0x00, indicating an exception with an unknown reason
- Instruction Aborts
- Data Aborts that do not have ISS information, or for which the ISS is not valid.

In these cases, the IL field is UNK/SBZP.

- An instruction specific syndrome field, ISS. Architecturally, this field can be defined independently for each defined exception class.

This field is not valid, UNK/SBZP, when the EC field is 0x00, indicating an exception with an unknown reason.

Figure B3-25 shows the format of the HSR, with the subdivision of the ISS field that applies to nonzero EC values with the two most significant bits 0b00.

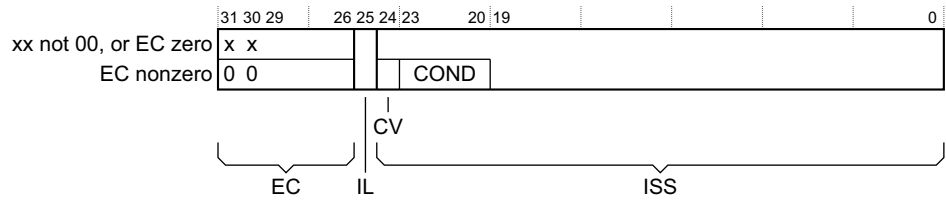

Figure B3-25 Format of the HSR, with subdivision of the ISS field for specified EC encodings

### HSR exception classes and associated ISS encodings

Table B3-29 shows the encoding of the HSR exception class field, EC. Values of EC not shown in the table are reserved. The table divides the EC values into three groups, relating to the interpretation of the associated ISS fields. For each EC value, the table references a subsection that gives information about:

- the cause of the exception, for example the configuration required to enable the trap
- the encoding of the associated ISS.

Table B3-29 HSR.EC field encoding

EC	Exception class	ISS description, or notes
0x00	Unknown reason	<i>Exceptions with an unknown reason on page B3-1426.</i>
Nonzero EC values with HSR[31:30] zero <sup>a</sup>		
0x01	Trapped WFI or WFE instruction	<i>ISS encoding for trapped WFI or WFE instruction on page B3-1427.</i>
0x03	Trapped MCR or MRC access to CP15	<i>ISS encoding for trapped MCR or MRC access on page B3-1427.</i>
0x04	Trapped MCRR or MRRC access to CP15	<i>ISS encoding for trapped MCRR or MRRC access on page B3-1428.</i>
0x05	Trapped MCR or MRC access to CP14	<i>ISS encoding for trapped MCR or MRC access on page B3-1427.</i>
0x06	Trapped LDC or STC access to CP14	<i>ISS encoding for trapped LDC or STC access on page B3-1429.</i>
0x07	HCPTR-trapped access to CP0-CP13	<i>ISS encoding for HCPTR-trapped access to CP0-CP13 on page B3-1430.</i> Includes trap on use of Advanced SIMD.
0x08	Trapped MRC or VMRS access to CP10, for ID group traps	<i>ISS encoding for trapped MCR or MRC access on page B3-1427.</i> This trap is not taken if the HCPTR settings trap the access.
0x0A	Trapped BXJ instruction	<i>ISS encoding for trapped BXJ execution on page B3-1430.</i>
0x0C	Trapped MRRC access to CP14	<i>ISS encoding for trapped MCRR or MRRC access on page B3-1428.</i>

**Table B3-29 HSR.EC field encoding (continued)**

EC	Exception class	ISS description, or notes
EC values with HSR[31:30] nonzero		
0x11	Supervisor Call exception routed to Hyp mode	<i>ISS encoding for Hypervisor Call exception, or Supervisor Call exception routed to Hyp mode on page B3-1430.</i>
0x12	Hypervisor Call	
0x13	Trapped SMC instruction	<i>ISS encoding for trapped SMC execution on page B3-1431.</i>
0x20	Prefetch Abort routed to Hyp mode	<i>ISS encoding for Prefetch Abort exceptions taken to Hyp mode on page B3-1431.</i>
0x21	Prefetch Abort taken from Hyp mode	
0x24	Data Abort routed to Hyp mode	<i>ISS encoding for Data Abort exceptions taken to Hyp mode on page B3-1433.</i>
0x25	Data Abort taken from Hyp mode	

- a. For more information see [Encoding of ISS\[24:20\] when HSR\[31:30\] is 0b00](#).

All EC encodings not shown in [Table B3-28 on page B3-1422](#) are reserved by ARM.

#### **Exceptions with an unknown reason**

An HSR.EC value of 0x00 indicates an exception with an unknown reason. Any exception not covered by a nonzero EC value defined in [Table B3-29 on page B3-1425](#) returns this value. When HSR.EC returns a value of 0x00, all other fields of HSR are invalid.

[Undefined Instruction exception, when HCR.TGE is set to 1 on page B1-1191](#) describes the configuration settings for a trap that returns an HSR.EC value of 0x00.

#### **Encoding of ISS[24:20] when HSR[31:30] is 0b00**

For EC values that are nonzero and have the two most-significant bits 0b00, ISS[24:20] provides the condition code field for the trapped instruction, together with a valid flag for this field. The encoding of this part of the ISS field is:

**CV, ISS[24]** Condition code valid. Possible values of this bit are:

0	The COND field is not valid.
1	The COND field is valid

#### **COND, ISS[23:20]**

The condition code for the trapped instruction. This field is valid only when CV is set to 1. If CV is set to 0, this field is UNK/SBZP.

When an ARM instruction is trapped, CV is set to 1 and:

- if the instruction is conditional, COND is set to the condition code field value from the instruction
- if the instruction is unconditional, COND is set to 0xE.

A conditional ARM instruction that is known to pass its condition code check can be presented either:

- with COND set to 0xE, the value for unconditional
- with the COND value held in the instruction.

When a Thumb instruction is trapped, it is IMPLEMENTATION DEFINED whether:

- CV set to 0 and COND is set to an UNKNOWN value
- CV set to 1 and COND is set to the condition code for the condition that applied to the instruction.

When CV is set to 0, software must examine the SPSR.IT field to determine the conditionality of a Thumb instruction.

Except for unconditional Thumb instructions reported with CV set to 0, a trapped unconditional instruction is reported with CV set to 1 and a COND value of 0x0E, the condition code value for unconditional.

For an implementation that, for both ARM and Thumb instructions, takes an exception on a trapped conditional instruction only if the instruction passes its condition code check, these definitions mean that when CV is set to 1 it is IMPLEMENTATION DEFINED whether the COND field is set to 0xE, or to the value of any condition that applied to the instruction.

———— **Note** ————

In some circumstances, it is IMPLEMENTATION DEFINED whether a conditional instruction that fails its condition code check generates an Undefined Instruction exception, see [Conditional execution of undefined instructions on page B1-1208](#).

**ISS encoding for trapped WFI or WFE instruction**

This is the exception with EC value 0x01. When HSR.EC returns this value, the encoding of the ISS field is:

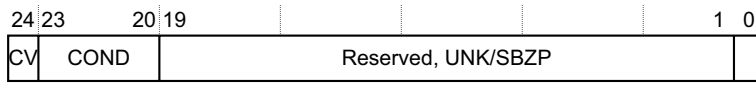

Trapped instruction ↴

**ISS[24:20]** See [Encoding of ISS\[24:20\] when HSR\[31:30\] is 0b00 on page B3-1426](#).

**ISS[19:1]** Reserved, UNK/SBZP.

**ISS[0]** Indicates the trapped instruction. The possible values of this bit are:

- 0**           WFI trapped.
- 1**           WFE trapped.

[Trapping use of the WFI and WFE instructions on page B1-1255](#) describes the configuration settings for this trap.

**ISS encoding for trapped MCR or MRC access**

These are the exceptions with the following EC values:

- 0x03, trapped MRC or MCR access to CP15
- 0x05, trapped MRC or MCR access to CP14
- 0x08, trapped MRC or VMRS access to CP10.

When HSR.EC returns one of these values, the encoding of the ISS field is:

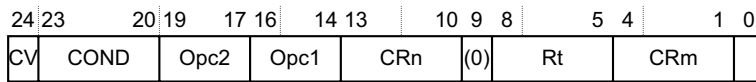

Direction ↴

**ISS[24:20]** See [Encoding of ISS\[24:20\] when HSR\[31:30\] is 0b00 on page B3-1426](#).

**ISS[19:17]** The Opc2 value from the issued instruction.

**ISS[16:14]** The Opc1 value from the issued instruction.

**ISS[13:10]** The CRn value from the issued instruction, the coprocessor primary register value.

**ISS[9]** Reserved, UNK/SBZP.

**ISS[8:5]** The Rt value from the issued instruction, the ARM core register used for the transfer.

**ISS[4:1]** The CRm value from the issued instruction.

**ISS[0]** Indicates the direction of the trapped instruction. The possible values of this bit are:

- 0**           Write to coprocessor. MCR instruction.
- 1**           Read from coprocessor. MRC or VMRS instruction.



The following sections describe configuration settings for traps that are reported using EC value 0x03:

- [Trapping ID mechanisms](#) on page B1-1250
- [Trapping accesses to lockdown, DMA, and TCM operations](#) on page B1-1252
- [Trapping accesses to cache maintenance operations](#) on page B1-1253
- [Trapping accesses to TLB maintenance operations](#) on page B1-1253
- [Trapping accesses to the Auxiliary Control Register](#) on page B1-1253
- [Trapping accesses to the Performance Monitors Extension](#) on page B1-1254
- [Trapping CPACR accesses](#) on page B1-1257
- [Generic trapping of accesses to CP15 system control registers](#) on page B1-1258.

The following sections describe configuration settings for traps that are reported using EC value 0x05:

- [ID group 0, Primary device identification registers](#) on page B1-1251
- [Trapping accesses to Jazelle functionality](#) on page B1-1255, for accesses to Jazelle registers
- [Trapping accesses to the ThumbEE configuration registers](#) on page B1-1255
- [Trapping CP14 accesses to Debug ROM registers](#) on page B1-1259
- [Trapping CP14 accesses to OS-related debug registers](#) on page B1-1259
- [Trapping general CP14 accesses to debug registers](#) on page B1-1260
- [Trapping CP14 accesses to trace registers](#) on page B1-1260.

[Trapping ID mechanisms](#) on page B1-1250 describes configuration settings for traps that are reported using EC value 0x08.

#### ISS encoding for trapped MCRR or MRRC access

These are the exceptions with the following EC values:

- 0x04, trapped MRRC or MCRR access to CP15
- 0x0C, trapped MRRC access to CP14.

When HSR.EC returns one of these values, the encoding of the ISS field is:

24	23	20	19	16	15	14	13	10	9	8	5	4	1	0
CV	COND	Opc1	(0)	(0)	Rt2	(0)	Rt	CRm						

Direction ↯

**ISS[24:20]** See [Encoding of ISS\[24:20\] when HSR\[31:30\] is 0b00](#) on page B3-1426.

**ISS[19:16]** The Opc1 value from the issued instruction.

**ISS[15:14]** Reserved, UNK/SBZP.

**ISS[13:10]** The Rt2 value from the issued instruction, one of the ARM core registers for the transfer.

**ISS[9]** Reserved, UNK/SBZP.

**ISS[8:5]** The Rt value from the issued instruction, one of the ARM core registers for the transfer.

**ISS[4:1]** The CRm value from the issued instruction, the coprocessor primary register value.

**ISS[0]** Indicates the direction of the trapped instruction. The possible values of this bit are:

- 0** Write to coprocessor, MCRR instruction.
- 1** Read from coprocessor, MRRC instruction.

The following sections describe configuration settings for traps that are reported using EC value 0x04:

- [Trapping writes to virtual memory control registers](#) on page B1-1257
- [Generic trapping of accesses to CP15 system control registers](#) on page B1-1258.

The following sections describe configuration settings for traps that are reported using EC value 0x0C:

- [Trapping general CP14 accesses to debug registers](#) on page B1-1260
- [Trapping CP14 accesses to Debug ROM registers](#) on page B1-1259.



**ISS encoding for trapped LDC or STC access**

This is the exception with EC value 0x06. When HSR.EC returns this value, the encoding of the ISS field is:

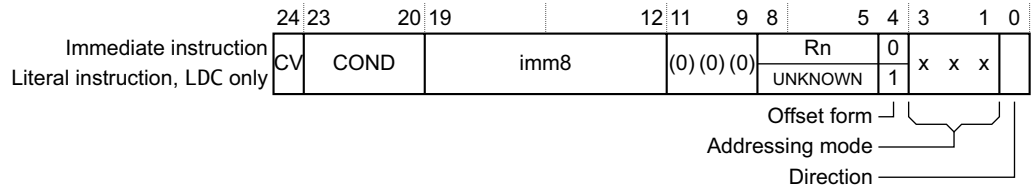

- ISS[24:20]** See [Encoding of ISS\[24:20\] when HSR\[31:30\] is 0b00](#) on page B3-1426.
- ISS[19:12]** imm8. The immediate value from the issued instruction.
- ISS[11:9]** Reserved, UNK/SBZP.
- ISS[8:5]** Encoding depends on the instruction form indicated by ISS[3]:  
**ISS[3]==0** Encodes Rn, the ARM core register that holds the base address. Applies only to immediate instruction forms.  
**ISS[3]==1** UNKNOWN. Applies only to literal instruction forms, that are available only for LDC instructions
- ISS[4]** Indicates whether the offset is added or subtracted:  
**0** Subtract offset.  
**1** Add offset.  
 This bit corresponds to the U bit in the instruction encoding.
- ISS[3:1]** Addressing mode. The permitted values of this field are:  
 0b000 Immediate unindexed.  
 0b001 Immediate post-indexed.  
 0b010 Immediate offset.  
 0b011 Immediate pre-indexed.  
 0b100 Literal unindexed.  
 LDC instruction in ARM instruction set only.  
 For a trapped STC instruction or a trapped LDC Thumb instruction, this encoding is reserved.  
 0b101 Reserved.  
 0b110 Literal offset.  
 LDC instruction only.  
 For a trapped STC instruction, this encoding is reserved.  
 0b111 Reserved.  
 ISS[3] indicates the instruction form, immediate or literal. See the description of ISS[8:5].  
 ISS[2:1] correspond to the bits {P, W} in the instruction encoding.
- ISS[0]** Indicates the direction of the trapped instruction. The possible values of this bit are:  
**0** Write to coprocessor. STC instruction.  
**1** Read from coprocessor, LDC instruction.

———— **Note** ————

The only architected uses of these instructions to access CP14 are:

- an STC to write to [DBGDTRRXint](#)
- an LDC to read [DBGDTRTXint](#).

For more information see [CP14 debug register interface accesses on page C6-2122](#).

[Trapping general CP14 accesses to debug registers on page B1-1260](#) describes the configuration settings for the trap that is reported using EC value 0x06.

**ISS encoding for HCPTR-trapped access to CP0-CP13**

This is the exception with EC value 0x07. When [HSR.EC](#) returns this value, the encoding of the ISS field is:

24	23	20	19					6	5	4	3	0
CV	COND	Reserved, UNK/SBZP						(0)	coproc			

Trapped Advanced SIMD —┘

**ISS[24:20]** See [Encoding of ISS\[24:20\] when HSR\[31:30\] is 0b00 on page B3-1426](#).

**ISS[19:6]** Reserved, UNK/SBZP.

**ISS[5]** Indicates trapped use of the Advanced SIMD Extension. The possible values of this bit are:  
**0** Exception was not caused by trapped use of the Advanced SIMD Extension.  
**1** Exception was caused by trapped use of the Advanced SIMD Extension.

Any use of an Advanced SIMD instruction that is trapped to Hyp mode because of a trap configured in the [HCPTR](#) sets this bit to 1.

**ISS[4]** Reserved, UNK/SBZP.

**ISS[3:0]** coproc. The number of the coprocessor accessed by the trapped operation, 0-13.  
 This field is valid only when [ISS\[5\]](#) returns 0. Otherwise, it is UNK/SBZP.

Any use of a Floating-point instruction or access to a Floating-point Extension register that is trapped to Hyp mode because of a trap configured in the [HCPTR](#) sets this field to 0xA.

The following sections describe the configuration settings for the traps that are reported using EC value 0x07:

- [Trapping of Advanced SIMD functionality on page B1-1256](#)
- [General trapping of coprocessor accesses on page B1-1257](#)

**ISS encoding for trapped BXJ execution**

This is the exception with EC value 0x0A. When [HSR.EC](#) returns this value, the encoding of the ISS field is:

24	23	20	19					4	3	0
CV	COND	Reserved, UNK/SBZP						Rm		

**ISS[24:20]** See [Encoding of ISS\[24:20\] when HSR\[31:30\] is 0b00 on page B3-1426](#).

**ISS[19:4]** Reserved, UNK/SBZP.

[Trapping accesses to Jazelle functionality on page B1-1255](#) describes the configuration settings for this trap.

**ISS encoding for Hypervisor Call exception, or Supervisor Call exception routed to Hyp mode**

These are the exceptions with the following EC values:

- 0x11, Supervisor Call exception taken to Hyp mode
- 0x12, Hypervisor Call exception.

**Note**

- A Supervisor Call exception is generated by executing an SVC instruction, see [SVC \(previously SWI\) on page A8-720](#).
- A Hypervisor Call exception is generated by executing an HVC instruction, see [HVC on page B9-1982](#).

When `HSR.EC` returns one of these values, the encoding of the ISS field is:



**ISS[24:16]** Reserved, UNK/SBZP.

**ISS[15:0]** imm16. The value of the immediate field from the issued instruction.

For an SVC instruction:

- if the instruction is unconditional:
  - for the 16-bit Thumb instruction, this field is zero-extended from the imm8 field of the instruction
  - for the ARM instruction, this field is the bottom 16 bits of the imm24 field of the instruction
- if the instruction is conditional, this field is UNKNOWN.

**Note**

The HVC instruction is unconditional, and a conditional SVC instruction generates a Supervisor Call exception that is routed to Hyp mode only if it passes its condition code check. Therefore, the syndrome information for these exceptions does not include conditionality information.

[Supervisor Call exception, when `HCR.TGE` is set to 1 on page B1-1191](#) describes the configuration settings for the trap reported with EC value `0x11`.

**ISS encoding for trapped SMC execution**

This is the exception with EC value `0x13`. When `HSR.EC` returns this value, the ISS field does not return any syndrome information, and the encoding of the ISS field is:

**ISS[24:0]** Reserved, UNK/SBZP.

**Note**

SMC instructions cannot be trapped if they fail their condition code check. Therefore, the syndrome information for this exception does not include conditionality information.

[Trapping use of the SMC instruction on page B1-1254](#) describes the configuration settings for this trap, for instructions executed in Non-secure PL1 modes.

**ISS encoding for Prefetch Abort exceptions taken to Hyp mode**

These are the exceptions with the following EC values:

- `0x20`, for a Prefetch Abort exception taken from a mode other than Hyp mode and routed to Hyp mode
- `0x21`, for a Prefetch Abort exception taken from Hyp mode.

When [HSR](#).EC returns one of these values, the encoding of the ISS field is:

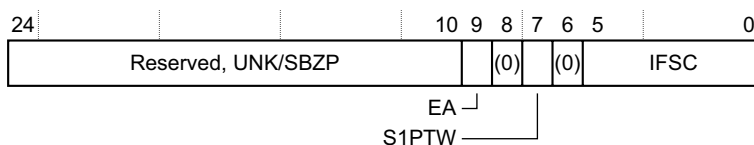

**ISS[24:10]** Reserved, UNK/SBZP.

**ISS[9]** EA, External abort type. Can provide an IMPLEMENTATION DEFINED classification of external aborts. If the implementation does not provide any classification of external aborts, this bit is UNK/SBZP.

For any abort other than an External abort this bit returns a value of 0.

**————— Note —————**

This bit is equivalent to the [IFSR](#).Ext bit.

**ISS[8]** Reserved, UNK/SBZP.

**ISS[7]** S1PTW. For a stage 2 fault, indicates whether the fault was a fault on the stage 2 translation of an address accessed during a stage 1 translation table walk:

**0** Fault not on a stage 2 translation for a stage 1 translation table walk.

**1** Fault on the stage 2 translation of an access for a stage 1 translation table walk.

For a stage 1 fault, this bit is UNK/SBZP.

**ISS[6]** Reserved, UNK/SBZP.

**ISS[5:0]** IFSC, Instruction fault status code. Indicates the fault that caused the exception, using the fault codes defined for use with the Long-descriptor translation table format, see [Fault reporting with the Long-descriptor translation table format](#) on page B3-1416.

**————— Note —————**

This field is equivalent to the [IFSR](#).STATUS field, and only valid [IFSR](#).STATUS values are valid for this field.

The following sections describe cases where Prefetch Abort exceptions can be routed to Hyp mode, generating exceptions that are reported in the [HSR](#) with EC value 0x20:

- [Synchronous external abort, when HCR.TGE is set to 1](#) on page B1-1192.
- [Routing Debug exceptions to Hyp mode](#) on page B1-1193.

**ISS encoding for Data Abort exceptions taken to Hyp mode**

These are the exceptions with the following EC values:

- 0x24, for a Data Abort exception taken from a mode other than Hyp mode and routed to Hyp mode
- 0x25, for a Data Abort exception taken from Hyp mode.

When HSR.EC returns one of these values, the encoding of the ISS field is:

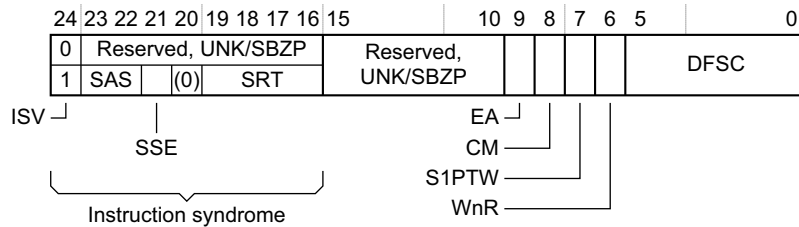

**ISS[24]** Instruction syndrome valid. Indicates whether ISS[24:16] provide a valid instruction syndrome, as part of the returned ISS. The possible values of this bit are:

- 0** No valid instruction syndrome. ISS[23:16] are UNK/SBZP.
- 1** ISS[24:16] hold a valid instruction syndrome.

This bit is 0 for all faults except for those generated by a stage 2 translation. For Data Abort exceptions generated by a stage 2 translation, this bit is 1 and a valid instruction syndrome is returned only if all of the following are true:

- the instruction that generated the Data Abort exception:
  - is an LDR, LDRT, LDRSH, LDRSHT, LDRH, LDRHT, LDRSB, LDERSBT, LDRB, LDRBT, STR, STRT, STRH, STRHT, STRB, or STRBT
  - is not performing register writeback
  - is not using the PC as its destination register.

**Note**

- For ISS reporting, a stage 2 abort on a stage 1 translation table lookup is treated as a stage 1 Translation fault, and does not return a valid instruction syndrome.
- In the ARM instruction set, LDR\*T and STR\*T instructions always perform register writeback and therefore never return a valid instruction syndrome.
- A valid instruction syndrome provides information that can help a hypervisor to emulate the instruction efficiently. Instruction syndromes are returned for instructions for which such accelerated emulation is possible.

**ISS[23:16], when ISS[24] is 0**

Reserved, UNK/SBZP.

**ISS[23:16], when ISS[24] is 1**

The remainder of the valid instruction syndrome, defined as follows:

**ISS[23:22]** SAS, Syndrome access size. Indicate the size of the access attempted by the faulted operation. The possible values of this field are:

- 0b00 Byte.
- 0b01 Halfword.
- 0b10 Word.
- 0b11 Reserved.

**ISS[21]** SSE, Syndrome sign extend. For a byte or halfword load operation, indicates whether the data item must be sign extended. For these cases, the possible values of this bit are:

- 0** Sign-extension not required.
- 1** Data item must be sign-extended.

For all other operations this bit is 0.

**ISS[20]** Reserved, UNK/SBZP.

**ISS[19:16]** SRT, Syndrome Register Transfer. The value of the Rt operand of the faulting instruction. This specifies:

- the destination register for a load operation
- the source register for a store operation.

———— **Note** —————

Normally, software emulating an instruction must consider both the Rt value and the Mode value saved in the [SPSR](#), to determine the physical register to access.

**ISS[15:10]** Reserved, UNK/SBZP.

**ISS[9]** EA, External abort type. Can provide an IMPLEMENTATION DEFINED classification of external aborts. If the implementation does not provide any classification of external aborts, this bit is UNK/SBZP.

For any abort other than an External abort this bit returns a value of 0.

———— **Note** —————

This bit is equivalent to the [DFSR.ExT](#) bit.

**ISS[8]** CM, Cache maintenance. For a synchronous fault, identifies fault that comes from a cache maintenance or address translation operation. For synchronous faults, the possible values of this bit are:

- 0** Fault not generated by a cache maintenance or address translation operation.
- 1** Fault generated by a cache maintenance or address translation operation.

For asynchronous faults, this bit is 0.

———— **Note** —————

This bit is equivalent to the [DFSR.CM](#) bit.

**ISS[7]** S1PTW. For a stage 2 fault, indicates whether the fault was a fault on the stage 2 translation of an address accessed during a stage 1 translation table walk:

- 0** Fault not on a stage 2 translation for a stage 1 translation table walk.
- 1** Fault on the stage 2 translation of an access for a stage 1 translation table walk.

For a stage 1 fault, this bit is UNK/SBZP.

**ISS[6]** WnR. Indicates whether a synchronous abort was caused by a write or a read operation. The possible values of this bit are:

- 0** Abort caused by a read operation.
- 1** Abort caused by a write operation.

For synchronous faults on cache maintenance and address translation operations, this bit always returns a value of 1.

———— **Note** —————

ISS[8] is set to 1 to identify a fault on a cache maintenance or address translation operation.

For an asynchronous Data Abort exception this bit is UNKNOWN.

For a fault generated by an SWP or SWPB instruction, the WnR bit is 0 if a read to the location would have generated a fault, otherwise it is 1.

———— **Note** —————

This bit is equivalent to the [DFSR.WnR](#) bit.

**ISS[5:0]** DFSC, Data fault status code. Indicates the fault that caused the exception, using the fault codes defined for use with the Long-descriptor translation table format, see [Fault reporting with the Long-descriptor translation table format on page B3-1416](#).

**Note**

This field is equivalent to the **DFSR.STATUS** field, and all valid **DFSR.STATUS** values are valid for this field.

The following describe cases where Data Abort exceptions can be routed to Hyp mode, generating exceptions that are reported in the **HSR** with EC value 0x24:

- [Alignment fault, when HCR.TGE is set to 1 on page B1-1192](#).
- [Synchronous external abort, when HCR.TGE is set to 1 on page B1-1192](#).
- [Routing Debug exceptions to Hyp mode on page B1-1193](#).

### B3.13.7 Summary of register updates on exceptions taken to the PL2 mode

For memory system faults that generate exceptions that are taken to Hyp mode, [Table B3-30](#) shows the registers affected by each fault. In this table:

- Yes indicates that the register is updated
- UNK indicates that the fault makes the register value UNKNOWN
- a null entry, -, indicates that the fault does not affect the register.

**Table B3-30 Effect of an exception taken to the PL2 mode on the reporting registers**

Fault	HSR	HIFAR	HDFAR	HPFAR	DBGWFAR
Faults reported as Prefetch Abort exceptions:					
MMU fault <sup>a</sup> at stage 1.	Yes	Yes	UNK	UNK	-
MMU Translation or Access flag fault <sup>a</sup> at stage 2.	Yes	Yes	UNK	Yes	-
MMU Permission fault <sup>a</sup> at stage 2.	Yes	Yes	UNK	UNK	-
MMU stage 2 fault <sup>a</sup> on stage 1 translation.	Yes	Yes	UNK	Yes	-
Synchronous external abort on translation table walk.	Yes	Yes	UNK	UNK	-
Synchronous parity error on translation table walk.	Yes	Yes	UNK	UNK	-
Synchronous external abort.	Yes	Yes	UNK	UNK	-
Synchronous parity error on memory access.	Yes	Yes	UNK	UNK	-
TLB conflict abort.	Yes	Yes	UNK	UNK	-

**Table B3-30 Effect of an exception taken to the PL2 mode on the reporting registers (continued)**

Fault	HSR	HIFAR	HDFAR	HPFAR	DBGWFAR
Fault reported as Data Abort exception:					
Alignment fault, always synchronous	Yes	UNK	Yes	UNK	-
MMU fault <sup>a</sup> at stage 1.	Yes	UNK	Yes	UNK	-
MMU Translation or Access flag fault <sup>a</sup> at stage 2.	Yes	UNK	Yes	Yes	-
MMU Permission fault <sup>a</sup> at stage 2.	Yes	UNK	Yes	UNK	-
MMU stage 2 fault <sup>a</sup> on stage 1 translation.	Yes	UNK	Yes	Yes	-
Synchronous external abort on translation table walk.	Yes	UNK	Yes	UNK	-
Synchronous parity error on translation table walk.	Yes	UNK	Yes	UNK	-
Synchronous external abort.	Yes	UNK	Yes	UNK	-
Synchronous parity error on memory access.	Yes	UNK	Yes	UNK	-
Asynchronous external abort.	Yes	UNK	UNK	UNK	-
Asynchronous parity error on memory access.	Yes	UNK	UNK	UNK	-
TLB conflict abort.	Yes	UNK	Yes	UNK	-
Debug exception:					
BKPT instruction debug event <sup>b</sup> , generates a Prefetch Abort exception.	Yes	UNK	-	UNK	-
Debug exception routed to Hyp mode because <code>HDCCR.TDE</code> is set to 1. Generates a Hyp Trap exception.					
Breakpoint, BKPT instruction, or Vector catch debug event	Yes	UNK	-	UNK	-
Watchpoint exception, on synchronous watchpoint.	Yes	-	Yes	UNK	UNK
Watchpoint exception, on asynchronous watchpoint.	Yes	-	UNK	UNK	Yes

a. For more information see [Classification of MMU faults taken to the PL2 mode on page B3-1437](#).

b. All other debug exceptions are not permitted in Hyp mode.

———— **Note** ————

Unlike [Table B3-26 on page B3-1418](#), the PL2 fault reporting table does not include an entry for a fault on an instruction cache maintenance operation. That is because, when the fault is taken to the PL2 mode, the reporting indicates the cause of the fault, for example a Translation fault, and `ISS.CM` is set to 1 to indicate that the fault was on a cache maintenance operation, see [ISS encoding for Data Abort exceptions taken to Hyp mode on page B3-1433](#).



## Classification of MMU faults taken to the PL2 mode

This subsection gives more information about the MMU faults shown in [Table B3-30 on page B3-1435](#).

———— **Note** —————

All MMU faults are synchronous.

The table uses the following descriptions for MMU faults taken to the PL2 mode:

**MMU fault at stage 1** This is an MMU fault generated on a stage 1 translation performed in the Non-secure PL2 translation regime.

**MMU fault at stage 2** This is an MMU fault generated on a stage 2 translation performed in the Non-secure PL1&0 translation regime.

As the table shows, for the faults in this group:

- Translation and Access flag faults update the [HPFAR](#)
- Permission faults leave the [HPFAR](#) UNKNOWN.

**MMU stage 2 fault on a stage 1 translation**

This is an MMU fault generated on the stage 2 translation of an address accessed in a stage 1 translation table walk performed in the Non-secure PL1&0 translation regime. For more information about these faults see [Stage 2 fault on a stage 1 translation table walk, Virtualization Extensions](#) on page B3-1402.

[Figure B3-1 on page B3-1309](#) shows the different translation regimes and associated stages of translation.

## B3.14 Virtual Address to Physical Address translation operations

CP15 c7 includes operations for *Virtual Address (VA) to Physical Address (PA) translation*. [Address translation operations, functional group on page B3-1498](#) summarizes these operations. Each of the following architecture extensions affects the details of these operations:

- the Security Extensions
- the Large Physical Address Extension
- the Virtualization Extensions.

When using the Short-descriptor translation table format, all VA to PA translations take account of TEX remap when this is enabled, see [Short-descriptor format memory region attributes, with TEX remap on page B3-1368](#).

———— **Note** —————

A processor that does not implement the Large Physical Address Extension always uses the Short-descriptor translation table format.

A VA to PA translation operation returns the PA in the **PAR**. The Large Physical Address Extension extends the **PAR** to 64 bits, to hold PAs of up to 40 bits.

The following sections give more information about these operations:

- [Naming of the address translation operations, and operation summary](#)
- [Encoding and availability of the address translation operations on page B3-1440](#)
- [Determining the PAR format, Large Physical Address Extension on page B3-1441](#)
- [Handling of faults and aborts during an address translation operation on page B3-1441](#).

### B3.14.1 Naming of the address translation operations, and operation summary

The Virtualization Extensions introduce additional address translation operations. Therefore, the older operations are renamed to give consistent naming for all operations. The operation names now indicate the corresponding translation stage. In an implementation that does not include the Virtualization Extensions, there is no distinction between stage 1 translations and stage 1 and 2 combined translations.

**Table B3-31 Naming of address translation operations**

Name	Old name	Description
<a href="#">ATS1CPR, ATS1CPW, ATS1CUR, ATS1CUW</a>	V2PCWPR, V2PCWPW, V2PCWUR, V2PCWUW	See <a href="#">Address translation stage 1, current security state on page B3-1439</a>
<a href="#">ATS12NSOPR, ATS12NSOPW, ATS12NSOUR, ATS12NSOUW</a>	V2POWPR, V2POWPW, V2POWUR, V2POWUW	See <a href="#">Address translation stages 1 and 2, Non-secure state only on page B3-1439</a>
<a href="#">ATS1HR, ATS1HW</a>	Not applicable <sup>a</sup>	See <a href="#">Address translation stage 1, Hyp mode on page B3-1440</a>

a. Operations are part of the Virtualization Extensions and have no equivalent in the older descriptions.

In the *stage 1 current state* and *stages 1 and 2 Non-secure state only* operations, the meanings of the last two letters of the names are:

- PR** PL1 mode, read operation.
- PW** PL1 mode, write operation.
- UR** PL0 mode, read operation.
- UW** PL0 mode, write operation.

———— **Note** —————

PL0 modes can also be described as unprivileged modes. User mode is the only PL0 mode.

In the *stage 1 Hyp mode* operations, the last letter of the operation name is **R** for the read operation and **W** for the write operation.

The following sections describe the use and availability of these operations:

- [Address translation stage 1, current security state](#)
- [Address translation stages 1 and 2, Non-secure state only](#)
- [Address translation stage 1, Hyp mode on page B3-1440](#).

[Encoding and availability of the address translation operations on page B3-1440](#) gives the encodings of the operations.

### Address translation stage 1, current security state

These are the `ATS1Cxx` operations. Any VMSAv7 implementation supports these operations. They can be executed by any software executing at PL1 or higher, in either security state.

These instructions perform the address translations of the PL1&0 translation regime of the current security state. In an implementation that includes the Virtualization Extensions, when executed in Non-secure state, they return the IPA that is the output address of the stage 1 translation. [Figure B3-1 on page B3-1309](#) shows the different translation regimes.

#### ———— **Note** —————

The Non-secure PL1 and PL0 modes have no visibility of the stage 2 address translations, that can be defined only at PL2, and translate IPAs to be PAs.

For an implementation that includes the Large Physical Address Extension, see [Determining the PAR format, Large Physical Address Extension on page B3-1441](#) for the format used when returning the result of these operations.

### Address translation stages 1 and 2, Non-secure state only

These are the `ATS12NSOxx` operations. A VMSAv7 implementation supports these operations only if it includes the Security Extensions. They can be executed:

- By any software executing in Secure state at PL1.
- If the implementation includes the Virtualization Extensions, by software executing in Non-secure state at PL2. This means by software executing in Hyp mode.

ARM deprecates use of these operations from any Secure PL1 mode other than Monitor mode.

In Secure state, and in Non-secure Hyp mode on an implementation that includes the Virtualization Extensions, these operations perform the translations made by the Non-secure PL1&0 translation regime.

These operations always return the PA and final attributes generated by the translation. That is, for an implementation that includes the Virtualization Extensions, they return:

- the result of the two stages of address translation for the specified Non-secure input address.
- the memory attributes obtained by the combination of the stage 1 and stage 2 attributes.

#### ———— **Note** —————

From Hyp mode, the `ATS1Cxx` and `ATS12NSOxx` operations both return the results of address translations that would be performed in the Non-secure modes other than Hyp mode. The difference is:

- The `ATS1Cxx` operations return the Non-secure PL1 view of these operations. That is, they return the IPA output address corresponding to the VA input address.
- The `ATS12NSOxx` operations return the PL2, or Hyp mode, view of these operations. That is, they return the PA output address corresponding to the VA input address, generated by two stages of translation.

For an implementation that includes the Large Physical Address Extension, see [Determining the PAR format, Large Physical Address Extension on page B3-1441](#) for the format used when returning the result of these operations.

### Address translation stage 1, Hyp mode

These are the ATS1Hx operations. A VMSAv7 implementation supports these operations only if it includes the Virtualization Extensions. They can be executed by:

- Software executing in Non-secure state at PL2. This means by software executing in Hyp mode.
- Software executing in Secure state in Monitor mode.

These operations are UNPREDICTABLE if used in a Secure PL1 mode other than Monitor mode.

These operations perform the translations made by the Non-secure PL2 translation regime. The operation takes a VA input address and returns a PA output address.

These operations always return a result in a 64-bit format [PAR](#).

### B3.14.2 Encoding and availability of the address translation operations

Software executing at PL0 never has any visibility of the address translation operations, but software executing at PL1 or higher can use the unprivileged address translation operations to find the address translations used for memory accesses by software executing at PL0 and PL1.

———— **Note** ————

For information about translations when the MMU is disabled see [Address translation operations when the MMU is disabled on page B4-1749](#).

[Table B3-32](#) shows the encodings for the address translation operations, and their availability in different implementations in different processor modes and states.

**Table B3-32 CP15 c7 address translation operations**

opc1	CRm	opc2	Name	Type	Description
All VMSAv7 implementations, in all modes, at PL1 or higher					
0	c8	0	<a href="#">ATS1CPR</a>	WO	PL1 stage 1 read translation, current state <sup>a</sup>
		1	<a href="#">ATS1CPW</a>	WO	PL1 stage 1 write translation, current state <sup>a</sup>
		2	<a href="#">ATS1CUR</a>	WO	Unprivileged stage 1 read translation, current state <sup>a</sup>
		3	<a href="#">ATS1CUW</a>	WO	Unprivileged stage 1 write translation, current state <sup>a</sup>
Implementations that include the Security Extensions, in Secure PL1 modes and Non-secure Hyp mode					
0	c8	4	<a href="#">ATS12NSOPR</a>	WO	Non-secure PL1 stage 1 and 2 read translation <sup>b</sup>
		5	<a href="#">ATS12NSOPW</a>	WO	Non-secure PL1 stage 1 and 2 write translation <sup>b</sup>
		6	<a href="#">ATS12NSOUR</a>	WO	Non-secure unprivileged stage 1 and 2 read translation <sup>b</sup>
		7	<a href="#">ATS12NSOUW</a>	WO	Non-secure unprivileged stage 1 and 2 write translation <sup>b</sup>
Implementations that include the Virtualization Extensions, in Non-secure Hyp mode and Secure Monitor mode					
4	c8	0	<a href="#">ATS1HR</a>	WO	Hyp mode stage 1 read translation <sup>c</sup>
		1	<a href="#">ATS1HW</a>	WO	Hyp mode stage 1 write translation <sup>c</sup>

- For more information about these operations see [Address translation stage 1, current security state on page B3-1439](#).
- For more information about these operations see [Address translation stages 1 and 2, Non-secure state only on page B3-1439](#).
- For more information about these operations see [Address translation stage 1, Hyp mode](#).

The result of an operation is always returned in the **PAR**. The **PAR** is a RW register and:

- in all implementations, the 32-bit format **PAR** is accessed using an MCR or MRC instruction with CRn set to c7, CRm set to c4, and opc1 and opc2 both set to 0
- in an implementation that includes the Large Physical Address Extension, the 64-bit format **PAR** is accessed using an MCRR or MRRC instruction with CRm set to c7, and opc1 set to 0.

CP15 c7 address translation operations that are not available in a particular implementation are reserved and UNPREDICTABLE. For example, in an implementation that does not include the Security Extensions, the encodings with opc2 values of 4-7, and the encodings with an opc1 value of 4, are reserved and UNPREDICTABLE.

### B3.14.3 Determining the **PAR** format, Large Physical Address Extension

The Large Physical Address Extension extends the **PAR** to become a 64-bit register, and supports both 32-bit and 64-bit **PAR** formats. This section describes how the **PAR** format is determined, for returning a result from each of the groups of address translation operations. The returned result might be the translated address, or might indicate a fault on the translation, see *Handling of faults and aborts during an address translation operation*.

#### ATS1Cxx operations

Address translations for the current state. From modes other than Hyp mode:

- **TTBCR.EAE** determines whether the result is returned using the 32-bit or the 64-bit **PAR** format.
- If the implementation includes the Security Extensions, the translation performed is for the current security state and, depending on that state:
  - the Secure or Non-secure **TTBCR.EAE** determines the **PAR** format.
  - the result is returned to the Secure or Non-secure copy of the **PAR**

Operations from Hyp mode always return a result to the Non-secure **PAR**, using the 64-bit format.

#### ATS12NSOxx operations

Address translations for the Non-secure PL1 and PL0 modes. These operations return a result using the 64-bit **PAR** format if at least one of the following is true:

- the Non-secure **TTBCR.EAE** bit is set to 1
- the implementation includes the Virtualization Extensions, and **HCR.VM** is set to 1.

Otherwise, the operation returns a result using the 32-bit **PAR** format.

Operations from a Secure PL1 mode return a result to the Secure **PAR**. Operations from Hyp mode return a result to the Non-secure **PAR**.

#### ATS1Hx operations

Address translations from Hyp mode. These operations always return a result using the 64-bit **PAR** format.

Operations from Secure Monitor mode return a result to the Secure **PAR**. Operations from Non-secure Hyp mode return a result to the Non-secure **PAR**.

### B3.14.4 Handling of faults and aborts during an address translation operation

When an MMU is enabled, any corresponding address translation operation requires a translation table lookup, and this might require a translation table walk. However, the input address for the translation might be a faulting address, either because:

- the translation table entries used for the translation indicate a fault
- a stage 2 fault or an external abort occurs on the required translation table walk.

*VMSA memory aborts on page B3-1395* describes the faults that might occur on a translation table walk.

How the fault is handled, and whether it generates an exception, depends on the cause of the fault, as described in:

- [MMU fault on an address translation operation](#)
- [External abort during an address translation operation](#)
- [Stage 2 fault on a current state address translation operation on page B3-1443.](#)

### MMU fault on an address translation operation

In the following cases, an MMU fault on an address translation is reported in the [PAR](#), and no abort is taken. This applies:

- For a faulting address translation operation executed in Hyp mode, or in a Secure PL1 mode.
- For a faulting address translation operation executed in a Non-secure PL1 mode, for cases where the fault would generate a stage 1 abort if it occurred on the on the equivalent load or store operation.

[Using the PAR to report a fault on an address translation operation](#) gives more information about how these faults are reported.

#### ————— Note —————

- The Domain fault encodings shown in [Table B3-24 on page B3-1416](#) are used only for reporting a fault on an address translation operation that uses the 64-bit [PAR](#) format. That is, they are used only in an implementation that includes the Virtualization Extensions, and are used for reporting a Domain fault on either:
  - an [ATS1Cxx](#) operation from Hyp mode
  - an [ATS12NSOxx](#) operation when [HCR.VM](#) is set to 1.These encodings are never used for fault reporting in the [DFSR](#), [IFSR](#), or [HSR](#).
- For an address translation operation executed in a Non-secure PL1 mode, for a fault that would generate a stage 2 abort if it occurred on the equivalent load or store operation, the stage 2 abort is generated as described in [Stage 2 fault on a current state address translation operation on page B3-1443.](#)

### Using the PAR to report a fault on an address translation operation

For a fault on an address translation operation for which no abort is taken, the [PAR](#) is updated with the following information, to indicate the fault:

- The fault code, that would normally be written to the Fault status register. The code used depends on the current translation table format, as described in either:
  - [PL1 fault reporting with the Short-descriptor translation table format on page B3-1414](#)
  - [Fault reporting with the Long-descriptor translation table format on page B3-1416.](#)See also the Note at the start of [Determining the PAR format, Large Physical Address Extension on page B3-1441](#) about the Domain fault encodings shown in [Table B3-24 on page B3-1416.](#)
- A status bit, that indicates that the translation operation failed.

The fault does not update any Fault Address Register.

### External abort during an address translation operation

As stated in [Behavior of external aborts on a translation table walk caused by address translation on page B3-1407](#), an external abort on a translation table walk generates a Data Abort exception. The abort can be synchronous or asynchronous, and behaves as follows:

#### Synchronous external abort on a translation table walk

The fault status and fault address registers of the security state to which the abort is taken are updated. The fault status register indicates the appropriate external abort on Translation fault, and the fault address register indicates the input address for the translation.

The [PAR](#) is UNKNOWN.

### Asynchronous external abort on a translation table walk

The fault status register of the security state to which the abort is taken is updated, to indicate the asynchronous external abort. No fault address registers are updated.

The **PAR** is UNKNOWN.

### Stage 2 fault on a current state address translation operation

If the processor is in a Non-secure PL1 mode and performs one of the ATS1C\*\* operations, then a fault in the stage 2 translation of an address accessed in a stage 1 translation table lookup generates an exception. This is equivalent to the case described in *Stage 2 fault on a stage 1 translation table walk, Virtualization Extensions* on page B3-1402. When this fault occurs on an ATS1C\*\* address translation operation:

- a Hyp Trap exception is taken to Hyp mode
- the **PAR** is UNKNOWN
- the **HSR** indicates that:
  - the fault occurred on a translation table walk
  - the operation that faulted was a cache maintenance operation
- the **HPFAR** holds the IPA that faulted
- the **HDFAR** holds the VA that the executing software supplied to the address translation operation.

## B3.15 About the system control registers for VMSA

On an ARMv7-A or ARMv7-R implementation, the system control registers comprise:

- the registers accessed using the System Control Coprocessor, CP15
- registers accessed using the CP14 coprocessor, including:
  - debug registers
  - trace registers
  - execution environment registers.

### ———— Note ————

Do not confuse this general term, *system control registers*, with the full name of the [SCTLR](#), described in [SCTLR, System Control Register, VMSA](#) on page B4-1705.

[Organization of the CP14 registers in a VMSA implementation](#) on page B3-1468 summarizes the CP14 registers, and indicates where the CP14 registers are described, either in this manual or in other architecture specifications.

[Organization of the CP15 registers in a VMSA implementation](#) on page B3-1469 summarizes the CP15 registers, and indicates where in this manual the CP15 registers are described.

This section gives general information about the control registers, the CP14 and CP15 interfaces to these registers, and the conventions used in describing these registers.

### ———— Note ————

Many implementations include other interfaces to some functional groups of CP14 and CP15 registers, for example memory-mapped interfaces to the CP14 Debug registers. These are described in the appropriate sections of this manual.

This section is organized as follows:

- [About system control register accesses](#)
- [General behavior of system control registers](#) on page B3-1446
- [Classification of system control registers](#) on page B3-1451
- [Effect of the LPAE and Virtualization Extensions on the system control registers](#) on page B3-1460
- [Synchronization of changes to system control registers](#) on page B3-1461
- [Meaning of fixed bit values in register diagrams](#) on page B3-1466.

### B3.15.1 About system control register accesses

Before the introduction of the Large Physical Address Extension, Virtualization Extensions, and Generic Timer, in ARMv7 all control registers were 32-bits wide. [Accessing 32-bit control registers](#) on page B3-1445 describes how these registers are accessed.

### ———— Note ————

Optionally, an ARMv6 implementation can include some block transfer operations that are accessed using 64-bit CP15 accesses, see [Block transfer operations](#) on page AppxL-2534.

The Large Physical Address Extension, Virtualization Extensions, and the OPTIONAL Generic Timer introduce a small number of 64-bit control registers. [Accessing 64-bit control registers](#) on page B3-1445 describes how these registers are accessed.

When using the MCR, MRC, MCRR, and MRRC instructions to access these registers, the instruction arguments include:

- a coprocessor identifier, coproc, as a value p0-p15, corresponding to CP0-CP15
- a coprocessor register, CRn or CRm, as a value c0-c15, to specify a coprocessor register number
- an opcode, opc1 or opc2, as a value in the range 0-7.



---

**Note**

- When accessing CP15, the primary coprocessor register is the top-level indicator of the accessed functionality, and when:
    - using an MCR or MRC instruction, CRn specifies the primary coprocessor register
    - using an MCRR or MRRC instruction, CRm specifies the primary coprocessor register.
  - When accessing CP14 using any of these instructions, opc1 is the top-level indicator of the accessed functionality.
- 

### Ordering of reads of system control registers

Reads of the system control registers can occur out of order with respect to earlier instructions executed on the same processor, provided that the data dependencies between the instructions, specified in [Synchronization of changes to system control registers on page B3-1461](#), are met.

---

**Note**

In particular, system control registers holding self-incrementing counts, for example the Performance Monitors counters or the Generic Timer counter or timers, can be read *early*. This means that, for example, if a memory communication is used to communicate a read of the Generic Timer counter, an ISB must be inserted between the read of the memory location used for this communication and the read of the Generic Timer counter if it is required that the Generic Timer counter returns a count value that is later than the memory communication.

---

### Accessing 32-bit control registers

Software accesses a 32-bit control register using the generic MCR and MRC coprocessor interface, specifying:

- A coprocessor identifier, coproc, identifying one of coprocessors CP0-CP15.
- Two coprocessor registers, CRn and CRm. CRn specifies the primary coprocessor register.
- Two coprocessor-specific opcodes, opc1 and opc2.
- An ARM core register to hold a 32-bit value to transfer to or from the coprocessor.

CP15 and CP14 provides the control registers. A processor access to a specific 32-bit control register uses:

- p15 to specify CP15, or p14 to specify CP14
- a unique combination of CRn, opc1, CRm, and opc2, to specify the required control register
- an ARM core register for the transferred 32-bit value.

The processor accesses a 32-bit control register using:

- an MCR instruction to write to a control register, see [MCR, MCR2 on page A8-476](#)
- an MRC instruction to read a control register, see [MRC, MRC2 on page A8-492](#).

### Accessing 64-bit control registers

Software accesses a 64-bit control register using the generic MCRR and MRRC coprocessor interface, specifying:

- A coprocessor identifier, coproc, identifying one of coprocessors CP0-CP15.
- A coprocessor register, CRm. In this case, CRm specifies the primary coprocessor register.
- A single coprocessor-specific opcode, opc1.
- Two ARM core registers to hold two 32-bit values to transfer to or from the coprocessor.

CP15 and CP14 provide the control registers. A processor access to a specific 64-bit control register uses:

- p15 to specify CP15, or p14 to specify CP14
- a unique combination of CRm and opc1, to specify the required 64-bit system control register
- two ARM core registers, each holding 32 bits of the value to transfer.

Therefore, processor accesses a 64-bit control register using:

- an MCRR instruction to write to a control register, see [MCRR, MCRR2 on page A8-478](#)

- an MRRC instruction to read a control register, see *MRRC*, *MRRC2* on page A8-494.

When using a MCRR or MRRC instruction:

- Rt contains the least-significant 32 bits of the transferred value, and Rt2 contains the most-significant 32 bits of that value
- the access is 64-bit atomic.

The Large Physical Address Extension extends some registers from 32-bits to 64-bits. The MCR and MRC encodings for these registers access the least significant 32 bits of the register. For example, to access the *PAR*, software can:

- use the following instructions to access all 64 bits of the register:  
MRRC p15, 0, <Rt>, <Rt2>, c7 ; Read 64-bit PAR into Rt (low word) and Rt2 (high word)  
MCRR p15, 0, <Rt>, <Rt2>, c7 ; Write Rt (low word) and Rt2 (high word) to 64-bit PAR
- use the following instructions to access the least-significant 32 bits of the register:  
MRC p15, 0, <Rt>, c7, c4, 0 ; Read PAR[31:0] into Rt  
MCR p15, 0, <Rt>, c7, c4, 0 ; Write Rt to PAR[31:0]

### B3.15.2 General behavior of system control registers

Except where indicated, system control registers are 32-bits wide. As stated in *About system control register accesses* on page B3-1444, there are some 64-bit registers, and these include cases where software can access either a 32-bit view or a 64-bit view of a register. The register summaries, and the individual register descriptions, identify the 64-bit registers and how they can be accessed.

The following sections give information about the general behavior of these registers. Unless otherwise indicated, information applies to both CP14 and CP15 registers:

- *Read-only bits in read/write registers*
- *UNPREDICTABLE and UNDEFINED behavior for CP14 and CP15 accesses*
- *Reset behavior of CP14 and CP15 registers on page B3-1450.*

See also *About system control register accesses* on page B3-1444 and *Meaning of fixed bit values in register diagrams* on page B3-1466.

#### Read-only bits in read/write registers

Some read/write registers include bits that are read-only. These bits ignore writes.

An example of this is the *SCTLR.NMFI* bit, bit[27].

#### UNPREDICTABLE and UNDEFINED behavior for CP14 and CP15 accesses

In ARMv7 the following operations are UNDEFINED:

- all CDP, LDC and STC operations to CP14 and CP15, except for the LDC access to *DBGDTRTXint* and the STC access to *DBGDTRRXint* specified in *CP14 debug register interface accesses on page C6-2122*
- all MCRR and MRRC operations to CP14 and CP15, except for those explicitly defined as accessing 64-bit CP14 and CP15 registers
- all CDP2, MCR2, MRC2, MCRR2, MRRC2, LDC2 and STC2 operations to CP14 and CP15.

Unless otherwise indicated in the individual register descriptions:

- reserved fields in registers are UNK/SBZP
- assigning a reserved value to a field can have an UNPREDICTABLE effect.

The following subsections give more information about UNPREDICTABLE and UNDEFINED behavior for CP14 and CP15 accesses:

- *Accesses to unallocated CP14 and CP15 encodings on page B3-1447*
- *Additional rules for MCR and MRC accesses to CP14 and CP15 registers on page B3-1448*
- *Effects of the Security Extensions and Virtualization Extensions on CP15 register accesses on page B3-1448.*

### Accesses to unallocated CP14 and CP15 encodings

The general rules for the behavior of accesses to unallocated register encodings are similar for CP14 and CP15, but because the primary register specifier is different for CP14 and CP15, the details differ. Therefore, the rules are:

**For CP14** For any MCR or MRC access to CP14, the `opc1` value for the instruction is the primary specifier for the functional group of registers accessed, see [Organization of the CP14 registers in a VMSA implementation on page B3-1468](#). Accesses to unallocated functional groups of registers are UNDEFINED. This means any access with `<opc1> == {2, 3, 4, 5}` is UNDEFINED.

For MCR or MRC accesses to an allocated functional group of registers, the behavior of accesses to unallocated registers in the functional group depends on the group:

#### **opc1==0, Debug registers**

The behavior of accesses to unallocated registers depends on the Debug architecture version, see:

- [Access to unallocated CP14 debug register encodings, v7 Debug on page C6-2136](#)
- [Access to unallocated CP14 debug register encodings, v7.1 Debug on page C6-2145](#).

#### **opc1==1, Trace registers**

See the appropriate trace architecture specification for the behavior of CP14 accesses to unallocated Trace registers.

#### **opc1=={6, 7}, ThumbEE and Jazelle registers**

Accesses to unallocated register encodings are UNPREDICTABLE.

#### **Note**

The `opc1==7` functional group, the Jazelle registers, can include registers that are defined by the Jazelle subarchitecture.

For MCRR or MRRC accesses to CP14, all accesses are UNDEFINED unless this manual, or the appropriate trace architecture specification, explicitly defines them as accessing a 64-bit system register:

- [Chapter C11 The Debug Registers](#) identifies valid MCRR or MRRC accesses with `opc1==0`
- the appropriate trace architecture specification identifies any valid MCRR or MRRC accesses with `opc1==1`
- there are no valid MCRR or MRRC accesses with `opc1==6` or `opc1==7`.

**For CP15** For an MCR or MRC access to CP15, the `CRn` value for the instruction is the primary register specifier for the CP15 space, and the following rules define the behavior of accesses to unallocated encodings:

1. Accesses to unallocated primary registers are UNDEFINED. For the ARMv7-A Architecture, this means that:
  - For any implementation, accesses to CP15 primary register `c4` are UNDEFINED.
  - For an implementation that does not include the Security Extensions, accesses to CP15 primary register `c12` are UNDEFINED.
  - For an implementation that does not include the Generic Timer Extension, accesses to CP15 primary register `c14` are UNDEFINED.

See rule 3 for the behavior of accesses to CP15 primary register `c15`.

2. In an allocated CP15 primary register, accesses to all unallocated encodings are UNPREDICTABLE for accesses at PL1 or higher.

This means that any MCR or MRC access from PL1 or higher with a combination of `<CRn>`, `<opc1>`, `<CRm>` and `<opc2>` values not shown in, or referenced from, [Full list of VMSA CP15 registers, by coprocessor register number on page B3-1481](#), that would access an allocated CP15 primary register, is UNPREDICTABLE. As indicated by rule 1, for the ARMv7-A architecture, the allocated CP15 primary registers are:

  - in any VMSA implementation, `c0-c3`, `c5-c11`, `c13`, and `c15`

- in addition, in an implementation that includes the Security Extensions, c12
- in addition, in an implementation that includes the Generic Timer, c14.

———— **Note** ————

As shown in [Figure B3-27 on page B3-1471](#), accesses to unallocated principal ID registers map onto the MIDR. These are accesses with  $\langle CRn \rangle = c0$ ,  $\langle opc1 \rangle = 0$ ,  $\langle CRm \rangle = c0$ , and  $\langle opc2 \rangle = \{4, 6, 7\}$ .

3. CP15 primary register c15 is reserved for IMPLEMENTATION DEFINED registers. This means it is IMPLEMENTATION DEFINED whether this primary register is allocated or unallocated:
  - if an implementation does not define any registers in CP15 primary register c15, then that primary register is unallocated, and all MCR and MRC accesses to it are UNDEFINED
  - otherwise, CP15 primary register c15 is allocated, and MCR and MRC accesses to unallocated encodings with CRn set to c15 are UNPREDICTABLE for accesses at PL1 or higher.

For MCRR or MRRC accesses to CP15, all accesses are UNDEFINED unless this manual explicitly defines them as accessing a 64-bit system register. [Full list of VMSA CP15 registers, by coprocessor register number on page B3-1481](#) identifies the valid MCRR and MRRC accesses to CP15.

**Additional rules for MCR and MRC accesses to CP14 and CP15 registers**

All MCR operations from the PC are UNPREDICTABLE for all coprocessors, including for CP14 and CP15.

All MRC operations to APSR\_nzcv are UNPREDICTABLE for CP14 and CP15, except for the CP14 MRC to APSR\_nzcv shown in [CP14 debug register interface accesses on page C6-2122](#).

Except for CP14 and CP15 encodings that the appropriate register description identifies as accessible by software executing at PL0, all MCR and MRC accesses from User mode are UNDEFINED. This applies to all User mode accesses to unallocated CP14 and CP15 encodings.

Some individual registers can be made inaccessible by setting configuration bits, possibly including IMPLEMENTATION DEFINED configuration bits, to disable access to the register. The effects of the architecturally-defined configuration bits are defined individually in this manual. Unless explicitly stated otherwise in this manual, setting a configuration bit to disable access to a register results in the register becoming UNDEFINED for MRC and MCR accesses.

See also [Read-only and write-only register encodings on page B3-1449](#).

**Effects of the Security Extensions and Virtualization Extensions on CP15 register accesses**

The Security Extensions and Virtualization Extensions introduce classes of system control registers, described in [Classification of system control registers on page B3-1451](#). Some of these classes of register are either:

- accessible only from certain modes or states
- accessible from certain modes or states only when configuration settings permit the access.

Accesses to these registers that are not permitted are UNDEFINED, meaning execution of the register access instruction generates an Undefined Instruction exception.

———— **Note** ————

This section applies only to registers that are accessible from some modes and states. That is, it applies only to register access instructions using an encoding that, under some circumstances, would perform a valid register access.

The following register classes restrict access in this way:

**Restricted access system control registers**

This register class is defined in any implementation that includes the Security Extensions.

Restricted access registers other than the NSACR are accessible only from Secure PL1 modes. All other accesses to these registers are UNDEFINED.

The **NSACR** is a special case of a Restricted access register and:

- the **NSACR** is:
  - read/write accessible from Secure PL1 modes
  - is Read-only accessible from Non-secure PL2 and PL1 modes
- all other accesses to the **NSACR** are UNDEFINED.

For more information, see *Restricted access system control registers* on page B3-1453.

### Configurable access system control registers

This register class is defined in any implementation that includes the Security Extensions.

Most Configurable access registers are accessible from Non-secure state only if control bits in the **NSACR** permit Non-secure access to the register. Otherwise, a Non-secure access to the register is UNDEFINED.

For other Configurable access registers, control bits in the **NSACR** control the behavior of bits or fields in the register when it is accessed from Non-secure state. That is, Non-secure accesses to the register are permitted, but the **NSACR** controls how they behave. The only architecturally-defined register of this type is the **CPACR**.

For more information, see *Configurable access system control registers* on page B3-1453.

### PL2-mode system control registers

This register class is defined only in an implementation that includes the Virtualization Extensions.

PL2-mode registers are accessible only from:

- the Non-secure PL2 mode, Hyp mode
- Secure Monitor mode when **SCR.NS** is set to 1.

All other accesses to these registers are UNDEFINED.

For more information, see *Banked PL2-mode CP15 read/write registers* on page B3-1454 and *PL2-mode encodings for shared CP15 registers* on page B3-1456.

### PL2-mode write-only operations

This register class is defined only in an implementation that includes the Virtualization Extensions.

PL2-mode write-only operations are accessible only from:

- the Non-secure PL2 mode, Hyp mode
- Secure Monitor mode, regardless of the value of **SCR.NS**.

Write accesses to these operations are:

- UNPREDICTABLE in Secure PL1 modes other than Monitor mode
- UNDEFINED in Non-secure modes other than Hyp mode.

For more information, see *Banked PL2-mode CP15 write-only operations* on page B3-1456.

In addition, in any implementation that includes the Security Extensions, if write access to a register is disabled by the **CP15SDISABLE** signal then any MCR access to that register is UNDEFINED.

### Read-only and write-only register encodings

Some system control registers are *read-only* (RO) or *write-only* (WO). For example:

- most identification registers are read-only
- most encodings that perform an operation, such as a cache maintenance operation, are write-only.

If this manual defines a register to be RO at a particular privilege level then, at that privilege level:

- an MCR access to the register is UNPREDICTABLE
- an MCRR access to the register is UNDEFINED, regardless of whether the register can be read by an MRRC instruction.

If this manual defines a register to be WO at a particular privilege level then, at that privilege level:

- an MRC access to the register is UNPREDICTABLE
- an MRRC access to the register is UNDEFINED, regardless of whether the register can be written by an MCRR instruction.

---

**Note**

- This section applies only to registers that this manual defines as RO or WO. It does not apply to registers for which other access permissions are explicitly defined.
  - Although the **FPSID** is a RO register, a write using the **FPSID** encoding is a valid *serializing* operation, see *Asynchronous bounces, serialization, and Floating-point exception barriers* on page B1-1237. Such a write does not access the register.
- 

### Reset behavior of CP14 and CP15 registers

After a reset, only a limited subset of the processor state is guaranteed to be set to defined values. Also, for CP14 debug and trace registers, reset requirements must take account of different levels of reset. For more information about the reset behavior of CP14 and CP15 registers, see:

- *Reset and debug on page C7-2160*, for the Debug CP14 registers
- the appropriate Trace architecture specification, for the Trace CP14 registers
- *ThumbEE configuration on page A2-95*
- *Application level configuration and control of the Jazelle extension on page A2-99*
- *Reset behavior of CP15 registers*
- *Pseudocode details of resetting CP14 and CP15 registers on page B3-1451*.

### Reset behavior of CP15 registers

On reset, the VMSAv7 architecture defines a required reset value for all or part of each of the following CP15 registers:

- The **SCTLR**, **CPACR**, and **TTBCR**.
- The **FCSEIDR**, if the implementation includes the *Fast Context Switch Extension* (FCSE). This register is RAZ/WI when the FCSE is not implemented.
- In an implementation that includes the Security Extensions, the **SCR**, the Secure copy of the **VBAR**, and the **NSACR**.
- In an implementation that includes the Virtualization Extensions, the **VPIDR**, **VMPIDR**, **HCR**, **HDCR**, **HCPTR**, **HSTR**, and **VTTBR**.
- In an implementation that includes the Performance Monitors extension, the **PMCR**, the **PMUSERENR**, and in an implementation of PMUv2, the instance of **PMXEVTYPER** that relates to the cycle counter.
- In an implementation that includes the Generic Timer Extension, the **CNTKCTL** and **CNTHCTL** registers.

---

**Note**

In an implementation that includes the Security Extensions, unless this manual explicitly states otherwise, only the Secure copy of a Banked register is reset to the defined value, and software must program the Non-secure copy of the register with the required values. Typically, this programming is part of the processor boot sequence.

---

For details of the reset values of these registers see the register descriptions. If the description of a register or register field does not include its reset value then the architecture does not require that register or field to reset to a defined value.

The values of all other registers at reset are architecturally UNKNOWN. An implementation can assign an IMPLEMENTATION DEFINED reset value to a register whose reset value is architecturally UNKNOWN. After a reset, software must not rely on the value of any read/write register that does not have either an architecturally-defined reset value or an IMPLEMENTATION DEFINED reset value.

### **Pseudocode details of resetting CP14 and CP15 registers**

The `ResetControlRegisters()` pseudocode function resets all CP14 and CP15 registers, and register fields, that have defined reset values, as described in this section.

———— **Note** —————

For CP14 debug and trace registers this function resets registers as defined for the appropriate level of reset.

## **B3.15.3 Classification of system control registers**

The Security Extensions and Virtualization Extensions integrate with many features of the architecture. Therefore, the descriptions of the individual system control registers include information about how these extensions affect the register. This section:

- summarizes how the Security Extensions and Virtualization Extensions affect the implementation of the system control registers, and the classification of those registers.
- summarizes how the Security Extensions control access to the system control registers
- describes a Security Extensions signal that can control access to some CP15 registers.

It contains the following subsections:

- [Banked system control registers on page B3-1452](#)
- [Restricted access system control registers on page B3-1453](#)
- [Configurable access system control registers on page B3-1453](#)
- [PL2-mode system control registers on page B3-1454](#)
- [Common system control registers on page B3-1457](#)
- [The CP15SDISABLE input on page B3-1458](#)
- [Access to registers from Monitor mode on page B3-1459.](#)

———— **Note** —————

- This section describes the effect of the Security Extensions on all of system control registers, including those that are added by the Security Extensions, or by the Virtualization Extensions.
- The Security Extensions define the register classifications of Banked, Restricted access, Configurable, and Common. The Virtualization Extensions add the PL2-mode classification. Some of these classifications can apply to some coprocessor registers other than the CP14 and CP15 system control registers.

It is IMPLEMENTATION DEFINED whether each IMPLEMENTATION DEFINED register is Banked, Restricted access, Configurable, PL2-mode, or Common.



## Banked system control registers

In an implementation that includes the Security Extensions, some system control registers are Banked. Banked system control registers have two copies, one Secure and one Non-secure. The **SCR.NS** bit selects the Secure or Non-secure copy of the register. [Table B3-33](#) shows which CP15 registers are Banked in this way, and the permitted access to each register. No CP14 registers are Banked.

**Table B3-33 Banked CP15 registers**

CRn <sup>a</sup>	Banked register	Permitted accesses <sup>b</sup>
c0	<a href="#">CSSELR</a> , Cache Size Selection Register	Read/write only at PL1 or higher
c1	<a href="#">SCTLR</a> , System Control Register <sup>c</sup>	Read/write only at PL1 or higher
	<a href="#">ACTLR</a> , Auxiliary Control Register <sup>d</sup>	Read/write only at PL1 or higher
c2	<a href="#">TTBR0</a> , Translation Table Base 0	Read/write only at PL1 or higher
	<a href="#">TTBR1</a> , Translation Table Base 1	Read/write only at PL1 or higher
	<a href="#">TTBCR</a> , Translation Table Base Control	Read/write only at PL1 or higher
c3	<a href="#">DACR</a> , Domain Access Control Register	Read/write only at PL1 or higher
c5	<a href="#">DFSR</a> , Data Fault Status Register	Read/write only at PL1 or higher
	<a href="#">IFSR</a> , Instruction Fault Status Register	Read/write only at PL1 or higher
	<a href="#">ADFSR</a> , Auxiliary Data Fault Status Register <sup>d</sup>	Read/write only at PL1 or higher
	<a href="#">AIFSR</a> , Auxiliary Instruction Fault Status Register <sup>d</sup>	Read/write only at PL1 or higher
c6	<a href="#">DFAR</a> , Data Fault Address Register	Read/write only at PL1 or higher
	<a href="#">IFAR</a> , Instruction Fault Address Register	Read/write only at PL1 or higher
c7	<a href="#">PAR</a> , Physical Address Register	Read/write only at PL1 or higher
c10	<a href="#">PRRR</a> , Primary Region Remap Register	Read/write only at PL1 or higher
	<a href="#">NMRR</a> , Normal Memory Remap Register	Read/write only at PL1 or higher
c12	<a href="#">VBAR</a> , Vector Base Address Register	Read/write only at PL1 or higher
c13	<a href="#">FCSEIDR</a> , FCSE PID Register <sup>e</sup>	Read/write only at PL1 or higher
	<a href="#">CONTEXTIDR</a> , Context ID Register	Read/write only at PL1 or higher
	<a href="#">TPIDRURW</a> , User Read/Write Thread ID	Read/write at all privilege levels, including PL0
	<a href="#">TPIDRURO</a> , User Read-only Thread ID	Read-only at PL0 Read/write at PL1 or higher
	<a href="#">TPIDRPRW</a> , PL1 only Thread ID	Read/write only at PL1 or higher

- For accesses to 32-bit registers. More correctly, this is the primary coprocessor register.
- Any attempt to execute an access that is not permitted results in an Undefined Instruction exception.
- Some bits are common to the Secure and the Non-secure copies of the register, see [SCTLR, System Control Register, VMSA on page B4-1705](#).
- See [ADFSR and AIFSR, Auxiliary Data and Instruction Fault Status Registers, VMSA on page B4-1523](#). Register is IMPLEMENTATION DEFINED.
- Banked only in an implementation that includes the FCSE. The FCSE PID Register is RAZ/WI if the FCSE is not implemented.



A Banked CP15 register can contain a mixture of:

- fields that are Banked
- fields that are read-only in Non-secure PL1 or PL2 modes but read/write in the Secure state.

The System Control Register **SCTLR** is an example of a register of that contains this mixture of fields.

The Secure copies of the Banked CP15 registers are sometimes referred to as the Secure Banked CP15 registers. The Non-secure copies of the Banked CP15 registers are sometimes referred to as the Non-secure Banked CP15 registers.

### Restricted access system control registers

In an implementation that includes the Security Extensions, some system control registers are present only in the Secure security state. These are called *Restricted access* registers, and their read/write access permissions are:

- In Non-secure state, software cannot modify Restricted access registers.
- For the **NSACR**, in Non-secure state:
  - software running at PL1 or higher can read the register
  - unprivileged software, meaning software running at PL0, cannot read the register.
 This means that Non-secure software running at PL1 or higher can read the access permissions for system control registers that have Configurable access.
- For all other Restricted access registers, Non-secure software cannot read the register.

Table B3-34 shows the Restricted access CP15 registers in an implementation that includes the Security Extensions. There are no Restricted access CP14 registers.

**Table B3-34 Restricted access CP15 registers**

CRn <sup>a</sup>	Register	Permitted accesses <sup>b</sup>
c1	<b>SCR</b> , Secure Configuration	Read/write in Secure PL1 modes
	<b>SDER</b> , Secure Debug Enable	Read/write in Secure PL1 modes
	<b>NSACR</b> , Non-Secure Access Control	Read/write in Secure PL1 modes Read-only in Non-secure PL1 and PL2 modes
c12	<b>MVBAR</b> , Monitor Vector Base Address	Read/write in Secure PL1 modes

a. For accesses to 32-bit registers. More correctly, this is the primary coprocessor register.

b. Any attempt to execute an access that is not permitted results in an Undefined Instruction exception.

### Configurable access system control registers

Secure software can configure the access to some system control registers. These registers are called Configurable access registers, and the control can be:

- A bit in the control register determines whether the register is:
  - accessible from Secure state only
  - accessible from both Secure and Non-secure states.
- A bit in the control register changes the accessibility of a register bit or field. For example, setting a bit in the control register might mean that a R/W field behaves as RAZ/WI when accessed from Non-secure state.

Bits in the **NSACR** control access.

In an ARMv7 implementation of the Security Extensions:

- there are no Configurable access CP14 registers
- the only required Configurable access CP15 register is the **CPACR**, Coprocessor Access Control Register

- the following registers in the CP10 and CP11 register space are Configurable access:
  - Floating-point Status and Control Register, [FPSCR](#)
  - Floating-point Exception register, [FPEXC](#)
  - Floating-point System ID register, [FPSID](#)
  - Media and VFP Feature Register 0, [MVFR0](#)
  - Media and VFP Feature Register 1, [MVFR1](#)
  - Floating-Point Instruction Registers, [FPINST](#) and [FPINST2](#), if implemented.

### PL2-mode system control registers

An implementation that includes both the Security Extensions and the Virtualization Extensions includes a number of registers for use in the PL2 mode, Hyp mode. As with other system control register encodings, some of these register encodings provide write-only operations. Secure software can access the register by moving to Monitor mode and setting [SCR.NS](#) to 1, before accessing the register.

The following subsections describe the PL2-mode registers:

- [Banked PL2-mode CP15 read/write registers](#)
- [PL2-mode encodings for shared CP15 registers on page B3-1456](#)
- [Banked PL2-mode CP15 write-only operations on page B3-1456.](#)

There are no PL2-mode CP14 registers.

#### **Banked PL2-mode CP15 read/write registers**

Architecturally, these are an extension of the Banked registers described in [Banked system control registers on page B3-1452](#), where:

- the processor does not implement the Secure copy of the register
- the Non-secure copy of the register is accessible only at PL2, that is, only from Hyp mode.

Except for accesses to [CNTVOFF](#) in an implementation that includes the Security Extensions but not the Virtualization Extensions, the behavior of accesses to these registers is as follows:

- in Secure state, the registers can be accessed from Monitor mode when [SCR.NS](#) is set to 1, see [Access to registers from Monitor mode on page B3-1459](#)
- the following accesses are UNDEFINED:
  - accesses from Non-secure PL1 modes
  - accesses in Secure state when [SCR.NS](#) is set to 0.

In an implementation that includes the Security Extensions but not the Virtualization Extensions, the behavior of accesses to [CNTVOFF](#) is as follows:

- any access from Secure Monitor mode is UNPREDICTABLE, regardless of the value of [SCR.NS](#)
- all other accesses are UNDEFINED.

#### ———— **Note** —————

Except for [CNTVOFF](#), the Banked PL2-mode registers are part of the Virtualization Extensions, meaning they are implemented only if the implementation includes the Virtualization Extensions. However, conceptually, [CNTVOFF](#) is part of any implementation that includes the Generic Timer Extension, see [Status of the CNTVOFF register on page B8-1968](#). This means the behavior of [CNTVOFF](#) in an implementation that includes the Generic Timer Extension but does not include the Virtualization Extensions is not covered by the general definition of the behavior of the Banked PL2-mode CP15 read/write registers.

Table B3-35 shows the PL2-mode CP15 read/write registers:

**Table B3-35 Banked PL2-mode CP15 read/write registers**

CRn or CRm <sup>a</sup>	Register	Width	Permitted accesses <sup>b</sup>
c0	VPIDR	32-bit	Read/write. In Non-secure state, accessible only from Hyp mode
	VMPIDR	32-bit	Read/write. In Non-secure state, accessible only from Hyp mode
c1	HSCTLR	32-bit	Read/write. In Non-secure state, accessible only from Hyp mode
	HACTLR	32-bit	Read/write. In Non-secure state, accessible only from Hyp mode
	HCR	32-bit	Read/write. In Non-secure state, accessible only from Hyp mode
	HDCR	32-bit	Read/write. In Non-secure state, accessible only from Hyp mode
	HCPTR	32-bit	Read/write. In Non-secure state, accessible only from Hyp mode
	HSTR	32-bit	Read/write. In Non-secure state, accessible only from Hyp mode
	HACR	32-bit	Read/write. In Non-secure state, accessible only from Hyp mode
c2	HTCR	32-bit	Read/write. In Non-secure state, accessible only from Hyp mode
	VTCTCR	32-bit	Read/write. In Non-secure state, accessible only from Hyp mode
	HTTBR	64-bit	Read/write. In Non-secure state, accessible only from Hyp mode
	VTTBR	64-bit	Read/write. In Non-secure state, accessible only from Hyp mode
c5	HADFSR <sup>c</sup>	32-bit	Read/write. In Non-secure state, accessible only from Hyp mode
	HAIFSR <sup>c</sup>	32-bit	Read/write. In Non-secure state, accessible only from Hyp mode
	HSR	32-bit	Read/write. In Non-secure state, accessible only from Hyp mode
c6	HPFAR	32-bit	Read/write. In Non-secure state, accessible only from Hyp mode
c10	HMAIR0	32-bit	Read/write. In Non-secure state, accessible only from Hyp mode
	HMAIR1	32-bit	Read/write. In Non-secure state, accessible only from Hyp mode
	HAMAIR0	32-bit	Read/write. In Non-secure state, accessible only from Hyp mode
	HAMAIR1	32-bit	Read/write. In Non-secure state, accessible only from Hyp mode
c12	HVBAR	32-bit	Read/write. In Non-secure state, accessible only from Hyp mode
c13	HTPIDR	32-bit	Read/write. In Non-secure state, accessible only from Hyp mode
c14	CNTVOFF <sup>d</sup>	64-bit	Read/write. In Non-secure state, accessible only from Hyp mode

- a. CRn for accesses to 32-bit registers, CRm for accesses to 64-bit registers. More correctly, this is the primary coprocessor register.
- b. Any attempt to execute an access that is not permitted results in an Undefined Instruction exception.
- c. See *HADFSR and HAIFSR, Hyp Auxiliary Fault Syndrome Registers, Virtualization Extensions* on page B4-1575
- d. Implemented only in an implementation that includes the Generic Timer Extension. See, also, the Note earlier in this section.

### PL2-mode encodings for shared CP15 registers

Some Hyp mode registers share the Secure copy of an existing Banked register. In this case the implementation includes an encoding for the register that is accessible only in Hyp mode, or in Monitor mode when [SCR.NS](#) is set to 1.

For these registers, the following accesses are UNDEFINED:

- Accesses from Non-secure PL1 modes.
- Accesses in Secure state when [SCR.NS](#) is set to 0.

[Table B3-36](#) lists the PL2-mode encodings for shared registers.

**Table B3-36 PL2-mode CP15 register encodings for shared registers**

CRn <sup>a</sup>	Register	Permitted accesses <sup>b</sup>	Shared register
c6	<a href="#">HDFAR</a>	Read/write. In Non-secure state, accessible only from Hyp mode <sup>c</sup>	Secure <a href="#">DFAR</a>
c6	<a href="#">HIFAR</a>	Read/write. In Non-secure state, accessible only from Hyp mode <sup>c</sup>	Secure <a href="#">IFAR</a>

- For accesses to 32-bit registers. More correctly, this is the primary coprocessor register.
- Any attempt to execute an access that is not permitted results in an Undefined Instruction exception.
- Also accessible from Monitor mode when [SCR.NS](#) set to 1.

In Monitor mode, the Secure copies of these registers can be accessed either:

- using the [DFAR](#) or [IFAR](#) encoding with [SCR.NS](#) set to 0
- using the [HDFAR](#) or [HIFAR](#) encoding with [SCR.NS](#) set to 1.

However, between accessing a register using one alias and accessing the register using the other alias, a [Context synchronization operation](#) is required to ensure the ordering of the accesses.

### Banked PL2-mode CP15 write-only operations

Architecturally, these encodings are an extension of the Banked register encodings described in [Banked system control registers on page B3-1452](#), where:

- the processor does not implement the operation in Secure state
- in Non-secure state, the operation is accessible only at PL2, that is, only from Hyp mode.

In Secure state:

- these operations can be accessed from Monitor mode regardless of the value of [SCR.NS](#), see [Access to registers from Monitor mode on page B3-1459](#)
- accesses to these operations are UNPREDICTABLE if executed in a Secure mode other than Monitor mode.

Accesses to these operations are UNDEFINED if accessed from a Non-secure PL1 mode.

[Table B3-37 on page B3-1457](#) shows the PL2-mode CP15 write-only operations:

**Table B3-37 Banked PL2-mode CP15 write-only operations**

CRn	Register	Width	Permitted accesses <sup>a</sup>
c8	<a href="#">ATS1HR</a>	32-bit	Write-only. In Non-secure state, accessible only from Hyp mode
	<a href="#">ATS1HW</a>	32-bit	Write-only. In Non-secure state, accessible only from Hyp mode
	<a href="#">TLBIALLHIS</a>	32-bit	Write-only. In Non-secure state, accessible only from Hyp mode
	<a href="#">TLBIMVAHIS</a>	32-bit	Write-only. In Non-secure state, accessible only from Hyp mode
	<a href="#">TLBIALLNSNHIS</a>	32-bit	Write-only. In Non-secure state, accessible only from Hyp mode
	<a href="#">TLBIALLH</a>	32-bit	Write-only. In Non-secure state, accessible only from Hyp mode
	<a href="#">TLBIMVAH</a>	32-bit	Write-only. In Non-secure state, accessible only from Hyp mode
	<a href="#">TLBIALLNSNH</a>	32-bit	Write-only. In Non-secure state, accessible only from Hyp mode

a. This section describes the behavior of write accesses that are not permitted. See also [Read-only and write-only register encodings](#) on page B3-1449.

For more information about these operations, see:

- [Address translation stage 1, Hyp mode](#) on page B3-1440
- [Hyp mode TLB maintenance operations, Virtualization Extensions](#) on page B4-1746

### Common system control registers

Some system control registers and operations are common to the Secure and Non-secure security states. These are described as the *Common access* registers, or simply as the *Common* registers. These registers include:

- read-only registers that hold configuration information
- register encodings used for various memory system operations, rather than to access registers
- the [ISR](#)
- all CP14 registers.

[Table B3-38](#) shows the Common CP15 system control registers in an ARMv7-A implementation that includes the Security Extensions. These registers are not affected by the implementation of the Security Extensions.

**Table B3-38 Common CP15 registers**

CRn <sup>a</sup>	Register	Permitted accesses <sup>b</sup>
c0	<a href="#">MIDR</a> , Main ID Register	Read-only, only at PL1 or higher
	<a href="#">CTR</a> , Cache Type Register	Read-only, only at PL1 or higher
	<a href="#">TCMTR</a> , TCM Type Register <sup>c</sup>	Read-only, only at PL1 or higher
	<a href="#">TLBTR</a> , TLB Type Register <sup>c</sup>	Read-only, only at PL1 or higher
	<a href="#">MPIDR</a> , Multiprocessor Affinity Register	Read-only, only at PL1 or higher
	<a href="#">REVIDR</a> , Revision ID	Read-only, only at PL1 or higher

**Table B3-38 Common CP15 registers (continued)**

CRn <sup>a</sup>	Register	Permitted accesses <sup>b</sup>
c0	ID_PFRx, Processor Feature Registers	Read-only, only at PL1 or higher
	ID_DFR0, Debug Feature Register 0	Read-only, only at PL1 or higher
	ID_AFR0, Auxiliary Feature Register 0	Read-only, only at PL1 or higher
	ID_MMFRx, Memory Model Feature Registers	Read-only, only at PL1 or higher
	ID_ISARx, Instruction Set Attribute Registers	Read-only, only at PL1 or higher
	CCSIDR, Cache Size ID Register	Read-only, only at PL1 or higher
	CLIDR, Cache Level ID Register	Read-only, only at PL1 or higher
	AIDR, Auxiliary ID Register <sup>c</sup>	Read-only, only at PL1 or higher
c7	Cache maintenance operations	See <i>Cache maintenance operations, functional group, VMSA</i> on page B3-1496
	Address translation operations	See <i>Address translation operations, functional group</i> on page B3-1498
	Data barrier operations	Write-only at all privilege levels, including PL0
c8	TLB maintenance operations	Write-only, only at PL1 or higher
c9	Performance monitors	See <i>Access permissions</i> on page C12-2328
c12	ISR, Interrupt Status Register	Read-only, only at PL1 or higher

- a. For accesses to 32-bit registers. More correctly, this is the primary coprocessor register.
- b. Any attempt to execute an access that is not permitted results in an Undefined Instruction exception.
- c. Register or operation details are IMPLEMENTATION DEFINED.

### Secure CP15 registers

The Secure CP15 registers comprise:

- The Secure copies of the Banked CP15 registers
- The Restricted access CP15 registers
- The Configurable access CP15 registers that are configured to be accessible only from Secure state.

In an implementation that includes the Security Extensions, the Non-secure CP15 registers are the CP15 registers other than the Secure CP15 registers.

### The CP15SDISABLE input

The Security Extensions include an input signal, **CP15SDISABLE**, that disables write access to some of the Secure registers when asserted HIGH.

#### ————— Note —————

The interaction between **CP15SDISABLE** and any IMPLEMENTATION DEFINED register is IMPLEMENTATION DEFINED.

Table B3-39 on page B3-1459 shows the registers and operations affected.

**Table B3-39 Secure registers affected by CP15SDISABLE**

CRn	Register name	Affected operation
c1	<a href="#">SCTLR</a> , System Control Register	MCR p15, 0, <Rt>, c1, c0, 0
c2	<a href="#">TTBR0</a> , Translation Table Base Register 0	MCR p15, 0, <Rt>, c2, c0, 0
	<a href="#">TTBCR</a> , Translation Table Base Control Register	MCR p15, 0, <Rt>, c2, c0, 2
c3	<a href="#">DACR</a> , Domain Access Control Register	MCR p15, 0, <Rt>, c3, c0, 0
c10	<a href="#">PRRR</a> , Primary Region Remap Register	MCR p15, 0, <Rt>, c10, c2, 0
	<a href="#">NMRR</a> , Normal Memory Remap Register	MCR p15, 0, <Rt>, c10, c2, 1
c12	<a href="#">VBAR</a> , Vector Base Address Register	MCR p15, 0, <Rt>, c12, c0, 0
	<a href="#">MVBAR</a> , Monitor Vector Base Address Register	MCR p15, 0, <Rt>, c12, c0, 1
c13	<a href="#">FCSEIDR</a> , FCSE PID Register <sup>a</sup>	MCR p15, 0, <Rt>, c13, c0, 0

a. In an implementation that includes the FCSE. The FCSE PID Register is RAZ/WI if the FCSE is not implemented.

On a reset by the external system, the **CP15SDISABLE** input signal must be taken LOW. This permits the Reset code to set up the configuration of the Security Extensions. When the input is asserted HIGH, any attempt to write to the Secure registers shown in [Table B3-39](#) results in an Undefined Instruction exception.

The **CP15SDISABLE** input does not affect reading Secure registers, or reading or writing Non-secure registers. It is IMPLEMENTATION DEFINED how the input is changed and when changes to this input are reflected in the processor, and an implementation might not provide any mechanism for driving the **CP15SDISABLE** input HIGH. However, in an implementation in which the **CP15SDISABLE** input can be driven HIGH, changes in the state of **CP15SDISABLE** must be reflected as quickly as possible. Any change must occur before completion of a Instruction Synchronization Barrier operation, issued after the change, is visible to the processor with respect to instruction execution boundaries. Software must perform a Instruction Synchronization Barrier operation meeting the above conditions to ensure all subsequent instructions are affected by the change to **CP15SDISABLE**.

Use of **CP15SDISABLE** means key Secure features that are accessible only at PL1 can be locked in a known good state. This provides an additional level of overall system security. ARM expects control of **CP15SDISABLE** to reside in the system, in a block dedicated to security.

### Access to registers from Monitor mode

When the processor is in Monitor mode, the processor is in Secure state regardless of the value of the [SCR.NS](#) bit. In Monitor mode, the [SCR.NS](#) bit determines whether valid uses of the MRC, MCR, MRRC and MCRR instructions access the Secure Banked CP15 registers or the Non-secure Banked CP15 registers. That is, when:

**NS == 0** Common, Restricted access, and Secure Banked registers are accessed by CP15 MRC, MCR, MRRC and MCRR instructions.

If the implementation includes the Virtualization Extensions, the registers listed in [Banked PL2-mode CP15 read/write registers on page B3-1454](#) and [PL2-mode encodings for shared CP15 registers on page B3-1456](#) are not accessible, and any attempt to access them generates an Undefined Instruction exception.

#### ————— Note —————

The operations listed in [Banked PL2-mode CP15 write-only operations on page B3-1456](#) are accessible in Monitor mode regardless of the value of [SCR.NS](#).

CP15 operations use the security state to determine all resources used, that is, all CP15-based operations are performed in Secure state.

**NS == 1** Common, Restricted access and Non-secure Banked registers are accessed by CP15 MRC, MCR, MRRC and MCRR instructions.

If the implementation includes the Virtualization Extensions, all the registers and operations listed in the subsections of *PL2-mode system control registers on page B3-1454* are accessible, using the MRC, MCR, MRRC, or MCRR instructions required to access them from Hyp mode.

CP15 operations use the security state to determine all resources used, that is, all CP15-based operations are performed in Secure state.

The security state determines whether the Secure or Non-secure Banked registers determine the control state.

———— **Note** —————

Where the contents of a register select the value accessed by an MRC or MCR access to a different register, then the register that is used for selection is being used as control state. For example, **CSSELR** selects the current **CCSIDR**, and therefore **CSSELR** is used as control state. Therefore, in Monitor mode:

- **SCR.NS** determines whether the Secure or Non-secure **CSSELR** is accessible
- because the processor is in Secure state, the Secure **CSSELR** selects the current **CCSIDR**.

### B3.15.4 Effect of the LPAE and Virtualization Extensions on the system control registers

The *Large Physical Address Extension* (LPAE) adds:

- two reserved CP15 encodings, for applying IMPLEMENTATION DEFINED memory attributes, **AMAIR0** and **AMAIR1**.
- 64-bit encodings of the **TTBR0**, **TTBR1**, and **PAR**
- 64-bit encodings of the **DBGDRAR** and **DBGDSAR**.

The Virtualization Extensions add:

- the CP15 registers and operations summarized in *Virtualization Extensions registers, functional group on page B3-1501*.
- the **PMOVSSET** register
- the **DBGBXVRs**.



## B3.15.5 Synchronization of changes to system control registers

In this section, *this processor* means the processor on which accesses are being synchronized.

———— **Note** —————

See [Definitions of direct and indirect reads and writes and their side-effects on page B3-1464](#) for definitions of the terms *direct write*, *direct read*, *indirect write*, and *indirect read*.

A *direct write* to a system control register might become visible at any point after the change to the register, but without a [Context synchronization operation](#) there is no guarantee that the change becomes visible.

Any direct write to a system control register is guaranteed not to affect any instruction that appears, in program order, before the instruction that performed the direct write, and any direct write to a system control register must be synchronized before any instruction that appears after the direct write, in program order, can rely on the effect of that write. The only exceptions to this are:

- All direct writes to the same register, using the same encoding, are guaranteed to occur in program order.
- All direct writes to a register are guaranteed to occur in program order relative to all direct reads of the same register using the same encoding.
- If an instruction that appears in program order before the direct write performs a memory access, such as a memory-mapped register access, that causes an indirect read or write to a register, that memory access is subject to the ARM ordering model. In this case, if permitted by the ARM ordering model, the instruction that appears in program order before the direct write can be affected by the direct write.

These rules mean that an instruction that writes to one of the address translation operations described in [Virtual Address to Physical Address translation operations on page B3-1438](#) must be explicitly synchronized to guarantee that the result of the address translation operation is visible in the [PAR](#).

———— **Note** —————

In this case, the direct write to the encoding of the address translation operation causes an *indirect write* to the [PAR](#). Without a [Context synchronization operation](#) after the direct write there is no guarantee that the indirect write to the [PAR](#) is visible.

Conceptually, the explicit synchronization occurs as the first step of any [Context synchronization operation](#). This means that if the operation uses state that had been changed but not synchronized before the operation occurred, the operation is guaranteed to use the state as if it had been synchronized.

———— **Note** —————

This explicit synchronization is applied as the first step of the execution of any instruction that causes the operation. This means it does not synchronize any effect of system registers that might affect the fetch and decode of the instructions that cause the operation, such as breakpoints or changes to translation tables.

Except for the register reads listed in [Registers with some architectural guarantee of ordering or observability on page B3-1463](#), if no context synchronization operation is performed, direct reads of system control registers can occur in any order.

[Table B3-40 on page B3-1462](#) shows the synchronization requirement between two reads or writes that access the same system control register. In the column headings, *First* and *Second* refer to:

- Program order, for any read or write caused by the execution of an instruction by this processor, other than a read or write caused by a memory access made by that instruction.
- The order of arrival of asynchronous reads or writes made by this processor relative to the execution of instructions by this processor.

In addition:

- For indirect reads or writes caused by an external agent, such as a debugger, the mechanism that determines the order of the reads or writes is defined by that external agent. The external agent can provide mechanisms that ensure that any reads or writes it makes arrive at the processor. These indirect reads and writes are asynchronous to software execution on the processor.
- For indirect reads or writes caused by memory-mapped reads or writes made by this processor, the ordering of the memory accesses is subject to the memory order model, including the effect of the memory type of the accessed memory address. This applies, for example, if this processor reads or writes one of its registers in a memory-mapped register interface.

The mechanism for ensuring completion of these memory accesses, including ensuring the arrival of the asynchronous read or write at the processor, is defined by the system.

———— **Note** —————

Such accesses are likely to be given the Device or Strongly-ordered attribute, but requiring this is outside the scope of the processor architecture.

- For indirect reads or writes caused by autonomous asynchronous events that count, for example events caused by the passage of time, the events are ordered so that:
  - Counts progress monotonically.
  - The events arrive at the processor in finite time and without undue delay.

**Table B3-40 Synchronization requirements for updates to system control registers**

First read or write	Second read or write	Context synchronization operation required
Direct read	Direct read	No
	Direct write	No
	Indirect read	No <sup>a</sup>
	Indirect write	No <sup>a</sup> , but see text in this section for exceptions
Direct write	Direct read	No
	Direct write	No
	Indirect read	Yes <sup>a</sup>
	Indirect write	No, but see text in this section for exceptions
Indirect read	Direct read	No
	Direct write	No
	Indirect read	No
	Indirect write	No
Indirect write	Direct read	Yes, but see text in this section for exceptions
	Direct write	No, but see text in this section for exceptions
	Indirect read	Yes, but see text in this section for exceptions
	Indirect write	No, but see text in this section for exceptions

a. Although no synchronization is required between a Direct write and a Direct read, or between a Direct read and an Indirect write, this does not imply that a Direct read causes synchronization of a previous Direct write. This means that the sequence Direct write followed by Direct read followed by Indirect read, with no intervening context synchronization, does not guarantee that the Indirect read observes the result of the Direct write.

If the indirect write is to a register that *Registers with some architectural guarantee of ordering or observability* shows as having some guarantee of the visibility of an indirect writes, synchronization might not be required.

If a direct read or a direct write to a register is followed by an indirect write to that register that is caused by an external agent, or by an autonomous asynchronous event, or as a result of a memory-mapped write, then synchronization is required to guarantee the ordering of the indirect write relative to the direct read or direct write.

If an indirect write caused by a direct write is followed by an indirect write caused by caused by an external agent, or by an autonomous asynchronous event, or as a result of a memory-mapped write, then synchronization is required to guarantee the ordering of the two indirect writes.

If a direct read causes an indirect write, synchronization is required to guarantee that the indirect write is visible to subsequent direct or indirect reads or writes. This synchronization must be performed after the direct read, before the subsequent direct or indirect reads or writes.

If a direct write causes an indirect write, synchronization is required to guarantee that the indirect write is visible to subsequent direct or indirect reads or writes. This synchronization must be performed after the direct write, before the subsequent direct or indirect reads or writes.

———— **Note** —————

Where a register has more than one encoding, a direct write to the register using a particular encoding is not an indirect write to the same register with a different encoding.

Where an indirect write is caused by the action of an external agent, such as a debugger, or by a memory-mapped read or write by the processor, then an indirect write by that agent to a register using a particular access mechanism, followed by an indirect read by that agent to the same register using the same access mechanism and address does not need synchronization.

For information about the additional synchronization requirements for memory-mapped registers, see [Synchronization requirements for memory-mapped register interfaces on page C6-2115](#).

To guarantee the visibility of changes to some registers, additional operations might be required before the context synchronization operation. For such a register, the definition of the register identifies these additional requirements.

In this manual, unless the context indicates otherwise:

- *Accessing* a system control register refers to a direct read or write of the register.
- *Using* a system control register refers to an indirect read or write of the register.

### Registers with some architectural guarantee of ordering or observability

For the registers for which [Table B3-41](#) shows that the ordering of direct reads is guaranteed, multiple direct reads of a single register, using the same encoding, occur in program order without any explicit ordering.

For the registers for which [Table B3-41](#) shows that some observability of indirect writes is guaranteed, an indirect write to the register caused by an external agent, an autonomous asynchronous events, or as a result of a memory mapped write, is both:

- Observable to direct reads of the register, in finite time, without explicit synchronization.
- Observable to subsequent indirect reads of the register without explicit synchronization.

These two sets of registers are similar, as [Table B3-41](#) shows:

**Table B3-41 Registers with a guarantee of ordering or observability, in a VMSA implementation**

Register	Ordering of direct reads	Observability of indirect writes	Notes
<a href="#">ISR</a>	Guaranteed	Guaranteed	Interrupt Status Register
<a href="#">DBGCLAIMCLR</a>	-	Guaranteed	Debug claim registers
<a href="#">DBGCLAIMSET</a>	Guaranteed	Guaranteed	

**Table B3-41 Registers with a guarantee of ordering or observability, in a VMSA implementation (continued)**

Register	Ordering of direct reads	Observability of indirect writes	Notes
DBGDTRRX	Guaranteed	Guaranteed	Debug Communication Channel registers
DBGDTRTX	Guaranteed	Guaranteed	
CNTPCT	Guaranteed	Guaranteed	Generic Timer Extension registers, if the implementation includes the extension
CNTP_TVAL	Guaranteed	Guaranteed	
CNTVCT	Guaranteed	Guaranteed	
CNTV_TVAL	Guaranteed	Guaranteed	
CNTHP_TVAL	Guaranteed	Guaranteed	
PMCCNTR	Guaranteed	Guaranteed	Performance Monitors Extension registers, if the implementation includes the extension
PMXEVCNTR	Guaranteed	Guaranteed	
PMOVSSET	Guaranteed	Guaranteed	

For the specified registers, the observability requirement is more demanding than the observability requirements for other registers. However, the possibility that direct reads can occur *early*, in the absence of context synchronization, described in [Ordering of reads of system control registers on page B3-1445](#), still applies to these registers.

In Debug state, additional synchronization requirements can apply to the registers shown in [Table B3-41 on page B3-1463](#). For more information, see:

- [Synchronization of accesses to the Debug Communications Channel on page C6-2115](#).
- [Synchronization of accesses to the DCC and the DBGITR on page C8-2176](#).

### Definitions of direct and indirect reads and writes and their side-effects

Direct and indirect reads and writes are defined as follows:

**Direct read** Is a read of a register, using an MRC, MRC2, MRRC, MRRC2, LDC, or LDC2 instruction, that the architecture permits for the current processor state.

If a direct read of a register has a side-effect of changing the value of a register, the effect of a direct read on that register is defined to be an *indirect write*, and has the synchronization requirements of an indirect write. This means the indirect write is guaranteed to have occurred, and to be visible to subsequent direct or indirect reads and writes only if synchronization is performed after the direct read.

———— **Note** —————

The indirect write described here can affect either the register written to by the direct write, or some other register. The synchronization requirement is the same in both cases.

**Direct write** Is a write to a register, using an MCR, MCR2, MCRR, MCRR2, STC, or STC2 instruction, that the architecture permits for the current processor state.

In the following cases, the side-effect of the direct write is defined to be an indirect write of the affected register, and has the synchronization requirements of an indirect write:

- If the direct write has a side-effect of changing the value of a register other than the register accessed by the direct write.
- If the direct write has a side-effect of changing the value of the register accessed by the direct write, so that the value in that register might not be the value that the direct write wrote to the register.

In both cases, this means that the indirect write is not guaranteed to be visible to subsequent direct or indirect reads and writes unless synchronization is performed after the direct write.

---

**Note**

---

- As an example of a direct write to a register having an effect that is an indirect write of that register, writing 1 to a [PMCNTENCLR.Px](#) bit is also an indirect write, because if the Px bit had the value 1 before the direct write, the side-effect of the write changes the value of that bit to 0.
- The indirect write described here can affect either the register written to by the direct write, or some other register. The synchronization requirement is the same in both cases. For example, writing 1 to a [PMCNTENCLR.Px](#) bit that is set to 1 also changes the corresponding [PMCNTENSET.Px](#) bit from 1 to 0. This means that the direct write to the [PMCNTENCLR](#) defines indirect writes to both itself and to the [PMCNTENSET](#).

---

**Indirect read** Is a use of the register by an instruction to establish the operating conditions for the instruction. Examples of operating conditions that might be determined by an indirect read are the translation table base address, or whether a cache is enabled.

Indirect reads include situations where the value of one register determines what value is returned by a second register. This means that any read of the second register is an indirect read of the register that determines what value is returned.

Indirect reads also include:

- Reads of the system control registers by external agents, such as debuggers, as described in [Chapter C6 Debug Register Interfaces](#).
- Memory-mapped reads of the system control registers made by the processor that implements the system control registers.

Where an indirect read of a register has a side-effect of changing the value of a register, that change is defined to be an indirect write, and has the synchronization requirements of an indirect write.

**Indirect write** Is an update to the value of a register as a consequence of either:

- An exception, operation, or execution of an instruction that is not a direct write to that register.
- The asynchronous operation of some external agent.

This can include:

- The passage of time, as seen in counters or timers, including performance counters.
- The assertion of an interrupt.
- A write from an external agent, such as a debugger.

However, for some registers, the architecture gives some guarantee of visibility without any explicit synchronization, see [Registers with some architectural guarantee of ordering or observability on page B3-1463](#).

---

**Note**

---

Taking an exception is a context-synchronizing operation. Therefore, any indirect write performed as part of an exception entry does not require additional synchronization. This includes the indirect writes to the registers that report the exception, as described in [Exception reporting in a VMSA implementation on page B3-1409](#).

---

### B3.15.6 Meaning of fixed bit values in register diagrams

In register diagrams, fixed bits are indicated by one of following:

- 0** In any implementation:
- the bit must read as 0
  - writes to the bit must be ignored
  - software:
    - can rely on the bit reading as 0
    - must use an SBZP policy to write to the bit.
- (0)** The Large Physical Address Extension creates a small number of cases where a bit is (0) in some contexts, and has a different defined behavior in other contexts. The meaning of (0) is modified for these bits. For a read/write register, this means:

**If a register bit is (0) for all uses of the register**

- the bit must read as 0
- writes to the bit must be ignored
- software:
  - must not rely on the bit reading as 0
  - must use an SBZP policy to write to the bit.

———— **Note** —————

This definition applies to all bits marked as (0) in an implementation that does not include the Large Physical Address Extension.

**If a register bit is (0) only for some uses of the register, when that bit is described as (0)**

- A read of the bit must return the value last successfully written to the bit, regardless of the use of the register when the bit was written.  
If the bit has not been successfully written since reset, then the read of the bit returns the reset value if there is one, or otherwise returns an UNKNOWN value.
- A write to the bit must update a storage location associated with the bit.
- While the use of the register is such that the bit is described as (0), or as UNK/SBZP, the value of the bit must have no effect on the operation of the processor, other than determining the value read back from that bit.
- Software:
  - must not rely on the bit reading as 0
  - must use an SBZP policy to write to the bit.

———— **Note** —————

This definition applies only to bits that are defined as (0), or as UNK/SBZP, for one use of a register, and are defined differently for another use of the register.

Fields that are more than one bit wide are sometimes described as UNK/SBZP, instead of having each bit marked as (0).

In a read-only register, (0) indicates that the bit reads as 0, but software must treat the bit as UNK.

In a write-only register, (0) indicates that software must treat the bit as SBZ.

- 1** In any implementation:

- the bit must read as 1
- writes to the bit must be ignored.
- software:
  - can rely on the bit reading as 1
  - must use an SBOP policy to write to the bit.

- (1) The Large Physical Address Extension creates a small number of cases where a bit is (1) in some contexts, and has a different defined behavior in other contexts. The meaning of (1) is modified for these bits. For a read/write register, this means:

**If a register bit is (1) for all uses of the register**

- the bit must read as 1
- writes to the bit must be ignored
- software:
  - must not rely on the bit reading as 1
  - must use an SBOP policy to write to the bit.

———— **Note** —————

This definition applies to all bits marked as (1) in an implementation that does not include the Large Physical Address Extensions.

**If a register bit is (1) only for some uses of the register, when that bit is described as (1)**

- A read of the bit must return the value last successfully written to the bit, regardless of the use of the register when the bit was written.  
If the bit has not been successfully written since reset, then the read of the bit returns the reset value if there is one, or otherwise returns an UNKNOWN value.
- A write to the bit must update a storage location associated with the bit.
- While the use of the register is such that the bit is described as (1), or as UNK/SBOP, the value of the bit must have no effect on the operation of the processor, other than determining the value read back from that bit.
- Software:
  - must not rely on the bit reading as 1
  - must use an SBOP policy to write to the bit.

———— **Note** —————

This definition applies only to bits that are defined as (1), or as UNK/SBOP, for one use of a register, and are defined differently for another use of the register.

Fields that are more than one bit wide are sometimes described as UNK/SBOP, instead of having each bit marked as (1).

In a read-only register, (1) indicates that the bit reads as 1, but software must treat the bit as UNK.

In a write-only register, (1) indicates that software must treat the bit as SBO.

## B3.16 Organization of the CP14 registers in a VMSA implementation

The CP14 registers provide a number of distinct control functions, covering:

- Debug
- Trace
- Execution environment control, for the Jazelle and ThumbEE execution environments.

Because these functions are so distinct, the descriptions of these registers are distributed, as follows:

- in this manual:
  - [Chapter C11 The Debug Registers](#) describes the Debug registers
  - [ThumbEE configuration on page A2-95](#) summarizes the ThumbEE registers
  - [Application level configuration and control of the Jazelle extension on page A2-99](#) summarizes the Jazelle registers
- the following ARM trace architecture specifications describe the Trace registers:
  - [Embedded Trace Macrocell Architecture Specification](#)
  - [CoreSight Program Flow Trace Architecture Specification](#).

This section summarizes the allocation of the CP14 registers between these different functions, and the CP14 register encodings that are reserved.

The CP14 register encodings are classified by the {CRn, opc1, CRm, opc2} values required to access them using an MCR or an MRC instruction. The opc1 value determines the primary allocation of these registers, as follows:

- opc1==0** Debug registers.
- opc1==1** Trace registers.
- opc1==6** ThumbEE registers.
- opc1==7** Jazelle registers. Can include Jazelle SUBARCHITECTURE DEFINED registers.

### Other opc1 values

Reserved.

### ———— Note —————

Primary allocation of CP14 register function by opc1 value differs from the allocation of CP15 registers, where primary allocation is by CRn value.

For the Debug registers, considering accesses using MCR or MCR instructions:

- Register encodings with CRn values 8-15 are unallocated.
- For registers with CRn values 0-7, the {CRn, opc2, CRm} values used for accessing the registers map onto a set of register numbers, as defined in [Using CP14 to access debug registers on page C6-2121](#). These register numbers define the order of the registers in:
  - the memory-mapped interfaces to the registers
  - the top-level register summary in [Debug register summary on page C11-2193](#).

### ———— Note —————

Some Debug registers are not visible in some of the Debug register interfaces. For more information see [Chapter C6 Debug Register Interfaces](#).

The ARM trace architectures use the same mapping of {CRn, opc2, CRm} values to register numbers for the Trace registers. The associated opc1 value determines whether a particular CP14 register number refers to the Trace register or the Debug register.



## B3.17 Organization of the CP15 registers in a VMSA implementation

Previous documentation has described the CP15 registers in order of their primary coprocessor register number. More precisely, the ordered set of values {CRn, opc1, CRm, opc2} determined the register order. As the number of system control registers has increased this ordering has become less appropriate. Also, it applies only to 32-bit registers, since 64-bit registers are identified only by {CRm, opc1}, making it difficult to include 32-bit and 64-bit versions of a single register in a common ordering scheme.

This document now:

- Groups the CP15 registers by functional group. For more information about this grouping in a VMSA implementation, including a summary of each functional group, see [Functional grouping of VMSAv7 system control registers on page B3-1491](#).
- Describes all of the system control registers for a VMSA implementation, including the CP15 registers, in [Chapter B4 System Control Registers in a VMSA implementation](#). The description of each register is in the section [VMSA System control registers descriptions, in register order on page B4-1522](#).

This section gives additional information about the organization of the CP15 registers in a VMSA implementation, as follows:

### Register ordering by {CRn, opc1, CRm, opc2}

See:

- [CP15 register summary by coprocessor register number on page B3-1470](#)
- [Full list of VMSA CP15 registers, by coprocessor register number on page B3-1481](#).

#### ———— Note —————

The ordered listing of CP15 registers by the {CRn, opc1, CRm, opc2} encoding of the 32-bit registers is most likely to be useful to those implementing ARMv7 processors, and to those validating such implementations. However, otherwise, the grouping of registers by function is more logical.

### Views of the registers, that depend on the current state of the processor

See [Views of the CP15 registers on page B3-1488](#).

#### ———— Note —————

The different register views are particularly significant in implementations that include the Virtualization Extensions.

In addition, the indexes in [Appendix R Register Index](#) include all of the CP15 registers.

#### ———— Note —————

ARMv7 introduced significant changes to the memory system registers, especially in relation to caches. For more information about:

- how the ARMv7 registers must be used for discovering what caches can be accessed by the processor, see [Identifying the cache resources in ARMv7 on page B2-1267](#).
- the CP15 register implementation in VMSAv6, see [Organization of CP15 registers for an ARMv6 VMSA implementation on page AppxL-2524](#)

### B3.17.1 CP15 register summary by coprocessor register number

Figure B3-26 summarizes the grouping of CP15 registers by primary coprocessor register number for a VMSAv7 implementation.

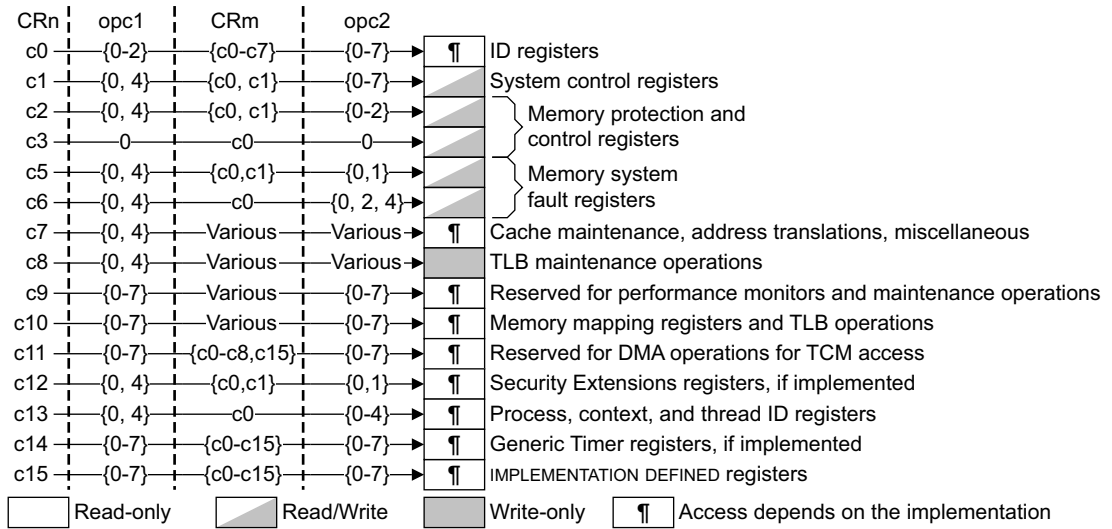

**Figure B3-26 CP15 register grouping by primary coprocessor register, CRn, VMSA implementation**

**Note**

Figure B3-26 gives only an overview of the assigned encodings for each of the CP15 primary registers c0-c15. See the description of each primary register for the definition of the assigned and unassigned encodings for that register, including any dependencies on whether the implementation includes architectural extensions.

The following sections give the register assignments for each of the CP15 primary registers, c0-c15:

- [VMSA CP15 c0 register summary, identification registers on page B3-1471](#)
- [VMSA CP15 c1 register summary, system control registers on page B3-1472](#)
- [VMSA CP15 c2 and c3 register summary, Memory protection and control registers on page B3-1473](#)
- [CP15 c4, Not used on page B3-1473](#)
- [VMSA CP15 c5 and c6 register summary, Memory system fault registers on page B3-1474](#)
- [VMSA CP15 c7 register summary, Cache maintenance, address translation, and other functions on page B3-1475](#)
- [VMSA CP15 c8 register summary, TLB maintenance operations on page B3-1476](#)
- [VMSA CP15 c9 register summary, reserved for cache and TCM control and performance monitors on page B3-1477](#)
- [VMSA CP15 c10 register summary, memory remapping and TLB control registers on page B3-1478](#)
- [VMSA CP15 c11 register summary, reserved for TCM DMA registers on page B3-1478](#)
- [VMSA CP15 c12 register summary, Security Extensions registers on page B3-1479](#)
- [VMSA CP15 c13 register summary, Process, context and thread ID registers on page B3-1479](#)
- [VMSA CP15 c14, reserved for Generic Timer Extension on page B3-1480](#)
- [VMSA CP15 c15 register summary, IMPLEMENTATION DEFINED registers on page B3-1480.](#)

### VMSA CP15 c0 register summary, identification registers

The CP15 c0 registers provide processor and feature identification. Figure B3-27 shows the CP15 c0 registers in a VMSA implementation.

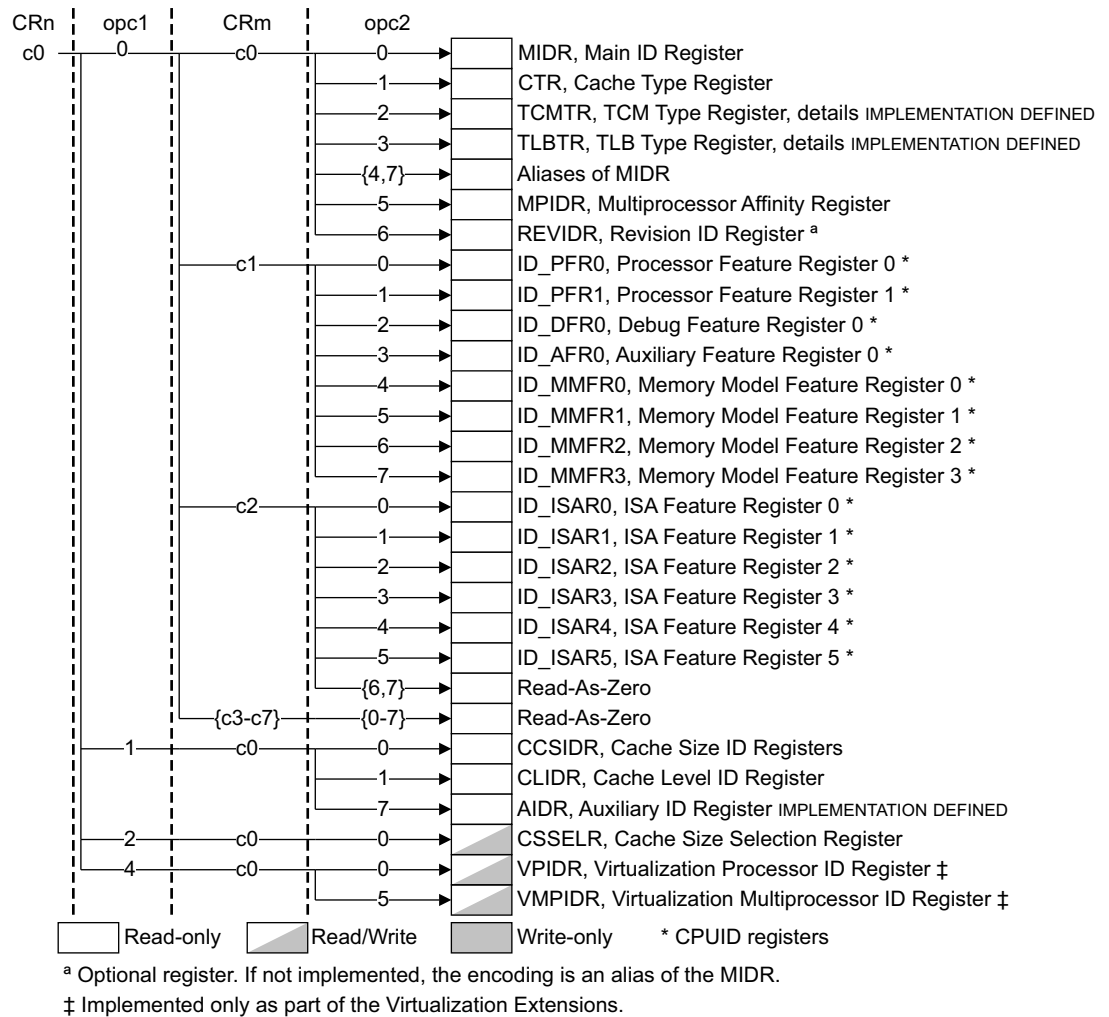

Figure B3-27 CP15 c0 registers in a VMSA implementation

CP15 c0 register encodings not shown in Figure B3-27, and encodings that are part of an unimplemented architectural extension, are UNPREDICTABLE, see [Accesses to unallocated CP14 and CP15 encodings on page B3-1447](#).

**Note**

- [Chapter B7 The CPUID Identification Scheme](#) describes the CPUID registers shown in Figure B3-27.
- The CPUID scheme includes information about the implementation of the OPTIONAL Floating-point and Advanced SIMD architecture extensions. See [Advanced SIMD and Floating-point Extensions on page A2-54](#) for a summary of the implementation options for these features.

### VMSA CP15 c1 register summary, system control registers

The CP15 c1 registers provide system control. Figure B3-28 shows the CP15 c1 registers in a VMSA implementation.

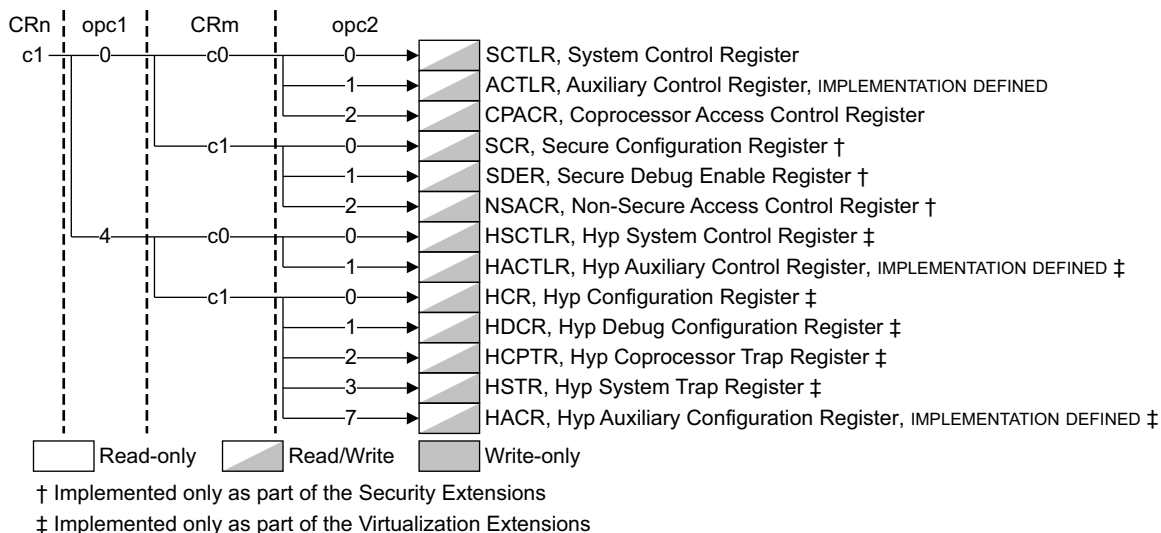

Figure B3-28 CP15 c1 registers in a VMSA implementation

CP15 c1 register encodings not shown in Figure B3-28, and encodings that are part of an unimplemented architectural extension, are UNPREDICTABLE. For more information, see *Accesses to unallocated CP14 and CP15 encodings* on page B3-1447.

### VMSA CP15 c2 and c3 register summary, Memory protection and control registers

On an ARMv7-A implementation, the CP15 c2 and c3 registers provide memory protection and control. Figure B3-29 shows the 32-bit registers in CP15 primary registers c2 and c3.

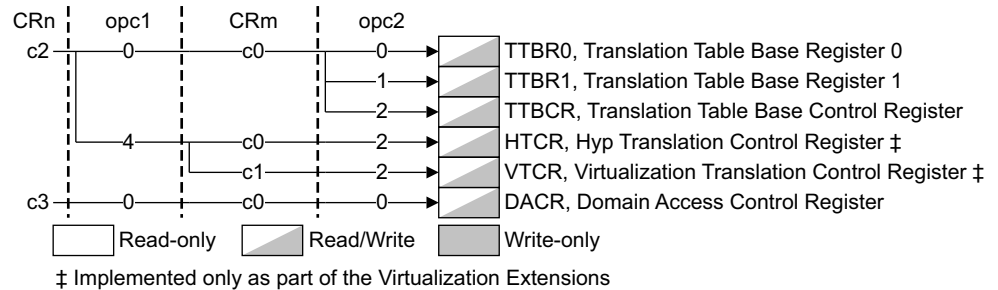

Figure B3-29 CP15 32-bit c2 and c3 registers

CP15 c2 and c3 32-bit register encodings not shown in Figure B3-29, and encodings that are part of an unimplemented architectural extension, are UNPREDICTABLE, see *Accesses to unallocated CP14 and CP15 encodings* on page B3-1447.

On an ARMv7-A implementation that includes the Large Physical Address Extension or Virtualization Extensions, the CP15 c2 register includes some 64-bit system control registers. Figure B3-30 shows these registers.

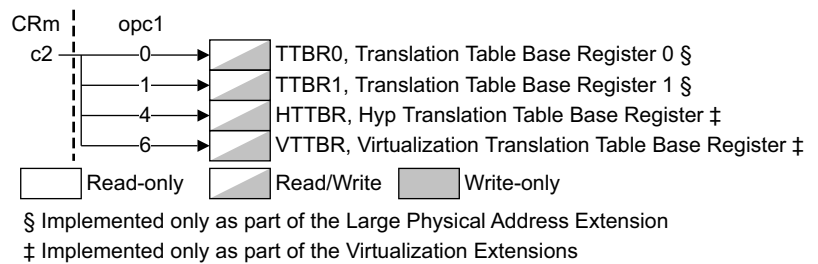

Figure B3-30 CP15 64-bit c2 registers

CP15 c2 64-bit register encodings not shown in Figure B3-30 are UNPREDICTABLE, and the allocations shown in Figure B3-30 are UNPREDICTABLE when the Virtualization Extensions are not implemented. For more information, see *Accesses to unallocated CP14 and CP15 encodings* on page B3-1447.

### CP15 c4, Not used

CP15 c4 is not used on any ARMv7 implementation, see *Accesses to unallocated CP14 and CP15 encodings* on page B3-1447.

### VMSA CP15 c5 and c6 register summary, Memory system fault registers

The CP15 c5 and c6 registers provide memory system fault reporting. Figure B3-31 shows the CP15 c5 and c6 registers in a VMSA implementation.

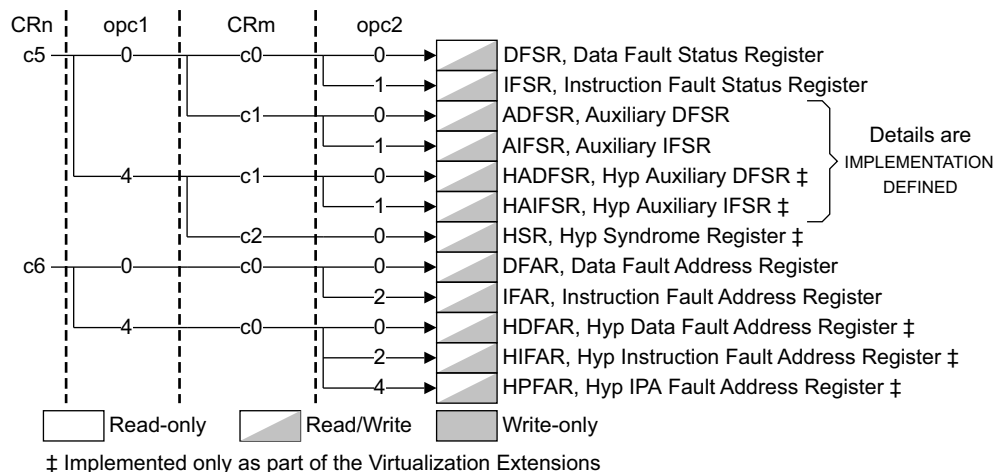
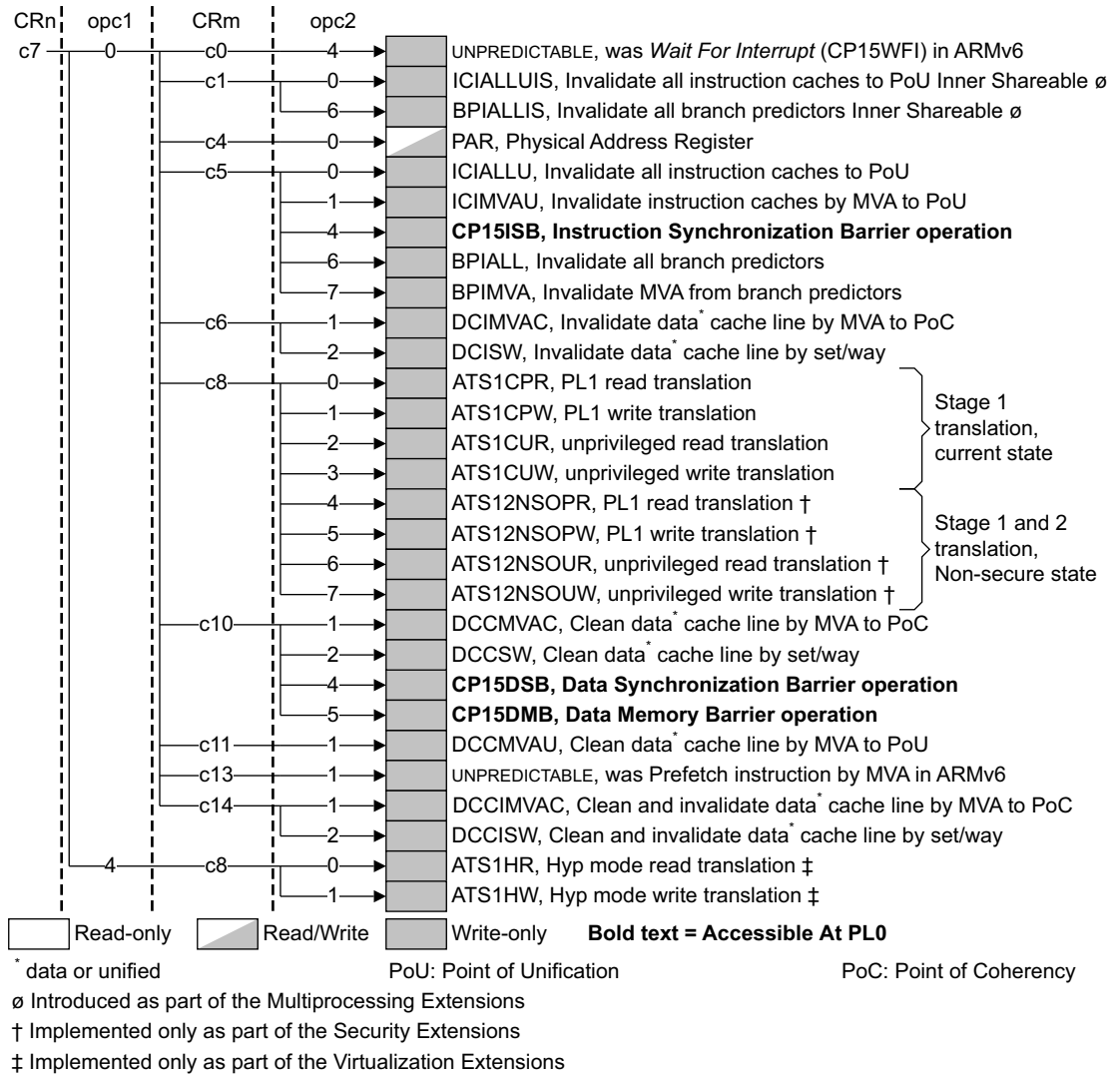

Figure B3-31 CP15 c5 and c6 registers in a VMSA implementation

CP15 c5 and c6 register encodings not shown in Figure B3-31, and encodings that are part of an unimplemented architectural extension, are UNPREDICTABLE, see [Accesses to unallocated CP14 and CP15 encodings on page B3-1447](#).

### VMSA CP15 c7 register summary, Cache maintenance, address translation, and other functions

On an ARMv7-A implementation, the CP15 c7 registers provide cache maintenance operations, address translation operations, and CP15 versions of the memory barrier operations. Figure B3-32 shows the CP15 c7 registers.



**Figure B3-32 CP15 32-bit c7 registers in a VMSA implementation**

CP15 c7 register encodings not shown in Figure B3-32, and encodings that are part of an unimplemented architectural extension, are UNPREDICTABLE, see [Accesses to unallocated CP14 and CP15 encodings on page B3-1447](#).

**Note**

Figure B3-32 shows only those UNPREDICTABLE CP15 c7 encodings that had defined functions in ARMv6.

On an ARMv7-A implementation that includes the Large Physical Address Extension, the CP15 c7 register includes a 64-bit implementation of the PAR, as Figure B3-33 shows.

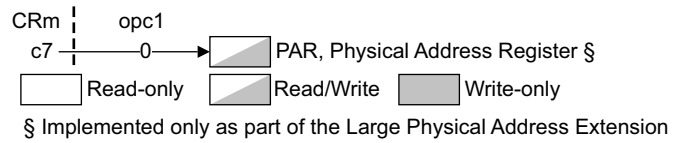

Figure B3-33 CP15 64-bit c7 registers

CP15 c7 64-bit register encodings not shown in Figure B3-33 are UNPREDICTABLE, and the allocations shown in Figure B3-33 are UNPREDICTABLE when the Large Physical Address Extension is not implemented. For more information, see *Accesses to unallocated CP14 and CP15 encodings* on page B3-1447.

**VMSA CP15 c8 register summary, TLB maintenance operations**

On an ARMv7-A implementation, the CP15 c8 registers provide TLB maintenance functions. Figure B3-34 shows the CP15 c8 registers.

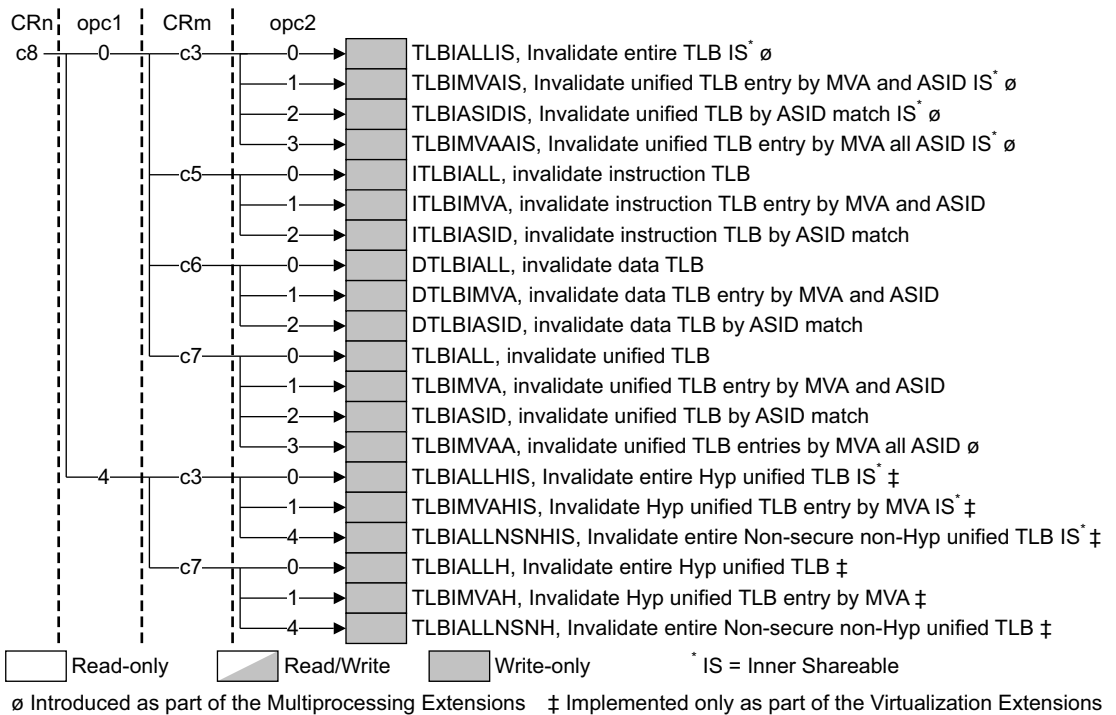

Figure B3-34 CP15 c8 registers in a VMSA implementation

CP15 c8 register encodings not shown in Figure B3-34, and encodings that are part of an unimplemented architectural extension, are UNPREDICTABLE, see *Accesses to unallocated CP14 and CP15 encodings* on page B3-1447.



### VMSA CP15 c9 register summary, reserved for cache and TCM control and performance monitors

ARMv7 reserves some CP15 c9 encodings for IMPLEMENTATION DEFINED memory system functions, in particular:

- cache control, including lockdown
- TCM control, including lockdown
- branch predictor control.

Additional CP15 c9 encodings are reserved for performance monitors. These encodings fall into two groups:

- the OPTIONAL Performance Monitors Extension described in [Chapter C12 The Performance Monitors Extension](#)
- additional IMPLEMENTATION DEFINED performance monitors.

The reserved encodings permit implementations that are compatible with previous versions of the ARM architecture, in particular with the ARMv6 requirements. [Figure B3-35](#) shows the reserved CP15 c9 register encodings in a VMSA implementation.

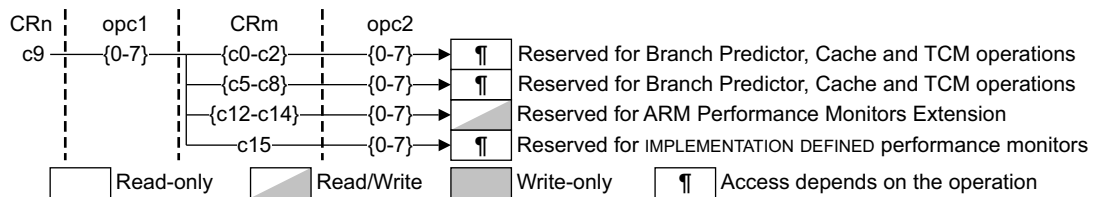

**Figure B3-35 Reserved CP15 c9 encodings**

CP15 c9 encodings not shown in [Figure B3-35](#) are UNPREDICTABLE, see [Accesses to unallocated CP14 and CP15 encodings on page B3-1447](#).

### VMSA CP15 c10 register summary, memory remapping and TLB control registers

On an ARMv7-A implementation, the CP15 c10 registers provide:

- memory remapping registers
- reserved encodings for IMPLEMENTATION DEFINED TLB control functions, including lockdown.

Figure B3-36 shows the CP15 c10 registers and reserved encodings in a VMSA implementation.

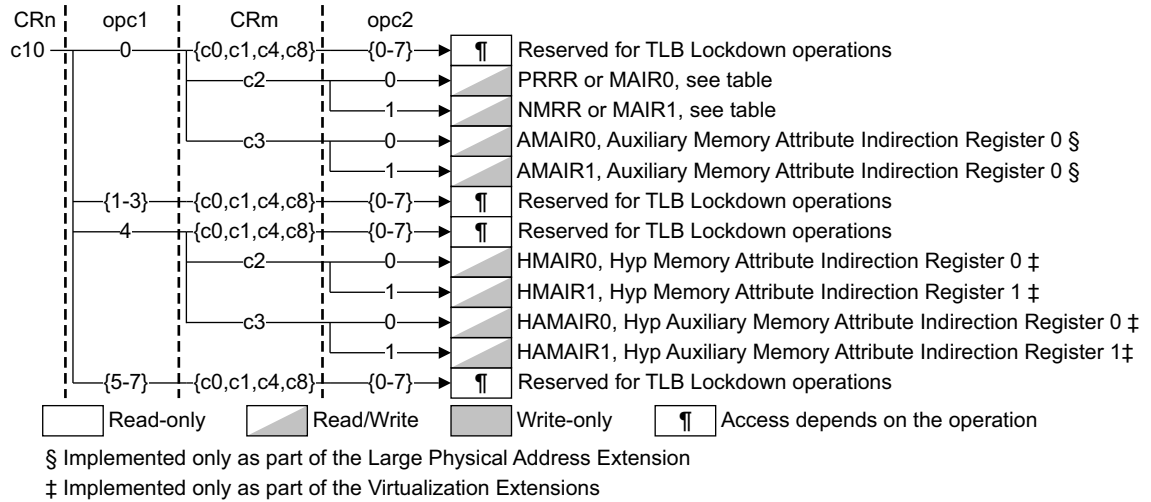

Without Large Physical Address Extension	With Large Physical Address Extension
PRRR, Primary Region Remap Register	MAIR0, Memory Attribute Indirection Register 0
NMRR, Normal Memory Remap Register	MAIR1, Memory Attribute Indirection Register 1

Figure B3-36 CP15 c10 registers in a VMSA implementation

CP15 c10 register encodings not shown in Figure B3-36, and encodings that are part of an unimplemented architectural extension, are UNPREDICTABLE, see [Accesses to unallocated CP14 and CP15 encodings on page B3-1447](#).

### VMSA CP15 c11 register summary, reserved for TCM DMA registers

ARMv7 reserves some CP15 c11 register encodings for IMPLEMENTATION DEFINED DMA operations to and from TCM. Figure B3-37 shows the reserved CP15 c11 encodings:

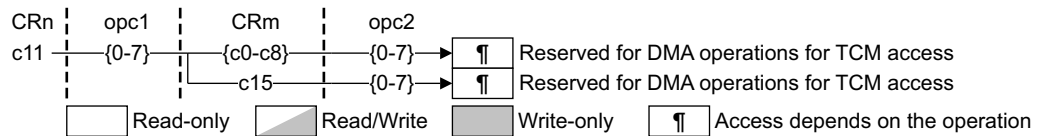

Figure B3-37 Reserved CP15 c11 encodings

CP15 c11 encodings not shown in Figure B3-37 are UNPREDICTABLE, see [Accesses to unallocated CP14 and CP15 encodings on page B3-1447](#).

### VMSA CP15 c12 register summary, Security Extensions registers

On an ARMv7-A implementation that includes the Security Extensions, the CP15 c12 registers provide Security Extensions functions. Figure B3-38 shows the CP15 c12 registers.

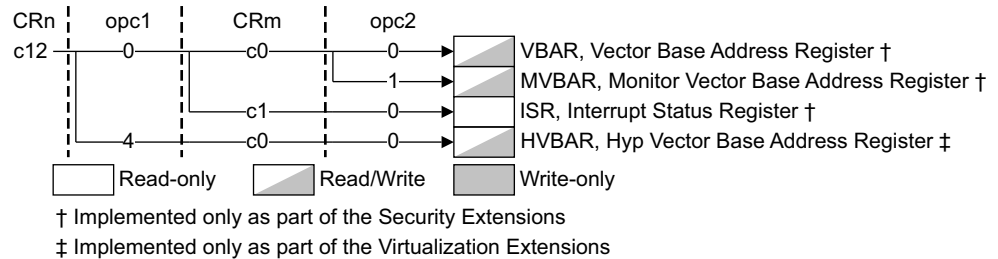

Figure B3-38 Security Extensions CP15 c12 registers

In an implementation that includes the Security Extensions, CP15 c12 encodings not shown in Figure B3-38, and encodings that are part of an unimplemented architectural extension, are UNPREDICTABLE. On an implementation that does not include the Security Extensions all CP15 c12 encodings are UNDEFINED. For more information, see [Accesses to unallocated CP14 and CP15 encodings on page B3-1447](#).

### VMSA CP15 c13 register summary, Process, context and thread ID registers

On an ARMv7-A implementation, the CP15 c8 registers provide TLB maintenance functions. Figure B3-34 on page B3-1476 shows the CP15 c8 registers.

On an ARMv7-A implementation, the CP15 c13 registers provide:

- an FCSE Process ID Register, that indicates whether the implementation includes the FCSE
- a Context ID Register
- Software Thread ID Registers.

Figure B3-39 shows the CP15 c13 registers:

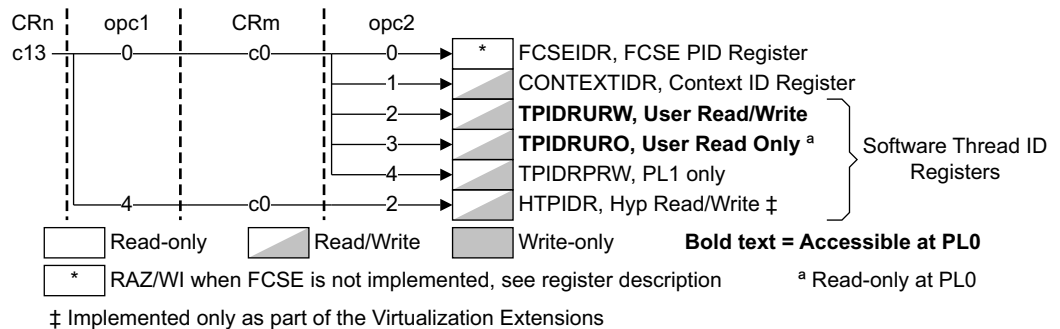

Figure B3-39 CP15 c13 registers in a VMSA implementation

CP15 c13 encodings not shown in Figure B3-39, and encodings that are part of an unimplemented architectural extension, are UNPREDICTABLE, see [Accesses to unallocated CP14 and CP15 encodings on page B3-1447](#).

### VMSA CP15 c14, reserved for Generic Timer Extension

From issue C.a of this manual, CP15 c14 is reserved for the system control registers of the OPTIONAL Generic Timer Extension. For more information, see [Chapter B8 The Generic Timer](#). On an implementation that does not include the Generic Timer, c14 is an unallocated CP15 primary register, see [UNPREDICTABLE and UNDEFINED behavior for CP14 and CP15 accesses](#) on page B3-1446.

Figure B3-40 shows the 32-bit CP15 c14 registers in a VMSAv7 implementation that includes the Generic Timer Extension:

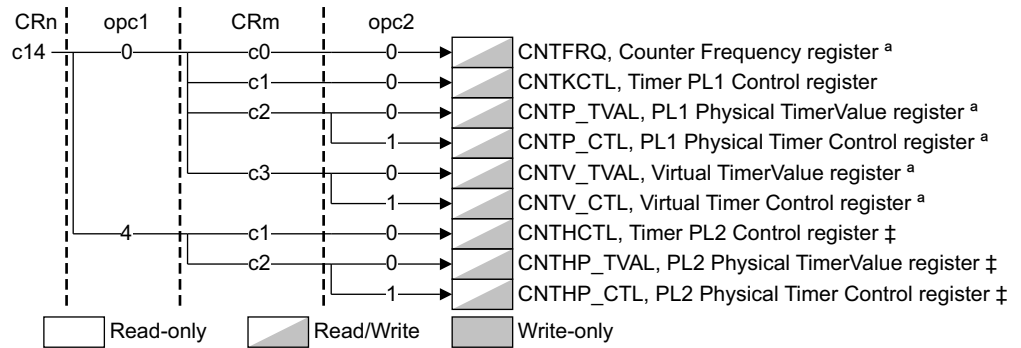

<sup>a</sup> Can be configured as accessible at PL0, see the register description for more information

All registers are implemented only as part of the optional Generic Timer Extension

‡ Implemented only if the implementation includes the Virtualization Extensions

**Figure B3-40 CP15 32-bit c14 registers in a VMSA implementation that includes the Generic Timer Extension**

Figure B3-41 shows the 64-bit CP15 c14 registers in a VMSAv7 implementation that includes the Generic Timer Extension:

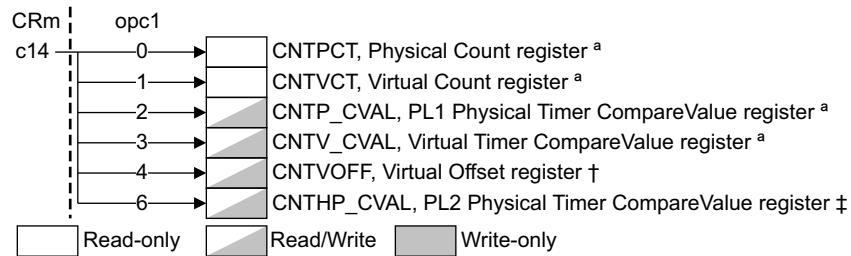

<sup>a</sup> Can be configured as accessible at PL0, see the register description for more information

All registers are implemented only as part of the optional Generic Timer Extension

† Implemented as RW only if the implementation includes the Virtualization Extensions, see the register description for more information

‡ Implemented only if the implementation includes the Virtualization Extensions

**Figure B3-41 CP15 64-bit c14 registers in a VMSA implementation that includes the Generic Timer Extension**

### VMSA CP15 c15 register summary, IMPLEMENTATION DEFINED registers

ARMv7 reserves CP15 c15 for IMPLEMENTATION DEFINED purposes, and does not impose any restrictions on the use of the CP15 c15 encodings. For more information, see [IMPLEMENTATION DEFINED registers, functional group](#) on page B3-1502.

### B3.17.2 Full list of VMSA CP15 registers, by coprocessor register number

Table B3-42 shows the CP15 registers in a VMSA implementation, in the order of the {CRn, opc1, CRm, opc2} values used in MCR or MRC accesses to the 32-bit registers:

- For MCR or MRC accesses to the 32-bit registers, CRn identifies the CP15 primary register used for the access.
- For MCRR or MRRC accesses to the 64-bit registers, CRm identifies the CP15 primary register used for the access. Table B3-42 lists the 64-bit registers with the 32-bit registers accessed using the same CP15 primary register number.

The table also includes links to the descriptions of each of the CP15 primary registers, c0 to c15.

The only UNPREDICTABLE encodings shown in the table are those that had defined functions in ARMv6.

**Table B3-42 Summary of VMSA CP15 register descriptions, in coprocessor register number order**

CRn	opc1	CRm	opc2	Name	Width	Description
c0	0	c0	0	<a href="#">MIDR</a>	32-bit	Main ID Register
			1	<a href="#">CTR</a>	32-bit	Cache Type Register
			2	<a href="#">TCMTR</a>	32-bit	TCM Type Register
			3	<a href="#">TLBTR</a>	32-bit	TLB Type Register
			4, 6 <sup>a</sup> , 7	<a href="#">MIDR</a>	32-bit	Aliases of Main ID Register
			5	<a href="#">MPIDR</a>	32-bit	Multiprocessor Affinity Register
			6 <sup>a</sup>	<a href="#">REVIDR</a>	32-bit	Revision ID Register
c0	0	c1	0	<a href="#">ID_PFR0</a>	32-bit	Processor Feature Register 0
			1	<a href="#">ID_PFR1</a>	32-bit	Processor Feature Register 1
			2	<a href="#">ID_DFR0</a>	32-bit	Debug Feature Register 0
			3	<a href="#">ID_AFR0</a>	32-bit	Auxiliary Feature Register 0
			4	<a href="#">ID_MMFR0</a>	32-bit	Memory Model Feature Register 0
			5	<a href="#">ID_MMFR1</a>	32-bit	Memory Model Feature Register 1
			6	<a href="#">ID_MMFR2</a>	32-bit	Memory Model Feature Register 2
		7	<a href="#">ID_MMFR3</a>	32-bit	Memory Model Feature Register 3	
		c2	0	<a href="#">ID_ISAR0</a>	32-bit	Instruction Set Attribute Register 0
			1	<a href="#">ID_ISAR1</a>	32-bit	Instruction Set Attribute Register 1
			2	<a href="#">ID_ISAR2</a>	32-bit	Instruction Set Attribute Register 2
			3	<a href="#">ID_ISAR3</a>	32-bit	Instruction Set Attribute Register 3
			4	<a href="#">ID_ISAR4</a>	32-bit	Instruction Set Attribute Register 4
			5	<a href="#">ID_ISAR5</a>	32-bit	Instruction Set Attribute Register 5

**Table B3-42 Summary of VMSA CP15 register descriptions, in coprocessor register number order (continued)**

CRn	opc1	CRm	opc2	Name	Width	Description
c0	1	c0	0	CCSIDR	32-bit	Cache Size ID Registers
			1	CLIDR	32-bit	Cache Level ID Register
			7	AIDR	32-bit	IMPLEMENTATION DEFINED Auxiliary ID Register <sup>b</sup>
	2	c0	0	CSSELR	32-bit	Cache Size Selection Register
	4	c0	0	VPIDR <sup>c</sup>	32-bit	Virtualization Processor ID Register
5	VMPIDR <sup>c</sup>		32-bit	Virtualization Multiprocessor ID Register		
c1	0	c0	0	SCTLR	32-bit	System Control Register
			1	ACTLR	32-bit	IMPLEMENTATION DEFINED Auxiliary Control Register
			2	CPACR	32-bit	Coprocessor Access Control Register
		c1	0	SCR <sup>d</sup>	32-bit	Secure Configuration Register
			1	SDER <sup>d</sup>	32-bit	Secure Debug Enable Register
			2	NSACR <sup>d</sup>	32-bit	Non-Secure Access Control Register
c1	4	c0	0	HSCTLR <sup>c</sup>	32-bit	Hyp System Control Register
			1	HACTLR <sup>c</sup>	32-bit	Hyp Auxiliary Control Register
c1	4	c1	0	HCR <sup>c</sup>	32-bit	Hyp Configuration Register
			1	HDCR <sup>c</sup>	32-bit	Hyp Debug Configuration Register
			2	HCPTR <sup>c</sup>	32-bit	Hyp Coprocessor Trap Register
			3	HSTR <sup>c</sup>	32-bit	Hyp System Trap Register
			7	HACR <sup>c</sup>	32-bit	Hyp Auxiliary Configuration Register
c2	0	c0	0	TTBR0	32-bit	Translation Table Base Register 0
-	0	c2	-	TTBR0 <sup>e</sup>	64-bit	
c2	0	c0	1	TTBR1	32-bit	Translation Table Base Register 1
-	1	c2	-	TTBR1 <sup>e</sup>	64-bit	
c2	0	c0	2	TTBCR	32-bit	Translation Table Base Control Register
	4	c0	2	HTCR <sup>c</sup>	32-bit	Hyp Translation Control Register
		c1	2	VTCR <sup>c</sup>	32-bit	Virtualization Translation Control Register
-	4	c2	-	HTTBR <sup>c</sup>	64-bit	Hyp Translation Table Base Register
-	6	c2	-	VTTBR <sup>c</sup>	64-bit	Virtualization Translation Table Base Register
c3	0	c0	1	DACR	32-bit	Domain Access Control Register

**Table B3-42 Summary of VMSA CP15 register descriptions, in coprocessor register number order (continued)**

CRn	opc1	CRm	opc2	Name	Width	Description
c5	0	c0	0	DFSR	32-bit	Data Fault Status Register
			1	IFSR	32-bit	Instruction Fault Status Register
	4	c1	0	AxFSR	32-bit	ADFSR, Auxiliary Data Fault Status Register
			1		32-bit	AIFSR, Auxiliary Instruction Fault Status Register
	4	c1	0	HxFSR <sup>c</sup>	32-bit	HADFSR, Hyp Auxiliary Data Fault Syndrome Register
			1		32-bit	HAIFSR, Hyp Auxiliary Instruction Fault Syndrome Register
		c2	0	HSR <sup>c</sup>	32-bit	Hyp Syndrome Register
c6	0	c0	0	DFAR	32-bit	Data Fault Address Register
			2	IFAR	32-bit	Instruction Fault Address Register
c6	4	c0	0	HDFAR <sup>c</sup>	32-bit	Hyp Data Fault Address Register
			2	HIFAR <sup>c</sup>	32-bit	Hyp Instruction Fault Address Register
			4	HPFAR <sup>c</sup>	32-bit	Hyp IPA Fault Address Register
c7	0	c0	4	UNPREDICTABLE	32-bit	See <i>Retired operations</i> on page B3-1499
			c1	0	ICIALLUIS <sup>f</sup>	32-bit
			6	BPIALLIS <sup>f</sup>	32-bit	
c7	0	c4	0	PAR	32-bit	Physical Address Register
			c7	-	PAR <sup>e</sup>	64-bit
		c5	0	ICIALLU	32-bit	See <i>Cache and branch predictor maintenance operations, VMSA</i> on page B4-1740
			1	ICIMVAU	32-bit	
			4	CP15ISB	32-bit	
		6	BPIALL	32-bit	See <i>Cache and branch predictor maintenance operations, VMSA</i> on page B4-1740	
			7	BPIMVA		32-bit
		c6	1	DCIMVAC	32-bit	See <i>Cache and branch predictor maintenance operations, VMSA</i> on page B4-1740
			2	DCISW	32-bit	

**Table B3-42 Summary of VMSA CP15 register descriptions, in coprocessor register number order (continued)**

CRn	opc1	CRm	opc2	Name	Width	Description		
c7	0	c8	0	ATS1CPR	32-bit	See <i>Performing address translation operations</i> on page B4-1747		
			1	ATS1CPW	32-bit			
			2	ATS1CUR	32-bit			
			3	ATS1CUW	32-bit			
			4	ATS12NSOPR <sup>d</sup>	32-bit			
			5	ATS12NSOPW <sup>d</sup>	32-bit			
			6	ATS12NSOUR <sup>d</sup>	32-bit			
	7	ATS12NSOUW <sup>d</sup>	32-bit					
	c10			1	DCCMVAC	32-bit	See <i>Cache and branch predictor maintenance operations, VMSA</i> on page B4-1740	
				2	DCCSW	32-bit		
				4	CP15DSB	32-bit		See <i>Data and instruction barrier operations, VMSA</i> on page B4-1749
				5	CP15DMB	32-bit		
	c11			1	DCCMVAU	32-bit	See <i>Cache and branch predictor maintenance operations, VMSA</i> on page B4-1740	
	c13			1	UNPREDICTABLE	32-bit	See <i>Retired operations</i> on page B3-1499	
c7	0	c14	1	DCCIMVAC	32-bit	See <i>Cache and branch predictor maintenance operations, VMSA</i> on page B4-1740		
			2	DCCISW	32-bit			
	4	c8	0	ATS1HR <sup>c</sup>	32-bit	See <i>Performing address translation operations</i> on page B4-1747		
			1	ATS1HW <sup>c</sup>	32-bit			
c8	0	c3	0	TLBIALLIS <sup>f</sup>	32-bit	See <i>TLB maintenance operations, not in Hyp mode</i> on page B4-1743		
			1	TLBIMVAIS <sup>f</sup>	32-bit			
			2	TLBIASIDIS <sup>f</sup>	32-bit			
			3	TLBIMVAAIS <sup>f</sup>	32-bit			



**Table B3-42 Summary of VMSA CP15 register descriptions, in coprocessor register number order (continued)**

CRn	opc1	CRm	opc2	Name	Width	Description
c8	0	c5	0	ITLBIALL	32-bit	See <i>TLB maintenance operations, not in Hyp mode</i> on page B4-1743
			1	ITLBIMVA	32-bit	
			2	ITLBIASID	32-bit	
		c6	0	DTLBIALL	32-bit	See <i>TLB maintenance operations, not in Hyp mode</i> on page B4-1743
			1	DTLBIMVA	32-bit	
			2	DTLBIASID	32-bit	
		c7	0	TLBIALL	32-bit	See <i>TLB maintenance operations, not in Hyp mode</i> on page B4-1743
			1	TLBIMVA	32-bit	
			2	TLBIASID	32-bit	
3	TLBIMVAA <sup>f</sup>		32-bit			
4	c3	0	TLBIALLHIS <sup>c</sup>	32-bit	See <i>Hyp mode TLB maintenance operations, Virtualization Extensions</i> on page B4-1746	
		1	TLBIMVAHIS <sup>c</sup>	32-bit		
		4	TLBIALLNSNHIS <sup>c</sup>	32-bit		
	c7	0	TLBIALLH <sup>c</sup>	32-bit	See <i>Hyp mode TLB maintenance operations, Virtualization Extensions</i> on page B4-1746	
		1	TLBIMVAH <sup>c</sup>	32-bit		
		4	TLBIALLNSNH <sup>c</sup>	32-bit		
c9	0-7	c0-c2	0-7	-	32-bit	See <i>Cache and TCM lockdown registers, VMSA</i> on page B4-1750
		c5-c8	0-7	-	32-bit	
c9	0	c12	0	PMCR	32-bit	Performance Monitors Control Register
			1	PMCNTENSET	32-bit	Performance Monitors Count Enable Set register
			2	PMCNTENCLR	32-bit	Performance Monitors Count Enable Clear register
			3	PMOVSRR	32-bit	Performance Monitors Overflow Flag Status Register
			4	PMSWINC	32-bit	Performance Monitors Software Increment register
			5	PMSELR	32-bit	Performance Monitors Event Counter Selection Register
			6	PMCEID0	32-bit	Performance Monitors Common Event Identification register 0
			7	PMCEID1	32-bit	Performance Monitors Common Event Identification register 1
c9	0	c13	0	PMCCNTR	32-bit	Performance Monitors Cycle Count Register
			1	PMXEVTYPER	32-bit	Performance Monitors Event Type Select Register
			2	PMXEVCNTR	32-bit	Performance Monitors Event Count Register

**Table B3-42 Summary of VMSA CP15 register descriptions, in coprocessor register number order (continued)**

CRn	opc1	CRm	opc2	Name	Width	Description		
c9	0	c14	0	<a href="#">PMUSERENR</a>	32-bit	Performance Monitors User Enable Register		
			1	<a href="#">PMINTENSET</a>	32-bit	Performance Monitors Interrupt Enable Set register		
			2	<a href="#">PMINTENCLR</a>	32-bit	Performance Monitors Interrupt Enable Clear register		
			3	<a href="#">PMOVSSSET</a> <sup>c</sup>	32-bit	Performance Monitors Overflow Flag Status Set register		
c9	0	c15	0-7	-	32-bit	See <a href="#">Performance Monitors, functional group on page B3-1500</a>		
	1-7	c12- c15	0-7	-	32-bit			
c10	0	c0, c1, c4, c8	0-7	-		See <a href="#">IMPLEMENTATION DEFINED TLB control operations, VMSA on page B4-1750</a>		
c10	0	c2	0	<a href="#">PRRR</a> <sup>g</sup>	32-bit	Primary Region Remap Register		
				<a href="#">MAIR0</a> <sup>g</sup>	32-bit	MAIR0, Memory Attribute Indirection Register 0		
			1	<a href="#">NMRR</a> <sup>g</sup>	32-bit	Normal Memory Remap Register		
				<a href="#">MAIR1</a> <sup>g</sup>	32-bit	MAIR1, Memory Attribute Indirection Register 1		
		c3	0	<a href="#">AMAIR0</a> <sup>e</sup>	32-bit	AMAIR0, Auxiliary Memory Attribute Indirection Register 0		
			1	<a href="#">AMAIR1</a> <sup>e</sup>	32-bit	AMAIR1, Auxiliary Memory Attribute Indirection Register 1		
		4	c2	0	<a href="#">HMAIR0</a> <sup>c</sup>	32-bit	HMAIR0, Hyp Memory Attribute Indirection Register 0	
				1	<a href="#">HMAIR1</a> <sup>c</sup>	32-bit	HMAIR1, Hyp Memory Attribute Indirection Register 1	
		c3	0	<a href="#">HAMAIR0</a> <sup>c</sup>	32-bit	HAMAIR0, Hyp Auxiliary Memory Attribute Indirection Register 0		
				<a href="#">HAMAIR1</a> <sup>c</sup>	32-bit	HAMAIR0, Hyp Auxiliary Memory Attribute Indirection Register 1		
		c11	0-7	c0-c8	0-7	-	32-bit	See <a href="#">DMA support, VMSA on page B4-1751</a>
				c15	c15	-	32-bit	
c12	0	c0	0	<a href="#">VBAR</a> <sup>d</sup>	32-bit	Vector Base Address Register		
			1	<a href="#">MVBAR</a> <sup>d</sup>	32-bit	Monitor Vector Base Address Register		
		c1	0	<a href="#">ISR</a> <sup>d</sup>	32-bit	Interrupt Status Register		
			4	<a href="#">HVBAR</a> <sup>c, d</sup>	32-bit	Hyp Vector Base Address Register		
c13	0	c0	0	<a href="#">FCSEIDR</a>	32-bit	FCSE Process ID Register		
			1	<a href="#">CONTEXTIDR</a>	32-bit	Context ID Register		
			2	<a href="#">TPIDRURW</a>	32-bit	User Read/Write Thread ID Register		
			3	<a href="#">TPIDRURO</a>	32-bit	User Read-Only Thread ID Register		
			4	<a href="#">TPIDRPRW</a>	32-bit	PL1 only Thread ID Register		
		4	<a href="#">HTPIDR</a> <sup>c</sup>	32-bit	Hyp Software Thread ID Register			

**Table B3-42 Summary of VMSA CP15 register descriptions, in coprocessor register number order (continued)**

CRn	opc1	CRm	opc2	Name	Width	Description
c14	0	c0	0	<a href="#">CNTFRQ<sup>h</sup></a>	32-bit	Counter Frequency register
-	0	c14	-	<a href="#">CNTPCT<sup>h</sup></a>	64-bit	Physical Count register
c14	0	c1	0	<a href="#">CNTKCTL<sup>h</sup></a>	32-bit	Timer PL1 Control register
			0	<a href="#">CNTP_TVAL<sup>h</sup></a>	32-bit	PL1 Physical TimerValue register
		1	0	<a href="#">CNTP_CTL<sup>h</sup></a>	32-bit	PL1 Physical Timer Control register
			0	<a href="#">CNTV_TVAL<sup>h</sup></a>	32-bit	Virtual TimerValue register
		1	<a href="#">CNTV_CTL<sup>h</sup></a>	32-bit	Virtual Timer Control register	
-	1	c14	-	<a href="#">CNTVCT<sup>h</sup></a>	64-bit	Virtual Count register
			2	<a href="#">CNTP_CVAL<sup>h</sup></a>	64-bit	PL1 Physical Timer CompareValue register1
			3	<a href="#">CNTV_CVAL<sup>h</sup></a>	64-bit	Virtual Timer CompareValue register
			4	<a href="#">CNTVOFF<sup>i</sup></a>	64-bit	Virtual Offset register
c14	4	c1	0	<a href="#">CNTHCTL</a>	32-bit	Timer PL2 Control register
			0	<a href="#">CNTHP_TVAL</a>	32-bit	PL2 Physical TimerValue register
		1	<a href="#">CNTHP_CTL</a>	32-bit	PL2 Physical Timer Control register	
-	6	c14	-	<a href="#">CNTHP_CVAL</a>	64-bit	PL2 Physical Timer CompareValue register
c15	0-7	c0-c15	0-7	-	32-bit	See <i>IMPLEMENTATION DEFINED registers, functional group</i> on page B3-1502

- a. [REVIDR](#) is an optional register. If it is not implemented, the encoding with opc2 set to 6 is an alias of [MIDR](#).
- b. In some ARMv7 implementations, the [AIDR](#) is UNDEFINED.
- c. Implemented only as part of the Virtualization Extensions. Otherwise, encoding is unallocated and UNPREDICTABLE, see *Accesses to unallocated CP14 and CP15 encodings* on page B3-1447.
- d. Implemented only as part of the Security Extensions. Otherwise, as described in *Accesses to unallocated CP14 and CP15 encodings* on page B3-1447, encoding is unallocated and:
  - UNDEFINED, for the registers accessed using CRn set to c12.
  - UNPREDICTABLE, for the register accessed using CRn values other than c12.
- e. Implemented only as part of the Large Physical Address Extension. Otherwise, encoding is unallocated and UNPREDICTABLE, see *Accesses to unallocated CP14 and CP15 encodings* on page B3-1447.
- f. Added as part of the Multiprocessing Extensions. In earlier ARMv7 implementations, encoding is unallocated and UNPREDICTABLE, see *Accesses to unallocated CP14 and CP15 encodings* on page B3-1447.
- g. When an implementation is using the Long descriptor translation table format these encodings access the [MAIR<sub>n</sub>](#) registers. Otherwise, including on any implementation that does not include the Large Physical Address Extension, they access the [PRRR](#) and [NMRR](#).
- h. Implemented only as part of the Generic Timers Extension. Otherwise, encoding is unallocated and UNDEFINED, see *Accesses to unallocated CP14 and CP15 encodings* on page B3-1447.
- i. Implemented as RW only as part of the Generic Timers Extension on an implementation that includes the Virtualization Extensions. For more information see *Status of the CNTVOFF register* on page B8-1968.

### B3.17.3 Views of the CP15 registers

The following sections summarize the different software views of the CP15 registers, for a VMSA implementation:

- [PL0 views of the CP15 registers](#)
- [PL1 views of the CP15 registers](#) on page B3-1489
- [Non-secure PL2 view of the CP15 registers](#) on page B3-1490.

#### PL0 views of the CP15 registers

Software executing at PL0, unprivileged, can access only a small subset of the CP15 registers, as [Table B3-43](#) shows. This table excludes possible PL0 access to CP15 registers that are part of the following OPTIONAL extensions to the architecture:

- the Performance Monitors Extension, see [Possible PL0 access to the Performance Monitors Extension CP15 registers](#)
- the Generic Timer Extension, see [Possible PL0 access to the Generic Timer Extension CP15 registers](#) on page B3-1489.

**Table B3-43 CP15 registers accessible from PL0**

Name	Access	Description	Note
CP15ISB	WO	<a href="#">Data and instruction barrier operations, VMSA</a> on page B4-1749	ARM deprecates use of these operations
CP15DSB	WO		
CP15DMB	WO		
TPIDRURW	RW	<a href="#">TPIDRURW, User Read/Write Thread ID Register, VMSA</a> on page B4-1720	-
TPIDRURO	RO	<a href="#">TPIDRURO, User Read-Only Thread ID Register, VMSA</a> on page B4-1719	RW at PL1

#### Possible PL0 access to the Performance Monitors Extension CP15 registers

In a VMSAv7 implementation that includes the Performance Monitors Extension, when using CP15 to access the Performance Monitors registers:

- The [PMUSERENR](#) is RO from PL0.
- When [PMUSERENR.EN](#) is set to 1:
  - the [PMCR](#), [PMOVSr](#), [PMSELR](#), [PMCCNTR](#), [PMXEVTYPER](#), [PMXEVCNTR](#), and the [PMCNTENSET](#), [PMCNTENCLR](#), and [PMSWINC](#) registers, are accessible from PL0
  - if the implementation includes PMUv2, the [PMCEID<sub>n</sub>](#) registers are accessible from PL0
  - if the implementation includes the Virtualization Extensions, the [PMOVSSET](#) register is accessible from PL0.

When [PMUSERENR.EN](#) is set to 1, these registers have the same access permissions from PL0 as they do from PL1.

For more information, see [CP15 c9 performance monitors registers](#) on page C12-2326 and [Access permissions](#) on page C12-2328.

### Possible PL0 access to the Generic Timer Extension CP15 registers

In a VMSAv7 implementation that includes the Generic Timer Extension, when using CP15 to access the Generic Timer registers:

- If `CNTKCTL.PL0PCTEN` is set to 1, then if the physical counter register `CNTPCT` is accessible from PL1 it is also accessible from PL0. For more information see [Accessing the physical counter on page B8-1960](#).
- If `CNTKCTL.PL0PVTEN` is set to 1, the virtual counter register `CNTVCT` is accessible from PL0. For more information, see [Accessing the virtual counter on page B8-1961](#).
- If at least one of `CNTKCTL.{PL0PCTEN, PL0PVTEN}` is set to 1, the `CNTFRQ` register is RO from PL0.
- If:
  - `CNTKCTL.PL0PTEN` is set to 1, the physical timer registers `CNTP_CTL`, `CNTP_CVAL`, and `CNTP_TVAL` are accessible from PL0
  - `CNTKCTL.PL0VTEN` is set to 1, the virtual timer registers `CNTV_CTL`, `CNTV_CVAL`, and `CNTV_TVAL`, are accessible from PL0.

For more information, see [Accessing the timer registers on page B8-1964](#).

### PL1 views of the CP15 registers

Software executing at PL1 can access all CP15 registers, with the following exceptions:

#### Non-secure PL1 software

The Security Extensions restrict or prevent access to some registers by Non-secure PL1 software. In particular:

- the Restricted access CP15 registers are either not accessible to Non-secure PL1 software, or are read-only to Non-secure PL1 software, see [Restricted access system control registers on page B3-1453](#)
- configuration settings determine whether Non-secure PL1 software can access the Configurable access CP15 registers, see [Configurable access system control registers on page B3-1453](#).

The individual register descriptions identify these access restrictions.

In an implementation that includes the Virtualization Extensions, Non-secure PL1 software has no visibility of the PL2-mode registers summarized in [Banked PL2-mode CP15 read/write registers on page B3-1454](#). The individual register descriptions identify these registers as PL2-mode registers.

#### Secure PL1 software

In general, Secure PL1 software has access to all CP15 registers. However:

- The `CP15SDISABLE` signal disables write access to a number of Secure registers, see [The CP15SDISABLE input on page B3-1458](#).
- To access the PL2-mode registers, Secure PL1 software must move into Monitor mode, and set `SCR.NS` to 1. [Banked PL2-mode CP15 read/write registers on page B3-1454](#) summarizes these registers.

The individual register descriptions identify:

- the registers affected by the `CP15SDISABLE` signal
- the PL2-mode registers.

## Non-secure PL2 view of the CP15 registers

Non-secure software executing at PL2 can access:

- The registers that are accessible to Non-secure software executing at PL1, as defined in *PL1 views of the CP15 registers* on page B3-1489. Access permissions for these registers are identical to those for Non-secure software executing at PL1.
- The PL2-mode registers summarized in *Banked PL2-mode CP15 read/write registers* on page B3-1454, and described in *Virtualization Extensions registers, functional group* on page B3-1501.

## B3.18 Functional grouping of VMSAv7 system control registers

This section describes how the system control registers in an VMSAv7 implementation divide into functional groups. [Chapter B4 System Control Registers in a VMSA implementation](#) describes these registers, in alphabetical order of the register names.

These registers are implemented in the CP15 System Control Coprocessor. Therefore, these sections and chapters describe the CP15 registers for a VMSAv7 implementation.

[Table B3-42 on page B3-1481](#) lists all of the CP15 registers in a VMSAv7 implementation, ordered by:

1. The CP15 primary register used when accessing the register. This is the CRn value for an access to a 32-bit register, or the CRm value for an access to a 64-bit register.
2. The opc1 value used when accessing the register.
3. For 32-bit registers, the {CRm, opc2} values used when accessing the register.

Entries in this table index the detailed description of each register.

An ARMv7 implementation with a PMSA also implements some of the registers described in this chapter. For more information, see [Functional grouping of PMSAv7 system control registers on page B5-1797](#).

For other related information see:

- [Coprorocessors and system control on page B1-1225](#) for general information about the System Control Coprocessor, CP15 and the register access instructions MRC and MCR
- [About the system control registers for VMSA on page B3-1444](#) for general information about the CP15 registers in a VMSA implementation, including:
  - their organization, both by CP15 primary registers c0 to c15, and by function
  - their general behavior
  - the effect of different ARMv7 architecture extensions on the registers
  - different views of the registers, that depend on the state of the processor
  - conventions used in describing the registers.

The remainder of this chapter, and [Chapter B4 System Control Registers in a VMSA implementation](#), assumes you are familiar with [About the system control registers for VMSA on page B3-1444](#), and uses conventions and other information from that section without any explanation.

Each of the following sections summarizes a functional group of VMSA system control registers:

- [Identification registers, functional group on page B3-1492](#)
- [Virtual memory control registers, functional group on page B3-1493](#)
- [PL1 Fault handling registers, functional group on page B3-1494](#)
- [Other system control registers, functional group on page B3-1494](#)
- [Lockdown, DMA, and TCM features, functional group, VMSA on page B3-1495](#)
- [Cache maintenance operations, functional group, VMSA on page B3-1496](#)
- [TLB maintenance operations, functional group on page B3-1497](#)
- [Address translation operations, functional group on page B3-1498](#)
- [Miscellaneous operations, functional group on page B3-1499](#)
- [Performance Monitors, functional group on page B3-1500](#)
- [Security Extensions registers, functional group on page B3-1500](#)
- [Virtualization Extensions registers, functional group on page B3-1501](#)
- [Generic Timer Extension registers on page B3-1502](#)
- [IMPLEMENTATION DEFINED registers, functional group on page B3-1502](#).

### B3.18.1 Identification registers, functional group

Table B3-44 shows the Identification registers in a VMSA implementation.

**Table B3-44 Identification registers, VMSA**

Name	CRn	opc1	CRm	opc2	Width	Type	Description
AIDR	c0	1	c0	7	32-bit	RO	IMPLEMENTATION DEFINED Auxiliary ID Register
CCSIDR	c0	1	c0	0	32-bit	RO	Cache Size ID Registers
CLIDR	c0	1	c0	1	32-bit	RO	Cache Level ID Register
CSSELR	c0	2	c0	0	32-bit	RW	Cache Size Selection Register
CTR	c0	0	c0	1	32-bit	RO	Cache Type Register
ID_AFR0	c0	0	c1	3	32-bit	RO	Auxiliary Feature Register 0 <sup>a</sup>
ID_DFR0	c0	0	c1	2	32-bit	RO	Debug Feature Register 0 <sup>a</sup>
ID_ISAR0	c0	0	c2	0	32-bit	RO	Instruction Set Attribute Register 0 <sup>a</sup>
ID_ISAR1	c0	0	c2	1	32-bit	RO	Instruction Set Attribute Register 1 <sup>a</sup>
ID_ISAR2	c0	0	c2	2	32-bit	RO	Instruction Set Attribute Register 2 <sup>a</sup>
ID_ISAR3	c0	0	c2	3	32-bit	RO	Instruction Set Attribute Register 3 <sup>a</sup>
ID_ISAR4	c0	0	c2	4	32-bit	RO	Instruction Set Attribute Register 4 <sup>a</sup>
ID_ISAR5	c0	0	c2	5	32-bit	RO	Instruction Set Attribute Register 5 <sup>a</sup>
ID_MMFR0	c0	0	c1	4	32-bit	RO	Memory Model Feature Register 0 <sup>a</sup>
ID_MMFR1	c0	0	c1	5	32-bit	RO	Memory Model Feature Register 1 <sup>a</sup>
ID_MMFR2	c0	0	c1	6	32-bit	RO	Memory Model Feature Register 2 <sup>a</sup>
ID_MMFR3	c0	0	c1	7	32-bit	RO	Memory Model Feature Register 3 <sup>a</sup>
ID_PFR0	c0	0	c1	0	32-bit	RO	Processor Feature Register 0 <sup>a</sup>
ID_PFR1	c0	0	c1	1	32-bit	RO	Processor Feature Register 1 <sup>a</sup>
MIDR	c0	0	c0	0	32-bit	RO	Main ID Register
MPIDR	c0	0	c0	5	32-bit	RO	Multiprocessor Affinity Register
REVIDR	c0	0	c0	6	32-bit	RO	Revision ID Register
TCMTR	c0	0	c0	2	32-bit	RO	TCM Type Register
TLBTR	c0	0	c0	3	32-bit	RO	TLB Type Register

a. CPUID register, see also [Chapter B7 The CPUID Identification Scheme](#).

The FPSID, MVFR0, MVFR1, and JIDR hold additional identification information.



## B3.18.2 Virtual memory control registers, functional group

Table B3-45 shows the Virtual memory control registers in a VMSA implementation.

**Table B3-45 Virtual memory control registers, VMSA only**

Name	CRn	opc1	CRm	opc2	Width	Type	Description
<a href="#">AMAIR0</a> <sup>a</sup>	c10	0	c3	0	32 bit	RW	Auxiliary Memory Attribute Indirection Register 0
<a href="#">AMAIR1</a> <sup>a</sup>				1	32 bit	RW	Auxiliary Memory Attribute Indirection Register 1
<a href="#">CONTEXTIDR</a>	c13	0	c0	1	32 bit	RW	Context ID Register
<a href="#">DACR</a>	c3	0	c0	0	32 bit	RW	Domain Access Control Register
<a href="#">MAIR0</a>	c10	0	c2	0	32 bit	RW	Memory Attribute Indirection Register 0
<a href="#">MAIR1</a>				1	32 bit	RW	Memory Attribute Indirection Register 1
<a href="#">NMRR</a>	c10	0	c2	1	32 bit	RW	Normal Memory Remap Register
<a href="#">PRRR</a>				0	32 bit	RW	Primary Region Remap Register
<a href="#">SCTLR</a>	c1	0	c0	0	32 bit	RW	System Control Register
<a href="#">TTBCR</a>	c2	0	c0	2	32 bit	RW	Translation Table Base Control Register
<a href="#">TTBR0</a>	c2	0	c0	0	32 bit	RW	Translation Table Base Register 0
<a href="#">TTBR0</a>	-	0	c2	-	64 bit <sup>b</sup>	RW	Translation Table Base Register 0
<a href="#">TTBR1</a>	c2	0	c0	1	32 bit	RW	Translation Table Base Register 1
<a href="#">TTBR1</a>	-	1	c2	-	64 bit <sup>b</sup>	RW	Translation Table Base Register 1

- Implemented as part of the Large Physical Address Extension. Otherwise, encodings are unallocated and reserved, see [Accesses to unallocated CP14 and CP15 encodings on page B3-1447](#)
- Implemented as part of the Large Physical Address Extension. Otherwise, encoding is unallocated and UNDEFINED, see [Accesses to unallocated CP14 and CP15 encodings on page B3-1447](#).

The IMPLEMENTATION DEFINED [ACTLR](#) might provided additional virtual memory control. For more information see [Other system control registers, functional group on page B3-1494](#).

### B3.18.3 PL1 Fault handling registers, functional group

Table B3-46 shows the PL1 Fault handling registers in a VMSA implementation.

**Table B3-46 Fault handling registers, VMSA**

Name	CRn	opc1	CRm	opc2	Width	Type	Description
AxFSR	c5	0	c1	0	32-bit	RW	Auxiliary Data Fault Status Register
				1	32-bit	RW	Auxiliary Instruction Fault Status Register
DFAR	c6	0	c0	0	32-bit	RW	Data Fault Address Register
DFSR	c5	0	c0	0	32-bit	RW	Data Fault Status Register
IFAR	c6	0	c0	2	32-bit	RW	Instruction Fault Address Register
IFSR	c5	0	c0	1	32-bit	RW	Instruction Fault Status Register

The processor returns fault information using the fault status registers and the fault address registers. For details of how these registers are used see [Exception reporting in a VMSA implementation on page B3-1409](#).

———— **Note** —————

- These registers also report information about debug exceptions. For more information see:
  - [Data Abort exceptions, taken to a PL1 mode on page B3-1411](#)
  - [Prefetch Abort exceptions, taken to a PL1 mode on page B3-1413](#)
  - [Reporting exceptions taken to the Non-secure PL2 mode on page B3-1420](#)
- Before ARMv7:
  - The [DFAR](#) was called the Fault Address Register (FAR).
  - The Watchpoint Fault Address Register, [DBGWFAR](#), was implemented in CP15 c6, with <opc2> = 1. In ARMv7, the [DBGWFAR](#) is only implemented as a CP14 debug register.

The Virtualization Extensions include additional fault handling registers. For more information see [Virtualization Extensions registers, functional group on page B3-1501](#).

### B3.18.4 Other system control registers, functional group

Table B3-47 shows the Other system control registers in a VMSA implementation.

**Table B3-47 Other system control registers, VMSA**

Name	CRn	opc1	CRm	opc2	Width	Type	Description
ACTLR	c1	0	c0	1	32-bit	RW	IMPLEMENTATION DEFINED Auxiliary Control Register
CPACR	c1	0	c0	2	32-bit	RW	Coprocessor Access Control Register
FCSEIDR	c13	0	c0	0	32-bit	a	FCSE Process ID Register

- a. The [FCSEIDR](#) is RO if the processor does not implement the FCSE, and RW otherwise. See the register description for more information.

The following sections summarize the system control registers added by the corresponding architecture extension:

- [Security Extensions registers, functional group on page B3-1500](#)
- [Virtualization Extensions registers, functional group on page B3-1501](#).

### B3.18.5 Lockdown, DMA, and TCM features, functional group, VMSA

Table B3-48 shows the Lockdown, DMA, and TCM features registers in a VMSA implementation.

**Table B3-48 Lockdown, DMA, and TCM features, VMSA**

Name	CRn	opc1	CRm	Width	opc2	Type	Description
IMPLEMENTATION DEFINED	c9	0-7	c0-c2	32-bit	0-7	a	<i>Cache and TCM lockdown registers, VMSA on page B4-1750</i>
			c5-c8	32-bit	0-7	a	
	c10	0	c0-c1	32-bit	0-7	a	<i>IMPLEMENTATION DEFINED TLB control operations, VMSA on page B4-1750</i>
			c4	32-bit	0-7	a	
			c8	32-bit	0-7	a	
	c11	0-7	c0-c8	32-bit	0-7	a	<i>DMA support, VMSA on page B4-1751</i>
c15			32-bit	0-7	a		

a. Access depends on the register or operation, and is IMPLEMENTATION DEFINED.

### B3.18.6 Cache maintenance operations, functional group, VMSA

Table B3-49 shows the Cache and branch predictor maintenance operations in a VMSA implementation.

**Table B3-49 Cache and branch predictor maintenance operations, VMSA**

Name	CRn	opc1	CRm	opc2	Width	Type	Description	Limits <sup>a</sup>
<a href="#">BPIALL<sup>c</sup></a>	c7	0	c5	6	32-bit	WO	Branch predictor invalidate all	-
<a href="#">BPIALLIS<sup>b, c</sup></a>	c7	0	c1	6	32-bit	WO	Branch predictor invalidate all	IS
<a href="#">BPIMVA<sup>c</sup></a>	c7	0	c5	7	32-bit	WO	Branch predictor invalidate by MVA	-
<a href="#">DCCIMVAC<sup>c</sup></a>	c7	0	c14	1	32-bit	WO	Data cache clean and invalidate by MVA	PoC
<a href="#">DCCISW<sup>c</sup></a>	c7	0	c14	2	32-bit	WO	Data cache clean and invalidate by set/way	-
<a href="#">DCCMVAC<sup>c</sup></a>	c7	0	c10	1	32-bit	WO	Data cache clean by MVA	PoC
<a href="#">DCCMVAU<sup>c</sup></a>	c7	0	c11	1	32-bit	WO	Data cache clean by MVA	PoU
<a href="#">DCCSW<sup>c</sup></a>	c7	0	c10	2	32-bit	WO	Data cache clean by set/way	-
<a href="#">DCIMVAC<sup>c</sup></a>	c7	0	c6	1	32-bit	WO	Data cache invalidate by MVA	PoC
<a href="#">DCISW<sup>c</sup></a>	c7	0	c6	2	32-bit	WO	Data cache invalidate by set/way	-
<a href="#">ICIALLU<sup>c</sup></a>	c7	0	c5	0	32-bit	WO	Instruction cache invalidate all	PoU
<a href="#">ICIALLUIS<sup>b, c</sup></a>	c7	0	c1	0	32-bit	WO	Instruction cache invalidate all	PoU, IS
<a href="#">ICIMVAU<sup>c</sup></a>	c7	0	c5	1	32-bit	WO	Instruction cache invalidate by MVA	PoU

- PoU = to Point of Unification, PoC = to Point of Coherence, IS = Inner Shareable.
- Introduced in the Multiprocessing Extensions, UNPREDICTABLE in earlier ARMv7 implementations, see [Accesses to unallocated CP14 and CP15 encodings on page B3-1447](#).
- The links in this column are to a summary of the operation. [Cache and branch predictor maintenance operations, VMSA on page B4-1740](#) describes the operation.

As stated in the table footnote, [Cache and branch predictor maintenance operations, VMSA on page B4-1740](#) describes these operations.

### B3.18.7 TLB maintenance operations, functional group

Table B3-50 shows the TLB maintenance operations in a VMSA implementation that does not implement the Virtualization Extensions.

**Table B3-50 TLB maintenance operations, VMSA only**

Name	CRn	opc1	CRm	opc2	Width	Type	Description	Limits <sup>a</sup>
<a href="#">DTLBIALL</a> <sup>b, d</sup>	c8	0	c6	0	32-bit	WO	Invalidate entire data TLB	-
<a href="#">DTLBIASID</a> <sup>b, d</sup>	c8	0	c6	2	32-bit	WO	Invalidate data TLB by ASID	-
<a href="#">DTLBIMVA</a> <sup>b, d</sup>	c8	0	c6	1	32-bit	WO	Invalidate data TLB entry by MVA	-
<a href="#">ITLBIALL</a> <sup>b, d</sup>	c8	0	c5	0	32-bit	WO	Invalidate entire instruction TLB	-
<a href="#">ITLBIASID</a> <sup>b, d</sup>	c8	0	c5	2	32-bit	WO	Invalidate instruction TLB by ASID	-
<a href="#">ITLBIMVA</a> <sup>b, d</sup>	c8	0	c5	1	32-bit	WO	Invalidate instruction TLB by MVA	-
<a href="#">TLBIALL</a> <sup>c, d</sup>	c8	0	c7	0	32-bit	WO	Invalidate entire unified TLB	-
<a href="#">TLBIALLIS</a> <sup>e, d</sup>	c8	0	c3	0	32-bit	WO	Invalidate entire unified TLB	IS
<a href="#">TLBIASID</a> <sup>d</sup>	c8	0	c7	2	32-bit	WO	Invalidate unified TLB by ASID	-
<a href="#">TLBIASIDIS</a> <sup>e, d</sup>	c8	0	c3	2	32-bit	WO	Invalidate unified TLB by ASID	IS
<a href="#">TLBIMVAA</a> <sup>d</sup>	c8	0	c7	3	32-bit	WO	Invalidate unified TLB by MVA, all ASID	-
<a href="#">TLBIMVAAIS</a> <sup>e, d</sup>	c8	0	c3	3	32-bit	WO	Invalidate unified TLB by MVA, all ASID	IS
<a href="#">TLBIMVA</a> <sup>d</sup>	c8	0	c7	1	32-bit	WO	Invalidate unified TLB by MVA	-
<a href="#">TLBIMVAIS</a> <sup>e, d</sup>	c8	0	c3	1	32-bit	WO	Invalidate unified TLB by MVA	IS

- IS = Inner Shareable.
- Deprecated. ARM deprecates use of operations that operate only on an Instruction TLB, or only on a Data TLB.
- The mnemonics for the operations with CRm==c7, opc2=={0, 1, 2} were previously UTLBIALL, UTLBIMVA and UTLBIMASID.
- The links in this column are to a summary of the operation. [TLB maintenance operations, not in Hyp mode on page B4-1743](#) describes the operation.
- Introduced in the Multiprocessing Extensions. In earlier ARMv7 implementations these encodings are unallocated and UNPREDICTABLE, see [Accesses to unallocated CP14 and CP15 encodings on page B3-1447](#).

[TLB maintenance operations, not in Hyp mode on page B4-1743](#) describes these operations.

The Virtualization Extensions add other TLB operations for use in Hyp mode, see:

- [Virtualization Extensions registers, functional group on page B3-1501](#)
- [Hyp mode TLB maintenance operations, Virtualization Extensions on page B4-1746](#).

### B3.18.8 Address translation operations, functional group

Table B3-51 shows the Address translation register and operations in a VMSA implementation.

**Table B3-51 Address translation operations, VMSA only**

Name	CRn	opc1	CRm	opc2	Width	Type	Description
<a href="#">ATS12NSOPR</a> <sup>a, c</sup>	c7	0	c8	4	32-bit	WO	Stages 1 and 2 Non-secure only PL1 read
<a href="#">ATS12NSOPW</a> <sup>a, c</sup>	c7	0	c8	5	32-bit	WO	Stages 1 and 2 Non-secure only PL1 write
<a href="#">ATS12NSOUR</a> <sup>a, c</sup>	c7	0	c8	6	32-bit	WO	Stages 1 and 2 Non-secure only unprivileged read
<a href="#">ATS12NSOUW</a> <sup>a, c</sup>	c7	0	c8	7	32-bit	WO	Stages 1 and 2 Non-secure only unprivileged write
<a href="#">ATS1CPR</a> <sup>c</sup>	c7	0	c8	0	32-bit	WO	Stage 1 Current state PL1 read
<a href="#">ATS1CPW</a> <sup>c</sup>	c7	0	c8	1	32-bit	WO	Stage 1 Current state PL1 write
<a href="#">ATS1CUR</a> <sup>c</sup>	c7	0	c8	2	32-bit	WO	Stage 1 Current state unprivileged read
<a href="#">ATS1CUW</a> <sup>c</sup>	c7	0	c8	3	32-bit	WO	Stage 1 Current state unprivileged write
<a href="#">ATS1HR</a> <sup>b, c</sup>	c7	4	c8	0	32-bit	WO	Stage 1 Hyp mode read
<a href="#">ATS1HW</a> <sup>b, c</sup>	c7	4	c8	1	32-bit	WO	Stage 1 Hyp mode write
PAR	c7	0	c4	0	32-bit	RW	Physical Address Register
	-	0	c7	-	64-bit <sup>d</sup>	RW	

- a. Implemented only as part of the Security Extensions. Otherwise, encoding is unallocated and UNPREDICTABLE, see [Accesses to unallocated CP14 and CP15 encodings on page B3-1447](#).
- b. Implemented only as part of the Virtualization Extensions. Otherwise, encoding is unallocated and UNPREDICTABLE, see [Accesses to unallocated CP14 and CP15 encodings on page B3-1447](#).
- c. Except for the link to the [PAR](#), the links in this column are to a summary of the operation, and [Performing address translation operations on page B4-1747](#) describes the operation.
- d. Implemented as part of the Large Physical Address Extension. Otherwise, encoding is unallocated and UNPREDICTABLE, see [Accesses to unallocated CP14 and CP15 encodings on page B3-1447](#).

[Performing address translation operations on page B4-1747](#) describes how to access the address translation operations. [Virtual Address to Physical Address translation operations on page B3-1438](#) describes these operations.

### B3.18.9 Miscellaneous operations, functional group

Table B3-52 shows the Miscellaneous operations in a VMSA implementation.

The only UNPREDICTABLE encodings shown in the table are those that had defined functions in ARMv6.

**Table B3-52 Miscellaneous system control operations, VMSA only**

Name	CRn	opc1	CRm	opc2	Width	Type <sup>a</sup>	Description
CP15DMB	c7	0	c10	5	32-bit	WO, PL0	<i>Data and instruction barrier operations, VMSA on page B4-1749</i>
CP15DSB	c7	0	c10	4	32-bit	WO, PL0	
CP15ISB	c7	0	c5	4	32-bit	WO, PL0	
HTPIDR <sup>b</sup>	c13	4	c0	2	32-bit	RW	Hyp Software Thread ID Register
TPIDRPRW	c13	0	c0	4	32-bit	RW	PL1 only Thread ID Register
TPIDRURO	c13	0	c0	3	32-bit	RW, PL0	User Read-Only Thread ID Register
TPIDRURW	c13	0	c0	2	32-bit	RW, PL0	User Read/Write Thread ID Register
UNPREDICTABLE	c7	0	c0	4	32-bit	WO	<i>Retired operations</i>
			c13	1	32-bit	WO	

a. PL0 = Accessible from unprivileged software, that is, from software executing at PL0. See the register description for more information.

b. Implemented only as part of the Virtualization Extensions. Otherwise, encoding is unallocated and UNPREDICTABLE, see *Accesses to unallocated CP14 and CP15 encodings on page B3-1447*.

#### Retired operations

ARMv6 includes two CP15 c7 operations that are not supported in ARMv7, with encodings that become UNPREDICTABLE in ARMv7. These are the ARMv6:

- *Wait For Interrupt* (CP15WFI) operation. In ARMv7 this operation is performed by the WFI instruction, that is available in the ARM and Thumb instruction sets. For more information, see *WFI on page A8-1106*.
- Prefetch instruction by MVA operation. In ARMv7 this operation is replaced by the PLI instruction, that is available in the ARM and Thumb instruction sets. For more information, see *PLI (immediate, literal) on page A8-530* and *PLI (register) on page A8-532*.

In ARMv7, the CP15 c7 encodings that were used for these operations are UNPREDICTABLE. These encodings are:

- for the ARMv6 CP15WFI operation:
  - an MCR instruction with <opc1> set to 0, <CRn> set to c7, <CRm> set to c0, and <opc2> set to 4
- for the ARMv6 Prefetch instruction by MVA operation:
  - an MCR instruction with <opc1> set to 0, <CRn> set to c7, <CRm> set to c13, and <opc2> set to 1.

#### ————— Note —————

In some ARMv7 implementations, these encodings are write-only operations that perform a NOP.

### B3.18.10 Performance Monitors, functional group

The Performance Monitors Extension is an OPTIONAL non-invasive debug extension, described in [Chapter C12 The Performance Monitors Extension](#). When a VMSA implementation includes this extension, it must provide a CP15 register interface to the Performance Monitors. [Table B3-53](#) summarizes the performance monitor register encodings in a VMSA implementation.

**Table B3-53 Performance monitors, VMSA**

CRn	opc1	CRm	opc2	Name	Width	Type	Description
c9	0-7	c12-c14	0-7	See <a href="#">Performance Monitors registers on page C12-2326</a> <sup>a</sup>	32-bit	RW or RO <sup>b</sup>	<a href="#">Performance monitors</a>
		c15	0-7	IMPLEMENTATION DEFINED	32-bit	c	

- a. The referenced section describes the registers defined by the recommended Performance Monitors Extension.
- b. The section referenced in footnote <sup>a</sup> shows the type of each of the recommended Performance Monitors Extension registers.
- c. Access depends on the register or operation, and is IMPLEMENTATION DEFINED.

#### Performance monitors

ARMv7 reserves some encodings in the system control register space for performance monitors. These provide encodings for:

- The OPTIONAL Performance Monitors Extension registers, summarized in [Performance Monitors registers on page C12-2326](#).
- Optional additional IMPLEMENTATION DEFINED performance monitors. [Table B3-53](#) shows these reserved encodings.

### B3.18.11 Security Extensions registers, functional group

[Table B3-54](#) shows the Security Extensions registers in a VMSA implementation.

**Table B3-54 Security Extensions registers, VMSA only**

Name	CRn	opc1	CRm	opc2	Width	Type	Description
<a href="#">ISR</a>	c12	0	c1	0	32-bit	RO	Interrupt Status Register
<a href="#">MVBAR</a>	c12	0	c0	1	32-bit	RW	Monitor Vector Base Address Register
<a href="#">NSACR</a>	c1	0	c1	2	32-bit	RW	Non-Secure Access Control Register
<a href="#">SCR</a>	c1	0	c1	0	32-bit	RW	Secure Configuration Register
<a href="#">SDER</a>	c1	0	c1	1	32-bit	RW	Secure Debug Enable Register
<a href="#">VBAR</a>	c12	0	c0	0	32-bit	RW	Vector Base Address Register

All the encodings shown in [Table B3-54](#) are unallocated and UNPREDICTABLE on a processor that does not implement the Security Extensions, see [Accesses to unallocated CP14 and CP15 encodings on page B3-1447](#).



### B3.18.12 Virtualization Extensions registers, functional group

This functional group comprises the registers added by the Virtualization Extensions. [Table B3-55](#) shows the Virtualization Extensions registers in a VMSA implementation.

**Table B3-55 Virtualization Extensions registers, VMSA with Virtualization Extensions only**

Name	CRn	opc1	CRm	opc2	Width	Type	Description
-	c8	4	c3	{0, 1, 4}	32-bit	WO	<a href="#">Table B3-56 on page B3-1502</a> and <i>Hyp mode TLB maintenance operations, Virtualization Extensions on page B4-1746</i>
			c7	{0, 1, 4}	32-bit	WO	
<a href="#">HACR</a>	c1	4	c1	7	32-bit	RW	Hyp Auxiliary Configuration Register
<a href="#">HACTLR</a>	c1	4	c0	1	32-bit	RW	Hyp Auxiliary Control Register
<a href="#">HAMAIR0</a>	c10	4	c3	0	32-bit	RW	Hyp Auxiliary Memory Attribute Indirection Register 0
<a href="#">HAMAIR1</a>				1	32-bit	RW	Hyp Auxiliary Memory Attribute Indirection Register 1
<a href="#">HAXFSR</a>	c5	4	c1	0	32-bit	RW	Hyp Auxiliary Data Fault Syndrome Register
				1	32-bit	RW	Hyp Auxiliary Instruction Fault Syndrome Register
<a href="#">HCPTR</a>	c1	4	c1	2	32-bit	RW	Hyp Coprocessor Trap Register
<a href="#">HCR</a>	c1	4	c1	0	32-bit	RW	Hyp Configuration Register
<a href="#">HDCR</a>	c1	4	c1	1	32-bit	RW	Hyp Debug Configuration Register
<a href="#">HDFAR</a>	c6	4	c0	0	32-bit	RW	Hyp Data Fault Address Register
<a href="#">HIFAR</a>	c6	4	c0	2	32-bit	RW	Hyp Instruction Fault Address Register
<a href="#">HMAIR0</a>	c10	4	c2	0	32-bit	RW	Hyp Memory Attribute Indirection Register 0
<a href="#">HMAIR1</a>				1	32-bit	RW	Hyp Memory Attribute Indirection Register 1
<a href="#">HPFAR</a>	c6	4	c0	4	32-bit	RW	Hyp IPA Fault Address Register
<a href="#">HSCTLR</a>	c1	4	c0	0	32-bit	RW	Hyp System Control Register
<a href="#">HSR</a>	c5	4	c2	0	32-bit	RW	Hyp Syndrome Register
<a href="#">HSTR</a>	c1	4	c1	3	32-bit	RW	Hyp System Trap Register
<a href="#">HTCR</a>	c2	4	c0	2	32-bit	RW	Hyp Translation Control Register
<a href="#">HTTBR</a>	-	4	c2	-	64-bit	RW	Hyp Translation Table Base Register
<a href="#">HVBAR</a>	c12	4	c0	0	32-bit	RW	Hyp Vector Base Address Register
<a href="#">VMPIDR</a>	c0	4	c0	5	32-bit	RW	Virtualization Multiprocessor ID Register
<a href="#">VPIDR</a>	c0	4	c0	0	32-bit	RW	Virtualization Processor ID Register
<a href="#">VTCR</a>	c2	4	c1	2	32-bit	RW	Virtualization Translation Control Register
<a href="#">VTTBR</a>	-	6	c2	-	64-bit	RW	Virtualization Translation Table Base Register

[Table B3-56 on page B3-1502](#) lists the TLB maintenance operations added in this functional group and summarized in [Table B3-55](#).

**Table B3-56 Hyp mode TLB maintenance operations, VMSA with Virtualization Extensions only**

Name	CRn	opc1	CRm	opc2	Width	Type	Description	Limits <sup>a</sup>
<a href="#">TLBIALLH<sup>b</sup></a>	c8	4	c7	0	32-bit	WO	Invalidate entire Hyp unified TLB	-
<a href="#">TLBIALLHIS<sup>b</sup></a>	c8	4	c3	0	32-bit	WO	Invalidate entire Hyp unified TLB	IS
<a href="#">TLBIALLNSNH<sup>b</sup></a>	c8	4	c7	4	32-bit	WO	Invalidate entire Non-secure Non-Hyp unified TLB	-
<a href="#">TLBIALLNSNHIS<sup>b</sup></a>	c8	4	c3	4	32-bit	WO	Invalidate entire Non-secure Non-Hyp unified TLB	IS
<a href="#">TLBIMVAH<sup>b</sup></a>	c8	4	c7	1	32-bit	WO	Invalidate Hyp unified TLB by MVA	-
<a href="#">TLBIMVAHIS<sup>b</sup></a>	c8	4	c3	1	32-bit	WO	Invalidate Hyp unified TLB by MVA	IS

a. IS = Inner Shareable.

b. The links in this column are to a summary of the operation, and [Hyp mode TLB maintenance operations, Virtualization Extensions on page B4-1746](#) describes the operation.

All the encodings shown in [Table B3-55 on page B3-1501](#) are unallocated and UNPREDICTABLE on a processor that does not implement the Virtualization Extensions, see [Accesses to unallocated CP14 and CP15 encodings on page B3-1447](#).

In addition to the registers shown in [Table B3-55 on page B3-1501](#), the Virtualization Extensions add:

- the [HTPIDR](#), see [Miscellaneous operations, functional group on page B3-1499](#)
- the [PMOVSSET](#) register, see [Performance Monitors registers on page C12-2326](#)
- the [ATS1H\\*](#) address translation operations, see [Address translation operations, functional group on page B3-1498](#) and [Performing address translation operations on page B4-1747](#)
- the [DBGVIDSR](#), see [Sample-based profiling registers on page C11-2200](#)
- the [DBGBXVRs](#), see [Software debug event registers on page C11-2199](#)
- if the implementation includes the Generic Timer Extension:
  - the [CNTHCTL](#), [CNTHP\\_TVAL](#), [CNTHP\\_CTL](#), and [CNTHP\\_CVAL](#) registers, see [Generic Timer registers summary on page B8-1967](#)
  - the [CNTVOFF](#) register as a RW register, see [Status of the CNTVOFF register on page B8-1968](#).

### B3.18.13 Generic Timer Extension registers

ARMv7 reserves CP15 primary coprocessor register c14 for access to the Generic Timer Extension registers. For more information about these registers see [Generic Timer registers summary on page B8-1967](#).

### B3.18.14 IMPLEMENTATION DEFINED registers, functional group

ARMv7 reserves CP15 c15 for IMPLEMENTATION DEFINED purposes, and does not impose any restrictions on the use of the CP15 c15 encodings. The documentation of the ARMv7 implementation must describe fully any registers implemented in CP15 c15. Normally, for processor implementations by ARM, this information is included in the *Technical Reference Manual* for the processor.

Typically, an implementation uses CP15 c15 to provide test features, and any required configuration options that are not covered by this manual.

## B3.19 Pseudocode details of VMSA memory system operations

This section contains pseudocode describing VMSA memory operations. The following subsections describe the pseudocode functions:

- [Alignment fault](#)
- [FCSE translation](#)
- [Address translation on page B3-1504](#)
- [Domain checking on page B3-1505](#)
- [TLB operations on page B3-1506](#)
- [Translation table walk on page B3-1506](#)
- [Writing to the HSR on page B3-1519](#)
- [Calling the hypervisor on page B3-1519](#)
- [Memory access decode when TEX remap is enabled on page B3-1520](#)

See also the pseudocode for general memory system operations in [Pseudocode details of general memory system operations on page B2-1292](#).

### B3.19.1 Alignment fault

The following pseudocode describes the generation of an Alignment fault Data Abort exception:

```
// AlignmentFaultV()
// =====

AlignmentFaultV(bits(32) address, boolean iswrite, boolean taketohyp)

    // parameters for calling DataAbort
    bits(40) ipaddress = bits(40) UNKNOWN;
    bits(4) domain = bits(4) UNKNOWN;
    integer level = integer UNKNOWN;
    boolean secondstageabort = FALSE;
    boolean ipavalid = FALSE;
    boolean LDFSRformat = taketohyp || TTBCR.EAE == '1';
    boolean s2fs1walk = FALSE;

    mva = FCSETranslate(address);
    DataAbort(mva, ipaddress, domain, level, iswrite, DAbort_Alignment, CurrentModeIsHyp(),
              secondstageabort, ipavalid, LDFSRformat, s2fs1walk);
```

### B3.19.2 FCSE translation

The following pseudocode describes the FCSE translation:

```
// FCSETranslate()
// =====

bits(32) FCSETranslate(bits(32) va)
    if va<31:25> == '0000000' then
        mva = FCSEIDR.PID : va<24:0>;
    else
        mva = va;
    return mva;
```

### B3.19.3 Address translation

The TranslateAddressV() pseudocode function describes address translation in a VMSA implementation. This function calls either:

- the function described in [Address translation when the stage 1 MMU is disabled on page B3-1505](#)
- one of the functions described in [Translation table walk on page B3-1506](#).

```
// TranslateAddressV()
// =====

AddressDescriptor TranslateAddressV(bits(32) va, boolean ispriv, boolean iswrite, integer size)

    bits(32) mva;
    bits(40) ia_in;
    AddressDescriptor result;

    mva<31:0> = FCSETranslate(va);

    // FirstStageTranslation
    ishyp = CurrentModeIsHyp();

    if (ishyp && HSCTLR.M == '1') || (!ishyp && SCTLR.M == '1') then
        // Stage 1 MMU enabled

        usesLD = ishyp || TTBCR.EAE == '1';

        if usesLD then
            ia_in = '00000000':mva;
            tlbrecordS1 = TranslationTableWalkLD(ia_in, mva, iswrite, TRUE, FALSE, size);
            CheckPermission(tlbrecordS1.perms, mva, tlbrecordS1.level, tlbrecordS1.domain, iswrite,
                ispriv, ishyp, usesLD);
        else
            tlbrecordS1 = TranslationTableWalkSD(mva, iswrite, size);

            if CheckDomain(tlbrecordS1.domain, mva,
                tlbrecordS1.level, iswrite) then
                CheckPermission(tlbrecordS1.perms, mva, tlbrecordS1.level, tlbrecordS1.domain,
                    iswrite, ispriv, ishyp, usesLD);
        else
            tlbrecordS1 = TranslateAddressVS10ff(mva);

    if HaveVirtExt() && !IsSecure() && !ishyp then
        if HCR.VM == '1' then // second stage enabled
            s1outputaddr = tlbrecordS1.addrdesc.address.physicaladdress;
            tlbrecordS2 = TranslationTableWalkLD(s1outputaddr, mva, iswrite,
                FALSE, FALSE);

            s2fs1walk = FALSE;
            CheckPermissionS2(tlbrecordS2.perms, mva, s1outputaddr,
                tlbrecordS2.level, iswrite, s2fs1walk);
            result = CombineS1S2Desc(tlbrecordS1.addrdesc, tlbrecordS2.addrdesc);
        else
            result = tlbrecordS1.addrdesc;
    else
        result = tlbrecordS1.addrdesc;

    return result;
```

[Stage 2 translation table walk on page B3-1516](#) describes the CheckPermissionS2() and CombineS1S2Desc() pseudocode functions.

## Address translation when the stage 1 MMU is disabled

The TranslateAddressVS10ff() pseudocode function describes the address translation performed when the stage 1 MMU is disabled.

```
// TranslateAddressVS10ff()
// =====

// Only called for data accesses. Does not define instruction fetch behavior.

TLBRecord TranslateAddressVS10ff(bits(32) va)

    TLBRecord result;

    if HCR.DC == '0' || IsSecure() || CurrentModeIsHyp() then
        result.addrdesc.memattrs.type = MemType_StronglyOrdered;
        result.addrdesc.memattrs.innerattrs = bits(2) UNKNOWN;
        result.addrdesc.memattrs.innerhints = bits(2) UNKNOWN;
        result.addrdesc.memattrs.outerattrs = bits(2) UNKNOWN;
        result.addrdesc.memattrs.outerhints = bits(2) UNKNOWN;
        result.addrdesc.memattrs.shareable = TRUE;
        result.addrdesc.memattrs.outershareable = TRUE;
    else
        result.addrdesc.memattrs.type = MemType_Normal;
        result.addrdesc.memattrs.innerattrs = '11';
        result.addrdesc.memattrs.innerhints = '11';
        result.addrdesc.memattrs.outerattrs = '11';
        result.addrdesc.memattrs.outerhints = '11';
        result.addrdesc.memattrs.shareable = FALSE;
        result.addrdesc.memattrs.outershareable = FALSE;
        if HCR.VM != '1' then
            UNPREDICTABLE;

    result.perms.ap = bits(3) UNKNOWN;
    result.perms.xn = '0';
    result.perms.pxn = '0';
    result.nG = bit UNKNOWN;
    result.contiguoshint = boolean UNKNOWN;
    result.domain = bits(4) UNKNOWN;
    result.level = integer UNKNOWN;
    result.blocksize = integer UNKNOWN;
    result.addrdesc.paddress.physicaladdress = '00000000':va;
    result.addrdesc.paddress.NS = if IsSecure() then '0' else '1';

    return result;
```

### B3.19.4 Domain checking

The following pseudocode describes domain checking:

```
// CheckDomain()
// =====

boolean CheckDomain(bits(4) domain, bits(32) mva, integer level, boolean iswrite)

    // variables used for dataabort function
    bits (40) ipaddress = bits(40) UNKNOWN;
    boolean taketohypmode = FALSE;
    boolean secondstageabort = FALSE;
    boolean ipavalid = FALSE;
    boolean LDFSRformat = FALSE;
    boolean s2fs1walk = FALSE;

    bitpos = 2*UInt(domain);
    case DACR<bitpos+1:bitpos> of
        when '00' DataAbort(mva, ipaddress, domain, level, iswrite, DAbort_Domain, taketohypmode,
            secondstageabort, ipavalid, LDFSRformat, s2fs1walk);
```

```
    when '01' permissioncheck = TRUE;
    when '10' UNPREDICTABLE;
    when '11' permissioncheck = FALSE;

    return permissioncheck;
```

### B3.19.5 TLB operations

The TLBRecord type represents the contents of a TLB entry:

```
// Types of TLB entry

enumeration TLBRecType { TLBRecType_SmallPage,
                        TLBRecType_LargePage,
                        TLBRecType_Section,
                        TLBRecType_Supersection,
                        TLBRecType_MMUDisabled};

type TLBRecord is (
    Permissions      perms,
    bit              nG,           // '0' = Global, '1' = not Global
    bits(4)          domain,
    boolean          contiguoushint,
    integer          level,       // generalises Section/Page to Table level
    integer          blocksize,   // describes size of memory translated in KBytes
    AddressDescriptor addrdesc
)
```

### B3.19.6 Translation table walk

Because of the complexity of a translation table walk, the following sections describe the different cases:

- [Translation table walk using the Short-descriptor translation table format for stage 1](#)
- [Translation table walk using the Long-descriptor translation table format for stage 1 on page B3-1510](#)
- [Stage 2 translation table walk on page B3-1516.](#)

#### Translation table walk using the Short-descriptor translation table format for stage 1

The TranslationTableWalkSD() pseudocode function describes the translation table walk when the stage 1 translation tables use the Short-descriptor format. It calls the function described in [Stage 2 translation table walk on page B3-1516](#) if necessary:

```
// TranslationTableWalkSD()
// =====
//
// Returns a result of a translation table walk using
// the Short-descriptor format for TLBRecord
//
// Implementations might cache information from memory in any
// number of non-coherent TLB caching structures, and so avoid
// memory accesses that have been expressed in this pseudocode
// The use of such TLBs is not expressed in this pseudocode.

TLBRecord TranslationTableWalkSD(bits(32) mva, boolean is_write, integer size)

    // this is only called when the MMU is enabled
    TLBRecord      result;
    AddressDescriptor l1descaddr;
    AddressDescriptor l2descaddr;

    // variables for DAbort function
    taketohypmode = FALSE;
    IA = bits(40) UNKNOWN;
    ipavalid = FALSE;
    stage2 = FALSE;
    LDFSRformat = FALSE;
```

```

s2fs1walk = FALSE;

// default setting of the domain
domain = bits(4) UNKNOWN;

// Determine correct Translation Table Base Register to use.
n = UInt(TTBCR.N);
if n == 0 || IsZero(mva<31:(32-n)>) then
    ttbr = TTBR0;
    disabled = (TTBCR.PD0 == '1');
else
    ttbr = TTBR1;
    disabled = (TTBCR.PD1 == '1');
    n = 0; // TTBR1 translation always works like N=0 TTBR0 translation

// Check this Translation Table Base Register is not disabled.
if HaveSecurityExt() && disabled == '1' then
    level = 1;
    DataAbort(mva, IA, domain, level, is_write, DAbort_Translation,
        taketohypmode, stage2, ipavalid, LDFSRformat, s2fs1walk);

// Obtain First level descriptor.
l1descaddr.paddress.physicaladdress = '00000000' : ttbr<31:(14-n)> : mva<(31-n):20> : '00';
l1descaddr.paddress.NS = if IsSecure() then '0' else '1';
l1descaddr.memattrs.type = MemType_Normal;
l1descaddr.memattrs.shareable = (ttbr<1> == '1');
l1descaddr.memattrs.outershareable = (ttbr<5> == '0' && ttbr<1> == '1');
hintsattrs = ConvertAttrsHints(ttbr<4:3>);
l1descaddr.memattrs.outerattrs = hintsattrs<1:0>;
l1descaddr.memattrs.outerhints = hintsattrs<3:2>;

if HaveMPEExt() then
    hintsattrs = ConvertAttrsHints(ttbr<0>:ttbr<6>);
    l1descaddr.memattrs.innerattrs = hintsattrs<1:0>;
    l1descaddr.memattrs.innerhints = hintsattrs<3:2>;
else
    if ttbr<0> == '0' then
        hintsattrs = ConvertAttrsHints('00');
        l1descaddr.memattrs.innerattrs = hintsattrs<1:0>;
        l1descaddr.memattrs.innerhints = hintsattrs<3:2>;
    else
        l1descaddr.memattrs.innerattrs = IMPLEMENTATION_DEFINED 10 or 11;
        l1descaddr.memattrs.innerhints = IMPLEMENTATION_DEFINED 01 or 11;

if !HaveVirtExt() || IsSecure() then
// if only 1 stage of translation
    l1descaddr2 = l1descaddr;
else
    l1descaddr2 = SecondStageTranslate(l1descaddr, mva);

l1desc = _Mem[l1descaddr2, 4];
if SCTL.R.EE == '1' then
    l1desc = BigEndianReverse(l1desc, 4);

// Process First level descriptor.
case l1desc<1:0> of
    when '00' // Fault, Reserved
        level = 1;
        DataAbort(mva, IA, domain, level, is_write, DAbort_Translation,
            taketohypmode, stage2, ipavalid, LDFSRformat, s2fs1walk);

    when '01' // Large page or Small page
        domain = l1desc<8:5>;
        level = 2;
        pxn = l1desc<2>;
        NS = l1desc<3>;

```

```

// Obtain Second level descriptor.
l2descaddr.paddress.physicaladdress = l1desc<31:10>:mva<19:12>:'00';
l2descaddr.paddress.physicaladdressext = '00000000';
l2descaddr.paddress.NS = if IsSecure() then '0' else '1';
l2descaddr.memattr = l1descaddr.memattr;
if !HaveVirtExt() || IsSecure() then
  // if only 1 stage of translation
  l2descaddr2 = l2descaddr;
else
  l2descaddr2 = SecondStageTranslate(l2descaddr, mva);
l2desc = _Mem[l2descaddr2, 4];
if SCTL.R.EE == '1' then
  l2desc = BigEndianReverse(l2desc,4);

// Process Second level descriptor.
if l2desc<1:0> == '00' then
  DataAbort(mva, IA, domain, level, is_write, DAbort_Translation,
    taketohypmode, stage2, ipavalid, LDFSRformat, s2fs1walk);

S = l2desc<10>;
ap = l2desc<9,5:4>;
nG = l2desc<11>;

if SCTL.R.AFE == '1' && l2desc<4> == '0' then
  if SCTL.R.HA == '0' then
    DataAbort(va, IA, domain, level, is_write, DAbort_AccessFlag,
      taketohypmode, stage2, ipavalid, LDFSRformat,
      s2fs1walk);
  else // Hardware-managed Access flag must be set in memory
    if SCTL.R.EE == '1' then
      _Mem[l2descaddr2,4]<28> = '1';
    else
      _Mem[l2descaddr2,4]<4> = '1';

if l2desc<1> == '0' then // Large page
  texcb = l2desc<14:12,3,2>;
  xn = l2desc<15>;
  blocksize = 64;
  physicaladdressext = '00000000';
  physicaladdress = l2desc<31:16>:mva<15:0>;
else // Small page
  texcb = l2desc<8:6,3,2>;
  xn = l2desc<0>;
  blocksize = 4;
  physicaladdressext = '00000000';
  physicaladdress = l2desc<31:12>:mva<11:0>;

when "1x" // Section or Supersection
  texcb = l1desc<14:12,3,2>;
  S = l1desc<16>;
  ap = l1desc<15,11:10>;
  xn = l1desc<4>;
  pxn = l1desc<0>;
  nG = l1desc<17>;
  level = 1;
  NS = l1desc<19>;

if SCTL.R.AFE == '1' && l1desc<10> == '0' then
  if SCTL.R.HA == '0' then
    DataAbort(mva, IA, domain, level, is_write,
      DAbort_AccessFlag, taketohypmode, stage2,
      ipavalid, LDFSRformat, s2fs1walk);
  else // Hardware-managed Access flag must be set in memory
    if SCTL.R.EE == '1' then
      _Mem[l1descaddr2,4]<18> = '1';
    else
      _Mem[l1descaddr2,4]<10> = '1';

```



```

    if l1desc<18> == '0' then // Section
        domain = l1desc<8:5>;
        blocksize = 1024;
        physicaladdresext = '00000000';
        physicaladdress = l1desc<31:20>;mva<19:0>;
    else // Supersection
        domain = '0000';
        blocksize = 16384;
        physicaladdresext = l1desc<8:5,23:20>;
        physicaladdress = l1desc<31:24>;mva<23:0>;

// Decode the TEX, C, B and S bits to produce the TLBRecord's memory attributes
if SCTL.R.TRE == '0' then
    if RemapRegsHaveResetValues() then
        result.addrdesc.memattrs = DefaultTEXDecode(texcb, S);
    else
        IMPLEMENTATION_DEFINED setting of result.addrdesc.memattrs;
else
    if SCTL.R.M == '0' then
        result.addrdesc.memattrs = DefaultTEXDecode(texcb, S);
    else
        result.addrdesc.memattrs = RemappedTEXDecode(texcb, S);

// transient bits are not supported in this format
result.addrdesc.memattrs.innertransient = FALSE;
result.addrdesc.memattrs.outertransient = FALSE;

// Set the rest of the TLBRecord, try to add it to the TLB, and return it.
result.perms.ap = ap;
result.perms.xn = xn;
result.perms.pxn = pxn;
result.nG = nG;
result.domain = domain;
result.level = level;
result.blocksize = blocksize;
result.addrdesc.paddress.physicaladdress = physicaladdresext:physicaladdress;
result.addrdesc.paddress.NS = if IsSecure() then NS else '1';

// check for alignment issues if memory type is S0 or Device
if (result.addrdesc.memattrs == MemType_Device ||
    result.addrdesc.memattrs == MemType_StronglyOrdered) then
    if mva != Align(mva, size) then
        AlignmentFaultV(mva, FALSE, FALSE);

return result;

```

The ConvertAttrHints() pseudocode function converts the Normal memory cacheability attribute, from the translation table base register or the translation table TEX field, into the separate cacheability attribute and cache allocation hint defined in a Long-descriptor translation table descriptor:

```

// ConvertAttrHints
// =====

bits(4) ConvertAttrHints(bits(2) RGN)
// Converts the Short-descriptor attribute fields for Normal memory as used
// in the TTBR and TEX fields to the orthogonal concepts of Attributes and Hints
bits(2) attributes;
bits(2) hints;

if RGN == '00' then // Non-cacheable
    attributes = '00';
    hints = '00';
elseif RGN<0> == '1' then // Write-Back
    attributes = '11';
    hints = '1',NOT(RGN<1>);
else
    attributes = '10'; // Write-Through
    hints = '10';

```

```
return hints.attributes;
```

### Translation table walk using the Long-descriptor translation table format for stage 1

The TranslationTableWalkLD() pseudocode function describes the translation table walk when the stage 1 translation tables use the Long-descriptor format. It calls the function described in [Stage 2 translation table walk on page B3-1516](#) if necessary:

```
// TranslationTableWalkLD()
// =====
//
// Returns a result of a translation table walk using
// the longdescriptor in TLBRecord form
//
// Implementations might cache information from memory in any
// number of non-coherent TLB caching structures, and so avoid
// memory accesses that have been expressed in this pseudocode
// The use of such TLBs is not expressed in this pseudocode.

TLBRecord TranslationTableWalkLD(bits(40) IA, bits(32) va,
                                boolean is_write, boolean stage1,
                                boolean s2fs1walk, integer size)

    TLBRecord      result;
    AddressDescriptor walkaddr;

    domain = bits(4) UNKNOWN;
    LDFSRformat = TRUE;
    BaseAddress<39:0> = Zeros(40);
    BaseFound = FALSE;
    Disabled = FALSE;

    if stage1 then
        if CurrentModeIsHyp() then
            // executing in Hyp mode
            LookupSecure = FALSE;
            T0Size = UInt(HTCR.T0SZ);
            if T0Size == 0 || IsZero(IA<31:(32-T0Size)>) then
                CurrentLevel = (if HTCR.T0SZ<2:1> == '00' then 1 else 2);
                BALowerBound = 9*CurrentLevel - T0Size - 4;
                BaseAddress<39:0> = HTTBR<39:BALowerBound>.Zeros(BALowerBound);
                if !IsZero(HTTBR<BALowerBound-1:3>) then UNPREDICTABLE;
                BaseFound = TRUE;
                StartBit = 31-T0Size;

                // unpack type information from HTCR
                walkaddr.memattrs.type = MemType_Normal;
                hintsattrs = ConvertAttrsHints(HTCR.IRGNO);
                walkaddr.memattrs.innerhints = hintsattrs<3:2>;
                walkaddr.memattrs.innerattrs = hintsattrs<1:0>;
                hintsattrs = ConvertAttrsHints(HTCR.ORGNO);
                walkaddr.memattrs.outerhints = hintsattrs<3:2>;
                walkaddr.memattrs.outerattrs = hintsattrs<1:0>;
                walkaddr.memattrs.shareable = (HTCR.SH0<1> == '1');
                walkaddr.memattrs.outershareable = (HTCR.SH0 == '10');
                walkaddr.memattrs.shareable = (HTCR.SH0<1> == '1');
                walkaddr.memattrs.outershareable = (HTCR.SH0 == '10');
                walkaddr.paddress.NS = '1';
            else
                // not executing in Hyp mode
                LookupSecure = IsSecure();
                T0Size = UInt(TTBCR.T0SZ);
                if T0Size == 0 || IsZero(IA<31:(32-T0Size)>) then
                    CurrentLevel = (if TTBCR.T0SZ<2:1> == '00' then 1 else 2);
                    BALowerBound = 9*CurrentLevel - T0Size - 4;
```

```

    BaseAddress<39:0> = TTBR0<39:BALowerBound>:Zeros(BALowerBound);
    if !IsZero(TTBR0<BALowerBound-1:3>) then UNPREDICTABLE;
    BaseFound = TRUE;
    Disabled = (TTBCR.EPD0 == '1');
    StartBit = 31-T0Size;

    // unpack type information from TTBCR
    walkaddr.memattrs.type = MemType_Normal;
    hintsattrs = ConvertAttrsHints(TTBCR.IRGN0);
    walkaddr.memattrs.innerhints = hintsattrs<3:2>;
    walkaddr.memattrs.innerattrs = hintsattrs<1:0>;
    hintsattrs = ConvertAttrsHints(TTBCR.ORGNO);
    walkaddr.memattrs.outerhints = hintsattrs<3:2>;
    walkaddr.memattrs.outerattrs = hintsattrs<1:0>;
    walkaddr.memattrs.shareable = (TTBCR.SH0<1> == '1');
    walkaddr.memattrs.outershareable = (TTBCR.SH0 == '10');

    T1Size = UInt(TTBCR.T1SZ);
    if (T1Size == 0 && !BaseFound) || IsOnes(IA<31:(32-T1Size)>) then
      CurrentLevel = (if TTBCR.T1SZ<2:1> == '00' then 1 else 2);
      BALowerBound = 9*CurrentLevel - T1Size - 4;
      BaseAddress<39:0> = TTBR1<39:BALowerBound>:Zeros(BALowerBound);
      if !IsZero(TTBR1<BALowerBound-1:3>) then UNPREDICTABLE;
      BaseFound = TRUE;
      Disabled = (TTBCR.EPD1 == '1');
      StartBit = 31-T1Size;

      // unpack type information from TTBCR
      walkaddr.memattrs.type = MemType_Normal;
      hintsattrs = ConvertAttrsHints(TTBCR.IRGN1);
      walkaddr.memattrs.innerhints = hintsattrs<3:2>;
      walkaddr.memattrs.innerattrs = hintsattrs<1:0>;
      hintsattrs = ConvertAttrsHints(TTBCR.ORG1);
      walkaddr.memattrs.outerhints = hintsattrs<3:2>;
      walkaddr.memattrs.outerattrs = hintsattrs<1:0>;
      walkaddr.memattrs.shareable = (TTBCR.SH1<1> == '1');
      walkaddr.memattrs.outershareable = (TTBCR.SH1 == '10');

else
  // not a stage 1 translation
  T0Size = SInt(VTCR.T0SZ);
  SLevel = UInt(VTCR.SL0);
  BALowerBound = 14 - T0Size - 9*SLevel;
  // check UNPREDICTABLE combinations of the Starting level and Size fields
  // and check the VTTBR is aligned correctly
  if SLevel == 0 && T0Size < -2 then UNPREDICTABLE;
  if SLevel == 1 && T0Size > 1 then UNPREDICTABLE;
  if VTCR.SL0<1> == '1' then UNPREDICTABLE;
  if IsZero(VTTBR<BALowerBound-1:3>) == FALSE then UNPREDICTABLE;

  if T0Size == -8 || IsZero(IA<39:(32-T0Size)>) then
    CurrentLevel = 2-SLevel;
    BaseAddress<39:0> = VTTBR<39:BALowerBound>:Zeros(BALowerBound);
    BaseFound = TRUE;
    StartBit = 31-T0Size;
    LookupSecure = FALSE;

    // unpack type information from VTCR
    walkaddr.memattrs.type = MemType_Normal;
    hintsattrs = ConvertAttrsHints(VTCR.IRGN0);
    walkaddr.memattrs.innerhints = hintsattrs<3:2>;
    walkaddr.memattrs.innerattrs = hintsattrs<1:0>;
    hintsattrs = ConvertAttrsHints(VTCR.ORGNO);
    walkaddr.memattrs.outerhints = hintsattrs<3:2>;
    walkaddr.memattrs.outerattrs = hintsattrs<1:0>;
    walkaddr.memattrs.shareable = (VTCR.SH0<1> == '1');
    walkaddr.memattrs.outershareable = (VTCR.SH0 == '10');

```

```

if !BaseFound || Disabled then
  taketohypmode = CurrentModeIsHyp() || !stage1;
  level = 1;
  ipavalid = !stage1;
  DataAbort(va, IA, domain, level, is_write, DAbort_Translation,
    taketohypmode, !stage1, ipavalid, LDFSRformat, s2fs1walk);

FirstIteration = TRUE;
TableRW = TRUE;
TableUser = TRUE;
TableXN = FALSE;
TablePXN = FALSE;

repeat
  LookUpFinished = TRUE;
  BlockTranslate = FALSE;
  Offset = 9*CurrentLevel;
  if FirstIteration then
    IASelect = ZeroExtend(IA<StartBit:39-Offset>:'000', 40);
  else
    IASelect = ZeroExtend(IA<47-Offset:39-Offset>:'000', 40);
  LookupAddress = BaseAddress OR IASelect;

  FirstIteration = FALSE;

  // If there are two stages of translation, then the stage 1
  // table walk addresses are themselves subject to translation
  walkaddr.address.physicaladdress = LookupAddress<39:0>;
  if LookupSecure then
    walkaddr.paddress.NS = '0';
  else
    walkaddr.paddress.NS = '1';
  if !HaveVirtExt() || !stage1 || IsSecure() || CurrentModeIsHyp() then
    // if only 1 stage of translation
    if HaveVirtExt() && (CurrentModeIsHyp() || !stage1) then
      BigEndian = (HCTLR.EE == '1');
    else
      BigEndian = SCTL.R.EE == '1';
    Descriptor = _Mem[walkaddr,8];
    if BigEndian then
      Descriptor = BigEndianReverse(Descriptor,8);
  else
    walkaddr2 = SecondStageTranslate(walkaddr, ia<31:0>);
    Descriptor = _Mem[walkaddr2, 8];
    if SCTL.R.EE == '1' then
      Descriptor = BigEndianReverse(Descriptor,8);

  if Descriptor<0> == '0' then
    taketohypmode = CurrentModeIsHyp() || !stage1;
    ipavalid = TRUE;
    DataAbort(va, IA, domain, CurrentLevel, is_write,
      DAbort_Translation, taketohypmode, !stage1,
      ipavalid, LDFSRformat, s2fs1walk);
  else
    if Descriptor<1> == '0' then
      if CurrentLevel == 3 then
        taketohypmode = CurrentModeIsHyp() || !stage1;
        ipavalid = TRUE;

        DataAbort(va, IA, domain, CurrentLevel, is_write,
          DAbort_Translation, taketohypmode, !stage1,
          ipavalid, LDFSRformat, s2fs1walk);
      else
        BlockTranslate = TRUE;
    else
      if CurrentLevel == 3 then
        BlockTranslate = TRUE;
      else // table translation

```

```

        BaseAddress = Descriptor<39:12>:'000000000000';
        LookupSecure = LookupSecure && (Descriptor<63> == '0');
        TableRW = TableRW && (Descriptor<62> == '0');
        TableUser = TableUser && (Descriptor<61> == '0');
        TablePXN = TablePXN || (Descriptor<59> == '1');
        TableXN = TableXN || (Descriptor<60> == '1');
        LookUpFinished = FALSE;

    if BlockTranslate then
        OutputAddress = Descriptor<39:39-Offset> : IA<38-Offset:0>;
        Attrs = Descriptor<54:52>: Descriptor<11:2>;

        if stage1 then
            if TableXN then Attrs<12> = '1';
            if TablePXN then Attrs<11> = '1';
            if IsSecure() && !(LookupSecure) then Attrs<9> = '1';
            if !(TableRW) then Attrs<5> = '1';
            if !(TableUser) then Attrs<4> = '0';
            if !(LookupSecure) then Attrs<3> = '1';
        else
            CurrentLevel = CurrentLevel + 1;
    until LookUpFinished

    // final Attrs<> bus contains:
    // 12:  XN
    // 11:  PXN
    // 10:  Contiguous Hint
    // 9:   nG
    // 8:   AccessFlag
    // 7:6: Shareability
    // 5:   Stage 1: ReadOnly 0: Read/Write
    // 4:   Stage 1: User 0: Privileged only
    // 5:   Stage 2: Write permission
    // 4:   Stage 2: Read permission
    // 3:0: Stage 2: Memory Type
    // 3:   Stage 1: Non-secure
    // 2:0: Stage 1: Memory Type Index

    // check the access flag
    if Attr<8> == '0' then
        taketohypmode = CurrentModeIsHyp() || !stage1;
        ipavalid = TRUE;
        DataAbort(va, IA, domain, CurrentLevel, is_write,
            DAbort_AccessFlag, taketohypmode, !stage1,
            ipavalid, LDFSRformat, s2fs1walk);

    result.perms.xn = Attrs<12>;
    result.perms.pxn = Attrs<11>;
    result.contiguoushint = Attrs<10>;
    result.nG = Attrs<9>;

    result.perms.ap<2:1> = Attrs<5:4>;

    result.perms.ap<0> = '1';
    if stage1 then
        result.addrdesc.memattrs = MAIRDecode(Attr<2:0>);
    else
        result.addrdesc.memattrs = S2AttrDecode(Attr<3:0>);

    // check for alignment issues if memory type is S0 or Device
    if result.addrdesc.memattrs == MemType_Device ||
        result.addrdesc.memattrs == MemType_StronglyOrdered then
        if va != Align(va, size) then
            TakeFaultInHypMode = !stage1 || CurrentModeIsHyp();
            AlignmentFaultV(va, FALSE, TakeFaultInHypMode);

    if result.addrdesc.memattrs == MemType_Normal then
        result.addrdesc.shareable = (Attr<7> == '1');
    
```

```

    result.addrdesc.outershareable = (Attr<7:6> == '10');
else
    result.addrdesc.shareable = TRUE;
    result.addrdesc.outshareable = TRUE;

result.domain = bits(4) UNKNOWN; // domains not used
result.level = CurrentLevel;
result.blocksize = 512^(3-CurrentLevel)*4;
result.addrdesc.paddress.physicaladdress = OutputAddress<39:0>;

if stage1 then
    result.addrdesc.paddress.NS = Attrs<3>;
else
    result.addrdesc.paddress.NS = '1';

// not all bits are legal in Hyp mode
if stage1 && CurrentModeIsHyp() then
    if Attrs<4> != '1' then UNPREDICTABLE;
    if !TableUser then UNPREDICTABLE;
    if Attrs<11> != '0' then UNPREDICTABLE;
    if !TablePXN then UNPREDICTABLE;
    if Attrs<9> != '0' then UNPREDICTABLE;

return result;

```

This function calls the ConvertAttrsHints() pseudocode function that is defined in [Translation table walk using the Short-descriptor translation table format for stage 1 on page B3-1506](#).

The MAIRDecode() pseudocode function uses the MAIR<sub>n</sub> registers to decode the Attr[2:0] value from a stage 1 translation table descriptor:

```

// MAIRDecode()
// =====

MemoryAttributes MAIRDecode(bits(3) attr)
// Converts the MAIR attributes to orthogonal attribute and
// hint fields.

MemoryAttributes memattrs;

if CurrentModeIsHyp() then
    mair = HMAIR1:HMAIR0;
else
    mair = MAIR1:MAIR0;

index = UInt(attr);
attrfield = mair<8*index+7:8*index>;

if attrfield<7:4> == '0000' then
    unpackinner = FALSE;
    memattrs.innerattrs = bits(2) UNKNOWN;
    memattrs.outerattrs = bits(2) UNKNOWN;
    memattrs.innerhints = bits(2) UNKNOWN;
    memattrs.outerhints = bits(2) UNKNOWN;
    memattrs.innertransient = boolean UNKNOWN;
    memattrs.outertransient = boolean UNKNOWN;
    if attrfield<3:0> == '0000' then
        memattrs.type = MemType_StronglyOrdered;
    elseif attrfield<3:0> == '0001' then
        memattrs.type = MemType_Device;
    else
        memattrs.type = IMPLEMENTATION_DEFINED;
        memattrs.innerattrs = IMPLEMENTATION_DEFINED;
        memattrs.outerattrs = IMPLEMENTATION_DEFINED;
        memattrs.innerhints = IMPLEMENTATION_DEFINED;
        memattrs.outerhints = IMPLEMENTATION_DEFINED;
        memattrs.innertransient = IMPLEMENTATION_DEFINED;
        memattrs.outertransient = IMPLEMENTATION_DEFINED;

```

```

elseif attrfield<7:6> == '00' then
    unpackinner = TRUE;
    if ImplementationSupportsTransient() then
        memattrs.type = MemType_Normal;
        memattrs.outerhints = attrfield<5:4>;
        memattrs.outerattrs = '10'; //Write-through
        memattrs.outertransient = TRUE;
    else
        memattrs.type = IMPLEMENTATION_DEFINED;
        memattrs.outerattrs = IMPLEMENTATION_DEFINED;
        memattrs.outerhints = IMPLEMENTATION_DEFINED;
        memattrs.outertransient = IMPLEMENTATION_DEFINED;
elseif attrfield<7:6> == '01' then
    unpackinner = TRUE;
    if attrfield<5:4> == '00' then // Non-cacheable
        memattrs.type = MemType_Normal;
        memattrs.outerattrs = '00';
        memattrs.outerhints = '00';
        memattrs.outertransient = FALSE;
    else
        if ImplementationSupportsTransient() then
            memattrs.type = MemType_Normal;
            memattrs.outerhints = attrfield<5:4>;
            memattrs.outerattrs = '11'; //Write-back
            memattrs.outertransient = TRUE;
        else
            memattrs.type = IMPLEMENTATION_DEFINED;
            memattrs.outerattrs = IMPLEMENTATION_DEFINED;
            memattrs.outerhints = IMPLEMENTATION_DEFINED;
            memattrs.outertransient = IMPLEMENTATION_DEFINED;
else
    unpackinner = TRUE;
    memattrs.type = MemType_Normal;
    memattrs.outerhints = attrfield<5:4>;
    memattrs.outerattrs = attrfield<7:6>;
    memattrs.outertransient = FALSE;

if unpackinner then
    if attrfield<3> == '1' then
        memattrs.innerhints = attrfield<1:0>;
        memattrs.innerattrs = attrfield<3:2>;
        memattrs.innertransient = FALSE;
    elseif attrfield<2:0> == '100' then // Non-cacheable
        memattrs.innerhints = '00';
        memattrs.innerattrs = '00';
        memattrs.innertransient = TRUE;
    else
        if ImplementationSupportsTransient() then
            if attrfield<2> == '0;' then
                memattrs.innerhints = attrfield<1:0>;
                memattrs.innerattrs = '10'; //Write-through
                memattrs.innertransient = TRUE;
            else
                memattrs.innerhints = attrfield<1:0>;
                memattrs.innerattrs = '11'; //Write-back
                memattrs.innertransient = TRUE;
        else
            memattrs.type = IMPLEMENTATION_DEFINED;
            memattrs.innerattrs = IMPLEMENTATION_DEFINED;
            memattrs.innerhints = IMPLEMENTATION_DEFINED;
            memattrs.innertransient = IMPLEMENTATION_DEFINED;
            memattrs.outerattrs = IMPLEMENTATION_DEFINED;
            memattrs.outerhints = IMPLEMENTATION_DEFINED;
            memattrs.outertransient = IMPLEMENTATION_DEFINED;
return memattrs;
    
```

The S2AttrDecode() pseudocode function decodes the Attr[3:0] value from a stage 2 translation table descriptor:

```

// S2AttrDecode()
// =====
// Converts the Stage 2 attribute fields into
// orthogonal attributes and hints

MemoryAttributes S2AttrDecode(bits(4) attr)

MemoryAttributes memattrs;

if attr<3:2> == '00' then
  memattrs.innerattrs = bits(2) UNKNOWN;
  memattrs.outerattrs = bits(2) UNKNOWN;
  memattrs.innerhints = bits(2) UNKNOWN;
  memattrs.outerhints = bits(2) UNKNOWN;
  if attr<1:0> == '00' then
    memattrs.type = MemType_StronglyOrdered;
  elseif attr<1:0> == '01' then
    memattrs.type = MemType_Device;
  else
    memattrs.type = MemType_UNKNOWN;
else
  memattrs.type = MemType_Normal;
  if attr<3> == '0' then // Non-cacheable
    memattrs.outerattrs = '00';
    memattrs.outerhints = '00';
  else // cacheable
    memattrs.outerattrs = attr<3:2>;
    memattrs.outerhints = '11';

  if attr<1:0> == '00' then // Reserved
    memattrs.type = MemType_UNKNOWN;
    memattrs.innerattrs = bits(2) UNKNOWN;
    memattrs.outerattrs = bits(2) UNKNOWN;
    memattrs.innerhints = bits(2) UNKNOWN;
    memattrs.outerhints = bits(2) UNKNOWN;
  elseif attr<1> == '0' then // Non-cacheable
    memattrs.innerattrs = '00';
    memattrs.innerhints = '00';
  else // Cacheable
    memattrs.innerhints = '11';
    memattrs.innerattrs = attr<1:0>;

return memattrs;

```

## Stage 2 translation table walk

The SecondStageTranslate() pseudocode function describes the stage 2 translation table walk. Stage 2 translations tables always use the Long-descriptor format:

```

// SecondStageTranslate()
// =====
// This function is called from a stage 1 translation table walk when
// the accesses generated from that requires a second stage of translation

AddressDescriptor SecondStageTranslate(AddressDescriptor s1outaddrdesc, bits(32) mva)

AddressDescriptor result;
TLBRecord tlbrecordS2;

if HaveVirtExt() && !IsSecure() && !CurrentModeIsHyp() then
  if HCR.VM == '1' then // second stage enabled
    s2ia = s1outaddrdesc.paddress.physicaladdress;
    is_write = FALSE;
    stage1 = FALSE;
    s2fs1walk = TRUE;
    tlbrecordS2 = TranslationTableWalkLD(s2ia, mva, is_write,
                                         stage1, s2fs1walk);

```



```

CheckPermissionS2(tlbreordS2.perms, mva, s2ia, tlbreordS2.level,
                 is_write, s2fs1walk);
if HCR.PTW == '1' then
  // protected table walk
  if tlbreordS2.addrdesc.memattrs.type != MemType_Normal then
    domain = bits(4) UNKNOWN;
    taketohypmode = TRUE;
    secondstageabort = TRUE;
    ipavalid = TRUE;
    LDFSRformat = TRUE;
    s2fs1walk = TRUE;
    DataAbort(mva, s2ia, domain, tlbreordS2.level,
              is_write, DAbort_Permission, taketohypmode,
              secondstageabort, ipavalid, LDFSRformat, s2fs1walk);
  result = CombineS1S2Desc(s1outaddrdesc, tlbreordS2.addrdesc);
else
  result = s1outaddrdesc;

return;

```

The CheckPermissionS2() pseudocode function checks the access permissions for the stage 2 translation.

———— **Note** ————

[Access permission checking on page B2-1298](#) describes the equivalent function for stage 1 translations, because that function is also used in the PMSA pseudocode.

```

// CheckPermissionS2()
// =====

CheckPermissionS2(Permissions perms, bits(32) mva, bits(40) ipa,
                 integer level, boolean iswrite, boolean s2fs1walk)

  abort = (iswrite && (perms.ap<2> == '0')) || (!iswrite && (perms.ap<1> == '0'));

  if abort then
    domain = bits(4) UNKNOWN;
    taketohypmode = TRUE;
    secondstageabort = TRUE;
    ipavalid = s2fs1walk;
    LDFSRformat = TRUE;
    DataAbort(mva, ipa, domain, level, iswrite, DAbort_Permission,
              taketohypmode, secondstageabort, ipavalid, LDFSRformat,
              s2fs1walk);

  return;

```

The CombineS1S2Desc() pseudocode function combines the stage 1 and stage 2 access permissions:

```

// CombineS1S2Desc()
// =====

AddressDescriptor CombineS1S2Desc(AddressDescriptor s1desc,
                                 AddressDescriptor s2desc)
  // Combines the address descriptors from stage 1 and stage 2

  AddressDescriptor result;

  result.paddress = s2desc.paddress;

  // default values:
  result.memattrs.innerattrs = bits(2) UNKNOWN;
  result.memattrs.outerattrs = bits(2) UNKNOWN;
  result.memattrs.innerhints = bits(2) UNKNOWN;
  result.memattrs.outerhints = bits(2) UNKNOWN;
  result.memattrs.shareable = TRUE;
  result.memattrs.outershareable = TRUE;

```

```
if s2desc.memattrs.type == MemType_StronglyOrdered ||
    s1desc.memattrs.type == MemType_StronglyOrdered then
    result.memattrs.type = MemType_StronglyOrdered;

elseif s2desc.memattrs.type == MemType_Device ||
    s1desc.memattrs.type == MemType_Device then
    result.memattrs.type = MemType_Device;
else
    result.memattrs.type = MemType_Normal;

if result.memattrs.type == MemType_Normal then

    if s2desc.memattrs.innerattrs == '01' ||
        s1desc.memattrs.innerattrs == '01' then
        // either encoding reserved
        result.memattrs.innerattrs = bits(2) UNKNOWN;
    elseif s2desc.memattrs.innerattrs == '00' ||
        s1desc.memattrs.innerattrs == '00' then
        // either encoding Non-cacheable
        result.memattrs.innerattrs = '00';
    elseif s2desc.memattrs.innerattrs == '10' ||
        s1desc.memattrs.innerattrs == '10' then
        // either encoding Write-Through cacheable
        result.memattrs.innerattrs = '10';
    else
        // both encodings Write-Back
        result.memattrs.innerattrs = '11';

    if s2desc.memattrs.outerattrs == '01' ||
        s1desc.memattrs.outerattrs == '01' then
        // either encoding reserved
        result.memattrs.outerattrs = bits(2) UNKNOWN;
    if s2desc.memattrs.outerattrs == '00' ||
        s1desc.memattrs.outerattrs == '00' then
        // either encoding Non-cacheable
        result.memattrs.outerattrs = '00';
    elseif s2desc.memattrs.outerattrs == '10' ||
        s1desc.memattrs.outerattrs == '10' then
        // either encoding Write-Through cacheable
        result.memattrs.outerattrs = '10';
    else
        // both encodings Write-Back
        result.memattrs.outerattrs = '11';

    result.memattrs.innerhints = s1desc.memattrs.innerhints;
    result.memattrs.outerhints = s1desc.memattrs.outerhints;

    result.memattrs.shareable = (s1desc.memattrs.shareable ||
        s2desc.memattrs.shareable);
    result.memattrs.outershareable = (s1desc.memattrs.outershareable ||
        s2desc.memattrs.outershareable);

    if result.memattrs.type == MemType_Normal then
        if result.memattrs.innerattrs == '00' &&
            result.memattrs.outerattrs == '00' then
            // something Non-cacheable at each level is Outer Shareable
            result.memattrs.outershareable = TRUE;
            result.memattrs.shareable = TRUE;

return result;
```

### B3.19.7 Writing to the HSR

The WriteHSR() pseudocode function writes a syndrome value to the HSR:

```
// WriteHSR()
// =====
// Writes a syndrome into the HSR

WriteHSR(bits(6) ec, bits(25) HSRString)

    bits(32) HSRValue = Zeros(32);

    HSRValue<31:26> = ec;

    // HSR.IL not valid for Prefetch Aborts (0x20, 0x21) and Data Aborts (0x24, 0x25) for which
    // the ISS information is not valid.
    if ec<5:3> != '100' || (ec<2> == '1' && HSRString<24> == '1') then
        HSRValue<25> = if ThisInstrLength == 32 then '1' else '0';

    // Condition code valid for EC[5:4] nonzero
    if ec<5:4> == '00' && ec<3:0> != '0000' then
        if CurrentInstrSet == InstrSet_ARM then
            // in the ARM instruction set
            HSRValue<24> = '1';
            HSRValue<23:20> = CurrentCond();
        else
            HSRValue<24> = IMPLEMENTATION_DEFINED;
            if HSRValue<24> == '1' then
                if ConditionPassed then
                    HSRValue<23:20> = IMPLEMENTATION_DEFINED choice between CurrentCond() and '1110';
            else
                HSRValue<23:20> = CurrentCond();
        HSRValue<19:0> = HSRString<19:0>;
    else
        HSRValue<24:0> = HSRString;

    HSR = HSRValue;

    return;
```

### B3.19.8 Calling the hypervisor

The CallHypervisor() pseudocode function generates an HVC exception. Valid execution of the HVC instruction calls this function.

```
// CallHypervisor()
// =====
//
// Performs a HVC call

CallHypervisor(bits(16) immediate)

    HSRString = Zeros(25);
    HSRString<15:0> = immediate;
    WriteHSR('010010', HSRString);

    TakeHVCException();
```

### B3.19.9 Memory access decode when TEX remap is enabled

When using the Short-descriptor translation table format, the function RemappedTEXDecode() decodes the texcb and S attributes derived from the translation tables when TEX remap is enabled. *Short-descriptor format memory region attributes, with TEX remap* on page B3-1368 shows the interpretation of the arguments.

```
// RemappedTEXDecode()
// =====

MemoryAttributes RemappedTEXDecode(bits(5) texcb, bit S)

MemoryAttributes memattrs;
bits(4) hintsattrs;
region = UInt(texcb<2:0>); // texcb<4:3> are ignored in this mapping scheme
if region == 6 then
    IMPLEMENTATION_DEFINED setting of memattrs;
else
    case PRRR<(2*region+1):2*region> of
        when '00'
            memattrs.type = MemType_StronglyOrdered;
            memattrs.innerattrs = bits(2) UNKNOWN;
            memattrs.outerattrs = bits(2) UNKNOWN;
            memattrs.innerhints = bits(2) UNKNOWN;
            memattrs.outerhints = bits(2) UNKNOWN;
            memattrs.shareable = TRUE;
            memattrs.outershareable = TRUE;
        when '01'
            memattrs.type = MemType_Device;
            memattrs.innerattrs = bits(2) UNKNOWN;
            memattrs.outerattrs = bits(2) UNKNOWN;
            memattrs.innerhints = bits(2) UNKNOWN;
            memattrs.outerhints = bits(2) UNKNOWN;
            memattrs.shareable = TRUE;
            memattrs.outershareable = TRUE;
        when '10'
            memattrs.type = MemType_Normal;
            hintsattrs = ConvertAttrsHints(NMRR<(2*region+1):2*region>);
            memattrs.innerattrs = hintsattrs<1:0>;
            memattrs.innerhints = hintsattrs<3:2>;

            hintattrs = ConvertAttrsHints(NMRR<(2*region+17):(2*region+16)>);
            memattrs.outerattrs = hintsattrs<1:0>;
            memattrs.outerhints = hintsattrs<3:2>;

            s_bit = if S == '0' then PRRR.NS0 else PRRR.NS1;
            memattrs.shareable = (s_bit == '1');
            memattrs.outershareable = (s_bit == '1') && (PRRR<region+24> == '0');
        when '11' // reserved
            memattrs.type = MemType_UNKNOWN;
            memattrs.innerattrs = bits(2) UNKNOWN;
            memattrs.outerattrs = bits(2) UNKNOWN;
            memattrs.innerhints = bits(2) UNKNOWN;
            memattrs.outerhints = bits(2) UNKNOWN;
            memattrs.shareable = boolean UNKNOWN;
            memattrs.outershareable = boolean UNKNOWN;

    return memattrs;
```

# Chapter B4

## System Control Registers in a VMSA implementation

This chapter describes the system control registers in a VMSA implementation. The registers are described in alphabetic order. The chapter contains the following sections:

- [VMSA System control registers descriptions, in register order on page B4-1522](#)
- [VMSA system control operations described by function on page B4-1740.](#)

———— **Note** —————

The architecture defines some registers identically for VMSAv7 and PMSAv7 implementations. Those registers are described fully both in this chapter and in [Chapter B6 System Control Registers in a PMSA implementation](#).

---

## B4.1 VMSA System control registers descriptions, in register order

This section describes all of the system control registers that might be present in a VMSAv7 implementation, including registers that are part of an OPTIONAL architecture extension. Registers are shown in register name order.

Some register encodings provide functions that form part of a closely-related functional group, for example, the encodings for cache maintenance operations. *VMSA system control operations described by function* on page B4-1740 describes these operations. However, operations that have an architecturally-defined name also have an alphabetic entry in *VMSA System control registers descriptions, in register order*. For example, the DCCISW cache maintenance operation has a short entry in this section, *DCCISW, Data Cache Clean and Invalidate by Set/Way, VMSA* on page B4-1559, that references its full description in *Cache and branch predictor maintenance operations, VMSA* on page B4-1740.

### B4.1.1 ACTLR, IMPLEMENTATION DEFINED Auxiliary Control Register, VMSA

The ACTLR characteristics are:

<b>Purpose</b>	The ACTLR provides IMPLEMENTATION DEFINED configuration and control options. This register is part of the Other system control registers functional group.
<b>Usage constraints</b>	Only accessible from PL1 or higher.
<b>Configurations</b>	If the implementation includes the Security Extensions, this register is Banked. However, some bits might define global configuration settings, and be common to the Secure and Non-secure copies of the register.
<b>Attributes</b>	A 32-bit RW register. Because the register is IMPLEMENTATION DEFINED, the register reset value is IMPLEMENTATION DEFINED. See also <i>Reset behavior of CP14 and CP15 registers</i> on page B3-1450. <a href="#">Table B3-47 on page B3-1494</a> shows the encodings of all of the registers in the Other system control registers functional group.

The contents of this register are IMPLEMENTATION DEFINED. ARMv7 requires this register to be PL1 read/write accessible, even if the implementation has not created any control bits in this register.

#### Accessing the ACTLR

To access the ACTLR, software reads or writes the CP15 registers with <opc1> set to 0, <CRn> set to c1, <CRm> set to c0, and <opc2> set to 1. For example:

```
MRC p15, 0, <Rt>, c1, c0, 1 ; Read ACTLR into Rt
MCR p15, 0, <Rt>, c1, c0, 1 ; Write Rt to ACTLR
```

## B4.1.2 ADFSR and AIFSR, Auxiliary Data and Instruction Fault Status Registers, VMSA

The ADFSR and AIFSR characteristics are:

<b>Purpose</b>	The <b>AxFSRs</b> can provide additional IMPLEMENTATION DEFINED fault status information, see <a href="#">Auxiliary Fault Status Registers on page B3-1410</a> . These registers are part of the PL1 Fault handling registers functional group.
<b>Usage constraints</b>	Only accessible from PL1 or higher.
<b>Configurations</b>	These registers are not implemented in architecture versions before ARMv7. If the implementation includes the Security Extensions, these registers are Banked.
<b>Attributes</b>	32-bit RW registers. Because these registers are IMPLEMENTATION DEFINED, the reset values are IMPLEMENTATION DEFINED. See also <a href="#">Reset behavior of CP14 and CP15 registers on page B3-1450</a> . <a href="#">Table B3-46 on page B3-1494</a> shows the encodings of all of the registers in the PL1 Fault handling registers functional group.

The ADFSR and AIFSR bit assignments are IMPLEMENTATION DEFINED.

### Accessing the ADFSR and AIFSR

To access the ADFSR or AIFSR, software reads or writes the CP15 registers with <opc1> set to 0, <CRn> set to c5, <CRm> set to c1, and <opc2> set to:

- 0 for the ADFSR
- 1 for the AIFSR.

For example:

```
MRC p15, 0, <Rt>, c5, c1, 0 ; Read ADFSR into Rt
MCR p15, 0, <Rt>, c5, c1, 0 ; Write Rt to ADFSR
MRC p15, 0, <Rt>, c5, c1, 1 ; Read AIFSR into Rt
MCR p15, 0, <Rt>, c5, c1, 1 ; Write Rt to AIFSR
```

### B4.1.3 AIDR, IMPLEMENTATION DEFINED Auxiliary ID Register, VMSA

The AIDR characteristics are:

<b>Purpose</b>	The <a href="#">AIDR</a> provides IMPLEMENTATION DEFINED identification information. This register is part of the Identification registers functional group.
<b>Usage constraints</b>	Only accessible from PL1 or higher. The value of this register must be used in conjunction with the value of <a href="#">MIDR</a> .
<b>Configurations</b>	This register is not implemented in architecture versions before ARMv7. In some ARMv7 implementations this register is UNDEFINED. If the implementation includes the Security Extensions, this register is Common.
<b>Attributes</b>	A 32-bit RO register with an IMPLEMENTATION DEFINED value. See also <a href="#">Reset behavior of CP14 and CP15 registers on page B3-1450</a> . <a href="#">Table B3-44 on page B3-1492</a> shows the encodings of all of the registers in the Identification registers functional group.

The AIDR bit assignments are IMPLEMENTATION DEFINED.

#### Accessing the AIDR

To access the AIDR, software reads the CP15 registers with <opc1> set to 1, <CRn> set to c0, <CRm> set to c0, and <opc2> set to 7. For example:

```
MRC p15, 1, <Rt>, c0, c0, 7 ; Read AIDR into Rt
```

### B4.1.4 AIFSR, Auxiliary Instruction Fault Status Register, VMSA

[ADFSR and AIFSR, Auxiliary Data and Instruction Fault Status Registers, VMSA on page B4-1523](#) describes the AIFSR.



## B4.1.5 AMAIR0 and AMAIR1, Auxiliary Memory Attribute Indirection Registers 0 and 1, VMSA

The AMAIR0 and AMAIR1 characteristics are:

<b>Purpose</b>	When using the Long-descriptor format translation tables for stage 1 translations, AMAIR0 and AMAIR1 provide IMPLEMENTATION DEFINED memory attributes for the memory regions specified by the MAIR <sub>n</sub> registers.  These registers are part of the Virtual memory control registers functional group.
<b>Usage constraints</b>	Only accessible from PL1 or higher.  If an implementation does not provide any IMPLEMENTATION DEFINED memory attributes, these registers are UNK/SBZP. Otherwise, they are only valid when using the Long-descriptor translation table format.  In the implementation includes the Security Extensions: <ul style="list-style-type: none"><li>• the Secure copies of the registers give the values for memory accesses from Secure state</li><li>• the Non-secure copies of the registers give the values for memory accesses from Non-secure modes other than Hyp mode.</li></ul>
<b>Configurations</b>	AMAIR0 and AMAIR1 are implemented only as part of the Large Physical Address Extension. In an implementation that includes the Security Extensions they: <ul style="list-style-type: none"><li>• are Banked</li><li>• have write access to the Secure copy of the register disabled when the CP15SDISABLE signal is asserted HIGH.</li></ul>
<b>Attributes</b>	32-bit RW registers with UNKNOWN reset values. See also <a href="#">Reset behavior of CP14 and CP15 registers on page B3-1450</a> .  <a href="#">Table B3-45 on page B3-1493</a> shows the encodings of all of the registers in the Virtual memory control registers functional group.

The AMAIR0 and AMAIR1 bit assignments are IMPLEMENTATION DEFINED.

### ———— Note —————

In a typical implementation, AMAIR0 and AMAIR1 split into eight one-byte fields, corresponding to the MAIR<sub>n</sub>.Attr<sub>m</sub> fields, but the architecture does not require them to do so.

Any IMPLEMENTATION DEFINED memory attributes are additional qualifiers for the memory locations and must not change the architected behavior specified by the MAIR<sub>n</sub> registers.

### Accessing AMAIR0 or AMAIR1

To access AMAIR0 or AMAIR1, software reads or writes the CP15 registers with <opc1> set to 0, <CRn> set to c10, <CRm> set to c3, and <opc2> set to 0 for AMAIR0, or to 1 for AMAIR1. For example:

```
MRC p15, 0, <Rt>, c10, c3, 0 ; Read AMAIR0 into Rt
MCR p15, 0, <Rt>, c10, c3, 1 ; Write Rt to AMAIR1
```

**B4.1.6 ATS12NSOPR, Address Translate Stages 1 and 2 Non-secure PL1 Read, VMSA only**

*Performing address translation operations on page B4-1747* describes this address translation operation.

This operation is part of the Address translation operations functional group. [Table B3-51 on page B3-1498](#) shows the encodings of all of the registers and operations in this functional group.

**B4.1.7 ATS12NSOPW, Address Translate Stages 1 and 2 Non-secure PL1 Write, VMSA only**

*Performing address translation operations on page B4-1747* describes this address translation operation.

This operation is part of the Address translation operations functional group. [Table B3-51 on page B3-1498](#) shows the encodings of all of the registers and operations in this functional group.

**B4.1.8 ATS12NSOUR, Address Translate Stages 1 and 2 Non-secure Unprivileged Read, VMSA only**

*Performing address translation operations on page B4-1747* describes this address translation operation.

This operation is part of the Address translation operations functional group. [Table B3-51 on page B3-1498](#) shows the encodings of all of the registers and operations in this functional group.

**B4.1.9 ATS12NSOUW, Address Translate Stages 1 and 2 Non-secure Unprivileged Write, VMSA only**

*Performing address translation operations on page B4-1747* describes this address translation operation.

This operation is part of the Address translation operations functional group. [Table B3-51 on page B3-1498](#) shows the encodings of all of the registers and operations in this functional group.

**B4.1.10 ATS1CPR, Address Translate Stage 1 Current state PL1 Read, VMSA only**

*Performing address translation operations on page B4-1747* describes this address translation operation.

This operation is part of the Address translation operations functional group. [Table B3-51 on page B3-1498](#) shows the encodings of all of the registers and operations in this functional group.

**B4.1.11 ATS1CPW, Address Translate Stage 1 Current state PL1 Write, VMSA only**

*Performing address translation operations on page B4-1747* describes this address translation operation.

This operation is part of the Address translation operations functional group. [Table B3-51 on page B3-1498](#) shows the encodings of all of the registers and operations in this functional group.

**B4.1.12 ATS1CUR, Address Translate Stage 1 Current state Unprivileged Read, VMSA only**

*Performing address translation operations on page B4-1747* describes this address translation operation.

This operation is part of the Address translation operations functional group. [Table B3-51 on page B3-1498](#) shows the encodings of all of the registers and operations in this functional group.

**B4.1.13 ATS1CUW, Address Translate Stage 1 Current state Unprivileged Write, VMSA only**

*Performing address translation operations on page B4-1747* describes this address translation operation.

This operation is part of the Address translation operations functional group. [Table B3-51 on page B3-1498](#) shows the encodings of all of the registers and operations in this functional group.

**B4.1.14 ATS1HR, Address Translate Stage 1 Hyp mode Read, VMSA only**

*Performing address translation operations on page B4-1747* describes this address translation operation.

This operation is part of the Address translation operations functional group. [Table B3-51 on page B3-1498](#) shows the encodings of all of the registers and operations in this functional group.

#### **B4.1.15   ATS1HW, Address Translate Stage 1 Hyp mode Write, VMSA only**

*Performing address translation operations on page B4-1747* describes this address translation operation.

This operation is part of the Address translation operations functional group. [Table B3-51 on page B3-1498](#) shows the encodings of all of the registers and operations in this functional group.

#### **B4.1.16   BPIALL, Branch Predictor Invalidate All, VMSA**

*Cache and branch predictor maintenance operations, VMSA on page B4-1740* describes this branch predictor maintenance operation.

This operation is part of the Cache maintenance operations functional group. [Table B3-49 on page B3-1496](#) shows the encodings of all of the registers and operations in this functional group.

#### **B4.1.17   BPIALLIS, Branch Predictor Invalidate All, Inner Shareable, VMSA**

*Cache and branch predictor maintenance operations, VMSA on page B4-1740* describes this branch predictor maintenance operation.

This operation is part of the Cache maintenance operations functional group. [Table B3-49 on page B3-1496](#) shows the encodings of all of the registers and operations in this functional group.

#### **B4.1.18   BPIMVA, Branch Predictor Invalidate by MVA, VMSA**

*Cache and branch predictor maintenance operations, VMSA on page B4-1740* describes this branch predictor maintenance operation.

This operation is part of the Cache maintenance operations functional group. [Table B3-49 on page B3-1496](#) shows the encodings of all of the registers and operations in this functional group.

### B4.1.19 CCSIDR, Cache Size ID Registers, VMSA

The CCSIDR characteristics are:

- Purpose** The [CCSIDR](#) provides information about the architecture of the caches. This register is part of the Identification registers functional group.
- Usage constraints** Only accessible from PL1 or higher. If [CSSELR](#) indicates a cache that is not implemented, the result of reading CCSIDR is UNPREDICTABLE.
- Configurations** The implementation includes one CCSIDR for each cache that it can access. [CSSELR](#) selects which Cache Size ID Register is accessible. Architecture versions before ARMv7 do not define these registers. If the implementation includes the Security Extensions, these registers are Common.
- Attributes** A 32-bit RO register with an IMPLEMENTATION DEFINED value. See also [Reset behavior of CP14 and CP15 registers on page B3-1450](#). [Table B3-44 on page B3-1492](#) shows the encodings of all of the registers in the Identification registers functional group.

The CCSIDR bit assignments are:

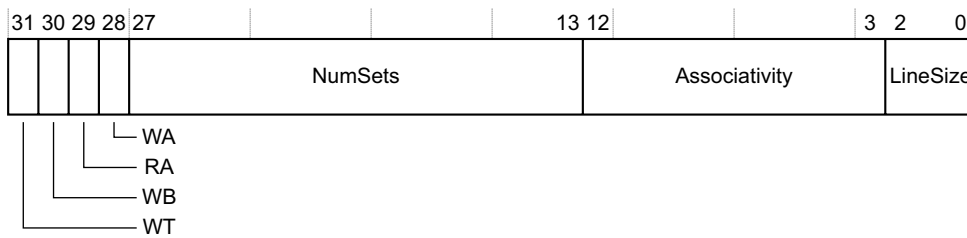

- WT, bit[31]** Indicates whether the cache level supports write-through, see [Table B4-1](#).
- WB, bit[30]** Indicates whether the cache level supports write-back, see [Table B4-1](#).
- RA, bit[29]** Indicates whether the cache level supports read-allocation, see [Table B4-1](#).
- WA, bit[28]** Indicates whether the cache level supports write-allocation, see [Table B4-1](#).

**Table B4-1 WT, WB, RA and WA bit values**

WT, WB, RA or WA bit value	Meaning
0	Feature not supported
1	Feature supported

**NumSets, bits[27:13]**

(Number of sets in cache) - 1, therefore a value of 0 indicates 1 set in the cache. The number of sets does not have to be a power of 2.

**Associativity, bits[12:3]**

(Associativity of cache) - 1, therefore a value of 0 indicates an associativity of 1. The associativity does not have to be a power of 2.

**LineSize, bits[2:0]**

( $\text{Log}_2(\text{Number of words in cache line}) - 2$ ). For example:

- For a line length of 4 words:  $\text{Log}_2(4) = 2$ , LineSize entry = 0.  
This is the minimum line length.
- For a line length of 8 words:  $\text{Log}_2(8) = 3$ , LineSize entry = 1.

**Accessing the currently selected CCSIDR**

The **CSSELR** selects a CCSIDR. To access the currently-selected CCSIDR, software reads the CP15 registers with `<opc1>` set to 1, `<CRn>` set to `c0`, `<CRm>` set to `c0`, and `<opc2>` set to 0. For example:

`MRC p15, 1, <Rt>, c0, c0, 0` ; Read current CCSIDR into Rt

Any access to the CCSIDR when the value in **CSSELR** corresponds to a cache that is not implemented returns an UNKNOWN value.

## B4.1.20 CLIDR, Cache Level ID Register, VMSA

The CLIDR characteristics are:

<b>Purpose</b>	The CLIDR identifies: <ul style="list-style-type: none"> <li>• the type of cache, or caches, implemented at each level, up to a maximum of seven levels</li> <li>• the Level of Coherency and Level of Unification for the cache hierarchy.</li> </ul> This register is part of the Identification registers functional group.
<b>Usage constraints</b>	Only accessible from PL1 or higher.
<b>Configurations</b>	This register is not implemented in architecture versions before ARMv7. If the implementation includes the Security Extensions, this register is Common.
<b>Attributes</b>	A 32-bit RO register with an IMPLEMENTATION DEFINED value. See also <a href="#">Reset behavior of CP14 and CP15 registers on page B3-1450</a> . <a href="#">Table B3-44 on page B3-1492</a> shows the encodings of all of the registers in the Identification registers functional group.

The CLIDR bit assignments are:

31	30	29	27	26	24	23	21	20	18	17	15	14	12	11	9	8	6	5	3	2	0	
(0)	(0)	LoUU	LoC	LoUIS	Ctype7	Ctype6	Ctype5	Ctype4	Ctype3	Ctype2	Ctype1											

**Bits[31:30]** Reserved, UNK.

**LoUU, bits[29:27]**

Level of Unification Uniprocessor for the cache hierarchy, see [Terminology for Clean, Invalidate, and Clean and Invalidate operations on page B2-1275](#).

**LoC, bits[26:24]**

Level of Coherency for the cache hierarchy, see [Terminology for Clean, Invalidate, and Clean and Invalidate operations on page B2-1275](#).

**LoUIS, bits[23:21]**

Level of Unification Inner Shareable for the cache hierarchy, see [Terminology for Clean, Invalidate, and Clean and Invalidate operations on page B2-1275](#).

In an implementation that does not include the Multiprocessing Extensions, this field is RAZ.

**Ct<sub>n</sub>, bits[3(n - 1) + 2:3(n - 1)], for n = 1 to 7**

Cache Type fields. Indicate the type of cache implemented at each level, from Level 1 up to a maximum of seven levels of cache hierarchy. The Level 1 cache field, Ctype1, is bits[2:0], see register diagram. [Table B4-2](#) shows the possible values for each Ct<sub>n</sub> field.

**Table B4-2 Ct<sub>n</sub> bit values**

Ct <sub>n</sub> value	Meaning, cache implemented at this level
000	No cache
001	Instruction cache only
010	Data cache only
011	Separate instruction and data caches

**Table B4-2 Ctypen bit values (continued)**

Ctypen value	Meaning, cache implemented at this level
100	Unified cache
101, 11X	Reserved

If software reads the Cache Type fields from Ctype1 upwards, once it has seen a value of 0b000, no caches exist at further-out levels of the hierarchy. So, for example, if Ctype3 is the first Cache Type field with a value of 0b000, the values of Ctype4 to Ctype7 must be ignored.

The CLIDR describes only the caches that are under the control of the processor.

### Accessing the CLIDR

To access the CLIDR, software reads the CP15 registers with <opc1> set to 1, <CRn> set to c0, <CRm> set to c0, and <opc2> set to 1. For example:

```
MRC p15, 1, <Rt>, c0, c0, 1 ; Read CLIDR into Rt
```

### B4.1.21 CNTFRQ, Counter Frequency register, VMSA

The CNTFRQ register characteristics are:

<b>Purpose</b>	The CNTFRQ register indicates the clock frequency of the system counter. This register is a Generic Timer register.
<b>Usage constraints</b>	In an implementation that includes the Security Extensions, RW only from Secure PL1 modes, RO from Non-secure PL1 and PL2 modes. Otherwise, RW only from PL1 modes. In all implementations, when <code>CNTKCTL</code> .{ <code>PL0VCTEN</code> , <code>PL0PCTEN</code> } is not set to <code>0b00</code> , is also RO from PL0 modes.
<b>Configurations</b>	Implemented only as part of the Generic Timers Extension. The VMSA, PMSA, and system level definitions of the register fields are identical. In an implementation that includes the Security Extensions, this register is Common.
<b>Attributes</b>	A 32-bit RW register with an UNKNOWN reset value. <a href="#">Table B8-2 on page B8-1967</a> shows the encodings of all of the Generic Timer registers.

The CNTFRQ bit assignments are:

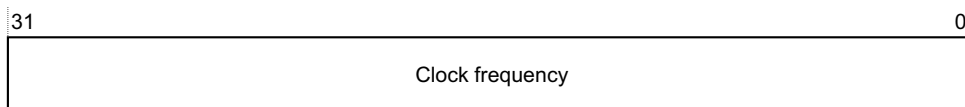

#### Clock frequency, bits[31:0]

Indicates the system counter clock frequency, in Hz.

#### ———— Note ————

Programming CNTFRQ does not affect the system clock frequency. However, on system initialization, CNTFRQ must be correctly programmed with the system clock frequency, to make this value available to software. For more information see [Initializing and reading the system counter frequency on page B8-1959](#).

#### Accessing CNTFRQ

To access CNTFRQ, software reads or writes the CP15 registers with `<opc1>` set to 0, `<CRn>` set to `c14`, `<CRm>` set to `c0`, and `<opc2>` set to 0. For example:

```
MRC p15, 0, <Rt>, c14, c0, 0 ; Read CNTFRQ into Rt
MCR p15, 0, <Rt>, c14, c0, 0 ; Write Rt to CNTFRQ
```



## B4.1.22 CNTHCTL, Timer PL2 Control register, Virtualization Extensions

The CNTHCTL characteristics are:

<b>Purpose</b>	Controls: <ul style="list-style-type: none"> <li>• access to the following from Non-secure PL1 modes:             <ul style="list-style-type: none"> <li>— the physical counter</li> <li>— the Non-secure PL1 physical timer.</li> </ul> </li> <li>• the generation of an event stream from the physical counter.</li> </ul> This register is a Generic Timer register.
<b>Usage constraints</b>	Only accessible from Hyp mode, or from Monitor mode when <a href="#">SCR.NS</a> is set to 1, see <a href="#">PL2-mode system control registers on page B3-1454</a> .
<b>Configurations</b>	Implemented only as part of the Generic Timers Extension, and only if the implementation also includes the Virtualization Extensions.  This is a PL2-mode register, see <a href="#">Banked PL2-mode CP15 read/write registers on page B3-1454</a> .
<b>Attributes</b>	A 32-bit RW register. See the field descriptions for information about the reset values.  <a href="#">Table B8-2 on page B8-1967</a> shows the encodings of all of the Generic Timer registers.

In an ARMv7 implementation, the CNTHCTL bit assignments are:

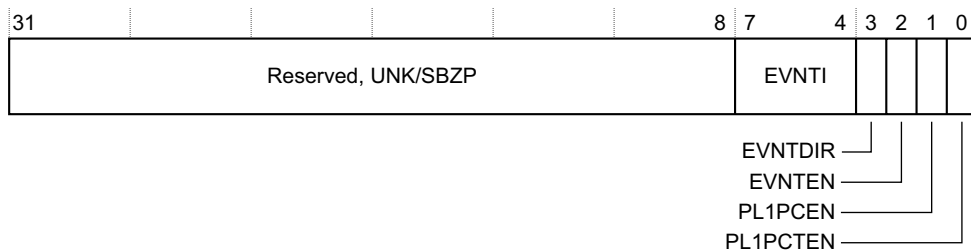

<b>Bits[31:8]</b>	Reserved, UNK/SBZP.
<b>EVNTI, bits[7:4]</b>	Selects which bit of <a href="#">CNTPCT</a> is the trigger for the event stream generated from the physical counter, when that stream is enabled. For example, if this field is <code>0b0110</code> , <a href="#">CNTPCT</a> [6] is the trigger bit for the virtual counter event stream.  For more information see <a href="#">Event streams on page B8-1962</a> .  This field is UNKNOWN on reset.
<b>EVNTDIR, bit[3]</b>	Controls which transition of the <a href="#">CNTPCT</a> trigger bit, defined by EVNTI, generates an event, when the event stream is enabled: <ul style="list-style-type: none"> <li><b>0</b> A 0 to 1 transition of the trigger bit triggers an event.</li> <li><b>1</b> A 1 to 0 transition of the trigger bit triggers an event.</li> </ul> For more information see <a href="#">Event streams on page B8-1962</a> .  This bit is UNKNOWN on reset.
<b>EVNTEN, bit[2]</b>	Enables the generation of an event stream from the physical counter: <ul style="list-style-type: none"> <li><b>0</b> Disables the event stream.</li> <li><b>1</b> Enables the event stream.</li> </ul> For more information see <a href="#">Event streams on page B8-1962</a> .  This bit resets to 0.

- PL1PCEN, bit[1]** Controls whether the Non-secure copies of the physical timer registers are accessible from Non-secure PL1 and PL0 modes:
- 0** The Non-secure [CNTP\\_CVAL](#), [CNTP\\_TVAL](#), and [CNTP\\_CTL](#) registers are not accessible Non-secure PL1 and PL0 modes.
  - 1** The Non-secure [CNTP\\_CVAL](#), [CNTP\\_TVAL](#), and [CNTP\\_CTL](#) registers are accessible from Non-secure PL1 and PL0 modes.
- For more information see [Accessing the timer registers on page B8-1964](#).  
This bit resets to 1.
- PL1PCTEN, bit[0]** Controls whether the physical counter, [CNTPCT](#), is accessible from Non-secure PL1 and PL0 modes:
- 0** The [CNTPCT](#) register is not accessible from Non-secure PL1 and PL0 modes.
  - 1** The [CNTPCT](#) register is accessible from Non-secure PL1 and PL0 modes.
- For more information see [Accessing the physical counter on page B8-1960](#).  
This bit resets to 1.

### Accessing CNTHCTL

To access CNTHCTL, software reads or writes the CP15 registers with <opc1> set to 4, <CRn> set to c14, <CRm> set to c1, and <opc2> set to 0. For example:

```
MRC p15, 4, <Rt>, c14, c1, 0 ; Read CNTHCTL to Rt  
MCR p15, 4, <Rt>, c14, c1, 0 ; Write Rt to CNTHCTL
```

### B4.1.23 CNTHP\_CTL, PL2 Physical Timer Control register, Virtualization Extension

The CNTHP\_CTL characteristics are:

<b>Purpose</b>	The control register for the Hyp mode physical timer. This register is a Generic Timer register.
<b>Usage constraints</b>	Only accessible from Hyp mode, or from Monitor mode when SCR.NS is set to 1, see <a href="#">PL2-mode system control registers on page B3-1454</a> . For more information, see <a href="#">Accessing the timer registers on page B8-1964</a> .
<b>Configurations</b>	Implemented only as part of the Generic Timers Extension, and only if the implementation also includes the Virtualization Extensions. This is a PL2-mode register, see <a href="#">Banked PL2-mode CP15 read/write registers on page B3-1454</a> .
<b>Attributes</b>	A 32-bit RW register with an UNKNOWN reset value. <a href="#">Table B8-2 on page B8-1967</a> shows the encodings of all of the Generic Timer registers.

The bit assignments of CNTHP\_CTL are identical to those of CNTP\_CTL.

#### Accessing CNTHP\_CTL

To access CNTHP\_CTL, software reads or writes the CP15 registers with <opc1> set to 4, <CRn> set to c14, <CRm> set to c2, and <opc2> set to 1. For example:

```
MRC p15, 4, <Rt>, c14, c2, 1 ; Read CNTHP_CTL into Rt
MCR p15, 4, <Rt>, c14, c2, 1 ; Write Rt to CNTHP_CTL
```

### B4.1.24 CNTHP\_CVAL, PL2 Physical Timer CompareValue register, Virtualization Extensions

The CNTHP\_CVAL characteristics are:

<b>Purpose</b>	Holds the compare value for the Hyp mode physical timer. This register is a Generic Timer register.
<b>Usage constraints</b>	Only accessible from Hyp mode, or from Monitor mode when SCR.NS is set to 1, see <a href="#">PL2-mode system control registers on page B3-1454</a> . For more information, see <a href="#">Accessing the timer registers on page B8-1964</a> .
<b>Configurations</b>	Implemented only as part of the Generic Timers Extension, and only if the implementation also includes the Virtualization Extensions. This is a PL2-mode register, see <a href="#">Banked PL2-mode CP15 read/write registers on page B3-1454</a> .
<b>Attributes</b>	A 64-bit RW register with an UNKNOWN reset value. <a href="#">Table B8-2 on page B8-1967</a> shows the encodings of all of the Generic Timer registers.

The bit assignments of CNTHP\_CVAL are identical to those of CNTP\_CVAL.

#### Accessing CNTHP\_CVAL

To access CNTHP\_CVAL, software performs a 64-bit read or write of the CP15 registers with <CRm> set to c14 and <opc1> set to 6. For example:

```
MRRC p15, 6, <Rt>, <Rt2>, c14 ; Read 64-bit CNTHP_CVAL into Rt (low word) and Rt2 (high word)
MCRR p15, 6, <Rt>, <Rt2>, c14 ; Write Rt (low word) and Rt2 (high word) to 64-bit CNTHP_CVAL
```

In these MRRC and MCRR instructions, Rt holds the least-significant word of CNTHP\_CVAL, and Rt2 holds the most-significant word.

## B4.1.25 CNTHP\_TVAL, PL2 Physical TimerValue register, Virtualization Extensions

The CNTHP\_TVAL characteristics are:

<b>Purpose</b>	Holds the timer value for the Hyp mode physical timer. This provides a 32-bit downcounter, see <a href="#">Operation of the TimerValue views of the timers</a> on page B8-1965. This register is a Generic Timer register.
<b>Usage constraints</b>	Only accessible from Hyp mode, or from Monitor mode when SCR.NS is set to 1, see <a href="#">PL2-mode system control registers</a> on page B3-1454. For more information, see <a href="#">Accessing the timer registers</a> on page B8-1964. When CNTHP_CTL.ENABLE is set to 0: <ul style="list-style-type: none"><li>• a write to this register updates the register</li><li>• the value held in the register continues to decrement</li><li>• a read of the register returns an UNKNOWN value.</li></ul>
<b>Configurations</b>	Implemented only as part of the Generic Timers Extension, and only if the implementation also includes the Virtualization Extensions. This is a PL2-mode register, see <a href="#">Banked PL2-mode CP15 read/write registers</a> on page B3-1454.
<b>Attributes</b>	A 32-bit RW register with an UNKNOWN reset value. <a href="#">Table B8-2 on page B8-1967</a> shows the encodings of all of the Generic Timer registers.

The bit assignments of CNTHP\_TVAL are identical to those of CNTP\_TVAL.

### Accessing CNTHP\_TVAL

To access CNTHP\_TVAL, software reads or writes the CP15 registers with <opc1> set to 4, <CRn> set to c14, <CRm> set to c2, and <opc2> set to 0. For example:

```
MRC p15, 4, <Rt>, c14, c2, 0 ; Read CNTHP_TVAL into Rt  
MCR p15, 4, <Rt>, c14, c2, 0 ; Write Rt to CNTHP_TVAL
```



- EVNTDIR, bit[3]** Controls which transition of the **CNTVCT** trigger bit, defined by EVNTI, generates an event, when the event stream is enabled:  
**0** A 0 to 1 transition of the trigger bit triggers an event.  
**1** A 1 to 0 transition of the trigger bit triggers an event.  
This bit is UNKNOWN on reset.  
For more information see [Event streams on page B8-1962](#).
- EVNTEN, bit[2]** Enables the generation of an event stream from the virtual counter:  
**0** Disables the event stream.  
**1** Enables the event stream.  
This bit resets to 0.  
For more information see [Event streams on page B8-1962](#).
- PL0VCTEN, bit[1]** Controls whether the virtual counter, **CNTVCT**, and the frequency register **CNTFRQ**, are accessible from PL0 modes:  
**0** **CNTVCT** is not accessible from PL0.  
If PL0PCTEN is set to 0, **CNTFRQ** is not accessible from PL0.  
**1** **CNTVCT** and **CNTFRQ** are accessible from PL0.  
This bit resets to 0.  
For more information see [Accessing the physical counter on page B8-1960](#).
- PL0PCTEN, bit[0]** Controls whether the physical counter, **CNTPCT**, and the frequency register **CNTFRQ**, are accessible from PL0 modes:  
**0** **CNTPCT** is not accessible from PL0 modes.  
If PL0VCTEN is set to 0, **CNTFRQ** is not accessible from PL0.  
**1** **CNTPCT** and **CNTFRQ** are accessible from PL0.  
This bit resets to 0.  
For more information see [Accessing the virtual counter on page B8-1961](#).

———— **Note** —————

**CNTFRQ** is accessible from PL0 modes if either PL0VCTEN or PL0PCTEN is set to 1.

### Accessing CNTKCTL

To access CNTKCTL, software reads or writes the CP15 registers with <opc1> set to 0, <CRn> set to c14, <CRm> set to c1, and <opc2> set to 0. For example:

```
MRC p15, 0, <Rt>, c14, c1, 0 ; Read CNTKCTL to Rt  
MCR p15, 0, <Rt>, c14, c1, 0 ; Write Rt to CNTKCTL
```

### B4.1.27 CNTP\_CTL, PL1 Physical Timer Control register, VMSA

The CNTP\_CTL characteristics are:

<b>Purpose</b>	The control register for the physical timer. This register is a Generic Timer register.
<b>Usage constraints</b>	In an implementation that does not include the Virtualization Extensions, accessible in PL1 modes. In an implementation that includes the Virtualization Extensions: <ul style="list-style-type: none"> <li>• the Secure copy of the register is accessible in Secure PL1 modes</li> <li>• the Non-secure copy of the register is accessible in Non-secure Hyp mode, and when <a href="#">CNTHCTL.PL1PCEN</a> is set to 1, in Non-secure PL1 modes.</li> </ul> When the register is accessible in PL1 modes, in the current security state, <a href="#">CNTKCTL.PLOPTEN</a> determines whether the register is accessible from the PL0 mode. For more information, see <a href="#">Accessing the timer registers on page B8-1964</a> .
<b>Configurations</b>	Implemented only as part of the Generic Timers Extension. The VMSA, PMSA, and system level definitions of the register fields are identical. If the implementation includes the Security Extensions, this register is Banked.
<b>Attributes</b>	A 32-bit RW register with an UNKNOWN reset value. <a href="#">Table B8-2 on page B8-1967</a> shows the encodings of all of the Generic Timer registers.

In an ARMv7 implementation, the CNTP\_CTL bit assignments are:

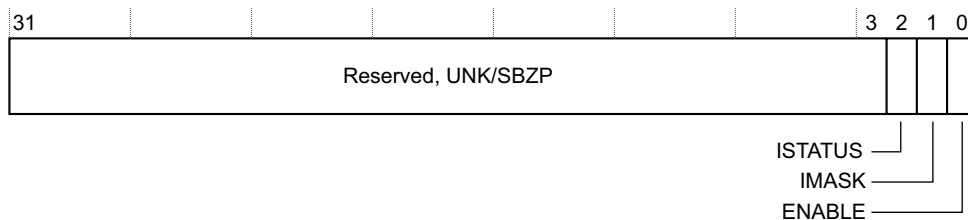

<b>Bits[31:3]</b>	Reserved, UNK/SBZP.
<b>ISTATUS, bit[2]</b>	The status of the timer. This bit indicates whether the timer condition is asserted: <ul style="list-style-type: none"> <li><b>0</b> Timer condition is not asserted.</li> <li><b>1</b> Timer condition is asserted.</li> </ul> When the ENABLE bit is set to 1, ISTATUS indicates whether the timer value meets the condition for the timer output to be asserted, see <a href="#">Operation of the CompareValue views of the timers on page B8-1964</a> and <a href="#">Operation of the TimerValue views of the timers on page B8-1965</a> . ISTATUS takes no account of the value of the IMASK bit. If ISTATUS is set to 1 and IMASK is set to 0 then the timer output signal is asserted. This bit is read-only.
<b>IMASK, bit[1]</b>	Timer output signal mask bit. Permitted values are: <ul style="list-style-type: none"> <li><b>0</b> Timer output signal is not masked.</li> <li><b>1</b> Timer output signal is masked.</li> </ul> For more information, see the description of the ISTATUS bit and <a href="#">Operation of the timer output signal on page B8-1966</a> .

**ENABLE, bit[0]**

Enables the timer. Permitted values are:

- 0** . Timer disabled.
- 1** . Timer enabled.

Setting this bit to 0 disables the timer output signal, but the timer value accessible from [CNTP\\_TVAL](#) continues to count down.

———— **Note** —————

Disabling the output signal might be a power-saving option.

---

**Accessing CNTP\_CTL**

To access CNTP\_CTL, software reads or writes the CP15 registers with <opc1> set to 0, <CRn> set to c14, <CRm> set to c2, and <opc2> set to 1. For example:

```
MRC p15, 0, <Rt>, c14, c2, 1 ; Read CNTP_CTL into Rt  
MCR p15, 0, <Rt>, c14, c2, 1 ; Write Rt to CNTP_CTL
```



## B4.1.28 CNTP\_CVAL, PL1 Physical Timer CompareValue register, VMSA

The CNTP\_CVAL characteristics are:

<b>Purpose</b>	<p>Holds the 64-bit compare value for the PL1 physical timer.          This register is a Generic Timer register.</p>
<b>Usage constraints</b>	<p>In an implementation that does not include the Virtualization Extensions, accessible in PL1 modes.</p> <p>In an implementation that includes the Virtualization Extensions:</p> <ul style="list-style-type: none"> <li>• the Secure copy of the register is accessible in Secure PL1 modes</li> <li>• the Non-secure copy of the register is accessible in Non-secure Hyp mode, and when <a href="#">CNTHCTL.PL1PCEN</a> is set to 1, in Non-secure PL1 modes.</li> </ul> <p>When the register is accessible in PL1 modes, in the current security state, <a href="#">CNTKCTL.PLOPTEN</a> determines whether the register is accessible from the PL0 mode.          For more information, see <a href="#">Accessing the timer registers on page B8-1964</a>.</p>
<b>Configurations</b>	<p>Implemented only as part of the Generic Timers Extension.          The VMSA, PMSA, and system level definitions of the register fields are identical.          If the implementation includes the Security Extensions, this register is Banked.</p>
<b>Attributes</b>	<p>A 64-bit RW register with an UNKNOWN reset value.  <a href="#">Table B8-2 on page B8-1967</a> shows the encodings of all of the Generic Timer registers.</p>

In an ARMv7 implementation, the CNTP\_CVAL bit assignments are:

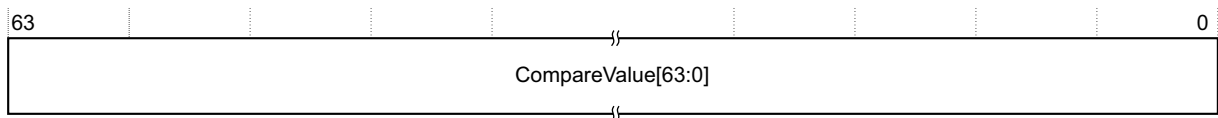

### CompareValue, bits[63:0]

Indicates the compare value for the PL1 physical timer.

For more information about the timer see [Timers on page B8-1963](#).

### Accessing CNTP\_CVAL

To access CNTP\_CVAL, software performs a 64-bit read or write of the CP15 registers with <CRm> set to c14 and <opc1> set to 2. For example:

```
MRRC p15, 2, <Rt>, <Rt2>, c14 ; Read 64-bit CNTP_CVAL into Rt (low word) and Rt2 (high word)
MCRR p15, 2, <Rt>, <Rt2>, c14 ; Write Rt (low word) and Rt2 (high word) to 64-bit CNTP_CVAL
```

In these MRRC and MCRR instructions, Rt holds the least-significant word of CNTP\_CVAL, and Rt2 holds the most-significant word.

## B4.1.29 CNTP\_TVAL, PL1 Physical TimerValue register, VMSA

The CNTP\_TVAL characteristics are:

<b>Purpose</b>	<p>Holds the timer value for the PL1 physical timer. This provides a 32-bit downcounter, see <a href="#">Operation of the TimerValue views of the timers on page B8-1965</a>.</p> <p>This register is a Generic Timer register.</p>
<b>Usage constraints</b>	<p>In an implementation that does not include the Virtualization Extensions, accessible in PL1 modes.</p> <p>In an implementation that includes the Virtualization Extensions:</p> <ul style="list-style-type: none"> <li>• the Secure copy of the register is accessible in Secure PL1 modes</li> <li>• the Non-secure copy of the register is accessible in Non-secure Hyp mode, and when <a href="#">CNTHCTL.PL1PCEN</a> is set to 1, in Non-secure PL1 modes.</li> </ul> <p>When the register is accessible in PL1 modes, in the current security state, <a href="#">CNTKCTL.PLOPTEN</a> determines whether the register is accessible from the PL0 mode.</p> <p>For more information, see <a href="#">Accessing the timer registers on page B8-1964</a>.</p> <p>When <a href="#">CNTP_CTL.ENABLE</a> is set to 0:</p> <ul style="list-style-type: none"> <li>• a write to this register updates the register</li> <li>• the value held in the register continues to decrement</li> <li>• a read of the register returns an UNKNOWN value.</li> </ul>
<b>Configurations</b>	<p>Implemented only as part of the Generic Timers Extension.</p> <p>The VMSA, PMSA, and system level definitions of the register fields are identical.</p> <p>If the implementation includes the Security Extensions, this register is Banked.</p>
<b>Attributes</b>	<p>A 32-bit RW register with an UNKNOWN reset value.</p> <p><a href="#">Table B8-2 on page B8-1967</a> shows the encodings of all of the Generic Timer registers.</p>

In an ARMv7 implementation, the CNTP\_TVAL bit assignments are:

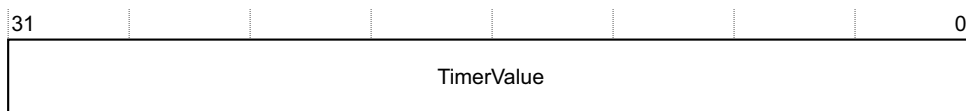

### TimerValue, bits[31:0]

Indicates the timer value.

### Accessing CNTP\_TVAL

To access CNTP\_TVAL, software reads or writes the CP15 registers with <opc1> set to 0, <CRn> set to c14, <CRm> set to c2, and <opc2> set to 0. For example:

```
MRC p15, 0, <Rt>, c14, c2, 0 ; Read CNTP_TVAL into Rt
MCR p15, 0, <Rt>, c14, c2, 0 ; Write Rt to CNTP_TVAL
```

### B4.1.30 CNTPCT, Physical Count register, VMSA

The CNTPCT register characteristics are:

<b>Purpose</b>	The CNTPCT register holds the 64-bit physical count value. This register is a Generic Timer register.
<b>Usage constraints</b>	In an implementation that does not include the Virtualization Extensions, always accessible from PL1 modes, in both security states. In an implementation that includes the Virtualization Extensions, CNTPCT is: <ul style="list-style-type: none"> <li>• always accessible Secure PL1 modes and from Non-secure Hyp mode</li> <li>• accessible from Non-secure PL1 modes only when <code>CNTHCTL.PL1PCTEN</code> is set to 1.</li> </ul> When <code>CNTKCTL.PLOPCTEN</code> is set to 1, CNTPCT is also accessible from PL0 modes. Fore more information about the CNTPCT access controls see <a href="#">Accessing the physical counter on page B8-1960</a> .
<b>Configurations</b>	Implemented only as part of the Generic Timers Extension. The VMSA, PMSA, and system level definitions of the register fields are identical. In an implementation that includes the Security Extensions, this register is Common.
<b>Attributes</b>	A 64-bit RO register with an UNKNOWN reset value. <a href="#">Table B8-2 on page B8-1967</a> shows the encodings of all of the Generic Timer registers.

The CNTPCT bit assignments are:

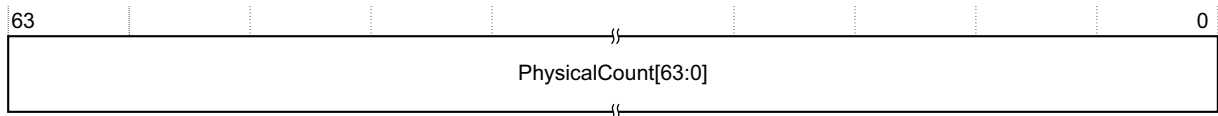

**PhysicalCount, bits[63:0]**  
 Indicates the physical count.

#### Accessing CNTPCT

To access CNTPCT, software performs a 64-bit read of the CP15 registers with `<CRm>` set to `c14` and `<opc1>` set to `0`. For example:

`MRRC p15, 0, <Rt>, <Rt2>, c14 ; Read 64-bit CNTPCT into Rt (low word) and Rt2 (high word)`

In the MRRC instruction, `Rt` holds the least-significant word of CNTPCT, and `Rt2` holds the most-significant word.

### B4.1.31 CNTV\_CTL, Virtual Timer Control register, VMSA

The CNTV\_CTL register characteristics are:

<b>Purpose</b>	The control register for the virtual timer. This register is a Generic Timer register.
<b>Usage constraints</b>	Accessible from Secure PL1 modes and Non-secure PL1 and PL2 modes. When <a href="#">CNTKCTL.PLOVTEN</a> is set to 1, also accessible from PL0 modes. For more information, see <a href="#">Accessing the timer registers on page B8-1964</a> .
<b>Configurations</b>	Implemented only as part of the Generic Timers Extension. The VMSA, PMSA, and system level definitions of the register fields are identical. In an implementation that includes the Security Extensions, this register is Common.
<b>Attributes</b>	A 32-bit RW register with an UNKNOWN reset value. <a href="#">Table B8-2 on page B8-1967</a> shows the encodings of all of the Generic Timer registers.

The bit assignments of the CNTV\_CTL register are identical to those of [CNTP\\_CTL](#).

#### Accessing CNTV\_CTL

To access CNTV\_CTL, software reads or writes the CP15 registers with <opc1> set to 0, <CRn> set to c14, <CRm> set to c3, and <opc2> set to 1. For example:

```
MRC p15, 0, <Rt>, c14, c3, 1 ; Read CNTV_CTL into Rt
MCR p15, 0, <Rt>, c14, c3, 1 ; Write Rt to CNTV_CTL
```

### B4.1.32 CNTV\_CVAL, Virtual Timer CompareValue register, VMSA

The CNTV\_CVAL characteristics are:

<b>Purpose</b>	Holds the compare value for the virtual timer. This register is a Generic Timer register.
<b>Usage constraints</b>	Accessible from Secure PL1 modes and Non-secure PL1 and PL2 modes. When <a href="#">CNTKCTL.PLOVTEN</a> is set to 1, also accessible from PL0 modes. For more information, see <a href="#">Accessing the timer registers on page B8-1964</a> .
<b>Configurations</b>	Implemented only as part of the Generic Timers Extension. The VMSA, PMSA, and system level definitions of the register fields are identical. In an implementation that includes the Security Extensions, this register is Common.
<b>Attributes</b>	A 64-bit RW register with an UNKNOWN reset value. <a href="#">Table B8-2 on page B8-1967</a> shows the encodings of all of the Generic Timer registers.

The bit assignments of CNTV\_CVAL are identical to those of [CNTP\\_CVAL](#).

#### Accessing CNTV\_CVAL

To access CNTV\_CVAL, software performs a 64-bit read or write of the CP15 registers with <CRm> set to c14 and <opc1> set to 3. For example:

```
MRRC p15, 3, <Rt>, <Rt2>, c14 ; Read 64-bit CNTV_CVAL into Rt (low word) and Rt2 (high word)
MCRR p15, 3, <Rt>, <Rt2>, c14 ; Write 64-bit Rt (low word) and Rt2 (high word) to CNTV_CVAL
```

In these MRRC and MCRR instructions, Rt holds the least-significant word of CNTV\_CVAL, and Rt2 holds the most-significant word.

### B4.1.33 CNTV\_TVAL, Virtual TimerValue register, VMSA

The CNTV\_TVAL characteristics are:

<b>Purpose</b>	Holds the timer value for the virtual timer. This provides a 32-bit downcounter, see <a href="#">Operation of the TimerValue views of the timers on page B8-1965</a> . This register is a Generic Timer register.
<b>Usage constraints</b>	Accessible from Secure PL1 modes and Non-secure PL1 and PL2 modes. When <a href="#">CNTKCTL.PLOVTEN</a> is set to 1, also accessible from PL0 modes. For more information, see <a href="#">Accessing the timer registers on page B8-1964</a> . When <a href="#">CNTV_CTL.ENABLE</a> is set to 0: <ul style="list-style-type: none"><li>• a write to this register updates the register</li><li>• the value held in the register continues to decrement</li><li>• a read of the register returns an UNKNOWN value.</li></ul>
<b>Configurations</b>	Implemented only as part of the Generic Timers Extension. The VMSA, PMSA, and system level definitions of the register fields are identical. In an implementation that includes the Security Extensions, this register is Common.
<b>Attributes</b>	A 32-bit RW register with an UNKNOWN reset value. <a href="#">Table B8-2 on page B8-1967</a> shows the encodings of all of the Generic Timer registers.

The bit assignments of CNTV\_TVAL are identical to those of [CNTP\\_TVAL](#).

#### Accessing CNTV\_TVAL

To access CNTV\_TVAL, software reads or writes the CP15 registers with <opc1> set to 0, <CRn> set to c14, <CRm> set to c3, and <opc2> set to 0. For example:

```
MRC p15, 0, <Rt>, c14, c3, 0      ; Read CNTV_TVAL into Rt
MCR p15, 0, <Rt>, c14, c3, 0      ; Write Rt to CNTV_TVAL
```

### B4.1.34 CNTVCT, Virtual Count register, VMSA

The CNTVCT characteristics are:

**Purpose** Holds the 64-bit virtual count.

———— **Note** —————

The virtual count is obtained by subtracting the virtual offset from the physical count, see [The virtual counter on page B8-1961](#).

This register is a Generic Timer register.

**Usage constraints** Always accessible from Secure PL1 modes and Non-secure PL1 and PL2 modes. When CNTKCTL.PLOVCTEN is set to 1, is also accessible from Secure and Non-secure PL0 modes. For more information about the CNTVCT access controls see [Accessing the virtual counter on page B8-1961](#).

**Configurations** Implemented only as part of the Generic Timers Extension. The VMSA, PMSA, and system level definitions of the register fields are identical. In an implementation that includes the Security Extensions, this register is Common.

**Attributes** A 64-bit RO register with an UNKNOWN reset value. [Table B8-2 on page B8-1967](#) shows the encodings of all of the Generic Timer registers.

In an ARMv7 implementation, the CNTVCT bit assignments are:

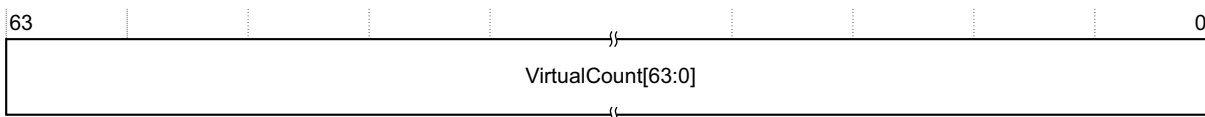

**VirtualCount, bits[63:0]**  
 Indicates the virtual count.

#### Accessing CNTVCT

To access CNTVCT, software performs a 64-bit read of the CP15 registers with <CRm> set to c14 and <opc1> set to 1. For example:

MRRC p15, 1, <Rt>, <Rt2>, c14 ; Read 64-bit CNTVCT into Rt (low word) and Rt2 (high word)

In the MRRC instruction, Rt holds the least-significant word of CNTVCT, and Rt2 holds the most-significant word.

### B4.1.35 CNTVOFF, Virtual Offset register, VMSA

The CNTVOFF characteristics are:

<b>Purpose</b>	Holds the 64-bit virtual offset. This register is a Generic Timer register.
<b>Usage constraints</b>	Only accessible from Hyp mode, or from Monitor mode when <code>SCR.NS</code> is set to 1, see <a href="#">PL2-mode system control registers on page B3-1454</a> .
<b>Configurations</b>	Implemented only as part of the Generic Timers Extension. This is a PL2-mode register, see <a href="#">Banked PL2-mode CP15 read/write registers on page B3-1454</a> . The implementation of this register depends on whether the implementation includes the Virtualization Extensions: <ul style="list-style-type: none"> <li>• If the implementation includes the Virtualization Extensions this is a RW register, accessible from Hyp mode, and from Monitor mode when <code>SCR.NS</code> is set to 1.</li> <li>• If the implementation includes the Security Extensions but not the Virtualization Extensions, an MCRR or MRRC to the CNTVOFF encoding is UNPREDICTABLE if executed in Monitor mode, regardless of the value of <code>SCR.NS</code>.</li> </ul> For more information, see <a href="#">Status of the CNTVOFF register on page B8-1968</a> . The VMSA and system level definitions of the register fields are identical.
<b>Attributes</b>	If the Virtualization Extensions are implemented, this is a 64-bit RW register with an UNKNOWN reset value. If the Virtualization Extensions are not implemented, for all purposes other than direct reads and writes this register behaves as if it contains the value 0. <a href="#">Table B8-2 on page B8-1967</a> shows the encodings of all of the Generic Timer registers.

In an ARMv7 implementation that also includes the Virtualization Extensions, the CNTVOFF bit assignments are:

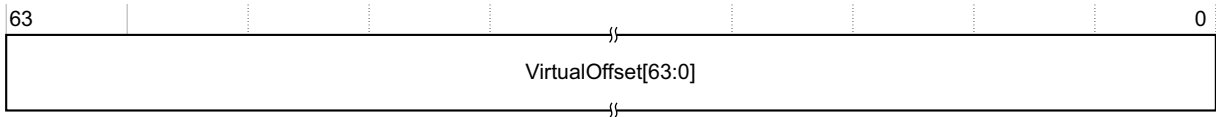

#### VirtualOffset, bits[63:0]

Indicates the virtual offset.

#### Accessing CNTVOFF

To access CNTVOFF, software performs a 64-bit read or write of the CP15 registers with `<CRm>` set to `c14` and `<opc1>` set to `4`. For example:

```
MRRC p15, 4, <Rt>, <Rt2>, c14 ; Read 64-bit CNTVOFF into Rt (low word) and Rt2 (high word)
MCRR p15, 4, <Rt>, <Rt2>, c14 ; Write Rt (low word) and Rt2 (high word) to 64-bit CNTVOFF
```

In these MRRC and MCRR instructions, `Rt` holds the least-significant word of CNTVOFF, and `Rt2` holds the most-significant word.

### B4.1.36 CONTEXTIDR, Context ID Register, VMSA

The CONTEXTIDR characteristics are:

- Purpose** CONTEXTIDR identifies the current *Process Identifier* (PROCID) and, when using the Short-descriptor translation table format, the *Address Space Identifier* (ASID).  
This register is part of the Virtual memory control registers functional group.
- Usage constraints** Only accessible from PL1 or higher.
- Configurations** The register format depends on whether address translation is using the Long-descriptor or the Short-descriptor translation table format.  
In an implementation that includes the Security Extensions, this register is Banked.
- Attributes** A 32-bit RW register with an UNKNOWN reset value. See also [Reset behavior of CP14 and CP15 registers on page B3-1450](#).  
[Table B3-45 on page B3-1493](#) shows the encodings of all of the registers in the Virtual memory control registers functional group.

In a VMSA implementation, the CONTEXTIDR bit assignments are:

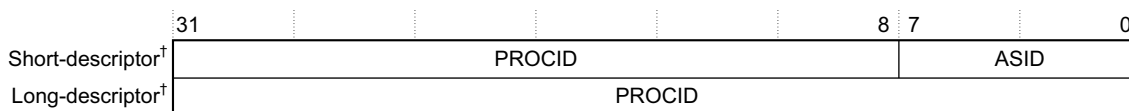

† Current translation table format

#### PROCID, bits[31:0], when using the Long-descriptor translation table format

#### PROCID, bits[31:8], when using the Short-descriptor translation table format

Process Identifier. This field must be programmed with a unique value that identifies the current process. See also [Using the CONTEXTIDR](#).

#### ASID, bits[7:0], when using the Short-descriptor translation table format

Address Space Identifier. This field is programmed with the value of the current ASID.

————— **Note** —————

When using the Long-descriptor translation table format, either [TTBR0](#) or [TTBR1](#) holds the current ASID.

### Using the CONTEXTIDR

The value of the whole of this register is called the *Context ID* and is used by:

- the debug logic, for Linked and Unlinked Context ID matching, see [Breakpoint debug events on page C3-2039](#) and [Watchpoint debug events on page C3-2057](#)
- the trace logic, to identify the current process.

The ASID field value is an identifier for a particular process. In the translation tables it identifies entries associated with a process, and distinguishes them from global entries. This means many cache and TLB maintenance operations take an ASID argument.

For information about the synchronization of changes to the CONTEXTIDR see [Synchronization of changes to system control registers on page B3-1461](#). There are particular synchronization requirements when changing the ASID and Translation Table Base Registers, see [Synchronization of changes of ASID and TTBR on page B3-1386](#).



## **Accessing the CONTEXTIDR**

To access the CONTEXTIDR, software reads or writes the CP15 registers with <opc1> set to 0, <CRn> set to c13, <CRm> set to c0, and <opc2> set to 1. For example:

```
MRC p15, 0, <Rt>, c13, c0, 1 ; Read CONTEXTIDR into Rt  
MCR p15, 0, <Rt>, c13, c0, 1 ; Write Rt to CONTEXTIDR
```

**B4.1.37 CP15DMB, CP15 Data Memory Barrier operation, VMSA**

*Data and instruction barrier operations, VMSA on page B4-1749* describes this deprecated CP15 barrier operation.

**B4.1.38 CP15DSB, CP15 Data Synchronization Barrier operation, VMSA**

*Data and instruction barrier operations, VMSA on page B4-1749* describes this deprecated CP15 barrier operation.

**B4.1.39 CP15ISB, CP15 Instruction Synchronization Barrier operation, VMSA**

*Data and instruction barrier operations, VMSA on page B4-1749* describes this deprecated CP15 barrier operation.

## B4.1.40 CPACR, Coprocessor Access Control Register, VMSA

The CPACR characteristics are:

<b>Purpose</b>	<p>The CPACR:</p> <ul style="list-style-type: none"> <li>Controls access to coprocessors CP0 to CP13 from PL0 and PL1.</li> <li>Is used to determine which, if any, of coprocessors CP0 to CP13 are implemented.</li> </ul> <p>This register is part of the Other system control registers functional group.</p>
<b>Usage constraints</b>	<p>Only accessible from PL1 or higher.</p> <p>In an implementation that includes the Virtualization Extensions, the CPACR has no effect on instructions executed in Hyp mode.</p> <p style="text-align: center;">———— <b>Note</b> ————</p> <p>In an implementation that includes the Virtualization Extensions, accesses to coprocessors other than CP14 and CP15, and to floating-point and Advanced SIMD functionality, from Hyp mode, are controlled by settings in the <a href="#">NSACR</a> and <a href="#">HCPTR</a>. The <a href="#">NSACR</a> settings take precedence over the <a href="#">HCPTR</a> settings.</p> <hr/>
<b>Configurations</b>	<p>If the implementation includes the Security Extensions, this is a Configurable access register, see <a href="#">Configurable access system control registers on page B3-1453</a>. Bits in the <a href="#">NSACR</a> control Non-secure access to the CPACR fields. See the field descriptions for more information.</p>
<b>Attributes</b>	<p>A 32-bit RW register. See the field descriptions for the reset values. See also <a href="#">Reset behavior of CP14 and CP15 registers on page B3-1450</a>.</p> <p><a href="#">Table B3-47 on page B3-1494</a> shows the encodings of all of the registers in the Other system control registers functional group.</p>

The CPACR bit assignments are:

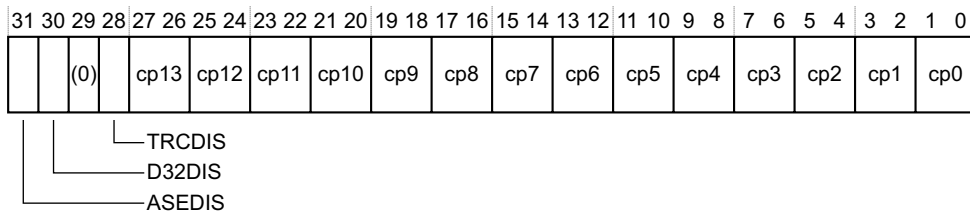

### ASEDIS, bit[31]

Disable Advanced SIMD functionality:

- 0** This bit does not cause any instructions to be UNDEFINED.
- 1** All instruction encodings identified in the [Alphabetical list of instructions on page A8-300](#) as being Advanced SIMD instructions, but that are not VFPv3 or VFPv4 instructions, are UNDEFINED when accessed from PL1 and PL0 modes.

———— **Note** ————

On an implementation that includes the Virtualization Extensions, when the [HCPTR.TASE](#) bit is set to 1, any use of these instructions from a Non-secure PL1 or PL0 mode, that is not UNDEFINED, is trapped to Hyp mode.

---

On an implementation that:

- Implements the Floating-point Extension and does not implement the Advanced SIMD Extension, this bit is RAO/WI.
- Does not implement the Floating-point Extension or the Advanced SIMD Extension, this bit is UNK/SBZP.

- Implements both the Floating-point Extension and the Advanced SIMD Extension, it is IMPLEMENTATION DEFINED whether this bit is supported. If it is not supported it is RAZ/WI.

If this bit is implemented as an RW bit:

- it resets to 0
- when `NSACR.NSASEDIS` is set to 1, it behaves as RAO/WI when accessed from Non-secure state.

#### D32DIS, bit[30]

Disable use of D16-D31 of the Floating-point Extension register file:

- 0** This bit does not cause any instructions to be UNDEFINED.
- 1** All instruction encodings identified in the [Alphabetical list of instructions on page A8-300](#) as being VFPv3 or VFPv4 instructions are UNDEFINED if they access any of registers D16-D31 when executed from a PL1 or PL0 mode.

If this bit is 1 when `CPACR.ASEDIS == 0`, the result is UNPREDICTABLE.

On an implementation that:

- Does not implement the Floating-point Extension, this bit is UNK/SBZP.
- Implements the Floating-point Extension and does not implement D16-D31, this bit is RAO/WI.
- Implements the Floating-point Extension and implements D16-D31, it is IMPLEMENTATION DEFINED whether this bit is supported. If it is not supported it is RAZ/WI.

If this bit is implemented as an RW bit:

- it resets to 0
- when `NSACR.NSD32DIS` is set to 1, it behaves as RAO/WI when accessed from Non-secure state.

**Bit[29]** Reserved, UNK/SBZP.

#### TRCDIS, bit[28]

Disable CP14 access to trace registers:

- 0** This bit does not cause any instructions to be UNDEFINED.
- 1** Any MRC or MCR instruction with coproc set to `0b1110` and `opc1` set to `0b001` is UNDEFINED when executed from a PL1 or PL0 mode.

#### ———— Note —————

On an implementation that includes the Virtualization Extensions, when the `HCPTR.TTA` bit is set to 1, any use of these instructions from a Non-secure PL1 or PL0 mode, that is not UNDEFINED, is trapped to Hyp mode.

On an implementation that:

- Does not include a trace macrocell, or does not include a CP14 interface to the trace macrocell registers, this bit is RAZ/WI.
- Includes a CP14 interface to trace macrocell registers, it is IMPLEMENTATION DEFINED whether this bit is supported. If it is not supported it is RAZ/WI.

If this bit is implemented as an RW bit:

- its reset value is UNKNOWN
- when `NSACR.NSTRCDIS` is set to 1, it behaves as RAO/WI when accessed from Non-secure state.

**cpn, bits[2n+1, 2n], for values of n from 0 to 13**

Defines the access rights for coprocessor n, for accesses from PL1 and PL0. The possible values of the field are:

0b00	Access denied. Any attempt to access the coprocessor generates an Undefined Instruction exception.
0b01	Access at PL1 only. Any attempt to access the coprocessor from software executing at PL0 generates an Undefined Instruction exception.
0b10	Reserved. The effect of this value is UNPREDICTABLE.
0b11	Full access. The meaning of full access is defined by the appropriate coprocessor.

**Note**

On an implementation that includes the Virtualization Extensions:

- The *Full access* setting for a cpn field, 0b11, cannot permit any accesses from PL2.
- When the corresponding [HCPTR.TCPn](#) bit is set to 1, any access to the coprocessor from a Non-secure PL1 or PL0 mode, that is not UNDEFINED, is trapped to Hyp mode.

For a coprocessor that is not implemented this field is RAZ/WI. Coprocessors 8, 9, 12, and 13 are reserved for future use by ARM, and therefore cp8, cp9, cp12, and cp13 are RAZ/WI.

If CPACR.cpn is implemented as RW, when [NSACR.cpn](#) is set to 0, CPACR.cpn behaves as RAZ/WI when accessed from Non-secure state.

When implemented as an RW field, cpn resets to zero.

In an implementation that includes the Security Extensions, the [NSACR](#) controls whether each coprocessor can be accessed from the Non-secure state. When the [NSACR](#) permits Non-secure access to a coprocessor, the CPACR determines the level of access permitted. Because the CPACR is not Banked, the options for Non-secure state access to a coprocessor are:

- no access
- identical access rights to the Secure state.

If more than one coprocessor is required to provide a particular set of functionality, then having different values for the CPACR fields for those coprocessors can lead to UNPREDICTABLE behavior. An example where this must be considered is with the Floating-point Extension. This uses CP10 and CP11.

In addition, in an implementation that includes the Security Extensions, the implementation of the [NSACR](#) {NSTRCDIS, NSASEDIS, NSD32DIS} bits must correspond to the implementation of the [CPACR](#) {TRCDIS, ASEDIS, D32DIS} bit, and implemented [NSACR](#) bits control Non-secure access to the associated functionality. For more information see the [NSACR](#) bit descriptions.

Typically, an operating system uses this register to control coprocessor resource sharing among applications:

- Initially all applications are denied access to the shared coprocessor-based resources.
- When an application attempts to use a resource it results in an Undefined Instruction exception.
- The Undefined Instruction exception handler can then grant access to the resource by setting the appropriate field in the CPACR.

Sharing resources among applications requires a state saving mechanism. Two possibilities are:

- during a context switch, if the last executing process or thread had access rights to a coprocessor then the operating system saves the state of that coprocessor
- on receiving a request for access to a coprocessor, the operating system saves the old state for that coprocessor with the last process or thread that accessed it.

For details of how software can use this register to check for implemented coprocessors see [Access controls on CP0 to CP13 on page B1-1226](#).

## Accessing the CPACR

To access the CPACR, software reads or writes the CP15 registers with <opc1> set to 0, <CRn> set to c1, <CRm> set to c0, and <opc2> set to 2. For example:

```
MRC p15, 0, <Rt>, c1, c0, 2 ; Read CPACR into Rt  
MCR p15, 0, <Rt>, c1, c0, 2 ; Write Rt to CPACR
```

Normally, software uses a read, modify, write sequence to update the CPACR, to avoid unwanted changes to the access settings for other coprocessors.

### B4.1.41 CSSELR, Cache Size Selection Register, VMSA

The CSSELR characteristics are:

**Purpose** The CSSELR selects the current [CCSIDR](#), by specifying:

- The required cache level.
- The cache type, either:
  - Instruction cache, if the memory system implements separate instruction and data caches.
  - Data cache. The data cache argument must be used for a unified cache.

This register is part of the Identification registers functional group.

**Usage constraints** Only accessible from PL1 or higher.

**Configurations** This register is not implemented in architecture versions before ARMv7.  
 If the implementation includes the Security Extensions, this register is Banked.

**Attributes** A 32-bit RW register with an UNKNOWN reset value. See also [Reset behavior of CP14 and CP15 registers on page B3-1450](#).  
[Table B3-44 on page B3-1492](#) shows the encodings of all of the registers in the Identification registers functional group.

The CSSELR bit assignments are:

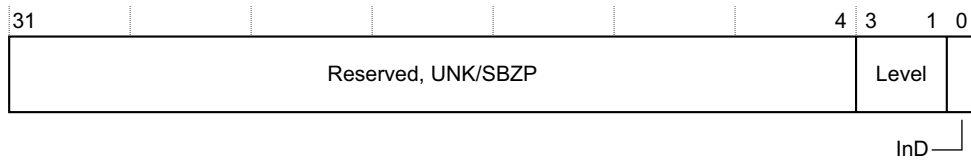

**Bits[31:4]** Reserved, UNK/SBZP.

**Level, bits[3:1]**

Cache level of required cache. Permitted values are from 0b000, indicating Level 1 cache, to 0b110 indicating Level 7 cache.

**InD, bit[0]** Instruction not Data bit. Permitted values are:

- 0 Data or unified cache
- 1 Instruction cache.

See the Note in [Access to registers from Monitor mode on page B3-1459](#) for a description of how [SCR.NS](#) controls whether Monitor mode accesses are to the Secure or Non-secure copy of the selected [CCSIDR](#).

#### Accessing CSSELR

To access CSSELR, software reads or writes the CP15 registers with <opc1> set to 2, <CRn> set to c0, <CRm> set to c0, and <opc2> set to 0. For example:

```
MRC p15, 2, <Rt>, c0, c0, 0 ; Read CSSELR into Rt
MCR p15, 2, <Rt>, c0, c0, 0 ; Write Rt to CSSELR
```





**L1Ip, bits[15:14]**

Level 1 instruction cache policy. Indicates the indexing and tagging policy for the L1 instruction cache. [Table B4-3](#) shows the possible values for this field.

**Table B4-3 Level 1 instruction cache policy field values**

L1Ip bits	L1 instruction cache indexing and tagging policy
00	Reserved
01	<i>ASID-tagged Virtual Index, Virtual Tag (AIVIVT)</i>
10	<i>Virtual Index, Physical Tag (VIPT)</i>
11	<i>Physical Index, Physical Tag (PIPT)</i>

**Bits[13:4]** RAZ.

**IminLine, bits[3:0]**

Log<sub>2</sub> of the number of words in the smallest cache line of all the instruction caches that are controlled by the processor.

**Accessing the CTR**

To access the CTR, software reads the CP15 registers with <opc1> set to 0, <CRn> set to c0, <CRm> set to c0, and <opc2> set to 1. For example

MRC p15, 0, <Rt>, c0, c0, 1 ; Read CTR into Rt

### B4.1.43 DACR, Domain Access Control Register, VMSA

The DACR characteristics are:

**Purpose** DACR defines the access permission for each of the sixteen memory domains. This register is part of the Virtual memory control registers functional group.

**Usage constraints** Only accessible from PL1 or higher.

**Configurations** If the implementation includes the Security Extensions, this register:

- is Banked
- has write access to the Secure copy of the register disabled when the **CP15SSDISABLE** signal is asserted HIGH.

In an implementation that includes the Large Physical Address Extension, this register has no function when **TTBCR.EAE** is set to 1, to select the Long-descriptor translation table format.

**Attributes** A 32-bit RW register with an UNKNOWN reset value. For more information see [Reset behavior of CP14 and CP15 registers on page B3-1450](#).  
[Table B3-45 on page B3-1493](#) shows the encodings of all of the registers in the Virtual memory control registers functional group.

The DACR bit assignments are:

31	30	29	28	27	26	25	24	23	22	21	20	19	18	17	16	15	14	13	12	11	10	9	8	7	6	5	4	3	2	1	0	
D15	D14	D13	D12	D11	D10	D9	D8	D7	D6	D5	D4	D3	D2	D1	D0																	

**Dn, bits[(2n+1):2n]**

Domain n access permission, where n = 0 to 15. Permitted values are:

- 0b00 No access. Any access to the domain generates a Domain fault.
- 0b01 Client. Accesses are checked against the permission bits in the translation tables.
- 0b10 Reserved, effect is UNPREDICTABLE.
- 0b11 Manager. Accesses are not checked against the permission bits in the translation tables.

For more information, see [Domains, Short-descriptor format only on page B3-1362](#).

#### Accessing the DACR

To access the DACR, software reads or writes the CP15 registers with <opc1> set to 0, <CRn> set to c3, <CRm> set to c0, and <opc2> set to 0. For example:

```
MRC p15, 0, <Rt>, c3, c0, 0 ; Read DACR into Rt
MCR p15, 0, <Rt>, c3, c0, 0 ; Write Rt to DACR
```

#### **B4.1.44 DCCIMVAC, Data Cache Clean and Invalidate by MVA to PoC, VMSA**

*Cache and branch predictor maintenance operations, VMSA on page B4-1740* describes this cache maintenance operation.

This operation is part of the Cache maintenance operations functional group. [Table B3-49 on page B3-1496](#) shows the encodings of all of the registers and operations in this functional group.

#### **B4.1.45 DCCISW, Data Cache Clean and Invalidate by Set/Way, VMSA**

*Cache and branch predictor maintenance operations, VMSA on page B4-1740* describes this cache maintenance operation.

This operation is part of the Cache maintenance operations functional group. [Table B3-49 on page B3-1496](#) shows the encodings of all of the registers and operations in this functional group.

#### **B4.1.46 DCCMVAC, Data Cache Clean by MVA to PoC, VMSA**

*Cache and branch predictor maintenance operations, VMSA on page B4-1740* describes this cache maintenance operation.

This operation is part of the Cache maintenance operations functional group. [Table B3-49 on page B3-1496](#) shows the encodings of all of the registers and operations in this functional group.

#### **B4.1.47 DCCMVAU, Data Cache Clean by MVA to PoU, VMSA**

*Cache and branch predictor maintenance operations, VMSA on page B4-1740* describes this cache maintenance operation.

This operation is part of the Cache maintenance operations functional group. [Table B3-49 on page B3-1496](#) shows the encodings of all of the registers and operations in this functional group.

#### **B4.1.48 DCCSW, Data Cache Clean by Set/Way, VMSA**

*Cache and branch predictor maintenance operations, VMSA on page B4-1740* describes this cache maintenance operation.

This operation is part of the Cache maintenance operations functional group. [Table B3-49 on page B3-1496](#) shows the encodings of all of the registers and operations in this functional group.

#### **B4.1.49 DCIMVAC, Data Cache Invalidate by MVA to PoC, VMSA**

*Cache and branch predictor maintenance operations, VMSA on page B4-1740* describes this cache maintenance operation.

This operation is part of the Cache maintenance operations functional group. [Table B3-49 on page B3-1496](#) shows the encodings of all of the registers and operations in this functional group.

#### **B4.1.50 DCISW, Data Cache Invalidate by Set/Way, VMSA**

*Cache and branch predictor maintenance operations, VMSA on page B4-1740* describes this cache maintenance operation.

This operation is part of the Cache maintenance operations functional group. [Table B3-49 on page B3-1496](#) shows the encodings of all of the registers and operations in this functional group.

### B4.1.51 DFAR, Data Fault Address Register, VMSA

The DFAR characteristics are:

- Purpose** The DFAR holds the VA of the faulting address that caused a synchronous Data Abort exception.  
This register is part of the PL1 Fault handling registers functional group.
- Usage constraints** Only accessible from PL1 or higher.
- Configurations** If the implementation includes the Security Extensions, this register is Banked.  
Before ARMv7 the DFAR was called the Fault Address Register (FAR).
- Attributes** A 32-bit RW register with an UNKNOWN reset value. See also [Reset behavior of CP14 and CP15 registers on page B3-1450](#).  
[Table B3-46 on page B3-1494](#) shows the encodings of all of the registers in the PL1 Fault handling registers functional group.

The DFAR bit assignments are:

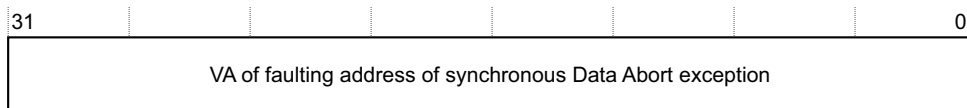

For information about using the DFAR, and when the value in the DFAR is valid, see [Exception reporting in a VMSA implementation on page B3-1409](#).

A debugger can write to the DFAR to restore its value.

#### Accessing the DFAR

To access the DFAR, software reads or writes the CP15 registers with <opc1> set to 0, <CRn> set to c6, <CRm> set to c0, and <opc2> set to 0. For example:

```
MRC p15, 0, <Rt>, c6, c0, 0 ; Read DFAR into Rt  
MCR p15, 0, <Rt>, c6, c0, 0 ; Write Rt to DFAR
```



**ExT, bit[12]** External abort type. This bit can provide an IMPLEMENTATION DEFINED classification of external aborts.  
 For aborts other than external aborts this bit always returns 0.  
 In an implementation that does not provide any classification of external aborts, this bit is UNK/SBZP.

**WnR, bit[11]** Write not Read bit. On a synchronous exception, indicates whether the abort was caused by a write or a read access. The possible values of this bit are:  
**0** Abort caused by a read access.  
**1** Abort caused by a write access.  
 For synchronous faults on CP15 cache maintenance operations, including the address translation operations, this bit always returns a value of 1.  
 This bit is UNKNOWN on:

- an asynchronous Data Abort exception
- a Data Abort exception caused by a debug exception.

**FS, bits[10, 3:0]** Fault status bits. For the valid encodings of these bits when using the Short-descriptor translation table format, see [Table B3-23 on page B3-1415](#). All encodings not shown in the table are reserved.

**LPAAE, bit[9], if the implementation includes the Large Physical Address Extension**  
 On taking a Data Abort exception, this bit is set to 0 to indicate use of the Short-descriptor translation table formats.  
 Hardware does not interpret this bit to determine the behavior of the memory system, and therefore software can set this bit to 0 or 1 without affecting operation. Unless the register has been updated to report a fault, a subsequent read of the register returns the value written to it.

**Bit[9], if the implementation does not include the Large Physical Address Extension**  
 Reserved, UNK/SBZP.

**Bit[8]** Reserved, UNK/SBZP.

**Domain, bits[7:4]**  
 The domain of the fault address.  
 ARM deprecates any use of this field, see [The Domain field in the DFSR on page B3-1415](#).  
 This field is UNKNOWN on a Data Abort exception:

- caused by a debug exception
- caused by a Permission fault in an implementation includes the Large Physical Address Extension.

**DFSR format when using the Long-descriptor translation table format**

In a VMSAv7 implementation that includes the Large Physical Address Extension, when address translation is using the Long-descriptor translation table format, the DFSR bit assignments are:

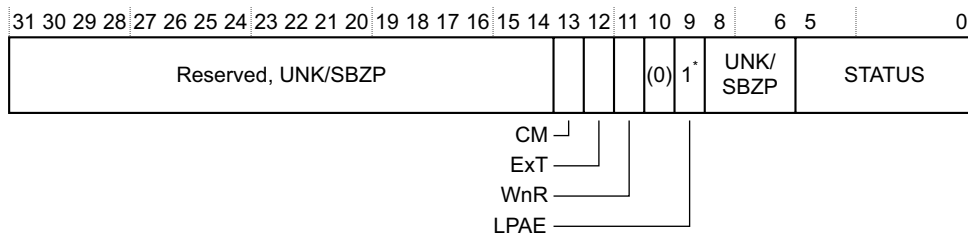

\* Returned value, but might be overwritten, because the bit is RW.

**Bits[31:14]** Reserved, UNK/SBZP.

- CM, bit[13]** Cache maintenance fault. For synchronous faults, this bit indicates whether a cache maintenance operation generated the fault. The possible values of this bit are:
- 0** Abort not caused by a cache maintenance operation.
  - 1** Abort caused by a cache maintenance operation.
- On an asynchronous fault, this bit is UNKNOWN.
- ExT, bit[12]** External abort type. This bit can provide an IMPLEMENTATION DEFINED classification of external aborts.
- For aborts other than external aborts this bit always returns 0.
- In an implementation that does not provide any classification of external aborts, this bit is UNK/SBZP.
- WnR, bit[11]** Write not Read bit. On a synchronous exception, indicates whether the abort was caused by a write or a read access. The possible values of this bit are:
- 0** Abort caused by a read access.
  - 1** Abort caused by a write access.
- For synchronous faults on CP15 cache maintenance operations, including the address translation operations, this bit always returns a value of 1.
- This bit is UNKNOWN on:
- an asynchronous Data Abort exception
  - a Data Abort exception caused by a debug exception.
- Bit[10]** Reserved, UNK/SBZP.
- LPAE, bit[9]** On taking a Data Abort exception, this bit is set to 1 to indicate use of the Long-descriptor translation table formats.
- Hardware does not interpret this bit to determine the behavior of the memory system, and therefore software can set this bit to 0 or 1 without affecting operation. Unless the register has been updated to report a fault, a subsequent read of the register returns the value written to it.
- Bits[8:6]** Reserved, UNK/SBZP.
- STATUS, bits[5:0]**
- Fault status bits. For the valid encodings of these bits when using the Long-descriptor translation table format, see [Table B3-24 on page B3-1416](#). All encodings not shown in the table are reserved.

### Accessing the DFSR

To access the DFSR, software reads or writes the CP15 registers with <opc1> set to 0, <CRn> set to c5, <CRm> set to c0, and <opc2> set to 0. For example:

```
MRC p15, 0, <Rt>, c5, c0, 0 ; Read DFSR into Rt
MCR p15, 0, <Rt>, c5, c0, 0 ; Write Rt to DFSR
```

#### **B4.1.53 DTLBIALL, Data TLB Invalidate All, VMSA only**

*TLB maintenance operations, not in Hyp mode on page B4-1743* describes this TLB maintenance operation.

This operation is part of the TLB maintenance operations functional group. [Table B3-50 on page B3-1497](#) shows the encodings of all of the registers and operations in this functional group.

#### **B4.1.54 DTLBIASID, Data TLB Invalidate by ASID, VMSA only**

*TLB maintenance operations, not in Hyp mode on page B4-1743* describes this TLB maintenance operation.

This operation is part of the TLB maintenance operations functional group. [Table B3-50 on page B3-1497](#) shows the encodings of all of the registers and operations in this functional group.

#### **B4.1.55 DTLBIMVA, Data TLB Invalidate by MVA, VMSA only**

*TLB maintenance operations, not in Hyp mode on page B4-1743* describes this TLB maintenance operation.

This operation is part of the TLB maintenance operations functional group. [Table B3-50 on page B3-1497](#) shows the encodings of all of the registers and operations in this functional group.



## B4.1.56 FCSEIDR, FCSE Process ID Register, VMSA

The FCSEIDR characteristics are:

- Purpose** The FCSEIDR identifies the current *Process ID* (PID) for the *Fast Context Switch Extension* (FCSE).  
 This register is part of the Other system control registers functional group.
- Usage constraints** Only accessible from PL1 or higher.  
 Access depends on whether the implementation includes the FCSE, see the **Attributes** description.  
 In an implementation that includes the Security Extensions, software must program the Non-secure copy of the register with the required initial value, as part of the processor boot sequence.
- Configurations** In an implementation that includes the Security Extensions:
- this register is Banked
  - if the implementation includes the FCSE, write access to the Secure copy of the FCSEIDR is disabled when the **CP15SDISABLE** signal is asserted HIGH.
- Attributes** A 32-bit register that:
- In an implementation that includes the FCSE, is RW and resets to zero. If the implementation also includes the Security Extensions, this reset value applies only to the Secure copy of the register.
  - In an implementation that does not include the FCSE, the register is RAZ/WI.
- See also [Reset behavior of CP14 and CP15 registers on page B3-1450](#).  
[Table B3-47 on page B3-1494](#) shows the encodings of all of the registers in the Other system control registers functional group.

In an implementation that includes the FCSE, the FCSEIDR bit assignments are:

31	25 24	0
PID	Reserved, UNK/SBZP	

### PID, bits[31:25]

The current Process ID, for the FCSE. If the FCSE is not implemented this field is RAZ/WI.

- Bits[24:0]** Reserved:
- in an implementation that includes the FCSE, this field is UNK/SBZP
  - if the FCSE is not implemented this field is RAZ/WI.

In ARMv7, the FCSE is OPTIONAL and deprecated, but the FCSEIDR must be implemented regardless of whether the implementation includes the FCSE. Software can access this register to determine whether the implementation includes the FCSE.

### Note

- Changing the PID changes the overall virtual-to-physical address mapping. Because of this, software must ensure that instructions that might have been speculatively fetched are not affected by the address mapping change.
- From ARMv6, ARM deprecates any use of the FCSE. The FCSE is:
  - OPTIONAL and deprecated in an ARMv7 implementation that does not include the Multiprocessing Extensions.
  - Obsolete from the addition of the Multiprocessing Extensions.

## **Accessing the FCSEIDR**

To access the FCSEIDR, software reads or writes the CP15 registers with <opc1> set to 0, <CRn> set to c13, <CRm> set to c0, and <opc2> set to 0. For example:

```
MRC p15, 0, <Rt>, c13, c0, 0 ; Read FCSEIDR into Rt  
MCR p15, 0, <Rt>, c13, c0, 0 ; Write Rt to FCSEIDR
```

## B4.1.57 FPEXC, Floating-Point Exception Control register, VMSA

The FPEXC register characteristics are:

<b>Purpose</b>	Provides a global enable for the Advanced SIMD and Floating-point (VFP) Extensions, and indicates how the state of these extensions is recorded.
<b>Usage constraints</b>	Only accessible by software executing at PL1 or higher. See <a href="#">Enabling Advanced SIMD and floating-point support on page B1-1228</a> for more information.
<b>Configurations</b>	<p>Implemented only if the implementation includes one or both of:</p> <ul style="list-style-type: none"> <li>• the Floating-point Extension</li> <li>• the Advanced SIMD Extension.</li> </ul> <p>In an implementation that includes the Security Extensions, <b>FPEXC</b> is a Configurable access register. When the settings in the <b>CPACR</b> permit access to the register:</p> <ul style="list-style-type: none"> <li>• it is accessible in Non-secure state only if the <b>NSACR</b>.{CP11, CP10} bits are both set to 1</li> <li>• if the implementation also includes the Virtualization Extensions then bits in the <b>HCPTR</b> also control Non-secure access to the register.</li> </ul> <p>For more information, see <a href="#">Access controls on CP0 to CP13 on page B1-1226</a>.</p> <p>The VFP subarchitecture might define additional bits in the FPEXC, see <a href="#">Additions to the Floating-Point Exception Register, FPEXC on page AppxF-2439</a>.</p>
<b>Attributes</b>	<p>A 32-bit RW register. See the register field descriptions for information about the reset value.</p> <p><a href="#">Table B1-24 on page B1-1235</a> shows the encodings of all of the Advanced SIMD and Floating-point Extension system registers.</p>

The FPEXC bit assignments are:

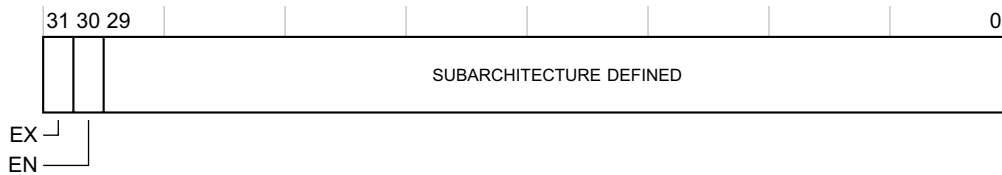

<b>EX, bit[31]</b>	<p>Exception bit. A status bit that specifies how much information must be saved to record the state of the Advanced SIMD and Floating-point system:</p> <p><b>0</b> The only significant state is the contents of the registers:</p> <ul style="list-style-type: none"> <li>• D0 - D15</li> <li>• D16 - D31, if implemented</li> <li>• <b>FPSCR</b></li> <li>• <b>FPEXC</b>.</li> </ul> <p>A context switch can be performed by saving and restoring the values of these registers.</p> <p><b>1</b> There is additional state that must be handled by any context switch system.</p> <p>The reset value of this bit is UNKNOWN.</p> <p>The behavior of the EX bit on writes is SUBARCHITECTURE DEFINED, except that in any implementation a write of 0 to this bit must be a valid operation, and must return a value of 0 if read back before any subsequent write to the register.</p>
--------------------	---

- EN, bit[30]** Enable bit. A global enable for the Advanced SIMD and Floating-point Extensions:
- 0** The Advanced SIMD and Floating-point Extensions are disabled. For details of how the system operates when EN == 0 see [Enabling Advanced SIMD and floating-point support on page B1-1228](#).
  - 1** The Advanced SIMD and Floating-point Extensions are enabled and operate normally. This bit is always a normal read/write bit. It has a reset value of 0.
- Bits[29:0]** SUBARCHITECTURE DEFINED. An implementation can use these bits to communicate exception information between the floating-point hardware and the support code. The subarchitectural definition of these bits includes their read/write access. This can be defined on a bit by bit basis. This means that the reset value of these bits is SUBARCHITECTURE DEFINED.
- A constraint on these bits is that if EX == 0 it must be possible to save and restore all significant state for the floating-point system by saving and restoring only the two Advanced SIMD and Floating-point Extension registers [FPSCR](#) and [FPEXC](#).

### Accessing the FPEXC register

Software reads or writes the [FPEXC](#) register using the VMRS and VMSR instructions. For more information, see [VMRS on page A8-954](#) and [VMSR on page A8-956](#). For example:

```
VMRS <Rt>, FPEXC      ; Read Floating-point Exception Control Register
VMSR FPEXC, <Rt>     ; Write Floating-point Exception Control Register
```

Writes to the [FPEXC](#) can have side-effects on various aspects of processor operation. All of these side-effects are synchronous to the [FPEXC](#) write. This means they are guaranteed not to be visible to earlier instructions in the execution stream, and they are guaranteed to be visible to later instructions in the execution stream.

## B4.1.58 FPSCR, Floating-point Status and Control Register, VMSA

The FPSCR characteristics are:

<b>Purpose</b>	Provides floating-point system status information and control.
<b>Usage constraints</b>	There are no usage constraints, but see <a href="#">Enabling Advanced SIMD and floating-point support on page B1-1228</a> for information about enabling access to this register.
<b>Configurations</b>	<p>Implemented only if the implementation includes one or both of:</p> <ul style="list-style-type: none"> <li>the Floating-point Extension</li> <li>the Advanced SIMD Extension.</li> </ul> <p>In an implementation that includes the Security Extensions, FPSCR is a Configurable access register. When the settings in the CPACR permit access to the register:</p> <ul style="list-style-type: none"> <li>it is accessible in Non-secure state only if the NSACR.{CP11, CP10} bits are both set to 1</li> <li>if the implementation also includes the Virtualization Extensions then bits in the HCPTR also control Non-secure access to the register.</li> </ul> <p>For more information, see <a href="#">Access controls on CP0 to CP13 on page B1-1226</a>.</p>
<b>Attributes</b>	<p>A 32-bit RW register. The reset value of the register fields are UNKNOWN except where the field descriptions indicate otherwise.</p> <p><a href="#">Table B1-24 on page B1-1235</a> shows the encodings of all of the Advanced SIMD and Floating-point Extension system registers.</p>

The FPSCR bit assignments are:

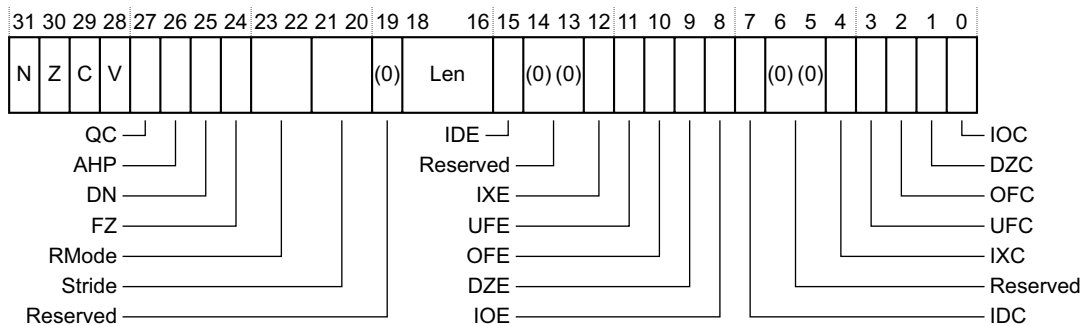

See the field descriptions for implementation differences in different VFP versions

**Bits[31:28]** Condition flags. These are updated by floating-point comparison operations, as shown in [Effect of a Floating-point comparison on the condition flags on page A2-80](#).

**N, bit[31]** Negative condition flag.

**Z, bit[30]** Zero condition flag.

**C, bit[29]** Carry condition flag.

**V, bit[28]** Overflow condition flag.

**Note**

Advanced SIMD operations never update these bits.

**QC, bit[27]** Cumulative saturation bit, Advanced SIMD only. This bit is set to 1 to indicate that an Advanced SIMD integer operation has saturated since 0 was last written to this bit. For details of saturation, see [Pseudocode details of saturation on page A2-44](#).

If the implementation does not include the Advanced SIMD Extension, this bit is UNK/SBZP.

- AHP, bit[26]** Alternative half-precision control bit:
- 0** IEEE half-precision format selected.
  - 1** Alternative half-precision format selected.
- For more information see [Advanced SIMD and Floating-point half-precision formats on page A2-66](#).
- If the implementation does not include the Half-precision Extension, this bit is UNK/SBZP.
- DN, bit[25]** Default NaN mode control bit:
- 0** NaN operands propagate through to the output of a floating-point operation.
  - 1** Any operation involving one or more NaNs returns the Default NaN.
- For more information, see [NaN handling and the Default NaN on page A2-69](#).
- The value of this bit only controls Floating-point arithmetic. Advanced SIMD arithmetic always uses the Default NaN setting, regardless of the value of the DN bit.
- FZ, bit[24]** Flush-to-zero mode control bit:
- 0** Flush-to-zero mode disabled. Behavior of the floating-point system is fully compliant with the IEEE 754 standard.
  - 1** Flush-to-zero mode enabled.
- For more information, see [Flush-to-zero on page A2-68](#).
- The value of this bit only controls Floating-point arithmetic. Advanced SIMD arithmetic always uses the Flush-to-zero setting, regardless of the value of the FZ bit.

**RMode, bits[23:22]**

Rounding Mode control field. The encoding of this field is:

- 0b00 *Round to Nearest (RN) mode*
- 0b01 *Round towards Plus Infinity (RP) mode*
- 0b10 *Round towards Minus Infinity (RM) mode*
- 0b11 *Round towards Zero (RZ) mode.*

The specified rounding mode is used by almost all floating-point instructions that are part of the Floating-point Extension. Advanced SIMD arithmetic always uses the Round to Nearest setting, regardless of the value of the RMode bits.

———— **Note** —————

The rounding mode names are based on the IEEE 754-1985 terminology. See [Floating-point standards, and terminology on page A2-55](#) for the corresponding terms in the IEEE 754-2008 revision of the standard.

**Stride, bits[21:20] and Len, bits[18:16]**

ARM deprecates use of nonzero values of these fields. For details of their use in previous versions of the ARM architecture see [Appendix K VFP Vector Operation Support](#).

The values of these fields are ignored by the Advanced SIMD Extension.

**Bits[19, 14:13, 6:5]**

Reserved, UNK/SBZP.

**Bits[15, 12:8]** Floating-point exception trap enable bits. These bits are supported only in VFPv2, VFPv3U, and VFPv4U. They are reserved, RAZ/WI, on a system that implements VFPv3 or VFPv4.

The possible values of each bit are:

- 0** Untrapped exception handling selected. If the floating-point exception occurs then the corresponding cumulative exception bit is set to 1.
- 1** Trapped exception handling selected. If the floating-point exception occurs, hardware does not update the corresponding cumulative exception bit. The trap-handling software can decide whether to set the cumulative exception bit to 1.

The values of these bits control only Floating-point arithmetic. Advanced SIMD arithmetic always uses untrapped exception handling, regardless of the values of these bits.

For more information, see [Floating-point exceptions on page A2-70](#).

The floating-point trap enable bits are:

**IDE, bit[15]** Input Denormal exception trap enable.

———— **Note** ————

Denormal corresponds to the term denormalized number in the IEEE 754-1985 standard. [Floating-point standards, and terminology on page A2-55](#) describes the terminology changes in the IEEE 754-2008 revision of the standard.

**IXE, bit[12]** Inexact exception trap enable.

**UFE, bit[11]** Underflow exception trap enable.

**OFE, bit[10]** Overflow exception trap enable.

**DZE, bit[9]** Division by Zero exception trap enable.

**IOE, bit[8]** Invalid Operation exception trap enable.

**Bits[7, 4:0]** Cumulative exception bits for floating-point exceptions. Each of these bits is set to 1 to indicate that the corresponding exception has occurred since 0 was last written to it. How floating-point instructions update these bits depends on the value of the corresponding exception trap enable bits, see the description of bits[15, 12:8].

Advanced SIMD instructions set each cumulative exception bit if the corresponding exception occurs in one or more of the floating-point calculations performed by the instruction, regardless of the setting of the trap enable bits.

For more information, see [Floating-point exceptions on page A2-70](#).

**IDC, bit[7]** Input Denormal cumulative exception bit. Updated by hardware only when IDE, bit[15], is set to 0.

**IXC, bit[4]** Inexact cumulative exception bit. Updated by hardware only when IXE, bit[12], is set to 0.

**UFC, bit[3]** Underflow cumulative exception bit. Updated by hardware only when UFE, bit[11], is set to 0.

**OFC, bit[2]** Overflow cumulative exception bit. Updated by hardware only when OFE, bit[10], is set to 0.

**DZC, bit[1]** Division by Zero cumulative exception bit. Updated by hardware only when DZE, bit[9], is set to 0.

**IOC, bit[0]** Invalid Operation cumulative exception bit. Updated by hardware only when IOE, bit[8], is set to 0.

If the implementation includes the integer-only Advanced SIMD Extension and does not include the Floating-point Extension, all of these bits except QC are UNK/SBZP.

Writes to the FPSCR can have side-effects on various aspects of processor operation. All of these side-effects are synchronous to the FPSCR write. This means they are guaranteed not to be visible to earlier instructions in the execution stream, and they are guaranteed to be visible to later instructions in the execution stream.

## Accessing the FPSCR

Software reads or writes the FPSCR, or transfers the FPSCR.{N, Z, C, V} flags to the APSR, using the VMRS and VMSR instructions. For more information, see [VMRS on page A8-954](#) and [VMSR on page A8-956](#). For example:

```
VMRS <Rt>, FPSCR      ; Read Floating-point System Control Register
VMSR FPSCR, <Rt>      ; Write Floating-point System Control Register
VMRS APSR_nzcv, FPSCR ; Write FPSCR.{N, Z, C, V} flags to APSR.{N, Z, C, V}
```

## B4.1.59 FPSID, Floating-point System ID Register, VMSA

The FPSID register characteristics are:

<b>Purpose</b>	Provides top-level information about the floating-point implementation.
<b>Usage constraints</b>	Only accessible from PL1 or higher. See <a href="#">Enabling Advanced SIMD and floating-point support on page B1-1228</a> for more information. This register complements the information provided by the CPUID scheme described in <a href="#">Chapter B7 The CPUID Identification Scheme</a> .
<b>Configurations</b>	FPSID can be implemented in a system that provides only software emulation of the ARM floating-point instructions, and must be implemented if the implementation includes one or both of: <ul style="list-style-type: none"> <li>• the Floating-point Extension</li> <li>• the Advanced SIMD Extension.</li> </ul> <p>The VMSA and PMSA definitions of the register fields are identical.</p> <p>In an implementation that includes the Security Extensions, FPSID is a Configurable access register. When the settings in the CPACR permit access to the register:</p> <ul style="list-style-type: none"> <li>• it is accessible in Non-secure state only if the NSACR.{CP11, CP10} bits are both set to 1</li> <li>• if the implementation also includes the Virtualization Extensions then bits in the HCPTR also control Non-secure access to the register.</li> </ul> <p>For more information, see <a href="#">Access controls on CP0 to CP13 on page B1-1226</a>.</p>
<b>Attributes</b>	A 32-bit RO register.

———— **Note** —————

Although the FPSID is a RO register, a write using the FPSID encoding is a valid *serializing* operation, see [Asynchronous bounces, serialization, and Floating-point exception barriers on page B1-1237](#). Such a write does not access the register.

[Table B1-24 on page B1-1235](#) shows the encodings of all of the Advanced SIMD and Floating-point Extension system registers.

In ARMv7, the FPSID bit assignments are:

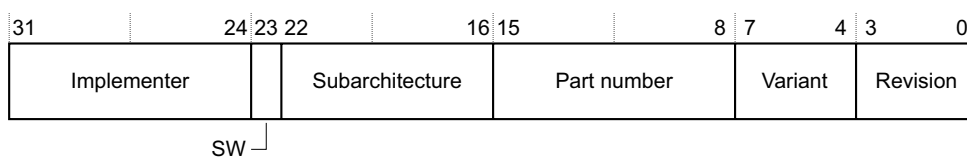

### Implementer, bits[31:24]

Implementer codes are the same as those used for the MIDR.

For an implementation by ARM this field is 0x41, the ASCII code for A.

### SW, bit[23]

Software bit. This bit indicates whether a system provides only software emulation of the floating-point instructions that are provided by the Floating-point Extension:

- 0** The system includes hardware support for the floating-point instructions provided by the Floating-point Extension.
- 1** The system provides only software emulation of the floating-point instructions provided by the Floating-point Extension.



### Subarchitecture, bits[22:16]

Subarchitecture version number. For an implementation by ARM, permitted values are:

0b0000000 VFPv1 architecture with an IMPLEMENTATION DEFINED subarchitecture.  
Not permitted in an ARMv7 implementation.

0b0000001 VFPv2 architecture with Common VFP subarchitecture v1.  
Not permitted in an ARMv7 implementation.

0b0000010 VFPv3 architecture, or later, with Common VFP subarchitecture v2. The VFP architecture version is indicated by the [MVFR0](#) and [MVFR1](#) registers.

0b0000011 VFPv3 architecture, or later, with no subarchitecture. The entire floating-point implementation is in hardware, and no software support code is required. The VFP architecture version is indicated by the [MVFR0](#) and [MVFR1](#) registers.

This value can be used only by an implementation that does not support the trap enable bits in the [FPSCR](#).

0b0000100 VFPv3 architecture, or later, with Common VFP subarchitecture v3. The VFP architecture version is indicated by the [MVFR0](#) and [MVFR1](#) registers.

For a subarchitecture designed by ARM the most significant bit of this field, register bit[22], is 0. Values with a most significant bit of 0 that are not listed here are reserved.

When the subarchitecture designer is not ARM, the most significant bit of this field, register bit[22], must be 1. Each implementer must maintain its own list of subarchitectures it has designed, starting at subarchitecture version number 0x40.

### Part number, bits[15:8]

An IMPLEMENTATION DEFINED part number for the floating-point implementation, assigned by the implementer.

### Variant, bits[7:4]

An IMPLEMENTATION DEFINED variant number. Typically, this field distinguishes between different production variants of a single product.

### Revision, bits[3:0]

An IMPLEMENTATION DEFINED revision number for the floating-point implementation.

## Accessing the FPSID register

Software accesses the FPSID register using the VMRS instruction, see [VMRS on page B9-2012](#). For example:

```
VMRS <Rt>, FPSID ; Read FPSID into Rt
```

## B4.1.60 HACR, Hyp Auxiliary Configuration Register, Virtualization Extensions

The HACR characteristics are:

<b>Purpose</b>	The HACR controls the trapping to Hyp mode of IMPLEMENTATION DEFINED aspects of Non-secure PL1 or PL0 operation. This register is part of the Virtualization Extensions registers functional group.
<b>Usage constraints</b>	Only accessible from Hyp mode, or from Monitor mode when <a href="#">SCR.NS</a> is set to 1, see <a href="#">PL2-mode system control registers on page B3-1454</a> .
<b>Configurations</b>	Implemented only as part of the Virtualization Extensions. This is Banked PL2-mode register, see <a href="#">Banked PL2-mode CP15 read/write registers on page B3-1454</a> .
<b>Attributes</b>	A 32-bit RW register with an IMPLEMENTATION DEFINED reset value. See also <a href="#">Reset behavior of CP14 and CP15 registers on page B3-1450</a> . <a href="#">Table B3-55 on page B3-1501</a> shows the encoding of all of the Virtualization Extensions registers.

The HACR bit assignments are IMPLEMENTATION DEFINED.

### Accessing the HACR

To access the HACR, software reads or writes the CP15 registers with <opc1> set to 4, <CRn> set to c1, <CRm> set to c1, and <opc2> set to 7. For example:

```
MRC p15, 4, <Rt>, c1, c1, 7 ; Read HACR into Rt  
MCR p15, 4, <Rt>, c1, c1, 7 ; Write Rt to HACR
```

## B4.1.61 HACTLR, Hyp Auxiliary Control Register, Virtualization Extensions

The HACTLR characteristics are:

<b>Purpose</b>	The HACTLR controls IMPLEMENTATION DEFINED features of Hyp mode operation. This register is part of the Virtualization Extensions registers functional group.
<b>Usage constraints</b>	Only accessible from Hyp mode, or from Monitor mode when <a href="#">SCR.NS</a> is set to 1, see <a href="#">PL2-mode system control registers on page B3-1454</a> .
<b>Configurations</b>	Implemented only as part of the Virtualization Extensions. This is PL2-mode register, see <a href="#">Banked PL2-mode CP15 read/write registers on page B3-1454</a> .
<b>Attributes</b>	A 32-bit RW register with an IMPLEMENTATION DEFINED reset value. See also <a href="#">Reset behavior of CP14 and CP15 registers on page B3-1450</a> . <a href="#">Table B3-55 on page B3-1501</a> shows the encoding of all of the Virtualization Extensions registers.

The HACTLR bit assignments are IMPLEMENTATION DEFINED.

### Accessing the HACTLR

To access the HACTLR, software reads or writes the CP15 registers with <opc1> set to 4, <CRn> set to c1, <CRm> set to c0, and <opc2> set to 1. For example:

```
MRC p15, 4, <Rt>, c1, c0, 1 ; Read HACTLR into Rt  
MCR p15, 4, <Rt>, c1, c0, 1 ; Write Rt to HACTLR
```

## B4.1.62 HADFSR and HAIFSR, Hyp Auxiliary Fault Syndrome Registers, Virtualization Extensions

The Hyp Auxiliary Data Fault Syndrome Register, HADFSR, and Hyp Auxiliary Instruction Fault Syndrome Register, HAIFSR, characteristics are:

<b>Purpose</b>	The HAXFSR contain additional IMPLEMENTATION DEFINED syndrome information for: <ul style="list-style-type: none"><li>• Data Abort exceptions taken to Hyp mode, for the HADFSR</li><li>• Prefetch Abort exceptions taken to Hyp mode, for the HAIFSR.</li></ul> These registers are part of the Virtualization Extensions registers functional group.
<b>Usage constraints</b>	Only accessible from Hyp mode, or from Monitor mode when SCR.NS is set to 1, see <a href="#">PL2-mode system control registers on page B3-1454</a> .
<b>Configurations</b>	Implemented only as part of the Virtualization Extensions. These are optional registers. An implementation that does not require one or both of these registers can implement the registers that are not required as UNK/SBZP. These are Banked PL2-mode register, see <a href="#">Banked PL2-mode CP15 read/write registers on page B3-1454</a> .
<b>Attributes</b>	32-bit RW registers with UNKNOWN reset values. See also <a href="#">Reset behavior of CP14 and CP15 registers on page B3-1450</a> . <a href="#">Table B3-55 on page B3-1501</a> shows the encoding of all of the Virtualization Extensions registers.

The HADFSR and HAIFSR bit assignments are IMPLEMENTATION DEFINED.

### Accessing the HADFSR and HAIFSR

To access the HADFSR or HAIFSR, software reads or writes the CP15 registers with <opc1> set to 4, <CRn> set to c5, <CRm> set to c1, and <opc2> set to 0 for the HADFSR, or to 1 for the HAIFSR. For example:

```
MRC p15, 4, <Rt>, c5, c1, 0 ; Read HADFSR into Rt
MCR p15, 4, <Rt>, c5, c1, 0 ; Write Rt to HADFSR
MRC p15, 4, <Rt>, c5, c1, 1 ; Read HAIFSR into Rt
MCR p15, 4, <Rt>, c5, c1, 1 ; Write Rt to HAIFSR
```

## B4.1.63 HMAIR0 and HMAIR1, Hyp Auxiliary Memory Attribute Indirection Registers 0 and 1

The HMAIR0 and HMAIR1 characteristics are

<b>Purpose</b>	<p>The HMAIR0 and HMAIR1 registers provide IMPLEMENTATION DEFINED memory attributes for the memory attribute encodings defined by the HMAIR0 and HMAIR1 registers.</p> <p>These IMPLEMENTATION DEFINED attributes can only provide additional qualifiers for the memory attribute encodings, and cannot change the memory attributes defined in the HMAIR0 and HMAIR1 registers.</p> <p>These registers are part of the Virtualization Extensions registers functional group.</p>
<b>Usage constraints</b>	<p>Only accessible from Hyp mode, or from Monitor mode when SCR.NS is set to 1, see <a href="#">PL2-mode system control registers on page B3-1454</a>.</p> <p>If an implementation does not provide any IMPLEMENTATION DEFINED memory attributes these registers are UNK/SBZP.</p>
<b>Configurations</b>	<p>Implemented only as part of the Virtualization Extensions.</p> <p>These are Banked PL2-mode registers, see <a href="#">Banked PL2-mode CP15 read/write registers on page B3-1454</a>.</p>
<b>Attributes</b>	<p>32-bit RW registers with an UNKNOWN reset values. See also <a href="#">Reset behavior of CP14 and CP15 registers on page B3-1450</a>.</p> <p><a href="#">Table B3-55 on page B3-1501</a> shows the encoding of all of the Virtualization Extensions registers.</p>

The the HMAIRn registers bit assignments are IMPLEMENTATION DEFINED.

### ———— Note —————

Although all aspects of the HMAIRn register bit assignments are IMPLEMENTATION DEFINED, a likely usage model is that the two HMAIRn registers provide eight 8-bit fields, indexed by the AttrIdx[2:0] value from the translation table descriptor, as described for the HMAIR registers.

### Accessing the HMAIR0 or HMAIR1

To access the HMAIR0 or HMAIR1, software reads or writes the CP15 registers with <opc1> set to 4, <CRn> set to c10, <CRm> set to c3, and <opc2> set to 0 for HMAIR0, or to 1 for HMAIR1. For example:

```
MRC p15, 4, <Rt>, c10, c3, 0 ; Read HMAIR0 into Rt
MCR p15, 4, <Rt>, c10, c3, 1 ; Write Rt to HMAIR1
```

## B4.1.64 HCPTR, Hyp Coprocessor Trap Register, Virtualization Extensions

The HCPTR characteristics are:

**Purpose** The HCPTR controls the trapping to Hyp mode of Non-secure accesses, at PL1 or lower, to coprocessors other than CP14 and CP15, and to floating-point and Advanced SIMD functionality. It also controls the access to coprocessors other than CP14 and CP15, and to floating-point and Advanced SIMD functionality, from Hyp mode.

———— **Note** ————

Accesses to coprocessors other than CP14 and CP15, and to floating-point and Advanced SIMD functionality, from Hyp mode:

- Are not affected by settings in the [CPACR](#).
- Are affected by settings in the [NSACR](#), and the [NSACR](#) settings take precedence over the HCPTR settings. See the Usage Constraints for more information.

This register is part of the Virtualization Extensions registers functional group.

**Usage constraints** Only accessible from Hyp mode, or from Monitor mode when [SCR.NS](#) is set to 1, see [PL2-mode system control registers on page B3-1454](#).

If a bit in the [NSACR](#) prohibits a Non-secure access, then the corresponding bit in the HCPTR behaves as RAO/WI for Non-secure accesses. See the bit descriptions for more information.

**Configurations** Implemented only as part of the Virtualization Extensions.

This is Banked PL2-mode register, see [Banked PL2-mode CP15 read/write registers on page B3-1454](#).

**Attributes** A 32-bit RW register that resets to zero. See also [Reset behavior of CP14 and CP15 registers on page B3-1450](#).

[Table B3-55 on page B3-1501](#) shows the encoding of all of the Virtualization Extensions registers.

The HCPTR bit assignments are:

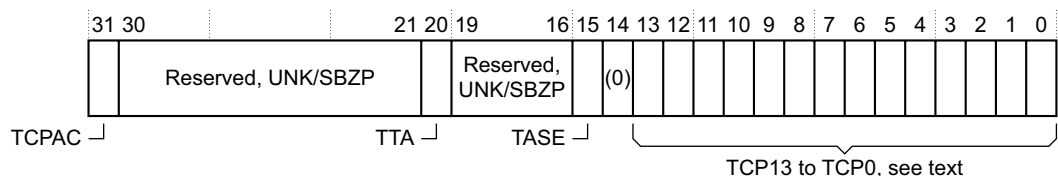

In the descriptions of the HCPTR fields, an *otherwise-valid Non-secure access* means an access that, if the bit was set to 0, would not be UNDEFINED or UNPREDICTABLE.

For more information about all of these bits see [Trapping accesses to coprocessors on page B1-1256](#).

For more information about control of access to functionality provided by the Advanced SIMD and Floating-point Extensions, see [Enabling Advanced SIMD and floating-point support on page B1-1228](#).

### TCPAC, bit[31]

Trap [CPACR](#) accesses. The possible values of this bit are:

- 0** Has no effect on accesses to the [CPACR](#).
- 1** Any access to the [CPACR](#) from a Non-secure PL1 mode generates an exception that is taken to Hyp mode. For more information, see [Trapping CPACR accesses on page B1-1257](#).

**Bits[30:21]** Reserved, UNK/SBZP.

- TTA, bit[20]** Trap Trace Access. The possible values of this bit are:
- 0** Has no effect on accesses to the CP14 trace registers from Non-secure PL1 and PL2 modes.
  - 1** Any otherwise-valid access to the CP14 trace registers from a Non-secure PL1 mode generates an exception that is taken to Hyp mode. For more information see [Trapping CP14 accesses to trace registers on page B1-1260](#).  
Any access to the CP14 trace registers from Non-secure Hyp mode is UNDEFINED.

———— **Note** —————

The [NSACR.NSTRCDIS](#) bit can make this bit behave as RAO/WI, regardless of its actual value.

In an implementation that does not include a trace macrocell, or does not include a CP14 interface to the trace macrocell registers, it is IMPLEMENTATION DEFINED whether this bit:

- is RAO/WI
- can be written from Hyp mode, and from Secure Monitor mode when [SCR.NS](#) is set to 1.

**Bits[19:16]** Reserved, UNK/SBZP.

**TASE, bit[15]** Trap Advanced SIMD Extension use. The possible values of this bit are:

- 0** Has no effect on accesses to Advanced SIMD functionality from Non-secure PL2, PL1 and PL0 modes.
- 1** Any otherwise-valid access to Advanced SIMD functionality from a Non-secure PL1 or PL0 mode generates an exception that is taken to Hyp mode. For more information, see [Trapping of Advanced SIMD functionality on page B1-1256](#).  
Any access to Advanced SIMD functionality from Hyp mode is UNDEFINED. This means that any instruction encoding that [Alphabetical list of instructions on page A8-300](#) identifies as being an Advanced SIMD instruction but does not also identify as being a VFPv3 or VFPv4 instruction, is UNDEFINED if executed in Hyp mode.

———— **Note** —————

- If [TCP10](#) and [TCP11](#) are set to 1 then all otherwise-valid Advanced SIMD use by Non-secure PL1 and PL0 modes is trapped to Hyp mode, regardless of the value of this field.
- The [NSACR.NSASEDIS](#) bit can make this bit behave as RAO/WI, regardless of its actual value.

For more information, see [Summary of access controls for Advanced SIMD functionality on page B1-1232](#).

On an implementation that:

- Implements the Floating-point Extension but does not implement the Advanced SIMD Extension, this bit is RAO/WI.
- Does not implement the Floating-point Extension or the Advanced SIMD Extension, this bit is RAO/WI.
- Implements both the Floating-point Extension and the Advanced SIMD Extension, it is IMPLEMENTATION DEFINED whether this bit is supported. If it is not supported, it is RAZ/WI.

**Bit[14]** Reserved, UNK/SBZP.

### TCP $n$ , bit[ $n$ ], for values of $n$ from 0 to 13

Trap coprocessor  $n$  (CP $n$ ). For each bit, the possible values are:

- 0** Has no effect on accesses to coprocessor CP $n$  from Non-secure PL2, PL1 and PL0 modes.
- 1** Any otherwise-valid Non-secure access to CP $n$  generates an exception that is taken to Hyp mode. For more information, see [General trapping of coprocessor accesses on page B1-1257](#).  
Any access to the coprocessor from Hyp mode is UNDEFINED.

For more information, see [Summary of general controls of CP10 and CP11 functionality on page B1-1230](#).

#### ———— Note —————

Each NSACR.cpn bit can make the corresponding HCPTR.TCP $n$  bit behave as RAO/WI, regardless of its actual value.

For values of  $n$  that correspond to coprocessors that are not implemented, it is IMPLEMENTATION DEFINED whether TCP $n$ :

- is RAO/WI
- can be written by software that has write access to HCPTR.

Coprocessors 8, 9, 12, and 13 are reserved for possible use by ARM, and therefore are never implemented.

If a set of functionality requires the use of more than one coprocessor, then setting the TCP $n$  bits corresponding to those coprocessors to different values can cause UNPREDICTABLE behavior. For example, since CP10 and CP11 provide the Floating-point Extension and Advanced SIMD Extension functionality, TCP10 and TCP11 must be set to the same value.

### Accessing the HCPTR

To access the HCPTR, software reads or writes the CP15 registers with <opc1> set to 4, <CRn> set to c1, <CRm> set to c1, and <opc2> set to 2. For example:

```
MRC p15, 4, <Rt>, c1, c1, 2 ; Read HCPTR into Rt  
MCR p15, 4, <Rt>, c1, c1, 2 ; Write Rt to HCPTR
```

### B4.1.65 HCR, Hyp Configuration Register, Virtualization Extensions

The HCR characteristics are:

- Purpose** The HCR provides configuration controls for virtualization, including defining whether various Non-secure operations are trapped to Hyp mode.  
 This register is part of the Virtualization Extensions registers functional group.
- Usage constraints** Only accessible from Hyp mode, or from Monitor mode when `SCR.NS` is set to 1, see [PL2-mode system control registers on page B3-1454](#).
- Configurations** Implemented only as part of the Virtualization Extensions.  
 This is Banked PL2-mode register, see [Banked PL2-mode CP15 read/write registers on page B3-1454](#).
- Attributes** A 32-bit RW register that resets to zero. See also [Reset behavior of CP14 and CP15 registers on page B3-1450](#).  
[Table B3-55 on page B3-1501](#) shows the encoding of all of the Virtualization Extensions registers.

The HCR bit assignments are:

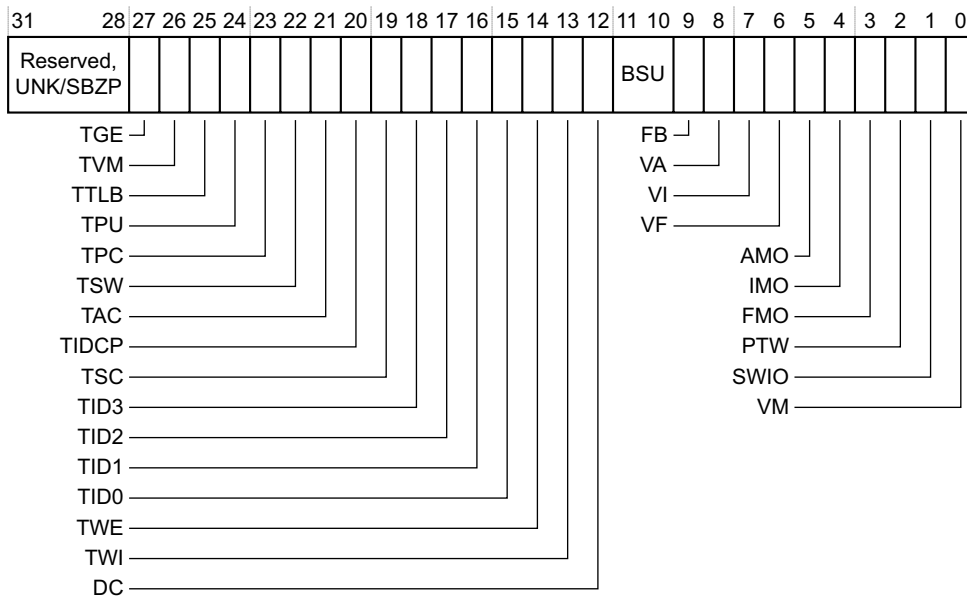

In the descriptions of the HCR fields:

- Descriptions of bits describe the effect of setting the bit to 1. If the bit is set to 0 it has no effect on the operation of the processor.
- A *valid Non-secure PL1 or PL0 access* means an access from a Non-secure PL1 or PL0 mode that, if the bit was set to 0, would not be UNDEFINED or UNPREDICTABLE.

**Bits[31:28]** Reserved, UNK/SBZP.

**TGE, bit[27]** Trap general exceptions. When this bit is set to 1, and the processor is executing at PL0 in Non-secure state, Undefined Instruction exceptions, Supervisor Call exceptions, synchronous External aborts, and some Alignment faults, are taken to Hyp mode. For more information see [Routing general exceptions to Hyp mode on page B1-1191](#).

**TVM, bit[26]** Trap virtual memory controls. When this bit is set to 1, any valid Non-secure PL1 or PL0 write to a virtual memory control register is trapped to Hyp mode. For more information see [Trapping writes to virtual memory control registers on page B1-1257](#).



- TTLB, bit[25]** Trap TLB maintenance operations. When this bit is set to 1, any valid Non-secure PL1 or PL0 access to a TLB maintenance operation is trapped to Hyp mode. For more information see [Trapping accesses to TLB maintenance operations on page B1-1253](#).
- TPU, bit[24]** Trap cache maintenance to point of unification operations. When this bit is set to 1, any valid Non-secure PL1 or PL0 access to a cache maintenance operation that operates to the point of unification is trapped to Hyp mode. For more information see [Trapping accesses to cache maintenance operations on page B1-1253](#).
- TPC, bit[23]** Trap cache maintenance to point of coherency operations. When this bit is set to 1, any valid Non-secure PL1 or PL0 access to a cache maintenance operation that operates to the point of coherency is trapped to Hyp mode. For more information see [Trapping accesses to cache maintenance operations on page B1-1253](#)....
- TSW, bit[22]** Trap set/way cache maintenance operations. When this bit is set to 1, any valid Non-secure PL1 or PL0 access to a cache maintenance operation that operates by set/way is trapped to Hyp mode. For more information see [Trapping accesses to cache maintenance operations on page B1-1253](#).
- TAC, bit[21]** Trap **ACTLR** accesses. When this bit is set to 1, any valid Non-secure PL1 or PL0 access to the **ACTLR** is trapped to Hyp mode. For more information see [Trapping accesses to the Auxiliary Control Register on page B1-1253](#).
- TIDCP, bit[20]**  
Trap lockdown. When this bit is set to 1, any valid Non-secure PL1 or PL0 access to a CP15 lockdown, DMA, or TCM operation, is trapped to Hyp mode. For more information, including the handling of Non-secure accesses at PL0, see [Trapping accesses to lockdown, DMA, and TCM operations on page B1-1252](#).
- TSC, bit[19]** Trap SMC instruction. When this bit is set to 1, attempts to execute SMC instructions in Non-secure PL1 modes are trapped to Hyp mode. For more information, including the interaction with the **SCR.SCD** bit, see [Trapping use of the SMC instruction on page B1-1254](#).
- TIDn, for values of n from 3 to 0, bits[18:15]**  
Trap ID register groups. When one of these bits is set to 1, any valid Non-secure read of a register in the corresponding group is trapped to Hyp mode. For more information, including the registers in each group, see [Trapping ID mechanisms on page B1-1250](#).  
TID3 is bit[18], TID2 is bit[17], TID1 is bit[16], and TID0 is bit[15].
- TWE, bit[14]** Trap WFE instruction. When this bit is set to 1, any attempt, from a Non-secure PL1 or PL0 mode, to execute an WFE instruction that might otherwise cause the processor to suspend execution is trapped to Hyp mode. For more information see [Trapping use of the WFI and WFE instructions on page B1-1255](#).
- TW1, bit[13]** Trap WFI instruction. When this bit is set to 1, any attempt, from a Non-secure PL1 or PL0 mode, to execute an WFI instruction that might otherwise cause the processor to suspend execution is trapped to Hyp mode. For more information see [Trapping use of the WFI and WFE instructions on page B1-1255](#).
- DC, bit[12]** Default cacheable. When the Non-secure PL1&0 stage 1 MMU is disabled, this bit affects the memory type and attributes determined by a Non-secure PL1&0 stage 1 translation. For more information see [VMSA behavior when a stage 1 MMU is disabled on page B3-1314](#).
- BSU, bits[11:10]**  
Barrier shareability upgrade. When this field is nonzero, it upgrades the required shareability of DMB and DSB barrier instructions executed in a Non-secure PL1 or PL0 mode, beyond the effect specified in the instruction. For more information, including the encoding of this field, see [Shareability and access limitations on the data barrier operations on page A3-152](#).

**FB, bit[9]** Force broadcast. When this bit is set to 1, TLB maintenance operations, branch predictor invalidate all operations, and instruction cache invalidate all operations performed in Non-secure PL1 modes, are broadcast across the Inner Shareable domain. For more information see [Virtualization Extensions upgrading of maintenance operations on page B2-1286](#) and [Virtualization Extensions upgrading of TLB maintenance operations on page B3-1391](#).

#### Virtual asynchronous exception bits, bits[8:6]

Subject to other controls, when one of these bits is set to 1 the corresponding virtual asynchronous exception is generated when the processor is executing in Non-secure state at PL1 or PL0. For more information see [Virtual exceptions in the Virtualization Extensions on page B1-1196](#).

The virtual asynchronous exception bits are:

**VA, bit[8]** Virtual asynchronous abort.

**VI, bit[7]** Virtual IRQ.

**VF, bit[6]** Virtual FIQ.

#### Mask override bits, bits[5:3]

Setting one of these bits to 1 can modify the effect of the corresponding **CPSR** exception mask bit when the processor is in Non-secure state. For more information see [Asynchronous exception masking on page B1-1183](#).

The mask override bits are:

**AMO, bit[5]** Overrides the **CPSR.A** bit, and enables signaling by the VA bit.

**IMO, bit[4]** Overrides the **CPSR.I** bit, and enables signaling by the VI bit.

**FMO, bit[3]** Overrides the **CPSR.F** bit, and enables signaling by the VF bit.

#### ———— Note ————

These bits also affect the signaling of virtual asynchronous exceptions.

**PTW, bit[2]** Protected table walk. When this bit is set to 1 it enables the generation of a stage 2 Permission fault on a memory access made as part of a stage 1 translation table lookup in the Non-secure PL1&0 translation regime if the stage 2 translation of the access address assigns the Device or Strongly-ordered attribute. For more information see [Stage 2 fault on a stage 1 translation table walk, Virtualization Extensions on page B3-1402](#).

**SWIO, bit[1]** Set/way invalidation override. When this bit is set to 1, it forces invalidate by set/way operations executed in a Non-secure PL1 mode to be treated as clean and invalidate by set/way operations. For more information see [Virtualization Extensions upgrading of maintenance operations on page B2-1286](#).

**VM, bit[0]** Virtualization MMU enable bit. This is a global enable bit for the PL1&0 stage 2 MMU. The possible values of this bit are:

**0** PL1&0 stage 2 MMU disabled.

For more information see [The effects of disabling MMUs on VMSA behavior on page B3-1314](#).

**1** PL1&0 stage 2 MMU enabled.

## Accessing the HCR

To access the HCR, software reads or writes the CP15 registers with <opc1> set to 4, <CRn> set to c1, <CRm> set to c1, and <opc2> set to 0. For example:

MRC p15, 4, <Rt>, c1, c1, 0 ; Read HCR into Rt

MCR p15, 4, <Rt>, c1, c1, 0 ; Write Rt to HCR

## B4.1.66 HDCR, Hyp Debug Configuration Register, Virtualization Extensions

The HDCR characteristics are:

<b>Purpose</b>	The HDCR controls the trapping to Hyp mode of Non-secure accesses, at PL1 or lower, to functions provided by the debug and trace architectures. This register is part of the Virtualization Extensions registers functional group.
<b>Usage constraints</b>	Only accessible from Hyp mode, or from Monitor mode when <code>SCR.NS</code> is set to 1, see <a href="#">PL2-mode system control registers on page B3-1454</a> .
<b>Configurations</b>	Implemented only as part of the Virtualization Extensions. This is Banked PL2-mode register, see <a href="#">Banked PL2-mode CP15 read/write registers on page B3-1454</a> .
<b>Attributes</b>	A 32-bit RW register. See the field descriptions for the reset value of the register. See also <a href="#">Reset behavior of CP14 and CP15 registers on page B3-1450</a> . <a href="#">Table B3-55 on page B3-1501</a> shows the encoding of all of the Virtualization Extensions registers.

The HDCR bit assignments are:

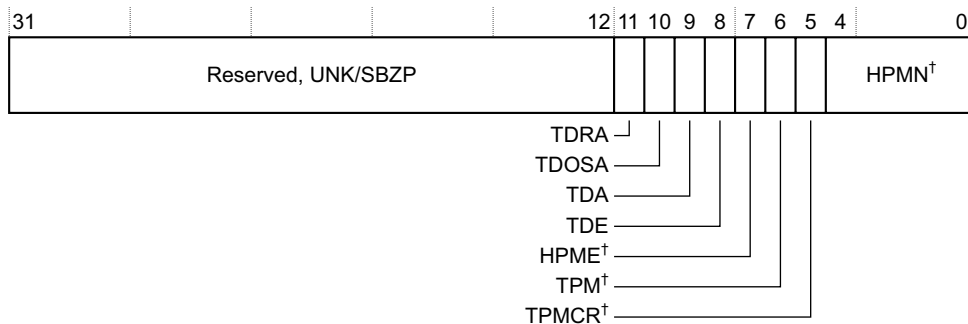

† Only on an implementation that includes the Performance Monitors Extension.  
 For more information, see the field description.

In the descriptions of the HDCR fields, a *valid Non-secure access* means an access from a Non-secure PL1 or PL0 mode that, if the bit was set to 0, would not be UNDEFINED or UNPREDICTABLE.

<b>Bits[31:12]</b>	Reserved, UNK/SBZP.
<b>TDRA, bit[11]</b>	Trap Debug ROM access. When this bit is set to 1, any valid Non-secure access to the <a href="#">DBGDRAR</a> or <a href="#">DBGDSAR</a> is trapped to Hyp mode. For more information, including dependencies on the values of other HDCR bits, see <a href="#">Trapping CP14 accesses to Debug ROM registers on page B1-1259</a> . This bit resets to 0.
<b>TDOSA, bit[10]</b>	Trap debug OS-related register access. When this bit is set to 1, any valid Non-secure CP14 access to the OS-related registers is trapped to Hyp mode. For more information, including dependencies on the values of other HDCR bits and a summary of the OS-related registers, see <a href="#">Trapping CP14 accesses to OS-related debug registers on page B1-1259</a> . This bit resets to 0.
<b>TDA, bit[9]</b>	Trap debug access. When this bit is set to 1, any valid Non-secure access to the CP14 Debug registers, other than the registers trapped by the TDRA and TDOSA bits, is trapped to Hyp mode. For more information, including dependencies on the values of other HDCR bits, see <a href="#">Trapping general CP14 accesses to debug registers on page B1-1260</a> . This bit resets to 0.

**TDE, bit[8]** Trap Debug exceptions. When this bit is set to 1, any Debug exception taken to Non-secure state is routed to Hyp mode. For more information, including dependencies on the values of other HDCR bits, see [Routing Debug exceptions to Hyp mode on page B1-1193](#).  
This bit resets to 0.

**Bits[7:0], on an implementation that does not include the Performance Monitors Extension**

Reserved, UNK/SBZP.

**HPME, bit[7], on an implementation that includes the Performance Monitors Extension**

Hypervisor Performance Monitors Enable. The possible values of this bit are:

- 0** Hyp mode Performance Monitors counters disabled.
- 1** Hyp mode Performance Monitors counters enabled.

When this bit is set to 1, the Performance Monitors counters that are reserved for use from Hyp mode are enabled. For more information see the description of the HPMN field and [Counter enables on page C12-2311](#).

The reset value of this bit is UNKNOWN.

**TPM, bit[6], on an implementation that includes the Performance Monitors Extension**

Trap Performance Monitors accesses. The possible values of this bit are:

- 0** Has no effect on Performance Monitors accesses.
- 1** Trap valid Non-secure Performance Monitors accesses to Hyp mode.

When this bit is set to 1, any valid Non-secure access to the Performance Monitors registers is trapped to Hyp mode. For more information see [Trapping accesses to the Performance Monitors Extension on page B1-1254](#).

This bit resets to 0.

**TPMCR, bit[5], on an implementation that includes the Performance Monitors Extension**

Trap **PMCR** accesses. The possible values of this bit are:

- 0** Has no effect on **PMCR** accesses.
- 1** Trap valid Non-secure **PMCR** accesses to Hyp mode.

When this bit is set to 1, any valid Non-secure access to the **PMCR** is trapped to Hyp mode. For more information see [Trapping accesses to the Performance Monitors Extension on page B1-1254](#).

This bit resets to 0.

**HPMN, bits[4:0], on an implementation that includes the Performance Monitors Extension**

Defines the number of Performance Monitors counters that are accessible from Non-secure PL1 modes, and from Non-secure PL0 modes if unprivileged access is enabled.

In Non-secure state, HPMN divides the Performance Monitors counters as follows. If **PMXEVCNTR** is accessing Performance Monitors counter  $n$  then, in Non-secure state:

- If  $n$  is in the range  $0 \leq n < \text{HPMN}$ , the counter is accessible from PL1 and PL2, and from PL0 if unprivileged access to the counters is enabled.
- If  $n$  is in the range  $\text{HPMN} \leq n < \text{PMCR.N}$ , the counter is accessible only from PL2. The HPME bit enables the operation of the counters in this range.

The behavior of the Performance Monitors counters is UNPREDICTABLE if this field is set zero, or to a value greater than **PMCR.N**.

For more information see [Counter access on page C12-2312](#).

This field resets to the value of **PMCR.N**.

**Permitted combinations of {TDRA, TDOSA, TDA, TDE} bits**

The permitted values of the HDCR.{TDRA, TDOSA, TDA, TDE} bits are 0b0000, 0b0100, 0b1000, 0b1100, 0b1110, and 0b1111. If these bits are set to any other values, behavior is UNPREDICTABLE.

## **Accessing the HDCR**

To access the HDCR, software reads or writes the CP15 registers with <opc1> set to 4, <CRn> set to c1, <CRm> set to c1, and <opc2> set to 1. For example:

```
MRC p15, 4, <Rt>, c1, c1, 1 ; Read HDCR into Rt  
MCR p15, 4, <Rt>, c1, c1, 1 ; Write Rt to HDCR
```

## B4.1.67 HDFAR, Hyp Data Fault Address Register, Virtualization Extensions

The HDFAR characteristics are:

- Purpose** The HDFAR holds the VA of the faulting address that caused a synchronous Data Abort exception that is taken to Hyp mode.  
 This register is part of the Virtualization Extensions registers functional group.
- Usage constraints** Only accessible from Hyp mode, or from Monitor mode when SCR.NS is set to 1, see [PL2-mode system control registers on page B3-1454](#).  
 Any execution in a Non-secure PL1 mode, or in Secure state, makes the HDFAR UNKNOWN.
- Configurations** Implemented only as part of the Virtualization Extensions.  
 This is PL2-mode register, see [Banked PL2-mode CP15 read/write registers on page B3-1454](#).  
 This register is shared with the Secure copy of the DFAR, and the CP15 encoding for the HDFAR provides Hyp mode access to an alias of the Secure DFAR, see [PL2-mode encodings for shared CP15 registers on page B3-1456](#).
- Attributes** A 32-bit RW register with an UNKNOWN reset value. See also [Reset behavior of CP14 and CP15 registers on page B3-1450](#).  
[Table B3-55 on page B3-1501](#) shows the encoding of all of the Virtualization Extensions registers.

The HDFAR bit assignments are:

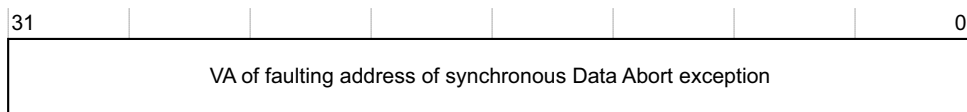

**VA, bits[31:0]** The VA of the address used in the access that faulted, generating a synchronous Data Abort exception.

### Accessing the HDFAR

To access the HDFAR, software reads or writes the CP15 registers with <opc1> set to 4, <CRn> set to c6, <CRm> set to c0, and <opc2> set to 0. For example:

```
MRC p15, 4, <Rt>, c6, c0, 0 ; Read HDFAR into Rt
MCR p15, 4, <Rt>, c6, c0, 0 ; Write Rt to HDFAR
```

## B4.1.68 HIFAR, Hyp Instruction Fault Address Register, Virtualization Extensions

The HIFAR characteristics are:

<b>Purpose</b>	The HIFAR holds the VA of the faulting address that caused a synchronous Prefetch Abort exception that is taken to Hyp mode. This register is part of the Virtualization Extensions registers functional group.
<b>Usage constraints</b>	Only accessible from Hyp mode, or from Monitor mode when <a href="#">SCR.NS</a> is set to 1, see <a href="#">PL2-mode system control registers on page B3-1454</a> . Any execution in a Non-secure PL1 mode, or in Secure state, makes the HIFAR UNKNOWN.
<b>Configurations</b>	Implemented only as part of the Virtualization Extensions. This is PL2-mode register, see <a href="#">Banked PL2-mode CP15 read/write registers on page B3-1454</a> . This register is shared with the Secure copy of the <a href="#">IFAR</a> , and the CP15 encoding for the HIFAR provides Hyp mode access to an alias of the Secure <a href="#">IFAR</a> , see <a href="#">PL2-mode encodings for shared CP15 registers on page B3-1456</a> .
<b>Attributes</b>	A 32-bit RW register with an UNKNOWN reset value. See also <a href="#">Reset behavior of CP14 and CP15 registers on page B3-1450</a> . <a href="#">Table B3-55 on page B3-1501</a> shows the encoding of all of the Virtualization Extensions registers.

The HIFAR bit assignments are:

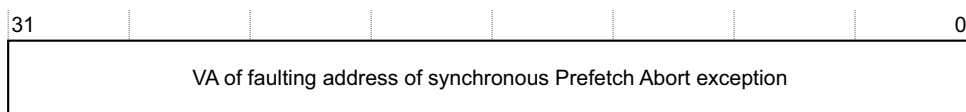

**VA, bits[31:0]** The VA of the instruction address used in the instruction fetch that faulted, generating a synchronous Prefetch Abort exception.

### Accessing the HIFAR

To access the HIFAR, software reads or writes the CP15 registers with <opc1> set to 4, <CRn> set to c6, <CRm> set to c0, and <opc2> set to 2. For example:

```
MRC p15, 4, <Rt>, c6, c0, 2 ; Read HIFAR into Rt
MCR p15, 4, <Rt>, c6, c0, 2 ; Write Rt to HIFAR
```

## B4.1.69 HMAIRn, Hyp Memory Attribute Indirection Registers 0 and 1, Virtualization Extensions

The HMAIR0 and HMAIR1 characteristics are:

**Purpose** The HMAIR0 and HMAIR1 registers provide the memory attribute encodings corresponding to the possible AttrIdx values in a translation table entry for stage 1 translations for memory accesses from Hyp mode. For more information about the AttrIdx field, see [Long-descriptor format memory region attributes on page B3-1372](#).

———— **Note** —————

Memory accesses from Hyp mode always use the Long-descriptor translation table format.

These registers are part of the Virtualization Extensions registers functional group.

**Usage constraints** Only accessible from Hyp mode, or from Monitor mode when SCR.NS is set to 1, see [PL2-mode system control registers on page B3-1454](#).

AttrIdx[2], from the translation table descriptor, selects the appropriate HMAIR:

- setting AttrIdx[2] to 0 selects HMAIR0
- setting AttrIdx[2] to 1 selects HMAIR1.

**Configurations** Implemented only as part of the Virtualization Extensions.

These are Banked PL2-mode registers, see [Banked PL2-mode CP15 read/write registers on page B3-1454](#).

**Attributes** 32-bit RW registers with an UNKNOWN reset values. See also [Reset behavior of CP14 and CP15 registers on page B3-1450](#).

[Table B3-55 on page B3-1501](#) shows the encoding of all of the Virtualization Extensions registers.

The HMAIRn bit assignments and encodings are identical to those for MAIRn.

### Accessing the HMAIR0 or HMAIR1

To access the HMAIR0 or HMAIR1, software reads or writes the CP15 registers with <opc1> set to 4, <CRn> set to c10, <CRm> set to c2, and <opc2> set to 0 for HMAIR0, or to 1 for HMAIR1. For example:

```
MRC p15, 4, <Rt>, c10, c2, 0 ; Read HMAIR0 into Rt
MCR p15, 4, <Rt>, c10, c2, 1 ; Write Rt to HMAIR1
```



### B4.1.70 HPFAR, Hyp IPA Fault Address Register, Virtualization Extensions

The HPFAR characteristics are:

- Purpose** For some aborts on a stage 2 translation, taken to Hyp mode, HPFAR holds the faulting IPA. This register is part of the Virtualization Extensions registers functional group.
- Usage constraints** Only accessible from Hyp mode, or from Monitor mode when `SCR.NS` is set to 1, see [PL2-mode system control registers on page B3-1454](#). Execution in any Non-secure mode other than Hyp mode makes this register UNKNOWN.
- Configurations** Implemented only as part of the Virtualization Extensions. This is Banked PL2-mode register, see [Banked PL2-mode CP15 read/write registers on page B3-1454](#).
- Attributes** A 32-bit RW register with an UNKNOWN reset value. See also [Reset behavior of CP14 and CP15 registers on page B3-1450](#). [Table B3-55 on page B3-1501](#) shows the encoding of all of the Virtualization Extensions registers.

The HPFAR bit assignments are:

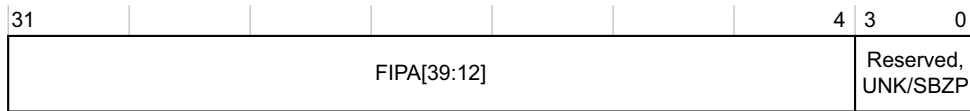

#### FIPA, bits[31:4]

Bits[39:12] of the faulting IPA.

**Bits[3:0]** Reserved, UNK/SBZP.

#### Accessing the HPFAR

To access the HPFAR, software reads or writes the CP15 registers with `<opc1>` set to 4, `<CRn>` set to c6, `<CRm>` set to c0, and `<opc2>` set to 4. For example:

```
MRC p15, 4, <Rt>, c6, c0, 4 ; Read HPFAR into Rt
MCR p15, 4, <Rt>, c6, c0, 4 ; Write Rt to HPFAR
```

## B4.1.71 HSCTLR, Hyp System Control Register, Virtualization Extensions

The HSCTLR characteristics are:

- Purpose** The HSCTLR provides top level control of the system operation in Hyp mode. This register provides Hyp mode control of features controlled by the Banked SCTL R bits, and shows the values of the non-Banked SCTL R bits.
- This register is part of the Virtualization Extensions registers functional group.
- Usage constraints** Only accessible from Hyp mode, or from Monitor mode when SCR.NS is set to 1, see [PL2-mode system control registers on page B3-1454](#).
- Configurations** Implemented only as part of the Virtualization Extensions.
- This is Banked PL2-mode register, see [Banked PL2-mode CP15 read/write registers on page B3-1454](#).
- Attributes** A 32-bit RW register with an UNKNOWN reset value. See also [Reset behavior of CP14 and CP15 registers on page B3-1450](#).
- [Table B3-55 on page B3-1501](#) shows the encoding of all of the Virtualization Extensions registers.

The HSCTLR bit assignments are:

31	30	29	28	27	26	25	24	23	22	21	20	19	18	17	16	15	14	13	12	11	10	9	8	7	6	5	4	3	2	1	0
(0)	(1)	(1)	(0)	(0)			(0)	(1)	(1)	FI	(0)		(1)	(0)	(1)	(0)	(0)	(0)	I	(1)	(0)	(0)	(0)	(0)	(1)		(1)	(1)	C	A	M
TE ↵		EE ↵				WXN ↵				CP15BEN ↵																					

- Bit[31]** Reserved, UNK/SBZP.
- TE, bit[30]** Thumb Exception enable. This bit controls whether exceptions taken to Hyp mode are taken in ARM or Thumb state. The possible values of this bit are:
- 0 Exceptions taken in ARM state
  - 1 Exceptions taken in Thumb state.
- For more information about the use of this bit see [Instruction set state on exception entry on page B1-1181](#).
- Bits[29:28]** Reserved, UNK/SBOP.
- Bits[27:26]** Reserved, UNK/SBZP.
- EE, bit[25]** Exception Endianness bit. The value of this bit defines the value of the CPSR.E bit on entry to an exception vector in Hyp mode. This value also indicates the endianness of the translation table data for translation table lookups for the Non-secure PL1&0 stage 2 and PL2 stage 1 address translations. The possible values of this bit are:
- 0 Little-endian.
  - 1 Big-endian.
- Bit[24]** Reserved, UNK/SBZP.
- Bits[23:22]** Reserved, UNK/SBOP.
- FI, bit[21]** Fast interrupts configuration enable bit. The possible values of this bit are:
- 0 All performance features enabled.
  - 1 Low interrupt latency configuration. Some performance features disabled.
- Setting this bit to 1 can reduce interrupt latency in an implementation by disabling IMPLEMENTATION DEFINED performance features.
- This is a read-only bit that takes the value of the SCTL R.FI bit.
- For more information, see [Low interrupt latency configuration on page B1-1197](#).

- Bit[20]** Reserved, UNK/SBZP.
- WXN, bit[19]** Write permission implies XN. The possible values of this bit are:  
**0** Hyp translations that permit write are not forced to XN.  
**1** Hyp translations that permit write are forced to XN.  
For more information see [Preventing execution from writable locations on page B3-1361](#).
- Bit[18]** Reserved, UNK/SBOP.
- Bit[17]** Reserved, UNK/SBZP.
- Bit[16]** Reserved, UNK/SBOP.
- Bits[15:13]** Reserved, UNK/SBZP.
- I, bit[12]** Instruction cache enable bit: This is a global enable bit for instruction caches, for memory accesses made in Hyp mode. The possible values of this bit are:  
**0** Instruction caches disabled.  
**1** Instruction caches enabled.  
If the system does not implement any instruction caches that can be accessed by the processor, at any level of the memory hierarchy, this bit is RAZ/WI.  
If the system implements any instruction caches that can be accessed by the processor then it must be possible to disable them by setting this bit to 0.  
For more information see [Cache enabling and disabling on page B2-1270](#).
- Bit[11]** Reserved, UNK/SBOP.
- Bits[10:7]** Reserved, UNK/SBZP.
- Bit[6]** Reserved, UNK/SBOP.
- CP15BEN, bit[5]**  
CP15 barrier enable. If implemented, this is an enable bit for use of the CP15 DMB, DSB, and ISB barrier operations from Hyp mode:  
**0** CP15 barrier operations disabled. Their encodings are UNDEFINED.  
**1** CP15 barrier operations enabled.  
This bit is optional. If not implemented, bit[5] is RAO/WI. However, it must be implemented if [SCTLR.CP15BEN](#) is implemented.
- **Note** —————  
[SCTLR.CP15BEN](#) controls the use of these operations from PL1 and PL0 modes.
- For more information about these operations see [Data and instruction barrier operations, VMSA on page B4-1749](#).
- Bits[4:3]** Reserved, UNK/SBOP.
- C, bit[2]** Cache enable bit. This is a global enable bit for data and unified caches, for memory accesses made in Hyp mode. The possible values of this bit are:  
**0** Data or unified caches disabled.  
**1** Data or unified caches enabled.  
If the system does not implement any data or unified caches that can be accessed by the processor, at any level of the memory hierarchy, this bit is RAZ/WI.  
If the system implements any data or unified caches that can be accessed by the processor then it must be possible to disable them by setting this bit to 0.  
For more information see [Cache enabling and disabling on page B2-1270](#).

- A, bit[1]** Alignment bit. This is the enable bit for Alignment fault checking, for memory accesses made in Hyp mode. The possible values of this bit are:
- 0** Alignment fault checking disabled.
  - 1** Alignment fault checking enabled.
- For more information, see [Unaligned data access on page A3-108](#).
- M, bit[0]** MMU enable bit. This is a global enable bit for the PL2 stage 1 MMU. The possible values of this bit are:
- 0** PL2 stage 1 MMU disabled.
  - 1** PL2 stage 1 MMU enabled.
- For more information, see [The effects of disabling MMUs on VMSA behavior on page B3-1314](#).

### Accessing the HSCTLR

To access the HSCTLR, software reads or writes the CP15 registers with <opc1> set to 4, <CRn> set to c1, <CRm> set to c0, and <opc2> set to 0. For example:

```
MRC p15, 4, <Rt>, c1, c0, 0 ; Read HSCTLR into Rt  
MCR p15, 4, <Rt>, c1, c0, 0 ; Write Rt to HSCTLR
```

## B4.1.72 HSR, Hyp Syndrome Register, Virtualization Extensions

The HSR characteristics are:

<b>Purpose</b>	The HSR holds syndrome information for an exception taken to Hyp mode. This register is part of the Virtualization Extensions registers functional group.
<b>Usage constraints</b>	Only accessible from Hyp mode, or from Monitor mode when <a href="#">SCR.NS</a> is set to 1, see <a href="#">PL2-mode system control registers on page B3-1454</a> . Execution in any Non-secure mode other than Hyp mode makes this register UNKNOWN.
<b>Configurations</b>	Implemented only as part of the Virtualization Extensions. This is Banked PL2-mode register, see <a href="#">Banked PL2-mode CP15 read/write registers on page B3-1454</a> .
<b>Attributes</b>	A 32-bit RW register with an UNKNOWN reset value. See also <a href="#">Reset behavior of CP14 and CP15 registers on page B3-1450</a> . <a href="#">Table B3-55 on page B3-1501</a> shows the encoding of all of the Virtualization Extensions registers.

The HSR bit assignments are:

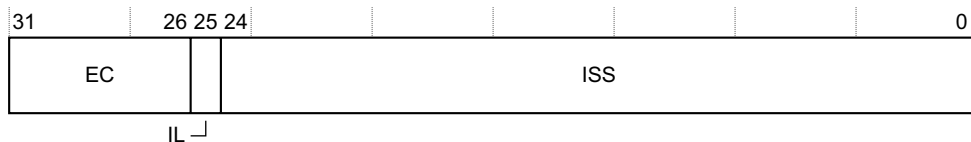

### EC, bits[31:26]

Exception class. The exception class for the exception that is taken to Hyp mode:

- When zero, this field indicates that the reason for the exception is not known. In this case, the other fields in the register are UNKNOWN.
- Otherwise, the field holds the Exception class for the exception, as described in [Use of the HSR on page B3-1424](#).

### IL, bit[25]

Instruction length. Indicates the size of the instruction that has been trapped to Hyp mode. The possible values of this bit are:

- 0** 16-bit instruction.
- 1** 32-bit instruction.

For information about the validity of the IL field see [Use of the HSR on page B3-1424](#). When the field is not valid it is UNK/SBZP.

### ISS, bits[24:0]

Instruction-specific syndrome. The interpretation of this field depends on the value of the EC field.

For more information see [Use of the HSR on page B3-1424](#).

## Accessing the HSR

To access the HSR, software reads or writes the CP15 registers with <opc1> set to 4, <CRn> set to c5, <CRm> set to c2, and <opc2> set to 0. For example:

```
MRC p15, 4, <Rt>, c5, c2, 0 ; Read HSR into Rt
MCR p15, 4, <Rt>, c5, c2, 0 ; Write Rt to HSR
```

### B4.1.73 HSTR, Hyp System Trap Register, Virtualization Extensions

The HSTR characteristics are:

- Purpose** The HSTR controls the trapping to Hyp mode of Non-secure accesses, at PL1 or lower, of:
- use of Jazelle or ThumbEE
  - access to each of the CP15 primary coprocessor registers, {c0-c3, c5-c13, c15}.
- This register is part of the Virtualization Extensions registers functional group.
- Usage constraints** Only accessible from Hyp mode, or from Monitor mode when `SCR.NS` is set to 1, see [PL2-mode system control registers on page B3-1454](#).
- Configurations** Implemented only as part of the Virtualization Extensions.  
 This is Banked PL2-mode register, see [Banked PL2-mode CP15 read/write registers on page B3-1454](#).
- Attributes** A 32-bit RW register that resets to zero. See also [Reset behavior of CP14 and CP15 registers on page B3-1450](#).  
[Table B3-55 on page B3-1501](#) shows the encoding of all of the Virtualization Extensions registers.

The HSTR bit assignments are:

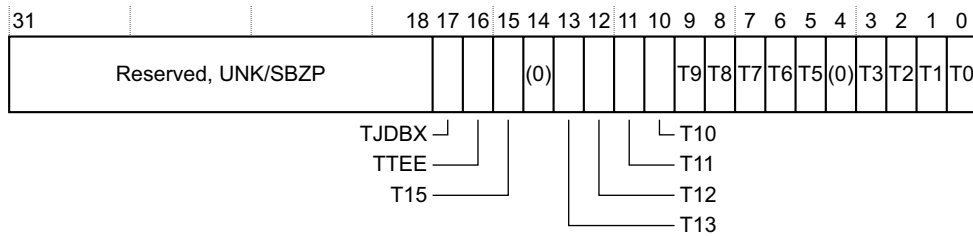

In the descriptions of the HSTR fields, a *valid Non-secure access* means an access that, if the bit was set to 0, would not be UNDEFINED or UNPREDICTABLE.

**Bits[31:18, 14, 4]**

Reserved, UNK/SBZP.

**TJDBX, bit[17]**

Trap Jazelle operations. When this bit is set to 1, any valid Non-secure access to Jazelle functionality is trapped to Hyp mode. For more information see [Trapping accesses to Jazelle functionality on page B1-1255](#).

**TTEE, bit[16]** Trap ThumbEE operations. When this bit is set to 1, any valid Non-secure access to the ThumbEE configuration registers is trapped to Hyp mode. For more information see [Trapping accesses to the ThumbEE configuration registers on page B1-1255](#).

**Tx, bit[x], for values of x in the set {0-3, 5-13, 15}**

Trap coprocessor primary register. When Tx is set to 1, Non-secure accesses from PL1 and PL0 modes to CP15 primary coprocessor register cx are trapped to Hyp mode. This means that, when Tx is set to 1, the following accesses are trapped to Hyp mode:

- an access using an MCR or MRC instruction with CRn set to x:
  - from a Non-secure PL1 mode
  - from the Non-secure PL0 mode, if the access would not be UNDEFINED if Tx was set to 0

- any access using an MCRR or MRRC instruction with CRm set to x:
  - from a Non-secure PL1 mode
  - from the Non-secure PL0 mode, if the access would not be UNDEFINED if Tx was set to 0.

For more information see [Generic trapping of accesses to CP15 system control registers on page B1-1258](#).

———— **Note** —————

A *Tn* bit traps all accesses to the corresponding CP15 primary coprocessor register. This is unlike most traps to Hyp mode, including the traps controlled by the TJDBX and TTEE bits, that trap only otherwise-valid accesses.

### Accessing the HSTR

To access the HSTR, software reads or writes the CP15 registers with <opc1> set to 4, <CRn> set to c1, <CRm> set to c1, and <opc2> set to 2. For example:

```
MRC p15, 4, <Rt>, c1, c1, 3 ; Read HSTR into Rt
MCR p15, 4, <Rt>, c1, c1, 3 ; Write Rt to HSTR
```

### B4.1.74 HTCR, Hyp Translation Control Register, Virtualization Extensions

The HTCR characteristics are:

<b>Purpose</b>	The HTCR controls the translation table walks required for the stage 1 translation of memory accesses from Hyp mode, and holds cacheability and shareability information for the accesses.  This register is part of the Virtualization Extensions registers functional group.
<b>Usage constraints</b>	Used in conjunction with <a href="#">HTTBR</a> , that defines the translation table base address for the translations.  Only accessible from Hyp mode, or from Monitor mode when <a href="#">SCR.NS</a> is set to 1, see <a href="#">PL2-mode system control registers on page B3-1454</a> .
<b>Configurations</b>	Implemented only as part of the Virtualization Extensions.  This is Banked PL2-mode register, see <a href="#">Banked PL2-mode CP15 read/write registers on page B3-1454</a> .
<b>Attributes</b>	A 32-bit RW register with an UNKNOWN reset value. See also <a href="#">Reset behavior of CP14 and CP15 registers on page B3-1450</a> .  <a href="#">Table B3-55 on page B3-1501</a> shows the encoding of all of the Virtualization Extensions registers.

———— **Note** ————

For other address translations, the following registers are equivalent to the HTCR and [HTTBR](#):

- for stage 1 translations for accesses from modes other than Hyp mode, the [TTBCR](#), [TTBR0](#), and [TTBR1](#)
- for stage 2 translations, the [VTCR](#) and [VTTBR](#).

The HTCR bit assignments are:

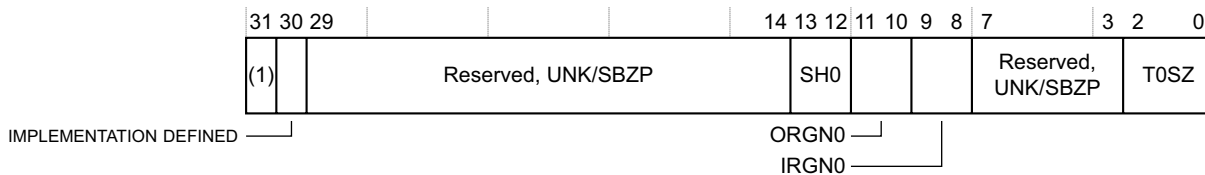

**Bit[31]** Reserved, UNK/SBOP.

**IMPLEMENTATION DEFINED, bit[30]**  
 An IMPLEMENTATION DEFINED bit.

**Bits[29:14]** Reserved, UNK/SBZP.

**SH0, bits[13:12]**  
 Shareability attribute for memory associated with translation table walks using [HTTBR](#). This field is encoded as described in [Shareability, Long-descriptor format on page B3-1373](#).



### ORGN0, bits[11:10]

Outer cacheability attribute for memory associated with translation table walks using [HTTBR](#). [Table B4-4](#) shows the encoding of this field.

**Table B4-4 HTCR.ORGNO field encoding**

ORGN0	Meaning
00	Normal memory, Outer Non-cacheable
01	Normal memory, Outer Write-Back Write-Allocate Cacheable
10	Normal memory, Outer Write-Through Cacheable
11	Normal memory, Outer Write-Back no Write-Allocate Cacheable

### IRGN0, bits[9:8]

Inner cacheability attribute for memory associated with translation table walks using [HTTBR](#). [Table B4-5](#) shows the encoding of this field.

**Table B4-5 HTCR.IRGN0 field encoding**

IRGN0	Meaning
00	Normal memory, Inner Non-cacheable
01	Normal memory, Inner Write-Back Write-Allocate Cacheable
10	Normal memory, Inner Write-Through Cacheable
11	Normal memory, Inner Write-Back no Write-Allocate Cacheable

**Bits[7:3]** Reserved, UNK/SBZP.

### T0SZ, bits[2:0]

The size offset of the memory region addressed by [HTTBR](#). This field is encoded as a three-bit unsigned integer, and the region size is  $2^{(32-T0SZ)}$  bytes.

[HTTBR](#), *Hyp Translation Table Base Register*, [Virtualization Extensions on page B4-1599](#) describes how the value of this field determines the width of the translation table base address defined by [HTTBR](#).

## Accessing the HTCR

To access the HTCR, software reads or writes the CP15 registers with <opc1> set to 4, <CRn> set to c2, <CRm> set to c0, and <opc2> set to 2. For example:

```
MRC p15, 4, <Rt>, c2, c0, 2 ; Read HTCR into Rt
MCR p15, 4, <Rt>, c2, c0, 2 ; Write Rt to HTCR
```

### B4.1.75 HTPIDR, Hyp Software Thread ID Register, Virtualization Extensions

The HTPIDR characteristics are:

<b>Purpose</b>	The HTPIDR provides a location where software running in Hyp mode can store thread identifying information that is not visible to Non-secure software executing at PL0 or PL1, for hypervisor management purposes. This register is part of the Miscellaneous operations functional group.
<b>Usage constraints</b>	Only accessible from Hyp mode, or from Monitor mode when SCR.NS is set to 1, see <a href="#">PL2-mode system control registers on page B3-1454</a> . Processor hardware never updates this register.
<b>Configurations</b>	Implemented only as part of the Virtualization Extensions. This is a Banked PL2-mode register, see <a href="#">Banked PL2-mode CP15 read/write registers on page B3-1454</a> .
<b>Attributes</b>	A 32-bit RW register with an UNKNOWN reset value. See also <a href="#">Reset behavior of CP14 and CP15 registers on page B3-1450</a> . <a href="#">Table B3-52 on page B3-1499</a> shows the encodings of all of the registers in the Miscellaneous operations functional group.

#### Accessing the HTPIDR

To access the HTPIDR, software executing in Hyp mode reads or writes the CP15 registers with <opc1> set to 4, <CRn> set to c13, <CRm> set to c0, and <opc2> set to 2.

For example:

```
MRC p15, 4, <Rt>, c13, c0, 2 ; Read HTPIDR into Rt  
MCR p15, 4, <Rt>, c13, c0, 2 ; Write Rt to HTPIDR
```

## B4.1.76 HTTBR, Hyp Translation Table Base Register, Virtualization Extensions

The HTTBR characteristics are:

**Purpose** The HTTBR holds the base address of the translation table for the stage 1 translation of memory accesses from Hyp mode.

———— **Note** —————

These translations are always defined using the Long-descriptor format translation tables.

This register is part of the Virtualization Extensions registers functional group.

**Usage constraints** Used in conjunction with the [HTCR](#).

Only accessible from Hyp mode, or from Monitor mode when [SCR.NS](#) is set to 1, see [PL2-mode system control registers on page B3-1454](#).

**Configurations** Implemented only as part of the Virtualization Extensions.

This is a Banked PL2-mode register, see [Banked PL2-mode CP15 read/write registers on page B3-1454](#).

**Attributes** A 64-bit RW register with an UNKNOWN reset value. See also [Reset behavior of CP14 and CP15 registers on page B3-1450](#).

[Table B3-55 on page B3-1501](#) shows the encoding of all of the Virtualization Extensions registers.

———— **Note** —————

See [HTCR, Hyp Translation Control Register, Virtualization Extensions on page B4-1596](#) for a summary of the registers that define the translation tables for other address translations.

The HTTBR bit assignments are:

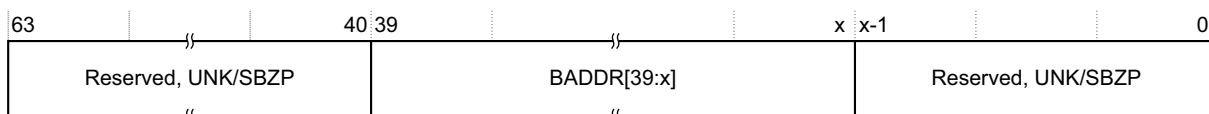

**Bits[63:40]** Reserved, UNK/SBZP.

**BADDR, bits[39:x]**

Translation table base address, bits[39:x]. See the text in this section for a description of how x is defined.

The value of x determines the required alignment of the translation table, which must be aligned to  $2^x$  bytes.

**Bits[x-1:0]** Reserved, UNK/SBZP.

The [HTCR.T0SZ](#) field determines the width of the defined translation table base address, indicated by the value of x in the HTTBR description. The following pseudocode calculates the value of x:

```
T0Size = UInt(HTCR.T0SZ);
if T0Size > 1 then
    x = 14 - T0Size;
else
    x = 5 - T0Size;
```

## **Accessing the HTTBR**

To access HTTBR, software performs a 64-bit read or write of the CP15 registers with <CRm> set to c2 and <opc1> set to 4. For example:

MRRC p15, 4, <Rt>, <Rt2>, c2 ; Read 64-bit HTTBR into Rt (low word) and Rt2 (high word)  
MCRR p15, 4, <Rt>, <Rt2>, c2 ; Write Rt (low word) and Rt2 (high word) to 64-bit HTTBR

In these MRRC and MCRR instructions, Rt holds the least-significant word of HTTBR, and Rt2 holds the most-significant word.

## B4.1.77 HVBAR, Hyp Vector Base Address Register, Virtualization Extensions

The HVBAR characteristics are:

<b>Purpose</b>	The HVBAR holds the exception base address for any exception that is taken to Hyp mode, see <a href="#">Exception vectors and the exception base address on page B1-1164</a> . This register is part of the Virtualization Extensions registers functional group.
<b>Usage constraints</b>	Only accessible from Hyp mode, or from Monitor mode when SCR.NS is set to 1, see <a href="#">PL2-mode system control registers on page B3-1454</a> .
<b>Configurations</b>	Implemented only as part of the Virtualization Extensions. This is Banked PL2-mode register, see <a href="#">Banked PL2-mode CP15 read/write registers on page B3-1454</a> .
<b>Attributes</b>	A 32-bit RW register with an UNKNOWN reset value. See also <a href="#">Reset behavior of CP14 and CP15 registers on page B3-1450</a> . <a href="#">Table B3-55 on page B3-1501</a> shows the encoding of all of the Virtualization Extensions registers.

The HVBAR bit assignments are:

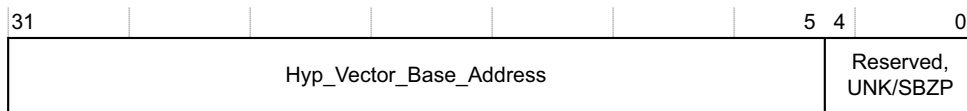

### Hyp\_Vector\_Base\_Address, bits[31:5]

Bits[31:5] of the base address of the exception vectors for exceptions that are taken to Monitor mode. Bits[4:0] of an exception vector is the exception offset, see [Table B1-3 on page B1-1166](#).

**Bits[4:0]** Reserved, UNK/SBZP.

For details of how the HVBAR determines the exception addresses see [Exception vectors and the exception base address on page B1-1164](#).

### Accessing the HVBAR

To access the HVBAR, software reads or writes the CP15 registers with <opc1> set to 4, <CRn> set to c12, <CRm> set to c0, and <opc2> set to 0. For example:

```
MRC p15, 4, <Rt>, c12, c0, 0 ; Read HVBAR into Rt
MCR p15, 4, <Rt>, c12, c0, 0 ; Write Rt to HVBAR
```

#### **B4.1.78 ICIALLU, Instruction Cache Invalidate All to PoU, VMSA**

*Cache and branch predictor maintenance operations, VMSA on page B4-1740* describes this cache maintenance operation.

This operation is part of the Cache maintenance operations functional group. [Table B3-49 on page B3-1496](#) shows the encodings of all of the registers and operations in this functional group.

#### **B4.1.79 ICIALLUIS, Instruction Cache Invalidate All to PoU, Inner Shareable, VMSA**

*Cache and branch predictor maintenance operations, VMSA on page B4-1740* describes this cache maintenance operation.

This operation is part of the Cache maintenance operations functional group. [Table B3-49 on page B3-1496](#) shows the encodings of all of the registers and operations in this functional group.

#### **B4.1.80 ICIMVAU, Instruction Cache Invalidate by MVA to PoU, VMSA**

*Cache and branch predictor maintenance operations, VMSA on page B4-1740* describes this cache maintenance operation.

This operation is part of the Cache maintenance operations functional group. [Table B3-49 on page B3-1496](#) shows the encodings of all of the registers and operations in this functional group.

## B4.1.81 ID\_AFR0, Auxiliary Feature Register 0, VMSA

The ID\_AFR0 characteristics are:

- Purpose** ID\_AFR0 provides information about the IMPLEMENTATION DEFINED features of the processor.  
 This register is a CPUID register, and is part of the Identification registers functional group.
- Usage constraints** Only accessible from PL1 or higher.  
 Must be interpreted with the Main ID Register, see *MIDR, Main ID Register, VMSA* on page B4-1648.
- Configurations** The VMSA and PMSA definitions of the register fields are identical.  
 In a VMSA implementation that includes the Security Extensions, this is a Common register.
- Attributes** A 32-bit RO register with an IMPLEMENTATION DEFINED value:
- [Table B7-1 on page B7-1950](#) shows the encodings of all of the CPUID registers
  - [Table B3-44 on page B3-1492](#) shows the encodings of all of the registers in the Identification registers functional group.

The ID\_AFR0 bit assignments are:

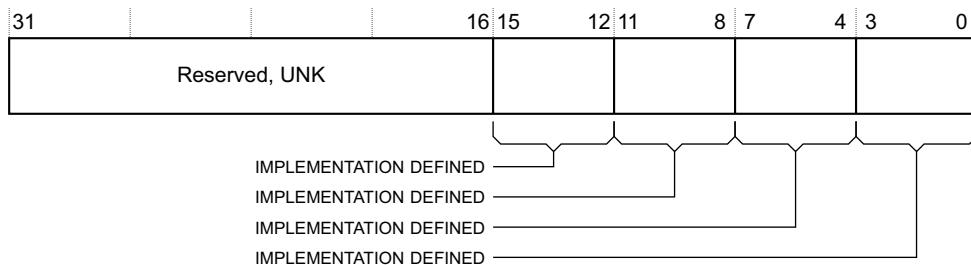

**Bits[31:16]** Reserved, UNK.

**IMPLEMENTATION DEFINED, bits[15:12]**

**IMPLEMENTATION DEFINED, bits[11:8]**

**IMPLEMENTATION DEFINED, bits[7:4]**

**IMPLEMENTATION DEFINED, bits[3:0]**

The Auxiliary Feature Register 0 has four 4-bit IMPLEMENTATION FIELDS. These fields are defined by the implementer of the design. The implementer is identified by the Implementer field of the [MIDR](#).

The Auxiliary Feature Register 0 enables implementers to include additional design features in the CPUID scheme. Field definitions for the Auxiliary Feature Register 0 might:

- differ between different implementers
- be subject to change
- migrate over time, for example if they are incorporated into the main architecture.

### Accessing ID\_AFR0

To access ID\_AFR0, software reads the CP15 registers with <opc1> set to 0, <CRn> set to c0, <CRm> set to c1, and <opc2> set to 3. For example:

```
MRC p15, 0, <Rt>, c0, c1, 3 ; Read ID_AFR0 into Rt
```

## B4.1.82 ID\_DFR0, Debug Feature Register 0, VMSA

The ID\_DFR0 characteristics are:

- Purpose** ID\_DFR0 provides top level information about the debug system.  
 This register is a CPUID register, and is part of the Identification registers functional group.
- Usage constraints** Only accessible from PL1 or higher.
- Configurations** The VMSA and PMSA definitions of the register fields are identical.  
 In a VMSA implementation that includes the Security Extensions, this is a Common register.
- Attributes** A 32-bit RO register with an IMPLEMENTATION DEFINED value:
- [Table B7-1 on page B7-1950](#) shows the encodings of all of the CPUID registers
  - [Table B3-44 on page B3-1492](#) shows the encodings of all of the registers in the Identification registers functional group.
- All field values not shown in the field descriptions are reserved.

The ID\_DFR0 bit assignments are:

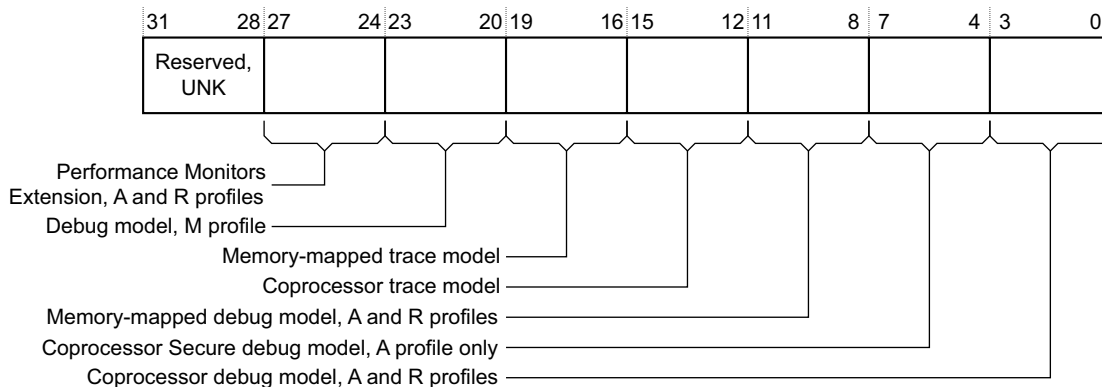

**Bits[31:28]** Reserved, UNK.

### Performance Monitors Extension, A and R profiles, bits[27:24]

Support for coprocessor-based ARM Performance Monitors Extension, for A and R profile processors. Permitted values are:

- 0b0000 PMUv2 not supported.
- 0b0001 Support for Performance Monitors Extension, PMUv1.
- 0b0010 Support for Performance Monitors Extension, PMUv2.
- 0b1111 No ARM Performance Monitors Extension support.

**Note**

A value of 0b0000 gives no indication of whether PMUv1 monitors are supported.

### Debug model, M profile, bits[23:20]

Support for memory-mapped debug model for M profile processors. Permitted values are:

- 0b0000 Not supported.
- 0b0001 Support for M profile Debug architecture, with memory-mapped access.



#### Memory-mapped trace model, bits[19:16]

Support for memory-mapped trace model. Permitted values are:

- 0b0000 Not supported.
- 0b0001 Support for ARM trace architecture, with memory-mapped access.

The ID register, register 0x079, gives more information about the implementation. See also [Trace on page C1-2022](#).

#### Coprocessor trace model, bits[15:12]

Support for coprocessor-based trace model. Permitted values are:

- 0b0000 Not supported.
- 0b0001 Support for ARM trace architecture, with CP14 access.

The ID register, register 0x079, gives more information about the implementation. See also [Trace on page C1-2022](#).

#### Memory-mapped debug model, A and R profiles, bits[11:8]

Support for memory-mapped debug model, for A and R profile processors. Permitted values are:

- 0b0000 Not supported, or pre-ARMv6 implementation.
- 0b0100 Support for v7 Debug architecture, with memory-mapped access.
- 0b0101 Support for v7.1 Debug architecture, with memory-mapped access.

———— **Note** —————

The permitted field values are not continuous, and values 0b0001, 0b0010, and 0b0011 are reserved.

#### Coprocessor Secure debug model, bits[7:4]

Support for coprocessor-based Secure debug model, for an A profile processor that includes the Security Extensions. Permitted values are:

- 0b0000 Not supported.
- 0b0011 Support for v6.1 Debug architecture, with CP14 access.
- 0b0100 Support for v7 Debug architecture, with CP14 access.
- 0b0101 Support for v7.1 Debug architecture, with CP14 access.

———— **Note** —————

The permitted field values are not continuous, and values 0b0001 and 0b0010 are reserved.

#### Coprocessor debug model, bits[3:0]

Support for coprocessor based debug model, for A and R profile processors. Permitted values are:

- 0b0000 Not supported.
- 0b0010 Support for v6 Debug architecture, with CP14 access.
- 0b0011 Support for v6.1 Debug architecture, with CP14 access.
- 0b0100 Support for v7 Debug architecture, with CP14 access.
- 0b0101 Support for v7.1 Debug architecture, with CP14 access.

———— **Note** —————

The permitted field values are not continuous, and value 0b0001 is reserved.

———— **Note** —————

Software can obtain more information about the debug implementation from the debug infrastructure, see [Debug identification registers on page C11-2196](#).

### **Accessing ID\_DFR0**

To access ID\_DFR0, software reads the CP15 registers with <opc1> set to 0, <CRn> set to c0, <CRm> set to c1, and <opc2> set to 2. For example:

MRC p15, 0, <Rt>, c0, c1, 2 ; Read ID\_DFR0 into Rt

### B4.1.83 ID\_ISAR0, Instruction Set Attribute Register 0, VMSA

The ID\_ISAR0 characteristics are:

- Purpose** ID\_ISAR0 provides information about the instruction sets implemented by the processor. For more information see [About the Instruction Set Attribute registers on page B7-1950](#). This register is a CPUID register, and is part of the Identification registers functional group.
- Usage constraints** Only accessible from PL1 or higher. Must be interpreted with ID\_ISAR1, ID\_ISAR2, ID\_ISAR3, and ID\_ISAR4. For more information see [About the Instruction Set Attribute registers on page B7-1950](#).
- Configurations** The VMSA and PMSA definitions of the register fields are identical. In a VMSA implementation that includes the Security Extensions, this is a Common register.
- Attributes** A 32-bit RO register with an IMPLEMENTATION DEFINED value:
- [Table B7-1 on page B7-1950](#) shows the encodings of all of the CPUID registers
  - [Table B3-44 on page B3-1492](#) shows the encodings of all of the registers in the Identification registers functional group.
- All field values not shown in the field descriptions are reserved.

The ID\_ISAR0 bit assignments are:

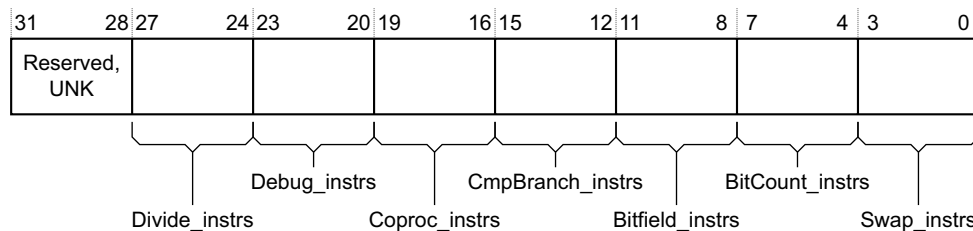

**Bits[31:28]** Reserved, UNK.

#### Divide\_instrs, bits[27:24]

Indicates the implemented Divide instructions. Permitted values are:

- 0b0000 None implemented.
- 0b0001 Adds SDIV and UDIV in the Thumb instruction set.
- 0b0010 As for 0b0001, and adds SDIV and UDIV in the ARM instruction set.

#### Debug\_instrs, bits[23:20]

Indicates the implemented Debug instructions. Permitted values are:

- 0b0000 None implemented.
- 0b0001 Adds BKPT.

#### Coproc\_instrs, bits[19:16]

Indicates the implemented Coprocessor instructions. Permitted values are:

- 0b0000 None implemented, except for instructions separately attributed by the architecture, including CP15, CP14, Advanced SIMD Extension and the Floating-point Extension.
- 0b0001 Adds generic CDP, LDC, MCR, MRC, and STC.
- 0b0010 As for 0b0001, and adds generic CDP2, LDC2, MCR2, MRC2, and STC2.
- 0b0011 As for 0b0010, and adds generic MCRR and MRRC.
- 0b0100 As for 0b0011, and adds generic MCRR2 and MRRC2.

#### **CmpBranch\_instrs, bits[15:12]**

Indicates the implemented combined Compare and Branch instructions in the Thumb instruction set. Permitted values are:

0b0000 None implemented.  
0b0001 Adds CBNZ and CBZ.

#### **Bitfield\_instrs, bits[11:8]**

Indicates the implemented BitField instructions. Permitted values are:

0b0000 None implemented.  
0b0001 Adds BFC, BFI, SBFX, and UBFX.

#### **BitCount\_instrs, bits[7:4]**

Indicates the implemented Bit Counting instructions. Permitted values are:

0b0000 None implemented.  
0b0001 Adds CLZ.

#### **Swap\_instrs, bits[3:0]**

Indicates the implemented Swap instructions in the ARM instruction set. Permitted values are:

0b0000 None implemented.  
0b0001 Adds SWP and SWPB.

### **Accessing ID\_ISAR0**

To access ID\_ISAR0, software reads the CP15 registers with <opc1> set to 0, <CRn> set to c0, <CRm> set to c2, and <opc2> set to 0. For example:

```
MRC p15, 0, <Rt>, c0, c2, 0 ; Read ID_ISAR0 into Rt
```

## B4.1.84 ID\_ISAR1, Instruction Set Attribute Register 1, VMSA

The ID\_ISAR1 characteristics are:

- Purpose** ID\_ISAR1 provides information about the instruction sets implemented by the processor. For more information see [About the Instruction Set Attribute registers on page B7-1950](#). This register is a CPUID register, and is part of the Identification registers functional group.
- Usage constraints** Only accessible from PL1 or higher.  
 Must be interpreted with ID\_ISAR0, ID\_ISAR2, ID\_ISAR3, and ID\_ISAR4. For more information see [About the Instruction Set Attribute registers on page B7-1950](#).
- Configurations** The VMSA and PMSA definitions of the register fields are identical.  
 In a VMSA implementation that includes the Security Extensions, this is a Common register.
- Attributes** A 32-bit RO register with an IMPLEMENTATION DEFINED value:
- [Table B7-1 on page B7-1950](#) shows the encodings of all of the CPUID registers
  - [Table B3-44 on page B3-1492](#) shows the encodings of all of the registers in the Identification registers functional group.
- All field values not shown in the field descriptions are reserved.

The ID\_ISAR1 bit assignments are:

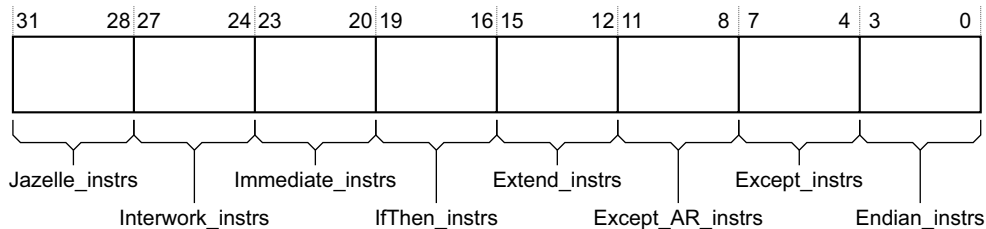

### Jazelle\_instrs, bits[31:28]

Indicates the implemented Jazelle extension instructions. Permitted values are:

- 0b0000 No support for Jazelle.
- 0b0001 Adds the BXJ instruction, and the J bit in the PSR.  
 This setting might indicate a trivial implementation of the Jazelle extension.

### Interwork\_instrs, bits[27:24]

Indicates the implemented Interworking instructions. Permitted values are:

- 0b0000 None implemented.
- 0b0001 Adds the BX instruction, and the T bit in the PSR.
- 0b0010 As for 0b0001, and adds the BLX instruction. PC loads have BX-like behavior.
- 0b0011 As for 0b0010, and guarantees that data-processing instructions in the ARM instruction set with the PC as the destination and the S bit clear have BX-like behavior.

### Note

A value of 0b0000, 0b0001, or 0b0010 in this field does not guarantee that an ARM data-processing instruction with the PC as the destination and the S bit clear behaves like an old MOV PC instruction, ignoring bits[1:0] of the result. With these values of this field:

- if bits[1:0] of the result value are 0b00 then the processor remains in ARM state
- if bits[1:0] are 0b01, 0b10 or 0b11, the result must be treated as UNPREDICTABLE.

#### Immediate\_instrs, bits[23:20]

Indicates the implemented data-processing instructions with long immediates. Permitted values are:

0b0000 None implemented.

0b0001 Adds:

- the MOVT instruction
- the MOV instruction encodings with zero-extended 16-bit immediates
- the Thumb ADD and SUB instruction encodings with zero-extended 12-bit immediates, and the other ADD, ADR and SUB encodings cross-referenced by the pseudocode for those encodings.

#### IfThen\_instrs, bits[19:16]

Indicates the implemented If-Then instructions in the Thumb instruction set. Permitted values are:

0b0000 None implemented.

0b0001 Adds the IT instructions, and the IT bits in the PSRs.

#### Extend\_instrs, bits[15:12]

Indicates the implemented Extend instructions. Permitted values are:

0b0000 No scalar sign-extend or zero-extend instructions are implemented, where scalar instructions means non-Advanced SIMD instructions.

0b0001 Adds the SXTB, SXTH, UXTB, and UXTH instructions.

0b0010 As for 0b0001, and adds the SXTB16, SXTAB, SXTAB16, SXTAH, UXTB16, UXTAB, UXTAB16, and UXTAH instructions.

#### Note

In addition:

- the shift options on these instructions are available only if the WithShifts\_instrs attribute is 0b0011 or greater
- the SXTAB16, SXTB16, UXTAB16, and UXTB16 instructions are implemented only if both:
  - the Extend\_instrs attribute is 0b0010 or greater
  - the SIMD\_instrs attribute is 0b0011 or greater.

#### Except\_AR\_instrs, bits[11:8]

Indicates the implemented A and R profile exception-handling instructions. Permitted values are:

0b0000 None implemented.

0b0001 Adds the SRS and RFE instructions, and the A and R profile forms of the CPS instruction.

#### Except\_instrs, bits[7:4]

Indicates the implemented exception-handling instructions in the ARM instruction set. Permitted values are:

0b0000 Not implemented. This indicates that the User registers and exception return forms of the LDM and STM instructions are not implemented.

0b0001 Adds the LDM (exception return), LDM (User registers) and STM (User registers) instruction versions.

#### Endian\_instrs, bits[3:0]

Indicates the implemented Endian instructions. Permitted values are:

0b0000 None implemented.

0b0001 Adds the SETEND instruction, and the E bit in the PSRs.

## **Accessing ID\_ISAR1**

To access ID\_ISAR1, software reads the CP15 registers with <opc1> set to 0, <CRn> set to c0, <CRm> set to c2, and <opc2> set to 1. For example:

MRC p15, 0, <Rt>, c0, c2, 1 ; Read ID\_ISAR1 into Rt

## B4.1.85 ID\_ISAR2, Instruction Set Attribute Register 2, VMSA

The ID\_ISAR2 characteristics are:

- Purpose** ID\_ISAR2 provides information about the instruction sets implemented by the processor. For more information see [About the Instruction Set Attribute registers on page B7-1950](#). This register is a CPUID register, and is part of the Identification registers functional group.
- Usage constraints** Only accessible from PL1 or higher.  
 Must be interpreted with ID\_ISAR0, ID\_ISAR1, ID\_ISAR3, and ID\_ISAR4. For more information see [About the Instruction Set Attribute registers on page B7-1950](#).
- Configurations** The VMSA and PMSA definitions of the register fields are identical.  
 In a VMSA implementation that includes the Security Extensions, this is a Common register.
- Attributes** A 32-bit RO register with an IMPLEMENTATION DEFINED value:
- [Table B7-1 on page B7-1950](#) shows the encodings of all of the CPUID registers
  - [Table B3-44 on page B3-1492](#) shows the encodings of all of the registers in the Identification registers functional group.
- All field values not shown in the field descriptions are reserved.

The ID\_ISAR2 bit assignments are:

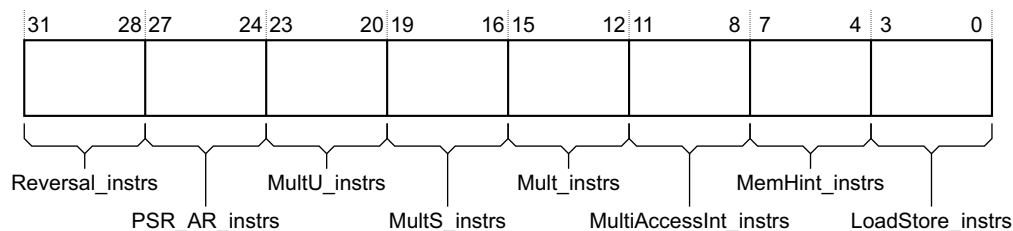

### Reversal\_instrs, bits[31:28]

Indicates the implemented Reversal instructions. Permitted values are:

- 0b0000 None implemented.
- 0b0001 Adds the REV, REV16, and REVSH instructions.
- 0b0010 As for 0b0001, and adds the RBIT instruction.

### PSR\_AR\_instrs, bits[27:24]

Indicates the implemented A and R profile instructions to manipulate the PSR. Permitted values are:

- 0b0000 None implemented.
- 0b0001 Adds the MRS and MSR instructions, and the exception return forms of data-processing instructions described in [SUBS PC, LR \(Thumb\) on page B9-2008](#) and [SUBS PC, LR and related instructions \(ARM\) on page B9-2010](#).

### ———— Note ————

The exception return forms of the data-processing instructions are:

- In the ARM instruction set, data-processing instructions with the PC as the destination and the S bit set. These instructions might be affected by the WithShifts attribute.
- In the Thumb instruction set, the SUBS PC, LR, #N instruction.



#### **MultU\_instrs, bits[23:20]**

Indicates the implemented advanced unsigned Multiply instructions. Permitted values are:

- 0b0000 None implemented.
- 0b0001 Adds the UMULL and UMLAL instructions.
- 0b0010 As for 0b0001, and adds the UMAAL instruction.

#### **MultS\_instrs, bits[19:16]**

Indicates the implemented advanced signed Multiply instructions. Permitted values are:

- 0b0000 None implemented.
- 0b0001 Adds the SMULL and SMLAL instructions.
- 0b0010 As for 0b0001, and adds the SMLABB, SMLABT, SMLALBB, SMLALBT, SMLALTB, SMLALTT, SMLATB, SMLATT, SMLAWB, SMLAWT, SMULBB, SMULBT, SMULTB, SMULTT, SMULWB, and SMULWT instructions. Also adds the Q bit in the PSRs.
- 0b0011 As for 0b0010, and adds the SMLAD, SMLADX, SMLALD, SMLALDX, SMLSD, SMLSDX, SMLSLD, SMLSLDX, SMMLA, SMMLAR, SMMLS, SMMLSR, SMMUL, SMMULR, SMUAD, SMUADX, SMUSD, and SMUSDX instructions.

#### **Mult\_instrs, bits[15:12]**

Indicates the implemented additional Multiply instructions. Permitted values are:

- 0b0000 No additional instructions implemented. This means only MUL is implemented.
- 0b0001 Adds the MLA instruction.
- 0b0010 As for 0b0001, and adds the MLS instruction.

#### **MultiAccessInt\_instrs, bits[11:8]**

Indicates the support for interruptible multi-access instructions. Permitted values are:

- 0b0000 No support. This means the LDM and STM instructions are not interruptible.
- 0b0001 LDM and STM instructions are restartable.
- 0b0010 LDM and STM instructions are continuable.

#### **MemHint\_instrs, bits[7:4]**

Indicates the implemented Memory Hint instructions. Permitted values are:

- 0b0000 None implemented.
- 0b0001 Adds the PLD instruction.
- 0b0010 Adds the PLD instruction.  
In the MemHint\_instrs field, entries of 0b0001 and 0b0010 have identical meanings.
- 0b0011 As for 0b0001 (or 0b0010), and adds the PLI instruction.
- 0b0100 As for 0b0011, and adds the PLDW instruction.

#### **LoadStore\_instrs, bits[3:0]**

Indicates the implemented additional load/store instructions. Permitted values are:

- 0b0000 No additional load/store instructions implemented.
- 0b0001 Adds the LDRD and STRD instructions.

### **Accessing ID\_ISAR2**

To access ID\_ISAR2, software reads the CP15 registers with <opc1> set to 0, <CRn> set to c0, <CRm> set to c2, and <opc2> set to 2. For example:

```
MRC p15, 0, <Rt>, c0, c2, 2 ; Read ID_ISAR2 into Rt
```

## B4.1.86 ID\_ISAR3, Instruction Set Attribute Register 3, VMSA

The ID\_ISAR3 characteristics are:

- Purpose** ID\_ISAR3 provides information about the instruction sets implemented by the processor. For more information see [About the Instruction Set Attribute registers on page B7-1950](#). This register is a CPUID register, and is part of the Identification registers functional group.
- Usage constraints** Only accessible from PL1 or higher. Must be interpreted with ID\_ISAR0, ID\_ISAR1, ID\_ISAR2, and ID\_ISAR4. For more information see [About the Instruction Set Attribute registers on page B7-1950](#).
- Configurations** The VMSA and PMSA definitions of the register fields are identical. In a VMSA implementation that includes the Security Extensions, this is a Common register.
- Attributes** A 32-bit RO register with an IMPLEMENTATION DEFINED value:
- [Table B7-1 on page B7-1950](#) shows the encodings of all of the CPUID registers
  - [Table B3-44 on page B3-1492](#) shows the encodings of all of the registers in the Identification registers functional group.
- All field values not shown in the field descriptions are reserved.

The ID\_ISAR3 bit assignments are:

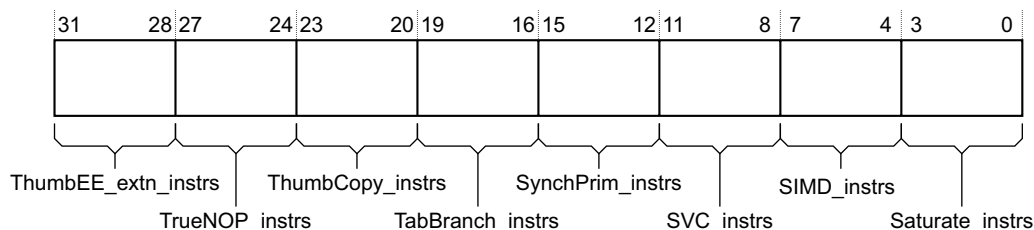

### ThumbEE\_extn\_instrs, bits[31:28]

Indicates the implemented Thumb Execution Environment (ThumbEE) Extension instructions. Permitted values are:

- 0b0000 None implemented.
- 0b0001 Adds the ENTERX and LEAVEX instructions, and modifies the load behavior to include null checking.

**Note**

This field can only have a value other than 0b0000 when the ID\_PFR0.State3 field has a value of 0b0001.

### TrueNOP\_instrs, bits[27:24]

Indicates the implemented True NOP instructions. Permitted values are:

- 0b0000 None implemented. This means there are no NOP instructions that do not have any register dependencies.
- 0b0001 Adds true NOP instructions in both the Thumb and ARM instruction sets. This also permits additional NOP-compatible hints.

### ThumbCopy\_instrs, bits[23:20]

Indicates the support for Thumb non flag-setting MOV instructions. Permitted values are:

- 0b0000 Not supported. This means that in the Thumb instruction set, encoding T1 of the MOV (register) instruction does not support a copy from a low register to a low register.
- 0b0001 Adds support for Thumb instruction set encoding T1 of the MOV (register) instruction, copying from a low register to a low register.

#### TabBranch\_instrs, bits[19:16]

Indicates the implemented Table Branch instructions in the Thumb instruction set. Permitted values are:

- 0b0000 None implemented.
- 0b0001 Adds the TBB and TBH instructions.

#### SynchPrim\_instrs, bits[15:12]

This field is used with the [ID\\_ISAR4.SynchPrim\\_instrs\\_frac](#) field to indicate the implemented Synchronization Primitive instructions. [Table B4-6](#) shows the permitted values of these fields:

**Table B4-6 Implemented Synchronization Primitive instructions**

SynchPrim_instrs	SynchPrim_instrs_frac	Implemented Synchronization Primitives
0000	0000	None implemented
0001	0000	Adds the LDREX and STREX instructions
0001	0011	As for [0001, 0000], and adds the CLREX, LDREXB, LDREXH, STREXB, and STREXH instructions
0010	0000	As for [0001, 0011], and adds the LDREXD and STREXD instructions

All combinations of SynchPrim\_instrs and SynchPrim\_instrs\_frac not shown in [Table B4-6](#) are reserved.

#### SVC\_instrs, bits[11:8]

Indicates the implemented SVC instructions. Permitted values are:

- 0b0000 Not implemented.
- 0b0001 Adds the SVC instruction.

———— **Note** —————

The SVC instruction was called the SWI instruction in previous versions of the ARM architecture.

#### SIMD\_instrs, bits[7:4]

Indicates the implemented SIMD instructions. Permitted values are:

- 0b0000 None implemented.
- 0b0001 Adds the SSAT and USAT instructions, and the Q bit in the PSRs.
- 0b0011 As for 0b0001, and adds the PKHBT, PKHTB, QADD16, QADD8, QASX, QSUB16, QSUB8, QSAX, SADD16, SADD8, SASX, SEL, SHADD16, SHADD8, SHASX, SHSUB16, SHSUB8, SHSAX, SSAT16, SSUB16, SSUB8, SSAX, SXTAB16, SXTB16, UADD16, UADD8, UASX, UHADD16, UHADD8, UHASX, UHSUB16, UHSUB8, UHSAX, UQADD16, UQADD8, UQASX, UQSUB16, UQSUB8, UQSAX, USAD8, USADA8, USAT16, USUB16, USUB8, USAX, UXTAB16, and UXTB16 instructions.

Also adds support for the GE[3:0] bits in the PSRs.

———— **Note** —————

- In the SIMD\_instrs field, the permitted values are not continuous, and the value 0b0010 is reserved.
- The SXTAB16, SXTB16, UXTAB16, and UXTB16 instructions are implemented only if both:
  - the Extend\_instrs attribute is 0b0010 or greater
  - the SIMD\_instrs attribute is 0b0011 or greater.
- The SIMD\_instrs field relates only to implemented instructions that perform SIMD operations on the ARM core registers. [MVFR0](#) and [MVFR1](#) give information about the SIMD instructions implemented by the optional Advanced SIMD Extension.

### Saturate\_instrs, bits[3:0]

Indicates the implemented Saturate instructions. Permitted values are:

- 0b0000 None implemented. This means no non-Advanced SIMD saturate instructions are implemented.
- 0b0001 Adds the QADD, QDADD, QDSUB, and QSUB instructions, and the Q bit in the PSRs.

### Accessing ID\_ISAR3

To access ID\_ISAR3, software reads the CP15 registers with <opc1> set to 0, <CRn> set to c0, <CRm> set to c2, and <opc2> set to 3. For example:

```
MRC p15, 0, <Rt>, c0, c2, 3 ; Read ID_ISAR3 into Rt
```

## B4.1.87 ID\_ISAR4, Instruction Set Attribute Register 4, VMSA

The ID\_ISAR4 characteristics are:

<b>Purpose</b>	ID_ISAR4 provides information about the instruction sets implemented by the processor. For more information see <a href="#">About the Instruction Set Attribute registers on page B7-1950</a> . This register is a CPUID register, and is part of the Identification registers functional group.
<b>Usage constraints</b>	Only accessible from PL1 or higher. Must be interpreted with ID_ISAR0, ID_ISAR1, ID_ISAR2, and ID_ISAR3. For more information see <a href="#">About the Instruction Set Attribute registers on page B7-1950</a> .
<b>Configurations</b>	The VMSA and PMSA definitions of the register fields are identical. In a VMSA implementation that includes the Security Extensions, this is a Common register.
<b>Attributes</b>	A 32-bit RO register with an IMPLEMENTATION DEFINED value: <ul style="list-style-type: none"> <li>• <a href="#">Table B7-1 on page B7-1950</a> shows the encodings of all of the CPUID registers</li> <li>• <a href="#">Table B3-44 on page B3-1492</a> shows the encodings of all of the registers in the Identification registers functional group.</li> </ul> All field values not shown in the field descriptions are reserved.

The ID\_ISAR4 bit assignments are:

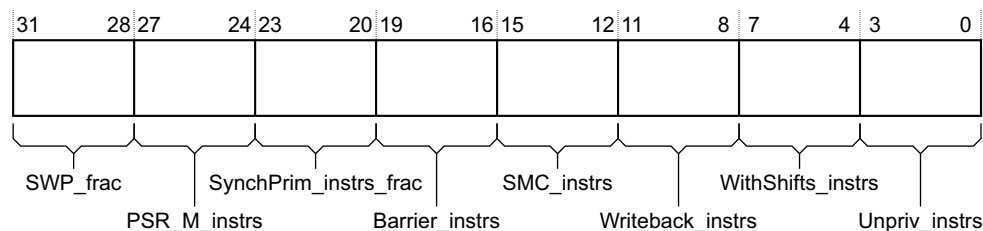

### SWP\_frac, bits[31:28]

Indicates support for the memory system locking the bus for SWP or SWPB instructions. Permitted values are:

- 0b0000 SWP or SWPB instructions not implemented.
- 0b0001 SWP or SWPB implemented but only in a uniprocessor context. SWP and SWPB do not guarantee whether memory accesses from other masters can come between the load memory access and the store memory access of the SWP or SWPB.

This field is valid only if the ID\_ISAR0.Swap\_instrs field is zero.

### PSR\_M\_instrs, bits[27:24]

Indicates the implemented M profile instructions to modify the PSRs. Permitted values are:

- 0b0000 None implemented.
- 0b0001 Adds the M profile forms of the CPS, MRS and MSR instructions.

### SynchPrim\_instrs\_frac, bits[23:20]

This field is used with the ID\_ISAR3.SynchPrim\_instrs field to indicate the implemented Synchronization Primitive instructions. [Table B4-6 on page B4-1615](#) shows the permitted values of these fields.

All combinations of SynchPrim\_instrs and SynchPrim\_instrs\_frac not shown in [Table B4-6 on page B4-1615](#) are reserved.

#### Barrier\_instrs, bits[19:16]

Indicates the implemented Barrier instructions in the ARM and Thumb instruction sets. Permitted values are:

- 0b0000 None implemented. Barrier operations are provided only as CP15 operations.
- 0b0001 Adds the DMB, DSB, and ISB barrier instructions.

#### SMC\_instrs, bits[15:12]

Indicates the implemented SMC instructions. Permitted values are:

- 0b0000 None implemented.
- 0b0001 Adds the SMC instruction.

———— **Note** —————

The SMC instruction was called the SMI instruction in previous versions of the ARM architecture.

#### Writeback\_instrs, bits[11:8]

Indicates the support for Writeback addressing modes. Permitted values are:

- 0b0000 Basic support. Only the LDM, STM, PUSH, POP, SRS, and RFE instructions support writeback addressing modes. These instructions support all of their writeback addressing modes.
- 0b0001 Adds support for all of the writeback addressing modes defined in ARMv7.

#### WithShifts\_instrs, bits[7:4]

Indicates the support for instructions with shifts. Permitted values are:

- 0b0000 Nonzero shifts supported only in MOV and shift instructions.
- 0b0001 Adds support for shifts of loads and stores over the range LSL 0-3.
- 0b0011 As for 0b0001, and adds support for other constant shift options, both on load/store and other instructions.
- 0b0100 As for 0b0011, and adds support for register-controlled shift options.

———— **Note** —————

- In this field, the permitted values are not continuous, and the value 0b0010 is reserved.
- Additions to the basic support indicated by the 0b0000 field value only apply when the encoding supports them. In particular, in the Thumb instruction set there is no difference between the 0b0011 and 0b0100 levels of support.
- MOV instructions with shift options are treated as ASR, LSL, LSR, ROR or RRX instructions, as described in [Data-processing instructions on page B7-1951](#).

#### Unpriv\_instrs, bits[3:0]

Indicates the implemented unprivileged instructions. Permitted values are:

- 0b0000 None implemented. No T variant instructions are implemented.
- 0b0001 Adds the LDRBT, LDRT, STRBT, and STRT instructions.
- 0b0010 As for 0b0001, and adds the LDRHT, LDRSBT, LDRSHT, and STRHT instructions.

### Accessing ID\_ISAR4

To access ID\_ISAR4, software reads the CP15 registers with <opc1> set to 0, <CRn> set to c0, <CRm> set to c2, and <opc2> set to 4. For example:

MRC p15, 0, <Rt>, c0, c2, 4 ; Read ID\_ISAR4 into Rt



## B4.1.89 ID\_MMFR0, Memory Model Feature Register 0, VMSA

The ID\_MMFR0 characteristics are:

- Purpose** ID\_MMFR0 provides information about the implemented memory model and memory management support.  
 This register is a CPUID register, and is part of the Identification registers functional group.
- Usage constraints** Only accessible from PL1 or higher.  
 Must be interpreted with ID\_MMFR1, ID\_MMFR2, and ID\_MMFR3.
- Configurations** The VMSA and PMSA definitions of the register fields are identical.  
 In a VMSA implementation that includes the Security Extensions, this is a Common register.
- Attributes** A 32-bit RO register with an IMPLEMENTATION DEFINED value:
- [Table B7-1 on page B7-1950](#) shows the encodings of all of the CPUID registers
  - [Table B3-44 on page B3-1492](#) shows the encodings of all of the registers in the Identification registers functional group.
- All field values not shown in the field descriptions are reserved.

The ID\_MMFR0 bit assignments are:

31	28	27	24	23	20	19	16	15	12	11	8	7	4	3	0
Innermost shareability	FCSE support	Auxiliary registers	TCM support	Shareability levels	Outermost shareability	PMSA support	VMSA support								

### Innermost shareability, bits[31:28]

Indicates the innermost shareability domain implemented. Permitted values are:

- 0b0000 Implemented as Non-cacheable.
- 0b0001 Implemented with hardware coherency support.
- 0b1111 Shareability ignored.

This field is valid only if the implementation distinguishes between Inner Shareable and Outer Shareable, by implementing two levels of shareability, as indicated by the value of the Shareability levels field, bits[15:12].

When the Shareability levels field is zero, this field is reserved, UNK.

### FCSE support, bits[27:24]

Indicates whether the implementation includes the FCSE. Permitted values are:

- 0b0000 Not supported.
- 0b0001 Support for FCSE.

The value of 0b0001 is only permitted when the VMSA\_support field has a value greater than 0b0010.

### Auxiliary registers, bits[23:20]

Indicates support for Auxiliary registers. Permitted values are:

- 0b0000 None supported.
- 0b0001 Support for Auxiliary Control Register only.
- 0b0010 Support for Auxiliary Fault Status Registers (AIFSR and ADFSR) and Auxiliary Control Register.



### TCM support, bits[19:16]

Indicates support for TCMs and associated DMAs. Permitted values are:

- 0b0000 Not supported.
- 0b0001 Support is IMPLEMENTATION DEFINED. ARMv7 requires this setting.
- 0b0010 Support for TCM only, ARMv6 implementation.
- 0b0011 Support for TCM and DMA, ARMv6 implementation.

#### ———— Note —————

An ARMv7 implementation might include an ARMv6 model for TCM support. However, in ARMv7 this is an IMPLEMENTATION DEFINED option, and therefore it must be represented by the 0b0001 encoding in this field.

### Shareability levels, bits[15:12]

Indicates the number of shareability levels implemented. Permitted values are:

- 0b0000 One level of shareability implemented.
- 0b0001 Two levels of shareability implemented.

### Outermost shareability, bits[11:8]

Indicates the outermost shareability domain implemented. Permitted values are:

- 0b0000 Implemented as Non-cacheable.
- 0b0001 Implemented with hardware coherency support.
- 0b1111 Shareability ignored.

### PMSA support, bits[7:4]

Indicates support for a PMSA. Permitted values are:

- 0b0000 Not supported.
- 0b0001 Support for IMPLEMENTATION DEFINED PMSA.
- 0b0010 Support for PMSAv6, with a Cache Type Register implemented.
- 0b0011 Support for PMSAv7, with support for memory subsections. ARMv7-R profile.

When the PMSA support field is set to a value other than 0b0000 the VMSA support field must be set to 0b0000.

### VMSA support, bits[3:0]

Indicates support for a VMSA. Permitted values are:

- 0b0000 Not supported.
- 0b0001 Support for IMPLEMENTATION DEFINED VMSA.
- 0b0010 Support for VMSAv6, with Cache and TLB Type Registers implemented.
- 0b0011 Support for VMSAv7, with support for remapping and the Access flag. ARMv7-A profile.
- 0b0100 As for 0b0011, and adds support for the PXN bit in the Short-descriptor translation table format descriptors.
- 0b0101 As for 0b0100, and adds support for the Long-descriptor translation table format.

When the VMSA support field is set to a value other than 0b0000 the PMSA support field must be set to 0b0000.

## Accessing ID\_MMFR0

To access ID\_MMFR0, software reads the CP15 registers with <opc1> set to 0, <CRn> set to c0, <CRm> set to c1, and <opc2> set to 4. For example:

MRC p15, 0, <Rt>, c0, c1, 4 ; Read ID\_MMFR0 into Rt

## B4.1.90 ID\_MMFR1, Memory Model Feature Register 1, VMSA

The ID\_MMFR1 characteristics are:

- Purpose** ID\_MMFR1 provides information about the implemented memory model and memory management support.  
 This register is a CPUID register, and is part of the Identification registers functional group.
- Usage constraints** Only accessible from PL1 or higher.  
 Must be interpreted with ID\_MMFR0, ID\_MMFR2, and ID\_MMFR3.
- Configurations** The VMSA and PMSA definitions of the register fields are identical.  
 In a VMSA implementation that includes the Security Extensions, this is a Common register.
- Attributes** A 32-bit RO register with an IMPLEMENTATION DEFINED value:
- [Table B7-1 on page B7-1950](#) shows the encodings of all of the CPUID registers
  - [Table B3-44 on page B3-1492](#) shows the encodings of all of the registers in the Identification registers functional group.
- All field values not shown in the field descriptions are reserved.

The ID\_MMFR1 bit assignments are:

31	28	27	24	23	20	19	16	15	12	11	8	7	4	3	0
Branch predictor	L1 cache test and clean	L1 unified cache	L1 Harvard cache	L1 unified cache set/way	L1 Harvard cache set/way	L1 unified cache VA	L1 Harvard cache VA								

### Branch predictor, bits[31:28]

Indicates branch predictor management requirements. Permitted values are:

- 0b0000 No branch predictor, or no MMU present. Implies a fixed MPU configuration.
- 0b0001 Branch predictor requires flushing on:
- enabling or disabling the MMU
  - writing new data to instruction locations
  - writing new mappings to the translation tables
  - any change to the TTBR0, TTBR1, or TTBCR registers
  - changes of FCSE ProcessID or ContextID.
- 0b0010 Branch predictor requires flushing on:
- enabling or disabling the MMU
  - writing new data to instruction locations
  - writing new mappings to the translation tables
  - any change to the TTBR0, TTBR1, or TTBCR registers without a corresponding change to the FCSE ProcessID or ContextID.
- 0b0011 Branch predictor requires flushing only on writing new data to instruction locations.
- 0b0100 For execution correctness, branch predictor requires no flushing at any time.

———— **Note** ————

The branch predictor is described in some documentation as the Branch Target Buffer.

#### L1 cache test and clean, bits[27:24]

Indicates the supported Level 1 data cache test and clean operations, for Harvard or unified cache implementations. Permitted values are:

- 0b0000 None supported. This is the required setting for ARMv7.
- 0b0001 Supported Level 1 data cache test and clean operations are:
  - Test and clean data cache.
- 0b0010 As for 0b0001, and adds:
  - Test, clean, and invalidate data cache.

#### L1 unified cache, bits[23:20]

Indicates the supported entire Level 1 cache maintenance operations, for a unified cache implementation. Permitted values are:

- 0b0000 None supported. This is the required setting for ARMv7, because ARMv7 requires a hierarchical cache implementation.
- 0b0001 Supported entire Level 1 cache operations are:
  - Invalidate cache, including branch predictor if appropriate
  - Invalidate branch predictor, if appropriate.
- 0b0010 As for 0b0001, and adds:
  - Clean cache. Uses a recursive model, using the cache dirty status bit.
  - Clean and invalidate cache. Uses a recursive model, using the cache dirty status bit.

If this field is set to a value other than 0b0000 then the L1 Harvard cache field, bits[19:16], must be set to 0b0000.

#### L1 Harvard cache, bits[19:16]

Indicates the supported entire Level 1 cache maintenance operations, for a Harvard cache implementation. Permitted values are:

- 0b0000 None supported. This is the required setting for ARMv7, because ARMv7 requires a hierarchical cache implementation.
- 0b0001 Supported entire Level 1 cache operations are:
  - Invalidate instruction cache, including branch predictor if appropriate
  - Invalidate branch predictor, if appropriate.
- 0b0010 As for 0b0001, and adds:
  - Invalidate data cache
  - Invalidate data cache and instruction cache, including branch predictor if appropriate.
- 0b0011 As for 0b0010, and adds:
  - Clean data cache. Uses a recursive model, using the cache dirty status bit.
  - Clean and invalidate data cache. Uses a recursive model, using the cache dirty status bit.

If this field is set to a value other than 0b0000 then the L1 unified cache field, bits[23:20], must be set to 0b0000.

#### L1 unified cache set/way, bits[15:12]

Indicates the supported Level 1 cache line maintenance operations by set/way, for a unified cache implementation. Permitted values are:

- 0b0000 None supported. This is the required setting for ARMv7, because ARMv7 requires a hierarchical cache implementation.
- 0b0001 Supported Level 1 unified cache line maintenance operations by set/way are:
- Clean cache line by set/way.
- 0b0010 As for 0b0001, and adds:
- Clean and invalidate cache line by set/way.
- 0b0011 As for 0b0010, and adds:
- Invalidate cache line by set/way.

If this field is set to a value other than 0b0000 then the L1 Harvard cache s/w field, bits[11:8], must be set to 0b0000.

#### L1 Harvard cache set/way, bits[11:8]

Indicates the supported Level 1 cache line maintenance operations by set/way, for a Harvard cache implementation. Permitted values are:

- 0b0000 None supported. This is the required setting for ARMv7, because ARMv7 requires a hierarchical cache implementation.
- 0b0001 Supported Level 1 Harvard cache line maintenance operations by set/way are:
- Clean data cache line by set/way
  - Clean and invalidate data cache line by set/way.
- 0b0010 As for 0b0001, and adds:
- Invalidate data cache line by set/way.
- 0b0011 As for 0b0010, and adds:
- Invalidate instruction cache line by set/way.

If this field is set to a value other than 0b0000 then the L1 unified cache s/w field, bits[15:12], must be set to 0b0000.

#### L1 unified cache VA, bits[7:4]

Indicates the supported Level 1 cache line maintenance operations by MVA, for a unified cache implementation. Permitted values are:

- 0b0000 None supported. This is the required setting for ARMv7, because ARMv7 requires a hierarchical cache implementation.
- 0b0001 Supported Level 1 unified cache line maintenance operations by MVA are:
- Clean cache line by MVA
  - Invalidate cache line by MVA
  - Clean and invalidate cache line by MVA.
- 0b0010 As for 0b0001, and adds:
- Invalidate branch predictor by MVA, if branch predictor is implemented.

If this field is set to a value other than 0b0000 then the L1 Harvard cache VA field, bits[3:0], must be set to 0b0000.

### L1 Harvard cache VA, bits[3:0]

Indicates the supported Level 1 cache line maintenance operations by MVA, for a Harvard cache implementation. Permitted values are:

- 0b0000 None supported. This is the required setting for ARMv7, because ARMv7 requires a hierarchical cache implementation.
- 0b0001 Supported Level 1 Harvard cache line maintenance operations by MVA are:
- Clean data cache line by MVA
  - Invalidate data cache line by MVA
  - Clean and invalidate data cache line by MVA
  - Clean instruction cache line by MVA.
- 0b0010 As for 0b0001, and adds:
- Invalidate branch predictor by MVA, if branch predictor is implemented.

If this field is set to a value other than 0b0000 then the L1 unified cache VA field, bits[7:4], must be set to 0b0000.

### Accessing ID\_MMFR1

To access ID\_MMFR1, software reads the CP15 registers with <opc1> set to 0, <CRn> set to c0, <CRm> set to c1, and <opc2> set to 5. For example:

```
MRC p15, 0, <Rt>, c0, c1, 5 ; Read ID_MMFR1 into Rt
```

## B4.1.91 ID\_MMFR2, Memory Model Feature Register 2, VMSA

The ID\_MMFR2 characteristics are:

- Purpose** ID\_MMFR2 provides information about the implemented memory model and memory management support.  
 This register is a CPUID register, and is part of the Identification registers functional group.
- Usage constraints** Only accessible from PL1 or higher.  
 Must be interpreted with [ID\\_MMFR0](#), [ID\\_MMFR1](#), and [ID\\_MMFR3](#).
- Configurations** The VMSA and PMSA definitions of the register fields are identical.  
 In a VMSA implementation that includes the Security Extensions, this is a Common register.
- Attributes** A 32-bit RO register with an IMPLEMENTATION DEFINED value:
- [Table B7-1 on page B7-1950](#) shows the encodings of all of the CPUID registers
  - [Table B3-44 on page B3-1492](#) shows the encodings of all of the registers in the Identification registers functional group.
- All field values not shown in the field descriptions are reserved.

The ID\_MMFR2 bit assignments are:

31	28	27	24	23	20	19	16	15	12	11	8	7	4	3	0
HW Access flag		WFI stall		Mem barrier		Unified TLB		Harvard TLB		L1 Harvard range		L1 Harvard bg fetch		L1 Harvard fg fetch	

### HW Access flag, bits[31:28]

Indicates support for a Hardware Access flag, as part of the VMSAv7 implementation. Permitted values are:

- 0b0000 Not supported.  
 0b0001 Support for VMSAv7 Access flag, updated in hardware.  
 On an ARMv7-R implementation this field must be 0b0000.

### WFI stall, bits[27:24]

Indicates the support for Wait For Interrupt (WFI) stalling. Permitted values are:

- 0b0000 Not supported.  
 0b0001 Support for WFI stalling.

### Mem barrier, bits[23:20]

Indicates the supported CP15 memory barrier operations:

- 0b0000 None supported.  
 0b0001 Supported CP15 Memory barrier operations are:
- Data Synchronization Barrier (DSB). In previous versions of the ARM architecture, DSB was named Data Write Barrier (DWB).
- 0b0010 As for 0b0001, and adds:
- Instruction Synchronization Barrier (ISB). In previous versions of the ARM architecture, the ISB operation was called Prefetch Flush.
  - Data Memory Barrier (DMB).

———— **Note** ————

ARM deprecates the use of these operations. [ID\\_ISAR4.Barrier\\_instrs](#) indicates the level of support for the preferred barrier instructions.

### Unified TLB, bits[19:16]

Indicates the supported TLB maintenance operations, for a unified or Harvard TLB implementation. Permitted values are:

- 0b0000 Not supported.
- 0b0001 Supported unified TLB maintenance operations are:
  - Invalidate all entries in the TLB
  - Invalidate TLB entry by MVA.
- 0b0010 As for 0b0001, and adds:
  - Invalidate TLB entries by ASID match.
- 0b0011 As for 0b0010 and adds:
  - Invalidate instruction TLB and data TLB entries by MVA All ASID. This is a shared unified TLB operation.
- 0b0100 As for 0b0011 and adds:
  - Invalidate Hyp mode unified TLB entry by MVA
  - Invalidate entire Non-secure PL1&0 unified TLB
  - Invalidate entire Hyp mode unified TLB.

If this field is set to a value other than 0b0000 then the Harvard TLB field, bits[15:12], must be set to 0b0000.

### Harvard TLB, bits[15:12]

Indicates the supported TLB maintenance operations, for a Harvard TLB implementation. Permitted values are:

- 0b0000 Not supported.
- 0b0001 Supported Harvard TLB maintenance operations are:
  - Invalidate all entries in the ITLB and the DTLB. This is a shared unified TLB operation.
  - Invalidate all ITLB entries.
  - Invalidate all DTLB entries.
  - Invalidate ITLB entry by MVA.
  - Invalidate DTLB entry by MVA.
- 0b0010 As for 0b0001, and adds:
  - Invalidate ITLB and DTLB entries by ASID match. This is a shared unified TLB operation.
  - Invalidate ITLB entries by ASID match
  - Invalidate DTLB entries by ASID match.

If this field is set to a value other than 0b0000 then the Unified TLB field, bits[19:16], must be set to 0b0000.

#### ———— **Note** —————

This field is defined only for legacy reasons. It is replaced by the Unified TLB field, bits[19:16].

### L1 Harvard range, bits[11:8]

Indicates the supported Level 1 cache maintenance range operations, for a Harvard cache implementation. Permitted values are:

- 0b0000 Not supported.
- 0b0001 Supported Level 1 Harvard cache maintenance range operations are:
  - Invalidate data cache range by VA
  - Invalidate instruction cache range by VA
  - Clean data cache range by VA
  - Clean and invalidate data cache range by VA.

#### L1 Harvard bg fetch, bits[7:4]

Indicates the supported Level 1 cache background fetch operations, for a Harvard cache implementation. When supported, background fetch operations are non-blocking operations.

Permitted values are:

0b0000 Not supported.

0b0001 Supported Level 1 Harvard cache background fetch operations are:

- Fetch instruction cache range by VA
- Fetch data cache range by VA.

#### L1 Harvard fg fetch, bits[3:0]

Indicates the supported Level 1 cache foreground fetch operations, for a Harvard cache implementation. When supported, foreground fetch operations are blocking operations. Permitted values are:

0b0000 Not supported.

0b0001 Supported Level 1 Harvard cache foreground fetch operations are:

- Fetch instruction cache range by VA
- Fetch data cache range by VA.

### Accessing ID\_MMFR2

To access ID\_MMFR2, software reads the CP15 registers with <opc1> set to 0, <CRn> set to c0, <CRm> set to c1, and <opc2> set to 6. For example:

```
MRC p15, 0, <Rt>, c0, c1, 6 ; Read ID_MMFR2 into Rt
```



## B4.1.92 ID\_MMFR3, Memory Model Feature Register 3, VMSA

The ID\_MMFR3 characteristics are:

- Purpose** ID\_MMFR3 provides information about the implemented memory model and memory management support.  
 This register is a CPUID register, and is part of the Identification registers functional group.
- Usage constraints** Only accessible from PL1 or higher.  
 Must be interpreted with ID\_MMFR0, ID\_MMFR1, and ID\_MMFR2.
- Configurations** The VMSA and PMSA definitions of the register fields are identical.  
 In a VMSA implementation that includes the Security Extensions, this is a Common register.
- Attributes** A 32-bit RO register with an IMPLEMENTATION DEFINED value:
- [Table B7-1 on page B7-1950](#) shows the encodings of all of the CPUID registers
  - [Table B3-44 on page B3-1492](#) shows the encodings of all of the registers in the Identification registers functional group.
- All field values not shown in the field descriptions are reserved.

The ID\_MMFR3 bit assignments are:

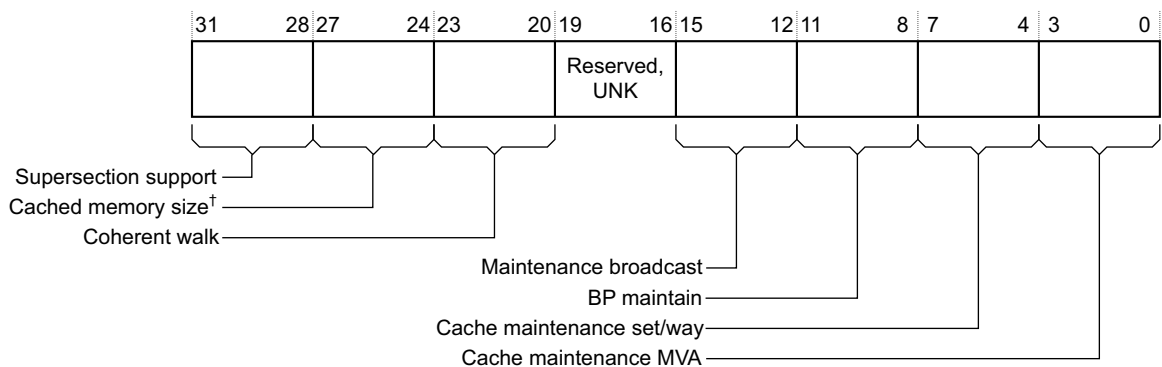

† Only on an implementation that includes the Large Physical Address Extension, otherwise reserved.

### Supersection support, bits[31:28]

On a VMSA implementation, indicates whether Supersections are supported. Permitted values are:

- 0b0000 Supersections supported.
- 0b1111 Supersections not supported.

**Note**

The sense of this identification is reversed from the normal usage in the CPUID mechanism, with the value of zero indicating that the feature is supported.

### Cached memory size, bits[27:24]

Indicates the physical memory size supported by the processor caches. Permitted values are:

- 0b0000 4GByte, corresponding to a 32-bit physical address range.
- 0b0001 64GByte, corresponding to a 36-bit physical address range.
- 0b0010 1TByte, corresponding to a 40-bit physical address range.

#### Coherent walk, bits[23:20]

Indicates whether translation table updates require a clean to the point of unification. Permitted values are:

- 0b0000 Updates to the translation tables require a clean to the point of unification to ensure visibility by subsequent translation table walks.
- 0b0001 Updates to the translation tables do not require a clean to the point of unification to ensure visibility by subsequent translation table walks.

**Bits[19:16]** Reserved, UNK.

#### Maintenance broadcast, bits[15:12]

Indicates whether Cache, TLB and branch predictor operations are broadcast. Permitted values are:

- 0b0000 Cache, TLB and branch predictor operations only affect local structures.
- 0b0001 Cache and branch predictor operations affect structures according to shareability and defined behavior of instructions. TLB operations only affect local structures.
- 0b0010 Cache, TLB and branch predictor operations affect structures according to shareability and defined behavior of instructions.

#### BP maintain, bits[11:8]

Indicates the supported branch predictor maintenance operations in an implementation with hierarchical cache maintenance operations. Permitted values are:

- 0b0000 None supported.
- 0b0001 Supported branch predictor maintenance operations are:
  - Invalidate all branch predictors.
- 0b0010 As for 0b0001, and adds:
  - Invalidate branch predictors by MVA.

#### Cache maintain set/way, bits[7:4]

Indicates the supported cache maintenance operations by set/way, in an implementation with hierarchical caches. Permitted values are:

- 0b0000 None supported.
- 0b0001 Supported hierarchical cache maintenance operations by set/way are:
  - Invalidate data cache by set/way
  - Clean data cache by set/way
  - Clean and invalidate data cache by set/way.

In a unified cache implementation, the data cache operations apply to the unified caches.

#### Cache maintain MVA, bits[3:0]

Indicates the supported cache maintenance operations by MVA, in an implementation with hierarchical caches. Permitted values are:

- 0b0000 None supported.
- 0b0001 Supported hierarchical cache maintenance operations by MVA are:
  - Invalidate data cache by MVA
  - Clean data cache by MVA
  - Clean and invalidate data cache by MVA
  - Invalidate instruction cache by MVA
  - Invalidate all instruction cache entries.

In a unified cache implementation, the data cache operations apply to the unified caches, and the instruction cache operations are not implemented.

### **Accessing ID\_MMFR3**

To access ID\_MMFR3, software reads the CP15 registers with <opc1> set to 0, <CRn> set to c0, <CRm> set to c1, and <opc2> set to 7. For example:

MRC p15, 0, <Rt>, c0, c1, 7 ; Read ID\_MMFR3 into Rt

### B4.1.93 ID\_PFR0, Processor Feature Register 0, VMSA

The ID\_PFR0 characteristics are:

- Purpose** ID\_PFR0 gives information about the programmers' model and top-level information about the instruction sets supported by the processor.  
 This register is a CPUID register, and is part of the Identification registers functional group.
- Usage constraints** Only accessible from PL1 or higher.  
 Must be interpreted with [ID\\_PFR1](#).
- Configurations** The VMSA and PMSA definitions of the register fields are identical.  
 In a VMSA implementation that includes the Security Extensions, this is a Common register.
- Attributes** A 32-bit RO register with an IMPLEMENTATION DEFINED value:
- [Table B7-1 on page B7-1950](#) shows the encodings of all of the CPUID registers
  - [Table B3-44 on page B3-1492](#) shows the encodings of all of the registers in the Identification registers functional group.
- All field values not shown in the field descriptions are reserved.

The ID\_PFR0 bit assignments are:

31					16	15			12	11		8	7		4	3	0
Reserved, UNK						State3		State2		State1		State0					

**Bits[31:16]** Reserved, UNK.

**State3, bits[15:12]**

ThumbEE instruction set support. Permitted values are:

- 0b0000 Not implemented.
- 0b0001 ThumbEE instruction set implemented.

The value of 0b0001 is only permitted when State1 == 0b0011.

**State2, bits[11:8]**

Jazelle extension support. Permitted values are:

- 0b0000 Not implemented.
- 0b0001 Jazelle extension implemented, without clearing of [JOSCR.CV](#) on exception entry.
- 0b0010 Jazelle extension implemented, with clearing of [JOSCR.CV](#) on exception entry.

A trivial implementation of the Jazelle extension is indicated by the value 0b0001.

**State1, bits[7:4]**

Thumb instruction set support. Permitted values are:

- 0b0000 Thumb instruction set not implemented.
- 0b0001 Thumb encodings before the introduction of Thumb-2 technology implemented:
  - all instructions are 16-bit
  - a BL or BLX is a pair of 16-bit instructions
  - 32-bit instructions other than BL and BLX cannot be encoded.
- 0b0010 Reserved.
- 0b0011 Thumb encodings after the introduction of Thumb-2 technology implemented, for all 16-bit and 32-bit Thumb basic instructions.

**State0, bits[3:0]**

ARM instruction set support. Permitted values are:

0b0000 ARM instruction set not implemented.

0b0001 ARM instruction set implemented.

**Accessing ID\_PFR0**

To access ID\_PFR0, software reads the CP15 registers with <opc1> set to 0, <CRn> set to c0, <CRm> set to c1, and <opc2> set to 0. For example:

MRC p15, 0, <Rt>, c0, c1, 0 ; Read ID\_PFR0 into Rt

### B4.1.94 ID\_PFR1, Processor Feature Register 1, VMSA

The ID\_PFR1 characteristics are:

- Purpose** ID\_PFR1 gives information about the programmers' model and Security Extensions support.  
 This register is a CPUID register, and is part of the Identification registers functional group.
- Usage constraints** Only accessible from PL1 or higher.  
 Must be interpreted with ID\_PFR0.
- Configurations** The VMSA and PMSA definitions of the register fields are identical.  
 In a VMSA implementation that includes the Security Extensions, this is a Common register.
- Attributes** A 32-bit RO register with an IMPLEMENTATION DEFINED value:
- [Table B7-1 on page B7-1950](#) shows the encodings of all of the CPUID registers
  - [Table B3-44 on page B3-1492](#) shows the encodings of all of the registers in the Identification registers functional group.
- All field values not shown in the field descriptions are reserved.

The ID\_PFR1 bit assignments are:

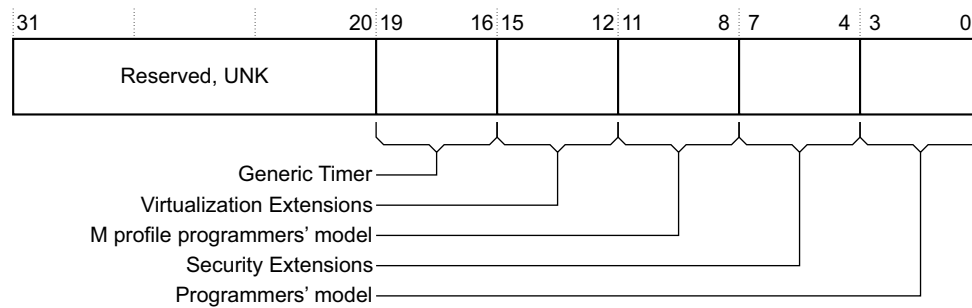

**Bits[31:20]** Reserved, UNK.

#### Generic Timer Extension, bits[19:16]

- Permitted values are:
- 0b0000 Not implemented.
  - 0b0001 Generic Timer Extension implemented.

#### Virtualization Extensions, bits[15:12]

- Permitted values are:
- 0b0000 Not implemented.
  - 0b0001 Virtualization Extensions implemented.

———— **Note** —————

A value of 0b0001 implies implementation of the HVC, ERET, MRS (Banked register), and MSR (Banked register) instructions. The ID\_ISARs do not identify whether these instructions are implemented.

### M profile programmers' model, bits[11:8]

Permitted values are:

0b0000 Not supported.

0b0010 Support for two-stack programmers' model.

———— **Note** —————

In this field, the permitted values are not continuous, and the value of 0b0001 is reserved.

### Security Extensions, bits[7:4]

Permitted values are:

0b0000 Not implemented.

0b0001 Security Extensions implemented.

This includes support for Monitor mode and the SMC instruction.

0b0010 As for 0b0001, and adds the ability to set the [NSACR](#).RFR bit.

### Programmers' model, bits[3:0]

Support for the standard programmers' model for ARMv4 and later. Model must support User, FIQ, IRQ, Supervisor, Abort, Undefined and System modes. Permitted values are:

0b0000 Not supported.

0b0001 Supported.

### Accessing ID\_PFR1

To access ID\_PFR1, software reads the CP15 registers with <opc1> set to 0, <CRn> set to c0, <CRm> set to c1, and <opc2> set to 1. For example:

MRC p15, 0, <Rt>, c0, c1, 1 ; Read ID\_PFR1 into Rt

### B4.1.95 IFAR, Instruction Fault Address Register, VMSA

The IFAR characteristics are:

- Purpose** The IFAR holds the VA of the faulting access that caused a synchronous Prefetch Abort exception.  
This register is part of the PL1 Fault handling registers functional group.
- Usage constraints** Only accessible from PL1 or higher.
- Configurations** If the implementation includes the Security Extensions, this register is Banked.
- Attributes** A 32-bit RW register with an UNKNOWN reset value. See also [Reset behavior of CP14 and CP15 registers on page B3-1450](#).  
[Table B3-46 on page B3-1494](#) shows the encodings of all of the registers in the PL1 Fault handling registers functional group.

The IFAR bit assignments are:

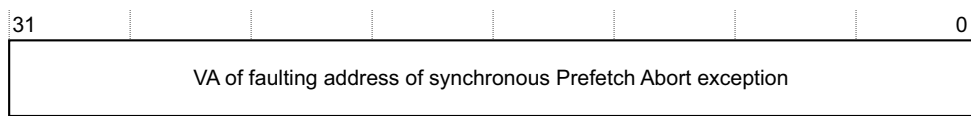

For information about using the IFAR see [Exception reporting in a VMSA implementation on page B3-1409](#).

A debugger can write to the IFAR to restore its value.

#### Accessing the IFAR

To access the IFAR, software reads or writes the CP15 registers with <opc1> set to 0, <CRn> set to c6, <CRm> set to c0, and <opc2> set to 2. For example:

```
MRC p15, 0, <Rt>, c6, c0, 2 ; Read IFAR into Rt  
MCR p15, 0, <Rt>, c6, c0, 2 ; Write Rt to IFAR
```



## B4.1.96 IFSR, Instruction Fault Status Register, VMSA

The IFSR characteristics are:

<b>Purpose</b>	The IFSR holds status information about the last instruction fault. This register is part of the PL1 Fault handling registers functional group.
<b>Usage constraints</b>	Only accessible from PL1 or higher.
<b>Configurations</b>	The Large Physical Address Extension adds an alternative format for the register. If an implementation includes the Large Physical Address Extension then the current translation table format determines which format of the register is used.  If the implementation includes the Security Extensions, this register is Banked.
<b>Attributes</b>	A 32-bit RW register with an UNKNOWN reset value. See also <a href="#">Reset behavior of CP14 and CP15 registers on page B3-1450</a> .  <a href="#">Table B3-46 on page B3-1494</a> shows the encodings of all of the registers in the PL1 Fault handling registers functional group.

For information about using the IFSR see [Exception reporting in a VMSA implementation on page B3-1409](#).

The following sections describe the alternative IFSR formats:

- [IFSR format when using the Short-descriptor translation table format](#)
- [IFSR format when using the Long-descriptor translation table format on page B4-1638](#).

### IFSR format when using the Short-descriptor translation table format

In a VMSAv7 implementation that does not include the Large Physical Address Extension, or in an implementation that includes the Large Physical Address Extension when address translation is using the Short-descriptor translation table format, the IFSR bit assignments are:

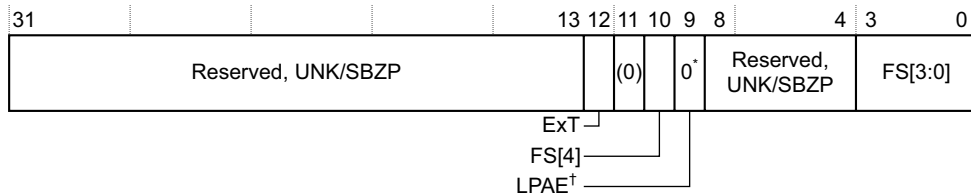

† Only on an implementation that includes the Large Physical Address Extension.  
 For more information, see the field description.

\* Returned value, but might be overwritten, because the bit is RW.

**Bits[31:13]** Reserved, UNK/SBZP.

**ExT, bit[12]** External abort type. This bit can provide an IMPLEMENTATION DEFINED classification of external aborts.

For aborts other than external aborts this bit always returns 0.

In an implementation that does not provide any classification of external aborts, this bit is UNK/SBZP.

**Bit[11]** Reserved, UNK/SBZP.

**FS, bits[10, 3:0]**

Fault status bits. For the valid encodings of these bits when using the Short-descriptor translation table format, see [Table B3-23 on page B3-1415](#). All encodings not shown in the table are reserved.

**LPAE, bit[9], if the implementation includes the Large Physical Address Extension**

On taking an exception, this bit is set to 0 to indicate use of the Short-descriptor translation table format.





The bit positions of the A, I and F bits in the ISR match the A, I and F bits in the [CPSR](#). This means software can use the same masks to extract the bits from the register value.

### Accessing the ISR

To access the ISR, software reads the CP15 registers with <opc1> set to 0, <CRn> set to c12, <CRm> set to c1, and <opc2> set to 0. For example:

```
MRC p15, 0, <Rt>, c12, c1, 0 ; Read ISR into Rt
```

#### **B4.1.98 ITLBIALL, Instruction TLB Invalidate All, VMSA only**

*TLB maintenance operations, not in Hyp mode on page B4-1743* describes this TLB maintenance operation.

This operation is part of the TLB maintenance operations functional group. [Table B3-50 on page B3-1497](#) shows the encodings of all of the registers and operations in this functional group.

#### **B4.1.99 ITLBIASID, Instruction TLB Invalidate by ASID, VMSA only**

*TLB maintenance operations, not in Hyp mode on page B4-1743* describes this TLB maintenance operation.

This operation is part of the TLB maintenance operations functional group. [Table B3-50 on page B3-1497](#) shows the encodings of all of the registers and operations in this functional group.

#### **B4.1.100 ITLBIMVA, Instruction TLB Invalidate by MVA, VMSA only**

*TLB maintenance operations, not in Hyp mode on page B4-1743* describes this TLB maintenance operation.

This operation is part of the TLB maintenance operations functional group. [Table B3-50 on page B3-1497](#) shows the encodings of all of the registers and operations in this functional group.

## B4.1.101 JIDR, Jazelle ID Register, VMSA

The JIDR characteristics are:

- Purpose** Identifies the Jazelle architecture and subarchitecture versions.  
 This register is a Jazelle register.
- Usage constraints** Read access rights depend on the execution privilege and the value of the `JOSCR.CD` bit. Write accesses are UNPREDICTABLE at PL1 or higher, and UNDEFINED at PL0. See [Access to Jazelle registers on page A2-100](#).
- Configurations** The VMSA and PMSA definitions of the register fields are identical.  
 Always implemented, but can be implemented as RAZ on a processor with a trivial implementation of the Jazelle extension.

———— **Note** —————

An implementation that includes the Virtualization Extensions must implement a trivial implementation of the Jazelle extension.

In an implementation that includes the Security Extensions, JIDR is a Common register.

- Attributes** A 32-bit RO register.  
[Table A2-17 on page A2-100](#) shows the encodings of all the Jazelle registers.

The JIDR bit assignments are:

31	28	27	20	19	12	11	0
Architecture	Implementer		Subarchitecture		SUBARCHITECTURE DEFINED		

### Architecture, bits[31:28]

Architecture code. This uses the same Architecture code that appears in the [MIDR](#).

On a trivial implementation of the Jazelle extension this field must be RAZ.

### Implementer, bits[27:20]

Implementer code of the designer of the subarchitecture. This uses the same Implementer code that appears in the [MIDR](#).

On a trivial implementation of the Jazelle extension this field must be RAZ.

### Subarchitecture, bits[19:12]

Contain the subarchitecture code. The following subarchitecture code is defined:

0x00 Jazelle v1 subarchitecture, or trivial implementation of Jazelle extension if the Implementer field is RAZ.

On a trivial implementation of the Jazelle extension this field must be RAZ.

- Bits[11:0]** Can contain additional SUBARCHITECTURE DEFINED information.

## Accessing the JIDR

To access the JIDR, software reads the CP14 registers with `<opc1>` set to 7, `<CRn>` set to c0, `<CRm>` set to c0, and `<opc2>` set to 0. For example:

```
MRC p14, 7, <Rt>, c0, c0, 0 ; Read JIDR into Rt
```

### B4.1.102 JMCR, Jazelle Main Configuration Register, VMSA

The JMCR characteristics are:

- Purpose** Provides control of the Jazelle extension.  
This register is a Jazelle register.
- Usage constraints** Access rights depend on the execution privilege and the value of the `JOSCR.CD` bit, see [Access to Jazelle registers on page A2-100](#).
- Configurations** The VMSA and PMSA definitions of the register fields are identical.  
Always implemented. A processor with a trivial implementation of the Jazelle extension must implement JMCR as RAZ/WI.  
In an implementation that includes the Security Extensions, JMCR is a Common register.
- Attributes** A 32-bit RW register. See the field descriptions for details about the reset value.  
[Table A2-17 on page A2-100](#) shows the encodings of all the Jazelle registers.

The JMCR bit assignments are:

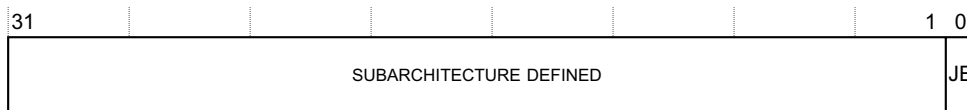

**Bits[31:1]** SUBARCHITECTURE DEFINED information. This means the reset value of this field is also SUBARCHITECTURE DEFINED.

**JE, bit[0]** Jazelle Enable bit:

**0** Jazelle extension disabled. The BXJ instruction does not cause Jazelle state execution. BXJ behaves exactly as a BX instruction, see [Jazelle state entry instruction, BXJ on page A2-98](#).

**1** Jazelle extension enabled.

The reset value of this bit is 0.

#### Accessing the JMCR

To access the JMCR, read or write the CP14 registers with `<opc1>` set to 7, `<CRn>` set to c2, `<CRm>` set to c0, and `<opc2>` set to 0. For example:

```
MRC p14, 7, <Rt>, c2, c0, 0 ; Read JMCR into Rt
MCR p14, 7, <Rt>, c2, c0, 0 ; Write Rt to JMCR
```

### B4.1.103 JOSCR, Jazelle OS Control Register, VMSA

The JOSCR characteristics are:

- Purpose** Provides operating system control of the use of the Jazelle extension by processes and threads.  
 This register is a Jazelle register.
- Usage constraints** Accessible only from PL1 or higher.  
 Normally used in conjunction with the [JMCR.JE](#) bit.
- Configurations** The VMSA and PMSA definitions of the register fields are identical.  
 Always implemented. A processor with a trivial implementation of the Jazelle extension must implement JOSCR either:
- as RAZ/WI
  - so that it can be read or written, but the processor ignores the effect of any read or write.
- In an implementation that includes the Security Extensions, JOSCR is a Common register.
- Attributes** A 32-bit RW register that resets to zero.  
[Table A2-17 on page A2-100](#) shows the encodings of all the Jazelle registers.

The JOSCR bit assignments are:

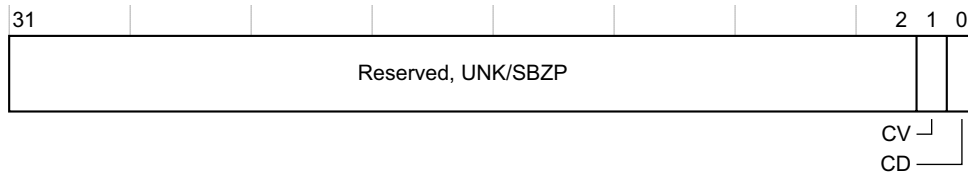

- Bits[31:2]** Reserved, UNK/SBZP.
- CV, bit[1]** Configuration Valid bit. This bit is used by an operating system to signal to the EJVM that it must rewrite its configuration to the configuration registers. The possible values are:
- 0** Configuration not valid. The EJVM must rewrite its configuration to the configuration registers before it executes another bytecode instruction.
  - 1** Configuration valid. The EJVM does not need to update the configuration registers.
- When the [JMCR.JE](#) bit is set to 1, the CV bit also controls entry to Jazelle state, see [Controlling entry to Jazelle state on page B1-1242](#).
- CD, bit[0]** Configuration Disabled bit. This bit is used by an operating system to disable User mode access to the [JIDR](#) and configuration registers:
- 0** Configuration enabled. Access to the Jazelle registers, including User mode accesses, operate normally. For more information, see the register descriptions in [Application level configuration and control of the Jazelle extension on page A2-99](#).
  - 1** Configuration disabled in User mode. User mode access to the Jazelle registers are UNDEFINED, and all User mode accesses to the Jazelle registers cause an Undefined Instruction exception.
- For more information about the use of this bit see [Monitoring and controlling User mode access to the Jazelle extension on page B1-1243](#).

The JOSCR provides a control mechanism that is independent of the subarchitecture of the Jazelle extension. An operating system can use this mechanism to control access to the Jazelle extension, see [Jazelle state configuration and control on page B1-1242](#).

## Accessing the JOSCR

To access the JOSCR, read or write the CP14 registers with <opc1> set to 7, <CRn> set to c1, <CRm> set to c0, and <opc2> set to 0. For example:

```
MRC p14, 7, <Rt>, c1, c0, 0 ; Read JOSCR into Rt  
MCR p14, 7, <Rt>, c1, c0, 0 ; Write Rt to JOSCR
```



## B4.1.104 MAIRO and MAIR1, Memory Attribute Indirection Registers 0 and 1, VMSA

The MAIRO and MAIR1 characteristics are:

- Purpose** MAIRO and MAIR1 provide the memory attribute encodings corresponding to the possible AttrIdx values in a Long-descriptor format translation table entry for stage 1 translations. For more information about the AttrIdx field see [Long-descriptor format memory region attributes on page B3-1372](#).
- These registers are part of the Virtual memory control registers functional group.
- Usage constraints** Only accessible from PL1 or higher.
- Only accessible when using the Long-descriptor translation table format. When using the Short-descriptor format see [PRRR, Primary Region Remap Register, VMSA on page B4-1698](#) and [NMRR, Normal Memory Remap Register, VMSA on page B4-1659](#).
- AttrIdx[2] selects the appropriate MAIR:
- setting AttrIdx[2] to 0 selects MAIRO
  - setting AttrIdx[2] to 1 selects MAIR1.
- In the implementation includes the Security Extensions:
- the Secure copies of the registers give the values for memory accesses from Secure state
  - the Non-secure copies of the registers give the values for memory accesses from Non-secure modes other than Hyp mode.
- Configurations** MAIRO and MAIR1 are implemented only as part of the Large Physical Address Extension. In an implementation that includes the Security Extensions they:
- are Banked
  - have write access to the Secure copy of the register disabled when the **CPI5SDISABLE** signal is asserted HIGH.
- Attributes** 32-bit RW registers with UNKNOWN reset values. See also [Reset behavior of CP14 and CP15 registers on page B3-1450](#).
- [Table B3-45 on page B3-1493](#) shows the encodings of all of the registers in the Virtual memory control registers functional group.

The MAIRO and MAIR1 bit assignments are:

	31	24	23	16	15	8	7	0
MAIRO	Attr3		Attr2		Attr1		Attr0	
MAIR1	Attr7		Attr6		Attr5		Attr4	

### Attrm[7:0], for values of m from 0 to 7

The memory attribute encoding for an AttrIdx[2:0] entry in a Long descriptor format translation table entry, where:

- AttrIdx[2] defines which MAIR to access
- AttrIdx[2:0] gives the value of m in Attrm.

[Table B4-7 on page B4-1646](#) shows the encoding of Attrn[7:4].

**Table B4-7 MAIRn.Attrm[7:4] encoding**

Attrm[7:4]	Meaning
0000	Strongly-ordered or Device memory, see encoding of Attrm[3:0].
00RW, RW not 00	It is IMPLEMENTATION DEFINED whether the encoding is: <ul style="list-style-type: none"> <li>• UNPREDICTABLE</li> <li>• Normal memory, Outer Write-Through<sup>b</sup> Transient.</li> </ul>
0100	Normal memory, Outer <sup>a</sup> Non-cacheable.
01RW, RW not 00	It is IMPLEMENTATION DEFINED whether the encoding is: <ul style="list-style-type: none"> <li>• UNPREDICTABLE</li> <li>• Normal memory, Outer Write-Back<sup>b</sup> Transient.</li> </ul>
10RW	Normal memory, Outer <sup>a</sup> Write-Through Cacheable <sup>b</sup> , Non-transient <sup>c</sup> .
11RW	Normal memory, Outer <sup>a</sup> Write-Back Cacheable <sup>b</sup> , Non-transient <sup>c</sup> .

- a. See encoding of Attrm[3:0], shown in [Table B4-8](#), for Inner cacheability policies.  
 b. R defines the Outer Read-Allocate policy, and W defined the Outer Write-Allocate policy, see [Table B4-9 on page B4-1647](#).  
 c. Non-transient if the implementation includes support for the Transient attribute.

The encoding of Attrm[3:0] depends on the value of Attrm[7:4], as [Table B4-8](#) shows.

**Table B4-8 MAIRn.Attrm[3:0] encoding**

Attrm[3:0]	Meaning when Attrm[7:4] is 0b0000	Meaning when Attrm[7:4] is not 0b0000
0000	Strongly-ordered memory	UNPREDICTABLE.
00RW, RW not 00	UNPREDICTABLE	It is IMPLEMENTATION DEFINED whether the encoding is: <ul style="list-style-type: none"> <li>• UNPREDICTABLE</li> <li>• Normal memory, Inner Write-Through<sup>a</sup> Transient.</li> </ul>
0100	Device memory	Normal memory, Inner Non-cacheable.
01RW, RW not 00	UNPREDICTABLE	It is IMPLEMENTATION DEFINED whether the encoding is: <ul style="list-style-type: none"> <li>• UNPREDICTABLE</li> <li>• Normal memory, Inner Write-Back<sup>a</sup> Transient.</li> </ul>
10RW	UNPREDICTABLE	Normal memory, Inner Write-Through Cacheable <sup>a</sup> , Non-transient <sup>b</sup> .
11RW	UNPREDICTABLE	Normal memory, Inner Write-Back Cacheable <sup>a</sup> , Non-transient <sup>b</sup> .

- a. R defines the Inner Read-Allocate policy, and W defines the Inner Write-Allocate policy, see [Table B4-9 on page B4-1647](#).  
 b. Non-transient if the implementation includes support for the Transient attribute.

Table B4-9 shows the encoding of the R and W bits that are used, in some *Attrm* encodings in Table B4-7 on page B4-1646 and Table B4-8 on page B4-1646, to define the read-allocate and write-allocate policies:

**Table B4-9 Encoding of R and W bits in some *Attrm* fields**

R or W	Meaning
0	Do not allocate
1	Allocate

The IMPLEMENTATION DEFINED meanings of the *Attrm*[7:4] *Attrm*[3:0] *0b0xyy* encodings must be consistent. This means that the IMPLEMENTATION DEFINED choice is that either:

- all of these encodings are UNPREDICTABLE
- this set of encodings provides the Normal memory Write-Through transient and Write-Back transient encodings.

See [Transient cacheability attribute, Large Physical Address Extension on page A3-134](#) for more information about the Transient attribute.

### Accessing MAIR0 or MAIR1

To access MAIR0 or MAIR1, software reads or writes the CP15 registers with <opc1> set to 0, <CRn> set to c10, <CRm> set to c2, and <opc2> set to 0 for MAIR0, or to 1 for MAIR1. For example:

```
MRC p15, 0, <Rt>, c10, c2, 0 ; Read MAIR0 into Rt  
MCR p15, 0, <Rt>, c10, c2, 1 ; Write Rt to MAIR1
```

### B4.1.105 MIDR, Main ID Register, VMSA

The MIDR characteristics are:

- Purpose** The MIDR provides identification information for the processor, including an implementer code for the device and a device ID number.  
 This register is part of the Identification registers functional group.
- Usage constraints** Only accessible from PL1 or higher.
- Configurations** If the implementation includes the Security Extensions, this register is Common.  
 Some fields of the MIDR are IMPLEMENTATION DEFINED. For details of the values of these fields for a particular ARMv7 implementation, and any implementation-specific significance of these values, see the product documentation.
- Attributes** A 32-bit RO register with an IMPLEMENTATION DEFINED value. See also [Reset behavior of CP14 and CP15 registers on page B3-1450](#).  
[Table B3-44 on page B3-1492](#) shows the encodings of all of the registers in the Identification registers functional group.

The MIDR bit assignments are:

31	24 23	20 19	16 15	4 3	0
Implementer	Variant	Architecture	Primary part number	Revision	

#### Implementer, bits[31:24]

The Implementer code. [Table B4-10](#) shows the permitted values for this field:

**Table B4-10 Implementer codes**

Bits[31:24]	ASCII character	Implementer
0x41	A	ARM Limited
0x44	D	Digital Equipment Corporation
0x4D	M	Motorola, Freescale Semiconductor Inc.
0x51	Q	Qualcomm Inc.
0x56	V	Marvell Semiconductor Inc.
0x69	i	Intel Corporation

All other values are reserved by ARM and must not be used.

#### Variant, bits[23:20]

An IMPLEMENTATION DEFINED variant number. Typically, this field distinguishes between different product variants, or major revisions of a product.

**Architecture, bits[19:16]**

Table B4-11 shows the permitted values for this field:

**Table B4-11 Architecture codes**

Bits[19:16]	Architecture
0x1	ARMv4
0x2	ARMv4T
0x3	ARMv5 (obsolete)
0x4	ARMv5T
0x5	ARMv5TE
0x6	ARMv5TEJ
0x7	ARMv6
0xF	Defined by CPUID scheme

All other values are reserved by ARM and must not be used.

**Primary part number, bits[15:4]**

An IMPLEMENTATION DEFINED primary part number for the device.

**Note**

- On processors implemented by ARM, if the top four bits of the primary part number are 0x0 or 0x7, the variant and architecture are encoded differently, see the description of the MIDR in [Appendix O ARMv4 and ARMv5 Differences](#).
- Processors implemented by ARM have an Implementer code of 0x41.

**Revision, bits[3:0]**

An IMPLEMENTATION DEFINED revision number for the device.

ARMv7 requires all implementations to use the CPUID scheme, described in [Chapter B7 The CPUID Identification Scheme](#), and an implementation is described by the MIDR with the CPUID registers.

**Note**

For an ARMv7 implementation by ARM, the MIDR is interpreted as:

- Bits[31:24]** Implementer code, must be 0x41.
- Bits[23:20]** Major revision number, rX.
- Bits[19:16]** Architecture code, must be 0xF.
- Bits[15:4]** ARM part number.
- Bits[3:0]** Minor revision number, pY.

**Accessing the MIDR**

To access the MIDR, software reads the CP15 registers with <opc1> set to 0, <CRn> set to c0, <CRm> set to c0, and <opc2> set to 0. For example:

```
MRC p15, 0, <Rt>, c0, c0, 0 ; Read MIDR into Rt
```

### B4.1.106 MPIDR, Multiprocessor Affinity Register, VMSA

The MPIDR characteristics are:

- Purpose** In a multiprocessor system, the MPIDR provides an additional processor identification mechanism for scheduling purposes, and indicates whether the implementation includes the Multiprocessing Extensions.  
 This register is part of the Identification registers functional group.
- Usage constraints** Only accessible from PL1 or higher.
- Configurations** This register is not implemented in architecture versions before ARMv7.  
 In a uniprocessor system ARM recommends that this register returns a value of 0.  
 If the implementation includes the Security Extensions, the register is Common.
- Attributes** A 32-bit RO register with an IMPLEMENTATION DEFINED value. See also [Reset behavior of CP14 and CP15 registers on page B3-1450](#).  
[Table B3-44 on page B3-1492](#) shows the encodings of all of the registers in the Identification registers functional group.

In an implementation that does not include the Multiprocessing Extensions, the MPIDR bit assignments are:

31	24 23	16 15	8 7	0
Reserved, RAZ	Aff2	Aff1	Aff0	

In an implementation that includes the Multiprocessing Extensions, the MPIDR bit assignments are:

31	30	29	25 24 23	16 15	8 7	0
1	U	Reserved, UNK	Aff2	Aff1	Aff0	
		MT				

———— **Note** —————

In the MPIDR bit definitions, a *processor in the system* can be a physical processor or a virtual machine.

**Bits[31:24], ARMv7 without Multiprocessing Extensions**

Reserved, RAZ.

**Bits[31], in an implementation that includes the Multiprocessing Extensions**

RAO. Indicates that the implementation uses the Multiprocessing Extensions register format.

**U, bit[30], in an implementation that includes the Multiprocessing Extensions**

Indicates a Uniprocessor system, as distinct from processor 0 in a multiprocessor system. The possible values of this bit are:

- 0** Processor is part of a multiprocessor system.
- 1** Processor is part of a uniprocessor system.

**Bits[29:25], in an implementation that includes the Multiprocessing Extensions**

Reserved, UNK.

### MT, bit[24], in an implementation that includes the Multiprocessing Extensions

Indicates whether the lowest level of affinity consists of logical processors that are implemented using a multi-threading type approach. The possible values of this bit are:

- 0 Performance of processors at the lowest affinity level is largely independent.
- 1 Performance of processors at the lowest affinity level is very interdependent.

For more information about the meaning of this bit see [Multi-threading approach to lowest affinity levels, Multiprocessing Extensions](#).

### Aff2, bits[23:16]

Affinity level 2. The least significant affinity level field, for this processor in the system.

### Aff1, bits[15:8]

Affinity level 1. The intermediate affinity level field, for this processor in the system.

### Aff0, bits[7:0]

Affinity level 0. The most significant affinity level field, for this processor in the system.

See [Recommended use of the MPIDR](#) for clarification of the meaning of *most significant* and *least significant* affinity levels.

In the system as a whole, for each of the affinity level fields, the assigned values must start at 0 and increase monotonically.

When matching against an affinity level field, scheduler software checks for a value equal to or greater than a required value.

[Recommended use of the MPIDR](#) includes a description of an example multiprocessor system and the affinity level field values it might use.

The interpretation of these fields is IMPLEMENTATION DEFINED, and must be documented as part of the documentation of the multiprocessor system. ARM recommends that this register might be used as described in [Recommended use of the MPIDR](#).

The software mechanism to discover the total number of affinity numbers used at each level is IMPLEMENTATION DEFINED, and is part of the general system identification task.

## Multi-threading approach to lowest affinity levels, Multiprocessing Extensions

In an implementation that includes the Multiprocessing Extensions, if the MPIDR.MT bit is set to 1, this indicates that the processors at affinity level 0 are logical processors, implemented using a multi-threading type approach. In such an approach, there can be a significant performance impact if a new thread is assigned the processor with:

- a different affinity level 0 value to some other thread, referred to as the original thread
- a pair of values for affinity levels 1 and 2 that are the same as the pair of values of the original thread.

In this situation, the performance of the original thread might be significantly reduced.

### ———— Note —————

In this description, thread always refers to a thread or a process.

## Recommended use of the MPIDR

In a multiprocessor system the register might provide two important functions:

- Identifying special functionality of a particular processor in the system. In general, the actual meaning of the affinity level fields is not important. In a small number of situations, an affinity level field value might have a special IMPLEMENTATION DEFINED significance. Possible examples include booting from reset and powerdown events.

- Providing affinity information for the scheduling software, to help the scheduler run an individual thread or process on either:
  - the same processor, or as similar a processor as possible, as the processor it was running on previously
  - a processor on which a related thread or process was run.

MPIDR provides a mechanism with up to three levels of affinity information, but the meaning of those levels of affinity is entirely IMPLEMENTATION DEFINED. The levels of affinity provided can have different meanings.

Table B4-12 shows two possible implementations:

**Table B4-12 Possible implementations of the affinity levels**

Affinity level	Example system 1	Example system 2
0	Virtual CPUs in a multi-threaded processor	Processors in an SMP cluster
1	Processors in an <i>Symmetric Multi Processor</i> (SMP) cluster	Clusters with a system
2	Clusters in a system	No meaning, fixed as 0

The scheduler maintains affinity level information for all threads and processes. When it has to reschedule a thread or process, the scheduler:

1. Looks for an available processor that matches at all three affinity levels.
2. If step 1 fails, the scheduler might look for a processor that matches at levels 1 and 2 only.
3. If the scheduler still cannot find an available processor it might look for a match at level 2 only.

A multiprocessor system corresponding to Example system 1 in Table B4-12 might implement affinity values as shown in Table B4-13:

**Table B4-13 Example of possible affinity values at different affinity levels**

Aff2, Cluster level, values	Aff1, Processor level, values	Aff0, Virtual CPU level, values
0	0	0, 1
0	1	0, 1
0	2	0, 1
0	3	0, 1
1	0	0, 1
1	1	0, 1
1	2	0, 1
1	3	0, 1

### Accessing the MPIDR

To access MPIDR, software reads the CP15 registers with <opc1> set to 0, <CRn> set to c0, <CRm> set to c0, and <opc2> set to 5. For example:

```
MRC p15, 0, <Rt>, c0, c0, 5 ; Read MPIDR into Rt
```



## B4.1.107 MVBAR, Monitor Vector Base Address Register, Security Extensions

The MVBAR characteristics are:

<b>Purpose</b>	The MVBAR holds the exception base address for all exceptions that are taken to Monitor mode, see <a href="#">Exception vectors and the exception base address on page B1-1164</a> . This register is part of the Security Extensions registers functional group.
<b>Usage constraints</b>	Only accessible from Secure PL1 modes. Secure software must program the MVBAR with the required initial value as part of the processor boot sequence.
<b>Configurations</b>	Only present in an implementation that includes the Security Extensions. A Restricted access register, meaning it exists only in the Secure state.
<b>Attributes</b>	A 32-bit RW register with an UNKNOWN reset value. See also <a href="#">Reset behavior of CP14 and CP15 registers on page B3-1450</a> . <a href="#">Table B3-54 on page B3-1500</a> shows the encoding of all of the Security Extensions registers.

The MVBAR bit assignments are:

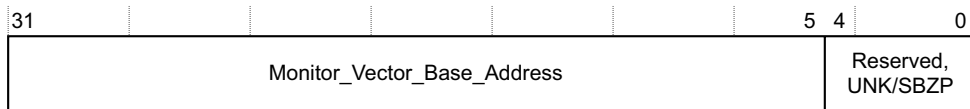

### Monitor\_Vector\_Base\_Address, bits[31:5]

Bits[31:5] of the base address of the exception vectors for exceptions that are taken to Monitor mode. Bits[4:0] of an exception vector is the exception offset, see [Table B1-3 on page B1-1166](#).

**Bits[4:0]** Reserved, UNK/SBZP.

For details of how the MVBAR determines the exception addresses see [Exception vectors and the exception base address on page B1-1164](#).

### Accessing the MVBAR

To access the MVBAR, software reads or writes the CP15 registers with <opc1> set to 0, <CRn> set to c12, <CRm> set to c0, and <opc2> set to 1. For example:

```
MRC p15, 0, <Rt>, c12, c0, 1 ; Read MVBAR into Rt
MCR p15, 0, <Rt>, c12, c0, 1 ; Write Rt to MVBAR
```

### B4.1.108 MVFR0, Media and VFP Feature Register 0, VMSA

The MVFR0 characteristics are:

- Purpose** Describes the features provided by the Advanced SIMD and Floating-point Extensions.
- Usage constraints** Only accessible from PL1 or higher. See [Accessing the Advanced SIMD and Floating-point Extension system registers on page B1-1236](#) for more information.  
 Must be interpreted with **MVFR1**. This register complements the information provided by the CPUID scheme described in [Chapter B7 The CPUID Identification Scheme](#).
- Configurations** Implemented only if the implementation includes one or both of:
- the Floating-point Extension
  - the Advanced SIMD Extension.
- The VMSA and PMSA definitions of the register fields are identical.
- In an implementation that includes the Security Extensions, MVFR0 is a Configurable access register. When the settings in the **CPACR** permit access to the register:
- it is accessible in Non-secure state only if the **NSACR**.{CP11, CP10} bits are both set to 1
  - if the implementation also includes the Virtualization Extensions then bits in the **HCPTR** also control Non-secure access to the register.
- For more information, see [Access controls on CP0 to CP13 on page B1-1226](#).

**Attributes** A 32-bit RO register.  
[Table B1-24 on page B1-1235](#) shows the encodings of all of the Advanced SIMD and Floating-point Extension system registers

The MVFR0 bit assignments are:

31	28	27	24	23	20	19	16	15	12	11	8	7	4	3	0	
VFP rounding modes				Short vectors		Square root		Divide		VFP exception trapping		Double-precision		Single-precision		A_SIMD registers

#### VFP rounding modes, bits[31:28]

Indicates the rounding modes supported by the Floating-point Extension hardware. Permitted values are:

- 0b0000 Only Round to Nearest mode supported, except that Round towards Zero mode is supported for VCVT instructions that always use that rounding mode regardless of the **FPSCR** setting.
- 0b0001 All rounding modes supported.

#### Short vectors, bits[27:24]

Indicates the hardware support for VFP short vectors. Permitted values are:

- 0b0000 Not supported.
- 0b0001 Short vector operation supported.

#### Square root, bits[23:20]

Indicates the hardware support for the Floating-point Extension square root operations. Permitted values are:

- 0b0000 Not supported in hardware.
- 0b0001 Supported.

———— **Note** —————

- the VSQRT.F32 instruction also requires the single-precision Floating-point attribute, bits[7:4]
- the VSQRT.F64 instruction also requires the double-precision Floating-point attribute, bits[11:8].

### Divide, bits[19:16]

Indicates the hardware support for Floating-point Extension divide operations. Permitted values are:

- 0b0000 Not supported in hardware.
- 0b0001 Supported.

---

**Note**

---

- the VDIV.F32 instruction also requires the single-precision Floating-point attribute, bits[7:4]
  - the VDIV.F64 instruction also requires the double-precision Floating-point attribute, bits[11:8].
- 

### VFP exception trapping, bits[15:12]

Indicates whether the Floating-point Extension hardware implementation supports exception trapping. Permitted values are:

- 0b0000 Not supported. This is the value for VFPv3 and VFPv4.
- 0b0001 Supported by the hardware. This is the value for VFPv2, and for VFPv3U and VFPv4U. When exception trapping is supported, support code is required to handle the trapped exceptions.

---

**Note**

---

This value does not indicate that trapped exception handling is available. Because trapped exception handling requires support code, only the support code can provide this information.

---

### Double-precision, bits[11:8]

Indicates the hardware support for the Floating-point Extension double-precision operations. Permitted values are:

- 0b0000 Not supported in hardware.
- 0b0001 Supported, VFPv2.
- 0b0010 Supported, VFPv3 or VFPv4.  
VFPv3 adds an instruction to load a double-precision floating-point constant, and conversions between double-precision and fixed-point values.

A value of 0b0001 or 0b0010 indicates support for all the floating-point double-precision instructions in the supported version of the Floating-point Extension, except that, in addition to this field being nonzero:

- VSQRT.F64 is available only if the Square root field is 0b0001
- VDIV.F64 is available only if the Divide field is 0b0001
- conversion between double-precision and single-precision is available only if the single-precision field is nonzero.

### Single-precision, bits[7:4]

Indicates the hardware support for the Floating-point Extension single-precision operations. Permitted values are:

0b0000 Not supported in hardware.

0b0001 Supported, VFPv2.

0b0010 Supported, VFPv3 or VFPv4.

VFPv3 adds an instruction to load a single-precision floating-point constant, and conversions between single-precision and fixed-point values.

A value of 0b0001 or 0b0010 indicates support for all floating-point single-precision instructions in the supported version of the Floating-point Extension, except that, in addition to this field being nonzero:

- VSQRT.F32 is only available if the Square root field is 0b0001
- VDIV.F32 is only available if the Divide field is 0b0001
- conversion between double-precision and single-precision is only available if the double-precision field is nonzero.

### A\_SIMD registers, bits[3:0]

Indicates support for the Advanced SIMD register bank. Permitted values are:

0b0000 Not supported.

0b0001 Supported, 16 × 64-bit registers.

0b0010 Supported, 32 × 64-bit registers.

If this field is nonzero:

- all Floating-point Extension LDC, STC, MCR, and MRC instructions are supported
- if the CPUID register shows that the MCRR and MRRC instructions are supported then the corresponding Floating-point Extension instructions are supported.

## Accessing MVFR0

Software accesses MVFR0 using the VMRS instruction, see [VMRS on page B9-2012](#). For example:

```
VMRS <Rt>, MVFR0 ; Read MVFR0 into Rt
```

## B4.1.109 MVFR1, Media and VFP Feature Register 1, VMSA

The MVFR1 characteristics are:

- Purpose** Describes the features provided by the Advanced SIMD and Floating-point Extensions.
- Usage constraints** Only accessible from PL1 or higher. See [Accessing the Advanced SIMD and Floating-point Extension system registers on page B1-1236](#) for more information.  
 Must be interpreted with [MVFR0](#). These registers complement the information provided by the CUID scheme described in [Chapter B7 The CUID Identification Scheme](#).
- Configurations** Implemented only if the implementation includes one or both of:
- the Floating-point Extension
  - the Advanced SIMD Extension.
- The VMSA and PMSA definitions of the register fields are identical.
- In an implementation that includes the Security Extensions, MVFR1 is a Configurable access register. When the settings in the [CPACR](#) permit access to the register:
- it is accessible in Non-secure state only if the [NSACR](#).{CP11, CP10} bits are both set to 1
  - if the implementation also includes the Virtualization Extensions then bits in the [HCPTR](#) also control Non-secure access to the register.
- For more information, see [Access controls on CP0 to CP13 on page B1-1226](#).

**Attributes** A 32-bit RO register.  
[Table B1-24 on page B1-1235](#) shows the encodings of all of the Advanced SIMD and Floating-point Extension system registers

The MVFR1 bit assignments are:

31	28	27	24	23	20	19	16	15	12	11	8	7	4	3	0
A_SIMD FMAC		VFP HPFP		A_SIMD HPFP		A_SIMD SPFP		A_SIMD integer		A_SIMD load/store		D_NaN mode		FtZ mode	

### A\_SIMD FMAC, bits[31:28]

Indicates whether any implemented Floating-point or Advanced SIMD Extension implements the fused multiply accumulate instructions. Permitted values are:

- 0b0000 Not implemented.
- 0b0001 Implemented.

If an implementation includes both the Floating-point Extension and the Advanced SIMD Extension, both extensions must provide the same level of support for these instructions.

### VFP HPFP, bits[27:24]

Indicates whether the Floating-point Extension implements half-precision floating-point conversion instructions. Permitted values are:

- 0b0000 Not implemented.
- 0b0001 Implemented.

### A\_SIMD HPFP, bits[23:20]

Indicates whether the Advanced SIMD Extension implements half-precision floating-point conversion instructions. Permitted values are:

- 0b0000 Not implemented.
- 0b0001 Implemented. This value is permitted only if the A\_SIMD SPFP field is 0b0001.

#### A\_SIMD SPFP, bits[19:16]

Indicates whether the Advanced SIMD Extension implements single-precision floating-point instructions. Permitted values are:

- 0b0000 Not implemented.
- 0b0001 Implemented. This value is permitted only if the A\_SIMD integer field is 0b0001.

#### A\_SIMD integer, bits[15:12]

Indicates whether the Advanced SIMD Extension implements integer instructions. Permitted values are:

- 0b0000 Not implemented.
- 0b0001 Implemented.

#### A\_SIMD load/store, bits[11:8]

Indicates whether the Advanced SIMD Extension implements load/store instructions. Permitted values are:

- 0b0000 Not implemented.
- 0b0001 Implemented.

#### D\_NaN mode, bits[7:4]

Indicates whether the Floating-point Extension hardware implementation supports only the Default NaN mode. Permitted values are:

- 0b0000 Hardware supports only the Default NaN mode. If a VFP subarchitecture is implemented its support code might include support for propagation of NaN values.
- 0b0001 Hardware supports propagation of NaN values.

#### FtZ mode, bits[3:0]

Indicates whether the Floating-point Extension hardware implementation supports only the Flush-to-Zero mode of operation. Permitted values are:

- 0b0000 Hardware supports only the Flush-to-Zero mode of operation. If a VFP subarchitecture is implemented its support code might include support for full denormalized number arithmetic.
- 0b0001 Hardware supports full denormalized number arithmetic.

### Accessing MVFR1

Software accesses MVFR1 using the VMRS instruction, see [VMRS on page B9-2012](#). For example:

```
VMRS <Rt>, MVFR1 ; Read MVFR1 into Rt
```

## B4.1.110 NMRR, Normal Memory Remap Register, VMSA

The NMRR characteristics are:

- Purpose** Under the conditions described in [Architectural status of PRRR and NMRR on page B4-1700](#), NMRR provides additional mapping controls for memory regions that are mapped as Normal memory by their entry in the PRRR. For more information see [Short-descriptor format memory region attributes, with TEX remap on page B3-1368](#).  
 This register is part of the Virtual memory control registers functional group.
- Usage constraints** Only accessible from PL1 or higher.  
 Used in conjunction with the PRRR.  
 In a processor that implements the Large Physical Address Extension, not accessible when using the Long-descriptor translation table format. See, instead, [MAIRO and MAIR1, Memory Attribute Indirection Registers 0 and 1, VMSA on page B4-1645](#).  
 See also [Architectural status of PRRR and NMRR on page B4-1700](#).
- Configurations** In an implementation that includes the Security Extensions, the NMRR:
- is Banked
  - has write access to the Secure copy of the register disabled when the CPI5SDISABLE signal is asserted HIGH.
- Attributes** A 32-bit RW register with an UNKNOWN reset value. See also [Reset behavior of CP14 and CP15 registers on page B3-1450](#).  
[Table B3-45 on page B3-1493](#) shows the encodings of all of the registers in the Virtual memory control registers functional group.

The NMRR bit assignments are:

31	30	29	28	27	26	25	24	23	22	21	20	19	18	17	16	15	14	13	12	11	10	9	8	7	6	5	4	3	2	1	0
OR7	OR6	OR5	OR4	OR3	OR2	OR1	OR0	IR7	IR6	IR5	IR4	IR3	IR2	IR1	IR0																

### OR $n$ , bits[2 $n$ +17:2 $n$ +16], for values of $n$ from 0 to 7

Outer Cacheable property mapping for memory attributes  $n$ , if the region is mapped as Normal memory by the PRRR.TR $n$  entry.  $n$  is the value of the TEX[0], C and B bits, see [Table B4-28 on page B4-1700](#). The possible values of this field are:

- 00** Region is Non-cacheable.
- 01** Region is Write-Back, Write-Allocate.
- 10** Region is Write-Through, no Write-Allocate.
- 11** Region is Write-Back, no Write-Allocate.

The meaning of the field with  $n = 6$  is IMPLEMENTATION DEFINED and might differ from the meaning given here. This is because the meaning of the attribute combination {TEX[0] = 1, C = 1, B = 0} is IMPLEMENTATION DEFINED.

### IR $n$ , bits[2 $n$ +1:2 $n$ ], for values of $n$ from 0 to 7

Inner Cacheable property mapping for memory attributes  $n$ , if the region is mapped as Normal Memory by the PRRR.TR $n$  entry.  $n$  is the value of the TEX[0], C and B bits, see [Table B4-28 on page B4-1700](#). The possible values of this field are the same as those given for the OR $n$  field.

The meaning of the field with  $n = 6$  is IMPLEMENTATION DEFINED and might differ from the meaning given here. This is because the meaning of the attribute combination {TEX[0] = 1, C = 1, B = 0} is IMPLEMENTATION DEFINED.

For more information about the NMRR see [Short-descriptor format memory region attributes, with TEX remap on page B3-1368](#).

### **Accessing the NMRR**

To access the NMRR, software reads or writes the CP15 registers with <opc1> set to 0, <CRn> set to c10, <CRm> set to c2, and <opc2> set to 1. For example:

```
MRC p15, 0, <Rt>, c10, c2, 1 ; Read NMRR into Rt  
MCR p15, 0, <Rt>, c10, c2, 1 ; Write Rt to NMRR
```



### B4.1.111 NSACR, Non-Secure Access Control Register, Security Extensions

The NSACR characteristics are:

<b>Purpose</b>	<p>The NSACR:</p> <ul style="list-style-type: none"> <li>• Defines the Non-secure access permissions to coprocessors CP0 to CP13.</li> <li>• Can include additional IMPLEMENTATION DEFINED bits that define Non-secure access permissions for IMPLEMENTATION DEFINED functionality.</li> <li>• In an implementation that includes the Virtualization Extensions, controls Hyp mode access to:                     <ul style="list-style-type: none"> <li>— coprocessors CP0 to CP13</li> <li>— floating-point and Advanced SIMD functionality.</li> </ul> </li> </ul> <p>This register is part of the Security Extensions registers functional group.</p>
<b>Usage constraints</b>	<p>Only accessible from PL1 or higher, with access rights that depend on the mode and security state:</p> <ul style="list-style-type: none"> <li>• the NSACR is read/write in Secure PL1 modes</li> <li>• the NSACR is read-only in Non-secure PL1 and PL2 modes.</li> </ul>
<b>Configurations</b>	<p>The NSACR is implemented only as part of the Security Extensions. It is a Restricted access register, but can be read from Non-secure state.</p>
<b>Attributes</b>	<p>A 32-bit RW register with a reset value that depends on the implementation. For more information, see the register field descriptions. See also <a href="#">Reset behavior of CP14 and CP15 registers on page B3-1450</a>.</p> <p><a href="#">Table B3-54 on page B3-1500</a> shows the encoding of all of the Security Extensions registers.</p>

The NSACR bit assignments are:

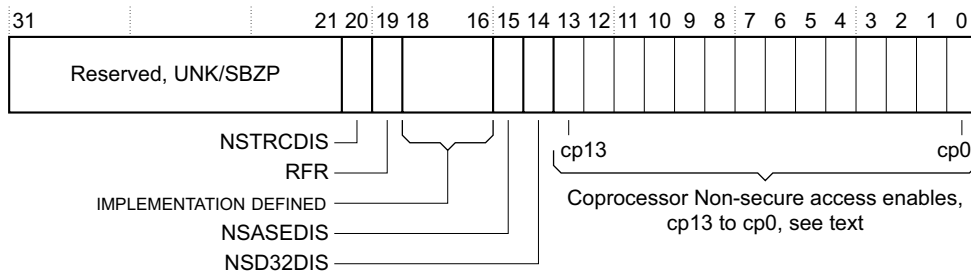

**Bits[31:21]** Reserved, UNK/SBZP.

#### NSTRCDIS, bit[20]

Disable Non-secure access to CP14 trace registers.

The implementation of this bit must correspond to the implementation of the [CPACR](#).TRCDIS bit:

- if [CPACR](#).TRCDIS is RAZ/WI then this bit is RAZ/WI
- if [CPACR](#).TRCDIS is RW then this bit is RW.

If NSTRCDIS is RW its possible values are:

**0** This bit has no effect on the ability to write to [CPACR](#).TRCDIS.

**1** When executing in Non-secure state:

- [CPACR](#).TRCDIS behaves as RAO/WI, regardless of its actual value.
- In an implementation that includes the Virtualization Extensions, [HCPTR](#).TTA behaves as RAO/WI, regardless of its actual value.

See the [CPACR](#).TRCDIS description for more information about when this bit can be RW.

If this bit is implemented as an RW bit, it resets to 0.

**RFR, bit[19]** Reserve FIQ Registers:

- 0** FIQ mode and the FIQ Banked registers are accessible in Secure and Non-secure security states.
- 1** FIQ mode and the FIQ Banked registers are accessible in the Secure security state only. Any attempt to access any FIQ Banked register or to enter FIQ mode when in the Non-secure security state is UNPREDICTABLE.

It is IMPLEMENTATION DEFINED whether this bit is supported. If it is not supported it is RAZ/WI.

If this bit is implemented as an RW bit, it resets to 0.

If NSACR.RFR is set to 1 when `SCR.FIQ == 0`, instruction execution is UNPREDICTABLE in Non-secure state.

From the introduction of the Virtualization Extensions, ARM deprecates any use of this bit.

**Bits[18:16]** IMPLEMENTATION DEFINED.

These bits can define the Non-secure access permissions for IMPLEMENTATION DEFINED features.

**NSASEDIS, bit[15]**

Disable Non-secure Advanced SIMD functionality.

The implementation of this bit must correspond to the implementation of the `CPACR.ASEDIS` bit.

This means:

- If a processor:
  - implements the Floating-point Extension but does not implement the Advanced SIMD Extension, this bit is RAO/WI
  - does not implement the Floating-point Extension or the Advanced SIMD Extension, this bit is UNK/SBZP.
- If a processor implements both the Floating-point Extension and the Advanced SIMD Extension, it is IMPLEMENTATION DEFINED whether `CPACR.ASEDIS` is RAZ/WI or RW, and the NSASEDIS bit must behave in the same way.

If NSASEDIS is RW, its possible values are:

- 0** This bit has no effect on the ability to write to `CPACR.ASEDIS`.
- 1** When executing in Non-secure state:
  - `CPACR.ASEDIS` behaves as RAO/WI, regardless of its actual value.
  - In an implementation that includes the Virtualization Extensions, `HCPTR.TASE` behaves as RAO/WI, regardless of its actual value.

If this bit is implemented as an RW bit, it resets to 0.

**NSD32DIS, bit[14]**

Disable Non-secure use of registers D16-D31 of the Floating-point Extension register file

The implementation of this bit must correspond to the implementation of the `CPACR.D32DIS` bit.

This means:

- If a processor:
  - implements the Floating-point Extension but does not implement D16-D31, this bit is RAO/WI
  - does not implement Floating-point Extension, this bit is UNK/SBZP.
- If a processor implements the Floating-point Extension and implements D16-D31, it is IMPLEMENTATION DEFINED whether `CPACR.D32DIS` is RAZ/WI or RW, and the NSD32DIS must behave in the same way.

If NSD32DIS is RW, its possible values are:

- 0** This bit has no effect on the ability to write to `CPACR.D32DIS`.
- 1** When executing in Non-secure state, `CPACR.D32DIS` is RAO/WI.

When this bit is RW, if it is set to 1 when NSACR.NSASEDIS is set to 0, the result is UNPREDICTABLE.

If this bit is implemented as an RW bit, it resets to 0.

### cp $n$ , bit[n], for values of n from 0 to 13

Non-secure access to coprocessor  $n$  enable. Each bit enables access to the corresponding coprocessor from Non-secure state:

**0** Coprocessor  $n$  can be accessed only from Secure state. Any attempt to access coprocessor  $n$  in Non-secure state results in an Undefined Instruction exception.

If the processor is in Non-secure state:

- The corresponding field in the CPACR reads as 0b00, and ignores writes, regardless of its actual value.
- In an implementation that includes the Virtualization Extensions, HCPTR.TCP $n$  behaves as RAO/WI, regardless of its actual value.

**1** Coprocessor  $n$  can be accessed from any security state.

If Non-secure access to a coprocessor is enabled, for accesses from Non-secure modes other than Hyp mode, the CPACR must be checked to determine the level of access that is permitted.

If multiple coprocessors are required to control a particular feature then the Non-secure access enable bits for those coprocessors must be set to the same value, otherwise behavior is UNPREDICTABLE. For example, in an implementation that includes the Floating-point Extension, the extension is controlled by coprocessors 10 and 11, and bits[10, 11] of the NSACR must be set to the same value.

For bits that correspond to coprocessors that are not implemented, it is IMPLEMENTATION DEFINED whether the bits:

- behave as RAZ/WI
- can be written by Secure PL1 modes.

Coprocessors 8, 9, 12, and 13 are reserved for future use by ARM, and therefore are never implemented.

### Accessing the NSACR

To access the NSACR, software reads or writes the CP15 registers with <opc1> set to 0, <CRn> set to c1, <CRm> set to c1, and <opc2> set to 2. For example:

```
MRC p15, 0, <Rt>, c1, c1, 2 ; Read NSACR into Rt
MCR p15, 0, <Rt>, c1, c1, 2 ; Write Rt to NSACR
```

### B4.1.112 PAR, Physical Address Register, VMSA

The PAR characteristics are:

<b>Purpose</b>	Receives the PA from any address translation operation. This register is part of the Address translation operations functional group.
<b>Usage constraints</b>	Only accessible from PL1 or higher. An implementation that does not support a memory attribute can report its corresponding behavior instead of the actual value in the translation table entry. Write access to the register means its contents can be context switched.
<b>Configurations</b>	If the implementation includes the Large Physical Address Extension, the PAR is extended to be a 64-bit register and: <ul style="list-style-type: none"> <li>• The 64-bit PAR is used if any of the following applies:                         <ul style="list-style-type: none"> <li>— When using the Long-descriptor translation table format.</li> <li>— If the stage 1 MMU is disabled and <code>TTBCR.EAE</code> is set to 1.</li> <li>— In an implementation that includes the Virtualization Extensions, for the result of an <code>ATS1Cxx</code> operation performed from Hyp mode.</li> </ul> </li> <li>• The 32-bit PAR is used when using the Short-descriptor translation table format. In this case, <code>PAR[63:32]</code> is UNK/SBZP.</li> </ul> Otherwise, the PAR is a 32-bit register. If the implementation includes the Security Extensions, this register is Banked.
<b>Attributes</b>	A 32-bit or 64-bit RW register with an UNKNOWN reset value. See also <a href="#">Reset behavior of CP14 and CP15 registers on page B3-1450</a> . <a href="#">Table B3-51 on page B3-1498</a> shows the encodings of all of the registers and operations in the Address translation operations functional group.

For both the 32-bit and the 64-bit PAR formats, the format depends on the value of bit[0]. Bit[0] indicates whether the address translation operation completed successfully. The following subsections describe the PAR formats:

- [32-bit PAR format](#)
- [64-bit PAR format on page B4-1667](#).

[Virtual Address to Physical Address translation operations on page B3-1438](#) described the operations that use the PAR, including the handling of faults on these operations.

#### 32-bit PAR format

For a translation that returns a 32-bit address and completes successfully, the PAR bit assignments are:

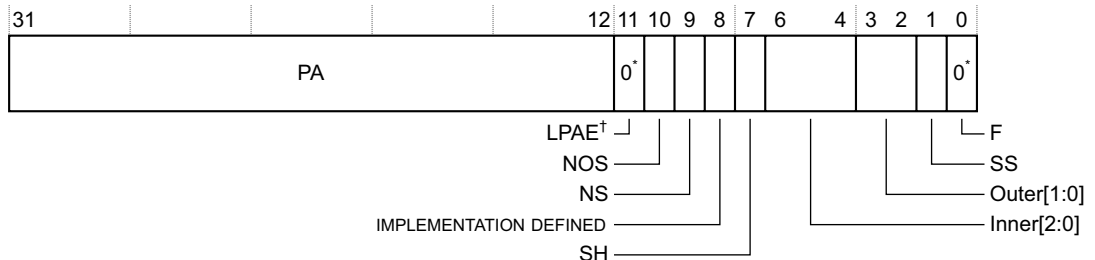

\* Returned value, but might be overwritten, because the bit is RW.

† Reserved before the introduction of the Large Physical Address Extension, see text for more information.

#### PA, bits[31:12]

Physical Address. The physical address corresponding to the supplied virtual address. This field returns address bits[31:12].

**LPAE, bit[11], if the implementation included the Large Physical Address Extension**

When updating the PAR with the result of a translation operation, this bit is set to 0 to indicate use of the Short-descriptor translation table formats. This indicates that the PAR returns a 32-bit value.

Hardware does not interpret this bit to determine the behavior of the memory system, and therefore software can set this bit to 0 or 1 without affecting operation. Unless the register has been updated as a result of an address translation operation, a subsequent read of the register returns the value written to it.

**Bit[11], if the implementation does not include the Large Physical Address Extension**

Reserved, UNK/SBZP.

**Bits[10:1]** Return memory attributes for the region:

**NOS, bit[10]**

Not Outer Shareable attribute. Indicates whether Shareable physical memory is Outer Shareable:

**0** Memory is Outer Shareable.

**1** Memory is not Outer Shareable.

If the physical memory is not Shareable, this bit is UNKNOWN.

On an implementation that does not distinguish between Inner Shareable and Outer Shareable, this bit is UNK/SBZP.

On an implementation that includes the Large Physical Address Extension and is using the Short-descriptor translation table format:

- For a Strongly-ordered or Device memory region, this field returns the value 0, regardless of any shareability attributes applied to the region. This means that any [PRRR](#).{NOS, DS0, DS1} bits that apply to the region have no effect on the returned value.
- For a Normal memory region with the Inner Non-cacheable, Outer Non-cacheable attribute, it is IMPLEMENTATION DEFINED whether this bit returns the Outer Shareable attribute for the region, or returns 0.

**NS, bit[9]** Non-secure. The NS attribute for a translation table entry read from Secure state.

This bit is UNKNOWN for a translation table entry read from Non-secure state.

**Bit[8]** IMPLEMENTATION DEFINED.

**SH, bit[7]** Shareable attribute. Indicates whether the physical memory is Shareable:

**0** Memory is Non-shareable.

**1** Memory is Shareable.

On an implementation that includes the Large Physical Address Extension and is using the Short-descriptor translation table format:

- For a Strongly-ordered or Device memory region, this field returns the value 1, regardless of any shareability attributes applied to the region. This means that any [PRRR](#).{NOS, DS0, DS1} bits that apply to the region have no effect on the returned value.
- For a Normal memory region with the Inner Non-cacheable, Outer Non-cacheable attribute, it is IMPLEMENTATION DEFINED whether this bit returns the Shareable attribute for the region, or returns 1.

An implementation that does not make use of this attribute can return the value that corresponds to its behavior, instead of the value in the translation table entry.

**Inner[2:0], bits[6:4]**

Inner memory attributes. Permitted values are:

- 0b111 Write-Back, no Write-Allocate.
- 0b110 Write-Through.
- 0b101 Write-Back, Write-Allocate.
- 0b011 Device.
- 0b001 Strongly-ordered.
- 0b000 Non-cacheable.

Other encodings for Inner[2:0] are reserved.

An implementation that does not support all of the defined attributes can return the behavior that the cache supports, instead of the value in the translation table entry.

**Outer[1:0], bits[3:2]**

Outer memory attributes. Possible values are:

- 0b11 Write-Back, no Write-Allocate.
- 0b10 Write-Through, no Write-Allocate.
- 0b01 Write-Back, Write-Allocate.
- 0b00 Non-cacheable.

An implementation that does not support all of the defined attributes can return the behavior that the cache supports, instead of the value in the translation table entry.

**SS, bit[1]** Supersection. Indicates whether the result is a Supersection:

- 0** Page is not a Supersection, that is, PAR[31:12] contains PA[31:12], regardless of the page size.
- 1** Page is part of a Supersection, and:
  - PAR[31:24] contains PA[31:24]
  - PAR[23:16] contains PA[39:32]
  - PAR[15:12] contains 0b0000.

If an implementation supports less than 40 bits of physical address, the bits in the PAR field that correspond to physical address bits that are not implemented are UNKNOWN.

**Note**

PA[23:12] is the same as VA[23:12] for Supersections.

**F, bit[0]** RAZ. Indicates that the conversion completed successfully.

For a translation that should return a 32-bit address, if the translation aborts without generating an exception the PAR bit assignments are:

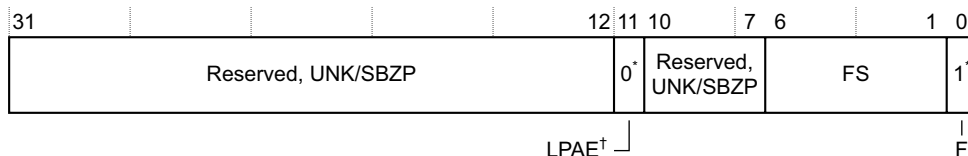

\* Returned value, but might be overwritten, because the bit is RW.

† Reserved before the introduction of the Large Physical Address Extension, see text for more information.

**Bits[31:12]** Reserved, UNK/SBZP.

**LPAE, bit[11], if the implementation includes the Large Physical Address Extension**

When updating the PAR with the result of a translation operation, this bit is set to 0 to indicate use of the Short-descriptor translation table formats.

Hardware does not interpret this bit to determine the behavior of the memory system, and therefore software can set this bit to 0 or 1 without affecting operation.

**Bit[11], if the implementation does not include the Large Physical Address Extension**

Reserved, UNK/SBZP.

**Bits[10:7]** Reserved, UNK/SBZP.

**FS, bits[6:1]** Fault status bits. Bits[12, 10, 3:0] from the Data Fault Status Register, indicate the source of the abort. For more information, see *DFSR, Data Fault Status Register; VMSA* on page B4-1561.

**F, bit[0]** RAO. Indicates that the conversion aborted.

**64-bit PAR format**

For a translation that returns a 64-bit address and completes successfully, the PAR bit assignments are:

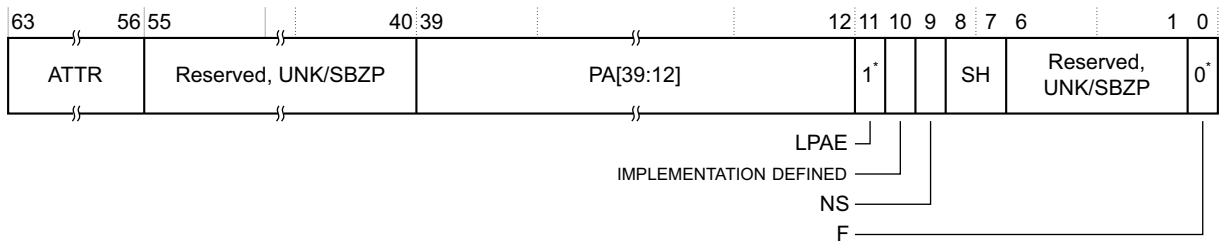

\* Returned value, but might be overwritten, because the bit is RW.

**ATTR, bits[63:56]**

Memory attributes for the returned PA, as indicated by the translation table entry. This field uses the same encoding as the *Attr<sub>n</sub>* fields in the *MAIR<sub>n</sub>* registers.

An implementation that does not support all of the defined attribute can return the value corresponding to its behavior, instead of the value in the translation table entry.

**Bits[55:40]** Reserved, UNK/SBZP.

**PA[39:12], bits[39:12]**

Physical Address. The physical address corresponding to the supplied virtual address. This field returns address bits[39:12].

**LPAE, bit[11]** When updating the PAR with the result of a translation operation, this bit is set to 1 to indicate use of the Long-descriptor translation table format. This indicates that the PAR returns a 64-bit value.

Hardware does not interpret this bit to determine the behavior of the memory system, and therefore software can set this bit to 0 or 1 without affecting operation. Unless the register has been updated as a result of an address translation operation, a subsequent read of the register returns the value written to it.

**IMPLEMENTATION DEFINED, bit[10]**

An IMPLEMENTATION DEFINED bit.

**NS, bit[9]** Non-secure. The NS attribute for a translation table entry read from Secure state. For more information, see *Control of Secure or Non-secure memory access, Long-descriptor format* on page B3-1344.

This bit is UNKNOWN for a translation table entry read from Non-secure state.

**SH[1:0], bits[8:7]**

Shareability attribute, from the translation table entry for the returned PA. For more information, including the encoding of this field, see *Shareability, Long-descriptor format* on page B3-1373. If the returned PA is in a Device or Strongly-ordered memory region this field returns the value 0b10.

An implementation that does not make use of this attribute can return the value that corresponds to its behavior, instead of the value in the translation table entry.

- Bits[6:1]** Reserved, UNK/SBZP.
- F, bit[0]** RAZ. Indicates that the conversion completed successfully.

For a translation that should return a 64-bit address, if the translation aborts without generating an exception the PAR bit assignments are:

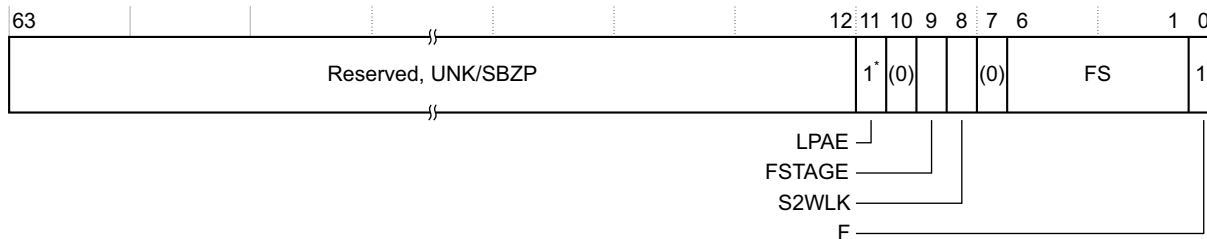

\* Returned value, but might be overwritten, because the bit is RW.

- Bits[63:12]** Reserved, UNK/SBZP.
- LPAE, bit[11]** After an address translation operation, in this format of the PAR, this bit is set to 1 to indicate that the translation used the Long-descriptor translation table formats, and returns a 64-bit PAR value. Hardware does not interpret this bit to determine the behavior of the memory system, and therefore software can set this bit to 0 or 1 without affecting operation.
- Bit[10]** Reserved, UNK/SBZP.
- FSTAGE, bit[9]**
  - Indicates the translation stage at which the translation aborted:
  - 0** Translation aborted because of a fault in the stage 1 translation.
  - 1** Translation aborted because of a fault in the stage 2 translation.
- S2WLK, bit[8]**
  - This bit is set to 1 to indicate that the translation aborted because of a stage 2 fault during a stage 1 translation table walk. Otherwise, it is set to 0.
- Bit[7]** Reserved, UNK/SBZP.
- FS, bits[6:1]** Fault status field. The field uses the fault encoding described in [Fault reporting with the Long-descriptor translation table format on page B3-1416](#).
- F, bit[0]** RAO. Indicates that the conversion aborted.

### Accessing the PAR

To access the PAR in an implementation that does not include the Large Physical Address Extension, or bits[31:0] of the PAR in an implementation that includes the Large Physical Address Extension, software reads or writes the CP15 registers with an MRC or MCR instruction with <opc1> set to 0, <CRn> set to c7, <CRm> set to c4, and <opc2> set to 0. For example:

```
MRC p15, 0, <Rt>, c7, c4, 0 ; Read PAR[31:0] into Rt
MCR p15, 0, <Rt>, c7, c4, 0 ; Write Rt to PAR[31:0]
```

In an implementation that includes the Large Physical Address Extension, to access all 64 bits of the PAR, software reads or writes the CP15 registers with an MRRC or MCRR instruction with <opc1> set to 0 and <CRn> set to c7. For example:

```
MRRC p15, 0, <Rt>, <Rt2>, c7 ; Read 64-bit PAR into Rt (low word) and Rt2 (high word)
MCRR p15, 0, <Rt>, <Rt2>, c7 ; Write Rt (low word) and Rt2 (high word) to 64-bit PAR
```

For examples of accessing the PAR as part of an address translation operation, see [Accessing the PAR and the address translation operations on page B4-1748](#).



### B4.1.113 PMCCNTR, Performance Monitors Cycle Count Register, VMSA

When accessed through the CP15 interface, the PMCCNTR characteristics are:

<b>Purpose</b>	The PMCCNTR holds the value of the processor Cycle Counter, CCNT, that counts processor clock cycles. This register is a Performance Monitors register.
<b>Usage constraints</b>	The PMCCNTR is accessible in: <ul style="list-style-type: none"> <li>• all modes executing at PL1 or higher</li> <li>• User mode when <code>PMUSERENR.EN == 1</code>.</li> </ul> See <a href="#">Access permissions on page C12-2328</a> for more information. The <code>PMCR.D</code> bit configures whether PMCCNTR increments once every clock cycle, or once every 64 clock cycles. In PMUv2, the <code>PMXEVTYPER</code> accessed when <code>PMSELR.SEL</code> is set to <code>0b11111</code> determines the modes and states in which the PMCCNTR can increment.
<b>Configurations</b>	Implemented only as part of the Performance Monitors Extension. The VMSA and PMSA definitions of the register fields are identical. In a VMSA implementation that includes the Security Extensions, this is a Common register.
<b>Attributes</b>	A 32-bit RW register with a reset value that is UNKNOWN on a non-debug logic reset. See also <a href="#">Power domains and Performance Monitors registers reset on page C12-2327</a> . <a href="#">Table C12-7 on page C12-2327</a> shows the CP15 encodings of all of the Performance Monitors registers.

———— **Note** ————

[Differences in the memory-mapped views of the Performance Monitors registers on page AppxB-2352](#) describes how the characteristics of the PMCCNTR differ when it is accessed through an external debug interface or a memory-mapped interface.

The PMCCNTR bit assignments are:

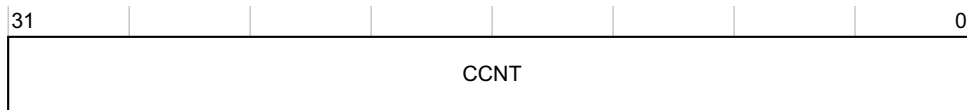

<b>CCNT, bits[31:0]</b>	Cycle count. Depending on the value of the <code>PMCR.D</code> bit, this field increments either: <ul style="list-style-type: none"> <li>• once every processor clock cycle</li> <li>• once every 64 processor clock cycles.</li> </ul>
-------------------------	---

The PMCCNTR.CCNT value can be reset to zero by writing a 1 to the `PMCR.C` bit.

#### Accessing the PMCCNTR

To access the PMCCNTR, read or write the CP15 registers with `<opc1>` set to 0, `<CRn>` set to c9, `<CRm>` set to c13, and `<opc2>` set to 0. For example:

```
MRC p15, 0, <Rt>, c9, c13, 0 : Read PMCCNTR into Rt
MCR p15, 0, <Rt>, c9, c13, 0 : Write Rt to PMCCNTR
```

### B4.1.114 PMCEID0 and PMCEID1, Performance Monitors Common Event ID registers, VMSA

When accessed through the CP15 interface, the PMCEID0 and PMCEID1 register characteristics are:

<b>Purpose</b>	The PMCEIDn registers define which common architectural and common microarchitectural feature events are implemented. These registers are Performance Monitors registers.
<b>Usage constraints</b>	The PMCEIDn registers are accessible in: <ul style="list-style-type: none"> <li>all modes executing at PL1 or higher</li> <li>User mode when <code>PMUSERENR.EN</code> is set to 1.</li> </ul> See <a href="#">Access permissions on page C12-2328</a> for more information.
<b>Configurations</b>	Implemented only as part of the Performance Monitors Extension. The VMSA and PMSA definitions of the register fields are identical. In a VMSA implementation that includes the Security Extensions, this is a Common register.
<b>Attributes</b>	A 32-bit RO register. <a href="#">Table C12-7 on page C12-2327</a> shows the CP15 encodings of all of the Performance Monitors registers.

———— **Note** —————

[Differences in the memory-mapped views of the Performance Monitors registers on page AppxB-2352](#) describes how the characteristics of the PMCEID0 and PMCEID1 registers differ when they are accessed through an external debug interface or a memory-mapped interface.

[Table B4-14](#) shows the PMCEID0 bit assignments with the event implemented or not implemented when the associated bit is set to 1 or 0.

PMCEID1[31:0] is reserved and must be implemented as RAZ. Software must not rely on the bits reading as 0.

**Table B4-14 PMCEID0 bit assignments**

Bit	Event number	Event implemented if set to 1 or not implemented if set to 0
[31]	0x1F	Reserved, UNK.
[30]	0x1E	
[29]	0x1D	Bus cycle.
[28]	0x1C	Instruction architecturally executed, condition code check pass, write to TTBR.
[27]	0x1B	Instruction speculatively executed.
[26]	0x1A	Local memory error.
[25]	0x19	Bus access.
[24]	0x18	Level 2 data cache write-back.
[23]	0x17	Level 2 data cache refill.
[22]	0x16	Level 2 data cache access.
[21]	0x15	Level 1 data cache write-back.
[20]	0x14	Level 1 instruction cache access.
[19]	0x13	Data memory access.

**Table B4-14 PMCEID0 bit assignments (continued)**

Bit	Event number	Event implemented if set to 1 or not implemented if set to 0
[18]	0x12	Predictable branch speculatively executed. If the implementation includes program flow prediction, this bit is RAO.
[17]	0x11	Cycle, this bit is RAO.
[16]	0x10	Mispredicted or not predicted branch speculatively executed. If the implementation includes program flow prediction resources, this bit is RAO.
[15]	0x0F	Instruction architecturally executed, condition code check pass, unaligned load or store.
[14]	0x0E	Instruction architecturally executed, condition code check pass, procedure return.
[13]	0x0D	Instruction architecturally executed, immediate branch.
[12]	0x0C	Instruction architecturally executed, condition code check pass, software change of the PC.
[11]	0x0B	Instruction architecturally executed, condition code check pass, write to <a href="#">CONTEXTIDR</a> .
[10]	0x0A	Instruction architecturally executed, condition code check pass, exception return.
[9]	0x09	Exception taken.
[8]	0x08	Instruction architecturally executed.
[7]	0x07	Instruction architecturally executed, condition code check pass, store.
[6]	0x06	Instruction architecturally executed, condition code check pass, load.
[5]	0x05	Level 1 data TLB refill.
[4]	0x04	Level 1 data cache access. If the implementation includes a L1 data or unified cache, this bit is RAO.
[3]	0x03	Level 1 data cache refill. If the implementation includes a L1 data or unified cache, this bit is RAO.
[2]	0x02	Level 1 instruction TLB refill.
[1]	0x01	Level 1 instruction cache refill.
[0]	0x00	Instruction architecturally executed, condition code check pass, software increment. This bit is RAO.

### Accessing the PMCEID0 or PMCEID1 register

To access the PMCEID0 or PMCEID1 register, software reads the CP15 register with <opc1> set to 0, <CRn> set to c9, <CRm> set to c12, and:

- <opc2> set to 6 for the PMCEID0 register
- <opc2> set to 7 for the PMCEID1 register.

For example:

```
MRC p15, 0, <Rt>, c9, c12, 6 ; Read PMCEID0 into Rt
MRC p15, 0, <Rt>, c9, c12, 7 ; Read PMCEID1 into Rt
```



**Bits[30:N]** Reserved, RAZ/WI.

**P<sub>x</sub>, bit[x], for x = 0 to (N-1)**

Event counter *x*, PMN<sub>x</sub>, disable bit.

In an implementation that includes the Virtualization Extensions, in Non-secure PL1 and PL0 modes, if  $x \geq \text{HDCR.HPMN}$  then P<sub>x</sub> is RAZ/WI, see [Counter access on page C12-2312](#). Otherwise, [Table B4-16](#) shows the behavior of this bit on reads and writes.

**Table B4-16 Read and write values for the PMCNTENCLR.P<sub>x</sub> bits**

P <sub>x</sub> value	Meaning on read	Action on write
0	PMN <sub>x</sub> event counter disabled	No action, write is ignored
1	PMN <sub>x</sub> event counter enabled	Disable the PMN <sub>x</sub> event counter

———— **Note** ————

[PMCR.E](#) can override the settings in this register and disable all counters including [PMCCNTR](#). PMCNTENCLR retains its value when [PMCR.E](#) is 0, even though its settings are ignored.

**Accessing the PMCNTENCLR register**

To access the PMCNTENCLR register, read or write the CP15 registers with <opc1> set to 0, <CRn> set to c9, <CRm> set to c12, and <opc2> set to 2. For example:

```
MRC p15, 0, <Rt>, c9, c12, 2 : Read PMCNTENCLR into Rt
MCR p15, 0, <Rt>, c9, c12, 2 : Write Rt to PMCNTENCLR
```



**C, bit[31]** **PMCCNTR** enable bit. [Table B4-17](#) shows the behavior of this bit on reads and writes.

**Table B4-17 Read and write bit values for the PMCNTENSET.C bit**

Value	Meaning on read	Action on write
0	Cycle counter disabled	No action, write is ignored
1	Cycle counter enabled	Enable the <a href="#">PMCCNTR</a> cycle counter

**Bits[30:N]** Reserved, RAZ/WI.

**Px, bit[x], for x = 0 to (N-1)**

Event counter x, PMNx, enable bit.

In an implementation that includes the Virtualization Extensions, in Non-secure PL1 and PL0 modes, if  $x \geq \text{HDCR.HPMN}$  then Px is RAZ/WI, see [Counter access on page C12-2312](#). Otherwise, [Table B4-18](#) shows the behavior of this bit on reads and writes.

**Table B4-18 Read and write values for the PMCNTENSET.Px bits**

Px value	Meaning on read	Action on write
0	PMNx event counter disabled	No action, write is ignored
1	PMNx event counter enabled	Enable the PMNx event counter

### Accessing the PMCNTENSET register

To access the PMCNTENSET register, read or write the CP15 registers with <opc1> set to 0, <CRn> set to c9, <CRm> set to c12, and <opc2> set to 1. For example:

```
MRC p15, 0, <Rt>, c9, c12, 1 ; Read PMCNTENSET into Rt
MCR p15, 0, <Rt>, c9, c12, 1 ; Write Rt to PMCNTENSET
```

## B4.1.117 PMCR, Performance Monitors Control Register, VMSA

When accessed through the CP15 interface, the PMCR characteristics are:

<b>Purpose</b>	The PMCR provides details of the Performance Monitors implementation, including the number of counters implemented, and configures and controls the counters. This register is a Performance Monitors register.
<b>Usage constraints</b>	The PMCR is accessible in: <ul style="list-style-type: none"> <li>• all modes executing at PL1 or higher</li> <li>• User mode when <code>PMUSERENR.EN</code> is set to 1.</li> </ul> See <a href="#">Access permissions on page C12-2328</a> for more information. See also <a href="#">Counter enables on page C12-2311</a> and <a href="#">Counter access on page C12-2312</a> .
<b>Configurations</b>	Implemented only as part of the Performance Monitors Extension. The VMSA and PMSA definitions of the register fields are identical. In a VMSA implementation that includes the Security Extensions, this is a Common register.
<b>Attributes</b>	A 32-bit RW register with a reset value that depends on the register implementation. For more information see the register bit descriptions and <a href="#">Power domains and Performance Monitors registers reset on page C12-2327</a> . <a href="#">Table C12-7 on page C12-2327</a> shows the CP15 encodings of all of the Performance Monitors registers.

———— **Note** ————

[Differences in the memory-mapped views of the Performance Monitors registers on page AppxB-2352](#) describes how the characteristics of the PMCR differ when it is accessed through an external debug interface or a memory-mapped interface.

The PMCR bit assignments are:

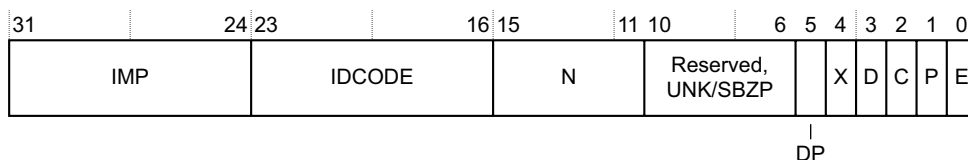

<b>IMP, bits[31:24]</b>	Implementer code. This field is RO with an IMPLEMENTATION DEFINED value. The implementer codes are allocated by ARM. Values have the same interpretation as bits[31:24] of the <a href="#">MIDR</a> .
<b>IDCODE, bits[23:16]</b>	Identification code. This field is RO with an IMPLEMENTATION DEFINED value. Each implementer must maintain a list of identification codes that is specific to the implementer. A specific implementation is identified by the combination of the implementer code and the identification code.
<b>N, bits[15:11]</b>	Number of event counters. This field is RO with an IMPLEMENTATION DEFINED value that indicates the number of counters implemented. The value of this field is the number of counters implemented, from <code>0b000000</code> for no counters to <code>0b111111</code> for 31 counters. An implementation can implement only the Cycle Count Register, <a href="#">PMCCNTR</a> . This is indicated by a value of <code>0b000000</code> for the N field.



In an implementation that includes the Virtualization Extensions:

- In Non-secure modes other than Hyp mode, this field reads the value of [HDCR.HPMN](#).
- In Secure state and Hyp mode, this field reads the IMPLEMENTATION DEFINED number of event counters.

**Bits[10:6]**

Reserved, UNK/SBZP.

**DP, bit[5]**

Disable [PMCCNTR](#) when event counting is prohibited. The possible values of this bit are:

**0** Cycle counter operates regardless of the non-invasive debug authentication settings.

**1** Cycle counter is disabled if non-invasive debug is not permitted.

For more information, see [Effects of non-invasive debug authentication on the Performance Monitors](#) on page C12-2302 and [Chapter C9 Non-invasive Debug Authentication](#).

———— **Note** —————

In an implementation that includes the Security Extensions, a Non-secure process can set this bit to 1, to discard cycle counts that might be accumulated during periods when the other counts are prohibited because of security prohibitions. It is not a control to enhance security. The function of this bit is to avoid corruption of the count. See also [Effect of the Security Extensions and Virtualization Extensions](#) on page C12-2307.

—————  
This bit is RW. Its non-debug logic reset value is 0.

**X, bit[4]**

Export enable. The possible values of this bit are:

**0** Export of events is disabled.

**1** Export of events is enabled.

This bit enables the exporting of events to another debug device, such as a trace macrocell, over an event bus. If the implementation does not include such an event bus, this bit is RAZ/WI.

This bit does not affect the generation of Performance Monitors interrupts, that can be implemented as a signal exported from the processor to an interrupt controller.

This bit is RW. Its non-debug logic reset value is 0.

**D, bit[3]**

Cycle counter clock divider. The possible values of this bit are:

**0** When enabled, [PMCCNTR](#) counts every clock cycle.

**1** When enabled, [PMCCNTR](#) counts once every 64 clock cycles.

This bit is RW. Its non-debug logic reset value is 0.

**C, bit[2]**

Cycle counter reset. This bit is WO. The effects of writing to this bit are:

**0** No action.

**1** Reset [PMCCNTR](#) to zero.

————— **Note** —————

Resetting [PMCCNTR](#) does not clear the [PMCCNTR](#) overflow bit to 0. For more information, see the description of [PMOVSr](#).

—————  
This bit is always RAZ.

**P, bit[1]** Event counter reset. This bit is WO. The effects of writing to this bit are:  
**0** . No action.  
**1** . Reset all event counters, except [PMCCNTR](#), to zero.

———— **Note** —————

Resetting the event counters does not clear any overflow bits to 0. For more information, see the description of [PMOVSr](#).

In an implementation that includes the Virtualization Extensions:

- In Non-secure modes other than Hyp mode:
  - A write of 1 to this bit by an MCR instruction does not reset event counters that the [HDCR.HPMN](#) field reserves for Hyp mode use.
  - It is UNPREDICTABLE whether a write of 1 to this bit through a memory-mapped interface or an external debug interface resets the event counters that the [HDCR.HPMN](#) field reserves for Hyp mode use.  
For more information about these interfaces, see [Appendix B Recommended Memory-mapped and External Debug Interfaces for the Performance Monitors](#).
- In Secure state and Hyp mode, a write of 1 to this bit resets all the event counters.

This bit is always RAZ.

**E, bit[0]** Enable. The possible values of this bit are:  
**0** All counters, including [PMCCNTR](#), are disabled.  
**1** All counters are enabled.  
In an implementation that includes the Virtualization Extensions, the value of this bit does not affect the operation of event counters that [HDCR.HPMN](#) reserves for use in Hyp mode. For more information, see [Counter enables on page C12-2311](#).  
This bit is RW. Its non-debug logic reset value is 0.

### Accessing the PMCR

To access PMCR, read or write the CP15 registers with <opc1> set to 0, <CRn> set to c9, <CRm> set to c12, and <opc2> set to 0. For example:

```
MRC p15, 0, <Rt>, c9, c12, 0 ; Read PMCR into Rt  
MCR p15, 0, <Rt>, c9, c12, 0 ; Write Rt to PMCR
```

### B4.1.118 PMINTENCLR, Performance Monitors Interrupt Enable Clear register, VMSA

When accessed through the CP15 interface, the PMINTENCLR register characteristics are:

**Purpose** The PMINTENCLR register disables the generation of interrupt requests on overflows from:

- the Cycle Count Register, [PMCCNTR](#)
- each implemented event counter, PMNx.

Reading the register shows which overflow interrupt requests are enabled.  
 This register is a Performance Monitors register.

**Usage constraints** The PMINTENCLR is accessible from PL1 or higher.

———— **Note** —————

In an implementation that includes the Virtualization Extensions, in Non-secure PL1 modes, the value of [HDCR.HPMN](#) can change the behavior of accesses to PMINTENCLR, see the description of the Px bit.

In User mode, instructions that access the register are always UNDEFINED, even if [PMUSERENR.EN](#) is set to 1.

See [Access permissions on page C12-2328](#) for more information. See also [Counter access on page C12-2312](#).

PMINTENCLR is used in conjunction with the [PMINTENSET](#) register.

**Configurations** Implemented only as part of the Performance Monitors Extension.  
 The VMSA and PMSA definitions of the register fields are identical.  
 In a VMSA implementation that includes the Security Extensions, this is a Common register.

**Attributes** A 32-bit RW register with a reset value that is UNKNOWN on a non-debug logic reset. See also [Power domains and Performance Monitors registers reset on page C12-2327](#).  
[Table C12-7 on page C12-2327](#) shows the CP15 encodings of all of the Performance Monitors registers.

———— **Note** —————

[Differences in the memory-mapped views of the Performance Monitors registers on page AppxB-2352](#) describes how the characteristics of the PMINTENCLR register differ when it is accessed through an external debug interface or a memory-mapped interface.

The PMINTENCLR register bit assignments are:

31	30		N	N-1					0
C	Reserved, RAZ/WI			Event counter overflow interrupt request disable bits, Px, for x = 0 to (N-1)					

———— **Note** —————

In the description of the PMINTENCLR register, N and x have the meanings used in the description of the [PMCNTENSET](#) register.

**C, bit[31]** [PMCCNTR](#) overflow interrupt request disable bit.

[Table B4-19](#) shows the behavior of this bit on reads and writes.

**Table B4-19 Read and write values for the PMINTENCLR.C bit**

Value	Meaning on read	Action on write
0	Cycle count interrupt request disabled	No action, write is ignored
1	Cycle count interrupt request enabled	Disable the cycle count interrupt request

**Bits[30:N]** Reserved, RAZ/WI.

**Px, bit[x], for x = 0 to (N-1)**

Event counter x, PMNx, overflow interrupt request disable bit.

In an implementation that includes the Virtualization Extensions, in Non-secure PL1 modes, if  $x \geq \text{HDCR.HPMN}$  then Px is RAZ/WI, see [Counter access on page C12-2312](#). Otherwise, [Table B4-20](#) shows the behavior of this bit on reads and writes.

**Table B4-20 Read and write values for the PMINTENCLR.Px bits**

Px value	Meaning on read	Action on write
0	PMNx interrupt request disabled	No action, write is ignored
1	PMNx interrupt request enabled	Disable the PMNx interrupt request

For more information about counter overflow interrupt requests see [PMINTENSET, Performance Monitors Interrupt Enable Set register, VMSA on page B4-1681](#).

### Accessing the PMINTENCLR register

To access the PMINTENCLR register, read or write the CP15 registers with <opc1> set to 0, <CRn> set to c9, <CRm> set to c14, and <opc2> set to 2. For example:

```
MRC p15, 0, <Rt>, c9, c14, 2 : Read PMINTENCLR into Rt
MCR p15, 0, <Rt>, c9, c14, 2 : Write Rt to PMINTENCLR
```

### B4.1.119 PMINTENSET, Performance Monitors Interrupt Enable Set register, VMSA

When accessed through the CP15 interface, the PMINTENSET register characteristics are:

**Purpose** The PMINTENSET register enables the generation of interrupt requests on overflows from:

- the Cycle Count Register, [PMCCNTR](#)
- each implemented event counter, PMNx.

Reading the register shows which overflow interrupt requests are enabled.

This register is a Performance Monitors register.

**Usage constraints** The PMINTENSET register is accessible from PL1 or higher.

———— **Note** ————

In an implementation that includes the Virtualization Extensions, in Non-secure PL1 modes, the value of [HDCR.HPMN](#) can change the behavior of accesses to PMINTENSET, see the description of the Px bit.

In User mode, instructions that access the register are always UNDEFINED, even if [PMUSERENR.EN](#) is set to 1.

See [Access permissions on page C12-2328](#) for more information. See also [Counter access on page C12-2312](#).

PMINTENSET is used in conjunction with the [PMINTENCLR](#) register.

**Configurations** Implemented only as part of the Performance Monitors Extension.

The VMSA and PMSA definitions of the register fields are identical.

In a VMSA implementation that includes the Security Extensions, this is a Common register.

**Attributes** A 32-bit RW register with a reset value that is UNKNOWN on a non-debug logic reset. See also [Power domains and Performance Monitors registers reset on page C12-2327](#).

[Table C12-7 on page C12-2327](#) shows the CP15 encodings of all of the Performance Monitors registers.

———— **Note** ————

[Differences in the memory-mapped views of the Performance Monitors registers on page AppxB-2352](#) describes how the characteristics of the PMINTENSET register differ when it is accessed through an external debug interface or a memory-mapped interface.

The PMINTENSET register bit assignments are:

31	30	N	N-1	0
C	Reserved, RAZ/WI		Event counter overflow interrupt request enable bits, Px, for x = 0 to (N-1)	

———— **Note** ————

In the description of the PMINTENSET register, N and x have the meanings used in the description of the [PMCCNTR](#) Register.

**C, bit[31]** [PMCCNTR](#) overflow interrupt request enable bit.

[Table B4-21](#) shows the behavior of this bit on reads and writes.

**Table B4-21 Read and write values for the PMINTENSET.C bit**

Value	Meaning on read	Action on write
0	Cycle count interrupt request disabled	No action, write is ignored
1	Cycle count interrupt request enabled	Enable the cycle count interrupt request

**Bits[30:N]** Reserved, RAZ/WI.

**Px, bit[x], for x = 0 to (N-1)**

Event counter x, PMNx, overflow interrupt request enable bit.

In an implementation that includes the Virtualization Extensions, in Non-secure PL1 modes, if  $x \geq \text{HDCR.HPMN}$  then Px is RAZ/WI, see [Counter access on page C12-2312](#). Otherwise, [Table B4-22](#) shows the behavior of this bit on reads and writes.

**Table B4-22 Read and write values for the PMINTENSET.Px bits**

Px value	Meaning on read	Action on write
0	PMNx interrupt request disabled	No action, write is ignored
1	PMNx interrupt request enabled	Enable the PMNx interrupt request

The debug logic does not signal an interrupt request if the [PMCR.E](#) enable bit is set to 0.

When an interrupt is signaled, software can remove it by writing a 1 to the corresponding overflow bit in the [PMOVSr](#).

———— **Note** ————

ARM expects that the interrupt request that can be generated on a counter overflow is exported from the processor, meaning it can be factored into a system interrupt controller if applicable. This means that normally the system has more levels of control of the interrupt generated.

**Accessing the PMINTENSET register**

To access the PMINTENSET register, read or write the CP15 registers with <opc1> set to 0, <CRn> set to c9, <CRm> set to c14, and <opc2> set to 1. For example:

MRC p15, 0, <Rt>, c9, c14, 1 : Read PMINTENSET into Rt  
 MCR p15, 0, <Rt>, c9, c14, 1 : Write Rt to PMINTENSET

## B4.1.120 PMOVSR, Performance Monitors Overflow Flag Status Register, VMSA

When accessed through the CP15 interface, the PMOVSR characteristics are:

**Purpose** The PMOVSR holds the state of the overflow bit for:

- the Cycle Count Register, [PMCCNTR](#)
- each of the implemented event counters, PMNx.

Software must write to this register to clear these bits.  
 This register is a Performance Monitors register.

**Usage constraints** The PMOVSR is accessible in:

- all modes executing at PL1 or higher
- User mode when [PMUSERENR.EN](#) is set to 1.

———— **Note** —————

In an implementation that includes the Virtualization Extensions, in Non-secure PL1 and PL0 modes, the value of [HDCR.HPMN](#) can change the behavior of accesses to PMOVSR, see the description of the Px bit.

See [Access permissions on page C12-2328](#) for more information. See also [Counter access on page C12-2312](#).

**Configurations** Implemented only as part of the Performance Monitors Extension.  
 The VMSA and PMSA definitions of the register fields are identical.  
 In a VMSA implementation that includes the Security Extensions, this is a Common register.

**Attributes** A 32-bit RW register with a reset value that is UNKNOWN on a non-debug logic reset. See also [Power domains and Performance Monitors registers reset on page C12-2327](#).  
[Table C12-7 on page C12-2327](#) shows the CP15 encodings of all of the Performance Monitors registers.

———— **Note** —————

[Differences in the memory-mapped views of the Performance Monitors registers on page AppxB-2352](#) describes how the characteristics of the PMOVSR differ when it is accessed through an external debug interface or a memory-mapped interface.

The PMOVSR bit assignments are:

31	30	N	N-1	0
C	Reserved, RAZ/WI		Event counter overflow bits, Px, for x = 0 to (N-1)	

———— **Note** —————

In the description of the PMOVSR, N and x have the meanings used in the description of the [PMCNTENSET](#) Register.

C, bit[31] [PMCCNTR](#) overflow bit.

[Table B4-23](#) shows the behavior of this bit on reads and writes.

**Table B4-23 Read and write values for the PMOVSR.C bit**

Value	Meaning on read	Action on write
0	Cycle counter has not overflowed	No action, write is ignored
1	Cycle counter has overflowed	Clear bit to 0

Bits[30:N] Reserved, RAZ/WI.

Px, bit[x], for x = 0 to (N-1)

Event counter x, PMNx, overflow bit.

In an implementation that includes the Virtualization Extensions, in Non-secure PL1 and PL0 modes, if  $x \geq \text{HDCR.HPMN}$  then Px is RAZ/WI, see [Counter access on page C12-2312](#). Otherwise, [Table B4-24](#) shows the behavior of this bit on reads and writes.

**Table B4-24 Read and write values for the PMOVSR.Px bits**

Px value	Meaning on read	Action on write
0	PMNx event counter has not overflowed	No action, write is ignored
1	PMNx event counter has overflowed	Clear bit to 0

**Note**

The overflow bit values for individual counters are retained until cleared to 0 by a write to the PMOVSR or processor reset, even if the counter is later disabled by writing to the [PMCNTENCLR](#) register or through the [PMCR.E](#) Enable bit. The overflow bits are also not cleared to 0 when the counters are reset through the Event counter reset or Clock counter reset bits in the [PMCR](#).

**Accessing the PMOVSR**

To access the PMOVSR, read or write the CP15 registers with <opc1> set to 0, <CRn> set to c9, <CRm> set to c12, and <opc2> set to 3. For example:

```
MRC p15, 0, <Rt>, c9, c12, 3;    Read PMOVSR into Rt
MCR p15, 0, <Rt>, c9, c12, 3;    Write Rt to PMOVSR
```



## B4.1.121 PMOVSET, Performance Monitors Overflow Flag Status Set register, Virtualization Extensions

When accessed through the CP15 interface, the PMOVSET register characteristics are:

**Purpose** The PMOVSET register sets the state of the overflow bit for:

- the Cycle Count Register, [PMCCNTR](#)
- each of the implemented event counters, PMNx.

This register is a Performance Monitors register.

**Usage constraints** The PMOVSET register is accessible in:

- all modes executing at PL1 or higher
- User mode when [PMUSERENR.EN](#) == 1.

———— **Note** —————

In Non-secure PL1 and PL0 modes, the value of [HDCR.HPMN](#) can change the behavior of accesses to PMOVSET, see the description of the Px bit.

See [Access permissions on page C12-2328](#) for more information. See also [Counter access on page C12-2312](#).

**Configurations** Implemented only as part of the Performance Monitors Extension, and only if the processor implementation includes the Virtualization Extensions.

This is a Common register.

**Attributes** A 32-bit RW register with a reset value that is UNKNOWN on a non-debug logic reset. See also [Power domains and Performance Monitors registers reset on page C12-2327](#).

[Table C12-7 on page C12-2327](#) shows the CP15 encodings of all of the Performance Monitors registers.

———— **Note** —————

[Differences in the memory-mapped views of the Performance Monitors registers on page AppxB-2352](#) describes how the characteristics of the PMOVSET register differ when it is accessed through an external debug interface or a memory-mapped interface.

The PMOVSET bit assignments are:

31	30	N	N-1	0
C	Reserved, RAZ/WI		Event counter overflow bits, Px, for x = 0 to (N-1)	

———— **Note** —————

In the description of the PMOVSET register, N and x have the meanings used in the description of the [PMCNTENSET](#) register.

**C, bit[31]** [PMCCNTR](#) overflow bit.

[Table B4-25](#) shows the behavior of this bit on reads and writes.

**Table B4-25 Read and write values for the PMOVSET.C bit**

Value	Meaning on read	Action on write
0	Cycle counter has not overflowed	No action, write is ignored
1	Cycle counter has overflowed	Set bit to 1

**Bits[30:N]** Reserved, RAZ/WI.

**Px, bit[x], for x = 0 to (N-1)**

Event counter x, PMNx, overflow bit.

In Non-secure PL1 and PL0 modes, if  $x \geq \text{HDCR.HPMN}$  then Px is RAZ/WI, see [Counter access on page C12-2312](#). Otherwise, [Table B4-26](#) shows the behavior of this bit on reads and writes.

**Table B4-26 Read and write values for the PMOVSSET.Px bits**

Px value	Meaning on read	Action on write
0	PMNx event counter has not overflowed	No action, write is ignored
1	PMNx event counter has overflowed	Set bit to 1

———— **Note** ————

Software can write to the PMOVSSET even when the counter is disabled. This is true regardless of why the counter is disabled, which can be any of:

- because 1 has been written to the appropriate bit in the [PMCNTENCLR](#)
- because the [PMCR.E](#) bit is set to 0
- by the non-invasive debug authentication.

**Accessing the PMOVSSET register**

Read or write the CP15 registers with <opc1> set to 0, <CRn> set to c9, <CRm> set to c14, and <opc2> set to 3. For example:

```
MRC p15, 0, <Rt>, c9, c14, 3 : Read PMOVSSET into Rt
MCR p15, 0, <Rt>, c9, c14, 3 : Write Rt to PMOVSSET
```

## B4.1.122 PMSELR, Performance Monitors Event Counter Selection Register, VMSA

The PMSELR characteristics are:

- Purpose**
- In PMUv1, PMSELR selects an event counter, PMNx.
  - In PMUv2, PMSELR selects an event counter, PMNx, or the cycle counter, CCNT. The PMSELR.SEL value of 31 selects the cycle counter.

This register is a Performance Monitors register.

- Usage constraints**
- The PMSELR is accessible in:
- all modes executing at PL1 or higher
  - User mode when `PMUSERENR.EN == 1`.

See [Access permissions on page C12-2328](#) for more information. See also [Counter access on page C12-2312](#).

PMSELR is not visible in an external debug interface or a memory-mapped interface to the Performance Monitors registers.

When using CP15 to access the Performance Monitors registers, PMSELR is used in conjunction with:

- [PMXEVTYPER](#), to determine:
  - the event that increments a selected event counter
  - in PMUv2, the modes and states in which the selected counter increments.
- [PMXEVCNTR](#), to determine the value of a selected event counter.

**Configurations**

Implemented only as part of the Performance Monitors Extension.

The VMSA and PMSA definitions of the register fields are identical.

In a VMSA implementation that includes the Security Extensions, this is a Common register.

**Attributes**

A 32-bit RW register with a reset value that is UNKNOWN on a non-debug logic reset. See also [Power domains and Performance Monitors registers reset on page C12-2327](#).

[Table C12-7 on page C12-2327](#) shows the CP15 encodings of all of the Performance Monitors registers.

The PMSELR bit assignments are:

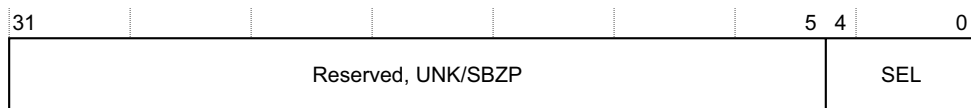

**Bits[31:5]** Reserved, UNK/SBZP.

- SEL, bits[4:0]** Selects event counter,  $PMN_x$ , where  $x$  is the value held in this field. That is, the SEL field identifies which event counter,  $PMN_{SEL}$ , is accessed, when a subsequent access to [PMXEVTYPER](#) or [PMXEVCNTR](#) occurs. In:
- PMUv1** This field can take any value from 0 (0b00000) to (PMCR.N)-1. The value of 0b11111 is reserved and must not be used.  
If this field is set to a value greater than or equal to the number of implemented counters the results are UNPREDICTABLE.
- PMUv2** This field can take any value from 0 (0b00000) to (PMCR.N)-1, or 31 (0b11111).  
When PMSELR.SEL is 0b11111:
- it selects the [PMXEVTYPER](#) for the cycle counter
  - a read or write of [PMXEVCNTR](#) is UNPREDICTABLE.
- If this field is set to a value greater than or equal to the number of implemented counters, but not equal to 31, the results are UNPREDICTABLE.

———— **Note** —————

[PMCR.N](#) defines the number of implemented counters.

### Accessing the PMSELR

To access the PMSELR, read or write the CP15 registers with <opc1> set to 0, <CRn> set to c9, <CRm> set to c12, and <opc2> set to 5. For example:

```
MRC p15, 0, <Rt>, c9, c12, 5 ; Read PMSELR into Rt  
MCR p15, 0, <Rt>, c9, c12, 5 ; Write Rt to PMSELR
```

### B4.1.123 PMSWINC, Performance Monitors Software Increment register, VMSA

When accessed through the CP15 interface, the PMSWINC register characteristics are:

**Purpose** The PMSWINC register increments a counter that is configured to count the Software increment event, event 0x00.

This register is a Performance Monitors register.

**Usage constraints** The PMSWINC register is accessible in:

- all modes executing at PL1 or higher
- User mode when [PMUSERENR.EN](#) is set to 1.

———— **Note** —————

In an implementation that includes the Virtualization Extensions, in Non-secure PL1 and PL0 modes, the value of [HDCR.HPMN](#) can change the behavior of writes to PMSWINC, see the description of the Px bit.

See [Access permissions on page C12-2328](#) for more information.

**Configurations** Implemented only as part of the Performance Monitors Extension.  
 The VMSA and PMSA definitions of the register fields are identical.  
 In a VMSA implementation that includes the Security Extensions, this is a Common register.

**Attributes** A 32-bit WO register. See also [Power domains and Performance Monitors registers reset on page C12-2327](#).

[Table C12-7 on page C12-2327](#) shows the CP15 encodings of all of the Performance Monitors registers.

———— **Note** —————

[Differences in the memory-mapped views of the Performance Monitors registers on page AppxB-2352](#) describes how the characteristics of the PMSWINC register differ when it is accessed through an external debug interface or a memory-mapped interface.

The PMSWINC register bit assignments are:

31	N	N-1	0
Reserved, WI		Event counter software increment bits, Px, for x = 0 to (N-1)	

———— **Note** —————

In the description of the PMSWINC register, N and x have the meanings used in the description of the [PMCNTENSET](#) register.

**Bits[31:N]** Reserved, WI.

**Px, bit[x], for x = 0 to (N-1)**

Event counter x, PMNx, software increment bit.

In an implementation that includes the Virtualization Extensions, in Non-secure PL1 and PL0 modes, if  $x \geq \text{HDCR.HPMN}$  then Px is WI, see [Counter access on page C12-2312](#). Otherwise, the effects of writing to this bit are:

**0** No action, the write is ignored.

**1, if PMNx is enabled and configured to count the Software increment event**

Increment the PMNx event counter by 1.

**1, if PMNx is disabled or not configured to count the Software increment event**

The behavior depends on the PMU version:

**PMUv1** UNPREDICTABLE.

**PMUv2** No action, the write is ignored.

**Accessing the PMSWINC register**

To access the PMSWINC register, write the CP15 registers with <opc1> set to 0, <CRn> set to c9, <CRm> set to c12, and <opc2> set to 4. For example:

MCR p15, 0, <Rt>, c9, c12, 4 ; Write Rt to PMSWINC

### B4.1.124 PMUSERENR, Performance Monitors User Enable Register, VMSA

When accessed through the CP15 interface, the PMUSERENR characteristics are:

<b>Purpose</b>	The PMUSERENR enables or disables User mode access to the Performance Monitors. This register is a Performance Monitors register.
<b>Usage constraints</b>	The PMUSERENR is accessible in: <ul style="list-style-type: none"> <li>• all modes executing at PL1 or higher</li> <li>• User mode as RO.</li> </ul> See <a href="#">Access permissions on page C12-2328</a> for more information.
<b>Configurations</b>	Implemented only as part of the Performance Monitors Extension. The VMSA and PMSA definitions of the register fields are identical. In a VMSA implementation that includes the Security Extensions, this is a Common register.
<b>Attributes</b>	A 32-bit RW register. PMUSERENR.EN is set to 0 on a non-debug logic reset. See also <a href="#">Power domains and Performance Monitors registers reset on page C12-2327</a> . <a href="#">Table C12-7 on page C12-2327</a> shows the CP15 encodings of all of the Performance Monitors registers.

———— **Note** —————

[Differences in the memory-mapped views of the Performance Monitors registers on page AppxB-2352](#) describes how the characteristics of the PMUSERENR differ when it is accessed through an external debug interface or a memory-mapped interface.

The PMUSERENR bit assignments are:

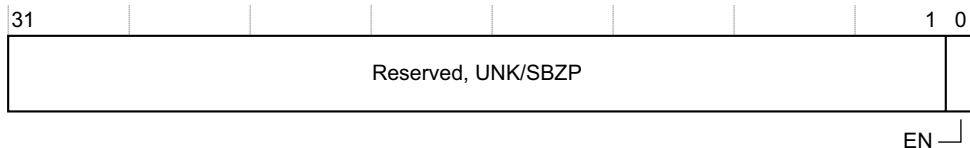

<b>Bits[31:1]</b>	Reserved, UNK/SBZP.
<b>EN, bit[0]</b>	User mode access enable bit. The possible values of this bit are: <ul style="list-style-type: none"> <li><b>0</b> User mode access to the Performance Monitors disabled.</li> <li><b>1</b> User mode access to the Performance Monitors enabled.</li> </ul>

Some MCR and MRC instruction accesses to the Performance Monitors are UNDEFINED in User mode when the EN bit is set to 0. For more information, see [Access permissions on page C12-2328](#).

#### Accessing the PMUSERENR

To access the PMUSERENR, read or write the CP15 registers with <opc1> set to 0, <CRn> set to c9, <CRm> set to c14, and <opc2> set to 0. For example:

```
MRC p15, 0, <Rt>, c9, c14, 0 : Read PMUSERENR into Rt
MCR p15, 0, <Rt>, c9, c14, 0 : Write Rt to PMUSERENR
```

### B4.1.125 PMXEVNTR, Performance Monitors Event Count Register, VMSA

When accessed through the CP15 interface, the PMXEVNTR characteristics are:

<b>Purpose</b>	The PMXEVNTR reads or writes the value of the selected event counter, PMN <sub>x</sub> . <a href="#">PMSELR.SEL</a> determines which event counter is selected. This register is a Performance Monitors register.
<b>Usage constraints</b>	The PMXEVNTR is accessible in: <ul style="list-style-type: none"><li>all modes executing at PL1 or higher</li><li>User mode when <a href="#">PMUSERENR.EN</a> is set to 1.</li></ul> If <a href="#">PMSELR.SEL</a> selects a counter that is not accessible then reads and writes of PMXEVNTR are UNPREDICTABLE. This applies: <ul style="list-style-type: none"><li>If <a href="#">PMSELR.SEL</a> is larger than the number of implemented counters.</li><li>In an implementation that includes the Virtualization Extensions, in Non-secure PL1 and PL0 modes, if <math>\text{PMSELR.SEL} \geq \text{HDCR.HPMN}</math>. The definition of UNPREDICTABLE means that, in this case, a read of PMXEVNTR must not return, and a write of PMXEVNTR must not update the register value.</li></ul> For more information, see <a href="#">Counter access on page C12-2312</a> and <a href="#">Access permissions on page C12-2328</a> .
<b>Configurations</b>	Implemented only as part of the Performance Monitors Extension. The VMSA and PMSA definitions of the register fields are identical. In a VMSA implementation that includes the Security Extensions, this is a Common register.
<b>Attributes</b>	A 32-bit RW register with a reset value that is UNKNOWN on a non-debug logic reset. See also <a href="#">Power domains and Performance Monitors registers reset on page C12-2327</a> . <a href="#">Table C12-7 on page C12-2327</a> shows the CP15 encodings of all of the Performance Monitors registers.

———— **Note** —————

[Differences in the memory-mapped views of the Performance Monitors registers on page AppxB-2352](#) describes how the characteristics of the PMXEVNTR differ when it is accessed through an external debug interface or a memory-mapped interface.

The PMXEVNTR bit assignments are:

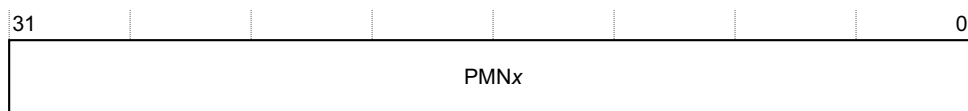

———— **Note** —————

See the Usage constraints for the conditions in which PMXEVNTR is accessible through CP15.



**PMNX, bits[31:0]** The value of the selected event counter, PMNx.

———— **Note** —————

Software can write to the PMXEVNTR even when the counter is disabled. This is true regardless of why the counter is disabled, which can be any of:

- because 1 has been written to the appropriate bit in the [PMCNTENCLR](#) register
- because the [PMCR.E](#) bit is set to 0
- by the non-invasive debug authentication.

## Accessing the PMXEVNTR

To access the PMXEVNTR:

1. Update the [PMSELR](#) to select the required event counter, PMNx.
2. Read or write the CP15 registers with <opc1> set to 0, <CRn> set to c9, <CRm> set to c13, and <opc2> set to 2. For example:

MRC p15, 0, <Rt>, c9, c13, 2 : Read PMXEVNTR into Rt  
MCR p15, 0, <Rt>, c9, c13, 2 : Write Rt to PMXEVNTR

## B4.1.126 PMXEVTYPER, Performance Monitors Event Type Select Register, VMSA

When accessed through the CP15 interface, the PMXEVTYPER characteristics are:

**Purpose** When [PMSELR.SEL](#) selects an event counter, PMN<sub>x</sub>, PMXEVTYPER configures which event increments that event counter.  
In PMUv2 PMXEVTYPER also determines the modes in which PMN<sub>x</sub> or [PMCCNTR](#) increments.  
[PMSELR.SEL](#) determines which event counter is selected, or if [PMCCNTR](#) is selected.

———— **Note** —————

A [PMSELR.SEL](#) value of 0b11111:

- in PMUv1, is reserved
- in PMUv2, selects the PMXEVTYPER for [PMCCNTR](#).

—————

This register is a Performance Monitors register.

**Usage constraints** The PMXEVTYPER is accessible in:

- all modes executing at PL1 or higher
- User mode when [PMUSERENR.EN](#) == 1.

If [PMSELR.SEL](#) selects a counter that is not accessible then reads and writes of PMXEVTYPER are UNPREDICTABLE.

This applies:

- In an implementation that includes PMUv1, if [PMSELR.SEL](#) is larger than the number of implemented counters.
- In an implementation that includes PMUv2, when [PMSELR.SEL](#) is not 0b11111:
  - If [PMSELR.SEL](#) is larger than the number of implemented counters.
  - In an implementation that includes the Virtualization Extensions, in Non-secure PL1 and PL0 modes, if [PMSELR.SEL](#) ≥ [HDCR.HPMN](#).

———— **Note** —————

The Virtualization Extensions cannot be implemented with PMUv1 and therefore this case applies only to the PMUv2 register format.

—————

The definition of UNPREDICTABLE means that, in this case, a read of PMXEVTYPER must not return, and a write of PMXEVTYPER must not update the register value.

For more information, see [Counter access on page C12-2312](#) and [Access permissions on page C12-2328](#).

**Configurations** Implemented only as part of the Performance Monitors Extension.  
In PMUv1, the VMSA and PMSA definitions of the register fields are identical.  
In a VMSA implementation that includes the Security Extensions, this is a Common register.

**Attributes** A 32-bit RW register. See [PMXEVTYPER reset values on page B4-1697](#) for information about the non-debug logic reset value. See also [Power domains and Performance Monitors registers reset on page C12-2327](#).  
[Table C12-7 on page C12-2327](#) shows the CP15 encodings of all of the Performance Monitors registers.



**NSU, bit[28], Security Extensions implemented**

Non-secure unprivileged control bit. Controls counting in when executing in Non-secure at PL0. The behavior depends on the combined values of the U and NSU bits:

**U == NSU** In Non-secure state, count events when executing at PL0.

**U != NSU** In Non-secure state, do not count events when executing at PL0.

**NSH, bit[27], Virtualization Extensions implemented**

Non-secure PL2 enable bit. The possible values of this bit are:

**0** In Non-secure state, do not count events when executing at PL2.

**1** In Non-secure state, count events when executing at PL2.

———— **Note** —————

The value of the P bit does not affect whether events are counted when executing in Non-secure state at PL2.

**Bit[27], Virtualization Extensions not implemented**

Reserved, UNK/SBZP.

**Bits[26:8]**

Reserved, UNK/SBZP.

**evtCount, bits[7:0]**

Event to count. The event number of the event that is counted by the selected event counter, PMNx. For more information, see [Event numbers on page B4-1697](#).

This field is reserved when **PMSELR.SEL** is set to 31, to select **PMCCNTR**.

[Table B4-27](#) shows the combination of reserved encodings that software must not select. However, they are not UNPREDICTABLE encodings and hardware must implement the P, U, NSK, NSU, and NSH filtering bits as described.

**Table B4-27 Reserved encodings, must not be used**

<b>P</b>	<b>U</b>	<b>NSK</b>	<b>NSU</b>	<b>NSH</b>	<b>Modes in which events are counted</b>
1	1	0	0	0	Never
0	1	1	1	0	Secure PL1 modes and Non-secure User mode
1	0	1	1	0	Secure User mode and Non-secure PL1 modes
0	1	1	1	1	Secure PL1 modes, Non-secure User mode, and Hyp mode
1	0	1	1	1	Secure User mode, Non-secure PL1 modes, and Hyp mode
1	0	0	0	1	User mode and Hyp mode
1	0	0	1	1	Secure User mode and Hyp mode
1	1	0	1	1	Non-secure User mode and Hyp mode

———— **Note** —————

- In some documentation published before issue C.a of this manual, the **PMXEVTYPER** register accessed when **PMSELR.SEL** is set to 31 is described as the **PMCCFILTR**.
- In issue C.a of this manual:
  - the P bit is called the PL1 bit
  - the NSK bit is called the NSPL1 bit.

## PMXEVTYPER reset values

Immediately after a non-debug logic reset:

- The values of the instances of PMXEVTYPER that relate to an event counter are UNKNOWN. That is, if  $m$  is one less than the number of implemented event counters, the non-debug reset values of PMXEVTYPER0 to PMXEVTYPER $m$  are UNKNOWN.
- In PMUv2, the reset values of the defined fields of the instance of PMXEVTYPER that relates to the cycle counter are zero. That is, the non-debug reset value of each implemented bit of PMXEVTYPER31.{P, U, NSK, NSU, NSH} is 0.

## Event numbers

The PMXEVTYPER uses event numbers to determine the event that causes an event counter to increment. These event numbers are split into two ranges:

0x00-0x3F	Common features. Reserved for the specified events. When an ARMv7 processor supports monitoring of an event that is assigned a number in this range, if possible it must use that number for the event. Unassigned values are reserved and might be used for additional common events in future versions of the architecture. For more information about the assigned values in the common features range, see <a href="#">Common event numbers on page C12-2316</a> .
0x40-0xFF	IMPLEMENTATION DEFINED features. For more information, see <a href="#">IMPLEMENTATION DEFINED event numbers on page C12-2325</a> .

## Accessing the PMXEVTYPER

To access the PMXEVTYPER:

1. Update [PMSELR](#) to select the required event counter, PMN $x$ , or, in PMUv2, [PMCCNTR](#).
2. Read or write the CP15 registers with <opc1> set to 0, <CRn> set to c9, <CRm> set to c13, and <opc2> set to 1. For example:

```
MRC p15, 0, <Rt>, c9, c13, 1 : Read PMXEVTYPER into Rt
MCR p15, 0, <Rt>, c9, c13, 1 : Write Rt to PMXEVTYPER
```

## B4.1.127 PRRR, Primary Region Remap Register, VMSA

The PRRR characteristics are:

- Purpose** Under the conditions described in [Architectural status of PRRR and NMRR on page B4-1700](#), PRRR controls the top level mapping of the TEX[0], C, and B memory region attributes. For more information see [Short-descriptor format memory region attributes, with TEX remap on page B3-1368](#).
- This register is part of the Virtual memory control registers functional group.
- Usage constraints** Only accessible from PL1 or higher.
- In a processor that implements the Large Physical Address Extension, not accessible when using the Long-descriptor translation table format. See, instead, [MAIR0 and MAIR1, Memory Attribute Indirection Registers 0 and 1, VMSA on page B4-1645](#).
- See also [Architectural status of PRRR and NMRR on page B4-1700](#).
- Configurations** In an implementation that includes the Security Extensions, the PRRR:
- is Banked
  - has write access to the Secure copy of the register disabled when the **CPI5SDISABLE** signal is asserted HIGH.
- Attributes** A 32-bit RW register with an UNKNOWN reset value. See also [Reset behavior of CPI4 and CPI5 registers on page B3-1450](#).
- [Table B3-45 on page B3-1493](#) shows the encodings of all of the registers in the Virtual memory control registers functional group.

The PRRR bit assignments are:

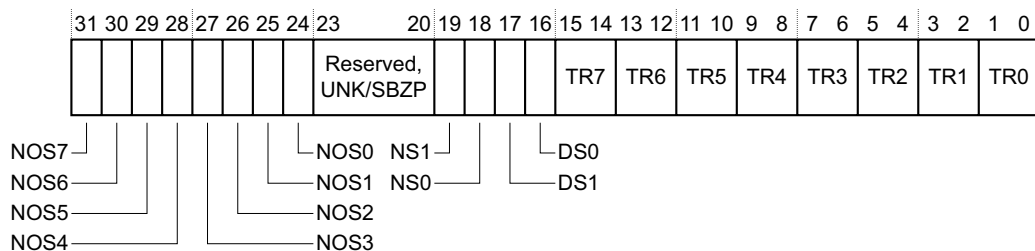

### NOS $n$ , bit[24+ $n$ ], for values of $n$ from 0 to 7

Outer Shareable property mapping for memory attributes  $n$ , if the region is mapped as Normal or Device memory that is Shareable.  $n$  is the value of the TEX[0], C and B bits, see [Table B4-28 on page B4-1700](#). The possible values of each NOS $n$  bit are:

- 0** Memory region is Outer Shareable.
- 1** Memory region is Inner Shareable.

The value of this bit is ignored if the region is Normal or Device memory that is not Shareable. For more information see [Interpretation of the NOS \$n\$  fields in the PRRR, with TEX remap on page B3-1371](#).

The meaning of the field with  $n = 6$  is IMPLEMENTATION DEFINED and might differ from the meaning given here. This is because the meaning of the attribute combination {TEX[0] = 1, C = 1, B = 0} is IMPLEMENTATION DEFINED.

If the implementation does not distinguish between Inner Shareable and Outer Shareable then these bits are reserved, RAZ/WI.

**Note**

For Device memory, for some implementations, the NOS $n$  field has no significance.

**Bits[23:20]** Reserved, UNK/SBZP.

**NS1, bit[19]** Mapping of S = 1 attribute for Normal memory. This bit gives the mapped Shareable attribute for a region of memory that:

- is mapped as Normal memory
- has the S bit set to 1.

The possible values of the bit are:

- 0** Region is not Shareable
- 1** Region is Shareable.

**NS0, bit[18]** Mapping of S = 0 attribute for Normal memory. This bit gives the mapped Shareable attribute for a region of memory that:

- is mapped as Normal memory
- has the S bit set to 0.

The possible values of the bit are the same as those given for the NS1 bit, bit[19].

**DS1, bit[17]** Mapping of S = 1 attribute for Device memory. This bit gives the mapped Shareable attribute for a region of memory that:

- is mapped as Device memory
- has the S bit set to 1.

The possible values of the bit are the same as those given for the NS1 bit, bit[19].

———— **Note** —————

For Device memory, for some implementations, the DS $n$  fields have no significance.

**DS0, bit[16]** Mapping of S = 0 attribute for Device memory. This bit gives the mapped Shareable attribute for a region of memory that:

- is mapped as Device memory
- has the S bit set to 0.

The possible values of the bit are the same as those given for the NS1 bit, bit[19].

———— **Note** —————

For Device memory, for some implementations, the DS $n$  fields have no significance.

**TR $n$ , bits[2 $n$ +1:2 $n$ ] for values of  $n$  from 0 to 7**

Primary TEX mapping for memory attributes  $n$ .  $n$  is the value of the TEX[0], C and B bits, see [Table B4-28 on page B4-1700](#). This field defines the mapped memory type for a region with attributes  $n$ . The possible values of the field are:

- 00** Strongly-ordered.
- 01** Device.
- 10** Normal Memory.
- 11** Reserved, effect is UNPREDICTABLE.

The meaning of the field with  $n = 6$  is IMPLEMENTATION DEFINED and might differ from the meaning given here. This is because the meaning of the attribute combination {TEX[0] = 1, C = 1, B = 0} is IMPLEMENTATION DEFINED.

Table B4-28 shows the mapping between the memory region attributes and the  $n$  value used in the PRRR.nOS $n$  and PRRR.TR $n$  field descriptions.

**Table B4-28 Memory attributes and the  $n$  value for the PRRR field descriptions**

Attributes			$n$ value
TEX[0]	C	B	
0	0	0	0
0	0	1	1
0	1	0	2
0	1	1	3
1	0	0	4
1	0	1	5
1	1	0	6
1	1	1	7

For more information about the PRRR, see *Short-descriptor format memory region attributes, with TEX remap* on page B3-1368.

### Architectural status of PRRR and NMRR

The function of these registers is architecturally defined only when the processor is using the Short-descriptor translation table formats and either:

- SCTLR.TRE is set to 1
- SCTLR.TRE is set to 0 and the processor has not invoked any IMPLEMENTATION DEFINED mechanism using MMU remap.

Otherwise, when the processor is using the Short-descriptor translation table formats, their behavior is IMPLEMENTATION DEFINED, see *SCTLR.TRE, SCTLR.M, and the effect of the TEX remap registers* on page B3-1371.

When an implementation includes the Large Physical Address Extension, and address translation is using the Long-descriptor translation table formats, MAIR0 replaces the PRRR, and MAIR1 replaces the NMRR.

### Accessing the PRRR

To access the PRRR, software reads or writes the CP15 registers with <opc1> set to 0, <CRn> set to c10, <CRm> set to c2, and <opc2> set to 0. For example:

```
MRC p15, 0, <Rt>, c10, c2, 0 ; Read PRRR into Rt
MCR p15, 0, <Rt>, c10, c2, 0 ; Write Rt to PRRR
```



### B4.1.128 REVIDR, Revision ID Register, VMSA

The REVIDR characteristics are:

<b>Purpose</b>	The REVIDR provides implementation-specific minor revision information that can only be interpreted in conjunction with the <a href="#">MIDR</a> . This register is part of the Identification registers functional group.
<b>Usage constraints</b>	Only accessible from PL1 or higher.
<b>Configurations</b>	An optional register. When REVIDR is not implemented, its encoding is an alias of the <a href="#">MIDR</a> . This register is not implemented in architecture versions before ARMv7. If the implementation includes the Security Extensions, the register is Common.
<b>Attributes</b>	A 32-bit RO register with an IMPLEMENTATION DEFINED value. See also <a href="#">Reset behavior of CP14 and CP15 registers on page B3-1450</a> . <a href="#">Table B3-44 on page B3-1492</a> shows the encodings of all of the registers in the Identification registers functional group.

The REVIDR bit assignments are IMPLEMENTATION DEFINED.

———— **Note** —————

To determine whether REVIDR is implemented, software can:

- Read [MIDR](#).
- Read REVIDR.
- Compare the two values. If they are identical, REVIDR is not implemented.

#### Accessing the REVIDR

To access REVIDR, software reads the CP15 registers with <opc1> set to 0, <CRn> set to c0, <CRm> set to c0, and <opc2> set to 6. For example:

MRC p15, 0, <Rt>, c0, c0, 6 ; Read REVIDR into Rt

### B4.1.129 SCR, Secure Configuration Register, Security Extensions

The SCR characteristics are:

- Purpose** The SCR defines the configuration of the current security state. It specifies:
- the security state of the processor, Secure or Non-secure
  - what mode the processor branches to if an IRQ, FIQ or external abort occurs
  - whether the CPSR.{F, A} bits can be modified when SCR.NS == 1.
- This register is part of the Security Extensions registers functional group.
- Usage constraints** Only accessible from Secure PL1 modes.
- Configurations** The SCR is implemented only as part of the Security Extensions. It is a Restricted access register, meaning it exists only in the Secure state.
- Attributes** A 32-bit RW register that resets to zero.
- Table B3-54 on page B3-1500 shows the encoding of all of the Security Extensions registers.

The SCR bit assignments are:

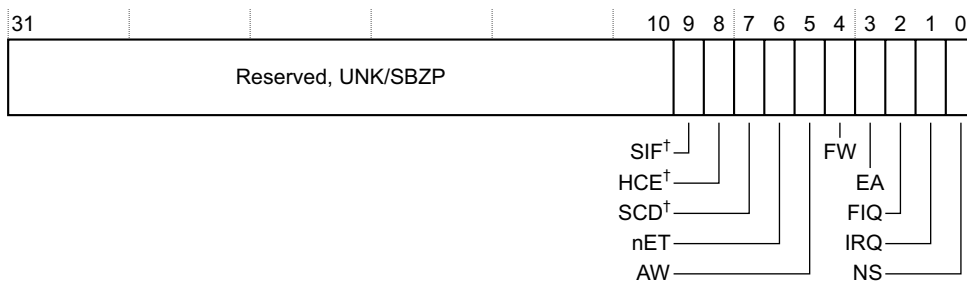

† Reserved before the introduction of the Virtualization Extensions, see text for more information.

**Bits[31:10]** Reserved, UNK/SBZP.

#### SIF, bit[9], when implementation includes the Virtualization Extensions

Secure instruction fetch. When the processor is in Secure state, this bit disables instruction fetches from Non-secure memory. The possible values of this bit are:

- 0** Secure state instruction fetches from Non-secure memory are permitted.
- 1** Secure state instruction fetches from Non-secure memory are not permitted.

For more information, see [Restriction on Secure instruction fetch on page B3-1361](#).

#### HCE, bit[8], when implementation includes the Virtualization Extensions

Hyp Call enable. This bit enables use of the HVC instruction from Non-secure PL1 modes. The possible values of this bit are:

- 0** HVC instruction is UNDEFINED in Non-secure PL1 modes, and UNPREDICTABLE in Hyp mode.
- 1** HVC instruction is enabled in Non-secure PL1 modes, and performs a Hyp Call.

For more information, see [Hyp mode on page B1-1141](#).

#### SCD, bit[7], when implementation includes the Virtualization Extensions

Secure Monitor Call disable. Makes the SMC instruction UNDEFINED in Non-secure state. The possible values of this bit are:

- 0** SMC executes normally in Non-secure state, performing a Secure Monitor Call.
- 1** SMC instruction is UNDEFINED in Non-secure state.

A trap of the SMC instruction to Hyp mode takes priority over the value of this bit, see [Trapping use of the SMC instruction on page B1-1254](#).

For more information, see [SMC \(previously SMI\) on page B9-2000](#).

**Bits[9:7], when implementation does not include the Virtualization Extensions**

Reserved, UNK/SBZP.

- nET, bit[6]** Not Early Termination. This bit disables early termination. The possible values of this bit are:
- 0** Early termination permitted. Execution time of data operations can depend on the data values.
  - 1** Disable early termination. The number of cycles required for data operations is forced to be independent of the data values.

This IMPLEMENTATION DEFINED mechanism can disable data dependent timing optimizations from multiplies and data operations. It can provide system support against information leakage that might be exploited by timing correlation types of attack.

On implementations that do not support early termination or do not support disabling early termination, this bit is UNK/SBZP.

- AW, bit[5]** A bit writable. In an implementation that does not include the Virtualization Extensions, this bit controls whether [CPSR.A](#) can be modified in Non-secure state, and the possible values of this bit are:

- 0** [CPSR.A](#) can be modified only in Secure state.
- 1** [CPSR.A](#) can be modified in any security state.

In an implementation that includes the Virtualization Extensions, this bit:

- Is part of the control of whether [CPSR.A](#) masks asynchronous external aborts that are taken from Non-secure state and routed to Monitor mode. When all of the following apply, [CPSR.A](#) has no effect on any asynchronous external abort taken from Non-secure state:
  - the EA bit is set to 1, to route external aborts to Monitor mode
  - this bit is set to 0
  - [HCR.AMO](#) is set to 0.

For more information, see [Asynchronous exception masking on page B1-1183](#).

- Otherwise, has no effect.

———— **Note** —————

This means that, in an implementation that includes the Virtualization Extensions, this bit has no effect on updates to [CPSR.A](#), and [CPSR.A](#) can be modified in either security state.

- FW, bit[4]** F bit writable. In an implementation that does not include the Virtualization Extensions, this bit controls whether [CPSR.F](#) can be modified in Non-secure state, and the possible values of this bit are:

- 0** [CPSR.F](#) can be modified only in Secure state.
- 1** [CPSR.F](#) can be modified in any security state.

In an implementation that includes the Virtualization Extensions, this bit:

- Is part of the control of whether [CPSR.F](#) masks FIQ taken from Non-secure state that are routed to Monitor mode. When all of the following apply, [CPSR.F](#) has no effect on any FIQ taken from Non-secure state:
  - the FIQ bit is set to 1, to route FIQs to Monitor mode
  - this bit is set to 0
  - [HCR.FMO](#) is set to 0.

For more information, see [Asynchronous exception masking on page B1-1183](#).

- Otherwise, has no effect.

———— **Note** —————

This means that, in an implementation that includes the Virtualization Extensions, this bit has no effect on updates to [CPSR.F](#), and [CPSR.F](#) can be modified in either security state.

**EA, bit[3]** External Abort handler. This bit controls whether external aborts are taken to Monitor mode. The possible values of this bit are:  
**0** External aborts not taken to Monitor mode.  
**1** External aborts taken to Monitor mode.  
 For more information, see [Asynchronous exception routing controls on page B1-1174](#).

———— **Note** —————

As described in the referenced section, the EA bit controls the routing of both synchronous and asynchronous external aborts.

**FIQ, bit[2]** FIQ handler. This bit controls whether FIQ exceptions are taken to Monitor mode. The possible values of this bit are:  
**0** FIQs not taken to Monitor mode.  
**1** FIQs taken to Monitor mode.  
 For more information, see [Asynchronous exception routing controls on page B1-1174](#).

**IRQ, bit[1]** IRQ handler. This bit controls whether IRQ exceptions are taken to Monitor mode. The possible values of this bit are:  
**0** IRQs not taken to Monitor mode.  
**1** IRQs taken to Monitor mode.  
 For more information, see [Asynchronous exception routing controls on page B1-1174](#).

**NS, bit[0]** Non-secure bit. Except when the processor is in Monitor mode, this bit determines the security state of the processor. [Table B4-29](#) shows the security settings:

**Table B4-29 Processor security state**

SCR.NS	Processor mode, from <b>CPSR.M</b> bits	
	Monitor mode	All modes except Monitor mode
0	Secure state	Secure state
1	Secure state	Non-secure state

For more information, see [Changing from Secure to Non-secure state on page B1-1157](#).

The value of the NS bit also affects the accessibility of the Banked CP15 registers in Monitor mode, see [Access to registers from Monitor mode on page B3-1459](#).

Unless the processor is in Debug state, when an exception occurs in Monitor mode the hardware sets the NS bit to 0.

———— **Note** —————

The Virtualization Extensions introduce additional exception routing controls that can apply when an SCR. {EA, FIQ, IRQ} bit does not route the corresponding exception to Monitor mode. [Asynchronous exception routing controls on page B1-1174](#) describes these controls.

Whenever the processor changes security state, the monitor software can change the value of the EA, FIQ and IRQ bits. This means that the behavior of IRQ, FIQ and External Abort exceptions can be different in each security state.

**Accessing the SCR**

To access the SCR, software reads or writes the CP15 registers with <opc1> set to 0, <CRn> set to c1, <CRm> set to c1, and <opc2> set to 0. For example:

```
MRC p15, 0, <Rt>, c1, c1, 0 ; Read SCR into Rt
MCR p15, 0, <Rt>, c1, c1, 0 ; Write Rt to SCR
```



- AFE, bit[29]** Access flag enable. The possible values of this bit are:
- 0** In the translation table descriptors, AP[0] is an access permissions bit. The full range of access permissions is supported. No Access flag is implemented.
  - 1** In the translation table descriptors, AP[0] is the Access flag. Only the simplified model for access permissions is supported.

Setting this bit to 1 enables use of the AP[0] bit in the translation table descriptors as the *Access flag*. It also restricts access permissions in the translation table descriptors to the simplified model described in [AP\[2:1\] access permissions model on page B3-1357](#).

In an implementation that includes the Security Extensions, this bit is Banked between the Secure and Non-secure copies of the register.

In an implementation that includes the Virtualization Extensions, when `TTBCR.EAE` is set to 1, to enable use of the Long-descriptor translation table format, this bit is UNK/SBOP.

- TRE, bit[28]** TEX remap enable. The possible values of this bit are:
- 0** TEX remap disabled. TEX[2:0] are used, with the C and B bits, to describe the memory region attributes.
  - 1** TEX remap enabled. TEX[2:1] are reassigned for use as bits managed by the operating system. The TEX[0], C and B bits, with the MMU remap registers, describe the memory region attributes.

Setting this bit to 1 enables remapping of the TEX[2:1] bits for use as two translation table bits that can be managed by the operating system. Enabling this remapping also changes the scheme that defines the memory region attributes in the VMSA.

In an implementation that includes the Security Extensions, this bit is Banked between the Secure and Non-secure copies of the register.

In an implementation that includes the Virtualization Extensions, when `TTBCR.EAE` is set to 1, to enable use of the Long-descriptor translation table format, this bit is UNK/SBOP.

For more information, see [Memory region attributes on page B3-1366](#).

**NMFI, bit[27]**

*Non-maskable FIQ* (NMFI) support. The possible values of this bit are:

- 0** Software can mask FIQs by setting the `CPSR.F` bit to 1.
- 1** Software cannot set the `CPSR.F` bit to 1. This means software cannot mask FIQs.

This bit is read-only.

In an implementation that includes the Security Extensions this bit is common to the Secure and Non-secure versions of the register.

The Virtualization Extensions do not support NMFIs. On an implementation that includes the Virtualization Extensions, this bit is RAZ. Otherwise, it is IMPLEMENTATION DEFINED whether an implementation supports NMFIs, and this bit is:

- RAZ if NMFIs are not supported
- determined by a configuration input signal if NMFIs are supported.

For more information, see [Non-maskable FIQs on page B1-1151](#).

**Bit[26]** Reserved, RAZ/SBZP.

**EE, bit[25]** Exception Endianness. This bit defines the value of the `CPSR.E` bit on entry to an exception vector, including reset. The possible values of this bit are:

- 0** Little-endian.
- 1** Big-endian.

This bit value also defines the endianness of the translation table data for translation table lookups.

In an implementation that includes the Security Extensions, this bit is Banked between the Secure and Non-secure copies of the register.

This is a read/write bit. An implementation can include a configuration input signal that determines the reset value of the EE bit. If there is no configuration input signal to determine the reset value of this bit then it resets to 0.

- VE, bit[24]** Interrupt Vectors Enable. This bit controls the vectors used for the FIQ and IRQ interrupts. The possible values of this bit are:
- 0** Use the FIQ and IRQ vectors from the vector table, see the V bit entry.
  - 1** Use the IMPLEMENTATION DEFINED values for the FIQ and IRQ vectors.
- In an implementation that includes the Security Extensions, this bit is Banked between the Secure and Non-secure copies of the register.
- In an implementation that includes the Virtualization Extensions, when at least one of [HCR.FMO](#) and [HCR.IMO](#) is set to 1, the processor behaves as if the Non-secure copy of this bit is set to 0, regardless of its actual value.
- For more information, see [Vectored interrupt support on page B1-1167](#).
- If the implementation does not support IMPLEMENTATION DEFINED FIQ and IRQ vectors then this bit is RAZ/WI.
- From the introduction of the Virtualization Extensions, ARM deprecates any use of this bit.
- Bit[23]** Reserved, RAO/SBOP.
- U, bit[22]** In ARMv7 this bit is RAO/SBOP, indicating use of the alignment model described in [Alignment support on page A3-108](#).
- For details of this bit in earlier versions of the architecture see [Alignment on page AppxL-2504](#).
- FI, bit[21]** Fast interrupts configuration enable. The possible values of this bit are:
- 0** All performance features enabled.
  - 1** Low interrupt latency configuration. Some performance features disabled.
- Setting this bit to 1 can reduce interrupt latency in an implementation, by disabling IMPLEMENTATION DEFINED performance features.
- In an implementation that includes the Security Extensions, this bit is common to the Secure and Non-secure versions of the register.
- This bit is:
- a read/write bit if the implementation does not include the Security Extensions
  - if the implementation includes the Security Extensions:
    - a read/write bit if the processor is in Secure state
    - a read-only bit if the processor is in Non-secure state.
- For more information, see [Low interrupt latency configuration on page B1-1197](#).
- If the implementation does not support a mechanism for selecting a low interrupt latency configuration this bit is RAZ/WI.
- UWXN, bit[20], if implementation includes the Virtualization Extensions**
- Unprivileged write permission implies PL1 XN. The possible values of this bit are:
- 0** Regions with unprivileged write permission are not forced to XN.
  - 1** Regions with unprivileged write permission are forced to XN for PL1 accesses.
- Setting this bit to 1 requires all memory regions with unprivileged write permission to be treated as XN for any access from software that is executing at PL1.
- For more information, see [Preventing execution from writable locations on page B3-1361](#).
- This bit resets to 0 in both the Secure and the Non-secure copy of the register.

**WXN, bit[19], if implementation includes the Virtualization Extensions**

Write permission implies XN. The possible values of this bit are:

- 0** Regions with write permission are not forced to XN.
- 1** Regions with write permission are forced to XN.

Setting this bit to 1 requires all memory regions with write permission to be treated as XN.

For more information, see [Preventing execution from writable locations on page B3-1361](#).

This bit resets to 0 in both the Secure and the Non-secure copy of the register.

**Bit[20:19], if implementation does not include the Virtualization Extensions**

Reserved, RAZ/SBZP.

**Bit[18]** Reserved, RAO/SBOP.

**HA, bit[17]** Hardware Access flag enable. If the implementation provides hardware management of the Access flag this bit enables the Access flag management. The possible values of this bit are:

- 0** Hardware management of Access flag disabled.
- 1** Hardware management of Access flag enabled.

In an implementation that includes the Security Extensions, bit is Banked between the Secure and Non-secure copies of the register.

If the implementation does not provide hardware management of the Access flag then this bit is RAZ/WI.

For more information, see [Hardware management of the Access flag on page B3-1363](#).

From the introduction of the Virtualization Extensions, ARM deprecates any use of this bit.

**Bit[16]** Reserved, RAO/SBOP.

**Bit[15]** Reserved, RAZ/SBZP.

**RR, bit[14]** Round Robin select. If the cache implementation supports the use of an alternative replacement strategy that has a more easily predictable worst-case performance, this bit controls whether it is used. The possible values of this bit are:

- 0** Normal replacement strategy, for example, random replacement.
- 1** Predictable strategy, for example, round-robin replacement.

In an implementation that includes the Security Extensions, this bit is common to the Secure and Non-secure versions of the register.

This bit is:

- a read/write bit if the implementation does not include the Security Extensions
- if the implementation includes the Security Extensions:
  - a read/write bit if the processor is in Secure state
  - a read-only bit if the processor is in Non-secure state.

The replacement strategy associated with each value of the RR bit is IMPLEMENTATION DEFINED.

If the implementation does not support multiple IMPLEMENTATION DEFINED replacement strategies this bit is RAZ/WI.

**V, bit[13]** Vectors bit. This bit selects the base address of the exception vectors. The possible values of this bit are:

- 0** Low exception vectors, base address 0x00000000.  
In an implementation that includes the Security Extensions, this base address can be re-mapped.
- 1** High exception vectors (Hivecs), base address 0xFFFF0000.  
This base address is never remapped.

In an implementation that includes the Security Extensions, this bit is Banked between the Secure and Non-secure copies of the register.



An implementation can include a configuration input signal that determines the reset value of the V bit. If there is no configuration input signal to determine the reset value of this bit then it resets to 0. For more information, see [Exception vectors and the exception base address on page B1-1164](#).

**I, bit[12]** Instruction cache enable: This is a global enable bit for instruction caches. The possible values of this bit are:

- 0** Instruction caches disabled.
- 1** Instruction caches enabled.

In an implementation that includes the Security Extensions, this bit is Banked between the Secure and Non-secure copies of the register.

If the system does not implement any instruction caches that can be accessed by the processor, at any level of the memory hierarchy, this bit is RAZ/WI.

If the system implements any instruction caches that can be accessed by the processor then it must be possible to disable them by setting this bit to 0.

For more information see [Cache enabling and disabling on page B2-1270](#).

**Z, bit[11]** Branch prediction enable. The possible values of this bit are:

- 0** Program flow prediction disabled.
- 1** Program flow prediction enabled.

Setting this bit to 1 enables branch prediction, also called program flow prediction.

In an implementation that includes the Security Extensions, this bit is Banked between the Secure and Non-secure copies of the register.

If program flow prediction cannot be disabled, this bit is RAO/WI. Program flow prediction includes all possible forms of speculative change of instruction stream prediction. Examples include static prediction, dynamic prediction, and return stacks.

If the implementation does not support program flow prediction this bit is RAZ/WI.

**SW, bit[10]** SWP and SWPB enable. This bit enables the use of SWP and SWPB instructions. The possible values of this bit are:

- 0** SWP and SWPB are UNDEFINED.
- 1** SWP and SWPB perform as described in [SWP, SWPB on page A8-722](#).

In an implementation that includes the Security Extensions, this bit is Banked between the Secure and Non-secure copies of the register. The bit is reset to 0.

This bit is part of the Multiprocessing Extensions. In implementations that do not implement the Multiprocessing Extensions this bit is RAZ and SWP and SWPB instructions perform as described in [SWP, SWPB on page A8-722](#).

The Virtualization Extensions make the SWP and SWPB instructions optional. In an implementation that does not include the SWP and SWPB instructions, the SW bit is RAZ/WI.

———— **Note** —————

When use of this bit is supported, at reset, it disables SWP and SWPB. This means that operating systems have to choose to use SWP or SWPB.

**Bits[9:8]** Reserved, RAZ/SBZP.

**B, bit[7]** In ARMv7 this bit is RAZ/SBZP, indicating use of the endianness model described in [Endian support on page A3-110](#).

For details of this bit in earlier versions of the architecture see:

- for ARMv6, [Endian support on page AppxL-2505](#)
- for ARMv4 and ARMv5, [Endian support on page AppxO-2591](#).

**Bit[6]** Reserved, RAO/SBOP.

#### CP15BEN, bit[5]

CP15 barrier enable. If implemented, this is an enable bit for the CP15 DMB, DSB, and ISB barrier operations, and the possible values of this bit are:

- 0** CP15 barrier operations disabled. Their encodings are UNDEFINED.
- 1** CP15 barrier operations enabled.

This bit is optional. If not implemented, bit[5] is RAO/WI.

If this bit is implemented, its reset value is 1.

In an implementation that includes the Security Extensions, this bit is Banked between the Secure and Non-secure copies of the register.

In an implementation that included the Virtualization Extensions:

- If this bit is implemented then [HSCTLR.CP15BEN](#) must be implemented.
- This bit controls the use of these operations from PL1 and PL0 modes. [HSCTLR.CP15BEN](#) controls their use from Non-secure PL2 mode.

#### ———— Note —————

This bit is first defined with the introduction of the Virtualization Extensions. However, it can be implemented on any ARMv7-A or ARMv7-R processor.

For more information about these operations see [Data and instruction barrier operations, VMSA on page B4-1749](#).

**Bits[4:3]** Reserved, RAO/SBOP.

**C, bit[2]** Cache enable. This is a global enable bit for data and unified caches. The possible values of this bit are:

- 0** Data and unified caches disabled.
- 1** Data and unified caches enabled.

In an implementation that includes the Security Extensions, this bit is Banked between the Secure and Non-secure copies of the register.

If the system does not implement any data or unified caches that can be accessed by the processor, at any level of the memory hierarchy, this bit is RAZ/WI.

If the system implements any data or unified caches that can be accessed by the processor then it must be possible to disable them by setting this bit to 0.

For more information about the effect of this bit see [Cache enabling and disabling on page B2-1270](#).

**A, bit[1]** Alignment check enable. This is the enable bit for Alignment fault checking. The possible values of this bit are:

- 0** Alignment fault checking disabled.
- 1** Alignment fault checking enabled.

In an implementation that includes the Security Extensions, this bit is Banked between the Secure and Non-secure copies of the register.

For more information, see [Unaligned data access on page A3-108](#).

**M, bit[0]** MMU enable. This is a global enable bit for the PL1&0 stage 1 MMU. The possible values of this bit are:

- 0** PL1&0 stage 1 MMU disabled.
- 1** PL1&0 stage 1 MMU enabled.

In an implementation that includes the Security Extensions, this bit is Banked between the Secure and Non-secure copies of the register.

For more information, see [The effects of disabling MMUs on VMSA behavior on page B3-1314](#).

## Reset value of the SCTLR

The SCTLR has an IMPLEMENTATION DEFINED reset value. There are different types of bits in the SCTLR:

- Some bits are defined as RAZ or RAO, and have the same value in all VMSAv7 implementations. [Figure B4-1](#) shows the values of these bits.
- Some bits are read-only and either:
  - have an IMPLEMENTATION DEFINED value
  - have a value that is determined by a configuration input signal.
- Some bits are read/write and either:
  - reset to zero
  - reset to an IMPLEMENTATION DEFINED value
  - reset to a value that is determined by a configuration input signal.

[Figure B4-1](#) shows the reset value, or how the reset value is defined, for each bit of the SCTLR. It also shows the possible values of each half byte of the register.

In an implementation that includes the Security Extensions, this IMPLEMENTATION DEFINED reset value applies only to the Secure copy of the SCTLR, except that, in an implementation that includes the Virtualization Extensions, the UWXN and WXN bits also reset to 0 in the Non-secure copy of the SCTLR.

On startup or after a reset, software must program the non-Banked read/write bits of the Non-secure copy of the register with the required values.

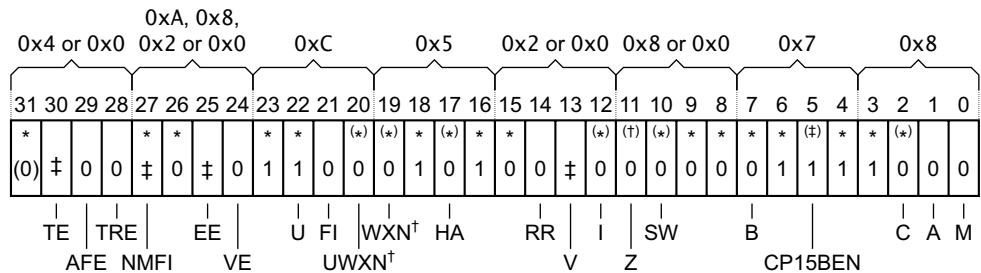

‡ Reserved before the introduction of the Virtualization Extensions, see text for more information.

\* Read-only bits, including RAZ and RAO bits.

(\*) Can be RAZ. Otherwise read/write, resets to 0.

(†) Can be read-only, with IMPLEMENTATION DEFINED value. Otherwise resets to 0.

(‡) Can be read-only, RAO. Otherwise resets to 1.

‡ Value or reset value can depend on configuration input. Otherwise RAZ or resets to 0.

**Figure B4-1** Reset value of the SCTLR, VMSAv7

## Accessing the SCTLR

To access the SCTLR, software reads or writes the CP15 registers with <opc1> set to 0, <CRn> set to c1, <CRm> set to c0, and <opc2> set to 0. For example:

```
MRC p15, 0, <Rt>, c1, c0, 0 ; Read SCTLR into Rt
MCR p15, 0, <Rt>, c1, c0, 0 ; Write Rt to SCTLR
```

### Note

Additional configuration and control bits might be added to the SCTLR in future versions of the ARM architecture. ARM strongly recommends that software always uses a read, modify, write sequence to update the SCTLR. This prevents software modifying any bit that is currently unallocated, and minimizes the chance of the register update having undesired side-effects.

### B4.1.131 SDER, Secure Debug Enable Register, Security Extensions

The SDER characteristics are:

- Purpose** The SDER controls invasive and non-invasive debug in the Secure PL0 mode. This register is part of the Security Extensions registers functional group.
- Usage constraints** Only accessible from Secure PL1 modes.
- Configurations** The SDER is implemented only as part of the Security Extensions. It is a Restricted access register, meaning it exists only in the Secure state.
- Attributes** A 32-bit RW register with an UNKNOWN reset value. For more information, see [Reset behavior of CP14 and CP15 registers on page B3-1450](#).  
[Table B3-54 on page B3-1500](#) shows the encoding of all of the Security Extensions registers.

The SDER bit assignments are:

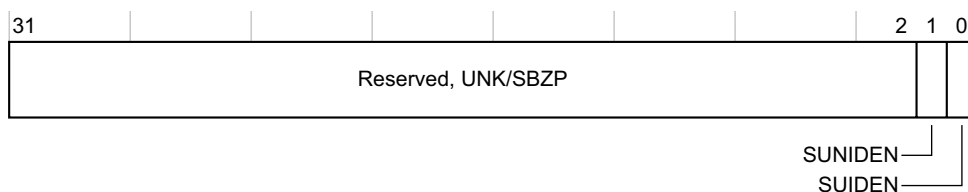

**Bits[31:2]** Reserved, UNK/SBZP.

#### SUNIDEN, bit[1]

Secure User Non-Invasive Debug Enable:

- 0** Non-invasive debug not permitted in Secure PL0 mode.
- 1** Non-invasive debug permitted in Secure PL0 mode.

#### SUIDEN, bit[0]

Secure User Invasive Debug Enable:

- 0** Invasive debug not permitted in Secure PL0 mode.
- 1** Invasive debug permitted in Secure PL0 mode.

For more information about the use of the SUNIDEN and SUIDEN bits see:

- [Chapter C2 Invasive Debug Authentication](#)
- [Chapter C9 Non-invasive Debug Authentication](#).

#### ————— Note —————

- Secure PL0 mode is synonymous with Secure User mode.
- Invasive and non-invasive debug in Secure PL1 modes is controlled by hardware only. For more information, see [Chapter C2 Invasive Debug Authentication](#) and [Chapter C9 Non-invasive Debug Authentication](#).

### Accessing the SDER

To access the SDER, software reads or writes the CP15 registers with <opc1> set to 0, <CRn> set to c1, <CRm> set to c1, and <opc2> set to 1. For example:

```
MRC p15, 0, <Rt>, c1, c1, 1 ; Read SDER into Rt
MCR p15, 0, <Rt>, c1, c1, 1 ; Write Rt to SDER
```

### B4.1.132 TCMTR, TCM Type Register, VMSA

The TCMTR characteristics are:

<b>Purpose</b>	The TCMTR provides information about the implementation of the TCM. This register is part of the Identification registers functional group.
<b>Usage constraints</b>	Only accessible from PL1 or higher.
<b>Configurations</b>	If the implementation includes the Security Extensions, this register is Common. In ARMv7: <ul style="list-style-type: none"><li>this register must be implemented</li><li>when the ARMv7 format is used, the meaning of bits[28:0] is IMPLEMENTATION DEFINED</li><li>the ARMv6 format of the register remains a valid usage model</li><li>if no TCMs are implemented the ARMv6 format is used, to indicate zero-sized TCMs.</li></ul>
<b>Attributes</b>	A 32-bit RO register with an IMPLEMENTATION DEFINED value. See also <a href="#">Reset behavior of CP14 and CP15 registers on page B3-1450</a> . <a href="#">Table B3-44 on page B3-1492</a> shows the encodings of all of the registers in the Identification registers functional group.

In the ARMv7 format, the TCMTR bit assignments are:

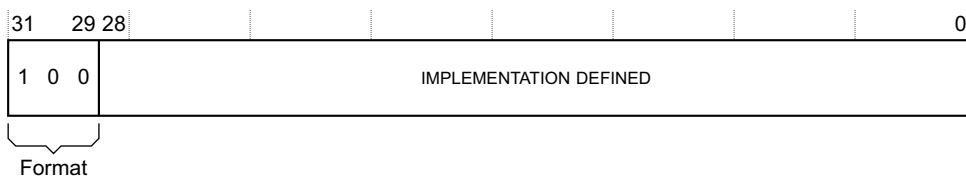

#### Format, bits[31:29]

Indicates the implemented TCMTR format. The possible values of this are:

- 0b000 ARMv6 format, or no TCMs implemented. For more information, see the description of TCMTR in [Appendix L ARMv6 Differences](#).
- 0b100 ARMv7 format.

All other values are reserved.

**Bits[28:0]** IMPLEMENTATION DEFINED in the ARMv7 register format.

If no TCMs are implemented, the TCMTR must be implemented with the ARMv6 format. In this format the TCMTR bit assignments are:

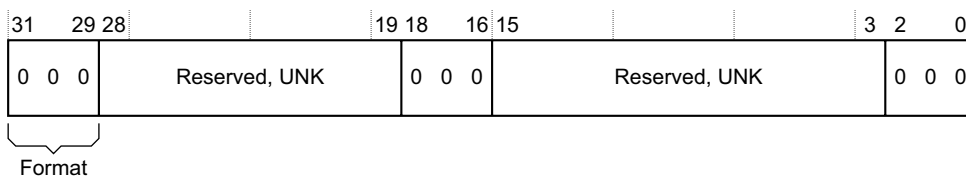

#### Accessing the TCMTR

To access the TCMTR, software reads the CP15 registers with <opc1> set to 0, <CRn> set to c0, <CRm> set to c0, and <opc2> set to 2. For example:

MRC p15, 0, <Rt>, c0, c0, 2 ; Read TCMTR into Rt

### B4.1.133 TEECR, ThumbEE Configuration Register, VMSA

The TEECR characteristics are:

- Purpose** A ThumbEE register. Controls unprivileged access to the [TEEHBR](#).
- Usage constraints** Access rights depend on the execution privilege:
- the result of an unprivileged write to the register is UNDEFINED
  - unprivileged reads, and reads and writes at PL1 or higher, are permitted.
- Configurations** The VMSA and PMSA definitions of the register fields are identical. Implemented in any system that implements the ThumbEE Extension. In an implementation that includes the Security Extensions, TEECR is a Common register.
- Attributes** A 32-bit RW register that resets to zero.  
[Table A2-14 on page A2-95](#) shows the encodings of all of the ThumbEE registers.

The TEECR bit assignments are:

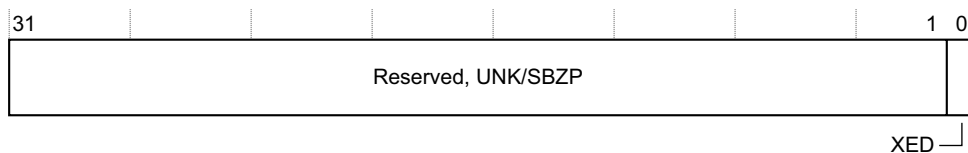

- Bits[31:1]** Reserved, UNK/SBZP.
- XED, bit[0]** Execution Environment Disable bit. Controls unprivileged access to the ThumbEE Handler Base Register:
- 0** Unprivileged access permitted.
  - 1** Unprivileged access disabled.

The effects of a write to this register on ThumbEE configuration are only guaranteed to be visible to subsequent instructions after the execution of a context synchronization operation. However, a read of this register always returns the value most recently written to the register.

———— **Note** —————

See [Context synchronization operation](#) for the definition of this term.

#### Accessing the TEECR

To access the TEECR, read or write the CP14 registers with <opc1> set to 6, <CRn> set to c0, <CRm> set to c0, and <opc2> set to 0. For example:

```
MRC p14, 6, <Rt>, c0, c0, 0 ; Read TEECR into Rt
MCR p14, 6, <Rt>, c0, c0, 0 ; Write Rt to TEECR
```

### B4.1.134 TEEHBR, ThumbEE Handler Base Register, VMSA

The TEEHBR characteristics are:

- Purpose** A ThumbEE register. Holds the base address for ThumbEE handlers.
- Usage constraints** Access rights depend on the execution privilege and the value of `TEECR.XED`:
- accesses at PL1 or higher are always permitted
  - when `TEECR.XED` is 0, unprivileged accesses are permitted
  - when `TEECR.XED` is 1, the result of an unprivileged access is UNDEFINED.
- Configurations** The VMSA and PMSA definitions of the register fields are identical. Implemented in any system that implements the ThumbEE Extension. In an implementation that includes the Security Extensions, TEEHBR is a Common register.
- Attributes** A 32-bit RW register with an UNKNOWN reset value. [Table A2-14 on page A2-95](#) shows the encodings of all of the ThumbEE registers.

The TEEHBR bit assignments are:

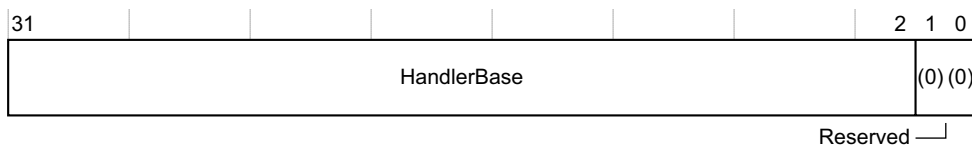

**HandlerBase, bits[31:2]**

The address of the ThumbEE Handler\_00 implementation. This is the address of the first of the ThumbEE handlers.

**Bits[1:0]** Reserved, UNK/SBZP.

The effects of a write to this register on ThumbEE handler entry are only guaranteed to be visible to subsequent instructions after the execution of a context synchronization operation. However, a read of this register always returns the value most recently written to the register.

#### Accessing the TEEHBR

To access the TEEHBR, read or write the CP14 registers with <opc1> set to 6, <CRn> set to c1, <CRm> set to c0, and <opc2> set to 0. For example:

```
MRC p14, 6, <Rt>, c1, c0, 0 ; Read TEEHBR into Rt
MCR p14, 6, <Rt>, c1, c0, 0 ; Write Rt to TEEHBR
```

#### **B4.1.135 TLBIALL, TLB Invalidate All, VMSA only**

*TLB maintenance operations, not in Hyp mode on page B4-1743* describes this TLB maintenance operation.

This operation is part of the TLB maintenance operations functional group. [Table B3-50 on page B3-1497](#) shows the encodings of all of the registers and operations in this functional group.

#### **B4.1.136 TLBIALLH, TLB Invalidate All, Hyp mode, Virtualization Extensions**

*Hyp mode TLB maintenance operations, Virtualization Extensions on page B4-1746* describes this TLB maintenance operation.

This operation is part of the TLB maintenance operations functional group. [Table B3-50 on page B3-1497](#) shows the encodings of all of the registers and operations in this functional group.

#### **B4.1.137 TLBIALLHIS, TLB Invalidate All, Hyp mode, Inner Shareable, Virtualization Extensions**

*Hyp mode TLB maintenance operations, Virtualization Extensions on page B4-1746* describes this TLB maintenance operation.

This operation is part of the TLB maintenance operations functional group. [Table B3-50 on page B3-1497](#) shows the encodings of all of the registers and operations in this functional group.

#### **B4.1.138 TLBIALLIS, TLB Invalidate All, Inner Shareable, VMSA only**

*TLB maintenance operations, not in Hyp mode on page B4-1743* describes this TLB maintenance operation.

This operation is part of the TLB maintenance operations functional group. [Table B3-50 on page B3-1497](#) shows the encodings of all of the registers and operations in this functional group.

#### **B4.1.139 TLBIALLNSNH, TLB Invalidate all Non-secure Non-Hyp, Virtualization Extensions**

*Hyp mode TLB maintenance operations, Virtualization Extensions on page B4-1746* describes this TLB maintenance operation.

This operation is part of the TLB maintenance operations functional group. [Table B3-50 on page B3-1497](#) shows the encodings of all of the registers and operations in this functional group.

#### **B4.1.140 TLBIALLNSNHIS, TLB Invalidate all Non-secure Non-Hyp IS, Virtualization Extensions**

IS indicates Inner Shareable. *Hyp mode TLB maintenance operations, Virtualization Extensions on page B4-1746* describes this TLB maintenance operation.

This operation is part of the TLB maintenance operations functional group. [Table B3-50 on page B3-1497](#) shows the encodings of all of the registers and operations in this functional group.

#### **B4.1.141 TLBIASID, TLB Invalidate by ASID, VMSA only**

*TLB maintenance operations, not in Hyp mode on page B4-1743* describes this TLB maintenance operation.

This operation is part of the TLB maintenance operations functional group. [Table B3-50 on page B3-1497](#) shows the encodings of all of the registers and operations in this functional group.

#### **B4.1.142 TLBIASIDIS, TLB Invalidate by ASID, Inner Shareable, VMSA only**

*TLB maintenance operations, not in Hyp mode on page B4-1743* describes this TLB maintenance operation.

This operation is part of the TLB maintenance operations functional group. [Table B3-50 on page B3-1497](#) shows the encodings of all of the registers and operations in this functional group.



**B4.1.143 TLBIMVA, TLB Invalidate by MVA, VMSA only**

*TLB maintenance operations, not in Hyp mode on page B4-1743* describes this TLB maintenance operation.

This operation is part of the TLB maintenance operations functional group. [Table B3-50 on page B3-1497](#) shows the encodings of all of the registers and operations in this functional group.

**B4.1.144 TLBIMVAA, TLB Invalidate by MVA, all ASIDs, VMSA only**

*TLB maintenance operations, not in Hyp mode on page B4-1743* describes this TLB maintenance operation.

This operation is part of the TLB maintenance operations functional group. [Table B3-50 on page B3-1497](#) shows the encodings of all of the registers and operations in this functional group.

**B4.1.145 TLBIMVAAIS, TLB Invalidate by MVA, all ASIDs, Inner Shareable, VMSA only**

*TLB maintenance operations, not in Hyp mode on page B4-1743* describes this TLB maintenance operation.

This operation is part of the TLB maintenance operations functional group. [Table B3-50 on page B3-1497](#) shows the encodings of all of the registers and operations in this functional group.

**B4.1.146 TLBIMVAH, TLB Invalidate by MVA, Hyp mode, Virtualization Extensions**

*Hyp mode TLB maintenance operations, Virtualization Extensions on page B4-1746* describes this TLB maintenance operation.

This operation is part of the TLB maintenance operations functional group. [Table B3-50 on page B3-1497](#) shows the encodings of all of the registers and operations in this functional group.

**B4.1.147 TLBIMVAHIS, TLB Invalidate by MVA, Hyp mode, Inner Shareable, Virtualization Extensions**

*Hyp mode TLB maintenance operations, Virtualization Extensions on page B4-1746* describes this TLB maintenance operation.

This operation is part of the TLB maintenance operations functional group. [Table B3-50 on page B3-1497](#) shows the encodings of all of the registers and operations in this functional group.

**B4.1.148 TLBIMVAIS, TLB Invalidate by MVA, Inner Shareable, VMSA only**

*TLB maintenance operations, not in Hyp mode on page B4-1743* describes this TLB maintenance operation.

This operation is part of the TLB maintenance operations functional group. [Table B3-50 on page B3-1497](#) shows the encodings of all of the registers and operations in this functional group.

### B4.1.149 TLBTR, TLB Type Register, VMSA

The TLBTR characteristics are:

- Purpose:** The TLBTR provides information about the TLB implementation. The register must define whether the implementation provides separate instruction and data TLBs, or a unified TLB. Normally, the IMPLEMENTATION DEFINED information in this register includes the number of lockable entries in the TLB.  
This register is part of the Identification registers functional group.
- Usage Constraints** Only accessible from PL1 or higher.
- Configurations** This register is only implemented in a VMSA implementation.  
If the implementation includes the Security Extensions, this register is Common.
- Attributes** A 32-bit RO register with an IMPLEMENTATION DEFINED value. See also [Reset behavior of CP14 and CP15 registers on page B3-1450](#).  
[Table B3-44 on page B3-1492](#) shows the encodings of all of the registers in the Identification registers functional group.

The TLBTR bit assignments are:

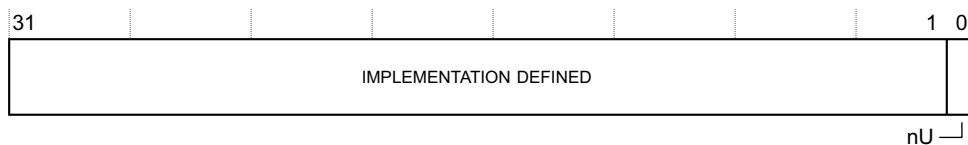

- Bits[31:1]** IMPLEMENTATION DEFINED.
- nU, bit[0]** Not Unified TLB. Indicates whether the implementation has a unified TLB:
  - nU == 0** Unified TLB.
  - nU == 1** Separate Instruction and Data TLBs.

———— **Note** —————

In ARMv7, the TLB lockdown mechanism is IMPLEMENTATION DEFINED, and therefore the details of bits[31:1] of the TLB Type Register are IMPLEMENTATION DEFINED.

#### Accessing the TLBTR

To access the TLBTR, software reads the CP15 registers with <opc1> set to 0, <CRn> set to c0, <CRm> set to c0, and <opc2> set to 3. For example:

```
MRC p15, 0, <Rt>, c0, c0, 3 ; Read TLBTR into Rt
```

### B4.1.150 TPIDRPRW, PL1 only Thread ID Register, VMSA

The TPIDRPRW register characteristics are:

<b>Purpose</b>	The TPIDRPRW provides a location where software executing at PL1 or higher can store thread identifying information that is not visible to software executing at PL0, for OS management purposes. This register is part of the Miscellaneous operations functional group.
<b>Usage constraints</b>	The TPIDRPRW is only accessible from PL1 or higher. Processor hardware never updates this register.
<b>Configurations</b>	Not implemented in architecture versions before ARMv7. In an implementation that includes the Security Extensions, the register is Banked.
<b>Attributes</b>	A 32-bit RW register with an UNKNOWN reset value. See also <a href="#">Reset behavior of CP14 and CP15 registers on page B3-1450</a> . <a href="#">Table B3-52 on page B3-1499</a> shows the encodings of all of the registers in the Miscellaneous operations functional group.

#### Accessing the TPIDRPRW register

To access the TPIDRPRW register, software reads or writes the CP15 registers with <opc1> set to 0, <CRn> set to c13, <CRm> set to c0, and <opc2> set to 4.

For example:

```
MRC p15, 0, <Rt>, c13, c0, 4 ; Read TPIDRPRW into Rt  
MCR p15, 0, <Rt>, c13, c0, 4 ; Write Rt to TPIDRPRW
```

### B4.1.151 TPIDRURO, User Read-Only Thread ID Register, VMSA

The TPIDRURO register characteristics are:

<b>Purpose</b>	The TPIDRURO provides a location where software executing at PL1 or higher can store thread identifying information that is visible to software executing at PL0, for OS management purposes. This register is part of the Miscellaneous operations functional group.
<b>Usage constraints</b>	The TPIDRURO is read-only from software executing at PL0. Processor hardware never updates this register.
<b>Configurations</b>	Not implemented in architecture versions before ARMv7. In an implementation that includes the Security Extensions, the register is Banked.
<b>Attributes</b>	A 32-bit RW register with an UNKNOWN reset value. See also <a href="#">Reset behavior of CP14 and CP15 registers on page B3-1450</a> . <a href="#">Table B3-52 on page B3-1499</a> shows the encodings of all of the registers in the Miscellaneous operations functional group.

#### Accessing the TPIDRURO register

To access the TPIDRURO register, software reads or writes the CP15 registers with <opc1> set to 0, <CRn> set to c13, <CRm> set to c0, and <opc2> set to 3.

For example:

```
MRC p15, 0, <Rt>, c13, c0, 3 ; Read TPIDRURO into Rt  
MCR p15, 0, <Rt>, c13, c0, 3 ; Write Rt to TPIDRURO
```

### B4.1.152 TPIDRURW, User Read/Write Thread ID Register, VMSA

The TPIDRURW register characteristics are:

<b>Purpose</b>	The TPIDRURW provides a location where software executing at PL0 can store thread identifying information, for OS management purposes. This register is part of the Miscellaneous operations functional group.
<b>Usage constraints</b>	No usage constraints. The TPIDRURW is accessible from all privilege levels. Processor hardware never updates this register.
<b>Configurations</b>	Not implemented in architecture versions before ARMv7. In an implementation that includes the Security Extensions, the register is Banked.
<b>Attributes</b>	A 32-bit RW register with an UNKNOWN reset value. See also <a href="#">Reset behavior of CP14 and CP15 registers on page B3-1450</a> . <a href="#">Table B3-52 on page B3-1499</a> shows the encodings of all of the registers in the Miscellaneous operations functional group.

#### Accessing the TPIDRURW register

To access the TPIDRURW register, software reads or writes the CP15 registers with <opc1> set to 0, <CRn> set to c13, <CRm> set to c0, and <opc2> set to 2.

For example:

```
MRC p15, 0, <Rt>, c13, c0, 2 ; Read TPIDRURW into Rt  
MCR p15, 0, <Rt>, c13, c0, 2 ; Write Rt to TPIDRURW
```

## B4.1.153 TTBCR, Translation Table Base Control Register, VMSA

The TTBCR characteristics are:

**Purpose** TTBCR determines which of the Translation Table Base Registers, [TTBR0](#) or [TTBR1](#), defines the base address for a translation table walk required for the stage 1 translation of a memory access from any mode other than Hyp mode.

If the implementation includes the Large Physical Address Extension, the TTBCR also:

- Controls the translation table format.
- When using the Long-descriptor translation table format, holds cacheability and shareability information for the accesses.

———— **Note** —————

When using the Short-descriptor translation table format, [TTBR0](#) and [TTBR1](#) hold this cacheability and shareability information.

This register is part of the Virtual memory control registers functional group.

**Usage constraints** Only accessible from PL1 or higher.

**Configurations** The Large Physical Address Extension adds an alternative format for the register. If an implementation includes the Large Physical Address Extension then the current translation table format determines which format of the register is used.

If the implementation includes the Security Extensions, this register:

- is Banked
- has write access to the Secure copy of the register disabled when the **CP15SDISABLE** signal is asserted HIGH.

**Attributes** A 32-bit RW register that resets to zero. If the implementation includes the Security Extensions this defined reset value applies only to the Secure copy of the register, except for the EAE bit in an implementation that includes the Large Physical Address Extension. For more information see the field descriptions. See also [Reset behavior of CP14 and CP15 registers on page B3-1450](#).

[Table B3-45 on page B3-1493](#) shows the encodings of all of the registers in the Virtual memory control registers functional group.

———— **Note** —————

For other address translations, the following registers are equivalent to the TTBCR and TTBRs:

- for stage 1 translations for accesses from Hyp mode, the [HTCR](#) and [HTTBR](#)
- for stage 2 translations, the [VTBR](#) and [VTTBR](#).

For more information about the use of TTBCR see:

- [Selecting between TTBR0 and TTBR1, Short-descriptor translation table format on page B3-1330](#)
- [Selecting between TTBR0 and TTBR1, Long-descriptor translation table format on page B3-1345](#).

The following sections describe the alternative TTBCR formats:

- [TTBCR format when using the Short-descriptor translation table format on page B4-1722](#)
- [TTBCR format when using the Long-descriptor translation table format on page B4-1723](#).

### TTBCR format when using the Short-descriptor translation table format

In an implementation that includes the Security Extensions and is using the Short-descriptor translation table format, the TTBCR bit assignments are:

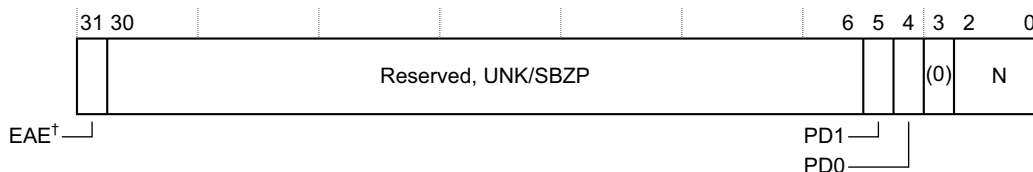

† Reserved, UNK/SBZP, if the implementation does not include the Large Physical Address Extension.

In an implementation that does not include the Security Extensions, and is using the Short-descriptor translation table format, the TTBCR bit assignments are:

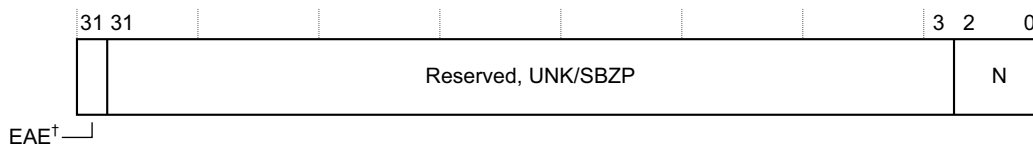

† Reserved, UNK/SBZP, if the implementation does not include the Large Physical Address Extension.

#### EAE, bit[31], if implementation includes the Large Physical Address Extension

Extended Address Enable. The meanings of the possible values of this bit are:

- 0** Use the 32-bit translation system, with the Short-descriptor translation table format. In this case, the format of the TTBCR is as described in this section.
- 1** Use the 40-bit translation system, with the Long-descriptor translation table format. In this case, the format of the TTBCR is as described in [TTBCR format when using the Long-descriptor translation table format on page B4-1723](#).

This bit resets to 0, in both the Secure and the Non-secure copies of the TTBCR.

#### Bit[31], if implementation does not include the Large Physical Address Extension

Reserved, UNK/SBZP.

#### Bits[30:6, 3] Reserved, UNK/SBZP.

#### PD1, bit[5], in an implementation that includes the Security Extensions

Translation table walk disable for translations using [TTBR1](#). This bit controls whether a translation table walk is performed on a TLB miss, for an address that is translated using [TTBR1](#). The encoding of this bit is:

- 0** Perform translation table walks using [TTBR1](#).
- 1** A TLB miss on an address that is translated using [TTBR1](#) generates a Translation fault. No translation table walk is performed.

#### PD0, bit[4], in an implementation that includes the Security Extensions

Translation table walk disable for translations using [TTBR0](#). This bit controls whether a translation table walk is performed on a TLB miss for an address that is translated using [TTBR0](#). The meanings of the possible values of this bit are equivalent to those for the PD1 bit.

#### Bits[5:4], in an implementation that does not include the Security Extensions

Reserved, UNK/SBZP.

**N, bits[2:0]** Indicate the width of the base address held in **TTBR0**. In **TTBR0**, the base address field is bits[31:14-N]. The value of N also determines:

- whether **TTBR0** or **TTBR1** is used as the base address for translation table walks.
- the size of the translation table pointed to by **TTBR0**.

N can take any value from 0 to 7, that is, from 0b000 to 0b111.

When N has its reset value of 0, the translation table base is compatible with ARMv5 and ARMv6.

### TTBCR format when using the Long-descriptor translation table format

When using the Long-descriptor translation table format, the TTBCR bit assignments are:

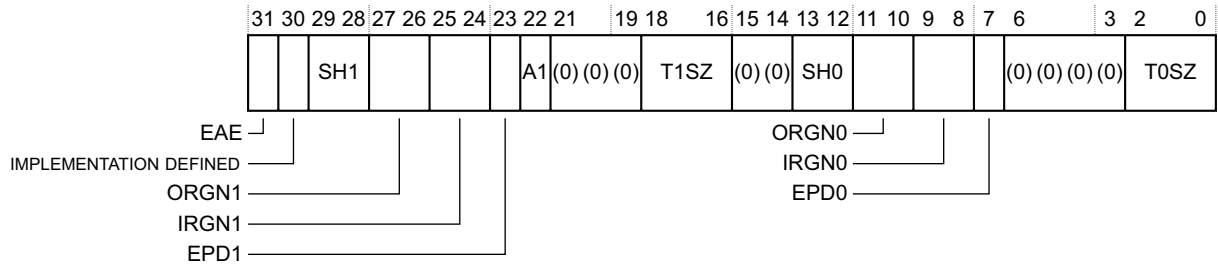

**EAE, bit[31]** Extended Address Enable. The meanings of the possible values of this bit are:

- 0** Use the 32-bit translation system, with the Short-descriptor translation table format. In this case, the format of the TTBCR is as described in *TTBCR format when using the Short-descriptor translation table format on page B4-1722*.
- 1** Use the 40-bit translation system, with the Long-descriptor translation table format. In this case, the format of the TTBCR is as described in this section.

This bit resets to 0, in both the Secure and the Non-secure copies of the TTBCR.

#### IMPLEMENTATION DEFINED, bit[30]

An IMPLEMENTATION DEFINED bit.

#### SH1, bits[29:28]

Shareability attribute for memory associated with translation table walks using **TTBR1**. This field is encoded as described in *Shareability, Long-descriptor format on page B3-1373*.

#### ORGN1, bits[27:26]

Outer cacheability attribute for memory associated with translation table walks using **TTBR1**. [Table B4-30](#) shows the encoding of this field.

**Table B4-30 TTBCR.ORGnx field encoding**

ORGnx	Meaning
00	Normal memory, Outer Non-cacheable
01	Normal memory, Outer Write-Back Write-Allocate Cacheable
10	Normal memory, Outer Write-Through Cacheable
11	Normal memory, Outer Write-Back no Write-Allocate Cacheable

**IRGN1, bits[25:24]**

Inner cacheability attribute for memory associated with translation table walks using [TTBR1](#). [Table B4-31](#) shows the encoding of this field.

**Table B4-31 TTBCR.IRGNx field encoding**

IRGNx	Meaning
00	Normal memory, Inner Non-cacheable
01	Normal memory, Inner Write-Back Write-Allocate Cacheable
10	Normal memory, Inner Write-Through Cacheable
11	Normal memory, Inner Write-Back no Write-Allocate Cacheable

**EPD1, bit[23]** Translation table walk disable for translations using [TTBR1](#). This bit controls whether a translation table walk is performed on a TLB miss, for an address that is translated using [TTBR1](#). The encoding of this bit is:

- 0** Perform translation table walks using [TTBR1](#).
- 1** A TLB miss on an address that is translated using [TTBR1](#) generates a Translation fault. No translation table walk is performed.

———— **Note** —————

This bit has the same function as the TTBCR.PD1 bit in the TTBCR format described in [TTBCR format when using the Short-descriptor translation table format on page B4-1722](#).

**A1, bit[22]** Selects whether [TTBR0](#) or [TTBR1](#) defines the ASID. The encoding of this bit is:

- 0** [TTBR0](#).ASID defines the ASID.
- 1** [TTBR1](#).ASID defines the ASID.

**Bits[21:19]** Reserved, UNK/SBZP.

**T1SZ, bits[18:16]**

The size offset of the memory region addressed by [TTBR1](#). This field is encoded as a three-bit unsigned integer, and the region size is  $2^{(32-T1SZ)}$  bytes.

[Defining the translation table base address width on page B4-1729](#) describes how the value of this field determines the width of the translation table base address defined by [TTBR1](#).

**Bits[15:14]** Reserved, UNK/SBZP.

**SH0, bits[13:12]**

Shareability attribute for memory associated with translation table walks using [TTBR0](#). [Shareability, Long-descriptor format on page B3-1373](#) defines the encoding of this field.

**ORGN0, bits[11:10]**

Outer cacheability attribute for memory associated with translation table walks using [TTBR0](#). [Table B4-30 on page B4-1723](#) shows the encoding of this field.

**IRGN0, bits[9:8]**

Inner cacheability attribute for memory associated with translation table walks using [TTBR0](#). [Table B4-31](#) shows the encoding of this field.



**EPD0, bit[7]** Translation table walk disable for translations using [TTBR0](#). This bit controls whether a translation table walk is performed on a TLB miss, for an address that is translated using [TTBR0](#). The meanings of the possible values of this bit are equivalent to those for the EPD1 bit

———— **Note** —————

This bit has the same function as the TTBCR.PD0 bit in the TTBCR format described in [TTBCR format when using the Short-descriptor translation table format on page B4-1722](#).

**Bits[6:3]** Reserved, UNK/SBZP.

**T0SZ, bits[2:0]**

The size offset of the memory region addressed by [TTBR0](#). This field is encoded as a three-bit unsigned integer, and the region size is  $2^{(32-T0SZ)}$  bytes.

[Defining the translation table base address width on page B4-1729](#) describes how the value of this field determines the width of the translation table base address defined by [TTBR1](#).

### Accessing TTBCR

To access TTBCR, software reads or writes the CP15 registers with <opc1> set to 0, <CRn> set to c2, <CRm> set to c0, and <opc2> set to 2. For example:

```
MRC p15, 0, <Rt>, c2, c0, 2 ; Read TTBCR into Rt  
MCR p15, 0, <Rt>, c2, c0, 2 ; Write RT to TTBCR
```



In an implementation that includes the Multiprocessing Extensions, the 32-bit TTBR0 bit assignments are:

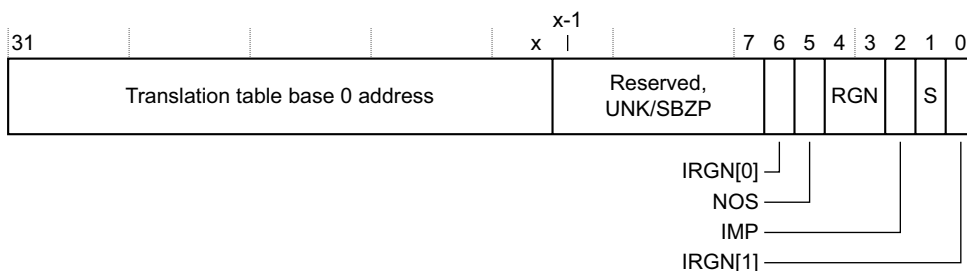

In these assignments, x is  $(14 - (\text{TTBCR.N}))$ .

**Bits[31:x]** Translation table base 0 address, bits[31:x].  
 The value of x determines the required alignment of the translation table, which must be aligned to  $2^x$  bytes.

**Bits[x-1:6], ARMv7-A without Multiprocessing Extensions**

Reserved, UNK/SBZP.

**Bits[x-1:7], in an implementation that includes the Multiprocessing Extensions**

Reserved, UNK/SBZP.

**IRGN[0], bit[6], in an implementation that includes the Multiprocessing Extensions**

See the description of bit[0] for an implementation that includes the Multiprocessing Extensions.

**NOS, bit[5]** Not Outer Shareable bit. Indicates the Outer Shareable attribute for the memory associated with a translation table walk that has the Shareable attribute, indicated by  $\text{TTBR0.S} == 1$ :

- 0 Outer Shareable
- 1 Inner Shareable.

This bit is ignored when  $\text{TTBR0.S} == 0$ .

ARMv7 introduces this bit. If an implementation does not distinguish between Inner Shareable and Outer Shareable, this bit is UNK/SBZP.

**RGN, bits[4:3]**

Region bits. Indicates the Outer cacheability attributes for the memory associated with the translation table walks:

- 0b00 Normal memory, Outer Non-cacheable.
- 0b01 Normal memory, Outer Write-Back Write-Allocate Cacheable.
- 0b10 Normal memory, Outer Write-Through Cacheable.
- 0b11 Normal memory, Outer Write-Back no Write-Allocate Cacheable.

**IMP, bit[2]** The effect of this bit is IMPLEMENTATION DEFINED. If the translation table implementation does not include any IMPLEMENTATION DEFINED features this bit is UNK/SBZP.

**S, bit[1]** Shareable bit. Indicates the Shareable attribute for the memory associated with the translation table walks:

- 0 Non-shareable
- 1 Shareable.

**C, bit[0], ARMv7-A without Multiprocessing Extensions**

Cacheable bit. Indicates whether the translation table walk is to Inner Cacheable memory.

- 0 Inner Non-cacheable
- 1 Inner Cacheable.

For regions marked as Inner Cacheable, it is IMPLEMENTATION DEFINED whether the read has the Write-Through, Write-Back no Write-Allocate, or Write-Back Write-Allocate attribute.

**IRGN, bits[6, 0], in an implementation that includes the Multiprocessing Extensions**

Inner region bits. Indicates the Inner Cacheability attributes for the memory associated with the translation table walks. The possible values of IRGN[1:0] are:

- 0b00 Normal memory, Inner Non-cacheable.
- 0b01 Normal memory, Inner Write-Back Write-Allocate Cacheable.
- 0b10 Normal memory, Inner Write-Through Cacheable.
- 0b11 Normal memory, Inner Write-Back no Write-Allocate Cacheable.

———— **Note** ————

The encoding of the IRGN bits is counter-intuitive, with register bit[6] being IRGN[0] and register bit[0] being IRGN[1]. This encoding is chosen to give a consistent encoding of memory region types and to ensure that software written for the ARMv7 architecture without the Multiprocessing Extensions can run unmodified on an implementation that includes the Multiprocessing Extensions.

**64-bit TTBR0 and TTBR1 format**

The bit assignments for the 64-bit implementations of TTBR0 and TTBR1 are identical, and are:

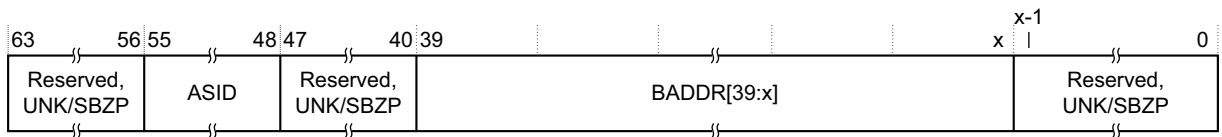

*Defining the translation table base address width on page B4-1729* defines how x is derived from the **TTBCR.T0SZ** or **TTBCR.T1SZ** field value.

———— **Note** ————

The value of x for TTBR0 is independent of its value for TTBR1.

**Bits[63:56]** Reserved, UNK/SBZP.

**ASID, bits[55:48]**

An ASID for the translation table base address. The **TTBCR.A1** field selects either TTBR0.ASID or TTBR1.ASID.

**Bits[47:40]** Reserved, UNK/SBZP.

**BADDR, bits[39:x]**

Translation table base address, bits[39:x]. *Defining the translation table base address width on page B4-1729* describes how x is defined.

The value of x determines the required alignment of the translation table, which must be aligned to 2<sup>x</sup> bytes.

**Bits[x-1:0]** Reserved, UNK/SBZP.

### Defining the translation table base address width

The value of *x* in the descriptions of the bit assignments of the 64-bit TTBR formats defines the width of the translation table base address. When using the 64-bit TTBR0 and TTBR1 formats:

- the **TTBCR.T0SZ** field determines the *x* value for TTBR0
- the **TTBCR.T1SZ** field determines the *x* value for TTBR1.

If *TxSZ* indicates either the T0SZ or the T1SZ field, the following pseudocode calculates the value of *x* for the corresponding TTBR:

```
TxSize = UInt(TTBCR.TxSZ);
if TxSize > 1 then
    x = 14 - TxSize;
else
    x = 5 - TxSize;
```

### Accessing TTBR0

To access TTBR0 in an implementation that does not include the Large Physical Address Extension, or bits[31:0] of TTBR0 in an implementation that includes the Large Physical Address Extension, software reads or writes the CP15 registers with <opc1> set to 0, <CRn> set to c2, <CRm> set to c0, and <opc2> set to 0. For example:

```
MRC p15, 0, <Rt>, c2, c0, 0 ; Read 32-bit TTBR0 into Rt
MCR p15, 0, <Rt>, c2, c0, 0 ; Write Rt to 32-bit TTBR0
```

In an implementation that includes the Large Physical Address Extension, to access all 64 bits of TTBR0, software performs a 64-bit read or write of the CP15 registers with <CRm> set to c2 and <opc1> set to 0. For example:

```
MRRC p15, 0, <Rt>, <Rt2>, c2 ; Read 64-bit TTBR0 into Rt (low word) and Rt2 (high word)
MCRR p15, 0, <Rt>, <Rt2>, c2 ; Write Rt (low word) and Rt2 (high word) to 64-bit TTBR0
```

In these MRRC and MCRR instructions, *Rt* holds the least-significant word of TTBR0, and *Rt2* holds the most-significant word.

### B4.1.155 TTBR1, Translation Table Base Register 1, VMSA

The TTBR1 characteristics are:

- Purpose** [TTBR1](#) holds the base address of translation table 1, and information about the memory it occupies. This is one of the translation tables for the stage 1 translation of memory accesses from modes other than Hyp mode.
- This register is part of the Virtual memory control registers functional group.
- Usage constraints** Only accessible from PL1 or higher.
- Used in conjunction with the [TTBCR](#). When the 64-bit TTBR1 format is used, cacheability and shareability information is held in the [TTBCR](#), not in TTBR1.
- Configurations** The Multiprocessing Extensions change the [TTBR0](#) 32-bit register format.
- The Large Physical Address Extension extends TTBR1 to a 64-bit register. In an implementation that includes the Large Physical Address Extension, [TTBCR.EAE](#) determines which TTBR1 format is used:
- EAE==0** 32-bit format is used. TTBR1[63:32] are ignored.
- EAE==1** 64-bit format is used.
- If the implementation includes the Security Extensions, this register is Banked.
- Attributes** A 32-bit or 64-bit RW register with a reset value that depends on the register implementation. For more information see the register bit descriptions. See also [Reset behavior of CP14 and CP15 registers on page B3-1450](#).
- [Table B3-45 on page B3-1493](#) shows the encodings of all of the registers in the Virtual memory control registers functional group.

The 64-bit format of TTBR1 is identical to the corresponding format for [TTBR0](#), see [64-bit TTBR0 and TTBR1 format on page B4-1728](#).

The following subsection describes the 32-bit TTBR1 formats.

See [TTBCR, Translation Table Base Control Register, VMSA on page B4-1721](#) for more information about using this register.

———— **Note** —————

See [TTBCR, Translation Table Base Control Register, VMSA on page B4-1721](#) for a summary of the registers that define the translation tables for other address translations.

#### 32-bit TTBR1 format

In an implementation that does not include the Multiprocessing Extensions, the 32-bit TTBR1 bit assignments are:

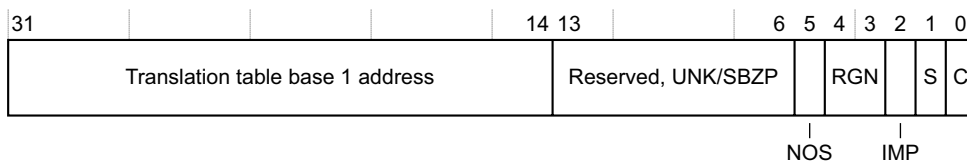



## B4.1.156 VBAR, Vector Base Address Register, Security Extensions

The VBAR characteristics are:

<b>Purpose</b>	When high exception vectors are not selected, the VBAR holds the exception base address for exceptions that are not taken to Monitor mode or to Hyp mode, see <a href="#">Exception vectors and the exception base address on page B1-1164</a> . This register is part of the Security Extensions registers functional group.
<b>Usage constraints</b>	Only accessible from PL1 or higher. Software must program the Non-secure copy of the register with the required initial value as part of the processor boot sequence.
<b>Configurations</b>	A Banked register that is only present in an implementation that includes the Security Extensions. Has write access to the Secure copy of the register disabled when the <b>CP15SDISABLE</b> signal is asserted HIGH.
<b>Attributes</b>	A 32-bit RW. The Secure copy of the register resets to zero. See also <a href="#">Reset behavior of CP14 and CP15 registers on page B3-1450</a> . <a href="#">Table B3-54 on page B3-1500</a> shows the encoding of all of the Security Extensions registers.

The VBAR bit assignments are:

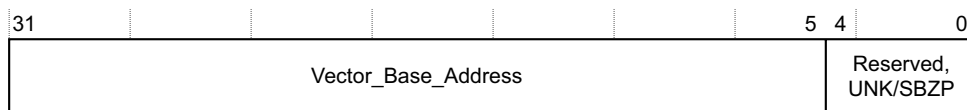

The Secure copy of the VBAR holds the vector base address for Secure state, described as the Secure exception base address

The Non-secure copy of the VBAR holds the vector base address for Non-secure state, described as the Non-secure exception base address.

### Vector\_Base\_Address, bits[31:5]

Bits[31:5] of the base address of the low exception vectors. Bits[4:0] of an exception vector is the exception offset, see [Table B1-3 on page B1-1166](#).

**Bits[4:0]** Reserved, UNK/SBZP.

For details of how the VBAR registers determine the exception addresses see [Exception vectors and the exception base address on page B1-1164](#).

### ————— Note —————

The high exception vectors always have the base address 0xFFFF0000 and are not affected by the value of VBAR.

## Accessing the VBAR

To access the VBAR, software reads or writes the CP15 registers with <opc1> set to 0, <CRn> set to c12, <CRm> set to c0, and <opc2> set to 0. For example:

```
MRC p15, 0, <Rt>, c12, c0, 0 ; Read VBAR into Rt
MCR p15, 0, <Rt>, c12, c0, 0 ; Write Rt to VBAR
```



### B4.1.157 VMPIDR, Virtualization Multiprocessor ID Register, Virtualization Extensions

The VMPIDR characteristics are:

- Purpose** The VMPIDR holds the value of the Virtualization Multiprocessor ID. A Non-secure read of the [MPIDR](#) from PL1 returns the value of this register.  
This register is part of the Virtualization Extensions registers functional group.
- Usage constraints** Only accessible from Hyp mode, or from Monitor mode when [SCR.NS](#) is set to 1, see [PL2-mode system control registers on page B3-1454](#).
- Configurations** Implemented only as part of the Virtualization Extensions.  
This is Banked PL2-mode register, see [Banked PL2-mode CP15 read/write registers on page B3-1454](#).
- Attributes** A 32-bit RW register that resets to the value of the [MPIDR](#). See also [Reset behavior of CP14 and CP15 registers on page B3-1450](#).  
[Table B3-55 on page B3-1501](#) shows the encoding of all of the Virtualization Extensions registers.

The VMPIDR bit assignments are:

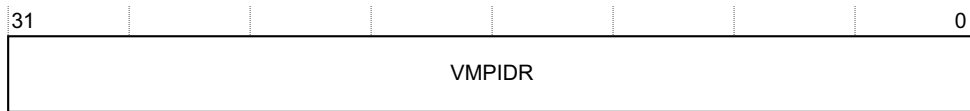

#### VMPIDR, bits[31:0]

[MPIDR](#) value returned by Non-secure PL1 reads of the [MPIDR](#). The [MPIDR](#) description defines the subdivision of this value. Fields that are UNK in the [MPIDR](#) are UNK/SBZP in the VMPIDR.

#### Accessing the VMPIDR

To access the VMPIDR, software reads or writes the CP15 registers with <opc1> set to 4, <CRn> set to c0, <CRm> set to c0, and <opc2> set to 5. For example:

```
MRC p15, 4, <Rt>, c0, c0, 5 ; Read VMPIDR into Rt  
MCR p15, 4, <Rt>, c0, c0, 5 ; Write Rt to VMPIDR
```

### B4.1.158 VPIDR, Virtualization Processor ID Register, Virtualization Extensions

The VPIDR characteristics are:

- Purpose** The VPIDR holds the value of the Virtualization Processor ID. A Non-secure read of the [MIDR](#) from PL1 returns the value of this register.  
 This register is part of the Virtualization Extensions registers functional group.
- Usage constraints** Only accessible from Hyp mode, or from Monitor mode when [SCR.NS](#) is set to 1, see [PL2-mode system control registers on page B3-1454](#).
- Configurations** Implemented only as part of the Virtualization Extensions.  
 This is Banked PL2-mode register, see [Banked PL2-mode CP15 read/write registers on page B3-1454](#).
- Attributes** A 32-bit RW register that resets to the value of the [MIDR](#). See also [Reset behavior of CP14 and CP15 registers on page B3-1450](#).  
[Table B3-55 on page B3-1501](#) shows the encoding of all of the Virtualization Extensions registers.

The VPIDR bit assignments are:

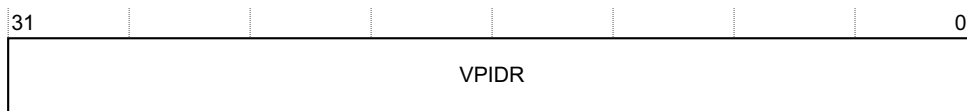

#### VPIDR, bits[31:0]

[MIDR](#) value returned by Non-secure PL1 reads of the [MIDR](#). The [MIDR](#) description defines the subdivision of this value.

#### Accessing the VPIDR

To access the VPIDR, software reads or writes the CP15 registers with <opc1> set to 4, <CRn> set to c0, <CRm> set to c0, and <opc2> set to 0. For example:

```
MRC p15, 4, <Rt>, c0, c0, 0 ; Read VPIDR into Rt
MCR p15, 4, <Rt>, c0, c0, 0 ; Write Rt to VPIDR
```

### B4.1.159 VTCR, Virtualization Translation Control Register, Virtualization Extensions

The VTCR characteristics are:

- Purpose** The VTCR controls the translation table walks required for the stage 2 translation of memory accesses from Non-secure modes other than Hyp mode, and holds cacheability and shareability information for the accesses.  
 This register is part of the Virtualization Extensions registers functional group.
- Usage constraints** Only accessible from Hyp mode, or from Monitor mode when [SCR.NS](#) is set to 1, see [PL2-mode system control registers on page B3-1454](#).  
 Used in conjunction with [VTTBR](#), that defines the translation table base address for the translations.
- Configurations** Implemented only as part of the Virtualization Extensions.  
 This is Banked PL2-mode register, see [Banked PL2-mode CP15 read/write registers on page B3-1454](#).
- Attributes** A 32-bit RW register with an UNKNOWN reset value. See also [Reset behavior of CP14 and CP15 registers on page B3-1450](#).  
[Table B3-55 on page B3-1501](#) shows the encoding of all of the Virtualization Extensions registers.

———— **Note** —————

For other address translations, the following registers are equivalent to the VTCR and [VTTBR](#):

- for stage 1 translations for accesses from modes other than Hyp mode, the [TTBCR](#), [TTBR0](#), and [TTBR1](#)
- for stage 1 translations for accesses from Hyp mode, the [HTCR](#) and [HTTBR](#).

The VTCR bit assignments are:

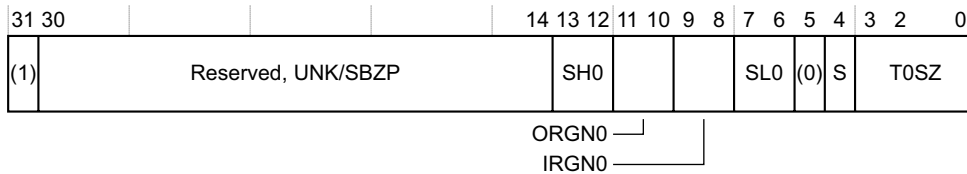

**Bit[31]** Reserved, UNK/SBOP.

**Bits[30:14]** Reserved, UNK/SBZP.

**SH0, bits[13:12]**

Shareability attribute for memory associated with translation table walks using [VTTBR](#). This field is encoded as described in [Shareability, Long-descriptor format on page B3-1373](#).

**ORGNO, bits[11:10]**

Outer cacheability attribute for memory associated with translation table walks using [VTTBR](#). [Table B4-32](#) shows the encoding of this field.

**Table B4-32 VTCR.ORGNO field encoding**

ORGNO	Meaning
00	Normal memory, Outer Non-cacheable
01	Normal memory, Outer Write-Back Write-Allocate Cacheable

**Table B4-32 VTCR.ORGNO field encoding (continued)**

ORGNO	Meaning
10	Normal memory, Outer Write-Through Cacheable
11	Normal memory, Outer Write-Back no Write-Allocate Cacheable

**IRGN0, bits[9:8]**

Inner cacheability attribute for memory associated with translation table walks using [VTTBR](#). [Table B4-33](#) shows the encoding of this field.

**Table B4-33 VTCR.IRGN0 field encoding**

IRGN0	Meaning
00	Normal memory, Inner Non-cacheable
01	Normal memory, Inner Write-Back Write-Allocate Cacheable
10	Normal memory, Inner Write-Through Cacheable
11	Normal memory, Inner Write-Back no Write-Allocate Cacheable

**SL0, bits[7:6]**

Starting level for translation table walks using [VTTBR](#). [Table B4-34](#) shows the encoding of this field.

**Table B4-34 VTCR.SL0 field encoding**

SL0	Meaning
00	Start at second level
01	Start at first level
10, 11	Reserved, UNPREDICTABLE

Behavior is UNPREDICTABLE if the programming of this field is not consistent with the programming of T0SZ. For more information, see the T0SZ description.

**Bit[5]** Reserved, UNK/SBZP.

**S, bit[4]** Sign extension bit. This bit must be programmed to the value of T0SZ[3], otherwise behavior is UNPREDICTABLE.

**T0SZ, bits[3:0]**

The size offset of the memory region addressed by [VTTBR](#). This field is encoded as a four-bit signed integer, and the region size is  $2^{(32-T0SZ)}$  bytes.

[Determining the required first lookup level for stage 2 translations on page B3-1352](#) describes the constraints on programming the SL0 and T0SZ fields. Behavior is UNPREDICTABLE if these constraints are not followed. See the description of the [VTTBR](#) for more information about how the values of the T0SZ and SL0 fields together determine the width of the translation table base address defined by the [VTTBR](#).

## **Accessing the VTCR**

To access the VTCR, software reads or writes the CP15 registers with <opc1> set to 4, <CRn> set to c2, <CRm> set to c1, and <opc2> set to 2. For example:

```
MRC p15, 4, <Rt>, c2, c1, 2 ; Read VTCR into Rt  
MCR p15, 4, <Rt>, c2, c1, 2 ; Write Rt to VTCR
```

## B4.1.160 VTTBR, Virtualization Translation Table Base Register, Virtualization Extensions

The VTTBR characteristics are:

**Purpose** The VTTBR holds the base address of the translation table for the stage 2 translation of memory accesses from Non-secure modes other than Hyp mode.

———— **Note** ————

These translations are always defined using Long-descriptor format translation tables.

This register is part of the Virtualization Extensions registers functional group.

**Usage constraints** Only accessible from Hyp mode, or from Monitor mode when `SCR.NS` is set to 1, see [PL2-mode system control registers](#) on page B3-1454.

Used in conjunction with the [VTCR](#).

**Configurations** Implemented only as part of the Virtualization Extensions.  
 This is a Banked PL2-mode register, see [Banked PL2-mode CP15 read/write registers](#) on page B3-1454.

**Attributes** A 64-bit RW register. See the field descriptions for information about the reset value. See also [Reset behavior of CP14 and CP15 registers](#) on page B3-1450.

[Table B3-55 on page B3-1501](#) shows the encoding of all of the Virtualization Extensions registers.

———— **Note** ————

See [VTCR, Virtualization Translation Control Register, Virtualization Extensions](#) on page B4-1735 for a summary of the registers that define the translation tables for other address translations.

The VTTBR bit assignments are:

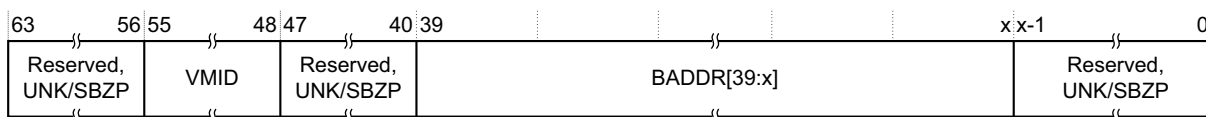

**Bits[63:56]** Reserved, UNK/SBZP.

**VMID, bits[55:48]**

The VMID for the translation table.  
 The reset value of this field is zero.

**Bits[47:40]** Reserved, UNK/SBZP.

**BADDR, bits[39:x]**

Translation table base address, bits[39:x]. See the text in this section for a description of how x is defined.  
 The value of x determines the required alignment of the translation table, which must be aligned to  $2^x$  bytes.

**Bits[x-1:0]** Reserved, UNK/SBZP.

The [VTCR.T0SZ](#) and [VTCR.SL0](#) fields determines the width of the defined translation table base address, indicated by the value of x in the VTTBR description. The following pseudocode calculates the value of x:

```
T0Size = SInt(VTCR.T0SZ);
if VTCR.SL0 == '00' then
    x = 14 - T0Size;
else
    x = 5 - T0Size;
```

## **Accessing the VTTBR**

To access VTTBR, software performs a 64-bit read or write of the CP15 registers with <CRm> set to c2 and <opc1> set to 6. For example:

```
MRRC p15, 6, <Rt>, <Rt2>, c2 ; Read 64-bit VTTBR to Rt (low word) and Rt2 (high word)
MCRR p15, 6, <Rt>, <Rt2>, c2 ; Write Rt (low word) and Rt2 (high word) to 64-bit VTTBR
```

In these MRRC and MCRR instructions, Rt holds the least-significant word of VTTBR, and Rt2 holds the most-significant word.

## B4.2 VMSA system control operations described by function

This section describes the system control operations that are available in a VMSA implementation and that are described as part of a functional group. Architecturally-defined operations have an entry, under the operation name, in *VMSA System control registers descriptions, in register order* on page B4-1522, that references the appropriate functional description in this section.

This section contains the following subsections:

- *Cache and branch predictor maintenance operations, VMSA*
- *TLB maintenance operations, not in Hyp mode* on page B4-1743
- *Hyp mode TLB maintenance operations, Virtualization Extensions* on page B4-1746
- *Performing address translation operations* on page B4-1747
- *Data and instruction barrier operations, VMSA* on page B4-1749
- *Cache and TCM lockdown registers, VMSA* on page B4-1750
- *IMPLEMENTATION DEFINED TLB control operations, VMSA* on page B4-1750
- *DMA support, VMSA* on page B4-1751.

### B4.2.1 Cache and branch predictor maintenance operations, VMSA

This section describes the cache and branch predictor maintenance operations. These are:

- 32-bit write-only operations
- can be executed only by software executing at PL1 or higher.

Table B3-49 on page B3-1496 shows the encodings for these operations.

For more information about the terms used in this section see *Terms used in describing the maintenance operations* on page B2-1274.

#### ————— Note —————

- The architecture includes branch predictor operations with cache maintenance operations because they operate in a similar way.
- ARMv7 introduces significant changes in the CP15 c7 operations. Most of these changes are because ARMv7 introduces support for multiple levels of cache. This section only describes the ARMv7 requirements for these operations. For details of these operations in previous versions of the architecture see:
  - *CP15 c7, Cache and branch predictor operations* on page AppxL-2531 for ARMv6
  - *CP15 c7, Cache and branch predictor operations* on page AppxO-2628 for ARMv4 and ARMv5.

The Multiprocessing Extensions change the set of caches affected by these operations, see *Scope of cache and branch predictor maintenance operations* on page B2-1280.

See *The interaction of cache lockdown with cache maintenance operations* on page B2-1287 for information about the interaction of these maintenance operations with cache lockdown.

Table B4-35 on page B4-1741 lists these operations. For the entries in the table:

- The *Rt data* column specifies what data is required in the register *Rt* specified by the MCR instruction that performs the operation, see *Data formats for the cache and branch predictor operations* on page B4-1741.
- *Terms used in describing the maintenance operations* on page B2-1274 describes *Modified Virtual Address* (MVA), *point of coherency* (PoC) and *point of unification* (PoU).



**Table B4-35 CP15 c7 cache and branch predictor maintenance operations, VMSA**

Operation	Type	Description	Rt data
ICIALLUIS	WO	Invalidate all instruction caches Inner Shareable to PoU. If branch predictors are architecturally-visible, also flushes branch predictors. <sup>a</sup>	Ignored
BPIALLIS	WO	Invalidate all entries from branch predictors Inner Shareable.	Ignored
ICIALLU	WO	Invalidate all instruction caches to PoU. If branch predictors are architecturally-visible, also flushes branch predictors. <sup>a</sup>	Ignored
ICIMVAU	WO	Invalidate instruction cache line by MVA to PoU. <sup>a</sup>	MVA
BPIALL	WO	Invalidate all entries from branch predictors.	Ignored
BPIMVA	WO	Invalidate MVA from branch predictors.	MVA
DCIMVAC	WO	Invalidate data or unified cache line by MVA to PoC.	MVA
DCISW	WO	Invalidate data or unified cache line by set/way.	Set/way
DCCMVAC	WO	Clean data or unified cache line by MVA to PoC.	MVA
DCCSW	WO	Clean data or unified cache line by set/way.	Set/way
DCCMVAU	WO	Clean data or unified cache line by MVA to PoU.	MVA
DCCIMVAC	WO	Clean and Invalidate data or unified cache line by MVA to PoC.	MVA
DCCISW	WO	Clean and Invalidate data or unified cache line by set/way.	Set/way

a. Only applies to separate instruction caches, does not apply to unified caches.

Branch predictor maintenance operations can perform a NOP if the operation of Branch Prediction hardware is not architecturally-visible.

### Data formats for the cache and branch predictor operations

Table B4-35 shows three possibilities for the data in the register Rt specified by the MCR instruction. These are described in the following subsections:

- *Ignored*
- *MVA*
- *Set/way* on page B4-1742.

#### **Ignored**

The value in the register specified by the MCR instruction is ignored. Software does not have to write a value to the register before issuing the MCR instruction.

#### **MVA**

For more information about the possible meaning when the table shows that an MVA is required see *Terms used in describing the maintenance operations* on page B2-1274. When the data is stated to be an MVA, it does not have to be cache line aligned.



## B4.2.2 TLB maintenance operations, not in Hyp mode

This section describes the TLB operations that are implemented on all ARMv7-A implementations. These:

- are 32-bit write-only operations
- can be executed only by software executing at PL1 or higher.

Table B3-50 on page B3-1497 shows the encodings for these operations.

———— **Note** —————

The Multiprocessing Extensions introduce the [TLBIALLIS](#), [TLBIMVAIS](#), [TLBIASIDIS](#), [TLBIMVAAIS](#), and [TLBIMVAA](#) operations. Therefore, these are not available on earlier ARMv7 implementations.

If an implementation includes the Virtualization Extensions, those extensions define the additional TLB maintenance operations described in *Hyp mode TLB maintenance operations, Virtualization Extensions* on page B4-1746.

These TLB maintenance functions:

- are write-only operations
- can be executed only in by software executing at PL1 or higher.

Table B4-36 shows these TLB maintenance operations. For these operations:

- on an implementation with separate data and instruction TLBs, any unified TLB operation operates on both TLBs
- on an implementation with a unified TLB, any instruction TLB operation, and any data TLB operation, operates on the unified TLB
- ARM deprecates use of instruction TLB operations and data TLB operations, and recommends that software always uses the unified TLB operations.

**Table B4-36 CP15 c8 TLB maintenance operations, without Virtualization Extensions**

Name	Description	Rt data <sup>a</sup>
<a href="#">TLBIALLIS</a> <sup>b</sup>	Invalidate entire unified TLB Inner Shareable	Ignored
<a href="#">TLBIMVAIS</a> <sup>b</sup>	Invalidate unified TLB entry by MVA and ASID, Inner Shareable	MVA
<a href="#">TLBIASIDIS</a> <sup>b</sup>	Invalidate unified TLB by ASID match Inner Shareable	ASID
<a href="#">TLBIMVAAIS</a> <sup>b</sup>	Invalidate unified TLB entry by MVA all ASID Inner Shareable	MVA
<a href="#">ITLBIALL</a> <sup>c</sup>	Invalidate entire instruction TLB	Ignored
<a href="#">ITLBIMVA</a> <sup>c</sup>	Invalidate instruction TLB entry by MVA and ASID	MVA
<a href="#">ITLBIASID</a> <sup>c</sup>	Invalidate instruction TLB by ASID match	ASID
<a href="#">DTLBIALL</a> <sup>c</sup>	Invalidate entire data TLB	Ignored
<a href="#">DTLBIMVA</a> <sup>c</sup>	Invalidate data TLB entry by MVA and ASID	MVA
<a href="#">DTLBIASID</a> <sup>c</sup>	Invalidate data TLB by ASID match	ASID
<a href="#">TLBIALL</a> <sup>d</sup>	Invalidate entire unified TLB	Ignore
<a href="#">TLBIMVA</a> <sup>d</sup>	Invalidate unified TLB entry by MVA and ASID	MVA

**Table B4-36 CP15 c8 TLB maintenance operations, without Virtualization Extensions (continued)**

Name	Description	Rt data <sup>a</sup>
TLBIASID <sup>d</sup>	Invalidate unified TLB by ASID match	ASID
TLBIMVAA <sup>b</sup>	Invalidate unified TLB entries by MVA all ASID	MVA

- a. See *TLB operations and associated Rt data formats* for definitions of these formats.
- b. Introduced in the Multiprocessing Extensions.
- c. Deprecated. ARM deprecates use of operations that operate only on an Instruction TLB, or only on a Data TLB.
- d. These mnemonics have changed. TLBIALL was previously UTLBIALL, TLBIMVA was previously UTLBIMVA, and TLBIASID was previously UTLBIMASID.

### About the TLB maintenance operations

For more information about TLBs and their maintenance see *Translation Lookaside Buffers (TLBs)* on page B3-1378, and in particular *TLB maintenance requirements* on page B3-1381.

For more information about the Inner Shareable operations see *Multiprocessor effects on TLB maintenance operations* on page B3-1388.

For information about the effect of these operations on locked TLB entries see *The interaction of TLB lockdown with TLB maintenance operations* on page B3-1382.

As stated in the footnotes to [Table B4-36 on page B4-1743](#):

- If an Instruction TLB or Data TLB operation is used on a system that implements a Unified TLB then the operation is performed on the Unified TLB
- If a Unified TLB operation is used on a system that implements separate Instruction and Data TLBs then the operation is performed on both the Instruction TLB and the Data TLB.
- The mnemonics for the operations to invalidate a unified TLB that are defined for an ARMv7 implementation that does not include the Multiprocessing Extensions were previously UTLBIALL, UTLBIMVA, and UTLBIASID. These remain synonyms for these operations, but ARM deprecates the use of the older names. These are the operations with CRm==c7, opc2=={0, 1, 2}.

For information about the synchronization of the TLB maintenance operations see *TLB maintenance operations and the memory order model* on page B3-1383.

### TLB operations and associated Rt data formats

The following subsections give more information about the different TLB operations and the associated Rt data formats shown in [Table B4-36 on page B4-1743](#).

#### Invalidate entire TLB

The Invalidate entire TLB operations invalidate all unlocked entries in the TLB. The operation ignores the value in the register Rt specified by the MCR instruction that performs the operation. Software does not have to write a value to the register before issuing the MCR instruction.

#### Invalidate single TLB entry by MVA and ASID

The Invalidate single entry operations invalidate a TLB entry that matches the MVA and ASID values provided as an argument to the operation. The required register format is:



With global entries in the TLB, the supplied ASID value is not checked.

**Invalidate TLB entries by ASID match**

The Invalidate on ASID match operations invalidate all TLB entries for non-global pages that match the ASID value provided as an argument to the operation. The required register format is:

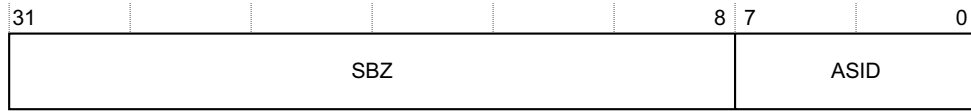

**Invalidate TLB entries by MVA all ASID**

The Invalidate TLB entries by MVA all ASID operations invalidate all unlocked TLB entries that match the MVA provided as an argument to the operation regardless of the ASID. The required register format is:

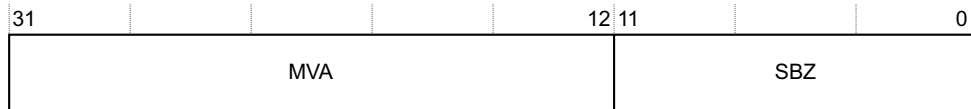

**Accessing the CP15 c8 TLB maintenance operations**

To perform one of the TLB maintenance operations, software writes to the CP15 registers with <opc1>==0, <CRn>==c8, and <CRm> and <opc2> set to the values shown in [Table B4-36 on page B4-1743](#). That is:

MCR p15, 0, <Rt>, c8, <CRm>, <opc2>

For example:

MCR p15, 0, <Rt>, c8, c5, 0 ; ITLBIALL, Instruction TLB invalidate all. Operation ignores Rt value.  
 MCR p15, 0, <Rt>, c8, c6, 2 ; DTLBIASID, Data TLB invalidate by ASID

### B4.2.3 Hyp mode TLB maintenance operations, Virtualization Extensions

The Virtualization Extensions add additional TLB maintenance operations, for use in Hyp mode.

These Hyp mode TLB maintenance operations:

- are write-only operations
- can be executed only in Hyp mode, or in Monitor mode
- are UNDEFINED if executed in any Non-secure mode other than Hyp mode
- are UNPREDICTABLE if executed in any Secure PL1 mode other than Monitor mode.

Table B4-37 summarizes the Hyp mode TLB maintenance operations. Table B3-56 on page B3-1502 shows the encodings for these operations.

**Table B4-37 CP15 c8 Hyp mode TLB maintenance operations, opc1==4**

Name	Description	Rt data <sup>a</sup>
TLBIALLHIS	Invalidate entire Hyp unified TLB Inner Shareable	Ignored
TLBIMVAHIS	Invalidate Hyp unified TLB entry by MVA Inner Shareable	MVA
TLBIALLNSNHIS	Invalidate entire Non-secure Non-Hyp unified TLB Inner Shareable	Ignored
TLBIALLH	Invalidate entire Hyp unified TLB	Ignore
TLBIMVAH	Invalidate Hyp unified TLB entry by MVA	MVA
TLBIALLNSNH	Invalidate entire Non-secure Non-Hyp unified TLB	Ignored

a. See *Hyp mode TLB operations and associated Rt data formats* for definitions of these formats. The MVA format differs from that used for the operations by MVA and ASID shown in Table B4-36 on page B4-1743.

#### About the Hyp mode TLB maintenance operations

For more information about TLBs and their maintenance see *Translation Lookaside Buffers (TLBs)* on page B3-1378, and in particular *TLB maintenance requirements* on page B3-1381.

All of these operations are defined as operating on unified TLBs. In a system that implements separate data and instruction TLBs they operate on both TLBs.

Operations defined as operating on Hyp TLB entries apply to Non-secure TLB entries associated with software execution in Hyp mode. Operations defined as operating on non-Hyp TLB entries apply to TLB entries, for all VMIDs, associated with software execution in any Non-secure mode other than Hyp mode.

For more information about the Inner Shareable operations see *Multiprocessor effects on TLB maintenance operations* on page B3-1388.

For information about the effect of these operations on locked TLB entries see *The interaction of TLB lockdown with TLB maintenance operations* on page B3-1382.

For information about the synchronization of the TLB maintenance operations see *TLB maintenance operations and the memory order model* on page B3-1383.

#### Hyp mode TLB operations and associated Rt data formats

The following subsections give more information about the different Hyp mode TLB operations and the associated Rt data formats shown in Table B4-37.

##### **Invalidate entire TLB**

The Invalidate entire TLB operations invalidate all unlocked entries in the specified TLB. These operations ignore the value in the register Rt specified by the MCR instruction that performs the operation. Software does not have to write a value to the register before issuing the MCR instruction.

### Invalidate single TLB entry by MVA

The Invalidate single entry operations invalidate a TLB entry that matches the MVA value provided as an argument to the operation. The required register format is:

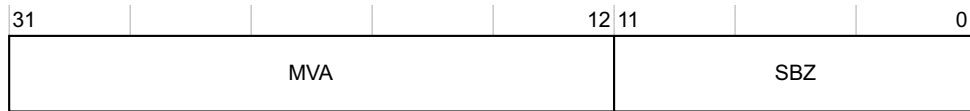

### Accessing the CP15 c8 Hyp mode TLB maintenance operations

To perform one of the TLB maintenance operations, software writes to the CP15 registers with <opc1> == 4, <CRn>==c8, and <CRm> and <opc2> set to the values shown in [Table B4-36 on page B4-1743](#). That is:

MCR p15, 4, <Rt>, c8, <CRm>, <opc2>

For example:

MCR p15, 4, <Rt>, c8, c3, 1 ; TLBIMVAHIS, Invalidate Hyp TLB by MVA value given in Rt, Inner Shareable  
 MCR p15, 4, <Rt>, c8, c7, 0 ; TLBIALLH, Invalidate entire Hyp TLB, operation ignores the Rt value

## B4.2.4 Performing address translation operations

As summarized in [Address translation operations, functional group on page B3-1498](#), the system control registers include a register and a set of operations that a processor can use to perform the address translation, either from VA to PA or from VA to IPA, that the MMU would perform for a memory access. This set of CP15 c7 registers comprises:

- A single Physical Address Register, [PAR](#), that returns the result of the required address translation. Depending on the implementation, and on the translation performed, this register can be a 32-bit register or a 64-bit registers.
- A set of address translation operations:

**ATS1C\*\*** Stage 1 current state operations:

- [ATS1CPR](#), Stage 1 current state PL1 read.
- [ATS1CPW](#), Stage 1 current state PL1 write.
- [ATS1CUR](#), Stage 1 current state unprivileged (PL0) read.
- [ATS1CUW](#), Stage 1 current state unprivileged (PL0) write.

In an implementation that includes the Virtualization Extensions, in Non-secure state, these operations return the result of a VA to IPA translation. Otherwise, they return the result of a VA to PA translation.

**ATS12NSO\*\***

Stages 1 and 2 Non-secure only operations:

- [ATS12NSOPR](#), Stages 1 and 2 Non-secure PL1 read.
- [ATS12NSOPW](#), Stages 1 and 2 Non-secure PL1 write.
- [ATS12NSOUR](#), Stages 1 and 2 Non-secure unprivileged (PL0) read.
- [ATS12NSOUW](#), Stages 1 and 2 Non-secure unprivileged (PL0) write.

These operations always return the result of a VA to PA translation.

**ATS1H\*** Stage 1 Hyp mode operations:

- [ATS1HR](#), Stage 1 Hyp mode read.
- [ATS1HW](#), Stage 1 Hyp mode write.

These operations always return the result of a VA to PA translation.

The available translations depend on whether the implementation includes:

- The Security Extensions. The ATS12NSO\*\* operations are part of the Security Extensions.
- The Virtualization Extensions. ATS12HW\* operations are part of the Virtualization Extensions.

Any VMSAv7 implementation includes the ATS1C\*\* operations.

- The address translation operations are:
  - 32-bit write-only operations.
  - For the ATS1C\*\* operations, accessible only at PL1 or higher.
  - For the ATS12NSO\*\* operations, accessible only in Secure PL1 modes and in Non-secure Hyp mode.

———— **Note** ————

ARM deprecates using these operations from any Secure PL1 mode other than Monitor mode.

- For the ATS1H\* operations, accessible only in Secure Monitor mode and in Non-secure Hyp mode.

Table B3-51 on page B3-1498 summarizes the PAR and the translation operations, and shows their encodings.

For more information about these operations, see *Virtual Address to Physical Address translation operations* on page B3-1438.

Software performs an address translation by writing to one of the operations shown in Table B3-51 on page B3-1498. If successful, the operation returns a PA in the PAR, otherwise the PAR returns fault information.

### Accessing the PAR and the address translation operations

To access one of the address translation operations, software writes to the CP15 registers with <CRn> set to c7, <CRm> set to c8, and <opc1> and <opc2> set to the values shown in Table B3-51 on page B3-1498.

With register Rt containing the original VA this gives:

MCR p15, <opc1>, <Rt>, c7, c8, <opc2> ; Address translation operation, as defined by <opc1> and <opc2>

To read the 32-bit PAR, software reads the CP15 registers with <opc1> set to 0, <CRn> set to c7, <CRm> set to c4, and <opc2> set to 0. This means that, to return the translated PA in register Rt, it uses:

MRC p15, 0, <Rt>, c7, c4, 0 ; Read 32-bit PAR into Rt

To read the 64-bit PAR, software performs a 64-bit read of the CP15 registers with <opc1> set to 0 and <CRm> set to c7. This means that, to return the least-significant word of the PAR to register Rt, and the most-significant word to register Rt2, it uses:

MRRC p15, 0, <Rt>, <Rt2>, c7 ; Read 64-bit PAR into Rt (low word) and Rt2 (high word)

———— **Note** ————

When the PAR is a 64-bit register, 32-bit accesses to the PAR, using MRC or MCR instructions, access the least-significant word of the PAR.

The PAR is a read/write register, and software can perform a CP15 register write, using the same encodings, to write to the register. No translation operation requires writing to this register, but the write operation might be required to restore the PAR value after a context switch.

An example of an address translation on a processor that does not implement the Security Extensions is:

MCR p15, 0, <Rt>, c7, c8, 2 ; ATS1CUR operation on address supplied in Rt, Stage 1 unprivileged read  
ISB ; Ensure completion of the MCR write to CP15  
MRC p15, 0, <Rt>, c7, c4, 0 ; Read result from 32-bit PAR into Rt

An example of an address translation on a processor that implements the Security Extensions and is in the Secure state is:

MCR p15, 0, <Rt>, c7, c8, 5 ; ATS12NSOPW operation on address supplied in Rt, Stage 1 and 2 PL1 write  
ISB ; Performs VA to PA translation for Non-secure security state  
ISB ; Ensure completion of the MCR write to CP15  
MRC p15, 0, <Rt>, c7, c4, 0 ; Read result from 32-bit PAR into Rt



An example of an address translation on a processor that implements the Virtualization Extensions and is in Hyp mode is:

```
MCR p15, 4, <Rt>, c7, c8, 1 ; ATS1HW operation on address supplied in Rt, Stage 1 Hyp mode write
                               ; Performs VA to PA translation for Hyp mode memory access
ISB                            ; Ensure completion of the MCR write to CP15
MRRC p15, 0, <Rt>, <Rt2>, c7 ; Read result from 64-bit PAR into Rt (low word) and Rt2 (high word)
```

### Address translation operations when the MMU is disabled

The address translation operations can be performed even when the MMU is disabled. The operations then report the flat address mapping and the MMU-disabled value of the attributes and permissions for the data side accesses. In a processor that is using the Short-descriptor translation table formats:

- these include any MMU-disabled re-mapping specified by the TEX remap facilities
- the SuperSection bit is 0 when the MMU is disabled.

For more information about the address and attributes returned when the MMU is disabled see [The effects of disabling MMUs on VMSA behavior on page B3-1314](#).

In an implementation that includes the Security Extensions, this information applies when the MMU is disabled in the security state for which the address translation is performed. In this case, if the implementation includes the Large Physical Address Extension and the stage 1 MMU is disabled, `TTBCR.EAE` determines the `PAR` format used to return the result of the address translation operation.

## B4.2.5 Data and instruction barrier operations, VMSA

ARMv6 includes two CP15 c7 operations to perform data barrier operations, and another operation to perform an instruction barrier operation. In ARMv7:

- The ARM and Thumb instruction sets include instructions to perform the barrier operations, that can be executed at any level of privilege, see [Memory barriers on page A3-150](#).
- The CP15 c7 operations are defined as write-only operations, that can be executed at any level of privilege. [Table B3-52 on page B3-1499](#) shows the encodings for these operations, and the following sections describe them:
  - [CP15ISB, Instruction Synchronization Barrier operation on page B4-1750](#)
  - [CP15DSB, Data Synchronization Barrier operation on page B4-1750](#)
  - [CP15DMB, Data Memory Barrier operation on page B4-1750](#)

The MCR instruction that performs a barrier operation specifies a register, `Rt`, as an argument. However, the operation ignores the value of this register, and software does not have to write a value to the register before issuing the MCR instruction.

In ARMv7, ARM deprecates any use of these CP15 c7 operations, and strongly recommends that software uses the ISB, DSB, and DMB instructions instead.

#### Note

- In ARMv6 and earlier documentation, the Instruction Synchronization Barrier operation is referred to as a Prefetch Flush (PFF).
- In versions of the ARM architecture before ARMv6 the Data Synchronization Barrier operation is described as a *Data Write Barrier* (DWB).

If the implementation supports the `SCTLR.CP15BEN` bit and this bit is set to 0, these operations are disabled and their encodings are UNDEFINED. For more information see [SCTLR, System Control Register, VMSA on page B4-1705](#).

### CP15ISB, Instruction Synchronization Barrier operation

In ARMv7, the ISB instruction performs an Instruction Synchronization Barrier, see [ISB on page A8-389](#).

The deprecated CP15 c7 encoding for an Instruction Synchronization Barrier is an MCR instruction with <opc1> set to 0, <CRn> set to c7, <CRm> set to c5, and <opc2> set to 4.

### CP15DSB, Data Synchronization Barrier operation

In ARMv7, the DSB instruction performs a Data Synchronization Barrier, see [DSB on page A8-380](#).

The deprecated CP15 c7 encoding for a Data Synchronization Barrier is an MCR instruction with <opc1> set to 0, <CRn> set to c7, <CRm> set to c10, and <opc2> set to 4. This operation performs the full system barrier performed by the DSB instruction.

### CP15DMB, Data Memory Barrier operation

In ARMv7, the DMB instruction performs a Data Memory Barrier, see [DMB on page A8-378](#).

The deprecated CP15 c7 encoding for a Data Memory Barrier is an MCR instruction with <opc1> set to 0, <CRn> set to c7, <CRm> set to c10, and <opc2> set to 5. This operation performs the full system barrier performed by the DMB instruction.

## B4.2.6 Cache and TCM lockdown registers, VMSA

Some CP15 c9 encodings are reserved for IMPLEMENTATION DEFINED memory system functions, in particular:

- cache control, including lockdown
- TCM control, including lockdown
- branch predictor control.

The reserved encodings support implementations that are compatible with previous versions of the ARM architecture, in particular with the ARMv6 requirements. For details of the ARMv6 implementation see [CP15 c9, Cache lockdown support on page AppxL-2537](#).

In ARMv6, CP15 c9 provides cache lockdown functions. With the ARMv7 abstraction of the hierarchical memory model, for CP15 c9, all encodings with CRm = {c0-c2, c5-c8} are reserved for IMPLEMENTATION DEFINED cache, branch predictor and TCM operations.

The naming and behavior of registers or operations defined in these regions is IMPLEMENTATION DEFINED.

#### ———— Note —————

In an ARMv6 implementation that implements the Security Extensions, a Cache Behavior Override Register is required in CP15 c9, with CRm = 8, see [CP15 c9, Cache Behavior Override Register, CBOR on page AppxL-2541](#). This register is not architecturally-defined in ARMv7, and therefore the CP15 c9 encoding with CRm = 8 is IMPLEMENTATION DEFINED. However, an ARMv7 implementation can include the CBOR, in which case ARM recommends that this encoding is used for it.

## B4.2.7 IMPLEMENTATION DEFINED TLB control operations, VMSA

In VMSAv6, CP15 c10 provides TLB lockdown functions. In VMSAv7, the TLB lockdown mechanism is IMPLEMENTATION DEFINED and some CP15 c10 encodings are reserved for IMPLEMENTATION DEFINED TLB control operations. These are the encodings with <CRn> == c10, <opc1> == 0, <CRm> == {c0, c1, c4, c8}, and <opc2> == {0-7}.

## B4.2.8 DMA support, VMSA

Some CP15 c11 encodings are reserved for IMPLEMENTATION DEFINED registers or operations to provide DMA support. The reserved encodings are those 32-bit CP15 accesses with CRn==c11, opc1=={0-7}, CRm=={c0-c8, c15}, opc2=={0-7}.

All other CP15 c11 encodings are UNPREDICTABLE, see [Accesses to unallocated CP14 and CP15 encodings on page B3-1447](#).

The reserved encodings permit implementations that are compatible with previous versions of the ARM architecture, in particular with the ARMv6 implementations of DMA support for TCMs described in *The ARM Architecture Reference Manual* (DDI 0100). As stated in [Appendix L ARMv6 Differences](#), ARM considers this support to be an IMPLEMENTATION DEFINED feature of those ARMv6 implementations.

The naming and behavior of registers or operations defined in these encoding regions is IMPLEMENTATION DEFINED.



# Chapter B5

## Protected Memory System Architecture (PMSA)

This chapter provides a system level view of the memory system. It contains the following sections:

- *About the PMSA* on page B5-1754
- *Memory access control* on page B5-1759
- *Memory region attributes* on page B5-1760
- *PMSA memory aborts* on page B5-1763
- *Exception reporting in a PMSA implementation* on page B5-1767
- *About the system control registers for PMSA* on page B5-1772
- *Organization of the CP14 registers in a PMSA implementation* on page B5-1784
- *Organization of the CP15 registers in a PMSA implementation* on page B5-1785
- *Functional grouping of PMSAv7 system control registers* on page B5-1797
- *Pseudocode details of PMSA memory system operations* on page B5-1804.

---

**Note**

For an ARMv7-R implementation, this chapter must be read with [Chapter B2 Common Memory System Architecture Features](#).

---

## B5.1 About the PMSA

The PMSA is based on a *Memory Protection Unit* (MPU). The PMSA provides a much simpler memory protection scheme than the MMU based VMSA described in [Chapter B3 Virtual Memory System Architecture \(VMSA\)](#). The simplification applies to both the hardware and the software. A PMSAv7 processor is identified by the presence of the MPU Type Register, see [MPUIR, MPU Type Register, PMSA on page B6-1897](#).

The main simplification is that the MPU does not use translation tables. Instead, System Control Coprocessor (CP15) registers define *protection regions*. The protection regions eliminate the need for:

- hardware to perform translation table walks
- software to set up and maintain the translation tables.

The use of protection regions has the benefit of making the memory checking fully deterministic. However, the level of control is region based rather than page based, meaning the control is considerably less fine-grained than in the VMSA.

A second simplification is that the PMSA does not support virtual to physical address mapping other than flat address mapping. The physical memory address accessed is the same as the virtual address generated by the processor.

### B5.1.1 Protection regions

In a PMSA implementation, software uses CP15 registers to define protection regions in the physical memory map. When describing a PMSA implementation, protection regions are often referred to as regions.

This means the PMSA has the following features:

- For each defined region, CP15 registers specify:
  - the region size
  - the base address
  - the memory attributes, for example, memory type and access permissions.Regions of 256 bytes or larger can be split into 8 subregions for improved granularity of memory access control.  
The minimum region size supported is IMPLEMENTATION DEFINED.
- Memory region control, requiring read and write access to the region configuration registers, is possible only from PL1.
- Regions can overlap. If an address is defined in multiple regions, a fixed priority scheme defines the properties of the address being accessed. This scheme gives priority to the region with the highest region number.
- The PMSA can be configured so that an access to an address that is not defined in any region either:
  - causes a memory abort
  - if it is an access from PL1, uses the default memory map.
- All addresses are physical addresses, address translation is not supported.
- Instruction and data address spaces can be either:
  - unified, so a single region descriptor applies to both instruction and data accesses
  - separated between different instruction region descriptors and data region descriptors.

When the processor generates a memory access, the MPU compares the memory address with the programmed memory regions:

- If a matching memory region is not found, then:
  - the access can be mapped onto a background region, see [Using the default memory map as a background region on page B5-1756](#)
  - otherwise, a Background fault memory abort is signaled to the processor.

- If a matching memory region is found:
  - The access permission bits determine whether the access is permitted. If the access is not permitted, the MPU signals a Permission fault memory abort. Otherwise, the access proceeds. See [Memory access control on page B5-1759](#) for a description of the access permission bits.
  - The memory region attributes determine the memory type, as described in [Memory region attributes on page B5-1760](#).

### B5.1.2 Subregions

A region of the PMSA memory map can be split into eight equal sized, non-overlapping subregions:

- any region size between 256bytes and 4Gbytes supports 8 subregions
- region sizes below 256 bytes do not support subregions

In the Region Size Register for each region, there is a Subregion disable bit for each subregion. This means that each subregion is either:

- part of the region, if its Subregion disable bit is 0
- not part of the region, if its Subregion disable bit is 1.

If the region size is smaller than 256 bytes then all eight of the Subregion bits are UNK/SBZP.

If a subregion is part of the region then the protection and memory type attributes of the region apply to the subregion. If a subregion is not part of the region then the addresses covered by the subregion do not match as part of the region.

Subregions are not supported in versions of the PMSA before PMSAv7.

### B5.1.3 Overlapping regions

The MPU can be programmed with two or more overlapping regions. When memory regions overlap, a fixed priority scheme determines the region whose attributes are applied to the memory access. The higher the region number the higher the priority. Therefore, for example, in an implementation that supports eight memory regions, the attributes for region 7 have highest priority and those for region 0 have lowest priority.

[Figure B5-1](#) shows a case where the MPU is programmed with overlapping memory regions.

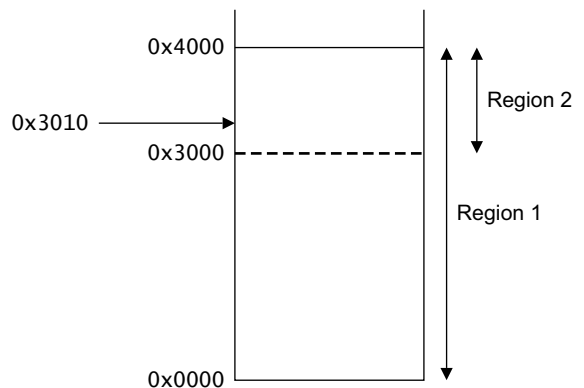

**Figure B5-1 Overlapping memory regions in the MPU**

In this example:

- Data region 2 is programmed to be 4KB in size, starting from address 0x3000 with AP[2:0] == 0b010, giving PL1 modes full access, and User mode read-only access.
- Data region 1 is programmed to be 16KB in size, starting from address 0x0 with AP[2:0] == 0b001, giving access from PL1 modes only.

If the processor performs a data load from address 0x3010 while in User mode, the address is in both region 1 and region 2. Region 2 has the higher priority, therefore the region 2 attributes apply to the access. This means the load does not abort.

#### B5.1.4 The background region

*Background region* refers to a region that matches the entire 4GB physical address map, and has a lower priority than any other region. Therefore, a background region provides the memory attributes for any memory access that does not match any of the defined memory regions.

When the `SCTLR.BR` bit is set to 0, the MPU behaves as if there is a background region that generates a Background fault memory abort on any access. This means that any memory access that does not match any of the programmed memory regions generates a Background fault memory abort. This is the same as the behavior in PMSAv6.

If a system requires a background region with a different set of memory attributes, region 0 can be programmed as a 4GB region with the required attributes. Because region 0 has the lowest priority this region then acts as a background region.

#### Using the default memory map as a background region

The default memory map is defined in *The default memory map on page B5-1757*. Before PMSAv7, the default memory map is used only to define the behavior of memory accesses when the MPU is disabled or not implemented. From PMSAv7, when the `SCTLR.BR` bit is set to 1, and the MPU is present and enabled:

- the default memory map defines the background region for memory accesses from PL1, meaning that a PL1 access that does not match any of the programmed memory regions takes the properties defined for that address in the default memory map
- an unprivileged memory access that does not match any of the defined memory regions generates a Background fault memory abort.

Using the default memory map as the background region means that all of the programmable memory region definitions are available to define protection regions in the 4GB memory address space.

#### B5.1.5 Enabling and disabling the MPU

Software can use the `SCTLR.M` bit to enable and disable the MPU. On reset, this bit is cleared to 0, meaning the MPU is disabled after a reset.

Software must program all relevant CP15 registers before enabling the MPU. This includes at least one of:

- setting up at least one memory region
- setting the `SCTLR.BR` bit to 1, to use the default memory map as a background region, see *Using the default memory map as a background region*.

The considerations described in *Synchronization of changes to system control registers on page B5-1777* apply to any change that enables or disables the MPU or the caches.

#### Behavior when the MPU is disabled

When the MPU is disabled:

- Instruction accesses use the default memory map and attributes shown in *Table B5-1 on page B5-1757*. An access to a memory region with the Execute-never attribute generates a Permission fault, see *The XN (Execute-never) attribute and instruction fetching on page B5-1759*. No other permission checks are performed. Additional control of the cacheability is made by:
  - the `SCTLR.I` bit if separate instruction and data caches are implemented
  - the `SCTLR.C` bit if unified caches are implemented.
- Data accesses use the default memory map and attributes shown in *Table B5-2 on page B5-1757*. No memory access permission checks are performed, and no aborts can be generated.



- Program flow prediction functions as normal, controlled by the value of the [SCTLR.Z](#) bit.
- All of the CP15 cache operations work as normal.
- Speculative instruction and data fetch operations work as normal, based on the default memory map:
  - speculative data fetch operations have no effect if the data cache is disabled
  - speculative instruction fetch operations have no effect if the instruction cache is disabled.
- The Outer memory attributes are the same as those for the Inner memory system.

**The default memory map**

The PMSAv7 default memory map is fixed and not configurable, and is shown in:

- [Table B5-1](#) for the instruction access attributes
- [Table B5-2](#) for the data access attributes.

The regions of the default memory map are identical in both tables. The information about the memory map is split into two tables only to improve the presentation of the information.

**Table B5-1 Default memory map, showing instruction access attributes**

Address range	HIVECS	Instruction memory type		Execute-never, XN
		Caching enabled <sup>a</sup>	Caching disabled <sup>a</sup>	
0xFFFFFFFF-0xF0000000	0	Not applicable	Not applicable	Execute-never
0xFFFFFFFF-0xF0000000	1 <sup>b</sup>	Normal, Non-cacheable	Normal, Non-cacheable	Execution permitted
0xEFFFFFFF-0xC0000000	x	Not applicable	Not applicable	Execute-never
0xBFFFFFFF-0xA0000000	x	Not applicable	Not applicable	Execute-never
0x9FFFFFFF-0x80000000	x	Not applicable	Not applicable	Execute-never
0x7FFFFFFF-0x60000000	x	Normal, Non-shareable, Write-Through Cacheable	Normal, Non-shareable, Non-cacheable	Execution permitted
0x5FFFFFFF-0x40000000	x	Normal, Non-shareable, Write-Through Cacheable	Normal, Non-shareable, Non-cacheable	Execution permitted
0x3FFFFFFF-0x00000000	x	Normal, Non-shareable, Write-Through Cacheable	Normal, Non-shareable, Non-cacheable	Execution permitted

- a. When separate instruction and data caches are implemented, caching is enabled for instruction accesses if the instruction caches are enabled. When unified caches are implemented caching is enabled if the data or unified caches are enabled. See the descriptions of the C and I bits in [SCTLR, System Control Register, PMSA on page B6-1930](#).
- b. ARM deprecates the use of HIVECS == 1 in PMSAv7, see [Exception vectors and the exception base address on page B1-1164](#).

**Table B5-2 Default memory map, showing data access attributes**

Address range	Data memory type	
	Caching enabled <sup>a</sup>	Caching disabled
0xFFFFFFFF - 0xC0000000	Strongly-ordered	Strongly-ordered
0xBFFFFFFF - 0xA0000000	Shareable Device	Shareable Device
0x9FFFFFFF - 0x80000000	Non-shareable Device	Non-shareable Device

**Table B5-2 Default memory map, showing data access attributes (continued)**

Address range	Data memory type	
	Caching enabled <sup>a</sup>	Caching disabled
0x7FFFFFFF - 0x60000000	Normal, Shareable, Non-cacheable	Normal, Shareable, Non-cacheable
0x5FFFFFFF - 0x40000000	Normal, Non-shareable, Write-Through Cacheable	Normal, Shareable, Non-cacheable
0x3FFFFFFF - 0x00000000	Normal, Non-shareable, Write-Back, Write-Allocate Cacheable	Normal, Shareable, Non-cacheable

a. Caching is enabled for data accesses if the data or unified caches are enabled. See the description of the C bit in *SCTLR, System Control Register*; PMSA on page B6-1930.

### Behavior of an implementation that does not include an MPU

If a PMSAv7 implementation does not include an MPU, it must adopt the default memory map behavior described in *Behavior when the MPU is disabled on page B5-1756*.

A PMSAv7 implementation that does not include an MPU is identified by an MPU Type Register entry that shows a Unified MPU with zero Data or Unified regions, see *MPUIR, MPU Type Register*; PMSA on page B6-1897.

#### B5.1.6 Finding the minimum supported region size

Software can use the **DRBAR** to find the minimum region size supported by an implementation, by following this procedure:

1. Write a valid memory region number to the **RGNR**. Normally software uses region number 0, because this is always a valid region number.
2. Write the value 0xFFFFF0 to the **DRBAR**. This value sets all valid bits in the register to 1.
3. Read back the value of the **DRBAR**. In the returned value the least significant bit set indicates the resolution of the selected region. If the least significant bit set is bit M the resolution of the region is  $2^M$  bytes.

If the MPU implements separate data and instruction regions this process gives the minimum size for data regions. To find the minimum size for instruction regions, use the same procedure with the **IRBAR**.

## B5.2 Memory access control

Access to a memory region is controlled by the access permission bits for each region, held in the [DRACR](#) and [IRACR](#).

### B5.2.1 Access permissions

Access permission bits control access to the corresponding memory region. If an access is made to an area of memory without the required permissions, a Permission fault is generated. In the appropriate Region Access Control Register:

- the AP bits determine the access permissions
- the XN bit provides an additional permission bit for instruction fetches.

The access permissions are a three-bit field, [DRACR.AP\[2:0\]](#) or [IRACR.AP\[2:0\]](#). [Table B5-3](#) shows the possible values of this field.

**Table B5-3 Access permissions**

AP[2:0]	PL1 permissions	PL0 permissions	Description
000	No access	No access	All accesses generate a Permission fault
001	Read/Write	No access	All unprivileged accesses generate Permission faults
010	Read/Write	Read-only	User mode write accesses generate Permission faults
011	Read/Write	Read/Write	Full access
100	UNPREDICTABLE	UNPREDICTABLE	Reserved
101	Read-only	No Access	PL1 read-only, all other accesses generate Permission faults
110	Read-only	Read-only	All write accesses generate Permission faults
111	UNPREDICTABLE	UNPREDICTABLE	Reserved

### The XN (Execute-never) attribute and instruction fetching

Each memory region can be tagged as not containing executable code. If the XN bit, the Execute-never bit, is set to 1, any attempt to execute an instruction in that region results in a Permission fault, and the implementation must not access the region to fetch instructions speculatively. If the XN bit is 0, code can execute from that memory region.

———— **Note** —————

The XN bit acts as an additional permission check. The address must also have a valid read access permission.

In ARMv7, all regions of memory that contain read-sensitive peripherals must be marked as XN to avoid the possibility of a speculative fetch accessing the locations.

## B5.3 Memory region attributes

Each memory region has an associated set of memory region attributes. These control the memory type, accesses to the caches, and whether the memory region is Shareable and therefore must be kept coherent. These attributes are encoded in the C, B, TEX[2:0] and S bits of the appropriate Region Access Control Register.

———— **Note** ————

The *Bufferable* (B), *Cacheable* (C), and *Type Extension* (TEX) bit names are inherited from earlier versions of the architecture. These names no longer adequately describe the function of the B, C, and TEX bits.

The following sections give more information:

- [C, B, and TEX\[2:0\] encodings](#)
- [Programming the MPU region attributes on page B5-1761](#)
- [Cache maintenance requirement created by changing MPU region attributes on page B5-1762.](#)

### B5.3.1 C, B, and TEX[2:0] encodings

The TEX[2:0] field must be considered with the C and B bits to give a five bit encoding of the access attributes for an MPU memory region. [Table B5-4](#) shows these encodings.

For Normal memory regions, the S (Shareable) bit gives more information about whether the region is Shareable. A Shareable region can be shared by multiple processors. A Normal memory region is Shareable if the S bit for the region is set to 1. For other memory types, the value of the S bit is ignored.

**Table B5-4 C, B and TEX[2:0] encodings**

TEX[2:0]	C	B	Description	Memory type	Shareable?
000	0	0	Strongly-ordered.	Strongly-ordered	Shareable
000	0	1	Shareable Device.	Device	Shareable
000	1	0	Outer and Inner Write-Through, no Write-Allocate.	Normal	S bit <sup>a</sup>
000	1	1	Outer and Inner Write-Back, no Write-Allocate.	Normal	S bit <sup>a</sup>
001	0	0	Outer and Inner Non-cacheable.	Normal	S bit <sup>a</sup>
001	0	1	Reserved.	-	-
001	1	0	IMPLEMENTATION DEFINED.	IMP. DEF. <sup>b</sup>	IMP. DEF. <sup>b</sup>
001	1	1	Outer and Inner Write-Back, Write-Allocate.	Normal	S bit <sup>a</sup>
010	0	0	Non-shareable Device.	Device	Non-shareable
010	0	1	Reserved.	-	-
010	1	x	Reserved.	-	-
011	x	x	Reserved.	-	-
1BB	A	A	Cacheable memory: AA = Inner attribute <sup>c</sup> BB = Outer policy	Normal	S bit <sup>a</sup>

a. Region is Shareable if S == 1, and Non-shareable if S == 0. See *DRACR, Data Region Access Control Register, PMSA* on page B6-1838 and *IRACR, Instruction Region Access Control Register, PMSA* on page B6-1885.

b. IMP. DEF. = IMPLEMENTATION DEFINED.

c. For more information see [Cacheable memory attributes on page B5-1761](#).

For an explanation of Normal, Strongly-ordered and Device memory types, and the Shareable attribute, see [Memory types and attributes and the memory order model](#) on page A3-125.

### Cacheable memory attributes

When  $TEX[2] == 1$ , the memory region is Cacheable memory, and the rest of the encoding defines the Inner and Outer cache attributes:

- TEX[1:0]** defines the Outer cache attribute
- C, B** defines the Inner cache attribute

The same encoding is used for the Outer and Inner cache attributes. [Table B5-5](#) shows the encoding.

**Table B5-5 Inner and Outer cache attribute encoding**

Memory attribute encoding	Cache attribute
00	Non-cacheable
01	Write-Back, Write-Allocate
10	Write-Through, no Write-Allocate
11	Write-Back, no Write-Allocate

### B5.3.2 Programming the MPU region attributes

When the PMSA is implemented, software uses CP15 registers to configure the MPU memory regions. There are three registers for each memory region supported by the MPU:

- A Base Address Register, that defines the start address of the region in the memory map.
- A Region Size and Enable Register, that:
  - has a single enable bit for the region
  - defines the size of the region
  - has a disable bit for each of the eight subregions in the region.
- A Region Access Control Register that defines the memory attributes for the region.

The multiple copies of these registers map onto three or six registers in CP15 c6, and the MPU Region Number Register, [RGNR](#), selects the current memory region. The mapping of the region registers onto the CP15 registers depends on whether the MPU implements a unified memory map, or separate Instruction and Data memory maps:

#### Separate Instruction and Data memory maps

The multiple copies of the registers that describe each memory region map onto six CP15 registers:

- For the memory regions in the Instruction memory map:
  - the multiple Region Base Address Registers map onto the Instruction Region Base Address Register, [IRBAR](#)
  - the multiple Region Size and Enable Registers map onto the Instruction Region Size and Enable Register, [IRSR](#)
  - the multiple Region Access Control Registers map onto the Instruction Region Access Control Register, [IRACR](#).
- For the memory regions in the Data memory map:
  - the multiple Region Base Address Registers map onto the Data Region Base Address Register, [DRBAR](#)
  - the multiple Region Size and Enable Registers map onto the Data Region Size and Enable Register, [DRSR](#)
  - the multiple Region Access Control Registers map onto the Data Region Access Control Register, [DRACR](#).

The value in the **RGNR** is the index value for both the instruction region and the data region registers. The **RGNR** value indicates the current memory region for both the instruction and the data memory maps. However, a particular value might not be valid for both memory maps.

### Unified memory maps

The multiple copies of the registers that describe each memory region map onto three CP15 registers:

- the multiple Region Base Address Registers map onto the Data Region Base Address Register, **DRBAR**
- the multiple Region Size and Enable Registers map onto the Data Region Size and Enable Register, **DRSR**
- the multiple Region Access Control Registers map onto the Data Region Access Control Register, **DRACR**.

The **IRBAR**, **IRSR**, and **IRACR** are not implemented, and their encodings are reserved.

The value in the **RGNR** is the index value for the data region registers. Its value indicates the current memory region in the unified memory map.

The read-only **MPUIR** indicates:

- whether the MPU implements separate Instruction and Data address maps, or a Unified address map
- the number of Data or Unified regions the MPU supports
- if separate Instruction and Data address maps are implemented, the number of Instruction regions the MPU supports.

Table B5-6 summarizes the register implementations for unified and separate memory maps.

**Table B5-6 Memory region registers**

Register	All implementations	Separate memory maps <sup>a</sup>
Base Address	<b>DRBAR</b>	<b>IRBAR</b>
Size and Enable	<b>DRSR</b>	<b>IRSR</b>
Access Control	<b>DRACR</b>	<b>IRACR</b>

a. These additional registers are implemented only if the MPU implements separate Instruction and Data memory maps.

### B5.3.3 Cache maintenance requirement created by changing MPU region attributes

If a change to the MPU region attributes affects the cacheability attributes of a memory region, including any change between Write-Through and Write-Back attributes, software must ensure that any cached copies of affected locations are removed from the caches, typically by cleaning and invalidating the locations from the levels of cache that might hold copies of the locations affected by the attribute change. Any of the following changes to the inner cacheability or outer cacheability attribute creates this maintenance requirement:

- Write-Back to Write-Through
- Write-Back to Non-cacheable
- Write-Through to Non-cacheable
- Write-Through to Write-Back.

The cache clean and invalidate avoids any possible coherency errors caused by mismatched memory attributes.

Similarly, to avoid possible coherency errors caused by mismatched memory attributes, the following sequence must be followed when changing the shareability attributes of a cacheable memory location:

1. Make the memory location Non-cacheable, Outer Shareable.
2. Clean and invalidate the location from them cache.
3. Change the shareability attributes to the required new values.

## B5.4 PMSA memory aborts

In a PMSAv7 implementation, the following mechanisms cause a processor to take an exception on a failed memory access:

<b>Debug exception</b>	An exception caused by the debug configuration, see <a href="#">About debug exceptions on page C4-2088</a> .
<b>Alignment fault</b>	An Alignment fault is generated if the address used for a memory access does not have the required alignment for the operation. For more information see <a href="#">Unaligned data access on page A3-108</a> and <a href="#">Alignment faults</a> .
<b>MPU fault</b>	The MPU detects an access restriction generates an exception.
<b>External abort</b>	A memory system component other than the MPU signals an illegal or faulting external memory access.

Collectively, these mechanisms are called *aborts*. [Chapter C4 Debug Exceptions](#) describes Debug exceptions, and the remainder of this section describes Alignment faults, MPU faults, and External aborts.

The exception generated on a synchronous memory abort:

- on an instruction fetch is called the Prefetch Abort exception
- on a data access is called the Data Abort exception.

———— **Note** ————

The Prefetch Abort exception applies to any synchronous memory abort on an instruction fetch. It is not restricted to speculative instruction fetches.

In the ARM architecture, asynchronous memory aborts are a type of External abort, and are treated as a special type of Data Abort exception.

The following sections describe the different abort mechanisms:

- [Alignment faults](#)
- [MPU faults on page B5-1764](#)
- [External aborts on page B5-1765](#).

An access that causes an abort is said to be *aborted*, and uses the *Fault Address Registers* (FARs) and *Fault Status Registers* (FSRs) to record context information. The FARs and FSRs are described in [Exception reporting in a PMSA implementation on page B5-1767](#).

### B5.4.1 Alignment faults

The ARMv7 memory architecture requires support for strict alignment checking. This checking is controlled by the SCTLRA bit. [Unaligned data access on page A3-108](#) defines when Alignment faults are generated, for both values of SCTLRA.

Alignment faults can occur when the MPU is disabled.

———— **Note** ————

In some documentation, including issues A and B of this manual, Alignment faults are classified as a type of MPU fault. However, the behavior of Alignment faults differs, in a number of ways, from the behavior of MPU faults. This change in the classification of Alignment faults has no effect on their behavior.

## B5.4.2 MPU faults

The MPU checks the memory accesses required for instruction fetches and for explicit memory accesses:

- if an instruction fetch faults it generates a Prefetch Abort exception
- if an explicit memory access faults it generates a Data Abort exception.

For more information about Prefetch Abort exceptions and Data Abort exceptions see [Exception handling on page B1-1164](#).

MPU faults are always synchronous. For more information, see [Terminology for describing exceptions on page B1-1137](#).

When the MPU generates an abort for a region of memory, no memory access is made if that region is or could be marked as Strongly-ordered or Device.

The following subsections describe the types of fault the MPU can generate:

- [Background fault](#)
- [Permission fault](#).

[The MPU fault checking sequence on page B5-1765](#) describes the fault checking sequence.

### Background fault

If the memory access address does not match one of the programmed MPU memory regions, and the default memory map is not being used, a Background fault memory abort is generated.

Background faults cannot occur on any cache or branch predictor maintenance operation.

### Permission fault

The access permissions, defined in [Memory access control on page B5-1759](#), are checked against the processor memory access. If the access is not permitted, a Permission fault memory abort is generated.

In a PMSA implementation, Permission faults cannot occur on cache or branch predictor maintenance operation.



## The MPU fault checking sequence

Figure B5-2 shows the MPU fault checking sequence, when the MPU is enabled.

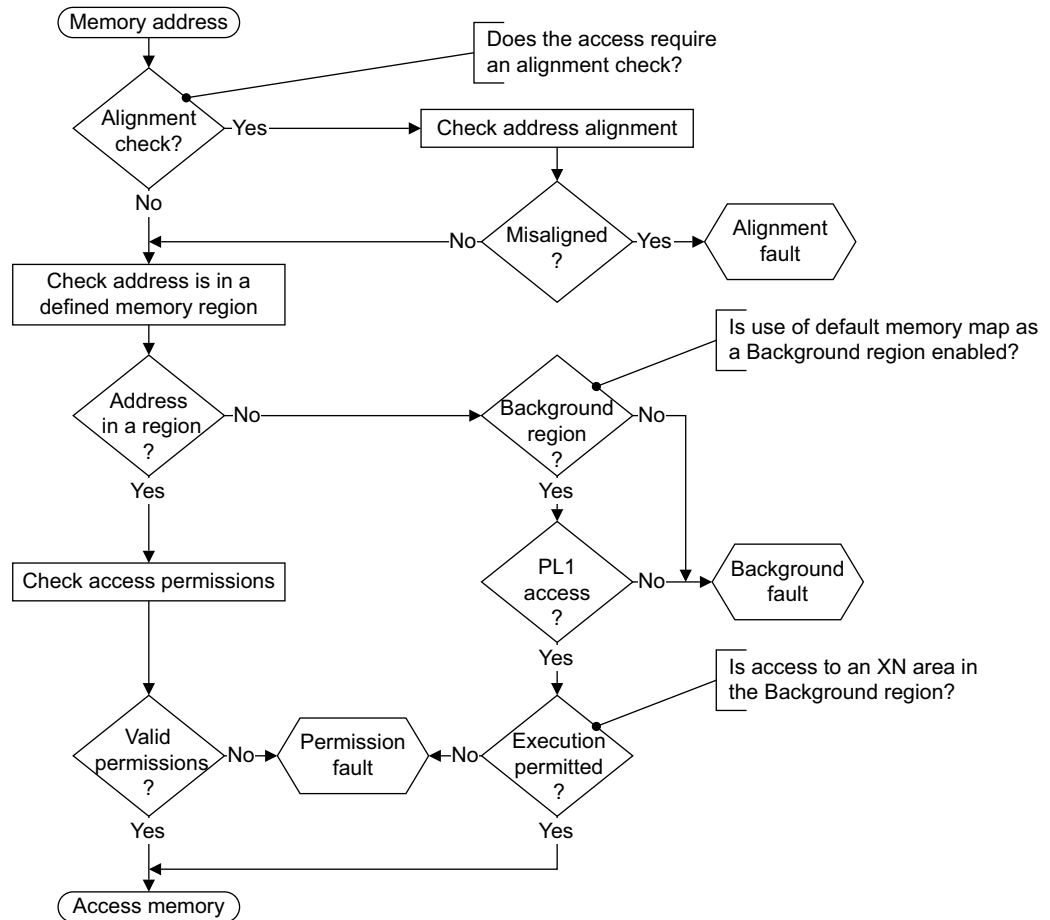

Figure B5-2 MPU fault checking sequence

### B5.4.3 External aborts

External memory errors are defined as errors that occur in the memory system other than those that are detected by the MPU or Debug hardware. They include parity errors detected by the caches or other parts of the memory system. An external abort is one of:

- synchronous
- precise asynchronous
- imprecise asynchronous.

For more information, see [Terminology for describing exceptions](#) on page B1-1137.

The ARM architecture does not provide a method to distinguish between precise asynchronous and imprecise asynchronous aborts.

The ARM architecture handles asynchronous aborts in a similar way to interrupts, except that they are reported to the processor using the Data Abort exception. Setting the `CPSR.A` bit to 1 masks asynchronous aborts, see [Program Status Registers \(PSRs\)](#) on page B1-1147.

Normally, external aborts are rare. An imprecise asynchronous external abort is likely to be fatal to the process that is running. An example of an event that might cause an external abort is an uncorrectable parity or ECC failure on a Level 2 memory structure.

It is IMPLEMENTATION DEFINED which external aborts, if any, are supported.

PMSAv7 permits external aborts on data accesses and instruction fetches to be either synchronous or asynchronous. The [DFSR](#) indicates whether the external abort is synchronous or asynchronous.

———— **Note** —————

Because imprecise asynchronous external aborts are normally fatal to the process that caused them, ARM recommends that implementations make external aborts precise wherever possible.

More information about possible external aborts is given in the subsections:

- [External abort on instruction fetch](#)
- [External abort on data read or write](#)
- [Parity error reporting.](#)

For information about how external aborts are reported see [Exception reporting in a PMSA implementation on page B5-1767](#).

### External abort on instruction fetch

An external abort on an instruction fetch can be either synchronous or asynchronous. A synchronous external abort on an instruction fetch is taken precisely.

An implementation can report the external abort asynchronously from the instruction that it applies to. In such an implementation these aborts behave essentially as interrupts. They are masked by the [CPSR.A](#) bit when it is set to 1, otherwise they are reported using the Data Abort exception.

### External abort on data read or write

Externally generated errors during a data read or write can be either synchronous or asynchronous.

An implementation can report the external abort asynchronously from the instruction that generated the access. In such an implementation these aborts behave essentially as interrupts. They are masked by the [CPSR.A](#) bit when it is set to 1, otherwise they are reported using the Data Abort exception.

### Parity error reporting

The ARM architecture supports the reporting of both synchronous and asynchronous parity errors from the cache systems. It is IMPLEMENTATION DEFINED what parity errors in the cache systems, if any, result in synchronous or asynchronous parity errors.

A fault status code is defined for reporting parity errors, see [Exception reporting in a PMSA implementation on page B5-1767](#). However when parity error reporting is implemented it is IMPLEMENTATION DEFINED whether the assigned fault status code or another appropriate encoding is used for reporting parity errors.

For all purposes other than the fault status encoding, parity errors are treated as external aborts.

## B5.4.4 Prioritization of aborts

The prioritization of synchronous aborts generated by different memory accesses from the same instruction is IMPLEMENTATION DEFINED. In general, the ARM architecture does not define when asynchronous events are taken, and therefore the prioritization of asynchronous events is IMPLEMENTATION DEFINED.

———— **Note** —————

[Debug event prioritization on page C3-2076](#) describes:

- the relationship between debug events, MPU faults, and external aborts. for synchronous aborts generated by the same memory access
- the special requirement that applies to asynchronous watchpoints.

## B5.5 Exception reporting in a PMSA implementation

This section describes the Fault Status and Fault Address registers, and how they report information about PMSA aborts. It contains the following subsections:

- [About the Fault Status and Fault Address registers](#)
- [Data Abort exceptions](#)
- [Prefetch Abort exceptions on page B5-1769](#)
- [Fault Status Register encodings for the PMSA on page B5-1769](#)
- [Provision for classification of external aborts on page B5-1770](#)
- [Auxiliary Fault Status Registers on page B5-1771.](#)

Also, these registers are used for reporting information about debug exceptions. For more information see [Data Abort exceptions](#) and [Prefetch Abort exceptions on page B5-1769](#).

### B5.5.1 About the Fault Status and Fault Address registers

PMSAv7 provides four registers for reporting fault address and status information:

- The *Data Fault Status Register (DFSR)* is updated on taking a Data Abort exception.
- The *Instruction Fault Status Register (IFSR)* is updated on taking a Prefetch Abort exception.
- The *Data Fault Address Register (DFAR)*. In some cases, on taking a synchronous Data Abort exception the DFAR is updated with the faulting address. See [Terminology for describing exceptions on page B1-1137](#) for a description of synchronous exceptions.
- The *Instruction Fault Address Register (IFAR)* is updated with the faulting address on taking a Prefetch Abort exception.

In addition, the architecture provides encodings for two IMPLEMENTATION DEFINED Auxiliary Fault Status Registers, see [Auxiliary Fault Status Registers on page B5-1771](#).

#### ———— Note —————

Before ARMv7, the Data Fault Address Register was called the *Fault Address Register (FAR)*.

On a Watchpoint debug exception, the *Watchpoint Fault Address Register (DBGWFAR)* holds fault information. On a watchpoint access the **DBGWFAR** is updated with the address of the instruction that generated the Data Abort exception.

### B5.5.2 Data Abort exceptions

On taking a Data Abort exception, if the exception is generated by a Watchpoint debug event, then its reporting depends on whether the Watchpoint debug event is synchronous or asynchronous, and on the Debug architecture version. For more information, see [Data Abort exception on a Watchpoint debug event on page B5-1768](#).

Otherwise:

- The **DFSR** is updated with details of the fault, including the appropriate fault status code.  
If the Data Abort exception is synchronous, **DFSR.WnR** is updated to indicate whether the faulted access was a read or a write. However, if the fault is:
  - on a cache maintenance operation, **WnR** is set to 1, to indicate a write access fault
  - generated by an **SWP** or **SWPB** instruction, **WnR** is set to 0 if a read of the location would have generated a fault, otherwise it is set to 1.
- If the Data Abort exception is:
  - synchronous, the **DFAR** is updated with the address that caused the Data Abort exception
  - asynchronous, the **DFAR** becomes UNKNOWN.

On any access that might have multiple aborts, the MPU fault checking sequence and the prioritization of aborts determine which abort occurs. For more information, see [The MPU fault checking sequence on page B5-1765](#) and [Prioritization of aborts on page B5-1766](#).

### Data Abort exception on a Watchpoint debug event

On taking a Data Abort exception caused by a Watchpoint debug event, **DFSR.FS** is updated to indicate a debug event, and **DFSR.WnR** is UNKNOWN.

The remaining register updates depend on the Debug architecture version, and in v7.1 debug, on whether the Watchpoint debug event is synchronous or asynchronous:

#### v7 Debug, and for an asynchronous Watchpoint debug event in v7.1 Debug

- **DFAR** is UNKNOWN
- **DBGWFAR** is set to the VA of the instruction that caused the watchpointed access, plus an offset that depends on the instruction set state of the processor for that instruction, as follows:
  - 8 for ARM state
  - 4 for Thumb or ThumbEE state
  - IMPLEMENTATION DEFINED for Jazelle state.

#### v7.1 Debug, for a synchronous Watchpoint debug event

- **DFAR** is set to the address that generated the watchpoint
- **DBGWFAR** is UNKNOWN.

A watchpointed address can be any byte-aligned address. The address reported in **DFAR** might not be the watchpointed address, and can be any address between and including:

- the lowest address accessed by the instruction that triggered the watchpoint
- the highest watchpointed address accessed by that instruction.

If multiple watchpoints are set in this range, there is no guarantee of which watchpoint is generated.

#### ———— Note —————

In particular, there is no guarantee of generating the watchpoint with the lowest address in the range.

In addition, it is IMPLEMENTATION DEFINED whether there is an additional restriction on the lowest value that might be reported in the **DFAR**, see [Synchronous Watchpoint debug event additional restriction on DFAR or HDFAR reporting, v7.1 Debug on page B3-1412](#).

#### ———— Note —————

For a synchronous Watchpoint debug event:

- in v7 Debug, both **LR\_abt** and **DBGWFAR** indicate the address of the instruction that triggered the watchpoint, and ARM deprecates using **DBGWFAR** to determine the address of this instruction.
- in v7.1 Debug, only **LR\_abt** indicates the address of the instruction that triggered the watchpoint

### B5.5.3 Prefetch Abort exceptions

For a Prefetch Abort exception generated by an instruction fetch, the Prefetch Abort exception is taken synchronously with the instruction that the abort is reported on. This means:

- If the processor attempts to execute the instruction a Prefetch Abort exception is generated.
- If the instruction fetch is issued but the processor does not attempt to execute the instruction, no Prefetch Abort exception is generated for that instruction. For example, if the processor branches round a prefetched instruction no Prefetch Abort exception is generated.

On taking a Prefetch Abort exception:

- The **IFSR** is updated with details of the fault, including the appropriate fault code. If appropriate, the fault code indicates that the exception was generated by a debug exception. See the register description for more information about the returned fault information.
- For a Prefetch Abort exception generated by an instruction fetch, the **IFAR** is updated with the VA that caused the exception.
- For a Prefetch Abort exception generated by a debug exception, the **IFAR** is UNKNOWN.

### B5.5.4 Fault Status Register encodings for the PMSA

For the PMSA fault status encodings in priority order see:

- [Table B5-7](#) for the **IFSR** encodings
- [Table B5-8 on page B5-1770](#) for the **DFSR** encodings.

**Table B5-7 PMSAv7 IFSR encodings**

IFSR[10, 3:0] <sup>a</sup>	Sources	IFAR	Notes
00001	Alignment fault	Valid	-
00000	Background fault	Valid	MPU fault
01101	Permission fault	Valid	MPU fault
00010	Debug event that generates a Prefetch Abort exception	UNKNOWN	See <a href="#">About debug events on page C3-2036</a>
01000	Synchronous external abort	Valid	-
10100	IMPLEMENTATION DEFINED	-	Lockdown
11010	IMPLEMENTATION DEFINED	-	Coprocessor abort
11001	Memory access synchronous parity error	Valid	-

a. All **IFSR**[10, 3:0] values not listed in this table are reserved.

**Table B5-8 PMSAv7 DFSR encodings**

DFSR[10, 3:0] <sup>a</sup>	Sources	DFAR	Notes
00001	Alignment fault	Valid	-
00000	Background fault	Valid	MPU fault
01101	Permission fault	Valid	MPU fault
00010	Synchronous Watchpoint debug event <sup>b</sup>	v7 Debug	UNKNOWN
		v7.1 Debug	Valid
	Asynchronous Watchpoint debug event <sup>b</sup>	UNKNOWN	
01000	Synchronous external abort	Valid	-
10100	IMPLEMENTATION DEFINED	-	Lockdown
11010	IMPLEMENTATION DEFINED	-	Coprocessor abort
11001	Memory access synchronous parity error	<sup>c</sup>	-
10110	Asynchronous external abort	UNKNOWN	-
11000	Memory access asynchronous parity error	UNKNOWN	-

- a. All DFSR[10, 3:0] values not listed in this table are reserved.
- b. These are the only debug events that generate a Data Abort exception.
- c. It is IMPLEMENTATION DEFINED whether the DFAR is updated for a synchronous parity error.

**Note**

In previous ARM documentation, the terms precise and imprecise were used instead of synchronous and asynchronous. For details of the more exact terminology introduced in this manual see [Terminology for describing exceptions on page B1-1137](#).

**Reserved encodings in the IFSR and DFSR encodings tables**

A single encoding is reserved for cache lockdown faults. The details of these faults and any associated subsidiary registers are IMPLEMENTATION DEFINED.

A single encoding is reserved for aborts associated with coprocessors. The details of these faults are IMPLEMENTATION DEFINED.

**B5.5.5 Provision for classification of external aborts**

An implementation can use the DFSR.ExT and IFSR.ExT bits to provide more information about external aborts:

- DFSR.ExT can provide an IMPLEMENTATION DEFINED classification of external aborts on data accesses
- IFSR.ExT can provide an IMPLEMENTATION DEFINED classification of external aborts on instruction accesses.

For all aborts other than external aborts these bits return a value of 0.

## B5.5.6 Auxiliary Fault Status Registers

ARMv7 architects two Auxiliary Fault Status Registers, described as the **AxFSRs**:

- the *Auxiliary Data Fault Status Register* (ADFSR)
- the *Auxiliary Instruction Fault Status Register* (AIFSR).

These registers enable additional fault status information to be returned:

- The position of these registers is architecturally-defined, but the content and use of the registers is IMPLEMENTATION DEFINED.
- An implementation that does not need to report additional fault information must implement these registers as UNK/SBZP. This ensures that an attempt to access these registers from PL1 is not faulted.

An example use of these registers would be to return more information for diagnosing parity errors.

## B5.6 About the system control registers for PMSA

On an ARMv7-A or ARMv7-R implementation, the control registers comprise:

- the registers accessed using the System Control Coprocessor, CP15
- registers accessed using the CP14 coprocessor, including:
  - debug registers
  - trace registers
  - execution environment registers.

*Organization of the CP14 registers in a PMSA implementation on page B5-1784* summarizes the CP14 registers, and indicates where the CP14 registers are described, either in this manual or in other architecture specifications.

*Organization of the CP15 registers in a PMSA implementation on page B5-1785* summarizes the CP15 registers, and indicates where in this manual the CP15 registers are described.

This section gives general information about the control registers, the CP14 and CP15 interfaces to these registers, and the conventions used in describing these registers.

### ———— Note —————

Many implementations include other interfaces to some functional groups of CP14 and CP15 registers, for example, memory-mapped interfaces to the CP14 Debug registers. These are described in the appropriate sections of this manual.

This section is organized as follows:

- *About system control register accesses*
- *General behavior of system control registers on page B5-1774*
- *Synchronization of changes to system control registers on page B5-1777*
- *Meaning of fixed bit values in register diagrams on page B5-1783.*

### B5.6.1 About system control register accesses

In a PMSAv7 implementation that does not include the OPTIONAL Generic Timer, all control registers are 32-bits wide. *Accessing 32-bit control registers on page B5-1773* describes how these registers are accessed.

A PMSA implementation that includes the OPTIONAL Generic Timer must also implement a small number of 64-bit control registers. *Accessing 64-bit control registers on page B5-1773* describes how these registers are accessed.

### ———— Note —————

- In addition, the Large Physical Address Extension and the Virtualization Extensions introduce a small number of 64-bit control registers to the processor implementation, and to the associated debug implementation. A PMSA implementation cannot include these extensions.
- Optionally, an ARMv6 implementation can include some block transfer operations that are accessed using 64-bit CP15 accesses, see *Block transfer operations on page AppxL-2534*.

When using the MCR and MRC instructions to access these registers, the instruction arguments include:

- A coprocessor identifier, coproc, as a value p0-p15, corresponding to CP0-CP15.
- A coprocessor register, CRn, as a value c0-c15, to specify a coprocessor register number.
- An opcode, opc1, as a value in the range 0-7.

### ———— Note —————

- When accessing CP15, the primary coprocessor register is the top-level indicator of the accessed functionality, and when using an MCR or MRC instruction, CRn specifies the primary coprocessor register.
- When accessing CP14 using these instructions, opc1 is the top-level indicator of the accessed functionality.



## Ordering of reads of system control registers

Reads of the system control registers can occur out of order with respect to earlier instructions executed on the same processor, provided that the data dependencies between the instructions, specified in [Synchronization of changes to system control registers on page B5-1777](#), are met.

### ———— Note —————

In particular, system control registers holding self-incrementing counts, for example the Performance Monitors counters or the Generic Timer counter or timers, can be read *early*. This means that, for example, if a memory communication is used to communicate a read of the Generic Timer counter, an ISB must be inserted between the read of the memory location used for this communication and the read of the Generic Timer counter if it is required that the Generic Timer counter returns a count value that is later than the memory communication.

---

## Accessing 32-bit control registers

Software accesses a 32-bit control register using the generic MCR and MRC coprocessor interface, specifying:

- A coprocessor identifier, *coproc*, identifying one of the coprocessors CP0-CP15.
- Two coprocessor registers, *CRn* and *CRm*. *CRn* specifies the primary coprocessor register.
- Two coprocessor-specific opcodes, *opc1* and *opc2*.
- An ARM core register to hold a 32-bit value to transfer to or from the coprocessor.

CP15 and CP14 provides the control registers. A processor access to a specific 32-bit control register uses:

- *p15* to specify CP15, or *p14* to specify CP14
- a unique combination of *CRn*, *opc1*, *CRm*, and *opc2*, to specify the required control register
- an ARM core register for the transferred 32-bit value.

The processor accesses a 32-bit control register using:

- an MCR instruction to write to a control register, see [MCR, MCR2 on page A8-476](#)
- an MRC instruction to read a control register, see [MRC, MRC2 on page A8-492](#).

## Accessing 64-bit control registers

As indicated at the start of this section, a PMSA implementation includes 64-bit control registers only if it includes the OPTIONAL Generic Timer.

Software accesses a 64-bit control register using the generic MCRR and MRRC coprocessor interface, specifying:

- A coprocessor identifier, *coproc*, identifying one of coprocessors CP0-CP15.
- A coprocessor register, *CRm*. In this case, *CRm* specifies the primary coprocessor register.
- A single coprocessor-specific opcode, *opc1*.
- Two ARM core registers to hold two 32-bit values to transfer to or from the coprocessor.

CP15 and CP14 provide the control registers. A processor access to a specific 64-bit control register uses:

- *p15* to specify CP15, or *p14* to specify CP14
- a unique combination of *CRm* and *opc1*, to specify the required 64-bit system control register
- two ARM core registers, each holding 32 bits of the value to transfer.

Therefore, processor accesses a 64-bit control register using:

- an MCRR instruction to write to a control register, see [MCRR, MCRR2 on page A8-478](#)
- an MRRC instruction to read a control register, see [MRRC, MRRC2 on page A8-494](#).

When using a MCRR or MRRC instruction:

- *Rt* contains the least-significant 32 bits of the transferred value, and *Rt2* contains the most-significant 32 bits of that value.
- the access is 64-bit atomic.

## B5.6.2 General behavior of system control registers

Except where indicated, system control registers are 32-bits wide. As stated in *About system control register accesses* on page B5-1772, there are some 64-bit registers, and these include cases where software can access either a 32-bit view or a 64-bit view of a register. The register summaries, and the individual register descriptions, identify the 64-bit registers and how they can be accessed.

The following sections give information about the general behavior of these registers. Unless otherwise indicated, information applies to both CP14 and CP15 registers:

- *Read-only bits in read/write registers*
- *UNPREDICTABLE and UNDEFINED behavior for CP14 and CP15 accesses*
- *Reset behavior of CP14 and CP15 registers on page B5-1776.*

See also *About system control register accesses* on page B5-1772 and *Meaning of fixed bit values in register diagrams* on page B5-1783.

### Read-only bits in read/write registers

Some read/write registers include bits that are read-only. These bits ignore writes.

An example of this is the `SCTLR.NMFI` bit, bit[27].

### UNPREDICTABLE and UNDEFINED behavior for CP14 and CP15 accesses

In PMSAv7 the following operations are UNDEFINED:

- all CDP, LDC and STC operations to CP14 and CP15, except for the LDC access to `DBGDTRTXint` and the STC access to `DBGDTRRXint` specified in *CP14 debug register interface accesses* on page C6-2122
- all MCR and MRRC operations to CP14 and CP15, except for those explicitly defined as accessing 64-bit CP14 and CP15 registers
- all CDP2, MCR2, MRC2, MCR2, MRRC2, LDC2 and STC2 operations to CP14 and CP15.

Unless otherwise indicated in the individual register descriptions:

- reserved fields in registers are UNK/SBZP
- assigning a reserved value to a field can have an UNPREDICTABLE effect.

The following subsections give more information about UNPREDICTABLE and UNDEFINED behavior for CP14 and CP15 accesses:

- *Accesses to unallocated CP14 and CP15 encodings*
- *Additional rules for MCR and MRC accesses to CP14 and CP15 registers on page B5-1775.*

### Accesses to unallocated CP14 and CP15 encodings

The general rules for the behavior of accesses to unallocated register encodings are similar for CP14 and CP15, but because the primary register specifier is different for CP14 and CP15, the details differ. Therefore, the rules are:

**For CP14** For any MCR or MRC access to CP14, the `opc1` value for the instruction is the primary specifier for the functional group of registers accessed, see *Organization of the CP14 registers in a PMSA implementation* on page B5-1784. Accesses to unallocated functional groups of registers are UNDEFINED. This means any access with `<opc1> == {2, 3, 4, 5}` is UNDEFINED.

For MCR or MRC accesses to an allocated functional group of registers, the behavior of accesses to unallocated registers in the functional group depends on the group:

#### **opc1==0, Debug registers**

The behavior of accesses to unallocated registers depends on the Debug architecture version, see:

- *Access to unallocated CP14 debug register encodings, v7 Debug* on page C6-2136

- [Access to unallocated CP14 debug register encodings, v7.1 Debug on page C6-2145.](#)

**opc1==1, Trace registers**

See the appropriate trace architecture specification for the behavior of CP14 accesses to unallocated Trace registers.

**opc1=={6, 7}, ThumbEE and Jazelle registers**

Accesses to unallocated register encodings are UNPREDICTABLE.

———— **Note** —————

The opc1==7 functional group, the Jazelle registers, can include registers that are defined by the Jazelle subarchitecture.

**For CP15** For an MCR or MRC access to CP15, the CRn value for the instruction is the primary register specifier for the CP15 space, and the following rules define the behavior of accesses to unallocated encodings:

1. Accesses to unallocated primary registers are UNDEFINED. For the ARMv7-R Architecture, this means that:
  - For any ARMv7-R implementation, accesses to CP15 primary registers {c2, c3, c4, c8, c10, c12} are UNDEFINED.
  - For an implementation that does not include the Generic Timer Extension, accesses to CP15 primary register c14 are UNDEFINED.

See rule 3 for the behavior of accesses to CP15 primary register c15.

2. In an allocated CP15 primary register, MCR and MRC accesses to all unallocated encodings are UNPREDICTABLE for accesses at PL1.

This means that any MCR and MRC accesses from PL1 with a combination of <CRn>, <opc1>, <CRm> and <opc2> values not shown in, or referenced from, [Full list of PMSA CP15 registers, by coprocessor register number on page B5-1792](#), that would access an allocated CP15 primary register, is UNPREDICTABLE. As indicated by rule 1, for the ARMv7-R architecture, the allocated CP15 primary registers are:

- in any PMSA implementation, c0, c1, c5-c7, c9, c11, and c13
- in addition, in an implementation that includes the Generic Timer, c14.

———— **Note** —————

As shown in [Figure B5-4 on page B5-1787](#), accesses to unallocated principal ID registers map onto the MIDR. These are accesses with <CRn> = c0, <opc1> = 0, <CRm> = c0, and <opc2> = {3, 6, 7}.

3. CP15 primary register c15 is reserved for IMPLEMENTATION DEFINED registers. This means it is IMPLEMENTATION DEFINED whether this primary register is allocated or unallocated:
  - if an implementation does not define any registers in CP15 primary register c15, then that primary register is unallocated, and all MCR and MRC accesses to it are UNDEFINED
  - otherwise, CP15 primary register c15 is allocated, and MCR and MRC accesses to unallocated encodings with CRn set to c15 are UNPREDICTABLE for accesses at PL1.

**Additional rules for MCR and MRC accesses to CP14 and CP15 registers**

All MCR operations from the PC are UNPREDICTABLE for all coprocessors, including for CP14 and CP15.

All MRC operations to APSR\_nzcv are UNPREDICTABLE for CP14 and CP15, except for the CP14 MRC to APSR\_nzcv shown in [CP14 debug register interface accesses on page C6-2122](#).

Except for CP14 and CP15 encodings that the appropriate register description identifies as accessible by software executing at PL0, all MCR and MRC accesses from User mode are UNDEFINED. This applies to all User mode accesses to unallocated CP14 and CP15 encodings.

Some individual registers can be made inaccessible by setting configuration bits, possibly including IMPLEMENTATION DEFINED configuration bits, to disable access to the register. The effects of the architecturally-defined configuration bits are defined individually in this manual. Unless explicitly stated otherwise in this manual, setting a configuration bit to disable access to a register results in the register becoming UNDEFINED for MRC and MCR accesses.

See also [Read-only and write-only register encodings](#).

### Read-only and write-only register encodings

Some system control registers are *read-only* (RO) or *write-only* (WO). For example:

- most identification registers are read-only
- most encodings that perform an operation, such as a cache maintenance operation, are write-only.

If this manual defines a register to be RO at a particular privilege level then, at that privilege level:

- an MCR access to the register is UNPREDICTABLE
- an MCRR access to the register is UNDEFINED, regardless of whether the register can be read by an MRRC instruction.

If this manual defines a register to be WO at a particular privilege level then, at that privilege level:

- an MRC access to the register is UNPREDICTABLE
- an MRRC access to the register is UNDEFINED, regardless of whether the register can be written by an MCRR instruction.

---

#### Note

- This section applies only to registers that this manual defines as RO or WO. It does not apply to registers for which other access permissions are explicitly defined.
  - Although the FPSID is a RO register, a write using the FPSID encoding is a valid *serializing* operation, see [Asynchronous bounces, serialization, and Floating-point exception barriers on page B1-1237](#). Such a write does not access the register.
- 

### Reset behavior of CP14 and CP15 registers

After a reset, only a limited subset of the processor state is guaranteed to be set to defined values. Also, for CP14 debug and trace registers, reset requirements must take account of different levels of reset. For more information about the reset behavior of CP14 and CP15 registers, see:

- [Reset and debug on page C7-2160](#), for the Debug CP14 registers
- the appropriate Trace architecture specification, for the Trace CP14 registers
- [ThumbEE configuration on page A2-95](#)
- [Application level configuration and control of the Jazelle extension on page A2-99](#).
- [Reset behavior of CP15 registers](#)
- [Pseudocode details of resetting CP14 and CP15 registers on page B5-1777](#).

### Reset behavior of CP15 registers

On reset, the PMSAv7 architecture defines a required reset value for all or part of each of the following CP15 registers:

- The SCTLR, DRSR, IRSR, and the CPACR.
- In an implementation that includes the Performance Monitors extension, the PMCR, the PMUSERENR, and in an implementation of PMUv2, the instance of PMXEVTYPER that relates to the cycle counter.
- In an implementation that includes the Generic Timer Extension, the CNTKCTL register.

For details of the reset values of these registers see the register descriptions. If the description of a register or register field does not include its reset value then the architecture does not require that register or field to reset to a defined value.

The values of all other registers at reset are architecturally UNKNOWN. An implementation can assign an IMPLEMENTATION DEFINED reset value to a register whose reset value is architecturally UNKNOWN. After a reset, software must not rely on the value of any read/write register that does not have either an architecturally-defined reset value or an IMPLEMENTATION DEFINED reset value.

### **Pseudocode details of resetting CP14 and CP15 registers**

The `ResetControlRegisters()` pseudocode function resets all CP14 and CP15 registers, and register fields, that have defined reset values, as described in this section.

———— **Note** —————

For CP14 debug and trace registers this function resets registers as defined for the appropriate level of reset.

## **B5.6.3 Synchronization of changes to system control registers**

In this section, *this processor* means the processor on which accesses are being synchronized.

———— **Note** —————

See [Definitions of direct and indirect reads and writes and their side-effects on page B5-1781](#) for definitions of the terms *direct write*, *direct read*, *indirect write*, and *indirect read*.

A *direct write* to a system control register might become visible at any point after the change to the register, but without a [Context synchronization operation](#) there is no guarantee that the change becomes visible.

Any direct write to a system control register is guaranteed not to affect any instruction that appears, in program order, before the instruction that performed the direct write, and any direct write to a system control register must be synchronized before any instruction that appears after the direct write, in program order, can rely on the effect of that write. The only exceptions to this are:

- All direct writes to the same register, using the same encoding, are guaranteed to occur in program order.
- All direct writes to a register are guaranteed to occur in program order relative to all direct reads of the same register using the same encoding.
- If an instruction that appears in program order before the direct write performs a memory access, such as a memory-mapped register access, that causes an indirect read or write to a register, that memory access is subject to the ARM ordering model. In this case, if permitted by the ARM ordering model, the instruction that appears in program order before the direct write can be affected by the direct write.

Conceptually, the explicit synchronization occurs as the first step of any [Context synchronization operation](#). This means that if the operation uses state that had been changed but not synchronized before the operation occurred, the operation is guaranteed to use the state as if it had been synchronized.

———— **Note** —————

This explicit synchronization is applied as the first step of the execution of any instruction that causes the operation. This means it does not synchronize any effect of system registers that might affect the fetch and decode of the instructions that cause the operation, such as breakpoints or changes to translation tables.

Except for the register reads listed in [Registers with some architectural guarantee of ordering or observability on page B5-1780](#), if no context synchronization operation is performed, direct reads of system control registers can occur in any order.

Table B5-9 shows the synchronization requirement between two reads or writes that access the same system control register. In the column headings, *First* and *Second* refer to:

- Program order, for any read or write caused by the execution of an instruction by this processor, other than a read or write caused by a memory access made by that instruction.
- The order of arrival of asynchronous reads or writes made by this processor relative to the execution of instructions by this processor.

In addition:

- For indirect reads or writes caused by an external agent, such as a debugger, the mechanism that determines the order of the reads or writes is defined by that external agent. The external agent can provide mechanisms that ensure that any reads or writes it makes arrive at the processor. These indirect reads and writes are asynchronous to software execution on the processor.
- For indirect reads or writes caused by memory-mapped reads or writes made by this processor, the ordering of the memory accesses is subject to the memory order model, including the effect of the memory type of the accessed memory address. This applies, for example, if this processor reads or writes one of its registers in a memory-mapped register interface.

The mechanism for ensuring completion of these memory accesses, including ensuring the arrival of the asynchronous read or write at the processor, is defined by the system.

———— **Note** —————

Such accesses are likely to be given the Device or Strongly-ordered attribute, but requiring this is outside the scope of the processor architecture.

- For indirect reads or writes caused by autonomous asynchronous events that count, for example events caused by the passage of time, the events are ordered so that:
  - Counts progress monotonically.
  - The events arrive at the processor in finite time and without undue delay.

**Table B5-9 Synchronization requirements for updates to system control registers**

First read or write	Second read or write	Context synchronization operation required
Direct read	Direct read	No
	Direct write	No
	Indirect read	No <sup>a</sup>
	Indirect write	No <sup>a</sup> , but see text in this section for exceptions
Direct write	Direct read	No
	Direct write	No
	Indirect read	Yes <sup>a</sup>
	Indirect write	No, but see text in this section for exceptions
Indirect read	Direct read	No
	Direct write	No
	Indirect read	No
	Indirect write	No

**Table B5-9 Synchronization requirements for updates to system control registers (continued)**

First read or write	Second read or write	Context synchronization operation required
Indirect write	Direct read	Yes, but see text in this section for exceptions
	Direct write	No, but see text in this section for exceptions
	Indirect read	Yes, but see text in this section for exceptions
	Indirect write	No, but see text in this section for exceptions

- a. Although no synchronization is required between a Direct write and a Direct read, or between a Direct read and an Indirect write, this does not imply that a Direct read causes synchronization of a previous Direct write. This means that the sequence Direct write followed by Direct read followed by Indirect read, with no intervening context synchronization, does not guarantee that the Indirect read observes the result of the Direct write.

If the indirect write is to a register that *Registers with some architectural guarantee of ordering or observability on page B5-1780* shows as having some guarantee of the visibility of an indirect writes, synchronization might not be required.

If a direct read or a direct write to a register is followed by an indirect write to that register that is caused by an external agent, or by an autonomous asynchronous event, or as a result of a memory-mapped write, then synchronization is required to guarantee the ordering of the indirect write relative to the direct read or direct write.

If an indirect write caused by a direct write is followed by an indirect write caused by an external agent, or by an autonomous asynchronous event, or as a result of a memory-mapped write, then synchronization is required to guarantee the ordering of the two indirect writes.

If a direct read causes an indirect write, synchronization is required to guarantee that the indirect write is visible to subsequent direct or indirect reads or writes. This synchronization must be performed after the direct read, before the subsequent direct or indirect reads or writes.

If a direct write causes an indirect write, synchronization is required to guarantee that the indirect write is visible to subsequent direct or indirect reads or writes. This synchronization must be performed after the direct write that causes the update and before the subsequent direct or indirect reads or writes.

———— **Note** —————

Where a register has more than one encoding, a direct write to the register using a particular encoding is not an indirect write to the same register with a different encoding.

Where an indirect write is caused by the action of an external agent, such as a debugger, or by a memory-mapped read or write by the processor, then an indirect write by that agent to a register using a particular access mechanism, followed by an indirect read by that agent to the same register using the same access mechanism and address does not need synchronization.

For information about the additional synchronization requirements for memory-mapped registers, see *Synchronization requirements for memory-mapped register interfaces on page C6-2115*.

To guarantee the visibility of changes to some registers, additional operations might be required, before the context synchronization operation. For such a register, the definition of the register identifies these additional requirements.

In this manual, unless the context indicates otherwise:

- *Accessing* a system control register refers to a direct read or write of the register.
- *Using* a system control register refers to an indirect read or write of the register.



### Registers with some architectural guarantee of ordering or observability

For the registers for which [Table B5-10](#) shows that the ordering of direct reads is guaranteed, multiple direct reads of a single register, using the same encoding, occur in program order without any explicit ordering.

For the registers for which [Table B5-10](#) shows that some observability of indirect writes is guaranteed, an indirect write to the register caused by an external agent, an autonomous asynchronous events, or as a result of a memory mapped write, is both:

- Observable to direct reads of the register, in finite time, without explicit synchronization.
- Observable to subsequent indirect reads of the register without explicit synchronization.

These two sets of registers are similar, as [Table B5-10](#) shows:

**Table B5-10 Registers with a guarantee of ordering or observability, in a VMSA implementation**

Register	Ordering of direct reads	Observability of indirect writes	Notes
<a href="#">DBGCLAIMCLR</a>	-	Guaranteed	Debug claim registers
<a href="#">DBGCLAIMSET</a>	Guaranteed	Guaranteed	
<a href="#">DBGDTRRX</a>	Guaranteed	Guaranteed	Debug Communication Channel registers
<a href="#">DBGDTRTX</a>	Guaranteed	Guaranteed	
<a href="#">CNTPTCT</a>	Guaranteed	Guaranteed	Generic Timer Extension registers, if the implementation includes the extension
<a href="#">CNTPT_TVAL</a>	Guaranteed	Guaranteed	
<a href="#">CNTVCT</a>	Guaranteed	Guaranteed	
<a href="#">CNTV_TVAL</a>	Guaranteed	Guaranteed	
<a href="#">PMCCNTR</a>	Guaranteed	Guaranteed	Performance Monitors Extension registers, if the implementation includes the extension
<a href="#">PMXVCNTR</a>	Guaranteed	Guaranteed	

For the specified registers, the observability requirement is more demanding than the observability requirements for other registers. However, the possibility that direct reads can occur *early*, in the absence of context synchronization, described in [Ordering of reads of system control registers on page B5-1773](#), still applies to these registers.

In Debug state, additional synchronization requirements can apply to the registers shown in [Table B5-10](#). For more information, see:

- [Synchronization of accesses to the Debug Communications Channel on page C6-2115](#).
- [Synchronization of accesses to the DCC and the DBGITR on page C8-2176](#).



## Definitions of direct and indirect reads and writes and their side-effects

Direct and indirect reads and writes are defined as follows:

**Direct read** Is a read of a register, using an MRC, MRC2, MRRC, MRRC2, LDC, or LDC2 instruction, that the architecture permits for the current processor state.

If a direct read of a register has a side-effect of changing the value of a register, the effect of a direct read on that register is defined to be an *indirect write*, and has the synchronization requirements of an indirect write. This means the indirect write is guaranteed to have occurred, and to be visible to subsequent direct or indirect reads and writes only if synchronization is performed after the direct read.

---

**Note**

---

The indirect write described here can affect either the register written to by the direct write, or some other register. The synchronization requirement is the same in both cases.

**Direct write** Is a write to a register, using an MCR, MCR2, MCRR, MCRR2, STC, or STC2 instruction, that the architecture permits for the current processor state.

In the following cases, the side-effect of the direct write is defined to be an indirect write of the affected register, and has the synchronization requirements of an indirect write:

- If the direct write has a side-effect of changing the value of a register other than the register accessed by the direct write.
- If the direct write has a side-effect of changing the value of the register accessed by the direct write, so that the value in that register might not be the value that the direct write wrote to the register.

In both cases, this means that the indirect write is not guaranteed to be visible to subsequent direct or indirect reads and writes unless synchronization is performed after the direct write.

---

**Note**

---

- As an example of a direct write to a register having an effect that is an indirect write of that register, writing 1 to a [PMCNTENCLR.Px](#) bit is also an indirect write, because if the Px bit had the value 1 before the direct write, the side-effect of the write changes the value of that bit to 0.
- The indirect write described here can affect either the register written to by the direct write, or some other register. The synchronization requirement is the same in both cases. For example, writing 1 to a [PMCNTENCLR.Px](#) bit that is set to 1 also changes the corresponding [PMCNTENSET.Px](#) bit from 1 to 0. This means that the direct write to the [PMCNTENCLR](#) defines indirect writes to both itself and to the [PMCNTENSET](#).

**Indirect read** Is a use of the register by an instruction to establish the operating conditions for the instruction. Examples of operating conditions that might be determined by an indirect read are the translation table base address, or whether a cache is enabled.

Indirect reads include situations where the value of one register determines what value is returned by a second register. This means that any read of the second register is an indirect read of the register that determines what value is returned.

Indirect reads also include:

- Reads of the system control registers by external agents, such as debuggers, as described in [Chapter C6 Debug Register Interfaces](#).
- Memory-mapped reads of the system control registers made by the processor that implements the system control registers.

Where an indirect read of a register has a side-effect of changing the value of a register, that change is defined to be an indirect write, and has the synchronization requirements of an indirect write.

**Indirect write** Is an update to the value of a register as a consequence of either:

- An exception, operation, or execution of an instruction that is not a direct write to that register.
- The asynchronous operation of some external agent.

This can include:

- The passage of time, as seen in counters or timers, including performance counters.
- The assertion of an interrupt.
- A write from an external agent, such as a debugger.

However, for some registers, the architecture gives some guarantee of visibility without any explicit synchronization, see [Registers with some architectural guarantee of ordering or observability on page B5-1780](#).

———— **Note** —————

Taking an exception is a context-synchronizing operation. Therefore, any indirect write performed as part of an exception entry does not require additional synchronization. This includes the indirect writes to the registers that report the exception, as described in [Exception reporting in a PMSA implementation on page B5-1767](#).

---

#### B5.6.4 Meaning of fixed bit values in register diagrams

In register diagrams, fixed bits are indicated by one of following:

- 0** In any implementation:
- the bit must read as 0
  - writes to the bit must be ignored
  - software:
    - can rely on the bit reading as 0
    - must use an SBZP policy to write to the bit.

- (0)** In any implementation, for a read/write register:
- the bit must read as 0
  - writes to the bit must be ignored
  - software:
    - must not rely on the bit reading as 0
    - must use an SBZP policy to write to the bit.

Fields that are more than 1 bit wide are sometimes described as UNK/SBZP, instead of having each bit marked as (0).

In a read-only register, (0) indicates that the bit reads as 0, but software must treat the bit as UNK.

In a write-only register, (0) indicates that software must treat the bit as SBZ.

- 1** In any implementation:
- the bit must read as 1
  - writes to the bit must be ignored.
  - software:
    - can rely on the bit reading as 1
    - must use an SBOP policy to write to the bit.

- (1)** In any implementation, for a read/write register:
- the bit must read as 1
  - writes to the bit must be ignored
  - software:
    - must not rely on the bit reading as 1
    - must use an SBOP policy to write to the bit.

In a read-only register, (1) indicates that the bit reads as 1, but software must treat the bit as UNK.

In a write-only register, (1) indicates that software must treat the bit as SBO.

## B5.7 Organization of the CP14 registers in a PMSA implementation

The organization of CP14 registers is identical in VMSA and PMSA implementations. For more information see [Organization of the CP14 registers in a VMSA implementation on page B3-1468](#).

## B5.8 Organization of the CP15 registers in a PMSA implementation

Previous issues of this document described the CP15 registers in order of their primary coprocessor register number. More precisely, the ordered set of values {CRn, opc1, CRm, opc2} determined the register order. As the number of system control registers has increased this ordering has become less appropriate. Also, it applies only to 32-bit registers, since 64-bit registers are identified only by {CRm, opc1}, making it difficult to include 32-bit and 64-bit versions of a single register in a common ordering scheme.

This document now:

- Groups the CP15 registers by functional group. For more information about this grouping in a PMSA implementation, including a summary of each functional group, see [Functional grouping of PMSAv7 system control registers on page B5-1797](#).
- Describes all of the system control registers for a PMSA implementation, including the CP15 registers, in [Chapter B6 System Control Registers in a PMSA implementation](#). The description of each register is in the section [PMSA System control registers descriptions, in register order on page B6-1808](#).

This section gives additional information about the organization of the CP15 registers in a PMSA implementation, as follows:

### Register ordering by {CRn, opc1, CRm, opc2}

See:

- [PMSA CP15 register summary by coprocessor register number on page B5-1786](#)
- [Full list of PMSA CP15 registers, by coprocessor register number on page B5-1792](#).

#### ———— Note —————

The ordered listing of CP15 registers by the {CRn, opc1, CRm, opc2} encoding of the 32-bit registers is most likely to be useful to those implementing ARMv7 processors, and to those validating such implementations. However, otherwise, the grouping of registers by function is more logical.

### Views of the registers, that depend on the current state of the processor

See [Views of the CP15 registers on page B5-1795](#).

#### ———— Note —————

Because a PMSA implementation cannot include the Security Extensions or the Virtualization Extensions, these views are more limited than those in a VMSA implementation.

In addition, the indexes in [Appendix R Register Index](#) include all of the CP15 registers.

#### ———— Note —————

ARMv7 introduced significant changes to the memory system registers, especially in relation to caches. For details of:

- the CP15 register implementation in PMSAv6, see [Organization of CP15 registers for an ARMv6 PMSA implementation on page AppxL-2525](#)
- how software can use the ARMv7 registers to discover what caches can be accessed by the processor, see [Identifying the cache resources in ARMv7 on page B2-1267](#).

### B5.8.1 PMSA CP15 register summary by coprocessor register number

Figure B5-3 summarizes the grouping of CP15 registers by primary coprocessor register number for a PMSAv7 implementation.

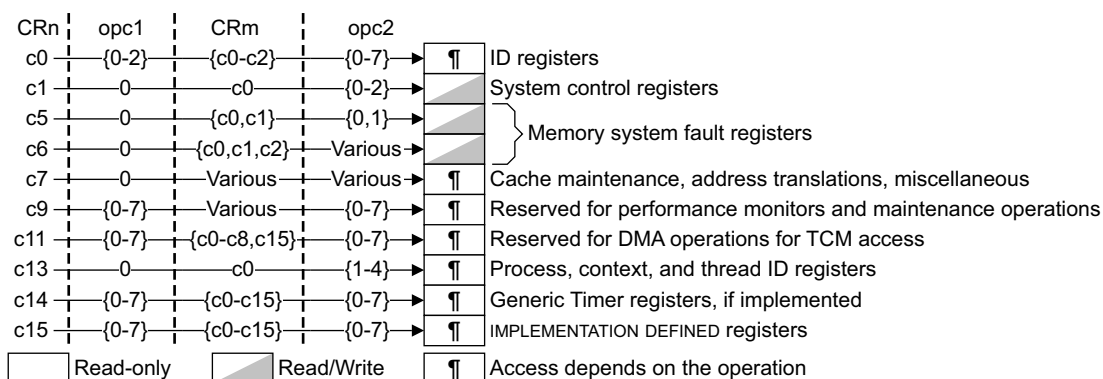

**Figure B5-3 CP15 register grouping by primary coprocessor register, CRn, PMSA implementation**

**Note**

Figure B5-3 gives only an overview of the assigned encodings for each of the CP15 primary registers c0-c15. See the description of each primary register for the definition of the assigned and unassigned encodings for that register, including any dependencies on whether the implementation includes architectural extensions.

The following sections give the register assignments for each of the CP15 primary registers, c0-c15:

- [PMSA CP15 c0 register summary, identification registers on page B5-1787](#)
- [PMSA CP15 c1 register summary, system control registers on page B5-1788](#)
- [PMSA CP15 c2 and c3 register summary, not used on a PMSA implementation on page B5-1788](#)
- [PMSA CP15 c4 register summary, not used on page B5-1788](#)
- [PMSA CP15 c5 and c6 register summary, memory system fault registers on page B5-1788](#)
- [PMSA CP15 c7 register summary, cache maintenance and other functions on page B5-1789](#)
- [PMSA CP15 c8 register summary, not used on a PMSA implementation on page B5-1789](#)
- [PMSA CP15 c9 register summary, reserved for cache and TCM lockdown registers and performance monitors on page B5-1789](#)
- [PMSA CP15 c10 register summary, not used on a PMSA implementation on page B5-1790](#)
- [PMSA CP15 c11 register summary, reserved for TCM DMA registers on page B5-1790](#)
- [PMSA CP15 c12 register summary, not used on a PMSA implementation on page B5-1790](#)
- [PMSA CP15 c13 register summary, context and thread ID registers on page B5-1790](#)
- [PMSA CP15 c14, reserved for Generic Timer Extension on page B5-1791](#)
- [PMSA CP15 c15 register summary, IMPLEMENTATION DEFINED registers on page B5-1791.](#)

[Full list of PMSA CP15 registers, by coprocessor register number on page B5-1792](#) then lists all of the PMSA CP15 registers, ordered by {CRn, opc1, CRm, opc2} values.

### PMSA CP15 c0 register summary, identification registers

The CP15 c0 registers provide processor and feature identification. Figure B5-4 shows the CP15 c0 registers in a PMSA implementation.

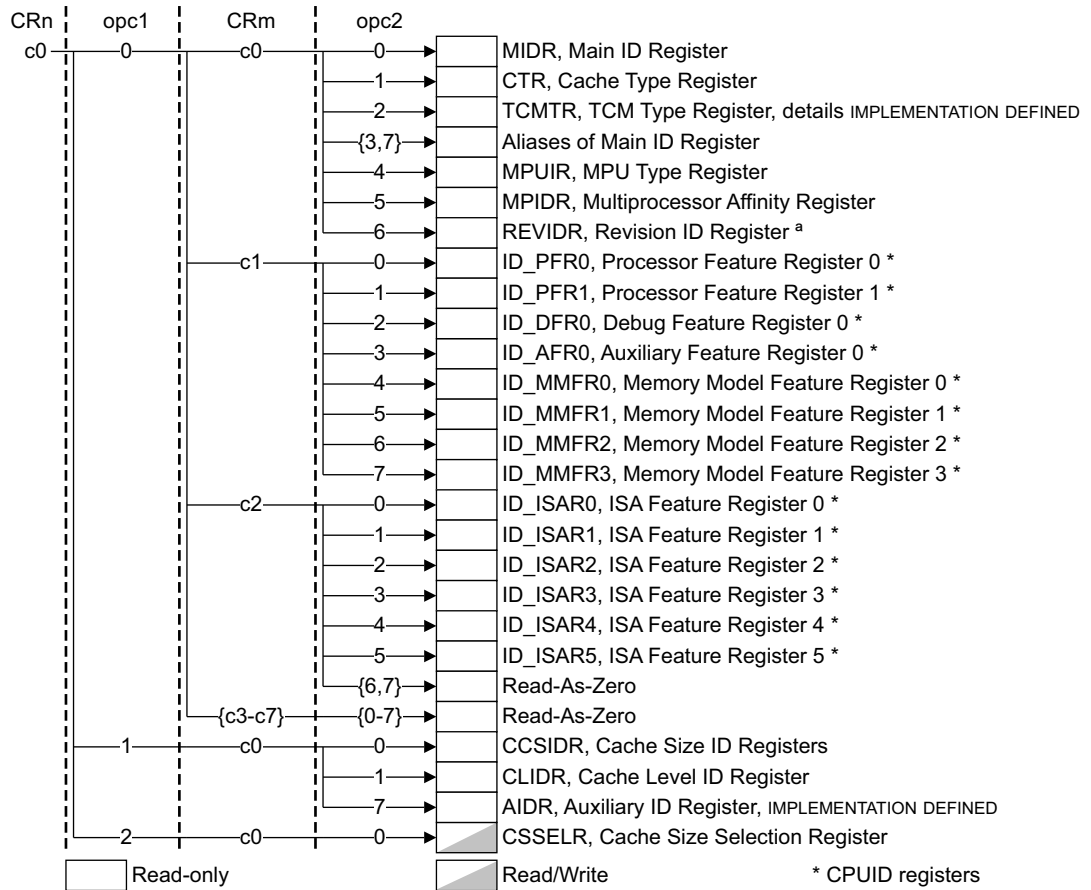

Figure B5-4 CP15 c0 registers in a PMSA implementation

CP15 c0 register encodings not shown in Figure B5-4, and encodings that are part of an unimplemented architectural extension, are UNPREDICTABLE, see [Accesses to unallocated CP14 and CP15 encodings](#) on page B5-1774.

**Note**

- Chapter B7 *The CPUID Identification Scheme* describes the CPUID registers shown in Figure B5-4.
- The CPUID scheme described in Chapter B7 *The CPUID Identification Scheme* includes information about the implementation of the OPTIONAL Floating-point and Advanced SIMD architecture extensions. See [Advanced SIMD and Floating-point Extensions](#) on page A2-54 for a summary of the implementation options for these features.

### PMSA CP15 c1 register summary, system control registers

The CP15 c1 registers provide system control. Figure B5-5 shows the CP15 c1 registers in a PMSA implementation.

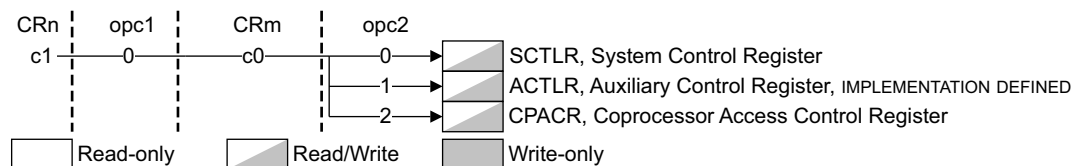

Figure B5-5 CP15 c1 registers in a PMSA implementation

CP15 c1 register encodings not shown in Figure B5-5, and encodings that are part of an unimplemented architectural extension, are UNPREDICTABLE, see [Accesses to unallocated CP14 and CP15 encodings on page B5-1774](#).

### PMSA CP15 c2 and c3 register summary, not used on a PMSA implementation

The CP15 c2 and c3 register encodings are not used on an ARMv7-R implementation, see [Accesses to unallocated CP14 and CP15 encodings on page B5-1774](#).

### PMSA CP15 c4 register summary, not used

CP15 c4 is not used on any ARMv7 implementation, see [Accesses to unallocated CP14 and CP15 encodings on page B5-1774](#).

### PMSA CP15 c5 and c6 register summary, memory system fault registers

The CP15 c5 and c6 registers provide memory system fault reporting. In addition, c6 provides the MPU Region registers. Figure B5-6 shows the CP15 c5 and c6 registers in a PMSA implementation.

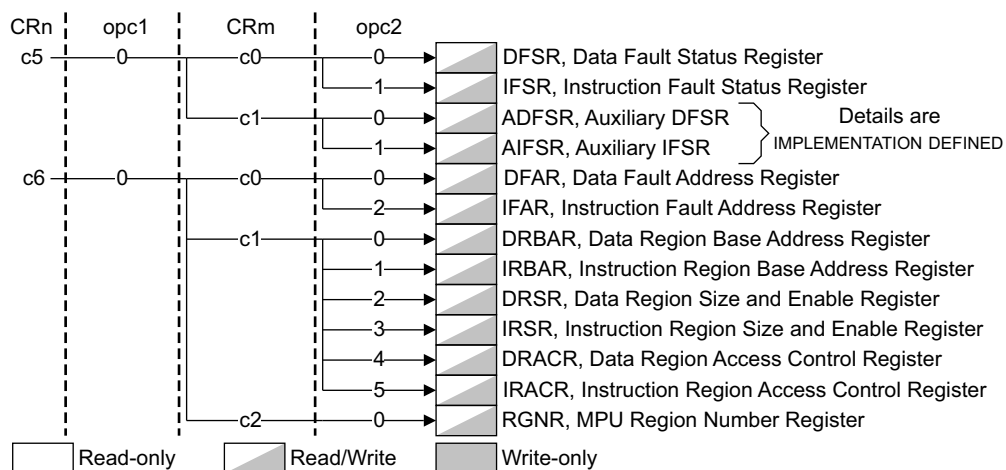

Figure B5-6 CP15 c5 and c6 registers in a PMSA implementation

CP15 c5 and c6 register encodings not shown in Figure B5-6, and encodings that are part of an unimplemented architectural extension, are UNPREDICTABLE, see [Accesses to unallocated CP14 and CP15 encodings on page B5-1774](#).





The reserved encodings permit implementations that are compatible with previous versions of the ARM architecture, in particular with the ARMv6 requirements. Figure B5-8 shows the reserved CP15 c9 register encodings in a PMSA implementation.

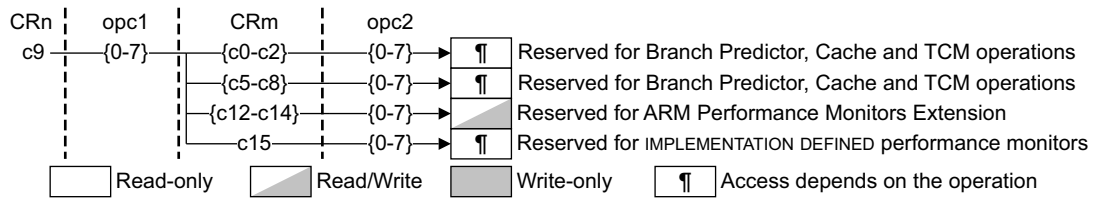

Figure B5-8 Reserved CP15 c9 encodings

CP15 c9 encodings not shown in Figure B5-8 are UNPREDICTABLE, see [Accesses to unallocated CP14 and CP15 encodings on page B5-1774](#).

### PMSA CP15 c10 register summary, not used on a PMSA implementation

CP15 c10 is not used on an ARMv7-R implementation, see [Accesses to unallocated CP14 and CP15 encodings on page B5-1774](#).

### PMSA CP15 c11 register summary, reserved for TCM DMA registers

ARM reserves some CP15 c11 encodings for IMPLEMENTATION DEFINED DMA operations to and from TCM. Figure B5-9 shows the reserved CP15 c11 encodings.

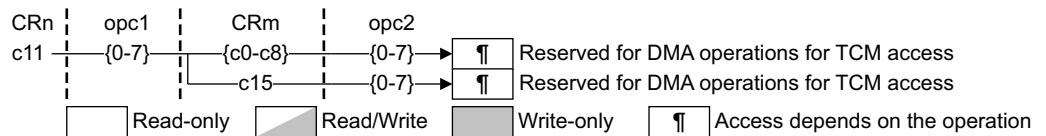

Figure B5-9 Reserved CP15 c11 encodings

All CP15 c11 encodings not shown in Figure B5-9 are UNPREDICTABLE, see [Accesses to unallocated CP14 and CP15 encodings on page B5-1774](#).

### PMSA CP15 c12 register summary, not used on a PMSA implementation

CP15 c12 is not used on an ARMv7-R implementation, see [Accesses to unallocated CP14 and CP15 encodings on page B5-1774](#).

### PMSA CP15 c13 register summary, context and thread ID registers

The CP15 c13 registers provide:

- a Context ID Register
- Software Thread ID Registers.

Figure B5-10 shows the CP15 c13 registers in a PMSA implementation.

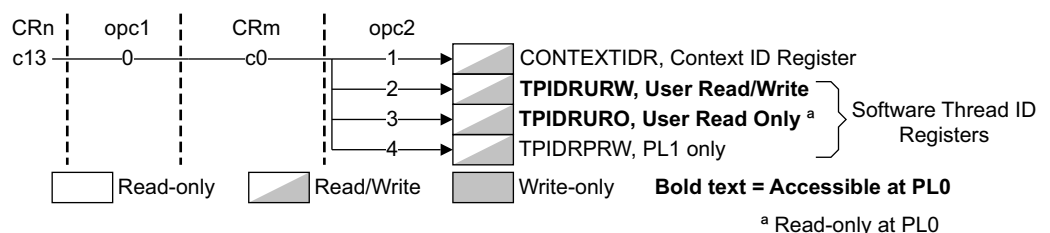

Figure B5-10 CP15 c13 registers in a PMSA implementation

CP15 c13 encodings not shown in Figure B5-10 on page B5-1790, and encodings that are part of an unimplemented architectural extension, are UNPREDICTABLE, see *Accesses to unallocated CP14 and CP15 encodings* on page B5-1774.

### PMSA CP15 c14, reserved for Generic Timer Extension

From issue C.a of this manual, CP15 c14 is reserved for the system control registers of the OPTIONAL Generic Timer Extension. For more information, see *Chapter B8 The Generic Timer*. On an implementation that does not include the Generic Timer, c14 is an unallocated CP15 primary register, see *UNPREDICTABLE and UNDEFINED behavior for CP14 and CP15 accesses* on page B5-1774.

Figure B5-11 shows the 32-bit CP15 c14 registers in a PMSAv7 implementation that includes the Generic Timer Extension:

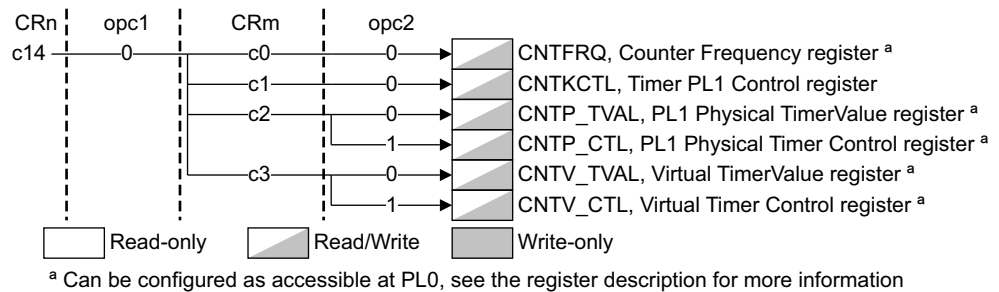

All registers are implemented only as part of the optional Generic Timer Extension

**Figure B5-11 CP15 32-bit c14 registers in a PMSA implementation that includes the Generic Timer Extension**

Figure B5-12 shows the 64-bit CP15 c14 registers in a PMSAv7 implementation that includes the Generic Timer Extension:

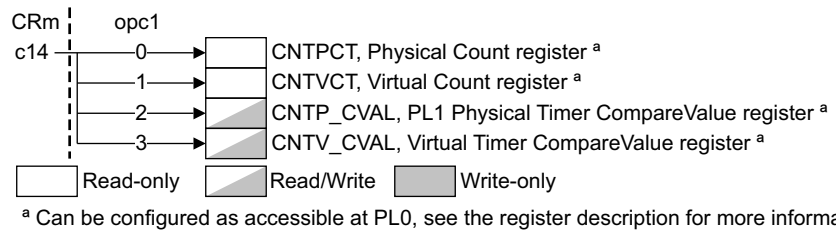

All registers are implemented only as part of the optional Generic Timer Extension

**Figure B5-12 CP15 64-bit c14 registers in a PMSA implementation that includes the Generic Timer Extension**

See also *Status of the CNTVOFF register* on page B8-1968.

### PMSA CP15 c15 register summary, IMPLEMENTATION DEFINED registers

ARMv7 reserves CP15 c15 for IMPLEMENTATION DEFINED purposes, and does not impose any restrictions on the use of the CP15 c15 encodings. For more information, see *IMPLEMENTATION DEFINED registers, functional group* on page B5-1803.

## B5.8.2 Full list of PMSA CP15 registers, by coprocessor register number

Table B5-11 shows the CP15 registers in a PMSA implementation, in {CRn, opc1, CRm, opc2} order. The table also includes links to the descriptions of each of the CP15 primary registers, c0 to c15.

The only UNPREDICTABLE encodings shown in the table are those that had defined functions in ARMv6.

**Table B5-11 Summary of PMSA CP15 register descriptions, in coprocessor register number order**

CRn	opc1	CRm	opc2	Name	Width	Description
c0	0	c0	0	<a href="#">MIDR</a>	32-bit	Main ID Register
			1	<a href="#">CTR</a>	32-bit	Cache Type Register
			2	<a href="#">TCMTR</a>	32-bit	TCM Type Register
			3, 6 <sup>a</sup> , 7	<a href="#">MIDR</a>	32-bit	Aliases of Main ID Register
			4	<a href="#">MPUIR</a>	32-bit	MPU Type Register
			5	<a href="#">MPIDR</a>	32-bit	Multiprocessor Affinity Register
			6 <sup>a</sup>	<a href="#">REVIDR</a>	32-bit	Revision ID Register
		c1	0	<a href="#">ID_PFR0</a>	32-bit	Processor Feature Register 0
			1	<a href="#">ID_PFR1</a>	32-bit	Processor Feature Register 1
			2	<a href="#">ID_DFR0</a>	32-bit	Debug Feature Register 0
c1			3	<a href="#">ID_AFR0</a>	32-bit	Auxiliary Feature Register 0
			4	<a href="#">ID_MMFR0</a>	32-bit	Memory Model Feature Register 0
			5	<a href="#">ID_MMFR1</a>	32-bit	Memory Model Feature Register 1
			6	<a href="#">ID_MMFR2</a>	32-bit	Memory Model Feature Register 2
			7	<a href="#">ID_MMFR3</a>	32-bit	Memory Model Feature Register 3
c0	0	c2	0	<a href="#">ID_ISAR0</a>	32-bit	Instruction Set Attribute Register 0
			1	<a href="#">ID_ISAR1</a>	32-bit	Instruction Set Attribute Register 1
			2	<a href="#">ID_ISAR2</a>	32-bit	Instruction Set Attribute Register 2
			3	<a href="#">ID_ISAR3</a>	32-bit	Instruction Set Attribute Register 3
			4	<a href="#">ID_ISAR4</a>	32-bit	Instruction Set Attribute Register 4
			5	<a href="#">ID_ISAR5</a>	32-bit	Instruction Set Attribute Register 5
c0	1	c0	0	<a href="#">CCSIDR</a>	32-bit	Cache Size ID Registers
			1	<a href="#">CLIDR</a>	32-bit	Cache Level ID Register
			7	<a href="#">AIDR</a>	32-bit	IMPLEMENTATION DEFINED Auxiliary ID Register
c0	2	c0	0	<a href="#">CSSELR</a>	32-bit	Cache Size Selection Register
c1	0	c0	0	<a href="#">SCTLR</a>	32-bit	System Control Register
			1	<a href="#">ACTLR</a>	32-bit	IMPLEMENTATION DEFINED Auxiliary Control Register
			2	<a href="#">CPACR</a>	32-bit	Coprocessor Access Control Register

**Table B5-11 Summary of PMSA CP15 register descriptions, in coprocessor register number order (continued)**

CRn	opc1	CRm	opc2	Name	Width	Description
c5	0	c0	0	DFSR	32-bit	Data Fault Status Register
			1	IFSR	32-bit	Instruction Fault Status Register
c5	0	c1	0	AxFSR	32-bit	ADFSR, Auxiliary Data Fault Status Register
			1		32-bit	AIFSR, Auxiliary Instruction Fault Status Register
c6	0	c0	0	DFAR	32-bit	Data Fault Address Register
			2	IFAR	32-bit	Instruction Fault Address Register
c6	0	c1	0	DRBAR	32-bit	Data Region Base Address Register
			1	IRBAR	32-bit	Instruction Region Base Address Register
			2	DRSR	32-bit	Data Region Size and Enable Register
			3	IRSR	32-bit	Instruction Region Size and Enable Register
			4	DRACR	32-bit	Data Region Access Control Register
			5	IRACR	32-bit	Instruction Region Access Control Register
c6	0	c2	0	RGNR	32-bit	MPU Region Number Register
c7	0	c0	4	UNPREDICTABLE	32-bit	See <i>Retired operations</i> on page B5-1802
c7	0	c1	0	ICIALUIS <sup>b</sup>	32-bit	See <i>Cache and branch predictor maintenance operations, PMSA</i> on page B6-1941
			6	BPIALLIS <sup>b</sup>	32-bit	
c7	0	c5	0	ICIALLU	32-bit	See <i>Cache and branch predictor maintenance operations, PMSA</i> on page B6-1941
			1	ICIMVAU	32-bit	
			4	CP15ISB	32-bit	See <i>Data and instruction barrier operations, PMSA</i> on page B6-1943
			6	BPIALL	32-bit	See <i>Cache and branch predictor maintenance operations, PMSA</i> on page B6-1941
			7	BPIMVA	32-bit	
c7	0	c6	1	DCIMVAC	32-bit	See <i>Cache and branch predictor maintenance operations, PMSA</i> on page B6-1941
			2	DCISW	32-bit	
c7	0	c10	1	DCCMVAC	32-bit	See <i>Cache and branch predictor maintenance operations, PMSA</i> on page B6-1941
			2	DCCSW	32-bit	
			4	CP15DSB	32-bit	See <i>Data and instruction barrier operations, PMSA</i> on page B6-1943
			5	CP15DMB	32-bit	
c7	0	c11	1	DCCMVAU	32-bit	See <i>Cache and branch predictor maintenance operations, PMSA</i> on page B6-1941
c7	0	c13	1	UNPREDICTABLE	32-bit	See <i>Retired operations</i> on page B5-1802
c7	0	c14	1	DCCIMVAC	32-bit	See <i>Cache and branch predictor maintenance operations, PMSA</i> on page B6-1941
			2	DCCISW	32-bit	

**Table B5-11 Summary of PMSA CP15 register descriptions, in coprocessor register number order (continued)**

CRn	opc1	CRm	opc2	Name	Width	Description
c9	0-7	c0-c2	0-7	-	32-bit	<i>Lockdown and DMA features, functional group on page B5-1800</i>
		c5-c8	0-7	-	32-bit	
c9	0	c12	0	<a href="#">PMCR</a>	32-bit	Performance Monitors Control Register
			1	<a href="#">PMCNTENSET</a>	32-bit	Performance Monitors Count Enable Set register
			2	<a href="#">PMCNTENCLR</a>	32-bit	Performance Monitors Count Enable Clear register
			3	<a href="#">PMOVSr</a>	32-bit	Performance Monitors Overflow Flag Status Register
			4	<a href="#">PMSWINC</a>	32-bit	Performance Monitors Software Increment register
			5	<a href="#">PMSELR</a>	32-bit	Performance Monitors Event Counter Selection Register
			6	<a href="#">PMCEID0</a>	32-bit	Performance Monitors Common Event Identification register 0
			7	<a href="#">PMCEID1</a>	32-bit	Performance Monitors Common Event Identification register 1
c9	0	c13	0	<a href="#">PMCCNTR</a>	32-bit	Performance Monitors Cycle Count Register
			1	<a href="#">PMXEVTYPER</a>	32-bit	Performance Monitors Event Type Select Register
			2	<a href="#">PMXEVCNTR</a>	32-bit	Performance Monitors Event Count Register
c9	0	c14	0	<a href="#">PMUSERENR</a>	32-bit	Performance Monitors User Enable Register
			1	<a href="#">PMINTENSET</a>	32-bit	Performance Monitors Interrupt Enable Set register
			2	<a href="#">PMINTENCLR</a>	32-bit	Performance Monitors Interrupt Enable Clear register
c9	0	c15	0-7	-	32-bit	<i>See Performance Monitors, functional group on page B5-1803</i>
	1-7	c12- c15	0-7	-	32-bit	
c11	0-7	c0-c8	0-7	-	32-bit	<i>See Lockdown and DMA features, functional group on page B5-1800</i>
		c15	0-7	-	32-bit	
c13	0	c0	1	<a href="#">CONTEXTIDR</a>	32-bit	Context ID Register
			2	<a href="#">TPIDRURW</a>	32-bit	User Read/Write Thread ID Register
			3	<a href="#">TPIDRURO</a>	32-bit	User Read-Only Thread ID Register
			4	<a href="#">TPIDRPRW</a>	32-bit	PL1 only Thread ID Register
c14	0	c0	0	<a href="#">CNTFRQ<sup>c</sup></a>	32-bit	Counter Frequency register
-	0	c14	-	<a href="#">CNTPCT<sup>c</sup></a>	64-bit	Physical Count register
c14	0	c1	0	<a href="#">CNTKCTL<sup>c</sup></a>	32-bit	Timer PL1 Control register
			c2	0	<a href="#">CNTP_TVAL<sup>c</sup></a>	32-bit
		c3	1	<a href="#">CNTP_CTL<sup>c</sup></a>	32-bit	PL1 Physical Timer Control register
			0	<a href="#">CNTV_TVAL<sup>c</sup></a>	32-bit	Virtual TimerValue register
			1	<a href="#">CNTV_CTL<sup>c</sup></a>	32-bit	Virtual Timer Control register

**Table B5-11 Summary of PMSA CP15 register descriptions, in coprocessor register number order (continued)**

CRn	opc1	CRm	opc2	Name	Width	Description
-	1	c14	-	CNTVCT <sup>c</sup>	64-bit	Virtual Count register
	2			CNTP_CVAL <sup>c</sup>	64-bit	PL1 Physical Timer CompareValue register1
	3			CNTV_CVAL <sup>c</sup>	64-bit	Virtual Timer CompareValue register
c15	0-7	c0- c15	0-7	-	32-bit	See <i>IMPLEMENTATION DEFINED registers, functional group</i> on page B5-1803

- REVIDR is an optional register. If it is not implemented, the encoding with opc2 set to 6 is an alias of MIDR.
- Added as part of the Multiprocessing Extensions. In earlier ARMv7 implementations, encoding is unallocated and UNPREDICTABLE, see *Accesses to unallocated CP14 and CP15 encodings* on page B5-1774.
- Implemented only as part of the Generic Timers Extension. Otherwise, encoding is unallocated and UNPREDICTABLE, see *Accesses to unallocated CP14 and CP15 encodings* on page B5-1774.

### B5.8.3 Views of the CP15 registers

The following sections summarize the different software views of the CP15 registers, for a PMSA implementation:

- PL0 views of the CP15 registers*
- PL1 views of the CP15 registers* on page B5-1796.

#### PL0 views of the CP15 registers

Software executing at PL0, unprivileged, can access only a small subset of the CP15 registers, as [Table B5-12](#) shows. This table excludes possible PL0 access to CP15 registers that are part of the following OPTIONAL extensions to the architecture:

- the Performance Monitors Extension, see *Possible PL0 access to the Performance Monitors Extension CP15 registers* on page B5-1796
- the Generic Timer Extension, see *Possible PL0 access to the Generic Timer Extension CP15 registers* on page B5-1796.

**Table B5-12 CP15 registers accessible from PL0**

Name	Access	Description	Note
CP15ISB	WO	<i>Data and instruction barrier operations, PMSA</i> on page B6-1943	ARM deprecates use of these operations
CP15DSB	WO		
CP15DMB	WO		
TPIDRURW	RW	<i>TPIDRURW, User Read/Write Thread ID Register, PMSA</i> on page B6-1940	-
TPIDRURO	RO	<i>TPIDRURO, User Read-Only Thread ID Register, PMSA</i> on page B6-1939	RW at PL1

### **Possible PL0 access to the Performance Monitors Extension CP15 registers**

In a PMSAv7 implementation that includes the Performance Monitors Extension, when using CP15 to access the Performance Monitors registers:

- The [PMUSERENR](#) is RO from PL0.
- When [PMUSERENR.EN](#) is set to 1:
  - the [PMCR](#), [PMOVSr](#), [PMSELR](#), [PMCCNTR](#), [PMXEVcntr](#), [PMXEVtyper](#), and the [PMCNTENCLR](#), [PMCNTENSET](#), and [PMSWINC](#) registers, are accessible from PL0
  - if the implementation includes PMUv2, the [PMCEID<sub>n</sub>](#) registers are accessible from PL0.
- When [PMUSERENR.EN](#) is set to 1, these registers have the same access permissions from PL0 as they do from PL1.

For more information, see [CP15 c9 performance monitors registers](#) on page C12-2326 and [Access permissions](#) on page C12-2328.

### **Possible PL0 access to the Generic Timer Extension CP15 registers**

In a PMSAv7 implementation that includes the Generic Timer Extension, when using CP15 to access the Generic Timer registers:

- If [CNTKCTL.PL0PCTEN](#) is set to 1, the physical counter register [CNTPCT](#) is accessible from PL0. For more information see [Accessing the physical counter](#) on page B8-1960.
- If [CNTKCTL.PL0PV TEN](#) is set to 1, the virtual counter register [CNTVCT](#) is accessible from PL0. For more information, see [Accessing the virtual counter](#) on page B8-1961.
- If at least one of [CNTKCTL.{PL0PCTEN, PL0PV TEN}](#) is set to 1, the [CNTFRQ](#) register is RO from PL0.
- If:
  - [CNTKCTL.PL0PTEN](#) is set to 1, the physical timer registers [CNTP\\_CTL](#), [CNTP\\_CVAL](#), and [CNTP\\_TVAL](#) are accessible from PL0
  - [CNTKCTL.PL0VTEN](#) is set to 1, the virtual timer registers [CNTV\\_CTL](#), [CNTV\\_CVAL](#), and [CNTV\\_TVAL](#), are accessible from PL0.

For more information, see [Accessing the timer registers](#) on page B8-1964.

### **PL1 views of the CP15 registers**

Software executing at PL1 can access all implemented CP15 registers.

#### **Note**

- See [Full list of PMSA CP15 registers, by coprocessor register number](#) on page B5-1792.
- PMSA cannot include the Security Extensions, or the Virtualization Extensions, or any associated registers.



## B5.9 Functional grouping of PMSAv7 system control registers

This section describes how the system control registers in a PMSAv7 implementation divide into functional groups. [Chapter B6 System Control Registers in a PMSA implementation](#) describes these registers, in alphabetical order of the register names.

These registers are implemented in the CP15 System Control Coprocessor. Therefore, these sections and chapters describe the CP15 registers for a PMSAv7 implementation.

In addition, [Table B5-11 on page B5-1792](#) lists all of the CP15 registers in a PMSAv7 implementation, ordered by:

1. The CP15 primary register used when accessing the register. This is the CRn value for an access to a 32-bit register, or the CRm value for an access to a 64-bit register.

———— **Note** ————

A PMSAv7 implementation includes 64-bit registers only if it includes the OPTIONAL Generic Timer Extension. In that case, the implemented 64-bit registers are part of that extension.

2. The opc1 value used when accessing the register.
3. For 32-bit registers, the {CRm, opc2} values used when accessing the register.

Entries in this table index the detailed description of each register.

An ARMv7 implementation with a VMSA also implements some of the registers described in this chapter. For more information, see [Functional grouping of VMSAv7 system control registers on page B3-1491](#).

For other related information see:

- [Coprocessors and system control on page B1-1225](#) for general information about the System Control Coprocessor, CP15 and the register access instructions MRC and MCR.
- [About the system control registers for PMSA on page B5-1772](#) for general information about the CP15 registers in a PMSA implementation, including:
  - their organization, both by CP15 primary registers c0 to c15, and by function
  - their general behavior
  - the effect of different ARMv7 architecture extensions on the registers
  - different views of the registers, that depend on the state of the processor
  - conventions used in describing the registers.

The remainder of this chapter, and [Chapter B6 System Control Registers in a PMSA implementation](#), assumes you are familiar with [About the system control registers for PMSA on page B5-1772](#), and uses conventions and other information from that section without any explanation.

Each of the following sections summarizes a functional group of PMSA system control registers:

- [Identification registers, functional group on page B5-1798](#)
- [MMU control registers, functional group on page B5-1799](#)
- [PL1 Fault handling registers, functional group on page B5-1799](#)
- [Other system control registers, functional group on page B5-1800](#)
- [Lockdown and DMA features, functional group on page B5-1800](#)
- [Cache maintenance operations, functional group on page B5-1801](#)
- [Miscellaneous operations, functional group on page B5-1802](#)
- [Performance Monitors, functional group on page B5-1803](#)
- [Generic Timer Extension registers on page B5-1803](#)
- [IMPLEMENTATION DEFINED registers, functional group on page B5-1803](#).

### B5.9.1 Identification registers, functional group

Table B5-13 shows the identification registers in a PMSA implementation.

**Table B5-13 Identification registers, PMSA**

Name	CRn	opc1	CRm	opc2	Width	Type	Description
AIDR	c0	1	c0	7	32-bit	RO	IMPLEMENTATION DEFINED Auxiliary ID Register
CCSIDR	c0	1	c0	0	32-bit	RO	Cache Size ID Registers
CLIDR	c0	1	c0	1	32-bit	RO	Cache Level ID Register
CSSELR	c0	2	c0	0	32-bit	RW	Cache Size Selection Register
CTR	c0	0	c0	1	32-bit	RO	Cache Type Register
ID_AFR0	c0	0	c1	3	32-bit	RO	Auxiliary Feature Register 0 <sup>a</sup>
ID_DFR0	c0	0	c1	2	32-bit	RO	Debug Feature Register 0 <sup>a</sup>
ID_ISAR0	c0	0	c2	0	32-bit	RO	Instruction Set Attribute Register 0 <sup>a</sup>
ID_ISAR1	c0	0	c2	1	32-bit	RO	Instruction Set Attribute Register 1 <sup>a</sup>
ID_ISAR2	c0	0	c2	2	32-bit	RO	Instruction Set Attribute Register 2 <sup>a</sup>
ID_ISAR3	c0	0	c2	3	32-bit	RO	Instruction Set Attribute Register 3 <sup>a</sup>
ID_ISAR4	c0	0	c2	4	32-bit	RO	Instruction Set Attribute Register 4 <sup>a</sup>
ID_ISAR5	c0	0	c2	5	32-bit	RO	Instruction Set Attribute Register 5 <sup>a</sup>
ID_MMFR0	c0	0	c1	4	32-bit	RO	Memory Model Feature Register 0 <sup>a</sup>
ID_MMFR1	c0	0	c1	5	32-bit	RO	Memory Model Feature Register 1 <sup>a</sup>
ID_MMFR2	c0	0	c1	6	32-bit	RO	Memory Model Feature Register 2 <sup>a</sup>
ID_MMFR3	c0	0	c1	7	32-bit	RO	Memory Model Feature Register 3 <sup>a</sup>
ID_PFR0	c0	0	c1	0	32-bit	RO	Processor Feature Register 0 <sup>a</sup>
ID_PFR1	c0	0	c1	1	32-bit	RO	Processor Feature Register 1 <sup>a</sup>
MIDR	c0	0	c0	0	32-bit	RO	Main ID Register
MPIDR	c0	0	c0	5	32-bit	RO	Multiprocessor Affinity Register
MPUIR	c0	0	c0	4	32-bit	RO	MPU Type Register
REVIDR	c0	0	c0	6	32-bit	RO	Revision ID Register
TCMTR	c0	0	c0	2	32-bit	RO	TCM Type Register

a. CPUID register, see also [Chapter B7 The CPUID Identification Scheme](#).

The FPSID, MVFR0, MVFR1, and JIDR hold additional identification information.

## B5.9.2 MMU control registers, functional group

Table B5-14 shows the MMU control registers in a PMSA implementation.

**Table B5-14 MMU control registers, PMSA**

Name	CRn	opc1	CRm	opc2	Width	Type	Description
CONTEXTIDR	c13	0	c0	1	32-bit	RW	Context ID Register
DRACR	c6	0	c1	4	32-bit	RW	Data Region Access Control Register
DRBAR	c6	0	c1	0	32-bit	RW	Data Region Base Address Register
DRSR	c6	0	c1	2	32-bit	RW	Data Region Size and Enable Register
IRACR	c6	0	c1	5	32-bit	RW	Instruction Region Access Control Register
IRBAR	c6	0	c1	1	32-bit	RW	Instruction Region Base Address Register
IRSR	c6	0	c1	3	32-bit	RW	Instruction Region Size and Enable Register
RGNR	c6	0	c2	0	32-bit	RW	MPU Region Number Register
SCTLR	c1	0	c0	0	32-bit	RW	System Control Register

## B5.9.3 PL1 Fault handling registers, functional group

Table B5-15 shows the PL1 Fault handling registers in a PMSA implementation.

**Table B5-15 Fault handling registers, PMSA**

Name	CRn	opc1	CRm	opc2	Width	Type	Description
AxFSR	c5	0	c1	0	32-bit	RW	Auxiliary Data Fault Status Register
				1	32-bit	RW	Auxiliary Instruction Fault Status Register
DFAR	c6	0	c0	0	32-bit	RW	Data Fault Address Register
DFSR	c5	0	c0	0	32-bit	RW	Data Fault Status Register
IFAR	c6	0	c0	2	32-bit	RW	Instruction Fault Address Register
IFSR	c5	0	c0	1	32-bit	RW	Instruction Fault Status Register

The processor returns fault information using the fault status registers and the fault address registers. For details of how these registers are used see [Exception reporting in a PMSA implementation on page B5-1767](#).

### Note

- These registers also report information about debug exceptions. For more information see [Data Abort exceptions on page B5-1767](#) and [Prefetch Abort exceptions on page B5-1769](#).
- Before ARMv7:
  - The DFAR was called the *Fault Address Register*, FAR.
  - The *Watchpoint Fault Address Register*, DBGWFAR, was implemented in CP15 c6, with <opc2> = 1. In ARMv7, the DBGWFAR is only implemented as a CP14 debug register.

### B5.9.4 Other system control registers, functional group

Table B5-16 shows the Other system control registers in a PMSA implementation.

**Table B5-16 Other system control registers, PMSA**

Name	CRn	opc1	CRm	opc2	Width	Type	Description
<a href="#">ACTLR</a>	c1	0	c0	1	32-bit	RW	IMPLEMENTATION DEFINED Auxiliary Control Register
<a href="#">CPACR</a>	c1	0	c0	2	32-bit	RW	Coprocessor Access Control Register

### B5.9.5 Lockdown and DMA features, functional group

Table B5-17 shows the Lockdown and DMA features registers in a PMSA implementation.

**Table B5-17 Lockdown and DMA features, PMSA**

Name	CRn	opc1	CRm	opc2	Width	Type	Description
IMPLEMENTATION DEFINED	c9	0-7	c0-c2	0-7	32-bit	a	<a href="#">Cache and TCM lockdown registers, PMSA on page B6-1944</a>
			c5-c8	0-7	32-bit	a	
	c11	0-7	c0-c8	0-7	32-bit	a	<a href="#">DMA support, PMSA on page B6-1945</a>
			c15	0-7	32-bit	a	

a. Access depends on the register or operation, and is IMPLEMENTATION DEFINED.

## B5.9.6 Cache maintenance operations, functional group

Table B5-18 shows the Cache and branch predictor maintenance operations in a PMSA implementation.

**Table B5-18 Cache and branch predictor maintenance operations, PMSA**

Name	CRn	opc1	CRm	opc2	Width	Type	Description	Limits <sup>a</sup>
<a href="#">BPIALL</a> <sup>c</sup>	c7	0	c5	6	32-bit	WO	Branch predictor invalidate all	-
<a href="#">BPIALLIS</a> <sup>b, c</sup>	c7	0	c1	6	32-bit	WO	Branch predictor invalidate all	IS
<a href="#">BPIMVA</a> <sup>c</sup>	c7	0	c5	7	32-bit	WO	Branch predictor invalidate by address	-
<a href="#">DCCIMVAC</a> <sup>c</sup>	c7	0	c14	1	32-bit	WO	Data cache clean and invalidate by address	PoC
<a href="#">DCCISW</a> <sup>c</sup>	c7	0	c14	2	32-bit	WO	Data cache clean and invalidate by set/way	-
<a href="#">DCCMVAC</a> <sup>c</sup>	c7	0	c10	1	32-bit	WO	Data cache clean by address	PoC
<a href="#">DCCMVAU</a> <sup>c</sup>	c7	0	c11	1	32-bit	WO	Data cache clean by address	PoU
<a href="#">DCCSW</a> <sup>c</sup>	c7	0	c10	2	32-bit	WO	Data cache clean by set/way	-
<a href="#">DCIMVAC</a> <sup>c</sup>	c7	0	c6	1	32-bit	WO	Data cache invalidate by address	PoC
<a href="#">DCISW</a> <sup>c</sup>	c7	0	c6	2	32-bit	WO	Data cache invalidate by set/way	-
<a href="#">ICIALLU</a> <sup>c</sup>	c7	0	c5	0	32-bit	WO	Instruction cache invalidate all	PoU
<a href="#">ICIALLUIS</a> <sup>b, c</sup>	c7	0	c1	0	32-bit	WO	Instruction cache invalidate all	PoU, IS
<a href="#">ICIMVAU</a> <sup>c</sup>	c7	0	c5	1	32-bit	WO	Instruction cache invalidate by address	PoU

a. PoU = to Point of Unification, PoC = to Point of Coherence, IS = Inner Shareable.

b. Introduced in the Multiprocessing Extensions, UNPREDICTABLE in earlier ARMv7 implementations, see [Accesses to unallocated CP14 and CP15 encodings on page B5-1774](#).

c. The links in this column are to a summary of the operation. [Cache and branch predictor maintenance operations, PMSA on page B6-1941](#).

As stated in the table footnote, [Cache and branch predictor maintenance operations, PMSA on page B6-1941](#) describes these operations.

## B5.9.7 Miscellaneous operations, functional group

Table B5-19 shows the Miscellaneous operations in a PMSA implementation.

The only UNPREDICTABLE encodings shown in the table are those that had defined functions in ARMv6.

**Table B5-19 Miscellaneous system control operations, PMSA**

Name	CRn	opc1	CRm	opc2	Width	Type <sup>a</sup>	Description
CP15DMB	c7	0	c10	5	32-bit	WO, PL0	<i>Data and instruction barrier operations, PMSA on page B6-1943</i>
CP15DSB	c7	0	c10	4	32-bit	WO, PL0	
CP15ISB	c7	0	c5	4	32-bit	WO, PL0	
TPIDRPRW	c13	0	c0	4	32-bit	RW	PL1 only Thread ID Register
TPIDRURO	c13	0	c0	3	32-bit	RW, PL0	User Read-Only Thread ID Register
TPIDRURW	c13	0	c0	2	32-bit	RW, PL0	User Read/Write Thread ID Register
UNPREDICTABLE	c7	0	c0	4	32-bit	WO	<i>Retired operations</i>
			c13	1	32-bit	WO	

a. PL0 = Accessible from unprivileged software, that is, from software executing at PL0. See the register description for more information.

### Retired operations

ARMv6 includes two CP15 c7 operations that are not supported in ARMv7, with encodings that become UNPREDICTABLE in ARMv7. These are the ARMv6:

- *Wait For Interrupt* (CP15WFI) operation. In ARMv7 this operation is performed by the WFI instruction, that is available in the ARM and Thumb instruction sets. For more information, see [WFI on page A8-1106](#).
- Prefetch instruction by MVA operation. In ARMv7 this operation is replaced by the PLI instruction, that is available in the ARM and Thumb instruction sets. For more information, see [PLI \(immediate, literal\) on page A8-530](#), and [PLI \(register\) on page A8-532](#).

In ARMv7, the CP15 c7 encodings that were used for these operations are UNPREDICTABLE. These encodings are:

- for the ARMv6 CP15WFI operation:
  - an MCR instruction with <opc1> set to 0, <CRn> set to c7, <CRm> set to c0, and <opc2> set to 4
- for the ARMv6 Prefetch instruction by MVA operation:
  - an MCR instruction with <opc1> set to 0, <CRn> set to c7, <CRm> set to c13, and <opc2> set to 1.

#### ———— Note —————

In some ARMv7 implementations, these encodings are write-only operations that perform a NOP.

## B5.9.8 Performance Monitors, functional group

Table B5-20 shows the performance monitor register encodings in a PMSA implementation.

**Table B5-20 Performance monitors, PMSA**

CRn	opc1	CRm	opc2	Name	Width	Type	Description
c9	0-7	c12-c14	0-7	See <i>Performance Monitors registers on page C12-2326</i> <sup>a</sup>	32-bit	RW or RO <sup>b</sup>	<i>Performance monitors</i>
		c15	0-7	IMPLEMENTATION DEFINED	32-bit	c	

- The referenced section describes the registers defined by the recommended Performance Monitors Extension.
- The section referenced in footnote <sup>a</sup> shows the type of each of the recommended Performance Monitors Extension registers.
- Access depends on the register or operation, and is IMPLEMENTATION DEFINED.

### Performance monitors

ARMv7 reserves some encodings in the system control register space for performance monitors. These provide encodings for:

- The OPTIONAL Performance Monitors Extension registers, summarized in *Chapter C12 The Performance Monitors Extension*.
- Optional additional IMPLEMENTATION DEFINED performance monitors. Table B5-20 shows these reserved encodings.

## B5.9.9 Generic Timer Extension registers

ARMv7 reserves CP15 primary coprocessor register c14 for access to the Generic Timer Extension registers. For more information about these registers see *Generic Timer registers summary on page B8-1967*.

## B5.9.10 IMPLEMENTATION DEFINED registers, functional group

ARMv7 reserves CP15 c15 for IMPLEMENTATION DEFINED purposes, and does not impose any restrictions on the use of the CP15 c15 encodings. The documentation of the ARMv7 implementation must describe fully any registers implemented in CP15 c15. Normally, for processor implementations by ARM, this information is included in the *Technical Reference Manual* for the processor.

Typically, an implementation uses CP15 c15 to provide test features, and any required configuration options that are not covered by this manual.

## B5.10 Pseudocode details of PMSA memory system operations

This section contains pseudocode describing PMSA-specific memory operations. The following subsections describe the pseudocode functions:

- [Alignment fault](#)
- [Address translation](#)
- [Default memory map attributes on page B5-1805](#).

See also the pseudocode for general memory system operations in [Pseudocode details of general memory system operations on page B2-1292](#).

### B5.10.1 Alignment fault

The following pseudocode describes the Alignment fault in a PMSA implementation:

```
// AlignmentFaultP()
// =====

AlignmentFaultP(bits(32) address, boolean iswrite)

    // fixed values for calling DataAbort
    bits(40) ipaddress = bits(40) UNKNOWN;
    bits(4) domain = bits(4) UNKNOWN;
    integer level = integer UNKNOWN;
    boolean taketohypmode = FALSE;
    boolean secondstageabort = FALSE;
    boolean ipavalid = FALSE;
    boolean LDFSRformat = FALSE;
    boolean s2fs1walk = FALSE;

    DataAbort(address, ipaddress, domain, level, iswrite, DAbort_Alignment,
              taketohypmode, secondstageabort, ipavalid, LDFSRformat, s2fs1walk);
```

### B5.10.2 Address translation

The following pseudocode describes address translation in a PMSA implementation:

```
// TranslateAddressP()
// =====

AddressDescriptor TranslateAddressP(bits(32) va, boolean ispriv, boolean iswrite)

    AddressDescriptor result;
    Permissions perms;

    // PMSA only does flat mapping and security domain is effectively
    // IMPLEMENTATION DEFINED.
    result.paddress.physicaladdress = '00000000':va;
    IMPLEMENTATION_DEFINED setting of result.paddress.NS;

    if SCTL.R.M == 0 then // MPU is disabled
        result.memAttrs = DefaultMemoryAttributes(va);
    else // MPU is enabled
        // Scan through regions looking for matching ones. If found, the last
        // one matched is used.
        region_found = FALSE;

        for r = 0 to UInt(MPUIR.DRegion) - 1
            size_enable = DRSR[r];
            base_address = DRBAR[r];
            access_control = DRACR[r];

            if size_enable<0> == '1' then // Region is enabled
                lsbite = UInt(size_enable<5:1>) + 1;
                if lsbite < 2 then UNPREDICTABLE;
```



```

if lsbite > 2 && IsZero(base_address<lsbite-1:2>) == FALSE then
    UNPREDICTABLE;

if lsbite == 32 || va<31:lsbite> == base_address<31:lsbite> then
    if lsbite >= 8 then // can have subregions
        subregion = UInt(va<lsbite-1:lsbite-3>);
        hit = (size_enable<subregion+8> == '0');
    else
        hit = TRUE;

    if hit then
        texcb = access_control<5:3,1:0>;
        S = access_control<2>;
        perms.ap = access_control<10:8>;
        perms.xn = access_control<12>;
        region_found = TRUE;

// Generate the memory attributes, and also the permissions if no region found.
if region_found then
    result.memattrs = DefaultTEXDecode(texcb, S);
else
    if SCTL.R.BR == '0' || !ispriv then
        // fixed values for calling DataAbort
        ipaddress = bits(40) UNKNOWN;
        domain = bits(4) UNKNOWN;
        level = integer UNKNOWN;
        taketohypmode = FALSE;
        secondstageabort = FALSE;
        ipavalid = FALSE;
        LDFSRformat = FALSE;
        s2fs1walk = FALSE;
        DataAbort(address, ipaddress, domain, level, iswrite,
            DAbort_Background, taketohypmode, secondstageabort,
            ipavalid, LDFSRformat, s2fs1walk);
    else
        result.memattrs = DefaultMemoryAttributes(va);
        perms.ap = '011';
        perms.xn = if va<31:28> == '1111' then NOT(SCTL.R.V) else va<31>;
        perms.pxn = FALSE;

// Check the permissions.
CheckPermission(perms, VA, integer UNKNOWN, bits(4) UNKNOWN, swrite, ispriv,
    FALSE, FALSE);

return result;
    
```

### B5.10.3 Default memory map attributes

The following pseudocode describes the default memory map attributes in a PMSA implementation:

```

// DefaultMemoryAttributes()
// =====

MemoryAttributes DefaultMemoryAttributes(bits(32) va)

MemoryAttributes memattrs;

case va<31:30> of
    when '00'
        if SCTL.R.C == '0' then
            memattrs.type = MemType_Normal;
            memattrs.innerattrs = '00'; // Non-cacheable
            memattrs.shareable = TRUE;
        else
            memattrs.type = MemType_Normal;
            memattrs.innerattrs = '01'; // Write-Back Write-Allocate cacheable
            memattrs.shareable = FALSE;
    
```

```
when '01'  
  if SCTL.R.C == '0' || va<29> == '1' then  
    memattrs.type = MemType_Normal;  
    memattrs.innerattrs = '00'; // Non-cacheable  
    memattrs.shareable = TRUE;  
  else  
    memattrs.type = MemType_Normal;  
    memattrs.innerattrs = '10'; // Write-Through cacheable  
    memattrs.shareable = FALSE;  
when '10'  
  memattrs.type = MemType_Device;  
  memattrs.innerattrs = '00'; // Non-cacheable  
  memattrs.shareable = (va<29> == '1');  
when '11'  
  memattrs.type = MemType_StronglyOrdered;  
  memattrs.innerattrs = '00'; // Non-cacheable  
  memattrs.shareable = TRUE;  
  
// Outer attributes are the same as the inner attributes in all cases.  
memattrs.outerattrs = memattrs.innerattrs;  
memattrs.outershareable = memattrs.shareable;  
  
return memattrs;
```

# Chapter B6

## System Control Registers in a PMSA implementation

This chapter describes the system control registers in a PMSA implementation. The registers are described in alphabetic order. The chapter contains the following section. It contains the following section:

- [PMSA System control registers descriptions, in register order on page B6-1808](#)
- [PMSA system control operations described by function on page B6-1941.](#)

———— **Note** —————

The architecture defines some registers identically for VMSSAv7 and PMSAv7 implementations. Those registers are described fully both in this chapter and in [Chapter B4 System Control Registers in a VMSSA implementation](#).

---

## B6.1 PMSA System control registers descriptions, in register order

This section describes all of the system control registers that might be present in a PMSAv7 implementation, including registers that are part of an OPTIONAL architecture extension. Registers are shown in register name order.

Some register encodings provide functions that form part of a closely-related functional group, for example, the encodings for cache maintenance operations. [PMSA system control operations described by function on page B6-1941](#) describes these operations. However, operations that have an architecturally-defined name also have an alphabetic entry in [PMSA System control registers descriptions, in register order](#). For example, the DCCISW cache maintenance operation has a short entry in this section, [DCISW, Data Cache Invalidate by Set/Way, PMSA on page B6-1835](#), that references its full description in [Cache and branch predictor maintenance operations, PMSA on page B6-1941](#).

### B6.1.1 ACTLR, IMPLEMENTATION DEFINED Auxiliary Control Register, PMSA

The ACTLR characteristics are:

<b>Purpose</b>	The ACTLR provides IMPLEMENTATION DEFINED configuration and control options. This register is part of the Other system control registers functional group.
<b>Usage constraints</b>	Only accessible from PL1.
<b>Configurations</b>	Always implemented.
<b>Attributes</b>	A 32-bit RW register. Because the register is IMPLEMENTATION DEFINED, the register reset value is IMPLEMENTATION DEFINED. See also <a href="#">Reset behavior of CP14 and CP15 registers on page B5-1776</a> . <a href="#">Table B5-16 on page B5-1800</a> shows the encodings of all of the registers in the Other system control registers functional group.

The contents of this register are IMPLEMENTATION DEFINED. ARMv7 requires this register to be PL1 read/write accessible, even if the implementation has not created any control bits in this register.

#### Accessing the ACTLR

To access the ACTLR, software reads or writes the CP15 registers with <opc1> set to 0, <CRn> set to c1, <CRm> set to c0, and <opc2> set to 1. For example:

```
MRC p15, 0, <Rt>, c1, c0, 1 ; Read ACTLR into Rt  
MCR p15, 0, <Rt>, c1, c0, 1 ; Write Rt to ACTLR
```

## B6.1.2 AIDR, IMPLEMENTATION DEFINED Auxiliary ID Register, PMSA

The AIDR characteristics are:

<b>Purpose</b>	Provides IMPLEMENTATION DEFINED ID information. This register is part of the Identification registers functional group.
<b>Usage constraints</b>	Only accessible from PL1. The value of this register must be used in conjunction with the value of <a href="#">MIDR</a> .
<b>Configurations</b>	This register is not implemented in architecture versions before ARMv7.
<b>Attributes</b>	A 32-bit RO register with an IMPLEMENTATION DEFINED value. See also <a href="#">Reset behavior of CP14 and CP15 registers on page B5-1776</a> . <a href="#">Table B5-13 on page B5-1798</a> shows the encodings of all of the registers in the Identification registers functional group.

The AIDR bit assignments are IMPLEMENTATION DEFINED.

### Accessing the AIDR

To access the AIDR, software reads the CP15 registers with <opc1> set to 1, <CRn> set to c0, <CRm> set to c0, and <opc2> set to 7. For example:

```
MRC p15, 1, <Rt>, c0, c0, 7 ; Read AIDR into Rt
```

### B6.1.3 ADFSR and AIFSR, Auxiliary Data and Instruction Fault Status Registers, PMSA

The AxFSR characteristics are:

<b>Purpose</b>	The ADFSR and AIFSR can return additional IMPLEMENTATION DEFINED fault status information, see <a href="#">Auxiliary Fault Status Registers on page B5-1771</a> . These registers are part of the PL1 Fault handling registers functional group.
<b>Usage constraints</b>	Only accessible from PL1.
<b>Configurations</b>	These registers are not implemented in architecture versions before ARMv7.
<b>Attributes</b>	32-bit RW registers. Because these registers are IMPLEMENTATION DEFINED, the reset values are IMPLEMENTATION DEFINED. See also <a href="#">Reset behavior of CP14 and CP15 registers on page B5-1776</a> . <a href="#">Table B5-15 on page B5-1799</a> shows the encodings of all of the registers in the PL1 Fault handling registers functional group.

The AxFSR bit assignments are IMPLEMENTATION DEFINED.

#### Accessing the ADFSR and AIFSR

To access the AxFSR registers, software reads or writes the CP15 registers with <opc1> set to 0, <CRn> set to c5, <CRm> set to c1, and <opc2> set to:

- 0 for the ADFSR
- 1 for the AIFSR.

For example:

```
MRC p15, 0, <Rt>, c5, c1, 0 ; Read ADFSR into Rt
MCR p15, 0, <Rt>, c5, c1, 0 ; Write Rt to ADFSR
MRC p15, 0, <Rt>, c5, c1, 1 ; Read AIFSR into Rt
MCR p15, 0, <Rt>, c5, c1, 1 ; Write Rt to AIFSR
```

#### **B6.1.4 BPIALL, Branch Predictor Invalidate All, PMSA**

*Cache and branch predictor maintenance operations, PMSA on page B6-1941* describes this cache maintenance operation.

This operation is part of the Cache maintenance operations functional group. [Table B5-18 on page B5-1801](#) shows the encodings of all of the registers and operations in this functional group.

#### **B6.1.5 BPIALLIS, Branch Predictor Invalidate All, Inner Shareable, PMSA**

*Cache and branch predictor maintenance operations, PMSA on page B6-1941* describes this cache maintenance operation.

This operation is part of the Cache maintenance operations functional group. [Table B5-18 on page B5-1801](#) shows the encodings of all of the registers and operations in this functional group.

#### **B6.1.6 BPIMVA, Branch Predictor Invalidate by MVA, PMSA**

*Cache and branch predictor maintenance operations, PMSA on page B6-1941* describes this cache maintenance operation.

This operation is part of the Cache maintenance operations functional group. [Table B5-18 on page B5-1801](#) shows the encodings of all of the registers and operations in this functional group.





**LineSize, bits[2:0]**

( $\text{Log}_2(\text{Number of words in cache line})$ )–2. For example:

- For a line length of 4 words:  $\text{Log}_2(4) = 2$ , LineSize entry = 0.  
This is the minimum line length.
- For a line length of 8 words:  $\text{Log}_2(8) = 3$ , LineSize entry = 1.

**Accessing the currently selected CCSIDR**

The **CSSELR** selects a CCSIDR. To access the currently-selected CCSIDR, software reads the CP15 registers with <opc1> set to 1, <CRn> set to c0, <CRm> set to c0, and <opc2> set to 0. For example:

MRC p15, 1, <Rt>, c0, c0, 0 ; Read current CCSIDR into Rt

Any access to the CCSIDR when the value in **CSSELR** corresponds to a cache that is not implemented returns an UNKNOWN value.

## B6.1.8 CLIDR, Cache Level ID Register, PMSA

The CLIDR characteristics are:

<b>Purpose</b>	Identifies: <ul style="list-style-type: none"> <li>• the type of cache, or caches, implemented at each level, up to a maximum of seven levels</li> <li>• the Level of Coherency and Level of Unification for the cache hierarchy.</li> </ul> This register is part of the Identification registers functional group.
<b>Usage constraints</b>	Only accessible from PL1.
<b>Configurations</b>	This register is not implemented in architecture versions before ARMv7.
<b>Attributes</b>	A 32-bit RO register with an IMPLEMENTATION DEFINED value. See also <a href="#">Reset behavior of CP14 and CP15 registers on page B5-1776</a> . <a href="#">Table B5-13 on page B5-1798</a> shows the encodings of all of the registers in the Identification registers functional group.

The CLIDR bit assignments are:

31	30	29	27	26	24	23	21	20	18	17	15	14	12	11	9	8	6	5	3	2	0	
(0)	(0)	LoUU	LoC	LoUIS	Ctype7	Ctype6	Ctype5	Ctype4	Ctype3	Ctype2	Ctype1											

**Bits[31:30]** Reserved, UNK.

### LoUU, bits[29:27]

Level of Unification Uniprocessor for the cache hierarchy, see [Terminology for Clean, Invalidate, and Clean and Invalidate operations on page B2-1275](#).

### LoC, bits[26:24]

Level of Coherency for the cache hierarchy, see [Terminology for Clean, Invalidate, and Clean and Invalidate operations on page B2-1275](#).

### LoUIS, bits[23:21]

Level of Unification Inner Shareable for the cache hierarchy, see [Terminology for Clean, Invalidate, and Clean and Invalidate operations on page B2-1275](#).

In an implementation that does not include the Multiprocessing Extensions, this field is RAZ.

### CtypeX, bits[3(x-1) + 2:3(x-1)], for x = 1 to 7

Cache type fields. Indicate the type of cache implemented at each level, from Level 1 up to a maximum of seven levels of cache hierarchy. The Level 1 cache type field, Ctype1, is bits[2:0], see register diagram. [Table B6-2](#) shows the possible values for each CtypeX field.

**Table B6-2 Ctype bit values**

CtypeX bits	Meaning, cache implemented at this level
000	No cache
001	Instruction cache only
010	Data cache only
011	Separate instruction and data caches
100	Unified cache
101, 11X	Reserved

If software read the Cache type fields from Ctype1 upwards, once it has seen a value of 0b000, no caches exist at further-out levels of the hierarchy. So, for example, if Ctype3 is the first Cache type field with a value of 0b000, the values of Ctype4 to Ctype7 must be ignored.

The CLIDR describes only the caches that are under the control of the processor.

### **Accessing the CLIDR**

To access the CLIDR, software reads the CP15 registers with <opc1> set to 1, <CRn> set to c0, <CRm> set to c0, and <opc2> set to 1. For example:

```
MRC p15, 1, <Rt>, c0, c0, 1 ; Read CLIDR into Rt
```

### B6.1.9 CNTFRQ, Counter Frequency register, PMSA

The CNTFRQ register characteristics are:

- Purpose** The CNTFRQ register indicates the clock frequency of the system counter.  
This register is a Generic Timer register.
- Usage constraints** The CNTFRQ register is accessible:
  - as RW from PL1 modes
  - when CNTKCTL.{PLOVCTEN, PLOPCTEN} is not set to 0b00, as RO from User mode.
- Configurations** Implemented only as part of the Generic Timers Extension.  
The VMSA, PMSA, and system level definitions of the register fields are identical.
- Attributes** A 32-bit RW register with an UNKNOWN reset value.  
[Table B8-2 on page B8-1967](#) shows the encodings of all of the Generic Timer registers.

The CNTFRQ register bit assignments are:

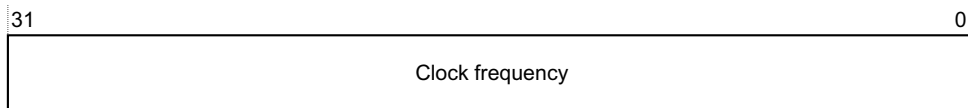

#### Clock frequency, bits[31:0]

Indicates the system counter clock frequency, in Hz.

———— **Note** ————

Programming CNTFRQ does not affect the system clock frequency. However, on system initialization, CNTFRQ must be correctly programmed with the system clock frequency, to make this value available to software. For more information see [Initializing and reading the system counter frequency on page B8-1959](#).

#### Accessing the CNTFRQ register

To access the CNTFRQ register, software reads or writes the CP15 registers with <opc1> set to 0, <CRn> set to c14, <CRm> set to c0, and <opc2> set to 0. For example:

```
MRC p15, 0, <Rt>, c14, c0, 0 ; Read CNTFRQ into Rt
MCR p15, 0, <Rt>, c14, c0, 0 ; Write Rt to CNTFRQ
```

## B6.1.10 CNTKCTL, Timer PL1 Control register, PMSA

The CNTKCTL register characteristics are:

- Purpose** The CNTKCTL register controls:
- access to the following from PL0 modes:
    - the physical counter
    - the virtual counter
    - the PL1 physical timers
    - the virtual timer.
  - the generation of an event stream from the virtual counter.

This register is a Generic Timer register.

**Usage constraints** The CNTKCTL register is accessible only from PL1 modes.

**Configurations** Implemented only as part of the Generic Timers Extension.  
 The VMSA and PMSA definitions of the register fields are identical.  
 If the implementation includes the Security Extensions, this register is Common.

**Attributes** A 32-bit RW register. See the field descriptions for information about the reset values.  
[Table B8-2 on page B8-1967](#) shows the encodings of all of the Generic Timer registers.

In an ARMv7 implementation, the CNTKCTL register bit assignments are:

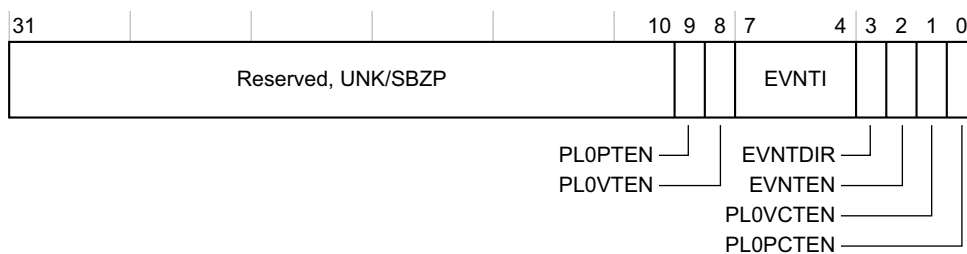

**Bits[31:10]** Reserved, UNK/SBZP.

**PL0PTEN, bit[9]** Controls whether the physical timer registers are accessible from PL0 modes:

- 0** The [CNTP\\_CVAL](#), [CNTP\\_CTL](#), and [CNTP\\_TVAL](#) registers are not accessible from PL0.
- 1** The [CNTP\\_CVAL](#), [CNTP\\_CTL](#), and [CNTP\\_TVAL](#) registers are accessible from PL0.

This bit resets to 0.

For more information see [Accessing the timer registers on page B8-1964](#).

**PL0VTEN, bit[8]** Controls whether the virtual timer registers are accessible from PL0 modes:

- 0** The [CNTV\\_CVAL](#), [CNTV\\_CTL](#), and [CNTV\\_TVAL](#) registers are not accessible from PL0.
- 1** The [CNTV\\_CVAL](#), [CNTV\\_CTL](#), and [CNTV\\_TVAL](#) registers are accessible from PL0.

This bit resets to 0.

For more information see [Accessing the timer registers on page B8-1964](#).

**EVNTI, bits[7:4]** Selects which bit of [CNTVCT](#) is the trigger for the event stream generated from the virtual counter, when that stream is enabled. For example, if this field is 0b0110, [CNTVCT](#)[6] is the trigger bit for the virtual counter event stream.

This field is UNKNOWN on reset.

For more information see [Event streams on page B8-1962](#).

- EVNTDIR, bit[3]** Controls which transition of the **CNTVCT** trigger bit, defined by EVNTI, generates an event, when the event stream is enabled:
- 0** A 0 to 1 transition of the trigger bit triggers an event.
  - 1** A 1 to 0 transition of the trigger bit triggers an event.
- This bit is UNKNOWN on reset.  
For more information see [Event streams on page B8-1962](#).
- EVNTEN, bit[2]** Enables the generation of an event stream from the virtual counter:
- 0** Disables the event stream.
  - 1** Enables the event stream.
- This bit resets to 0.  
For more information see [Event streams on page B8-1962](#).
- PL0VCTEN, bit[1]** Controls whether the virtual counter, **CNTVCT**, and the frequency register **CNTFRQ**, are accessible from PL0 modes:
- 0** **CNTVCT** is not accessible from PL0.  
If **PL0PCTEN** is set to 0, **CNTFRQ** is not accessible from PL0.
  - 1** **CNTVCT** and **CNTFRQ** are accessible from PL0.
- This bit resets to 0.  
For more information see [Accessing the physical counter on page B8-1960](#).
- PL0PCTEN, bit[0]** Controls whether the physical counter, **CNTPCT**, and the frequency register **CNTFRQ**, are accessible from PL0 modes:
- 0** **CNTPCT** is not accessible from PL0 modes.  
If **PL0VCTEN** is set to 0, **CNTFRQ** is not accessible from PL0.
  - 1** **CNTPCT** and **CNTFRQ** are accessible from PL0.
- This bit resets to 0.  
For more information see [Accessing the physical counter on page B8-1960](#).

———— **Note** —————

**CNTFRQ** is accessible from PL0 modes if either **PL0VCTEN** or **PL0PCTEN** is set to 1.

---

### Accessing the CNTKCTL register

To access the CNTKCTL register, software reads or writes the CP15 registers with <opc1> set to 0, <CRn> set to c14, <CRm> set to c1, and <opc2> set to 0. For example:

MRC p15, 0, <Rt>, c14, c1, 0 ; Read CNTKCTL to Rt  
MCR p15, 0, <Rt>, c14, c1, 0 ; Write Rt to CNTKCTL

### B6.1.11 CNTP\_CTL, PL1 Physical Timer Control register, PMSA

The CNTP\_CTL register characteristics are:

- Purpose** The CNTP\_CTL register is the control register for the physical timer.  
This register is a Generic Timer register.
- Usage constraints** In a PMSA implementation, the CNTP\_CTL register is always accessible from PL1 modes, and when CNTKCTL.PL0PTEN is set to 1, is also accessible from the PL0 mode.  
For more information, see [Accessing the timer registers on page B8-1964](#).
- Configurations** Implemented only as part of the Generic Timers Extension.  
The VMSA, PMSA, and system level definitions of the register fields are identical.
- Attributes** A 32-bit RW register with an UNKNOWN reset value.  
[Table B8-2 on page B8-1967](#) shows the encodings of all of the Generic Timer registers.

In an ARMv7 implementation, the CNTP\_CTL register bit assignments are:

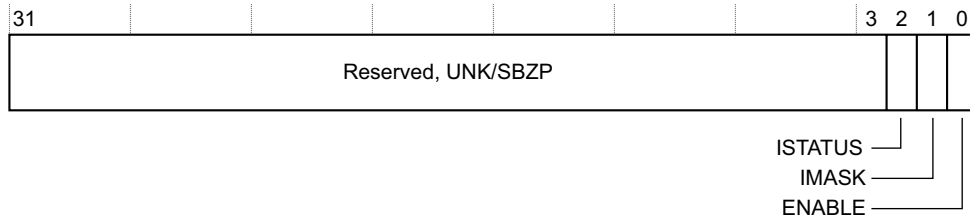

- Bits[31:3]** Reserved, UNK/SBZP.
- ISTATUS, bit[2]** The status of the timer. This bit indicates whether the timer condition is asserted:
  - 0** Timer condition is not asserted.
  - 1** Timer condition is asserted.

When the ENABLE bit is set to 1, ISTATUS indicates whether the timer value meets the condition for the timer output to be asserted, see [Operation of the CompareValue views of the timers on page B8-1964](#) and [Operation of the TimerValue views of the timers on page B8-1965](#). ISTATUS takes no account of the value of the IMASK bit. If ISTATUS is set to 1 and IMASK is set to 0 then the timer output signal is asserted.

This bit is read-only.
- IMASK, bit[1]** Timer output signal mask bit. Permitted values are:
  - 0** Timer output signal is not masked.
  - 1** Timer output signal is masked.

For more information, see the description of the ISTATUS bit and [Operation of the timer output signal on page B8-1966](#).
- ENABLE, bit[0]** Enables the timer. Permitted values are:
  - 0** Timer disabled.
  - 1** Timer enabled.

Setting this bit to 0 disables the timer output signal, but the timer value accessible from [CNTP\\_TVAL](#) continues to count down.

———— **Note** —————

Disabling the output signal might be a power-saving option.

### **Accessing the CNTP\_CTL register**

To access the CNTP\_CTL register, software reads or writes the CP15 registers with <opc1> set to 0, <CRn> set to c14, <CRm> set to c2, and <opc2> set to 1. For example:

```
MRC p15, 0, <Rt>, c14, c2, 1      ; Read CNTP_CTL into Rt  
MCR p15, 0, <Rt>, c14, c2, 1      ; Write Rt to CNTP_CTL
```



### B6.1.12 CNTP\_CVAL, PL1 Physical Timer CompareValue register, PMSA

The CNTP\_CVAL register characteristics are:

- Purpose** The CNTP\_CVAL register holds the 64-bit compare value for the PL1 physical timer. This register is a Generic Timer register.
- Usage constraints** In a PMSA implementation, the CNTP\_CVAL register is always accessible from PL1 modes, and when CNTKCTL.PLOPTEN is set to 1, is also accessible from the PL0 mode. For more information, see [Accessing the timer registers on page B8-1964](#).
- Configurations** Implemented only as part of the Generic Timers Extension. The VMSA, PMSA, and system level definitions of the register fields are identical.
- Attributes** A 64-bit RW register with an UNKNOWN reset value. [Table B8-2 on page B8-1967](#) shows the encodings of all of the Generic Timer registers.

In an ARMv7 implementation, the CNTP\_CVAL register bit assignments are:

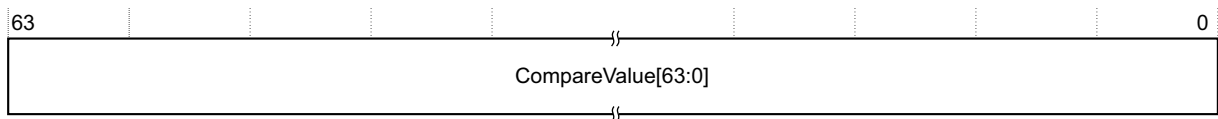

#### CompareValue, bits[63:0]

Indicates the compare value for the PL1 physical timer.

For more information about the timer see [Timers on page B8-1963](#).

#### Accessing the CNTP\_CVAL register

To access the CNTP\_CVAL register, software performs a 64-bit read or write of the CP15 registers with <CRm> set to c14 and <opc1> set to 2. For example:

```
MRRC p15, 2, <Rt>, <Rt2>, c14 ; Read 64-bit CNTP_CVAL into Rt (low word) and Rt2 (high word)
MCRR p15, 2, <Rt>, <Rt2>, c14 ; Write Rt (low word) and Rt2 (high word) to 64-bit CNTP_CVAL
```

In these MRRC and MCRR instructions, Rt holds the least-significant word of the CNTP\_CVAL register, and Rt2 holds the most-significant word.

### B6.1.13 CNTP\_TVAL, PL1 Physical TimerValue register, PMSA

The CNTP\_TVAL register characteristics are:

- Purpose** Holds the timer value for the PL1 physical timer. This provides a 32-bit downcounter, see [Operation of the TimerValue views of the timers on page B8-1965](#).  
 This register is a Generic Timer register.
- Usage constraints** In a PMSA implementation, the CNTP\_TVAL register is always accessible from PL1 modes, and when CNTKCTL.PLOPTEN is set to 1, is also accessible from the PL0 mode.  
 For more information, see [Accessing the timer registers on page B8-1964](#).  
 When CNTP\_CTL.ENABLE is set to 0:
- a write to this register updates the register
  - the value held in the register continues to decrement
  - a read of the register returns an UNKNOWN value.
- Configurations** Implemented only as part of the Generic Timers Extension.  
 The VMSA, PMSA, and system level definitions of the register fields are identical.
- Attributes** A 32-bit RW register with an UNKNOWN reset value.  
[Table B8-2 on page B8-1967](#) shows the encodings of all of the Generic Timer registers.

In an ARMv7 implementation, the CNTP\_TVAL register bit assignments are:

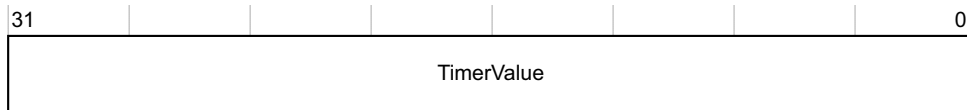

**TimerValue, bits[31:0]**

Indicates the timer value.

#### Accessing the CNTP\_TVAL register

To access the CNTP\_TVAL register, software reads or writes the CP15 registers with <opc1> set to 0, <CRn> set to c14, <CRm> set to c2, and <opc2> set to 0. For example:

```
MRC p15, 0, <Rt>, c14, c2, 0 ; Read CNTP_TVAL into Rt
MCR p15, 0, <Rt>, c14, c2, 0 ; Write Rt to CNTP_TVAL
```

### B6.1.14 CNTPCT, Physical Count register, PMSA

The CNTPCT register characteristics are:

<b>Purpose</b>	The CNTPCT register holds the 64-bit physical count value. This register is a Generic Timer register.
<b>Usage constraints</b>	The CNTPCT register is accessible: <ul style="list-style-type: none"><li>• from PL1 modes</li><li>• from User mode when <a href="#">CNTKCTL.PLOPCTEN</a> is set to 1.</li></ul> For more information about the CNTPCT register access controls see <a href="#">Accessing the physical counter on page B8-1960</a> .
<b>Configurations</b>	Implemented only as part of the Generic Timers Extension. The VMSA, PMSA, and system level definitions of the register fields are identical.
<b>Attributes</b>	A 64-bit RO register with an UNKNOWN reset value. <a href="#">Table B8-2 on page B8-1967</a> shows the encodings of all of the Generic Timer registers.

The CNTPCT bit assignments are:

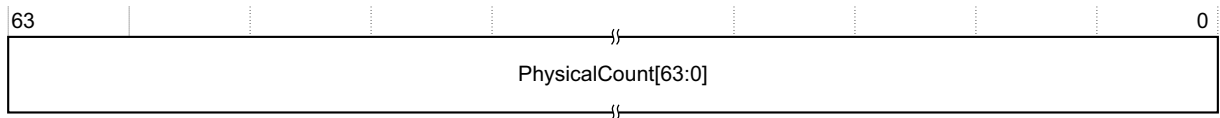

#### PhysicalCount, bits[63:0]

Indicates the physical count.

#### Accessing the CNTPCT register

To access the CNTPCT register, software performs a 64-bit read of the CP15 registers with `<CRm>` set to `c14` and `<opc1>` set to 0. For example:

`MRRC p15, 0, <Rt>, <Rt2>, c14` ; Read 64-bit CNTPCT into `Rt` (low word) and `Rt2` (high word)

In the `MRRC` instruction, `Rt` holds the least-significant word of the CNTPCT register, and `Rt2` holds the most-significant word.

### B6.1.15 CNTV\_CTL, Virtual Timer Control register, PMSA

The CNTV\_CTL register characteristics are:

<b>Purpose</b>	The CNTV_CTL register is the control register for the virtual timer. This register is a Generic Timer register.
<b>Usage constraints</b>	The CNTV_CTL register is accessible from PL1 modes, and when CNTKCTL.PLOPCTEN is set to 1, is also accessible from the PL0 mode. For more information, see <a href="#">Accessing the timer registers on page B8-1964</a> .
<b>Configurations</b>	Implemented only as part of the Generic Timers Extension. The VMSA, PMSA, and system level definitions of the register fields are identical.
<b>Attributes</b>	A 32-bit RW register with an UNKNOWN reset value. <a href="#">Table B8-2 on page B8-1967</a> shows the encodings of all of the Generic Timer registers.

The bit assignments of the CNTV\_CTL register are identical to those of the CNTP\_CTL register.

#### Accessing CNTV\_CTL

To access the CNTV\_CTL register, software reads or writes the CP15 registers with <opc1> set to 0, <CRn> set to c14, <CRm> set to c3, and <opc2> set to 1. For example:

```
MRC p15, 0, <Rt>, c14, c3, 1 ; Read CNTV_CTL into Rt  
MCR p15, 0, <Rt>, c14, c3, 1 ; Write Rt to CNTV_CTL
```

### B6.1.16 CNTV\_CVAL, Virtual Timer CompareValue register, PMSA

The CNTV\_CVAL register characteristics are:

<b>Purpose</b>	The CNTV_CVAL register holds the compare value for the virtual timer. This register is a Generic Timer register.
<b>Usage constraints</b>	The CNTV_CVAL register is accessible from PL1 modes, and when CNTKCTL.PLOPCTEN is set to 1, is also accessible from the PL0 mode. For more information, see <a href="#">Accessing the timer registers on page B8-1964</a> .
<b>Configurations</b>	Implemented only as part of the Generic Timers Extension. The VMSA, PMSA, and system level definitions of the register fields are identical.
<b>Attributes</b>	A 64-bit RW register with an UNKNOWN reset value. <a href="#">Table B8-2 on page B8-1967</a> shows the encodings of all of the Generic Timer registers.

The bit assignments of the CNTV\_CVAL register are identical to those of the CNTP\_CVAL register.

#### Accessing CNTV\_CVAL

To access the CNTV\_CVAL register, software performs a 64-bit read or write of the CP15 registers with <CRm> set to c14 and <opc1> set to 3. For example:

```
MRRC p15, 3, <Rt>, <Rt2>, c14 ; Read 64-bit CNTV_CVAL into Rt (low word) and Rt2 (high word)  
MCR p15, 3, <Rt>, <Rt2>, c14 ; Write 64-bit Rt (low word) and Rt2 (high word) to CNTV_CVAL
```

In these MRRC and MCR instructions, Rt holds the least-significant word of CNTV\_CVAL, and Rt2 holds the most-significant word.

### B6.1.17 CNTV\_TVAL, Virtual TimerValue register, PMSA

The CNTV\_TVAL register characteristics are:

**Purpose** The CNTV\_TVAL register holds the timer value for the virtual timer. This provides a 32-bit downcounter, see [Operation of the TimerValue views of the timers on page B8-1965](#).

This register is a Generic Timer register.

**Usage constraints** The CNTV\_TVAL register is accessible from PL1 modes, and when CNTKCTL.PLOPCTEN is set to 1, is also accessible from the PL0 mode.

For more information, see [Accessing the timer registers on page B8-1964](#).

When CNTV\_CTL.ENABLE is set to 0:

- a write to this register updates the register
- the value held in the register continues to decrement
- a read of the register returns an UNKNOWN value.

**Configurations** Implemented only as part of the Generic Timers Extension.

The VMSA, PMSA, and system level definitions of the register fields are identical.

**Attributes** A 32-bit RW register with an UNKNOWN reset value.

[Table B8-2 on page B8-1967](#) shows the encodings of all of the Generic Timer registers.

The bit assignments of the CNTV\_TVAL register are identical to those of the CNTP\_TVAL register.

#### Accessing CNTV\_TVAL

To access the CNTV\_TVAL register, software reads or writes the CP15 registers with <opc1> set to 0, <CRn> set to c14, <CRm> set to c3, and <opc2> set to 0. For example:

```
MRC p15, 0, <Rt>, c14, c3, 0 ; Read CNTV_TVAL into Rt  
MCR p15, 0, <Rt>, c14, c3, 0 ; Write Rt to CNTV_TVAL
```

### B6.1.18 CNTVCT, Virtual Count register, PMSA

The CNTVCT register characteristics are:

**Purpose** The CNTVCT register holds the 64-bit virtual count.

———— **Note** —————

The virtual count is obtained by subtracting the virtual offset from the physical count, see [The virtual counter on page B8-1961](#). In a PMSA implementation, the virtual offset is zero.

This register is a Generic Timer register.

**Usage constraints** The CNTVCT register is accessible:

- from PL1 modes
- from User mode when [CNTKCTL.PLOPCTEN](#) is set to 1.

For more information about the CNTVCT register access controls see [Accessing the virtual counter on page B8-1961](#).

**Configurations** Implemented only as part of the Generic Timers Extension.  
 The VMSA, PMSA, and system level definitions of the register fields are identical.

**Attributes** A 64-bit RO register with an UNKNOWN reset value.  
[Table B8-2 on page B8-1967](#) shows the encodings of all of the Generic Timer registers.

In an ARMv7 implementation, the CNTVCT bit assignments are:

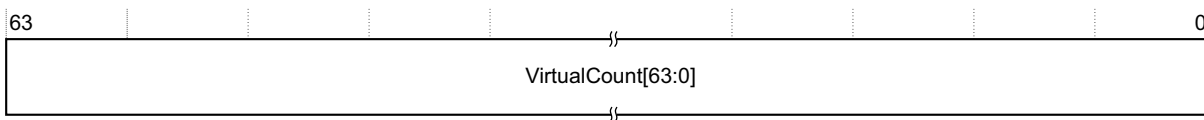

**VirtualCount, bits[63:0]**  
 Indicates the virtual count.

#### Accessing the CNTVCT register

To access the CNTVCT register, software performs a 64-bit read of the CP15 registers with `<CRm>` set to `c14` and `<opc1>` set to 1. For example:

`MRRC p15, 1, <Rt>, <Rt2>, c14` ; Read 64-bit CNTVCT into `Rt` (low word) and `Rt2` (high word)

In the `MRRC` instruction, `Rt` holds the least-significant word of the CNTVCT register, and `Rt2` holds the most-significant word.

## B6.1.19 CONTEXTIDR, Context ID Register, PMSA

The CONTEXTIDR characteristics are:

**Purpose** The CONTEXTIDR identifies the current context by specifying a *Context Identifier* (Context ID).

This register is part of the MMU control registers functional group.

**Usage constraints** Only accessible from PL1.

**Configurations** Always implemented.

———— **Note** —————

Previously, PMSA implementations identified this Context ID as a *Process Identifier* (PROCID), and called this CP15 c13 register the *Process ID Register*.

**Attributes** A 32-bit RW register with an UNKNOWN reset value. See also [Reset behavior of CP14 and CP15 registers on page B5-1776](#).

[Table B5-14 on page B5-1799](#) shows the encodings of all of the registers in the MMU control registers functional group.

In a PMSA implementation, the CONTEXTIDR bit assignments are:

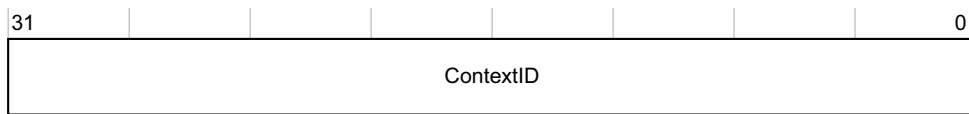

### ContextID, bits[31:0]

Context Identifier. This field must be programmed with a unique context identifier value that identifies the current process. It is used by the trace logic and the debug logic to identify the process that is running currently.

This register is used by:

- the debug logic, for Linked and Unlinked Context ID matching, see [Breakpoint debug events on page C3-2039](#) and [Watchpoint debug events on page C3-2057](#)
- the trace logic, to identify the current process.

### Accessing the CONTEXTIDR

To access the CONTEXTIDR, software reads or writes the CP15 registers with <opc1> set to 0, <CRn> set to c13, <CRm> set to c0, and <opc2> set to 1. For example:

MRC p15, 0, <Rt>, c13, c0, 1 ; Read CONTEXTIDR into Rt  
 MCR p15, 0, <Rt>, c13, c0, 1 ; Write Rt to CONTEXTIDR

**B6.1.20 CP15DMB, CP15 Data Memory Barrier operation, PMSA**

*Data and instruction barrier operations, PMSA on page B6-1943* describes this deprecated CP15 barrier operation.

**B6.1.21 CP15DSB, CP15 Data Synchronization Barrier operation, PMSA**

*Data and instruction barrier operations, PMSA on page B6-1943* describes this deprecated CP15 barrier operation.

**B6.1.22 CP15ISB, CP15 Instruction Synchronization Barrier operation, PMSA**

*Data and instruction barrier operations, PMSA on page B6-1943* describes this deprecated CP15 barrier operation.



### B6.1.23 CPACR, Coprocessor Access Control Register, PMSA

The CPACR characteristics are:

<b>Purpose</b>	The CPACR: <ul style="list-style-type: none"> <li>• controls access to coprocessors CP0 to CP13</li> <li>• is used for determining which, if any, of coprocessors CP0 to CP13 are implemented.</li> </ul> This register is part of the Other system control registers functional group.
<b>Usage constraints</b>	Only accessible from PL1.
<b>Configurations</b>	Always implemented.
<b>Attributes</b>	A 32-bit RW register. See the field descriptions for the reset values. See also <a href="#">Reset behavior of CP14 and CP15 registers on page B5-1776</a> . <a href="#">Table B5-16 on page B5-1800</a> shows the encodings of all of the registers in the Other system control registers functional group.

The CPACR bit assignments are:

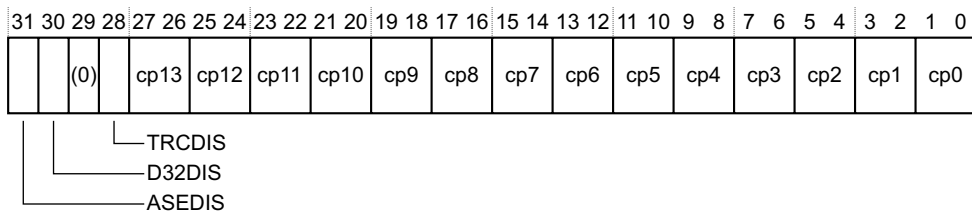

#### ASEDIS, bit[31]

Disable Advanced SIMD functionality:

- 0** This bit does not cause any instructions to be UNDEFINED.
- 1** All instruction encodings identified in the [Alphabetical list of instructions on page A8-300](#) as being Advanced SIMD instructions, but that are not VFPv3 or VFPv4 instructions, are UNDEFINED.

On an implementation that:

- Implements the Floating-point Extension and does not implement the Advanced SIMD Extension, this bit is RAO/WI.
- Does not implement the Floating-point Extension or the Advanced SIMD Extension, this bit is UNK/SBZP.
- Implements both the Floating-point and Advanced SIMD Extensions, it is IMPLEMENTATION DEFINED whether this bit is supported. If it is not supported it is RAZ/WI.

If this bit is implemented as an RW bit it resets to 0.

### D32DIS, bit[30]

Disable use of D16-D31 of the Floating-point Extension register file:

- 0** This bit does not cause any instructions to be UNDEFINED.
- 1** All instruction encodings identified in the [Alphabetical list of instructions on page A8-300](#) as being VFPv3 or VFPv4 instructions are UNDEFINED if they access any of registers D16-D31.

If this bit is 1 when CPACR.ASEDIS == 0, the result is UNPREDICTABLE.

On an implementation that:

- Does not implement the Floating-point Extension, this bit is UNK/SBZP.
- Implements the Floating-point Extension and does not implement D16-D31, this bit is RAO/WI.
- Implements the Floating-point Extension and implements D16-D31, it is IMPLEMENTATION DEFINED whether this bit is supported. If it is not supported it is RAZ/WI.

If this bit is implemented as an RW bit it resets to 0.

**Bit[29]** Reserved, UNK/SBZP.

### TRCDIS, bit[28]

Disable CP14 access to trace registers:

- 0** This bit does not cause any instructions to be UNDEFINED.
- 1** Any MRC or MCR instruction with coproc set to 0b1110 and opc1 set to 0b001 is UNDEFINED.

On an implementation that:

- Does not include a trace macrocell, or does not include a CP14 interface to the trace macrocell registers, this bit is RAZ/WI.
- Includes a CP14 interface to trace macrocell registers, it is IMPLEMENTATION DEFINED whether this bit is supported. If it is not supported it is RAZ/WI.

If this bit is implemented as an RW bit its reset value is UNKNOWN.

### cp<n>, bits[2n+1, 2n], for n = 0 to 13

Defines the access rights for coprocessor n. The possible values of the field are:

- 00** Access denied. Any attempt to access the coprocessor generates an Undefined Instruction exception.
- 01** Accessible from PL1 only. Any attempt to access the coprocessor from unprivileged software generates an Undefined Instruction exception.
- 10** Reserved. The effect of this value is UNPREDICTABLE.
- 11** Full access. The meaning of full access is defined by the appropriate coprocessor.

For a coprocessor that is not implemented this field is RAZ/WI. Coprocessors 8, 9, 12, and 13 are reserved for future use by ARM, and therefore cp8, cp9, cp12, and cp13 are RAZ/WI.

When implemented as an RW field, cpn resets to zero.

If more than one coprocessor is required to provide a particular set of functionality, then having different values for the CPACR fields for those coprocessors can lead to UNPREDICTABLE behavior. An example where this must be considered is with the Floating-point Extension, that uses CP10 and CP11.

Typically, an operating system uses this register to control coprocessor resource sharing among applications:

- Initially all applications are denied access to the shared coprocessor-based resources.
- When an application attempts to use a resource it results in an Undefined Instruction exception.
- The Undefined Instruction exception handler can then grant access to the resource by setting the appropriate field in the CPACR.

Sharing resources among applications requires a state saving mechanism. Two possibilities are:

- during a context switch, if the last executing process or thread had access rights to a coprocessor then the operating system saves the state of that coprocessor
- on receiving a request for access to a coprocessor, the operating system saves the old state for that coprocessor with the last process or thread that accessed it.

For details of how software can use this register to check for implemented coprocessors see [Access controls on CP0 to CP13](#) on page B1-1226.

### Accessing the CPACR

To access the CPACR, software reads or writes the CP15 registers with <opc1> set to 0, <CRn> set to c1, <CRm> set to c0, and <opc2> set to 2. For example:

```
MRC p15, 0, <Rt>, c1, c0, 2 ; Read CPACR into Rt  
MCR p15, 0, <Rt>, c1, c0, 2 ; Write Rt to CPACR
```

Normally, software uses a read, modify, write sequence to update the CPACR, to avoid unwanted changes to the access settings for other coprocessors.

## B6.1.24 CSSELR, Cache Size Selection Register, PMSA

CSSELR characteristics are:

- Purpose** The CSSELR selects the current [CCSIDR](#), by specifying:
- The required cache level.
  - The cache type, either:
    - Instruction cache, if the memory system implements separate instruction and data caches.
    - Data cache. The data cache argument must be used for a unified cache.
- This register is part of the Identification registers functional group.
- Usage constraints** Only accessible from PL1.
- Configurations** This register is not implemented in architecture versions before ARMv7.
- Attributes** A 32-bit RW register with an UNKNOWN reset value. See also [Reset behavior of CP14 and CP15 registers on page B5-1776](#).  
[Table B5-13 on page B5-1798](#) shows the encodings of all of the registers in the Identification registers functional group.

The CSSELR bit assignments are:

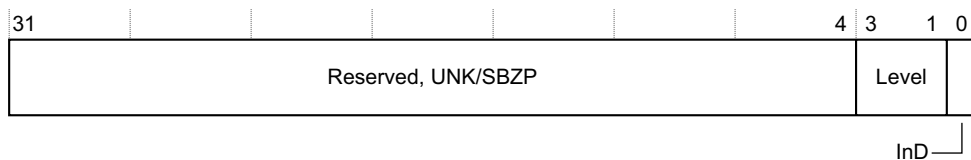

- Bits[31:4]** Reserved, UNK/SBZP.
- Level, bits[3:1]** Cache level of required cache. Permitted values are from 0b000, indicating Level 1 cache, to 0b110 indicating Level 7 cache.
- InD, bit[0]** Instruction not data bit. Permitted values are:
- 0** Data or unified cache.
  - 1** Instruction cache.

### Accessing CSSELR

To access CSSELR, software reads or writes the CP15 registers with <opc1> set to 2, <CRn> set to c0, <CRm> set to c0, and <opc2> set to 0. For example:

```
MRC p15, 2, <Rt>, c0, c0, 0 ; Read CSSELR into Rt
MCR p15, 2, <Rt>, c0, c0, 0 ; Write Rt to CSSELR
```

## B6.1.25 CTR, Cache Type Register, PMSA

The CTR characteristics are:

<b>Purpose</b>	The CTR provides information about the architecture of the caches. This register is part of the Identification registers functional group.
<b>Usage constraints</b>	Only accessible from PL1.
<b>Configurations</b>	ARMv7 changes the format of the CTR, This section describes only the ARMv7 format. For more information see the description of the Format field, bits[31:29].
<b>Attributes</b>	A 32-bit RO register with an IMPLEMENTATION DEFINED value. See also <i>Reset behavior of CP14 and CP15 registers on page B5-1776</i> .  <i>Table B5-13 on page B5-1798</i> shows the encodings of all of the registers in the Identification registers functional group.

In an ARMv7 PMSA implementation, the CTR bit assignments are:

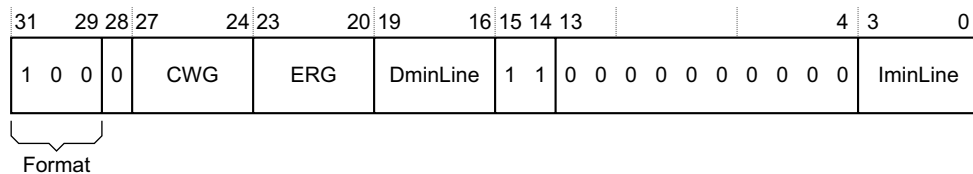

**Format, bits[31:29]** Indicates the implemented CTR format. The possible values of this are:  
 0b000 ARMv6 format, see *CP15 c0, Cache Type Register, CTR, ARMv4 and ARMv5 on page AppxO-2615*.  
 0b100 ARMv7 format. This is the format described in this section.  
 All other values are reserved.

**Bit[28]** RAZ.

**CWG, bits[27:24]** Cache Write-back Granule. The maximum size of memory that can be overwritten as a result of the eviction of a cache entry that has had a memory location in it modified, encoded as  $\text{Log}_2$  of the number of words.  
 A value of 0b0000 indicates that the CTR does not provide Cache Write-back Granule information and either:

- the architectural maximum of 512 words (2Kbytes) must be assumed
- the Cache Write-back Granule can be determined from maximum cache line size encoded in the Cache Size ID Registers.

Values greater than 0b1001 are reserved.

**ERG, bits[23:20]** Exclusives Reservation Granule. The maximum size of the reservation granule that has been implemented for the Load-Exclusive and Store-Exclusive instructions, encoded as  $\text{Log}_2$  of the number of words. For more information, see *Tagging and the size of the tagged memory block on page A3-121*.  
 A value of 0b0000 indicates that the CTR does not provide Exclusives Reservation Granule information and the architectural maximum of 512 words (2Kbytes) must be assumed.  
 Values greater than 0b1001 are reserved.

**DminLine, bits[19:16]**  
 $\text{Log}_2$  of the number of words in the smallest cache line of all the data caches and unified caches that are controlled by the processor.

**Bit[15:14]** RAO.

**Bits[13:4]** RAZ.

**IminLine, bits[3:0]**  $\text{Log}_2$  of the number of words in the smallest cache line of all the instruction caches that are controlled by the processor.

### Accessing the CTR

To access the CTR, software reads the CP15 registers with <opc1> set to 0, <CRn> set to c0, <CRm> set to c0, and <opc2> set to 1. For example

MRC p15, 0, <Rt>, c0, c0, 1 ; Read CTR into Rt

### **B6.1.26 DCCIMVAC, Data Cache Clean and Invalidate by MVA to PoC, PMSA**

*Cache and branch predictor maintenance operations, PMSA on page B6-1941* describes this cache maintenance operation.

This operation is part of the Cache maintenance operations functional group. [Table B5-18 on page B5-1801](#) shows the encodings of all of the registers and operations in this functional group.

### **B6.1.27 DCCISW, Data Cache Clean and Invalidate by Set/Way, PMSA only**

*Cache and branch predictor maintenance operations, PMSA on page B6-1941* describes this cache maintenance operation.

This operation is part of the Cache maintenance operations functional group. [Table B5-18 on page B5-1801](#) shows the encodings of all of the registers and operations in this functional group.

### **B6.1.28 DCCMVAC, Data Cache Clean by MVA to PoC, PMSA**

*Cache and branch predictor maintenance operations, PMSA on page B6-1941* describes this cache maintenance operation.

This operation is part of the Cache maintenance operations functional group. [Table B5-18 on page B5-1801](#) shows the encodings of all of the registers and operations in this functional group.

### **B6.1.29 DCCMVAU, Data Cache Clean by MVA to PoU, PMSA**

*Cache and branch predictor maintenance operations, PMSA on page B6-1941* describes this cache maintenance operation.

This operation is part of the Cache maintenance operations functional group. [Table B5-18 on page B5-1801](#) shows the encodings of all of the registers and operations in this functional group.

### **B6.1.30 DCCSW, Data Cache Clean by Set/Way, PMSA**

*Cache and branch predictor maintenance operations, PMSA on page B6-1941* describes this cache maintenance operation.

This operation is part of the Cache maintenance operations functional group. [Table B5-18 on page B5-1801](#) shows the encodings of all of the registers and operations in this functional group.

### **B6.1.31 DCIMVAC, Data Cache Invalidate by MVA to PoC, PMSA**

*Cache and branch predictor maintenance operations, PMSA on page B6-1941* describes this cache maintenance operation.

This operation is part of the Cache maintenance operations functional group. [Table B5-18 on page B5-1801](#) shows the encodings of all of the registers and operations in this functional group.

### **B6.1.32 DCISW, Data Cache Invalidate by Set/Way, PMSA**

*Cache and branch predictor maintenance operations, PMSA on page B6-1941* describes this cache maintenance operation.

This operation is part of the Cache maintenance operations functional group. [Table B5-18 on page B5-1801](#) shows the encodings of all of the registers and operations in this functional group.

### B6.1.33 DFAR, Data Fault Address Register, PMSA

The DFAR characteristics are:

- Purpose** The DFAR holds the faulting address that caused a synchronous Data Abort exception. This register is part of the PL1 Fault handling registers functional group.
- Usage constraints** Only accessible from PL1.
- Configurations** Always implemented.
- Attributes** A 32-bit RW register with an UNKNOWN reset value. See also [Reset behavior of CP14 and CP15 registers on page B5-1776](#).  
[Table B5-15 on page B5-1799](#) shows the encodings of all of the registers in the PL1 Fault handling registers functional group.

The DFAR bit assignments are:

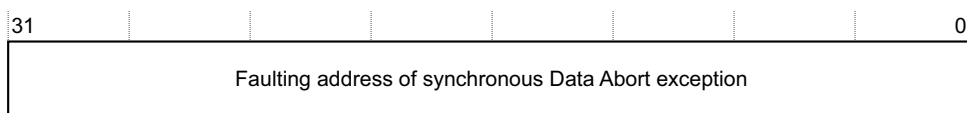

For information about using the DFAR, including when the value in the DFAR is valid, see [Exception reporting in a PMSA implementation on page B5-1767](#).

A debugger can write to the DFAR to restore its value.

#### Accessing the DFAR

To access the DFAR, software reads or writes the CP15 registers with <opc1> set to 0, <CRn> set to c6, <CRm> set to c0, and <opc2> set to 0. For example:

```
MRC p15, 0, <Rt>, c6, c0, 0 ; Read DFAR into Rt  
MCR p15, 0, <Rt>, c6, c0, 0 ; Write Rt to DFAR
```



### B6.1.34 DFSR, Data Fault Status Register, PMSA

The DFSR characteristics are:

- Purpose** The DFSR holds status information about the last data fault.  
 This register is part of the PL1 Fault handling registers functional group.
- Usage constraints** Only accessible from PL1.
- Configurations** Always implemented.
- Attributes** A 32-bit RW register with an UNKNOWN reset value. See also [Reset behavior of CP14 and CP15 registers on page B5-1776](#).  
[Table B5-15 on page B5-1799](#) shows the encodings of all of the registers in the PL1 Fault handling registers functional group.

In a PMSA implementation, the DFSR bit assignments are:

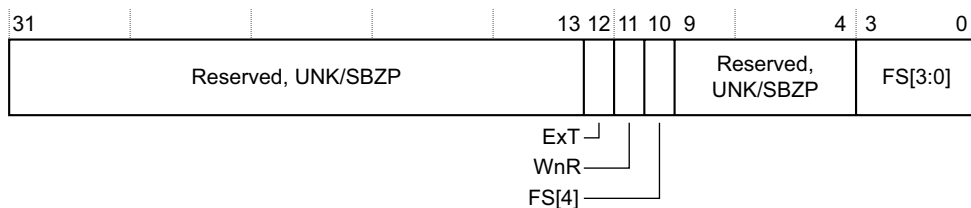

- Bits[31:13, 9:4]** Reserved, UNK/SBZP.
- ExT, bit[12]** External abort type. This bit can provide an IMPLEMENTATION DEFINED classification of external aborts.  
 For aborts other than external aborts this bit always returns 0.  
 In an implementation that does not provide any classification of external aborts, this bit is UNK/SBZP.
- WnR, bit[11]** Write not Read bit. On a synchronous exception, indicates whether the abort was caused by a write or a read access:  
**0** Abort caused by a read access.  
**1** Abort caused by a write access.  
 For synchronous faults on CP15 cache maintenance operations this bit always returns the value 1.  
 This bit is UNKNOWN on:
- an asynchronous Data Abort exception
  - a Data Abort exception caused by a debug exception.
- FS, bits[10, 3:0]** Fault status bits. For the valid encodings of these bits in an ARMv7-R implementation with a PMSA, see [Table B5-8 on page B5-1770](#).  
 All encodings not shown in the table are reserved.

For information about using the DFSR see [Exception reporting in a PMSA implementation on page B5-1767](#).

#### Accessing the DFSR

To access the DFSR, software reads or writes the CP15 registers with <opc1> set to 0, <CRn> set to c5, <CRm> set to c0, and <opc2> set to 0. For example:

```
MRC p15, 0, <Rt>, c5, c0, 0 ; Read DFSR into Rt
MCR p15, 0, <Rt>, c5, c0, 0 ; Write Rt to DFSR
```



## **Accessing the DRACR**

To access the DRACR, software reads or writes the CP15 registers with <opc1> set to 0, <CRn> set to c6, <CRm> set to c1, and <opc2> set to 4. For example:

```
MRC p15, 0, <Rt>, c6, c1, 4 ; Read DRACR into Rt  
MCR p15, 0, <Rt>, c6, c1, 4 ; Write Rt to DRACR
```

### B6.1.36 DRBAR, Data Region Base Address Register, PMSA

The DRBAR characteristics are:

- Purpose** The DRBAR indicates the base address of the current memory region in the data or unified address map.  
This register is part of the MMU control registers functional group.
- Usage constraints** Only accessible from PL1.  
Used in conjunction with the other MPU Memory region programming registers, see [Programming the MPU region attributes on page B5-1761](#).
- Configurations** Always implemented.
- Attributes** A 32-bit RW register with an UNKNOWN reset value. See also [Reset behavior of CP14 and CP15 registers on page B5-1776](#).  
[Table B5-14 on page B5-1799](#) shows the encodings of all of the registers in the MMU control registers functional group.

The DRBAR bit assignments are:

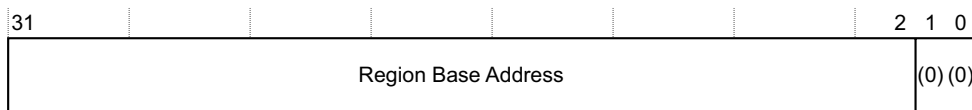

#### Region Base Address, bits[31:2]

The Base Address for the region, in the Data or Unified address map.

**Bit[1:0]** Reserved, UNK/SBZP.

The base address must be aligned to the region size, otherwise behavior is UNPREDICTABLE. The current memory region is selected by the value held in the [RGNR](#).

Software can use the DRBAR to find the size of the supported physical address space for the Data or Unified memory map, see [Finding the minimum supported region size on page B5-1758](#).

#### Accessing the DRBAR

To access the DRBAR, software reads or writes the CP15 registers with <opc1> set to 0, <CRn> set to c6, <CRm> set to c1, and <opc2> set to 0. For example:

```
MRC p15, 0, <Rt>, c6, c1, 0 ; Read DRBAR into Rt
MCR p15, 0, <Rt>, c6, c1, 0 ; Write Rt to DRBAR
```

## B6.1.37 DRSR, Data Region Size and Enable Register, PMSA

The DRSR characteristics are:

<b>Purpose</b>	The DRSR indicates the size of the current memory region in the data or unified address map, and can enable or disable: <ul style="list-style-type: none"> <li>• the entire region</li> <li>• each of the eight subregions, if the region is enabled.</li> </ul> This register is part of the MMU control registers functional group.
<b>Usage constraints</b>	Only accessible from PL1. Used in conjunction with the other MPU Memory region programming registers, see <a href="#">Programming the MPU region attributes on page B5-1761</a> .
<b>Configurations</b>	Always implemented.
<b>Attributes</b>	A 32-bit RW register that resets to zero. See also <a href="#">Reset behavior of CP14 and CP15 registers on page B5-1776</a> . <a href="#">Table B5-14 on page B5-1799</a> shows the encodings of all of the registers in the MMU control registers functional group.

The DRSR bit assignments are:

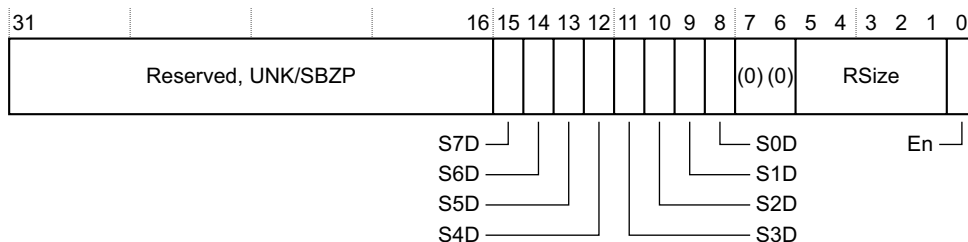

**Bit[31:16, 7:6]** Reserved, UNK/SBZP.

**SnD, bit[n+8], for values of n from 0 to 7**

Subregion disable bit for region n. Indicates whether the subregion is part of this region:

- 0** Subregion is part of this region.
- 1** Subregion disabled. The subregion is not part of this region.

The region is divided into exactly eight equal sized subregions. Subregion 0 is the subregion at the least significant address. For more information, see [Subregions on page B5-1755](#).

If the size of this region, indicated by the RSize field, is less than 256 bytes then the SnD fields are not defined, and register bits[15:8] are UNK/SBZP.

**RSize, bits[5:1]** Region Size field. Indicates the size of the current memory region:

- A value of 0 is not permitted, this value is reserved and UNPREDICTABLE.
- If N is the value in this field, the region size is  $2^{N+1}$  bytes.

**En, bit[0]** Enable bit for the region:

- 0** Region is disabled.
- 1** Region is enabled.

Because this register resets to zero, all memory regions are disabled on reset.

All memory regions must be enabled before they are used.

The current memory region is selected by the value held in the [RGNR](#).

The minimum region size supported is IMPLEMENTATION DEFINED, but if the memory system implementation includes a cache, ARM strongly recommends that the minimum region size is a multiple of the cache line length. This prevents cache attributes changing mid-way through a cache line.

Behavior is UNPREDICTABLE if software:

- writes a region size that is outside the range supported by the implementation
- accesses this register when the [RGNR](#) does not point to a valid region in the MPU Data or Unified address map.

### Accessing the DRSR

To access the DRSR, software reads or writes the CP15 registers with <opc1> set to 0, <CRn> set to c6, <CRm> set to c1, and <opc2> set to 2. For example:

```
MRC p15, 0, <Rt>, c6, c1, 2 ; Read DRSR into Rt  
MCR p15, 0, <Rt>, c6, c1, 2 ; Write Rt to DRSR
```

### B6.1.38 FPEXC, Floating-Point Exception Control register, PMSA

The FPEXC register characteristics are:

<b>Purpose</b>	The FPEXC provides a global enable for the Advanced SIMD and Floating-point Extensions, and indicates how the state of these extensions is recorded. This register is an Advanced SIMD and Floating-point Extension system register.
<b>Usage constraints</b>	Only accessible by software executing at PL1 or higher. See <a href="#">Enabling Advanced SIMD and floating-point support on page B1-1228</a> for more information.
<b>Configurations</b>	Implemented only if the implementation includes one or both of: <ul style="list-style-type: none"> <li>• the Floating-point Extension</li> <li>• the Advanced SIMD Extension.</li> </ul> The VFP subarchitecture might define additional bits in the FPEXC, see <a href="#">Additions to the Floating-Point Exception Register, FPEXC on page AppxF-2439</a> .
<b>Attributes</b>	A 32-bit RW register. See the register field descriptions for information about the reset value.  <a href="#">Table B1-24 on page B1-1235</a> shows the encodings of all of the Advanced SIMD and Floating-point Extension system registers

The FPEXC bit assignments are:

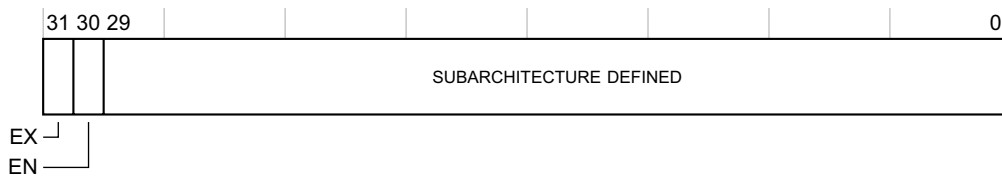

**EX, bit[31]** Exception bit. A status bit that specifies how much information must be saved to record the state of the Advanced SIMD and Floating-point system:

- 0** The only significant state is the contents of the registers:
  - D0 - D15
  - D16 - D31, if implemented
  - [FPSCR](#)
  - [FPEXC](#).
 A context switch can be performed by saving and restoring the values of these registers.
- 1** There is additional state that must be handled by any context switch system.

The reset value of this bit is UNKNOWN.

The behavior of the EX bit on writes is SUBARCHITECTURE DEFINED, except that in any implementation a write of 0 to this bit must be a valid operation, and must return a value of 0 if read back before any subsequent write to the register.

**EN, bit[30]** Enable bit. A global enable for the Advanced SIMD and Floating-point Extensions:

- 0** The Advanced SIMD and Floating-point Extensions are disabled. For details of how the system operates when EN == 0 see [Enabling Advanced SIMD and floating-point support on page B1-1228](#).
- 1** The Advanced SIMD and Floating-point Extensions are enabled and operate normally. This bit is always a normal read/write bit. It has a reset value of 0.

**Bits[29:0]** SUBARCHITECTURE DEFINED. An implementation can use these bits to communicate exception information between the floating-point hardware and the support code. The subarchitectural definition of these bits includes their read/write access. This can be defined on a bit by bit basis. This means that the reset value of these bits is SUBARCHITECTURE DEFINED.

A constraint on these bits is that if  $EX == 0$  it must be possible to save and restore all significant state for the floating-point system by saving and restoring only the two Advanced SIMD and Floating-point Extension registers [FPSCR](#) and [FPEXC](#).

### Accessing the FPEXC register

Software reads or writes the FPEXC register using the VMRS and VMSR instructions. For more information, see [VMRS on page A8-954](#) and [VMSR on page A8-956](#). For example:

```
VMRS <Rt>, FPEXC      ; Read Floating-point Exception Control Register  
VMSR FPEXC, <Rt>     ; Write Floating-point Exception Control Register
```

Writes to the FPEXC can have side-effects on various aspects of processor operation. All of these side-effects are synchronous to the FPEXC write. This means they are guaranteed not to be visible to earlier instructions in the execution stream, and they are guaranteed to be visible to later instructions in the execution stream.



### B6.1.39 FPSCR, Floating-point Status and Control Register, PMSA

The FPSCR characteristics are:

<b>Purpose</b>	Provides floating-point system status information and control. This register is an Advanced SIMD and Floating-point Extension system register.
<b>Usage constraints</b>	There are no usage constraints, but see <a href="#">Enabling Advanced SIMD and floating-point support on page B1-1228</a> for information about enabling access to this register.
<b>Configurations</b>	Implemented only if the implementation includes one or both of: <ul style="list-style-type: none"> <li>• the Floating-point Extension</li> <li>• the Advanced SIMD Extension.</li> </ul>
<b>Attributes</b>	A 32-bit RW register. The reset value of the register fields are UNKNOWN except where the field descriptions indicate otherwise.  <a href="#">Table B1-24 on page B1-1235</a> shows the encodings of all of the Advanced SIMD and Floating-point Extension system registers

The FPSCR bit assignments are:

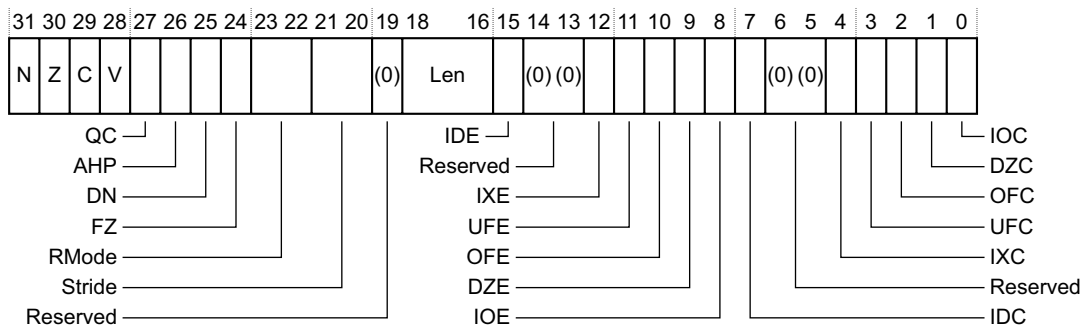

See the field descriptions for implementation differences in different VFP versions

**Bits[31:28]** Condition flags. These are updated by floating-point comparison operations, as shown in [Effect of a Floating-point comparison on the condition flags on page A2-80](#).

- N, bit[31]** Negative condition flag.
- Z, bit[30]** Zero condition flag.
- C, bit[29]** Carry condition flag.
- V, bit[28]** Overflow condition flag.

**———— Note ————**

Advanced SIMD operations never update these bits.

**QC, bit[27]** Cumulative saturation bit, Advanced SIMD only. This bit is set to 1 to indicate that an Advanced SIMD integer operation has saturated since 0 was last written to this bit. For details of saturation, see [Pseudocode details of saturation on page A2-44](#).

If the implementation does not include the Advanced SIMD Extension, this bit is UNK/SBZP.

**AHP, bit[26]** Alternative half-precision control bit:

- 0** IEEE half-precision format selected.
- 1** Alternative half-precision format selected.

For more information see [Advanced SIMD and Floating-point half-precision formats on page A2-66](#).

If the implementation does not include the Half-precision Extension, this bit is UNK/SBZP.

**DN, bit[25]** Default NaN mode control bit:

- 0** NaN operands propagate through to the output of a floating-point operation.
- 1** Any operation involving one or more NaNs returns the Default NaN.

For more information, see [NaN handling and the Default NaN on page A2-69](#).

The value of this bit only controls Floating-point arithmetic. Advanced SIMD arithmetic always uses the Default NaN setting, regardless of the value of the DN bit.

**FZ, bit[24]** Flush-to-zero mode control bit:

- 0** Flush-to-zero mode disabled. Behavior of the floating-point system is fully compliant with the IEEE 754 standard.
- 1** Flush-to-zero mode enabled.

For more information, see [Flush-to-zero on page A2-68](#).

The value of this bit only controls Floating-point arithmetic. Advanced SIMD arithmetic always uses the Flush-to-zero setting, regardless of the value of the FZ bit.

**RMode, bits[23:22]**

Rounding Mode control field. The encoding of this field is:

- 0b00 *Round to Nearest (RN) mode*
- 0b01 *Round towards Plus Infinity (RP) mode*
- 0b10 *Round towards Minus Infinity (RM) mode*
- 0b11 *Round towards Zero (RZ) mode.*

The specified rounding mode is used by almost all floating-point instructions provided by the Floating-point Extension. Advanced SIMD arithmetic always uses the Round to Nearest setting, regardless of the value of the RMode bits.

———— **Note** —————

The rounding mode names are based on the IEEE 754-1985 terminology. See [Floating-point standards, and terminology on page A2-55](#) for the corresponding terms in the IEEE 754-2008 revision of the standard.

**Stride, bits[21:20] and Len, bits[18:16]**

ARM deprecates use of nonzero values of these fields. For details of their use in previous versions of the ARM architecture see [Appendix K VFP Vector Operation Support](#).

The values of these fields are ignored by the Advanced SIMD Extension.

**Bits[19, 14:13, 6:5]**

Reserved, UNK/SBZP.

**Bits[15, 12:8]** Floating-point exception trap enable bits. These bits are supported only in VFPv2, VFPv3U, and VFPv4U. They are reserved, RAZ/WI, on a system that implements VFPv3 or VFPv4.

The possible values of each bit are:

- 0** Untrapped exception handling selected. If the floating-point exception occurs then the corresponding cumulative exception bit is set to 1.
- 1** Trapped exception handling selected. If the floating-point exception occurs, hardware does not update the corresponding cumulative exception bit. The trap handling software can decide whether to set the cumulative exception bit to 1.

The values of these bits control only floating-point arithmetic. Advanced SIMD arithmetic always uses untrapped exception handling, regardless of the values of these bits.

For more information, see [Floating-point exceptions on page A2-70](#).

The floating-point trap enable bits are:

**IDE, bit[15]** Input Denormal exception trap enable.

———— **Note** —————

Denormal corresponds to the term denormalized number in the IEEE 754-1985 standard. [Floating-point standards, and terminology on page A2-55](#) describes the terminology changes in the IEEE 754-2008 revision of the standard.

**IXE, bit[12]** Inexact exception trap enable.

**UFE, bit[11]** Underflow exception trap enable.

**OFE, bit[10]** Overflow exception trap enable.

**DZE, bit[9]** Division by Zero exception trap enable.

**IOE, bit[8]** Invalid Operation exception trap enable.

**Bits[7, 4:0]** Cumulative exception bits for floating-point exceptions. Each of these bits is set to 1 to indicate that the corresponding exception has occurred since 0 was last written to it. How floating-point instructions update these bits depends on the value of the corresponding exception trap enable bits, see the descriptions of bits[15, 12:8].

Advanced SIMD instructions set each cumulative exception bit if the corresponding exception occurs in one or more of the floating-point calculations performed by the instruction, regardless of the setting of the trap enable bits.

For more information, see [Floating-point exceptions on page A2-70](#).

**IDC, bit[7]** Input Denormal cumulative exception bit. Updated by hardware only when IDE, bit[15], is set to 0.

**IXC, bit[4]** Inexact cumulative exception bit. Updated by hardware only when IXE, bit[12], is set to 0.

**UFC, bit[3]** Underflow cumulative exception bit. Updated by hardware only when UFE, bit[11], is set to 0.

**OFC, bit[2]** Overflow cumulative exception bit. Updated by hardware only when OFE, bit[10], is set to 0.

**DZC, bit[1]** Division by Zero cumulative exception bit. Updated by hardware only when DZE, bit[9], is set to 0.

**IOC, bit[0]** Invalid Operation cumulative exception bit. Updated by hardware only when IOE, bit[8], is set to 0.

If the implementation includes the integer-only Advanced SIMD Extension and does not include the Floating-point Extension, all of these bits except QC are UNK/SBZP.

Writes to the FPSCR can have side-effects on various aspects of processor operation. All of these side-effects are synchronous to the FPSCR write. This means they are guaranteed not to be visible to earlier instructions in the execution stream, and they are guaranteed to be visible to later instructions in the execution stream.

## Accessing the FPSCR

Software reads or writes the FPSCR or transfers the FPSCR. {N, Z, C, V} flags to the APSR, using the VMRS and VMSR instructions. For more information, see [VMRS on page A8-954](#) and [VMSR on page A8-956](#). For example:

```
VMRS <Rt>, FPSCR      ; Read Floating-point System Control Register
VMSR FPSCR, <Rt>      ; Write Floating-point System Control Register
VMRS APSR_nzcv, FPSCR ; Write FPSCR.{N, Z, C, V} flags to APSR.{N, Z, C, V}
```

## B6.1.40 FPSID, Floating-point System ID Register, PMSA

The FPSID register characteristics are:

<b>Purpose</b>	The FPSID register provides top-level information about the floating-point implementation. This register is an Advanced SIMD and Floating-point Extension system register.
<b>Usage constraints</b>	Only accessible from PL1 or higher. See <a href="#">Enabling Advanced SIMD and floating-point support on page B1-1228</a> for more information.  This register complements the information provided by the CPUID scheme described in <a href="#">Chapter B7 The CPUID Identification Scheme</a> .
<b>Configurations</b>	The FPSID register can be implemented in a system that provides only software emulation of the ARM floating-point instructions, and must be implemented if the implementation includes one or both of: <ul style="list-style-type: none"> <li>• the Floating-point Extension</li> <li>• the Advanced SIMD Extension.</li> </ul> The VMSA and PMSA definitions of the register fields are identical.
<b>Attributes</b>	A 32-bit RO register.

———— **Note** —————

Although the FPSID is a RO register, a write using the FPSID encoding is a valid *serializing* operation, see [Asynchronous bounces, serialization, and Floating-point exception barriers on page B1-1237](#). Such a write does not access the register.

[Table B1-24 on page B1-1235](#) shows the encodings of all of the Advanced SIMD and Floating-point Extension system registers.

In ARMv7, the FPSID register bit assignments are:

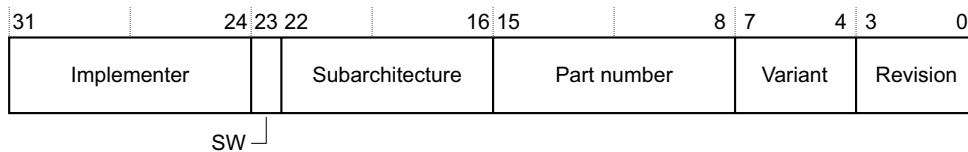

### Implementer, bits[31:24]

Implementer codes are the same as those used for the [MIDR](#).  
 For an implementation by ARM this field is 0x41, the ASCII code for A.

### SW, bit[23]

Software bit. This bit indicates whether a system provides only software emulation of the floating-point instructions that are provided by the Floating-point Extension:

- 0** The system includes hardware support for the floating-point instructions that are provided by the Floating-point Extension.
- 1** The system provides only software emulation of the floating-point instructions that are provided by the Floating-point Extension.

### Subarchitecture, bits[22:16]

Subarchitecture version number. For an implementation by ARM, permitted values are:

0b0000000 VFPv1 architecture with an IMPLEMENTATION DEFINED subarchitecture.  
Not permitted in an ARMv7 implementation.

0b0000001 VFPv2 architecture with Common VFP subarchitecture v1.  
Not permitted in an ARMv7 implementation.

0b0000010 VFPv3 architecture, or later, with Common VFP subarchitecture v2. The VFP architecture version is indicated by the [MVFR0](#) and [MVFR1](#) registers.

0b0000011 VFPv3 architecture, or later, with no subarchitecture. The entire floating-point implementation is in hardware, and no software support code is required. The VFP architecture version is indicated by the [MVFR0](#) and [MVFR1](#) registers.

This value can be used only by an implementation that does not support the trap enable bits in the [FPSCR](#).

0b0000100 VFPv3 architecture, or later, with Common VFP subarchitecture v3. The VFP architecture version is indicated by the [MVFR0](#) and [MVFR1](#) registers.

For a subarchitecture designed by ARM the most significant bit of this field, register bit[22], is 0. Values with a most significant bit of 0 that are not listed here are reserved.

When the subarchitecture designer is not ARM, the most significant bit of this field, register bit[22], must be 1. Each implementer must maintain its own list of subarchitectures it has designed, starting at subarchitecture version number 0x40.

### Part number, bits[15:8]

An IMPLEMENTATION DEFINED part number for the floating-point implementation, assigned by the implementer.

### Variant, bits[7:4]

An IMPLEMENTATION DEFINED variant number. Typically, this field distinguishes between different production variants of a single product.

### Revision, bits[3:0]

An IMPLEMENTATION DEFINED revision number for the floating-point implementation.

## Accessing the FPSID register

Software accesses the FPSID register using the VMRS instruction, see [VMRS on page B9-2012](#). For example:

```
VMRS <Rt>, FPSID ; Read FPSID into Rt
```

#### **B6.1.41 ICIALLU, Instruction Cache Invalidate All to PoU, PMSA**

*Cache and branch predictor maintenance operations, PMSA on page B6-1941* describes this cache maintenance operation.

This operation is part of the Cache maintenance operations functional group. [Table B5-18 on page B5-1801](#) shows the encodings of all of the registers and operations in this functional group.

#### **B6.1.42 ICIALLUIS, Instruction Cache Invalidate All to PoU, Inner Shareable, PMSA**

*Cache and branch predictor maintenance operations, PMSA on page B6-1941* describes this cache maintenance operation.

This operation is part of the Cache maintenance operations functional group. [Table B5-18 on page B5-1801](#) shows the encodings of all of the registers and operations in this functional group.

#### **B6.1.43 ICIMVAU, Instruction Cache Invalidate by MVA to PoU, PMSA**

*Cache and branch predictor maintenance operations, PMSA on page B6-1941* describes this cache maintenance operation.

This operation is part of the Cache maintenance operations functional group. [Table B5-18 on page B5-1801](#) shows the encodings of all of the registers and operations in this functional group.

## B6.1.44 ID\_AFR0, Auxiliary Feature Register 0, PMSA

The ID\_AFR0 characteristics are:

<b>Purpose</b>	ID_AFR0 provides information about the IMPLEMENTATION DEFINED features of the processor. This register is a CPUID register, and is part of the Identification registers functional group.
<b>Usage constraints</b>	Only accessible from PL1. Must be interpreted with the <a href="#">MIDR</a> .
<b>Configurations</b>	The VMSA and PMSA definitions of the register fields are identical.
<b>Attributes</b>	A 32-bit RO register with an IMPLEMENTATION DEFINED value: <ul style="list-style-type: none"> <li>• <a href="#">Table B7-1 on page B7-1950</a> shows the encodings of all of the CPUID registers</li> <li>• <a href="#">Table B5-13 on page B5-1798</a> shows the encodings of all of the registers in the Identification registers functional group.</li> </ul>

The ID\_AFR0 bit assignments are:

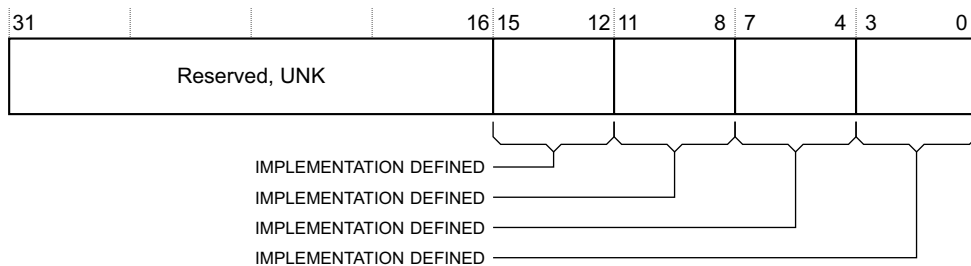

**Bits[31:16]** Reserved, UNK.

**IMPLEMENTATION DEFINED, bits[15:12]**

**IMPLEMENTATION DEFINED, bits[11:8]**

**IMPLEMENTATION DEFINED, bits[7:4]**

**IMPLEMENTATION DEFINED, bits[3:0]**

The Auxiliary Feature Register 0 has four 4-bit IMPLEMENTATION FIELDS. These fields are defined by the implementer of the design. The implementer is identified by the Implementer field of the [MIDR](#).

The Auxiliary Feature Register 0 enables implementers to include additional design features in the CPUID scheme. Field definitions for the Auxiliary Feature Register 0 might:

- differ between different implementers
- be subject to change
- migrate over time, for example if they are incorporated into the main architecture.

### Accessing ID\_AFR0

To access ID\_AFR0, software reads the CP15 registers with <opc1> set to 0, <CRn> set to c0, <CRm> set to c1, and <opc2> set to 3. For example:

```
MRC p15, 0, <Rt>, c0, c1, 3 ; Read ID_AFR0 into Rt
```

## B6.1.45 ID\_DFR0, Debug Feature Register 0, PMSA

The ID\_DFR0 characteristics are:

- Purpose** ID\_DFR0 provides top level information about the debug system.  
 This register is a CPUID register, and is part of the Identification registers functional group.
- Usage constraints** Only accessible from PL1.
- Configurations** The VMSA and PMSA definitions of the register fields are identical.
- Attributes** A 32-bit RO register with an IMPLEMENTATION DEFINED value:
- [Table B7-1 on page B7-1950](#) shows the encodings of all of the CPUID registers
  - [Table B5-13 on page B5-1798](#) shows the encodings of all of the registers in the Identification registers functional group.
- All field values not shown in the field descriptions are reserved.

The ID\_DFR0 bit assignments are:

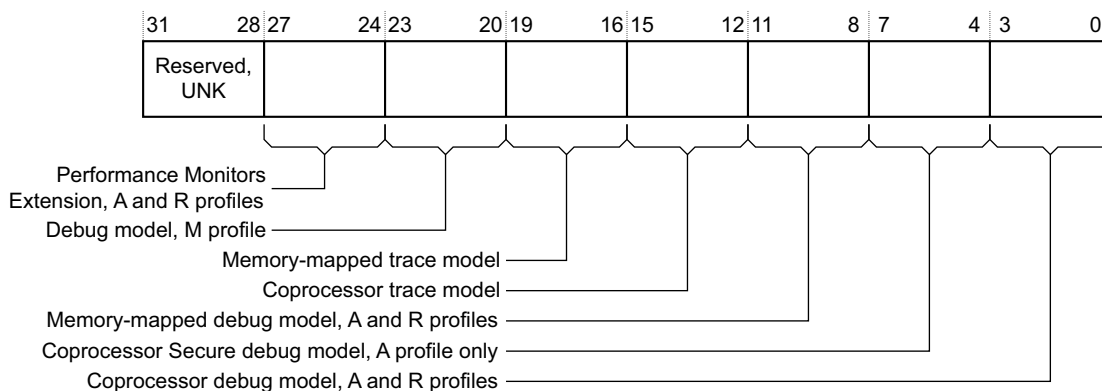

**Bits[31:28]** Reserved, UNK.

### Performance Monitors Extension, A and R profiles, bits[27:24]

Support for coprocessor-based ARM Performance Monitors Extension, for A and R profile processors. Permitted values are:

- 0b0000 PMUv2 not supported.
- 0b0001 Support for Performance Monitors Extension, PMUv1.
- 0b0010 Support for Performance Monitors Extension, PMUv2.
- 0b1111 No ARM Performance Monitors Extension support.

**Note**

A value of 0b0000 gives no indication of whether PMUv1 monitors are supported.

### Debug model, M profile, bits[23:20]

Support for memory-mapped debug model for M profile processors. Permitted values are:

- 0b0000 Not supported.
- 0b0001 Support for M profile Debug architecture, with memory-mapped access.

### Memory-mapped trace model, bits[19:16]

Support for memory-mapped trace model. Permitted values are:

- 0b0000 Not supported.
- 0b0001 Support for ARM trace architecture, with memory-mapped access.

The ID register, register 0x079, gives more information about the implementation. See also [Trace on page C1-2022](#).



#### Coprocessor trace model, bits[15:12]

Support for coprocessor-based trace model. Permitted values are:

0b0000 Not supported.

0b0001 Support for ARM trace architecture, with CP14 access.

The ID register, register 0x079, gives more information about the implementation. See also [Trace on page C1-2022](#).

#### Memory-mapped debug model, A and R profiles, bits[11:8]

Support for memory-mapped debug model, for A and R profile processors. Permitted values are:

0b0000 Not supported, or pre-ARMv6 implementation.

0b0100 Support for v7 Debug architecture, with memory-mapped access.

0b0101 Support for v7.1 Debug architecture, with memory-mapped access.

#### Note

The permitted field values are not continuous, and values 0b0001, 0b0010, and 0b0011 are reserved.

#### Coprocessor Secure debug model, bits[7:4]

Support for coprocessor-based Secure debug model, for an A profile processor that includes the Security Extensions. Permitted values are:

0b0000 Not supported.

0b0011 Support for v6.1 Debug architecture, with CP14 access.

0b0100 Support for v7 Debug architecture, with CP14 access.

0b0101 Support for v7.1 Debug architecture, with CP14 access.

#### Note

The permitted field values are not continuous, and values 0b0001 and 0b0010 are reserved.

#### Coprocessor debug model, bits[3:0]

Support for coprocessor based debug model, for A and R profile processors. Permitted values are:

0b0000 Not supported.

0b0010 Support for v6 Debug architecture, with CP14 access.

0b0011 Support for v6.1 Debug architecture, with CP14 access.

0b0100 Support for v7 Debug architecture, with CP14 access.

0b0101 Support for v7.1 Debug architecture, with CP14 access.

#### Note

The permitted field values are not continuous, and value 0b0001 is reserved.

#### Note

Software can obtain more information about the debug implementation from the debug infrastructure, see [Debug identification registers on page C11-2196](#).

### Accessing ID\_DFR0

To access ID\_DFR0, software reads the CP15 registers with <opc1> set to 0, <CRn> set to c0, <CRm> set to c1, and <opc2> set to 2. For example:

MRC p15, 0, <Rt>, c0, c1, 2 ; Read ID\_DFR0 into Rt

## B6.1.46 ID\_ISAR0, Instruction Set Attribute Register 0, PMSA

The ID\_ISAR0 characteristics are:

- Purpose** ID\_ISAR0 provides information about the instruction sets implemented by the processor. For more information see [About the Instruction Set Attribute registers on page B7-1950](#). This register is a CPUID register, and is part of the Identification registers functional group.
- Usage constraints** Only accessible from PL1.  
 Must be interpreted with ID\_ISAR1, ID\_ISAR2, ID\_ISAR3, and ID\_ISAR4. For more information see [About the Instruction Set Attribute registers on page B7-1950](#).
- Configurations** The VMSA and PMSA definitions of the register fields are identical.
- Attributes** A 32-bit RO register with an IMPLEMENTATION DEFINED value:
- [Table B7-1 on page B7-1950](#) shows the encodings of all of the CPUID registers
  - [Table B5-13 on page B5-1798](#) shows the encodings of all of the registers in the Identification registers functional group.
- All field values not shown in the field descriptions are reserved.

The ID\_ISAR0 bit assignments are:

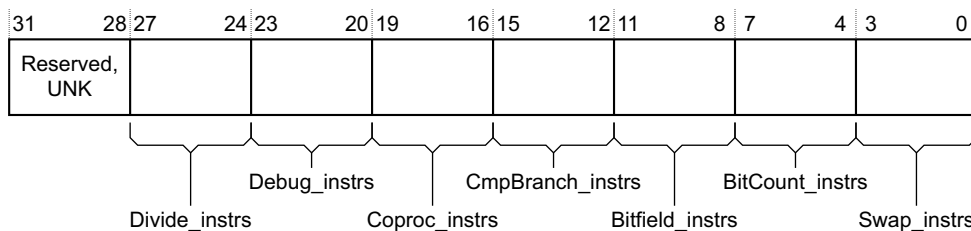

**Bits[31:28]** Reserved, UNK.

### Divide\_instrs, bits[27:24]

Indicates the implemented Divide instructions. Permitted values are:

- 0b0000 None implemented.
- 0b0001 Adds SDIV and UDIV in the Thumb instruction set.
- 0b0010 As for 0b0001, and adds SDIV and UDIV in the ARM instruction set.

### Debug\_instrs, bits[23:20]

Indicates the supported Debug instructions. Permitted values are:

- 0b0000 None implemented.
- 0b0001 Adds BKPT.

### Coproc\_instrs, bits[19:16]

Indicates the supported Coprocessor instructions. Permitted values are:

- 0b0000 None implemented, except for instructions separately attributed by the architecture, including CP15, CP14, and the Advanced SIMD and Floating-point Extensions.
- 0b0001 Adds generic CDP, LDC, MCR, MRC, and STC.
- 0b0010 As for 0b0001, and adds generic CDP2, LDC2, MCR2, MRC2, and STC2.
- 0b0011 As for 0b0010, and adds generic MCRR and MRRC.
- 0b0100 As for 0b0011, and adds generic MCRR2 and MRRC2.

### CmpBranch\_instrs, bits[15:12]

Indicates the implemented combined Compare and Branch instructions in the Thumb instruction set. Permitted values are:

- 0b0000 None implemented.
- 0b0001 Adds CBNZ and CBZ.

#### Bitfield\_instrs, bits[11:8]

Indicates the implemented BitField instructions. Permitted values are:

- 0b0000 None implemented.
- 0b0001 Adds BFC, BFI, SBFX, and UBFX.

#### BitCount\_instrs, bits[7:4]

Indicates the implemented Bit Counting instructions. Permitted values are:

- 0b0000 None implemented.
- 0b0001 Adds CLZ.

#### Swap\_instrs, bits[3:0]

Indicates the implemented Swap instructions in the ARM instruction set. Permitted values are:

- 0b0000 None implemented.
- 0b0001 Adds SWP and SWPB.

### Accessing ID\_ISAR0

To access ID\_ISAR0, software reads the CP15 registers with <opc1> set to 0, <CRn> set to c0, <CRm> set to c2, and <opc2> set to 0. For example:

```
MRC p15, 0, <Rt>, c0, c2, 0 ; Read ID_ISAR0 into Rt
```

## B6.1.47 ID\_ISAR1, Instruction Set Attribute Register 1, PMSA

The ID\_ISAR1 characteristics are:

<b>Purpose</b>	ID_ISAR1 provides information about the instruction sets implemented by the processor. For more information see <a href="#">About the Instruction Set Attribute registers on page B7-1950</a> . This register is a CPUID register, and is part of the Identification registers functional group.
<b>Usage constraints</b>	Only accessible from PL1. Must be interpreted with ID_ISAR0, ID_ISAR2, ID_ISAR3, and ID_ISAR4. For more information see <a href="#">About the Instruction Set Attribute registers on page B7-1950</a> .
<b>Configurations</b>	The VMSA and PMSA definitions of the register fields are identical.
<b>Attributes</b>	A 32-bit RO register with an IMPLEMENTATION DEFINED value: <ul style="list-style-type: none"> <li>• <a href="#">Table B7-1 on page B7-1950</a> shows the encodings of all of the CPUID registers</li> <li>• <a href="#">Table B5-13 on page B5-1798</a> shows the encodings of all of the registers in the Identification registers functional group.</li> </ul> All field values not shown in the field descriptions are reserved.

The ID\_ISAR1 bit assignments are:

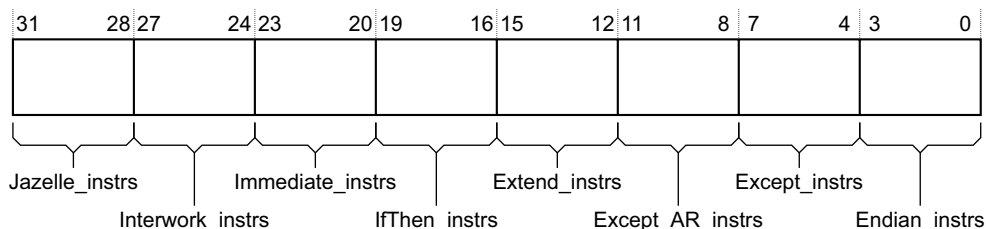

### Jazelle\_instrs, bits[31:28]

Indicates the implemented Jazelle extension instructions. Permitted values are:

- 0b0000 No support for Jazelle.
- 0b0001 Adds the BXJ instruction, and the J bit in the PSR.  
This setting might indicate a trivial implementation of the Jazelle extension.

### Interwork\_instrs, bits[27:24]

Indicates the implemented Interworking instructions. Permitted values are:

- 0b0000 None implemented.
- 0b0001 Adds the BX instruction, and the T bit in the PSR.
- 0b0010 As for 0b0001, and adds the BLX instruction. PC loads have BX-like behavior.
- 0b0011 As for 0b0010, and guarantees that data-processing instructions in the ARM instruction set with the PC as the destination and the S bit clear have BX-like behavior.

### ————— Note —————

A value of 0b0000, 0b0001, or 0b0010 in this field does not guarantee that an ARM data-processing instruction with the PC as the destination and the S bit clear behaves like an old MOV PC instruction, ignoring bits[1:0] of the result. With these values of this field:

- if bits[1:0] of the result value are 0b00 then the processor remains in ARM state
- if bits[1:0] are 0b01, 0b10 or 0b11, the result must be treated as UNPREDICTABLE.

#### Immediate\_instrs, bits[23:20]

Indicates the implemented data-processing instructions with long immediates. Permitted values are:

0b0000 None implemented.

0b0001 Adds:

- the MOV<sub>T</sub> instruction
- the MOV instruction encodings with zero-extended 16-bit immediates
- the Thumb ADD and SUB instruction encodings with zero-extended 12-bit immediates, and the other ADD, ADR and SUB encodings cross-referenced by the pseudocode for those encodings.

#### IfThen\_instrs, bits[19:16]

Indicates the implemented If-Then instructions in the Thumb instruction set. Permitted values are:

0b0000 None implemented.

0b0001 Adds the IT instructions, and the IT bits in the PSRs.

#### Extend\_instrs, bits[15:12]

Indicates the implemented Extend instructions. Permitted values are:

0b0000 No scalar sign-extend or zero-extend instructions are supported, where scalar instructions means non-Advanced SIMD instructions.

0b0001 Adds the SXTB, SXT<sub>H</sub>, UXTB, and UXTH instructions.

0b0010 As for 0b0001, and adds the SXTB16, SXTAB, SXTAB16, SXTA<sub>H</sub>, UXTB16, UXTAB, UXTAB16, and UXTA<sub>H</sub> instructions.

#### Note

In addition:

- the shift options on these instructions are available only if the WithShifts\_instrs attribute is 0b0011 or greater
- the SXTAB16, SXTB16, UXTAB16, and UXTB16 instructions are implemented only if both:
  - the Extend\_instrs attribute is 0b0010 or greater
  - the SIMD\_instrs attribute is 0b0011 or greater.

#### Except\_AR\_instrs, bits[11:8]

Indicates the implemented A and R profile exception-handling instructions. Permitted values are:

0b0000 None implemented.

0b0001 Adds the SRS and RFE instructions, and the A and R profile forms of the CPS instruction.

#### Except\_instrs, bits[7:4]

Indicates the supported exception-handling instructions in the ARM instruction set. Permitted values are:

0b0000 Not implemented. This indicates that the User registers and exception return forms of the LDM and STM instructions are not implemented.

0b0001 Adds the LDM (exception return), LDM (User registers) and STM (User registers) instruction versions.

#### Endian\_instrs, bits[3:0]

Indicates the implemented Endian instructions. Permitted values are:

0b0000 None implemented.

0b0001 Adds the SETEND instruction, and the E bit in the PSRs.

### **Accessing ID\_ISAR1**

To access ID\_ISAR1, software reads the CP15 registers with <opc1> set to 0, <CRn> set to c0, <CRm> set to c2, and <opc2> set to 1. For example:

MRC p15, 0, <Rt>, c0, c2, 1 ; Read ID\_ISAR1 into Rt

## B6.1.48 ID\_ISAR2, Instruction Set Attribute Register 2, PMSA

The ID\_ISAR2 characteristics are:

<b>Purpose</b>	ID_ISAR2 provides information about the instruction sets implemented by the processor. For more information see <a href="#">About the Instruction Set Attribute registers on page B7-1950</a> . This register is a CPUID register, and is part of the Identification registers functional group.
<b>Usage constraints</b>	Only accessible from PL1. Must be interpreted with ID_ISAR0, ID_ISAR1, ID_ISAR3, and ID_ISAR4. For more information see <a href="#">About the Instruction Set Attribute registers on page B7-1950</a> .
<b>Configurations</b>	The VMSA and PMSA definitions of the register fields are identical.
<b>Attributes</b>	A 32-bit RO register with an IMPLEMENTATION DEFINED value: <ul style="list-style-type: none"> <li>• <a href="#">Table B7-1 on page B7-1950</a> shows the encodings of all of the CPUID registers</li> <li>• <a href="#">Table B5-13 on page B5-1798</a> shows the encodings of all of the registers in the Identification registers functional group.</li> </ul> All field values not shown in the field descriptions are reserved.

The ID\_ISAR2 bit assignments are:

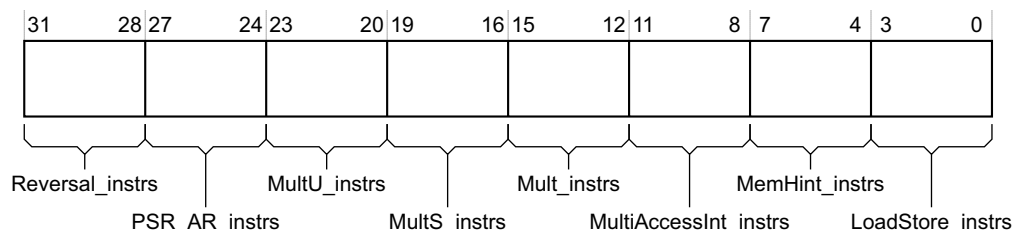

### Reversal\_instrs, bits[31:28]

Indicates the implemented Reversal instructions. Permitted values are:

- |        |   |
|--------|---|
| 0b0000 | None implemented.                             |
| 0b0001 | Adds the REV, REV16, and REVSH instructions.  |
| 0b0010 | As for 0b0001, and adds the RBIT instruction. |

### PSR\_AR\_instrs, bits[27:24]

Indicates the implemented A and R profile instructions to manipulate the PSR. Permitted values are:

- |        |   |
|--------|---|
| 0b0000 | None implemented.   |
| 0b0001 | Adds the MRS and MSR instructions, and the exception return forms of data-processing instructions described in <a href="#">SUBS PC, LR (Thumb) on page B9-2008</a> and <a href="#">SUBS PC, LR and related instructions (ARM) on page B9-2010</a> . |

#### ————— **Note** —————

The exception return forms of the data-processing instructions are:

- In the ARM instruction set, data-processing instructions with the PC as the destination and the S bit set. These instructions might be affected by the WithShifts attribute.
- In the Thumb instruction set, the SUBS PC, LR, #N instruction.

### MultU\_instrs, bits[23:20]

Indicates the implemented advanced unsigned Multiply instructions. Permitted values are:

- |        |  |
|--------|--|
| 0b0000 | None implemented.                              |
| 0b0001 | Adds the UMULL and UMLAL instructions.         |
| 0b0010 | As for 0b0001, and adds the UMAAL instruction. |

#### **MultS\_instrs, bits[19:16]**

Indicates the implemented advanced signed Multiply instructions. Permitted values are:

- 0b0000 None implemented.
- 0b0001 Adds the SMULL and SMLAL instructions.
- 0b0010 As for 0b0001, and adds the SMLABB, SMLABT, SMLALBB, SMLALBT, SMLALTB, SMLALTT, SMLATB, SMLATT, SMLAWB, SMLAWT, SMULBB, SMULBT, SMULTB, SMULTT, SMULWB, and SMULWT instructions. Also adds the Q bit in the PSRs.
- 0b0011 As for 0b0010, and adds the SMLAD, SMLADX, SMLALD, SMLALDX, SMLSD, SMLSDX, SMLSLD, SMLSLDX, SMMLA, SMMLAR, SMMLS, SMMLSR, SMMUL, SMMULR, SMUAD, SMUADX, SMUSD, and SMUSDX instructions.

#### **Mult\_instrs, bits[15:12]**

Indicates the implemented additional Multiply instructions. Permitted values are:

- 0b0000 No additional instructions implemented. This means only MUL is supported.
- 0b0001 Adds the MLA instruction.
- 0b0010 As for 0b0001, and adds the MLS instruction.

#### **MultiAccessInt\_instrs, bits[11:8]**

Indicates the support for interruptible multi-access instructions. Permitted values are:

- 0b0000 No support. This means the LDM and STM instructions are not interruptible.
- 0b0001 LDM and STM instructions are restartable.
- 0b0010 LDM and STM instructions are continuable.

#### **MemHint\_instrs, bits[7:4]**

Indicates the implemented Memory Hint instructions. Permitted values are:

- 0b0000 None implemented.
- 0b0001 Adds the PLD instruction.
- 0b0010 Adds the PLD instruction.  
In the MemHint\_instrs field, entries of 0b0001 and 0b0010 have identical meanings.
- 0b0011 As for 0b0001 (or 0b0010), and adds the PLI instruction.
- 0b0100 As for 0b0011, and adds the PLDW instruction.

#### **LoadStore\_instrs, bits[3:0]**

Indicates the implemented additional load/store instructions. Permitted values are:

- 0b0000 No additional load/store instructions implemented.
- 0b0001 Adds the LDRD and STRD instructions.

### **Accessing ID\_ISAR2**

To access ID\_ISAR2, software reads the CP15 registers with <opc1> set to 0, <CRn> set to c0, <CRm> set to c2, and <opc2> set to 2. For example:

```
MRC p15, 0, <Rt>, c0, c2, 2 ; Read ID_ISAR2 into Rt
```



## B6.1.49 ID\_ISAR3, Instruction Set Attribute Register 3, PMSA

The ID\_ISAR3 characteristics are:

<b>Purpose</b>	ID_ISAR3 provides information about the instruction sets implemented by the processor. For more information see <a href="#">About the Instruction Set Attribute registers on page B7-1950</a> . This register is a CPUID register, and is part of the Identification registers functional group.
<b>Usage constraints</b>	Only accessible from PL1. Must be interpreted with ID_ISAR0, ID_ISAR1, ID_ISAR2, and ID_ISAR4. For more information see <a href="#">About the Instruction Set Attribute registers on page B7-1950</a> .
<b>Configurations</b>	The VMSA and PMSA definitions of the register fields are identical.
<b>Attributes</b>	A 32-bit RO register with an IMPLEMENTATION DEFINED value: <ul style="list-style-type: none"> <li>• <a href="#">Table B7-1 on page B7-1950</a> shows the encodings of all of the CPUID registers</li> <li>• <a href="#">Table B5-13 on page B5-1798</a> shows the encodings of all of the registers in the Identification registers functional group.</li> </ul> All field values not shown in the field descriptions are reserved.

The ID\_ISAR3 bit assignments are:

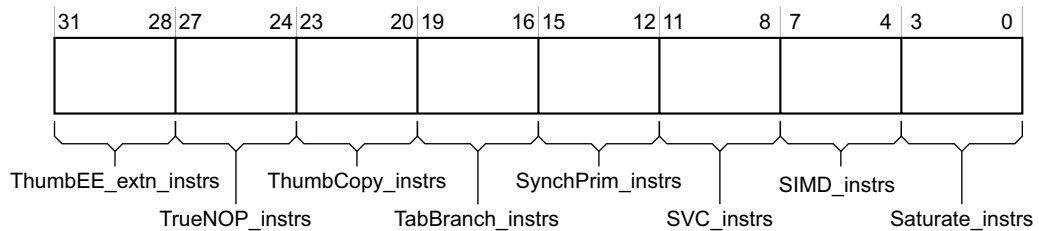

### ThumbEE\_extn\_instrs, bits[31:28]

Indicates the implemented Thumb Execution Environment (ThumbEE) Extension instructions.

Permitted values are:

- 0b0000 None implemented.
- 0b0001 Adds the ENTERX and LEAVEX instructions, and modifies the load behavior to include null checking.

———— **Note** ————

This field can only have a value other than 0b0000 when the ID\_PFR0.State3 field has a value of 0b0001.

### TrueNOP\_instrs, bits[27:24]

Indicates the implemented True NOP instructions. Permitted values are:

- 0b0000 None implemented. This means there are no NOP instructions that do not have any register dependencies.
- 0b0001 Adds true NOP instructions in both the Thumb and ARM instruction sets. This also permits additional NOP-compatible hints.

### ThumbCopy\_instrs, bits[23:20]

Indicates the support for Thumb non flag-setting MOV instructions. Permitted values are:

- 0b0000 Not supported. This means that in the Thumb instruction set, encoding T1 of the MOV (register) instruction does not support a copy from a low register to a low register.
- 0b0001 Adds support for Thumb instruction set encoding T1 of the MOV (register) instruction, copying from a low register to a low register.

**TabBranch\_instrs, bits[19:16]**

Indicates the implemented Table Branch instructions in the Thumb instruction set. Permitted values are:

- 0b0000 None implemented.
- 0b0001 Adds the TBB and TBH instructions.

**SynchPrim\_instrs, bits[15:12]**

This field is used with the [ID\\_ISAR4.SynchPrim\\_instrs\\_frac](#) field to indicate the implemented Synchronization Primitive instructions. [Table B6-3](#) shows the permitted values of these fields:

**Table B6-3 Implemented Synchronization Primitive instructions**

SynchPrim_instrs	SynchPrim_instrs_frac	Implemented Synchronization Primitives
0000	0000	None implemented
0001	0000	Adds the LDREX and STREX instructions
0001	0011	As for [0001, 0000], and adds the CLREX, LDREXB, LDREXH, STREXB, and STREXH instructions
0010	0000	As for [0001, 0011], and adds the LDREXD and STREXD instructions

All combinations of SynchPrim\_instrs and SynchPrim\_instrs\_frac not shown in [Table B6-3](#) are reserved.

**SVC\_instrs, bits[11:8]**

Indicates the implemented SVC instructions. Permitted values are:

- 0b0000 Not implemented.
- 0b0001 Adds the SVC instruction.

———— **Note** —————

The SVC instruction was called the SWI instruction in previous versions of the ARM architecture.

**SIMD\_instrs, bits[7:4]**

Indicates the implemented SIMD instructions. Permitted values are:

- 0b0000 None implemented.
- 0b0001 Adds the SSAT and USAT instructions, and the Q bit in the PSRs.
- 0b0011 As for 0b0001, and adds the PKHBT, PKHTB, QADD16, QADD8, QASX, QSUB16, QSUB8, QSAX, SADD16, SADD8, SASX, SEL, SHADD16, SHADD8, SHASX, SHSUB16, SHSUB8, SHSAX, SSAT16, SSUB16, SSUB8, SSAX, SXTAB16, SXTB16, UADD16, UADD8, UASX, UHADD16, UHADD8, UHASX, UHSUB16, UHSUB8, UHSAX, UQADD16, UQADD8, UQASX, UQSUB16, UQSUB8, UQSAX, USAD8, USADA8, USAT16, USUB16, USUB8, USAX, UXTAB16, and UXTB16 instructions.

Also adds support for the GE[3:0] bits in the PSRs.

———— **Note** —————

- In the SIMD\_instrs field, the permitted values are not continuous, and the value 0b0010 is reserved.
- The SXTAB16, SXTB16, UXTAB16, and UXTB16 instructions are implemented only if both:
  - the Extend\_instrs attribute is 0b0010 or greater
  - the SIMD\_instrs attribute is 0b0011 or greater.
- The SIMD\_instrs field relates only to implemented instructions that perform SIMD operations on the ARM core registers. [MVFR0](#) and [MVFR1](#) give information about the SIMD instructions implemented by the OPTIONAL Advanced SIMD Extension.

### Saturate\_instrs, bits[3:0]

Indicates the implemented Saturate instructions. Permitted values are:

- 0b0000 None implemented. This means no non-Advanced SIMD saturate instructions are implemented.
- 0b0001 Adds the QADD, QDADD, QDSUB, and QSUB instructions, and the Q bit in the PSRs.

### Accessing ID\_ISAR3

To access ID\_ISAR3, software reads the CP15 registers with <opc1> set to 0, <CRn> set to c0, <CRm> set to c2, and <opc2> set to 3. For example:

```
MRC p15, 0, <Rt>, c0, c2, 3 ; Read ID_ISAR3 into Rt
```

## B6.1.50 ID\_ISAR4, Instruction Set Attribute Register 4, PMSA

The ID\_ISAR4 characteristics are:

<b>Purpose</b>	ID_ISAR4 provides information about the instruction sets implemented by the processor. For more information see <a href="#">About the Instruction Set Attribute registers on page B7-1950</a> . This register is a CPUID register, and is part of the Identification registers functional group.
<b>Usage constraints</b>	Only accessible from PL1. Must be interpreted with ID_ISAR0, ID_ISAR1, ID_ISAR2, and ID_ISAR3. For more information see <a href="#">About the Instruction Set Attribute registers on page B7-1950</a> .
<b>Configurations</b>	The VMSA and PMSA definitions of the register fields are identical.
<b>Attributes</b>	A 32-bit RO register with an IMPLEMENTATION DEFINED value: <ul style="list-style-type: none"> <li>• <a href="#">Table B7-1 on page B7-1950</a> shows the encodings of all of the CPUID registers</li> <li>• <a href="#">Table B5-13 on page B5-1798</a> shows the encodings of all of the registers in the Identification registers functional group.</li> </ul> All field values not shown in the field descriptions are reserved.

The ID\_ISAR4 bit assignments are:

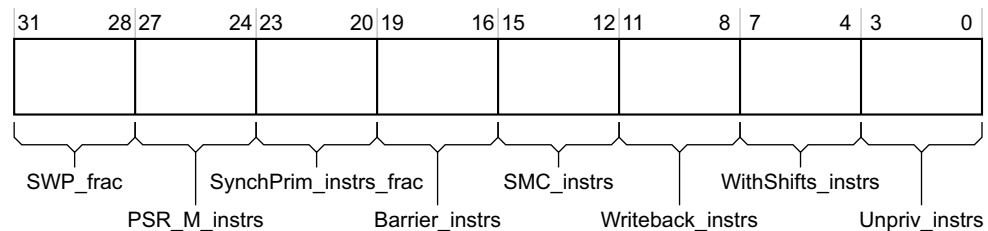

### SWP\_frac, bits[31:28]

Indicates support for the memory system locking the bus for SWP or SWPB instructions. Permitted values are:

- 0b0000 SWP or SWPB instructions not implemented.
- 0b0001 SWP or SWPB implemented but only in a uniprocessor context. SWP and SWPB do not guarantee whether memory accesses from other masters can come between the load memory access and the store memory access of the SWP or SWPB.

This field is valid only if the ID\_ISAR0.Swap\_instrs field is zero.

### PSR\_M\_instrs, bits[27:24]

Indicates the implemented M profile instructions to modify the PSRs. Permitted values are:

- 0b0000 None implemented.
- 0b0001 Adds the M profile forms of the CPS, MRS and MSR instructions.

### SynchPrim\_instrs\_frac, bits[23:20]

This field is used with the ID\_ISAR3.SynchPrim\_instrs field to indicate the implemented Synchronization Primitive instructions. [Table B6-3 on page B6-1862](#) shows the permitted values of these fields.

All combinations of SynchPrim\_instrs and SynchPrim\_instrs\_frac not shown in [Table B6-3 on page B6-1862](#) are reserved.

### Barrier\_instrs, bits[19:16]

Indicates the implemented Barrier instructions in the ARM and Thumb instruction sets. Permitted values are:

- 0b0000 None implemented. Barrier operations are provided only as CP15 operations.
- 0b0001 Adds the DMB, DSB, and ISB barrier instructions.

#### SMC\_instrs, bits[15:12]

Indicates the implemented SMC instructions. Permitted values are:

- 0b0000 Not implemented.
- 0b0001 Adds the SMC instruction.

———— **Note** ————

The SMC instruction was called the SMI instruction in previous versions of the ARM architecture.

#### Writeback\_instrs, bits[11:8]

Indicates the support for Writeback addressing modes. Permitted values are:

- 0b0000 Basic support. Only the LDM, STM, PUSH, POP, SRS, and RFE instructions support writeback addressing modes. These instructions support all of their writeback addressing modes.
- 0b0001 Adds support for all of the writeback addressing modes defined in ARMv7.

#### WithShifts\_instrs, bits[7:4]

Indicates the support for instructions with shifts. Permitted values are:

- 0b0000 Nonzero shifts supported only in MOV and shift instructions.
- 0b0001 Adds support for shifts of loads and stores over the range LSL 0-3.
- 0b0011 As for 0b0001, and adds support for other constant shift options, both on load/store and other instructions.
- 0b0100 As for 0b0011, and adds support for register-controlled shift options.

———— **Note** ————

- In this field, the permitted values are not continuous, and the value 0b0010 is reserved.
- Additions to the basic support indicated by the 0b0000 field value only apply when the encoding supports them. In particular, in the Thumb instruction set there is no difference between the 0b0011 and 0b0100 levels of support.
- MOV instructions with shift options are treated as ASR, LSL, LSR, ROR or RRX instructions, as described in [Data-processing instructions on page B7-1951](#).

#### Unpriv\_instrs, bits[3:0]

Indicates the implemented unprivileged instructions. Permitted values are:

- 0b0000 None implemented. No T variant instructions are implemented.
- 0b0001 Adds the LDRBT, LDRT, STRBT, and STRT instructions.
- 0b0010 As for 0b0001, and adds the LDRHT, LDRSBT, LDRSHT, and STRHT instructions.

#### Accessing ID\_ISAR4

To access ID\_ISAR4, software reads the CP15 registers with <opc1> set to 0, <CRn> set to c0, <CRm> set to c2, and <opc2> set to 4. For example:

MRC p15, 0, <Rt>, c0, c2, 4 ; Read ID\_ISAR4 into Rt

### B6.1.51 ID\_ISAR5, Instruction Set Attribute Register 5, PMSA

The ID\_ISAR5 characteristics are:

- Purpose** ID\_ISAR5 is reserved for future expansion of the information about the instruction sets implemented by the processor.  
This register is a CPUID register, and is part of the Identification registers functional group.
- Usage constraints** Only accessible from PL1.
- Configurations** The VMSA and PMSA definitions of the register fields are identical.
- Attributes** A 32-bit RO register:
- [Table B7-1 on page B7-1950](#) shows the encodings of all of the CPUID registers
  - [Table B5-13 on page B5-1798](#) shows the encodings of all of the registers in the Identification registers functional group.

The ID\_ISAR5 bit assignments are:



**Bits[31:0]** Reserved, UNK.

#### Accessing ID\_ISAR5

To access ID\_ISAR5, software reads the CP15 registers with <opc1> set to 0, <CRn> set to c0, <CRm> set to c2, and <opc2> set to 5. For example:

MRC p15, 0, <Rt>, c0, c2, 5 ; Read ID\_ISAR5 into Rt

## B6.1.52 ID\_MMFR0, Memory Model Feature Register 0, PMSA

The ID\_MMFR0 characteristics are:

- Purpose** ID\_MMFR0 provides information about the implemented memory model and memory management support.  
 This register is a CPUID register, and is part of the Identification registers functional group.
- Usage constraints** Only accessible from PL1.  
 Must be interpreted with ID\_MMFR1, ID\_MMFR2, and ID\_MMFR3.
- Configurations** The VMSA and PMSA definitions of the register fields are identical.
- Attributes** A 32-bit RO register with an IMPLEMENTATION DEFINED value:
- [Table B7-1 on page B7-1950](#) shows the encodings of all of the CPUID registers
  - [Table B5-13 on page B5-1798](#) shows the encodings of all of the registers in the Identification registers functional group.
- All field values not shown in the field descriptions are reserved.

The ID\_MMFR0 bit assignments are:

31	28	27	24	23	20	19	16	15	12	11	8	7	4	3	0
Innermost shareability	FCSE support		Auxiliary registers		TCM support		Shareability levels		Outermost shareability		PMSA support		VMSA support		

### Innermost shareability, bits[31:28]

Indicates the innermost shareability domain implemented. Permitted values are:

- 0b0000 Implemented as Non-cacheable.
- 0b0001 Implemented with hardware coherency support.
- 0b1111 Shareability ignored.

This field is valid only if the implementation distinguishes between Inner Shareable and Outer Shareable, by implementing two levels of shareability, as indicated by the value of the Shareability levels field, bits[15:12].

When the Shareability levels field is zero, this field is reserved, UNK.

### FCSE support, bits[27:24]

Indicates whether the implementation includes the FCSE. Permitted values are:

- 0b0000 Not supported.
- 0b0001 Support for FCSE.

The value of 0b0001 is only permitted when the VMSA\_support field has a value greater than 0b0010.

### Auxiliary registers, bits[23:20]

Indicates support for Auxiliary registers. Permitted values are:

- 0b0000 None supported.
- 0b0001 Support for Auxiliary Control Register only.
- 0b0010 Support for Auxiliary Fault Status Registers (AIFSR and ADFSR) and Auxiliary Control Register.

### TCM support, bits[19:16]

Indicates support for TCMs and associated DMAs. Permitted values are:

- 0b0000 Not supported.
- 0b0001 Support is IMPLEMENTATION DEFINED. ARMv7 requires this setting.
- 0b0010 Support for TCM only, ARMv6 implementation.
- 0b0011 Support for TCM and DMA, ARMv6 implementation.

#### ———— Note —————

An ARMv7 implementation might include an ARMv6 model for TCM support. However, in ARMv7 this is an IMPLEMENTATION DEFINED option, and therefore it must be represented by the 0b0001 encoding in this field.

### Shareability levels, bits[15:12]

Indicates the number of shareability levels implemented. Permitted values are:

- 0b0000 One level of shareability implemented.
- 0b0001 Two levels of shareability implemented.

### Outermost shareability, bits[11:8]

Indicates the outermost shareability domain implemented. Permitted values are:

- 0b0000 Implemented as Non-cacheable.
- 0b0001 Implemented with hardware coherency support.
- 0b1111 Shareability ignored.

### PMSA support, bits[7:4]

Indicates support for a PMSA. Permitted values are:

- 0b0000 Not supported.
- 0b0001 Support for IMPLEMENTATION DEFINED PMSA.
- 0b0010 Support for PMSAv6, with a Cache Type Register implemented.
- 0b0011 Support for PMSAv7, with support for memory subsections. ARMv7-R profile.

When the PMSA support field is set to a value other than 0b0000 the VMSA support field must be set to 0b0000.

### VMSA support, bits[3:0]

Indicates support for a VMSA. Permitted values are:

- 0b0000 Not supported.
- 0b0001 Support for IMPLEMENTATION DEFINED VMSA.
- 0b0010 Support for VMSAv6, with Cache and TLB Type Registers implemented.
- 0b0011 Support for VMSAv7, with support for remapping and the Access flag. ARMv7-A profile.
- 0b0100 As for 0b0011, and adds support for the PXN bit in the Short-descriptor translation table format descriptors.
- 0b0101 As for 0b0100, and adds support for the Long-descriptor translation table format.

When the VMSA support field is set to a value other than 0b0000 the PMSA support field must be set to 0b0000.

## Accessing ID\_MMFR0

To access ID\_MMFR0, software reads the CP15 registers with <opc1> set to 0, <CRn> set to c0, <CRm> set to c1, and <opc2> set to 4. For example:

MRC p15, 0, <Rt>, c0, c1, 4 ; Read ID\_MMFR0 into Rt



### B6.1.53 ID\_MMFR1, Memory Model Feature Register 1, PMSA

The ID\_MMFR1 characteristics are:

- Purpose** ID\_MMFR1 provides information about the implemented memory model and memory management support.  
 This register is a CPUID register, and is part of the Identification registers functional group.
- Usage constraints** Only accessible from PL1.  
 Must be interpreted with ID\_MMFR0, ID\_MMFR2, and ID\_MMFR3.
- Configurations** The VMSA and PMSA definitions of the register fields are identical.
- Attributes** A 32-bit RO register with an IMPLEMENTATION DEFINED value:
- [Table B7-1 on page B7-1950](#) shows the encodings of all of the CPUID registers
  - [Table B5-13 on page B5-1798](#) shows the encodings of all of the registers in the Identification registers functional group.
- All field values not shown in the field descriptions are reserved.

The ID\_MMFR1 bit assignments are:

31	28	27	24	23	20	19	16	15	12	11	8	7	4	3	0
Branch predictor	L1 cache test and clean	L1 unified cache	L1 Harvard cache	L1 unified cache set/way	L1 Harvard cache set/way	L1 unified cache VA	L1 Harvard cache VA								

#### Branch predictor, bits[31:28]

Indicates branch predictor management requirements. Permitted values are:

- 0b0000 No branch predictor, or no MMU present. Implies a fixed MPU configuration.
- 0b0001 Branch predictor requires flushing on:
- enabling or disabling the MMU
  - writing new data to instruction locations
  - writing new mappings to the translation tables
  - any change to the [TTBR0](#), [TTBR1](#), or [TTBCR](#) registers
  - changes of FCSE ProcessID or ContextID.
- 0b0010 Branch predictor requires flushing on:
- enabling or disabling the MMU
  - writing new data to instruction locations
  - writing new mappings to the translation tables
  - any change to the [TTBR0](#), [TTBR1](#), or [TTBCR](#) registers without a corresponding change to the FCSE ProcessID or ContextID.
- 0b0011 Branch predictor requires flushing only on writing new data to instruction locations.
- 0b0100 For execution correctness, branch predictor requires no flushing at any time.

———— **Note** —————

The branch predictor is described in some documentation as the Branch Target Buffer.

#### L1 cache test and clean, bits[27:24]

Indicates the supported Level 1 data cache test and clean operations, for Harvard or unified cache implementations. Permitted values are:

- 0b0000 None supported. This is the required setting for ARMv7.
- 0b0001 Supported Level 1 data cache test and clean operations are:
  - Test and clean data cache.
- 0b0010 As for 0b0001, and adds:
  - Test, clean, and invalidate data cache.

#### L1 unified cache, bits[23:20]

Indicates the supported entire Level 1 cache maintenance operations, for a unified cache implementation. Permitted values are:

- 0b0000 None supported. This is the required setting for ARMv7, because ARMv7 requires a hierarchical cache implementation.
- 0b0001 Supported entire Level 1 cache operations are:
  - Invalidate cache, including branch predictor if appropriate
  - Invalidate branch predictor, if appropriate.
- 0b0010 As for 0b0001, and adds:
  - Clean cache. Uses a recursive model, using the cache dirty status bit.
  - Clean and invalidate cache. Uses a recursive model, using the cache dirty status bit.

If this field is set to a value other than 0b0000 then the L1 Harvard cache field, bits[19:16], must be set to 0b0000.

#### L1 Harvard cache, bits[19:16]

Indicates the supported entire Level 1 cache maintenance operations, for a Harvard cache implementation. Permitted values are:

- 0b0000 None supported. This is the required setting for ARMv7, because ARMv7 requires a hierarchical cache implementation.
- 0b0001 Supported entire Level 1 cache operations are:
  - Invalidate instruction cache, including branch predictor if appropriate
  - Invalidate branch predictor, if appropriate.
- 0b0010 As for 0b0001, and adds:
  - Invalidate data cache
  - Invalidate data cache and instruction cache, including branch predictor if appropriate.
- 0b0011 As for 0b0010, and adds:
  - Clean data cache. Uses a recursive model, using the cache dirty status bit.
  - Clean and invalidate data cache. Uses a recursive model, using the cache dirty status bit.

If this field is set to a value other than 0b0000 then the L1 unified cache field, bits[23:20], must be set to 0b0000.

#### L1 unified cache set/way, bits[15:12]

Indicates the supported Level 1 cache line maintenance operations by set/way, for a unified cache implementation. Permitted values are:

- 0b0000 None supported. This is the required setting for ARMv7, because ARMv7 requires a hierarchical cache implementation.
- 0b0001 Supported Level 1 unified cache line maintenance operations by set/way are:
- Clean cache line by set/way.
- 0b0010 As for 0b0001, and adds:
- Clean and invalidate cache line by set/way.
- 0b0011 As for 0b0010, and adds:
- Invalidate cache line by set/way.

If this field is set to a value other than 0b0000 then the L1 Harvard cache s/w field, bits[11:8], must be set to 0b0000.

#### L1 Harvard cache set/way, bits[11:8]

Indicates the supported Level 1 cache line maintenance operations by set/way, for a Harvard cache implementation. Permitted values are:

- 0b0000 None supported. This is the required setting for ARMv7, because ARMv7 requires a hierarchical cache implementation.
- 0b0001 Supported Level 1 Harvard cache line maintenance operations by set/way are:
- Clean data cache line by set/way
  - Clean and invalidate data cache line by set/way.
- 0b0010 As for 0b0001, and adds:
- Invalidate data cache line by set/way.
- 0b0011 As for 0b0010, and adds:
- Invalidate instruction cache line by set/way.

If this field is set to a value other than 0b0000 then the L1 unified cache s/w field, bits[15:12], must be set to 0b0000.

#### L1 unified cache VA, bits[7:4]

Indicates the supported Level 1 cache line maintenance operations by MVA, for a unified cache implementation. Permitted values are:

- 0b0000 None supported. This is the required setting for ARMv7, because ARMv7 requires a hierarchical cache implementation.
- 0b0001 Supported Level 1 unified cache line maintenance operations by MVA are:
- Clean cache line by MVA
  - Invalidate cache line by MVA
  - Clean and invalidate cache line by MVA.
- 0b0010 As for 0b0001, and adds:
- Invalidate branch predictor by MVA, if branch predictor is implemented.

If this field is set to a value other than 0b0000 then the L1 Harvard cache VA field, bits[3:0], must be set to 0b0000.

### L1 Harvard cache VA, bits[3:0]

Indicates the supported Level 1 cache line maintenance operations by MVA, for a Harvard cache implementation. Permitted values are:

- 0b0000 None supported. This is the required setting for ARMv7, because ARMv7 requires a hierarchical cache implementation.
- 0b0001 Supported Level 1 Harvard cache line maintenance operations by MVA are:
- Clean data cache line by MVA
  - Invalidate data cache line by MVA
  - Clean and invalidate data cache line by MVA
  - Clean instruction cache line by MVA.
- 0b0010 As for 0b0001, and adds:
- Invalidate branch predictor by MVA, if branch predictor is implemented.

If this field is set to a value other than 0b0000 then the L1 unified cache VA field, bits[7:4], must be set to 0b0000.

### Accessing ID\_MMFR1

To access ID\_MMFR1, software reads the CP15 registers with <opc1> set to 0, <CRn> set to c0, <CRm> set to c1, and <opc2> set to 5. For example:

```
MRC p15, 0, <Rt>, c0, c1, 5 ; Read ID_MMFR1 into Rt
```

## B6.1.54 ID\_MMFR2, Memory Model Feature Register 2, PMSA

The ID\_MMFR2 characteristics are:

- Purpose** ID\_MMFR2 provides information about the implemented memory model and memory management support.  
 This register is a CPUID register, and is part of the Identification registers functional group.
- Usage constraints** Only accessible from PL1.  
 Must be interpreted with ID\_MMFR0, ID\_MMFR1, and ID\_MMFR3.
- Configurations** The VMSA and PMSA definitions of the register fields are identical.
- Attributes** A 32-bit RO register with an IMPLEMENTATION DEFINED value:
- [Table B7-1 on page B7-1950](#) shows the encodings of all of the CPUID registers
  - [Table B5-13 on page B5-1798](#) shows the encodings of all of the registers in the Identification registers functional group.
- All field values not shown in the field descriptions are reserved.

The ID\_MMFR2 bit assignments are:

31	28	27	24	23	20	19	16	15	12	11	8	7	4	3	0
HW Access flag		WFI stall		Mem barrier		Unified TLB		Harvard TLB		L1 Harvard range		L1 Harvard bg fetch		L1 Harvard fg fetch	

### HW Access flag, bits[31:28]

Indicates support for a Hardware Access flag, as part of the VMSAv7 implementation. Permitted values are:

- 0b0000 Not supported.
- 0b0001 Support for VMSAv7 Access flag, updated in hardware.

On an ARMv7-R implementation this field must be 0b0000.

### WFI stall, bits[27:24]

Indicates the support for Wait For Interrupt (WFI) stalling. Permitted values are:

- 0b0000 Not supported.
- 0b0001 Support for WFI stalling.

### Mem barrier, bits[23:20]

Indicates the supported CP15 memory barrier operations:

- 0b0000 None supported.
- 0b0001 Supported CP15 Memory barrier operations are:
  - Data Synchronization Barrier (DSB). In previous versions of the ARM architecture, DSB was named Data Write Barrier (DWB).
- 0b0010 As for 0b0001, and adds:
  - Instruction Synchronization Barrier (ISB). In previous versions of the ARM architecture, the ISB operation was called Prefetch Flush.
  - Data Memory Barrier (DMB).

#### Note

ARM deprecates the use of these operations. ID\_ISAR4.BarrierInstrs indicates the level of support for the preferred barrier instructions.

### Unified TLB, bits[19:16]

Indicates the supported TLB maintenance operations, for a unified or Harvard TLB implementation. Permitted values are:

- 0b0000 Not supported.
- 0b0001 Supported unified TLB maintenance operations are:
  - Invalidate all entries in the TLB
  - Invalidate TLB entry by MVA.
- 0b0010 As for 0b0001, and adds:
  - Invalidate TLB entries by ASID match.
- 0b0011 As for 0b0010 and adds:
  - Invalidate instruction TLB and data TLB entries by MVA All ASID. This is a shared unified TLB operation.
- 0b0100 As for 0b0011 and adds:
  - Invalidate Hyp mode unified TLB entry by MVA
  - Invalidate entire Non-secure PL1&0 unified TLB
  - Invalidate entire Hyp mode unified TLB.

If this field is set to a value other than 0b0000 then the Harvard TLB field, bits[15:12], must be set to 0b0000.

### Harvard TLB, bits[15:12]

Indicates the supported TLB maintenance operations, for a Harvard TLB implementation. Permitted values are:

- 0b0000 Not supported.
- 0b0001 Supported Harvard TLB maintenance operations are:
  - Invalidate all entries in the ITLB and the DTLB. This is a shared unified TLB operation.
  - Invalidate all ITLB entries.
  - Invalidate all DTLB entries.
  - Invalidate ITLB entry by MVA.
  - Invalidate DTLB entry by MVA.
- 0b0010 As for 0b0001, and adds:
  - Invalidate ITLB and DTLB entries by ASID match. This is a shared unified TLB operation.
  - Invalidate ITLB entries by ASID match
  - Invalidate DTLB entries by ASID match.

If this field is set to a value other than 0b0000 then the Unified TLB field, bits[19:16], must be set to 0b0000.

#### ———— **Note** —————

This field is defined only for legacy reasons. It is replaced by the Unified TLB field, bits[19:16].

### L1 Harvard range, bits[11:8]

Indicates the supported Level 1 cache maintenance range operations, for a Harvard cache implementation. Permitted values are:

- 0b0000 Not supported.
- 0b0001 Supported Level 1 Harvard cache maintenance range operations are:
  - Invalidate data cache range by VA
  - Invalidate instruction cache range by VA
  - Clean data cache range by VA
  - Clean and invalidate data cache range by VA.

#### L1 Harvard bg fetch, bits[7:4]

Indicates the supported Level 1 cache background fetch operations, for a Harvard cache implementation. When supported, background fetch operations are non-blocking operations.

Permitted values are:

0b0000 Not supported.

0b0001 Supported Level 1 Harvard cache background fetch operations are:

- Fetch instruction cache range by VA
- Fetch data cache range by VA.

#### L1 Harvard fg fetch, bits[3:0]

Indicates the supported Level 1 cache foreground fetch operations, for a Harvard cache implementation. When supported, foreground fetch operations are blocking operations. Permitted values are:

0b0000 Not supported.

0b0001 Supported Level 1 Harvard cache foreground fetch operations are:

- Fetch instruction cache range by VA
- Fetch data cache range by VA.

### Accessing ID\_MMFR2

To access ID\_MMFR2, software reads the CP15 registers with <opc1> set to 0, <CRn> set to c0, <CRm> set to c1, and <opc2> set to 6. For example:

```
MRC p15, 0, <Rt>, c0, c1, 6 ; Read ID_MMFR2 into Rt
```

### B6.1.55 ID\_MMFR3, Memory Model Feature Register 3, PMSA

The ID\_MMFR3 characteristics are:

- Purpose** ID\_MMFR3 provides information about the implemented memory model and memory management support.  
 This register is a CPUID register, and is part of the Identification registers functional group.
- Usage constraints** Only accessible from PL1.  
 Must be interpreted with ID\_MMFR0, ID\_MMFR1, and ID\_MMFR2.
- Configurations** The VMSA and PMSA definitions of the register fields are identical.
- Attributes** A 32-bit RO register with an IMPLEMENTATION DEFINED value:
  - Table B7-1 on page B7-1950 shows the encodings of all of the CPUID registers
  - Table B5-13 on page B5-1798 shows the encodings of all of the registers in the Identification registers functional group.
 All field values not shown in the field descriptions are reserved.

The ID\_MMFR3 bit assignments are:

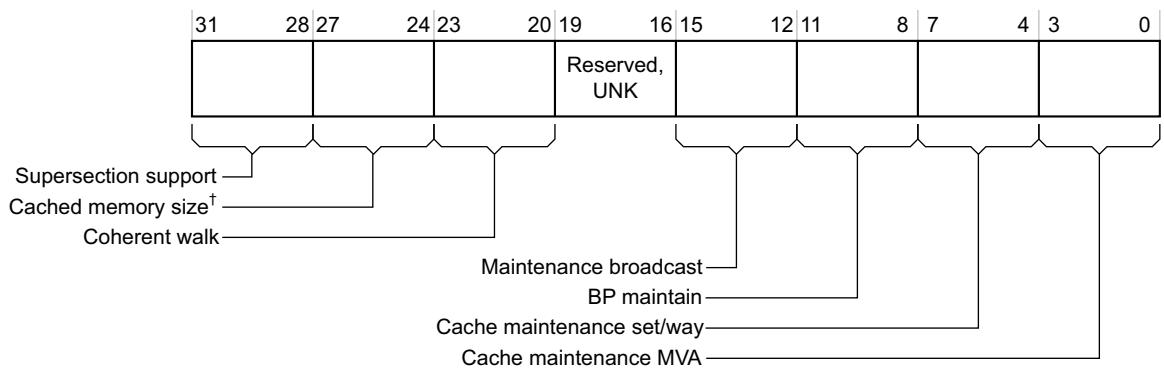

<sup>†</sup> Only on an implementation that includes the Large Physical Address Extension, otherwise reserved.

#### Supersection support, bits[31:28]

On a VMSA implementation, indicates whether Supersections are supported. Permitted values are:

- 0b0000 Supersections supported.
- 0b1111 Supersections not supported.

#### Note

The sense of this identification is reversed from the normal usage in the CPUID mechanism, with the value of zero indicating that the feature is supported.

#### Cached memory size, bits[27:24]

Indicates the physical memory size supported by the processor caches. Permitted values are:

- 0b0000 4GByte, corresponding to a 32-bit physical address range.
- 0b0001 64GByte, corresponding to a 36-bit physical address range.
- 0b0010 1TByte, corresponding to a 40-bit physical address range.



#### Coherent walk, bits[23:20]

Indicates whether translation table updates require a clean to the point of unification. Permitted values are:

- 0b0000 Updates to the translation tables require a clean to the point of unification to ensure visibility by subsequent translation table walks.
- 0b0001 Updates to the translation tables do not require a clean to the point of unification to ensure visibility by subsequent translation table walks.

**Bits[19:16]** Reserved, UNK.

#### Maintenance broadcast, bits[15:12]

Indicates whether Cache, TLB and branch predictor operations are broadcast. Permitted values are:

- 0b0000 Cache, TLB and branch predictor operations only affect local structures.
- 0b0001 Cache and branch predictor operations affect structures according to shareability and defined behavior of instructions. TLB operations only affect local structures.
- 0b0010 Cache, TLB and branch predictor operations affect structures according to shareability and defined behavior of instructions.

#### BP maintain, bits[11:8]

Indicates the supported branch predictor maintenance operations in an implementation with hierarchical cache maintenance operations. Permitted values are:

- 0b0000 None supported.
- 0b0001 Supported branch predictor maintenance operations are:
  - Invalidate all branch predictors.
- 0b0010 As for 0b0001, and adds:
  - Invalidate branch predictors by MVA.

#### Cache maintain set/way, bits[7:4]

Indicates the supported cache maintenance operations by set/way, in an implementation with hierarchical caches. Permitted values are:

- 0b0000 None supported.
- 0b0001 Supported hierarchical cache maintenance operations by set/way are:
  - Invalidate data cache by set/way
  - Clean data cache by set/way
  - Clean and invalidate data cache by set/way.

In a unified cache implementation, the data cache operations apply to the unified caches.

#### Cache maintain MVA, bits[3:0]

Indicates the supported cache maintenance operations by MVA, in an implementation with hierarchical caches. Permitted values are:

- 0b0000 None supported.
- 0b0001 Supported hierarchical cache maintenance operations by MVA are:
  - Invalidate data cache by MVA
  - Clean data cache by MVA
  - Clean and invalidate data cache by MVA
  - Invalidate instruction cache by MVA
  - Invalidate all instruction cache entries.

In a unified cache implementation, the data cache operations apply to the unified caches, and the instruction cache operations are not implemented.

### Accessing ID\_MMFR3

To access ID\_MMFR3, software reads the CP15 registers with <opc1> set to 0, <CRn> set to c0, <CRm> set to c1, and <opc2> set to 7. For example:

```
MRC p15, 0, <Rt>, c0, c1, 7 ; Read ID_MMFR3 into Rt
```

## B6.1.56 ID\_PFR0, Processor Feature Register 0, PMSA

The ID\_PFR0 characteristics are:

<b>Purpose</b>	ID_PFR0 gives information about the programmers' model and top-level information about the instruction sets supported by the processor. This register is a CPUID register, and is part of the Identification registers functional group.
<b>Usage constraints</b>	Only accessible from PL1. Must be interpreted with <a href="#">ID_PFR1</a> .
<b>Configurations</b>	The VMSA and PMSA definitions of the register fields are identical.
<b>Attributes</b>	A 32-bit RO register with an IMPLEMENTATION DEFINED value: <ul style="list-style-type: none"> <li>• <a href="#">Table B7-1 on page B7-1950</a> shows the encodings of all of the CPUID registers</li> <li>• <a href="#">Table B5-13 on page B5-1798</a> shows the encodings of all of the registers in the Identification registers functional group.</li> </ul> All field values not shown in the field descriptions are reserved.

The ID\_PFR0 bit assignments are:

31				16	15			12	11			8	7			4	3	0	
Reserved, UNK					State3		State2		State1		State0								

**Bits[31:16]** Reserved, UNK.

### State3, bits[15:12]

ThumbEE instruction set support. Permitted values are:

- 0b0000 Not implemented.
- 0b0001 ThumbEE instruction set implemented.

The value of 0b0001 is only permitted when State1 == 0b0011.

### State2, bits[11:8]

Jazelle extension support. Permitted values are:

- 0b0000 Not implemented.
- 0b0001 Jazelle extension implemented, without clearing of [JOSCR.CV](#) on exception entry.
- 0b0010 Jazelle extension implemented, with clearing of [JOSCR.CV](#) on exception entry.

A trivial implementation of the Jazelle extension is indicated by the value 0b0001.

### State1, bits[7:4]

Thumb instruction set support. Permitted values are:

- 0b0000 Thumb instruction set not implemented.
- 0b0001 Thumb encodings before the introduction of Thumb-2 technology implemented:
  - all instructions are 16-bit
  - a BL or BLX is a pair of 16-bit instructions
  - 32-bit instructions other than BL and BLX cannot be encoded.
- 0b0010 Reserved.
- 0b0011 Thumb encodings after the introduction of Thumb-2 technology implemented, for all 16-bit and 32-bit Thumb basic instructions.

### State0, bits[3:0]

ARM instruction set support. Permitted values are:

- 0b0000 ARM instruction set not implemented.
- 0b0001 ARM instruction set implemented.

### Accessing ID\_PFR0

To access ID\_PFR0, software reads the CP15 registers with <opc1> set to 0, <CRn> set to c0, <CRm> set to c1, and <opc2> set to 0. For example:

```
MRC p15, 0, <Rt>, c0, c1, 0 ; Read ID_PFR0 into Rt
```

## B6.1.57 ID\_PFR1, Processor Feature Register 1, PMSA

The ID\_PFR1 characteristics are:

- Purpose** ID\_PFR1 gives information about the programmers' model and Security Extensions support.  
 This register is a CPUID register, and is part of the Identification registers functional group.
- Usage constraints** Only accessible from PL1.  
 Must be interpreted with ID\_PFR0.
- Configurations** The VMSA and PMSA definitions of the register fields are identical.
- Attributes** A 32-bit RO register with an IMPLEMENTATION DEFINED value:
- [Table B7-1 on page B7-1950](#) shows the encodings of all of the CPUID registers
  - [Table B5-13 on page B5-1798](#) shows the encodings of all of the registers in the Identification registers functional group.
- All field values not shown in the field descriptions are reserved.

The ID\_PFR1 bit assignments are:

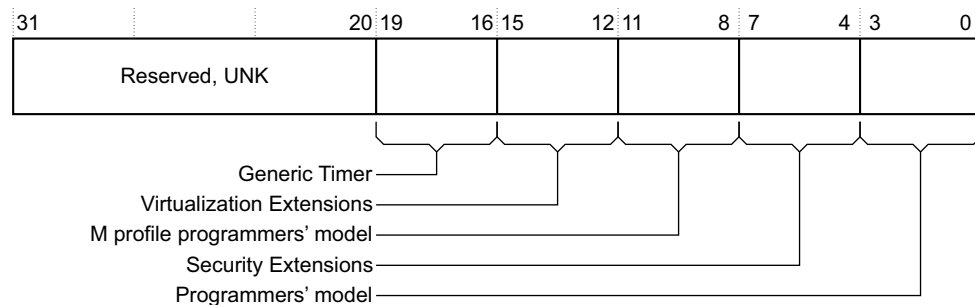

**Bits[31:20]** Reserved, UNK.

### Generic Timer Extension, bits[19:16]

Permitted values are:

- 0b0000 Not implemented.
- 0b0001 Generic Timer Extension implemented.

### Virtualization Extensions, bits[15:12]

Permitted values are:

- 0b0000 Not implemented.
- 0b0001 Virtualization Extensions implemented.

### Note

- A value of 0b0001 implies the implementation of the HVC, ERET, MRS (Banked register), and MSR (Banked register) instructions. The ID\_ISARs do not identify whether these instructions are implemented.
- This field must have the value 0b0000 in a PMSA implementation.

### M profile programmers' model, bits[11:8]

Permitted values are:

0b0000 Not supported.

0b0010 Support for two-stack programmers' model.

———— **Note** —————

In this field, the permitted values are not continuous, and the value of 0b0001 is reserved.

—————

### Security Extensions, bits[7:4]

Permitted values are:

0b0000 Not implemented.

0b0001 Security Extensions implemented.

This includes support for Monitor mode and the SMC instruction.

0b0010 As for 0b0001, and adds the ability to set the NSACR.RFR bit.

———— **Note** —————

This field must have the value 0b0000 in a PMSA implementation.

—————

### Programmers' model, bits[3:0]

Support for the standard programmers' model for ARMv4 and later. Model must support User, FIQ, IRQ, Supervisor, Abort, Undefined and System modes. Permitted values are:

0b0000 Not supported.

0b0001 Supported.

### Accessing ID\_PFR1

To access ID\_PFR1, software reads the CP15 registers with <opc1> set to 0, <CRn> set to c0, <CRm> set to c1, and <opc2> set to 1. For example:

MRC p15, 0, <Rt>, c0, c1, 1 ; Read ID\_PFR1 into Rt

## B6.1.58 IFAR, Instruction Fault Address Register, PMSA

The IFAR characteristics are:

<b>Purpose</b>	The IFAR holds the address of the access that caused a synchronous Prefetch Abort exception. This register is part of the PL1 Fault handling registers functional group.
<b>Usage constraints</b>	Only accessible from PL1.
<b>Configurations</b>	Always implemented.
<b>Attributes</b>	A 32-bit RW register with an UNKNOWN reset value. See also <a href="#">Reset behavior of CP14 and CP15 registers on page B5-1776</a> . <a href="#">Table B5-15 on page B5-1799</a> shows the encodings of all of the registers in the PL1 Fault handling registers functional group.

The IFAR bit assignments are:

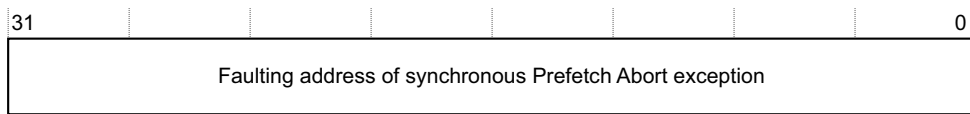

For information about using the IFAR, including when the value in the IFAR is valid, see [Exception reporting in a PMSA implementation on page B5-1767](#).

A debugger can write to the IFAR to restore its value.

### Accessing the IFAR

To access the IFAR, software reads or writes the CP15 registers with <opc1> set to 0, <CRn> set to c6, <CRm> set to c0, and <opc2> set to 2. For example:

```
MRC p15, 0, <Rt>, c6, c0, 2 ; Read IFAR into Rt  
MCR p15, 0, <Rt>, c6, c0, 2 ; Write Rt to IFAR
```





## B6.1.60 IRACR, Instruction Region Access Control Register, PMSA

The IRACR characteristics are:

<b>Purpose</b>	The IRACR defines the memory attributes for the current memory region in the instruction address map. This register is part of the MMU control registers functional group.
<b>Usage constraints</b>	Only accessible from PL1. Used in conjunction with the other MPU Memory region programming registers, see <a href="#">Programming the MPU region attributes on page B5-1761</a> .
<b>Configurations</b>	Only implemented when the PMSA implements separate instruction and data memory maps.
<b>Attributes</b>	A 32-bit RW register with an UNKNOWN reset value. See also <a href="#">Reset behavior of CP14 and CP15 registers on page B5-1776</a> . <a href="#">Table B5-14 on page B5-1799</a> shows the encodings of all of the registers in the MMU control registers functional group.

The IRACR bit assignments are identical to the [DRACR](#) assignments.

### ———— **Note** —————

The XN bit, bit[12], is always valid in the IRACR.

The current memory region is selected by the value held in the [RGNR](#).

If software accesses this register when the [RGNR](#) does not point to a valid region in the MPU instruction address map, the result is UNPREDICTABLE.

### Accessing the IRACR

To access the IRACR, software reads or writes the CP15 registers with <opc1> set to 0, <CRn> set to c6, <CRm> set to c1, and <opc2> set to 5. For example:

```
MRC p15, 0, <Rt>, c6, c1, 5 ; Read IRACR into Rt  
MCR p15, 0, <Rt>, c6, c1, 5 ; Write Rt to IRACR
```

## B6.1.61 IRBAR, Instruction Region Base Address Register, PMSA

The IRBAR characteristics are:

<b>Purpose</b>	The IRBAR indicates the base address of the current memory region in the Instruction address map. This register is part of the MMU control registers functional group.
<b>Usage constraints</b>	Only accessible from PL1. Used in conjunction with the other MPU Memory region programming registers, see <a href="#">Programming the MPU region attributes on page B5-1761</a> .
<b>Configurations</b>	Only implemented when the PMSA implements separate instruction and data memory maps.
<b>Attributes</b>	A 32-bit RW register with an UNKNOWN reset value. See also <a href="#">Reset behavior of CP14 and CP15 registers on page B5-1776</a> . <a href="#">Table B5-14 on page B5-1799</a> shows the encodings of all of the registers in the MMU control registers functional group.

The IRBAR bit assignments are identical to the [DRBAR](#) assignments.

The base address must be aligned to the region size, otherwise behavior is UNPREDICTABLE. The current memory region is selected by the value held in the [RGNR](#).

Software can use the IRBAR to find the minimum region size supported by the implementation, see [Finding the minimum supported region size on page B5-1758](#).

### Accessing the IRBAR

To access the IRBAR, software reads or writes the CP15 registers with <opc1> set to 0, <CRn> set to c6, <CRm> set to c1, and <opc2> set to 1. For example:

```
MRC p15, 0, <Rt>, c6, c1, 1 ; Read IRBAR into Rt  
MCR p15, 0, <Rt>, c6, c1, 1 ; Write Rt to IRBAR
```

## B6.1.62 IRSR, Instruction Region Size and Enable Register, PMSA

The IRSR characteristics are:

<b>Purpose</b>	The IRSR indicates the size of the current memory region in the instruction address map, and software can use it to enable or disable: <ul style="list-style-type: none"><li>• the entire region</li><li>• each of the eight subregions, if the region is enabled.</li></ul> This register is part of the MMU control registers functional group.
<b>Usage constraints</b>	Only accessible from PL1. Used in conjunction with the other MPU Memory region programming registers, see <a href="#">Programming the MPU region attributes on page B5-1761</a> .
<b>Configurations</b>	Only implemented when the PMSA implements separate instruction and data memory maps.
<b>Attributes</b>	A 32-bit RW register that resets to zero. See also <a href="#">Reset behavior of CP14 and CP15 registers on page B5-1776</a> . <a href="#">Table B5-14 on page B5-1799</a> shows the encodings of all of the registers in the MMU control registers functional group.

The IRSR bit assignments are identical to the [DRSR](#) assignments.

All memory regions must be enabled before they are used.

The current memory region is selected by the value held in the [RGNR](#).

The minimum region size supported is IMPLEMENTATION DEFINED, but if the memory system implementation includes an instruction cache, ARM strongly recommends that the minimum region size is a multiple of the instruction cache line length. This prevents cache attributes changing mid-way through a cache line.

Behavior is UNPREDICTABLE if software:

- writes a region size that is outside the range supported by the implementation
- accesses this register when the [RGNR](#) does not point to a valid region in the MPU instruction address map.

### Accessing the IRSR

To access the IRSR, software reads or writes the CP15 registers with <opc1> set to 0, <CRn> set to c6, <CRm> set to c1, and <opc2> set to 3. For example:

```
MRC p15, 0, <Rt>, c6, c1, 3 ; Read IRSR into Rt
MCR p15, 0, <Rt>, c6, c1, 3 ; Write Rt to IRSR
```

### B6.1.63 JIDR, Jazelle ID Register, PMSA

The JIDR characteristics are:

- Purpose** Identifies the Jazelle architecture and subarchitecture versions.  
This register is a Jazelle register.
- Usage constraints** Read access rights depend on the execution privilege and the value of the [JOSCR.CD](#) bit. Write accesses are UNPREDICTABLE at PL1 or higher, and UNDEFINED at PL0. See [Access to Jazelle registers on page A2-100](#).
- Configurations** The VMSA and PMSA definitions of the register fields are identical.  
Always implemented, but can be implemented as RAZ on a processor with a trivial implementation of the Jazelle extension.
- Attributes** A 32-bit RO register.  
[Table A2-16 on page A2-99](#) shows the encodings of all the Jazelle registers.

The JIDR bit assignments are:

31	28	27	20	19	12	11	0
Architecture		Implementer		Subarchitecture		SUBARCHITECTURE DEFINED	

#### Architecture, bits[31:28]

Architecture code. This uses the same Architecture code that appears in the [MIDR](#).  
 On a trivial implementation of the Jazelle extension this field must be RAZ.

#### Implementer, bits[27:20]

Implementer code of the designer of the subarchitecture. This uses the same Implementer code that appears in the [MIDR](#).  
 On a trivial implementation of the Jazelle extension this field must be RAZ.

#### Subarchitecture, bits[19:12]

Contain the subarchitecture code. The following subarchitecture code is defined:  
 0x00 Jazelle v1 subarchitecture, or trivial implementation of the Jazelle extension if the Implementer field is RAZ.  
 On a trivial implementation of the Jazelle extension this field must be RAZ.

**Bits[11:0]** Can contain additional SUBARCHITECTURE DEFINED information.

### Accessing the JIDR

To access the JIDR, software reads the CP14 registers with <opc1> set to 7, <CRn> set to c0, <CRm> set to c0, and <opc2> set to 0. For example:

```
MRC p14, 7, <Rt>, c0, c0, 0 ; Read JIDR into Rt
```

## B6.1.64 JMCR, Jazelle Main Configuration Register, PMSA

The JMCR characteristics are:

<b>Purpose</b>	Provides control of the Jazelle extension. This register is a Jazelle register.
<b>Usage constraints</b>	Access rights depend on the execution privilege and the value of the <code>JOSCR.CD</code> bit, see <a href="#">Access to Jazelle registers in a non-trivial Jazelle implementation on page A2-100</a> .
<b>Configurations</b>	The VMSA and PMSA definitions of the register fields are identical. Always implemented. A processor with a trivial implementation of the Jazelle extension must implement JMCR as RAZ/WI.
<b>Attributes</b>	A 32-bit RW register. See the field descriptions for details about the reset value. <a href="#">Table A2-16 on page A2-99</a> shows the encodings of all the Jazelle registers.

The JMCR bit assignments are:

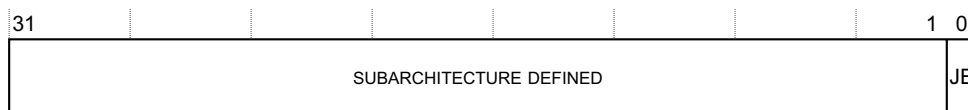

**Bits[31:1]** SUBARCHITECTURE DEFINED information. This means the reset value of this field is also SUBARCHITECTURE DEFINED.

**JE, bit[0]** Jazelle Enable bit:

- 0** Jazelle extension disabled. The `BXJ` instruction does not cause Jazelle state execution. `BXJ` behaves exactly as a `BX` instruction, see [Jazelle state entry instruction, `BXJ` on page A2-98](#).
- 1** Jazelle extension enabled.

The reset value of this bit is 0.

### Accessing the JMCR

To access the JMCR, software reads or writes the CP14 registers with `<opc1>` set to 7, `<CRn>` set to c2, `<CRm>` set to c0, and `<opc2>` set to 0. For example:

```
MRC p14, 7, <Rt>, c2, c0, 0 ; Read JMCR into Rt
MCR p14, 7, <Rt>, c2, c0, 0 ; Write Rt to JMCR
```

## B6.1.65 JOSCR, Jazelle OS Control Register, PMSA

The JOSCR characteristics are:

<b>Purpose</b>	Provides operating system control of the use of the Jazelle extension by processes and threads. This register is a Jazelle register
<b>Usage constraints</b>	Accessible only from PL1 or higher. Normally used in conjunction with the <a href="#">JMCR.JE</a> bit.
<b>Configurations</b>	The VMSA and PMSA definitions of the register fields are identical. Always implemented. A processor with a trivial implementation of the Jazelle extension must implement JOSCR either: <ul style="list-style-type: none"> <li>• as RAZ/WI</li> <li>• so that it can be read or written, but the processor ignores the effect of any read or write.</li> </ul>
<b>Attributes</b>	A 32-bit RW register that resets to zero. <a href="#">Table A2-16 on page A2-99</a> shows the encodings of all the Jazelle registers.

The JOSCR bit assignments are:

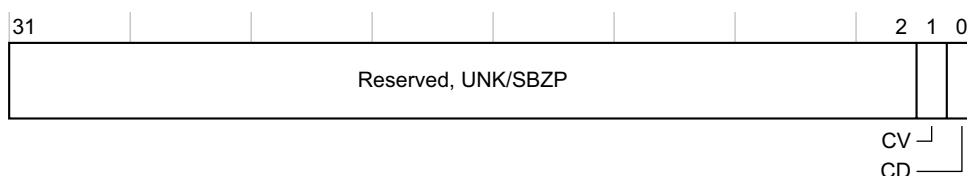

<b>Bits[31:2]</b>	Reserved, UNK/SBZP.
<b>CV, bit[1]</b>	Configuration Valid bit. This bit is used by an operating system to signal to the EJVM that it must rewrite its configuration to the configuration registers. The possible values are: <ul style="list-style-type: none"> <li><b>0</b> Configuration not valid. The EJVM must rewrite its configuration to the configuration registers before it executes another bytecode instruction.</li> <li><b>1</b> Configuration valid. The EJVM does not need to update the configuration registers.</li> </ul> When <a href="#">JMCR.JE</a> is set to 1, the CV bit also controls entry to Jazelle state, see <a href="#">Controlling entry to Jazelle state on page B1-1242</a> .
<b>CD, bit[0]</b>	Configuration Disabled bit. This bit is used by an operating system to disable User mode access to the <a href="#">JIDR</a> and configuration registers: <ul style="list-style-type: none"> <li><b>0</b> Configuration enabled. Access to the Jazelle registers, including User mode accesses, operate normally. For more information, see the register descriptions in <a href="#">Application level configuration and control of the Jazelle extension on page A2-99</a>.</li> <li><b>1</b> Configuration disabled in User mode. User mode access to the Jazelle registers are UNDEFINED, and all User mode accesses to the Jazelle registers cause an Undefined Instruction exception.</li> </ul> For more information about the use of this bit see <a href="#">Monitoring and controlling User mode access to the Jazelle extension on page B1-1243</a> .

The JOSCR provides a control mechanism that is independent of the subarchitecture of the Jazelle extension. An operating system can use this mechanism to control access to the Jazelle extension, see [Jazelle state configuration and control on page B1-1242](#).

## **Accessing the JOSCR**

To access the JOSCR, software reads or writes the CP14 registers with <opc1> set to 7, <CRn> set to c1, <CRm> set to c0, and <opc2> set to 0. For example:

```
MRC p14, 7, <Rt>, c1, c0, 0 ; Read JOSCR into Rt  
MCR p14, 7, <Rt>, c1, c0, 0 ; Write Rt to JOSCR
```

## B6.1.66 MIDR, Main ID Register, PMSA

The MIDR characteristics are:

- Purpose** The MIDR provides identification information for the processor, including an implementer code for the device and a device ID number.  
 This register is part of the Identification registers functional group.
- Usage constraints** Only accessible from PL1.
- Configurations** Some fields of the MIDR are IMPLEMENTATION DEFINED. For details of the values of these fields for a particular ARMv7 implementation, and any implementation-specific significance of these values, see the product documentation.
- Attributes** A 32-bit RO register with an IMPLEMENTATION DEFINED value. See also [Reset behavior of CP14 and CP15 registers on page B5-1776](#).  
[Table B5-13 on page B5-1798](#) shows the encodings of all of the registers in the Identification registers functional group.

The MIDR bit assignments are:

31	24	23	20	19	16	15	4	3	0
Implementer			Variant		Architecture		Primary part number		Revision

### Implementer, bits[31:24]

The Implementer code. [Table B6-4](#) shows the permitted values for this field.

**Table B6-4 Implementer codes**

Bits[31:24]	ASCII character	Implementer
0x41	A	ARM Limited
0x44	D	Digital Equipment Corporation
0x4D	M	Motorola, Freescale Semiconductor Inc.
0x51	Q	Qualcomm Inc.
0x56	V	Marvell Semiconductor Inc.
0x69	i	Intel Corporation

All other values are reserved by ARM and must not be used.

### Variant, bits[23:20]

An IMPLEMENTATION DEFINED variant number. Typically, this field distinguishes between different product variants, for example implementations of the same product with different cache sizes.



### Architecture, bits[19:16]

Table B6-5 shows the permitted values for this field.

**Table B6-5 Architecture codes**

Bits[19:16]	Architecture
0x1	ARMv4
0x2	ARMv4T
0x3	ARMv5 (obsolete)
0x4	ARMv5T
0x5	ARMv5TE
0x6	ARMv5TEJ
0x7	ARMv6
0xF	Defined by CPUID scheme

All other values are reserved by ARM and must not be used.

### Primary part number, bits[15:4]

An IMPLEMENTATION DEFINED primary part number for the device.

#### ———— Note —————

- On processors implemented by ARM, if the top four bits of the primary part number are 0x0 or 0x7, the variant and architecture are encoded differently, see the description of the MIDR in [Appendix O ARMv4 and ARMv5 Differences](#).
- Processors implemented by ARM have an Implementer code of 0x41.

### Revision, bits[3:0]

An IMPLEMENTATION DEFINED revision number for the device.

ARMv7 requires all implementations to use the CPUID scheme, described in [Chapter B7 The CPUID Identification Scheme](#), and an implementation is described by the MIDR and the CPUID registers.

#### ———— Note —————

For an ARMv7 implementation by ARM, the MIDR is interpreted as:

- Bits[31:24]** Implementer code, must be 0x41.
- Bits[23:20]** Major revision number, rX.
- Bits[19:16]** Architecture code, must be 0xF.
- Bits[15:4]** ARM part number.
- Bits[3:0]** Minor revision number, pY.

### Accessing the MIDR

To access the MIDR, software reads the CP15 registers with <opc1> set to 0, <CRn> set to c0, <CRm> set to c0, and <opc2> set to 0. For example:

```
MRC p15, 0, <Rt>, c0, c0, 0 ; Read MIDR into Rt
```

## B6.1.67 MPIDR, Multiprocessor Affinity Register, PMSA

The MPIDR characteristics are:

- Purpose** In a multiprocessor system, the MPIDR provides an additional processor identification mechanism for scheduling purposes, and indicates whether the implementation includes the Multiprocessing Extensions.  
 This register is part of the Identification registers functional group.
- Usage constraints** Only accessible from PL1.
- Configurations** This register is not implemented in architecture versions before ARMv7.  
 In a uniprocessor system ARM recommends that this register returns a value of 0.
- Attributes** A 32-bit RO register with an IMPLEMENTATION DEFINED value. See also [Reset behavior of CP14 and CP15 registers on page B5-1776](#).  
[Table B5-13 on page B5-1798](#) shows the encodings of all of the registers in the Identification registers functional group.

In an ARMv7 implementation that does not include the Multiprocessing Extensions, the MPIDR bit assignments are:

31	24	23	16	15	8	7	0
Reserved, RAZ			Aff2		Aff1		Aff0

In an implementation that includes the Multiprocessing Extensions, the MPIDR bit assignments are:

31	30	29	25	24	23	16	15	8	7	0
1	U	Reserved, UNK			Aff2		Aff1		Aff0	
		MT								

**Note**

In the MPIDR bit definitions, a *processor in the system* can be a physical processor or a virtual machine.

**Bits[31:24], ARMv7 without the Multiprocessing Extensions**

Reserved, RAZ.

**Bits[31], in an implementation that includes the Multiprocessing Extensions**

RAO. Indicates that the implementation uses the Multiprocessing Extensions register format.

**U, bit[30], in an implementation that includes the Multiprocessing Extensions**

Indicates a Uniprocessor system, as distinct from processor 0 in a multiprocessor system. The possible values of this bit are:

**0** Processor is part of a multiprocessor system.

**1** Processor is part of a uniprocessor system.

**Bits[29:25], in an implementation that includes the Multiprocessing Extensions**

Reserved, UNK.

### MT, bit[24], in an implementation that includes the Multiprocessing Extensions

Indicates whether the lowest level of affinity consists of logical processors that are implemented using a multi-threading type approach. The possible values of this bit are:

- 0 Performance of processors at the lowest affinity level is largely independent.
- 1 Performance of processors at the lowest affinity level is very interdependent.

For more information about the meaning of this bit see [Multi-threading approach to lowest affinity levels, Multiprocessing Extensions](#).

### Aff2, bits[23:16]

Affinity level 2. The least significant affinity level field, for this processor in the system.

### Aff1, bits[15:8]

Affinity level 1. The intermediate affinity level field, for this processor in the system.

### Aff0, bits[7:0]

Affinity level 0. The most significant affinity level field, for this processor in the system.

See [Recommended use of the MPIDR](#) for clarification of the meaning of *most significant* and *least significant* affinity levels.

In the system as a whole, for each of the affinity level fields, the assigned values must start at 0 and increase monotonically.

When matching against an affinity level field, scheduler software checks for a value equal to or greater than a required value.

[Recommended use of the MPIDR](#) includes a description of an example multiprocessor system and the affinity level field values it might use.

The interpretation of these fields is IMPLEMENTATION DEFINED, and must be documented as part of the documentation of the multiprocessor system. ARM recommends that this register might be used as described in [Recommended use of the MPIDR](#).

The software mechanism to discover the total number of affinity numbers used at each level is IMPLEMENTATION DEFINED, and is part of the general system identification task.

## Multi-threading approach to lowest affinity levels, Multiprocessing Extensions

In an implementation that includes the Multiprocessing Extensions, if the MPIDR.MT bit is set to 1, this indicates that the processors at affinity level 0 are logical processors, implemented using a multi-threading type approach. In such an approach, there can be a significant performance impact if a new thread is assigned the processor with:

- a different affinity level 0 value to some other thread, referred to as the original thread
- a pair of values for affinity levels 1 and 2 that are the same as the pair of values of the original thread.

In this situation, the performance of the original thread might be significantly reduced.

### ———— Note —————

In this description, thread always refers to a thread or a process.

## Recommended use of the MPIDR

In a multiprocessor system the register might provide two important functions:

- Identifying special functionality of a particular processor in the system. In general, the actual meaning of the affinity level fields is not important. In a small number of situations, an affinity level field value might have a special IMPLEMENTATION DEFINED significance. Possible examples include booting from reset and powerdown events.

- Providing affinity information for the scheduling software, to help the scheduler run an individual thread or process on either:
  - the same processor, or as similar a processor as possible, as the processor it was running on previously
  - a processor on which a related thread or process was run.

The MPIDR provides a mechanism with up to three levels of affinity information, but the meaning of those levels of affinity is entirely IMPLEMENTATION DEFINED. The levels of affinity provided can have different meanings.

Table B6-6 shows two possible implementations.

**Table B6-6 Possible implementations of the affinity levels**

Affinity level	Example system 1	Example system 2
0	Virtual CPUs in a in a multi-threaded processor	Processors in an SMP cluster
1	Processors in an <i>Symmetric Multi Processor</i> (SMP) cluster	Clusters with a system
2	Clusters in a system	No meaning, fixed as 0

The scheduler maintains affinity level information for all threads and processes. When it has to reschedule a thread or process, the scheduler:

1. Looks for an available processor that matches at all three affinity levels.
2. If step 1 fails, the scheduler might look for a processor that matches at levels 2 and 3 only.
3. If the scheduler still cannot find an available processor it might look for a match at level 3 only.

A multiprocessor system corresponding to Example system 1 in Table B6-6 might implement affinity values as shown in Table B6-7.

**Table B6-7 Example of possible affinity values at different affinity levels**

A2, Cluster level, values	Aff1, Processor level, values	Aff0, Virtual CPU level, values
0	0	0, 1
0	1	0, 1
0	2	0, 1
0	3	0, 1
1	0	0, 1
1	1	0, 1
1	2	0, 1
1	3	0, 1

### Accessing the MPIDR

To access the MPIDR, software reads the CP15 registers with <opc1> set to 0, <CRn> set to c0, <CRm> set to c0, and <opc2> set to 5. For example:

MRC p15, 0, <Rt>, c0, c0, 5 ; Read MPIDR into Rt

## B6.1.68 MPUIR, MPU Type Register, PMSA

The MPUIR characteristics are:

- Purpose** The MPUIR identifies the following features of the MPU implementation:
- whether the MPU implements:
    - a Unified address map, also referred to as a von Neumann architecture
    - separate Instruction and Data address maps, also referred to as a Harvard architecture.
  - the number of memory regions implemented by the MPU.

This register is part of the Identification registers functional group.

**Usage constraints** Only accessible from PL1.

**Configurations** Implemented only when the PMSA is implemented.

**Attributes** A 32-bit RO register with an IMPLEMENTATION DEFINED value. See also [Reset behavior of CP14 and CP15 registers on page B5-1776](#).

[Table B5-13 on page B5-1798](#) shows the encodings of all of the registers in the Identification registers functional group.

The MPUIR bit assignments are:

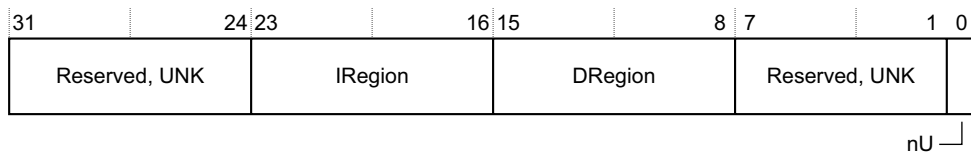

**Bits[31:24]** Reserved, UNK.

**IRegion, bits[23:16]** Specifies the number of Instruction regions implemented by the MPU.  
 If the MPU implements a Unified memory map this field is UNK.

**DRegion, bits[15:8]** Specifies the number of Data or Unified regions implemented by the MPU.  
 If this field is zero, no MPU is implemented, and the default memory map is in use.

**Bits[7:1]** Reserved, UNK.

**nU, bit[0]** Not Unified MPU. Indicates whether the MPU implements a unified memory map:  
**0** Unified memory map. Bits[23:16] of the register are zero.  
**1** Separate Instruction and Data memory maps.

### Accessing the MPUIR

To access the MPUIR, software reads the CP15 registers with <opc1> set to 0, <CRn> set to c0, <CRm> set to c0, and <opc2> set to 4. For example:

MRC p15, 0, <Rt>, c0, c0, 4 ; Read MPUIR into Rt

## B6.1.69 MVFR0, Media and VFP Feature Register 0, PMSA

The MVFR0 characteristics are:

<b>Purpose</b>	The MVFR0 describes the features provided by the Advanced SIMD and Floating-point Extensions. This register is an Advanced SIMD and Floating-point Extension system register.
<b>Usage constraints</b>	Only accessible from PL1 or higher. See <a href="#">Accessing the Advanced SIMD and Floating-point Extension system registers on page B1-1236</a> for more information. Must be interpreted with <a href="#">MVFR1</a> . This register complements the information provided by the CPUID scheme described in <a href="#">Chapter B7 The CPUID Identification Scheme</a> .
<b>Configurations</b>	Implemented only if the implementation includes one or both of: <ul style="list-style-type: none"> <li>• the Floating-point Extension</li> <li>• the Advanced SIMD Extension.</li> </ul> The VMSA and PMSA definitions of the register fields are identical.
<b>Attributes</b>	A 32-bit RO register. <a href="#">Table B1-24 on page B1-1235</a> shows the encodings of all of the Advanced SIMD and Floating-point Extension system registers

The MVFR0 bit assignments are:

31	28	27	24	23	20	19	16	15	12	11	8	7	4	3	0	
VFP rounding modes				Short vectors		Square root		Divide		VFP exception trapping		Double-precision		Single-precision		A_SIMD registers

### VFP rounding modes, bits[31:28]

Indicates the rounding modes supported by the Floating-point Extension hardware. Permitted values are:

- 0b0000 Only Round to Nearest mode supported, except that Round towards Zero mode is supported for VCVT instructions that always use that rounding mode regardless of the [FPSCR](#) setting.
- 0b0001 All rounding modes supported.

### Short vectors, bits[27:24]

Indicates the hardware support for VFP short vectors. Permitted values are:

- 0b0000 Not supported.
- 0b0001 Short vector operation supported.

### Square root, bits[23:20]

Indicates the hardware support for the Floating-point Extension square root operations. Permitted values are:

- 0b0000 Not supported in hardware.
- 0b0001 Supported.

#### ————— **Note** —————

- the VSQRT.F32 instruction also requires the single-precision floating-point attribute, bits[7:4]
- the VSQRT.F64 instruction also requires the double-precision floating-point attribute, bits[11:8].

### Divide, bits[19:16]

Indicates the hardware support for Floating-point Extension divide operations. Permitted values are:

0b0000 Not supported in hardware.  
0b0001 Supported.

---

**Note**

- the VDIV.F32 instruction also requires the single-precision floating-point attribute, bits[7:4]
  - the VDIV.F64 instruction also requires the double-precision floating-point attribute, bits[11:8].
- 

### VFP exception trapping, bits[15:12]

Indicates whether the Floating-point Extension hardware implementation supports exception trapping. Permitted values are:

0b0000 Not supported. This is the value for VFPv3 and VFPv4.  
0b0001 Supported by the hardware. This is the value for VFPv2, and for VFPv3U and VFPv4U.  
When exception trapping is supported, support code is required to handle the trapped exceptions.

---

**Note**

This value does not indicate that trapped exception handling is available. Because trapped exception handling requires support code, only the support code can provide this information.

---

### Double-precision, bits[11:8]

Indicates the hardware support for Floating-point Extension double-precision operations. Permitted values are:

0b0000 Not supported in hardware.  
0b0001 Supported, VFPv2.  
0b0010 Supported, VFPv3 or VFPv4.

VFPv3 adds an instruction to load a double-precision floating-point constant, and conversions between double-precision and fixed-point values.

A value of 0b0001 or 0b0010 indicates support for all Floating-point Extension double-precision instructions in the supported version of the extension, except that, in addition to this field being nonzero:

- VSQRT.F64 is only available if the Square root field is 0b0001
- VDIV.F64 is only available if the Divide field is 0b0001
- conversion between double-precision and single-precision is only available if the single-precision field is nonzero.

### Single-precision, bits[7:4]

Indicates the hardware support for Floating-point Extension single-precision operations. Permitted values are:

0b0000 Not supported in hardware.

0b0001 Supported, VFPv2.

0b0010 Supported, VFPv3 or VFPv4.

VFPv3 adds an instruction to load a single-precision floating-point constant, and conversions between single-precision and fixed-point values.

A value of 0b0001 or 0b0010 indicates support for all Floating-point Extension single-precision instructions in the supported version of the extension, except that, in addition to this field being nonzero:

- VSQRT.F32 is only available if the Square root field is 0b0001
- VDIV.F32 is only available if the Divide field is 0b0001
- conversion between double-precision and single-precision is only available if the double-precision field is nonzero.

### A\_SIMD registers, bits[3:0]

Indicates support for the Advanced SIMD register bank. Permitted values are:

0b0000 Not supported.

0b0001 Supported, 16 × 64-bit registers.

0b0010 Supported, 32 × 64-bit registers.

If this field is nonzero:

- all Floating-point Extension LDC, STC, MCR, and MRC instructions are supported
- if the CPUID register shows that the MCRR and MRRC instructions are supported then the corresponding Floating-point Extension instructions are supported.

### Accessing MVFR0

Software accesses MVFR0 using the VMRS instruction, see [VMRS on page B9-2012](#). For example:

```
VMRS <Rt>, MVFR0 ; Read MVFR0 into Rt
```



## B6.1.70 MVFR1, Media and VFP Feature Register 1, PMSA

The MVFR1 characteristics are:

<b>Purpose</b>	The MVFR1 describes the features provided by the Advanced SIMD and Floating-point Extensions. This register is an Advanced SIMD and Floating-point Extension system register.
<b>Usage constraints</b>	Only accessible from PL1 or higher. See <a href="#">Accessing the Advanced SIMD and Floating-point Extension system registers on page B1-1236</a> for more information. Must be interpreted with MVFR0. These registers complement the information provided by the CPUID scheme described in <a href="#">Chapter B7 The CPUID Identification Scheme</a> .
<b>Configurations</b>	Implemented only if the implementation includes one or both of: <ul style="list-style-type: none"> <li>• the Floating-point Extension</li> <li>• the Advanced SIMD Extension.</li> </ul> The VMSA and PMSA definitions of the register fields are identical.
<b>Attributes</b>	A 32-bit RO register. <a href="#">Table B1-24 on page B1-1235</a> shows the encodings of all of the Advanced SIMD and Floating-point Extension system registers

The MVFR1 bit assignments are:

31	28	27	24	23	20	19	16	15	12	11	8	7	4	3	0
A_SIMD FMAC	VFP HPFP		A_SIMD HPFP	A_SIMD SPFP	A_SIMD integer	A_SIMD load/store	D_NaN mode		FtZ mode						

### A\_SIMD FMAC, bits[31:28]

Indicates whether any implemented Floating-point or Advanced SIMD Extension implements the fused multiply accumulate instructions. Permitted values are:

0b0000	Not implemented.
0b0001	Implemented.

If an implementation includes both the Floating-point Extension and the Advanced SIMD Extension, both extensions must provide the same level of support for these instructions.

### VFP HPFP, bits[27:24]

Indicates whether the Floating-point Extension supports half-precision floating-point conversion instructions. Permitted values are:

0b0000	Not supported.
0b0001	Supported.

### A\_SIMD HPFP, bits[23:20]

Indicates whether the Advanced SIMD Extension implements half-precision floating-point conversion instructions. Permitted values are:

0b0000	Not implemented.
0b0001	Implemented. This value is permitted only if the A_SIMD SPFP field is 0b0001.

### A\_SIMD SPFP, bits[19:16]

Indicates whether the Advanced SIMD Extension implements single-precision floating-point instructions. Permitted values are:

0b0000	Not implemented.
0b0001	Implemented. This value is permitted only if the A_SIMD integer field is 0b0001.

#### A\_SIMD integer, bits[15:12]

Indicates whether the Advanced SIMD Extension implements integer instructions. Permitted values are:

- 0b0000 Not implemented.
- 0b0001 Implemented.

#### A\_SIMD load/store, bits[11:8]

Indicates whether the Advanced SIMD Extension implements load/store instructions. Permitted values are:

- 0b0000 Not implemented.
- 0b0001 Implemented.

#### D\_NaN mode, bits[7:4]

Indicates whether the Floating-point Extension hardware implementation supports only the Default NaN mode. Permitted values are:

- 0b0000 Hardware supports only the Default NaN mode. If a VFP subarchitecture is implemented its support code might include support for propagation of NaN values.
- 0b0001 Hardware supports propagation of NaN values.

#### FtZ mode, bits[3:0]

Indicates whether the Floating-point Extension hardware implementation supports only the Flush-to-Zero mode of operation. Permitted values are:

- 0b0000 Hardware supports only the Flush-to-Zero mode of operation. If a VFP subarchitecture is implemented its support code might include support for full denormalized number arithmetic.
- 0b0001 Hardware supports full denormalized number arithmetic.

### Accessing MVFR1

Software accesses MVFR1 using the VMRS instruction, see [VMRS on page B9-2012](#). For example:

```
VMRS <Rt>, MVFR1 ; Read MVFR1 into Rt
```

## B6.1.71 PMCCNTR, Performance Monitors Cycle Count Register, PMSA

When accessed through the CP15 interface, the PMCCNTR characteristics are:

<b>Purpose</b>	The PMCCNTR holds the value of the processor Cycle Counter, CCNT, that counts processor clock cycles. This register is a Performance Monitors register.
<b>Usage constraints</b>	The PMCCNTR is accessible in: <ul style="list-style-type: none"><li>• all PL1 modes</li><li>• User mode when <code>PMUSERENR.EN == 1</code>.</li></ul> See <a href="#">Access permissions on page C12-2328</a> for more information. The <code>PMCR.D</code> bit configures whether PMCCNTR increments once every clock cycle, or once every 64 clock cycles. In PMUv2, the <code>PMXEVTYP</code> accessed when <code>PMSELR.SEL</code> is set to <code>0b11111</code> determines the modes and states in which the PMCCNTR can increment.
<b>Configurations</b>	Implemented only as part of the Performance Monitors Extension. The VMSA and PMSA definitions of the register fields are identical.
<b>Attributes</b>	A 32-bit RW register with a reset value that is UNKNOWN on a non-debug logic reset. See also <a href="#">Power domains and Performance Monitors registers reset on page C12-2327</a> . <a href="#">Table C12-7 on page C12-2327</a> shows the CP15 encodings of all of the Performance Monitors registers.

### ———— Note ————

[Differences in the memory-mapped views of the Performance Monitors registers on page AppxB-2352](#) describes how the characteristics of the PMCCNTR differ when it is accessed through an external debug interface or a memory-mapped interface.

The PMCCNTR bit assignments are:

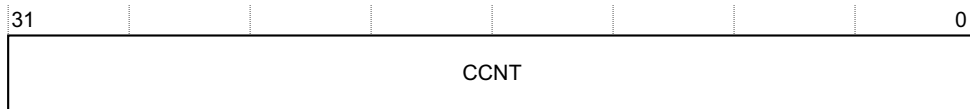

<b>CCNT, bits[31:0]</b>	Cycle count. Depending on the value of <code>PMCR.D</code> , this field increments either: <ul style="list-style-type: none"><li>• once every processor clock cycle</li><li>• once every 64 processor clock cycles.</li></ul>
-------------------------	---

The PMCCNTR.CCNT value can be reset to zero by writing a 1 to `PMCR.C`.

### Accessing the PMCCNTR

To access the PMCCNTR, read or write the CP15 registers with `<opc1>` set to 0, `<CRn>` set to c9, `<CRm>` set to c13, and `<opc2>` set to 0. For example:

```
MRC p15, 0, <Rt>, c9, c13, 0 : Read PMCCNTR into Rt
MCR p15, 0, <Rt>, c9, c13, 0 : Write Rt to PMCCNTR
```

## B6.1.72 PMCEID0 and PMCEID1, Performance Monitors Common Event ID registers, PMSA

When accessed through the CP15 interface, the PMCEID0 and PMCEID1 register characteristics are:

<b>Purpose</b>	The PMCEIDn registers define which common architectural and common microarchitectural feature events are implemented. These registers are Performance Monitors registers.
<b>Usage constraints</b>	The PMCEIDn registers are accessible in: <ul style="list-style-type: none"> <li>all PL1 modes</li> <li>User mode when <a href="#">PMUSERENR.EN</a> is set to 1.</li> </ul> See <a href="#">Access permissions on page C12-2328</a> for more information.
<b>Configurations</b>	Implemented only as part of the Performance Monitors Extension. The VMSA and PMSA definitions of the register fields are identical.
<b>Attributes</b>	A 32-bit RO register. <a href="#">Table C12-7 on page C12-2327</a> shows the CP15 encodings of all of the Performance Monitors registers.

———— **Note** —————

[Differences in the memory-mapped views of the Performance Monitors registers on page AppxB-2352](#) describes how the characteristics of the PMCEID0 and PMCEID1 registers differ when they are accessed through an external debug interface or a memory-mapped interface.

[Table B6-8](#) shows the PMCEID0 bit assignments with event implemented or not implemented when the associated bit is set to 1 or 0.

PMCEID1[31:0] is reserved and must be implemented as RAZ. Software must not rely on the bits reading as 0.

**Table B6-8 PMCEID0 bit assignments**

Bit	Event number	Event implemented if set to 1 or not implemented if set to 0
[31]	0x1F	Reserved, UNK.
[30]	0x1E	
[29]	0x1D	Bus cycle.
[28]	0x1C	Instruction architecturally executed, condition code check pass, write to TTBR.
[27]	0x1B	Instruction speculatively executed.
[26]	0x1A	Local memory error.
[25]	0x19	Bus access.
[24]	0x18	Level 2 data cache write-back.
[23]	0x17	Level 2 data cache refill.
[22]	0x16	Level 2 data cache access.
[21]	0x15	Level 1 data cache write-back.
[20]	0x14	Level 1 instruction cache access.
[19]	0x13	Data memory access.
[18]	0x12	Predictable branch speculatively executed. If the implementation includes program flow prediction, this bit is RAO.

**Table B6-8 PMCEID0 bit assignments (continued)**

Bit	Event number	Event implemented if set to 1 or not implemented if set to 0
[17]	0x11	Cycle, this bit is RAO.
[16]	0x10	Mispredicted or not predicted branch speculatively executed. If the implementation includes program flow prediction resources, this bit is RAO.
[15]	0x0F	Instruction architecturally executed, condition code check pass, unaligned load or store.
[14]	0x0E	Instruction architecturally executed, condition code check pass, procedure return.
[13]	0x0D	Instruction architecturally executed, immediate branch.
[12]	0x0C	Instruction architecturally executed, condition code check pass, software change of the PC.
[11]	0x0B	Instruction architecturally executed, condition code check pass, write to <a href="#">CONTEXTIDR</a> .
[10]	0x0A	Instruction architecturally executed, condition code check pass, exception return.
[9]	0x09	Exception taken.
[8]	0x08	Instruction architecturally executed.
[7]	0x07	Instruction architecturally executed, condition code check pass, store.
[6]	0x06	Instruction architecturally executed, condition code check pass, load.
[5]	0x05	Level 1 data TLB refill.
[4]	0x04	Level 1 data cache access. If the implementation includes a L1 data or unified cache, this bit is RAO.
[3]	0x03	Level 1 data cache refill. If the implementation includes a L1 data or unified cache, this bit is RAO.
[2]	0x02	Level 1 instruction TLB refill.
[1]	0x01	Level 1 instruction cache refill.
[0]	0x00	Instruction architecturally executed, condition code check pass, software increment. This bit is RAO.

### Accessing the PMCEID0 or PMCEID1 register

To access the PMCEID0 or PMCEID1 register, software reads the CP15 register with <opc1> set to 0, <CRn> set to c9, <CRm> set to c12, and:

- <opc2> set to 6 for the PMCEID0 register
- <opc2> set to 7 for the PMCEID1 register.

For example:

```
MRC p15, 0, <Rt>, c9, c12, 6 ; Read PMCEID0 into Rt
MRC p15, 0, <Rt>, c9, c12, 7 ; Read PMCEID1 into Rt
```

### B6.1.73 PMCNTENCLR, Performance Monitors Count Enable Clear register, PMSA

When accessed through the CP15 interface, the PMCNTENCLR register characteristics are:

- Purpose** The PMCNTENCLR register disables the Cycle Count Register, [PMCCNTR](#), and any implemented event counters, PMNx. Reading this register shows which counters are enabled.  
 This register is a Performance Monitors register.
- Usage constraints** PMCNTENCLR is accessible in:
- all PL1 modes
  - User mode when [PMUSERENR.EN](#) == 1.
- See [Access permissions on page C12-2328](#) for more information. See also [Counter enables on page C12-2311](#) and [Counter access on page C12-2312](#).  
 PMCNTENCLR is used in conjunction with the [PMCNTENSET](#) register.
- Configurations** Implemented only as part of the Performance Monitors Extension.  
 The VMSA and PMSA definitions of the register fields are identical.
- Attributes** A 32-bit RW register with a reset value that is UNKNOWN on a non-debug logic reset. See also [Power domains and Performance Monitors registers reset on page C12-2327](#).  
[Table C12-7 on page C12-2327](#) shows the CP15 encodings of all of the Performance Monitors registers.

———— **Note** —————

[Differences in the memory-mapped views of the Performance Monitors registers on page AppxB-2352](#) describes how the characteristics of the PMCNTENCLR register differ when it is accessed through an external debug interface or a memory-mapped interface.

The PMCNTENCLR register bit assignments are:

31	30	N	N-1	0
C	Reserved, RAZ/WI		Event counter disable bits, Px, for x = 0 to (N-1)	

———— **Note** —————

In the description of the PMCNTENCLR register, N and x have the meanings used in the description of the [PMCNTENSET](#) register.

**C, bit[31]** [PMCCNTR](#) disable bit. [Table B6-9](#) shows the behavior of this bit on reads and writes.

**Table B6-9 Read and write values for the PMCNTENCLR.C bit**

Value	Meaning on read	Action on write
0	Cycle counter disabled	No action, write is ignored
1	Cycle counter enabled	Disable the cycle counter

**Bits[30:N]** RAZ/WI.

**Px, bit[x], for x = 0 to (N-1)**

Event counter x, PMNx, disable bit.

Table B6-10 shows the behavior of this bit on reads and writes.

**Table B6-10 Read and write values for the PMCNTENCLR.Px bits**

Px value	Meaning on read	Action on write
0	PMNx event counter disabled	No action, write is ignored
1	PMNx event counter enabled	Disable the PMNx event counter

**Note**

PMCR.E can override the settings in this register and disable all counters including PMCCNTR. PMCNTENCLR retains its value when PMCR.E is 0, even though its settings are ignored.

**Accessing the PMCNTENCLR register**

To access the PMCNTENCLR register, read or write the CP15 registers with <opc1> set to 0, <CRn> set to c9, <CRm> set to c12, and <opc2> set to 2. For example:

MRC p15, 0, <Rt>, c9, c12, 2 : Read PMCNTENCLR into Rt  
MCR p15, 0, <Rt>, c9, c12, 2 : Write Rt to PMCNTENCLR

## B6.1.74 PMCNTENSET, Performance Monitors Count Enable Set register, PMSA

When accessed through the CP15 interface, the PMCNTENSET register characteristics are:

- Purpose** The PMCNTENSET register enables the Cycle Count Register, [PMCCNTR](#), and any implemented event counters, PMNx. Reading this register shows which counters are enabled.  
 This register is a Performance Monitors register.
- Usage constraints** PMCNTENSET is accessible in:
- all PL1 modes
  - User mode when [PMUSERENR.EN](#) is set to 1.
- See [Access permissions on page C12-2328](#) for more information. See also [Counter enables on page C12-2311](#) and [Counter access on page C12-2312](#).  
 PMCNTENSET is used in conjunction with [PMCNTENCLR](#).
- Configurations** Implemented only as part of the Performance Monitors Extension.  
 The VMSA and PMSA definitions of the register fields are identical.
- Attributes** A 32-bit RW register with a reset value that is UNKNOWN on a non-debug logic reset. See also [Power domains and Performance Monitors registers reset on page C12-2327](#).  
[Table C12-7 on page C12-2327](#) shows the CP15 encodings of all of the Performance Monitors registers.

———— **Note** —————

[Differences in the memory-mapped views of the Performance Monitors registers on page AppxB-2352](#) describes how the characteristics of the PMCNTENSET register differ when it is accessed through an external debug interface or a memory-mapped interface.

The PMCNTENSET register bit assignments are:

31	30	N	N-1	0
C	Reserved, RAZ/WI		Event counter enable bits, Px, for x = 0 to (N-1)	

———— **Note** —————

In the description of the PMCNTENSET register:

- N is the number of event counters implemented, as defined by the [PMCR.N](#) field.
- x refers to a single event counter, and takes values from 0 to (N-1).

**C, bit[31]** [PMCCNTR](#) enable bit.

[Table B6-11](#) shows the behavior of this bit on reads and writes.

**Table B6-11 Read and write bit values for the PMCNTENSET.C bit**

Value	Meaning on read	Action on write
0	Cycle counter disabled	No action, write is ignored
1	Cycle counter enabled	Enable the <a href="#">PMCCNTR</a> cycle counter

**Bits[30:N]** RAZ/WI.



**Px, bit[x], for x = 0 to (N-1)**

Event counter x, PMNx, enable bit.

Table B6-12 shows the behavior of this bit on reads and writes.

**Table B6-12 Read and write values for the PMCNTENSET.Px bits**

Px value	Meaning on read	Action on write
0	PMNx event counter disabled	No action, write is ignored
1	PMNx event counter enabled	Enable the PMNx event counter

**Accessing the PMCNTENSET register**

To access the PMCNTENSET register, read or write the CP15 registers with <opc1> set to 0, <CRn> set to c9, <CRm> set to c12, and <opc2> set to 1. For example:

```
MRC p15, 0, <Rt>, c9, c12, 1 ; Read PMCNTENSET into Rt  
MCR p15, 0, <Rt>, c9, c12, 1 ; Write Rt to PMCNTENSET
```

## B6.1.75 PMCR, Performance Monitors Control Register, PMSA

When accessed through the CP15 interface, the PMCR characteristics are:

<b>Purpose</b>	The PMCR provides details of the Performance Monitors implementation, including the number of counters implemented, and configures and controls the counters. This register is a Performance Monitors register.
<b>Usage constraints</b>	The PMCR is accessible in: <ul style="list-style-type: none"> <li>• all PL1 modes</li> <li>• User mode when <code>PMUSERENR.EN</code> is set to 1.</li> </ul> See <a href="#">Access permissions on page C12-2328</a> for more information. See also <a href="#">Counter enables on page C12-2311</a> and <a href="#">Counter access on page C12-2312</a> .
<b>Configurations</b>	Implemented only as part of the Performance Monitors Extension. The VMSA and PMSA definitions of the register fields are identical.
<b>Attributes</b>	A 32-bit RW register with a reset value that depends on the register implementation. For more information see the register bit descriptions and <a href="#">Power domains and Performance Monitors registers reset on page C12-2327</a> . <a href="#">Table C12-7 on page C12-2327</a> shows the CP15 encodings of all of the Performance Monitors registers.

———— **Note** —————

[Differences in the memory-mapped views of the Performance Monitors registers on page AppxB-2352](#) describes how the characteristics of the PMCR differ when it is accessed through an external debug interface or a memory-mapped interface.

The PMCR bit assignments are:

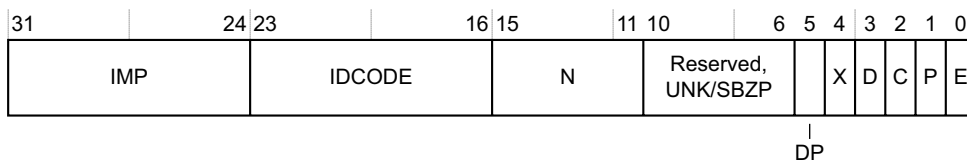

<b>IMP, bits[31:24]</b>	Implementer code. This field is RO with an IMPLEMENTATION DEFINED value. The implementer codes are allocated by ARM. Values have the same interpretation as bits[31:24] of the <a href="#">MIDR</a> .
<b>IDCODE, bits[23:16]</b>	Identification code. This field is RO with an IMPLEMENTATION DEFINED value. Each implementer must maintain a list of identification codes that is specific to the implementer. A specific implementation is identified by the combination of the implementer code and the identification code.
<b>N, bits[15:11]</b>	Number of event counters. This field is RO with an IMPLEMENTATION DEFINED value that indicates the number of counters implemented. The value of this field is the number of counters implemented, from <code>0b000000</code> for no counters to <code>0b111111</code> for 31 counters. An implementation can implement only the Cycle Count Register, <a href="#">PMCCNTR</a> . This is indicated by a value of <code>0b000000</code> for the N field.
<b>Bits[10:6]</b>	Reserved, UNK/SBZP.

<b>DP, bit[5]</b>	<p>Disable <b>PMCCNTR</b> when event counting is prohibited. The possible values of this bit are:</p> <p><b>0</b>      Cycle counter operates regardless of the non-invasive debug authentication settings.</p> <p><b>1</b>      Cycle counter is disabled if non-invasive debug is not permitted.</p> <p>For more information, see <a href="#">Effects of non-invasive debug authentication on the Performance Monitors on page C12-2302</a> and <a href="#">Chapter C9 Non-invasive Debug Authentication</a>.</p> <p>This bit is RW. Its non-debug logic reset value is 0.</p>
<b>X, bit[4]</b>	<p>Export enable. The possible values of this bit are:</p> <p><b>0</b>      Export of events is disabled.</p> <p><b>1</b>      Export of events is enabled.</p> <p>This bit enables the exporting of events to another debug device, such as a trace macrocell, over an event bus. If the implementation does not include such an event bus, this bit is RAZ/WI.</p> <p>This bit does not affect the generation of Performance Monitors interrupts, that can be implemented as a signal exported from the processor to an interrupt controller.</p> <p>This bit is RW. Its non-debug logic reset value is 0.</p>
<b>D, bit[3]</b>	<p>Cycle counter clock divider. The possible values of this bit are:</p> <p><b>0</b>      When enabled, <b>PMCCNTR</b> counts every clock cycle.</p> <p><b>1</b>      When enabled, <b>PMCCNTR</b> counts once every 64 clock cycles.</p> <p>This bit is RW. Its non-debug logic reset value is 0.</p>
<b>C, bit[2]</b>	<p>Cycle counter reset. This bit is WO. The effects of writing to this bit are:</p> <p><b>0</b>      No action.</p> <p><b>1</b>      Reset <b>PMCCNTR</b> to zero.</p> <p>———— <b>Note</b> —————</p> <p>Resetting <b>PMCCNTR</b> does not clear the <b>PMCCNTR</b> overflow bit to 0. For more information, see the description of <b>PMOVSr</b>.</p> <p>—————</p> <p>This bit is always RAZ.</p>
<b>P, bit[1]</b>	<p>Event counter reset. This bit is WO. The effects of writing to this bit are:</p> <p><b>0</b>      No action.</p> <p><b>1</b>      Reset all event counters, not including <b>PMCCNTR</b>, to zero.</p> <p>———— <b>Note</b> —————</p> <p>Resetting the event counters does not clear any overflow bits to 0. For more information, see the description of <b>PMOVSr</b>.</p> <p>—————</p> <p>This bit is always RAZ.</p>
<b>E, bit[0]</b>	<p>Enable. The possible values of this bit are:</p> <p><b>0</b>      All counters, including <b>PMCCNTR</b>, are disabled.</p> <p><b>1</b>      All counters are enabled.</p> <p>For more information, see <a href="#">Counter enables on page C12-2311</a>.</p> <p>This bit is RW. Its non-debug logic reset value is 0.</p>

### **Accessing the PMCR**

To access PMCR, read or write the CP15 registers with <opc1> set to 0, <CRn> set to c9, <CRm> set to c12, and <opc2> set to 0. For example:

```
MRC p15, 0, <Rt>, c9, c12, 0 ; Read PMCR into Rt  
MCR p15, 0, <Rt>, c9, c12, 0 ; Write Rt to PMCR
```

## B6.1.76 PMINTENCLR, Performance Monitors Interrupt Enable Clear register, PMSA

When accessed through the CP15 interface, the PMINTENCLR register characteristics are:

- Purpose** The PMINTENCLR register disables the generation of interrupt requests on overflows from:
- the Cycle Count Register, [PMCCNTR](#)
  - each implemented event counter, PMNx.
- Reading the register shows which overflow interrupt requests are enabled.  
 This register is a Performance Monitors register.
- Usage constraints** The PMINTENCLR register is accessible in all PL1 modes.  
 In User mode, instructions that access the register are always UNDEFINED, even if [PMUSERENR.EN](#) is set to 1.  
 See [Access permissions on page C12-2328](#) for more information. See also [Counter access on page C12-2312](#).  
 PMINTENCLR is used in conjunction with the [PMINTENSET](#) register.
- Configurations** Implemented only as part of the Performance Monitors Extension.  
 The VMSA and PMSA definitions of the register fields are identical.
- Attributes** A 32-bit RW register with a reset value that is UNKNOWN on a non-debug logic reset. See also [Power domains and Performance Monitors registers reset on page C12-2327](#).  
[Table C12-7 on page C12-2327](#) shows the CP15 encodings of all of the Performance Monitors registers.

———— **Note** —————

[Differences in the memory-mapped views of the Performance Monitors registers on page AppxB-2352](#) describes how the characteristics of the PMINTENCLR register differ when it is accessed through an external debug interface or a memory-mapped interface.

The PMINTENCLR register bit assignments are:

31	30	N	N-1	0
C	Reserved, RAZ/WI		Event counter overflow interrupt request disable bits, Px, for x = 0 to (N-1)	

———— **Note** —————

In the description of the PMINTENCLR register, N and x have the meanings used in the description of the [PMCNTENSET](#) register.

- C, bit[31]** [PMCCNTR](#) overflow interrupt request disable bit.  
[Table B6-13](#) shows the behavior of this bit on reads and writes.

**Table B6-13 Read and write values for the PMINTENCLR.C bit**

Value	Meaning on read	Action on write
0	Cycle count interrupt request disabled	No action, write is ignored
1	Cycle count interrupt request enabled	Disable the cycle count interrupt request

**Bits[30:N]** RAZ/WI.

**Px, bit[x], for x = 0 to (N-1)**

Event counter x, PMNx, overflow interrupt request disable bit.

Table B6-14 shows the behavior of this bit on reads and writes.

**Table B6-14 Read and write values for the PMINTENCLR.Px bits**

Px value	Meaning on read	Action on write
0	PMNx interrupt request disabled	No action, write is ignored
1	PMNx interrupt request enabled	Disable the PMNx interrupt request

For more information about counter overflow interrupt requests see the [PMINTENSET](#) register description.

**Accessing the PMINTENCLR register**

To access the PMINTENCLR register, read or write the CP15 registers with <opc1> set to 0, <CRn> set to c9, <CRm> set to c14, and <opc2> set to 2. For example:

MRC p15, 0, <Rt>, c9, c14, 2 : Read PMINTENCLR into Rt  
MCR p15, 0, <Rt>, c9, c14, 2 : Write Rt to PMINTENCLR

## B6.1.77 PMINTENSET, Performance Monitors Interrupt Enable Set register, PMSA

When accessed through the CP15 interface, the PMINTENSET register characteristics are:

- Purpose** The PMINTENSET register enables the generation of interrupt requests on overflows from:
- the Cycle Count Register, [PMCCNTR](#)
  - each implemented event counter, PMNx.
- Reading the register shows which overflow interrupt requests are enabled.  
 This register is a Performance Monitors register.
- Usage constraints** The PMINTENSET register is accessible in all PL1 modes.  
 In User mode, instructions that access the register are always UNDEFINED, even if [PMUSERENR.EN](#) is set to 1.  
 See [Access permissions on page C12-2328](#) for more information. See also [Counter access on page C12-2312](#).  
 PMINTENSET is used in conjunction with the [PMINTENCLR](#) register.
- Configurations** Implemented only as part of the Performance Monitors Extension.  
 The VMSA and PMSA definitions of the register fields are identical.
- Attributes** A 32-bit RW register with a reset value that is UNKNOWN on a non-debug logic reset. See also [Power domains and Performance Monitors registers reset on page C12-2327](#).  
[Table C12-7 on page C12-2327](#) shows the CP15 encodings of all of the Performance Monitors registers.

———— **Note** —————

[Differences in the memory-mapped views of the Performance Monitors registers on page AppxB-2352](#) describes how the characteristics of the PMINTENSET register differ when it is accessed through an external debug interface or a memory-mapped interface.

The PMINTENSET register bit assignments are:

31	30	N	N-1	0
C	Reserved, RAZ/WI		Event counter overflow interrupt request enable bits, Px, for x = 0 to (N-1)	

———— **Note** —————

In the description of the PMINTENSET register, N and x have the meanings used in the description of the [PMCNTENSET](#) register.

- C, bit[31]** [PMCCNTR](#) overflow interrupt request enable bit.  
[Table B6-15](#) shows the behavior of this bit on reads and writes.

**Table B6-15 Read and write values for the PMINTENSET.C bit**

Value	Meaning on read	Action on write
0	Cycle count interrupt request disabled	No action, write is ignored
1	Cycle count interrupt request enabled	Enable the cycle count interrupt request

- Bits[30:N]** RAZ/WI.

**Px, bit[x], for x = 0 to (N-1)**

Event counter x, PMNx, overflow interrupt request enable bit.

Table B6-16 shows the behavior of this bit on reads and writes.

**Table B6-16 Read and write values for the PMINTENSET.Px bits**

Px value	Meaning on read	Action on write
0	PMNx interrupt request disabled	No action, write is ignored
1	PMNx interrupt request enabled	Enable the PMNx interrupt request

The debug logic does not signal an interrupt request if the [PMCR.E](#) enable bit is set to 0.

When an interrupt is signaled, software can remove it by writing a 1 to the corresponding overflow bit in the [PMOVSr](#).

———— **Note** —————

ARM expects that the interrupt request that can be generated on a counter overflow is exported from the processor, meaning it can be factored into a system interrupt controller if applicable. This means that normally the system has more levels of control of the interrupt generated.

**Accessing the PMINTENSET register**

To access the PMINTENSET register, read or write the CP15 registers with <opc1> set to 0, <CRn> set to c9, <CRm> set to c14, and <opc2> set to 1. For example:

MRC p15, 0, <Rt>, c9, c14, 1 : Read PMINTENSET into Rt  
MCR p15, 0, <Rt>, c9, c14, 1 : Write Rt to PMINTENSET



## B6.1.78 PMOVSR, Performance Monitors Overflow Flag Status Register, PMSA

When accessed through the CP15 interface, the PMOVSR characteristics are:

- Purpose** The PMOVSR holds the state of the overflow bits for:
- the Cycle Count Register, [PMCCNTR](#)
  - each of the implemented event counters, PMNx.
- Software must write to this register to clear these bits.  
 This register is a Performance Monitors register.
- Usage constraints** The PMOVSR is accessible in:
- all PL1 modes
  - User mode when [PMUSERENR.EN](#) is set to 1.
- See [Access permissions on page C12-2328](#) for more information. See also [Counter access on page C12-2312](#).
- Configurations** Implemented only as part of the Performance Monitors Extension.  
 The VMSA and PMSA definitions of the register fields are identical.
- Attributes** A 32-bit RW register with a reset value that is UNKNOWN on a non-debug logic reset. See also [Power domains and Performance Monitors registers reset on page C12-2327](#).  
[Table C12-7 on page C12-2327](#) shows the CP15 encodings of all of the Performance Monitors registers.

———— **Note** —————

[Differences in the memory-mapped views of the Performance Monitors registers on page AppxB-2352](#) describes how the characteristics of the PMOVSR differ when it is accessed through an external debug interface or a memory-mapped interface.

The PMOVSR bit assignments are:

31	30	N	N-1	0
C	Reserved, RAZ/WI	Event counter overflow bits, Px, for x = 0 to (N-1)		

———— **Note** —————

In the description of the PMOVSR, N and x have the meanings used in the description of the [PMCNTENSET](#) register.

- C, bit[31]** [PMCCNTR](#) overflow bit.  
[Table B6-17](#) shows the behavior of this bit on reads and writes.

**Table B6-17 Read and write values for the PMOVSR.C bit**

Value	Meaning on read	Action on write
0	Cycle counter has not overflowed	No action, write is ignored
1	Cycle counter has overflowed	Clear bit to 0

- Bits[30:N]** RAZ/WI.

**Px, bit[x], for x = 0 to (N-1)**

Event counter x, PMNx, overflow bit.

Table B6-18 shows the behavior of this bit on reads and writes.

**Table B6-18 Read and write values for the PMOVSR.Px bits**

Px value	Meaning on read	Action on write
0	PMNx event counter has not overflowed	No action, write is ignored
1	PMNx event counter has overflowed	Clear bit to 0

**Note**

The overflow bit values for individual counters are retained until cleared to 0 by a write to PMOVSR or processor reset, even if the counter is later disabled by writing to the PMCNTENCLR register or through the PMCR.E enable bit. The overflow bits are also not cleared to 0 when the counters are reset through the Event counter reset or Clock counter reset bits in the PMCR.

**Accessing the PMOVSR**

To access the PMOVSR, read or write the CP15 registers with <opc1> set to 0, <CRn> set to c9, <CRm> set to c12, and <opc2> set to 3. For example:

```
MRC p15, 0, <Rt>, c9, c12, 3;   Read PMOVSR into Rt
MCR p15, 0, <Rt>, c9, c12, 3;   Write Rt to PMOVSR
```

## B6.1.79 PMSELR, Performance Monitors Event Counter Selection Register, PMSA

The PMSELR characteristics are:

- Purpose**
- In PMUv1, PMSELR selects an event counter, PMN<sub>x</sub>.
  - In PMUv2, PMSELR selects an event counter, PMN<sub>x</sub>, or the cycle counter, CCNT. The PMSELR.SEL value of 31 selects the cycle counter.

This register is a Performance Monitors register.

**Usage constraints** The PMSELR is accessible in:

- all PL1 modes
- User mode when `PMUSERENR.EN == 1`.

See [Access permissions on page C12-2328](#) for more information. See also [Counter access on page C12-2312](#).

PMSELR is not visible in an external debug interface or a memory-mapped interface to the Performance Monitors registers.

When using CP15 to access the Performance Monitors registers, PMSELR is used in conjunction with:

- [PMXEVTYPER](#), to determine:
  - the event that increments a selected event counter
  - in PMUv2, the modes and states in which the selected counter increments.
- [PMXEVCNTR](#), to determine the value of a selected event counter.

**Configurations** Implemented only as part of the Performance Monitors Extension.

The VMSA and PMSA definitions of the register fields are identical.

**Attributes** A 32-bit RW register with a reset value that is UNKNOWN on a non-debug logic reset. See also [Power domains and Performance Monitors registers reset on page C12-2327](#).

[Table C12-7 on page C12-2327](#) shows the CP15 encodings of all of the Performance Monitors registers.

The PMSELR bit assignments are:



**Bits[31:5]** Reserved, UNK/SBZP.

**SEL, bits[4:0]** Selects event counter, PMN<sub>x</sub>, where *x* is the value held in this field. That is, the SEL field identifies which event counter, PMN<sub>SEL</sub>, is accessed, when a subsequent access to [PMXEVTYPER](#) or [PMXEVCNTR](#) occurs. In:

**PMUv1** This field can take any value from 0 (0b00000) to (PMCR.N)-1. The value of 0b11111 is Reserved and must not be used.  
 If this field is set to a value greater than or equal to the number of implemented counters the results are UNPREDICTABLE.

**PMUv2** This field can take any value from 0 (0b00000) to (PMCR.N)-1, or 31 (0b11111). When PMSELR.SEL is 0b11111:

- it selects the it selects the [PMXEVTYPER](#) for the cycle counter
- a read or write of [PMXEVCNTR](#) is UNPREDICTABLE.

If this field is set to a value greater than or equal to the number of implemented counters, but not equal to 31, the results are UNPREDICTABLE.

**Note**

The number of implemented counters is defined by the [PMCR.N](#) field.

## **Accessing the PMSEL**

To access the PMSEL, read or write the CP15 registers with <opc1> set to 0, <CRn> set to c9, <CRm> set to c12, and <opc2> set to 5. For example:

```
MRC p15, 0, <Rt>, c9, c12, 5 ; Read PMSEL into Rt  
MCR p15, 0, <Rt>, c9, c12, 5 ; Write Rt to PMSEL
```

## B6.1.80 PMSWINC, Performance Monitors Software Increment register, PMSA

When accessed through the CP15 interface, the PMSWINC register characteristics are:

<b>Purpose</b>	The PMSWINC register increments a counter that is configured to count the Software increment event, event 0x00.  This register is a Performance Monitors register.
<b>Usage constraints</b>	The PMSWINC register is accessible in: <ul style="list-style-type: none"> <li>• all PL1 modes</li> <li>• User mode when <a href="#">PMUSERENR.EN</a> is set to 1.</li> </ul> See <a href="#">Access permissions on page C12-2328</a> for more information.
<b>Configurations</b>	Implemented only as part of the Performance Monitors Extension.  The VMSA and PMSA definitions of the register fields are identical.
<b>Attributes</b>	A 32-bit WO register. See also <a href="#">Power domains and Performance Monitors registers reset on page C12-2327</a> .  <a href="#">Table C12-7 on page C12-2327</a> shows the CP15 encodings of all of the Performance Monitors registers.

———— **Note** —————

[Differences in the memory-mapped views of the Performance Monitors registers on page AppxB-2352](#) describes how the characteristics of the PMSWINC register differ when it is accessed through an external debug interface or a memory-mapped interface.

The PMSWINC register bit assignments are:

31		N		N-1								0
Reserved, WI				Event counter software increment bits, Px, for x = 0 to (N-1)								

———— **Note** —————

In the description of the PMSWINC register, N and x have the meanings used in the description of the [PMCNTENSET](#) register.

**Bits[31:N]** Reserved, WI.

**Px, bit[x], for x = 0 to (N-1)**

Event counter x, PMNx, software increment bit. This bit is WO. The effects of writing to this bit are:

**0** No action, the write is ignored.

**1, if PMNx is enabled and configured to count the Software increment event**

Increment the PMNx event counter by 1.

**1, if PMNx is disabled or not configured to count the Software increment event**

The behavior depends on the PMU version:

**PMUv1** UNPREDICTABLE.

**PMUv2** No action, the write is ignored.

### Accessing the PMSWINC register

To access the PMSWINC register, write the CP15 registers with <opc1> set to 0, <CRn> set to c9, <CRm> set to c12, and <opc2> set to 4. For example:

MCR p15, 0, <Rt>, c9, c12, 4 ; Write Rt to PMSWINC

## B6.1.81 PMUSERENR, Performance Monitors User Enable Register, PMSA

When accessed through the CP15 interface, the PMUSERENR characteristics are:

<b>Purpose</b>	PMUSERENR enables or disables User mode access to the Performance Monitors. This register is a Performance Monitors register.
<b>Usage constraints</b>	The PMUSERENR is accessible in: <ul style="list-style-type: none"><li>• all PL1 modes</li><li>• User mode, as RO.</li></ul> See <a href="#">Access permissions on page C12-2328</a> for more information.
<b>Configurations</b>	Implemented only as part of the Performance Monitors Extension. The VMSA and PMSA definitions of the register fields are identical.
<b>Attributes</b>	A 32-bit RW register. PMUSERENR.EN is set to 0 on a non-debug logic reset. See also <a href="#">Power domains and Performance Monitors registers reset on page C12-2327</a> . <a href="#">Table C12-7 on page C12-2327</a> shows the CP15 encodings of all of the Performance Monitors registers.

### Note

[Differences in the memory-mapped views of the Performance Monitors registers on page AppxB-2352](#) describes how the characteristics of the PMUSERENR differ when it is accessed through an external debug interface or a memory-mapped interface.

The PMUSERENR bit assignments are:

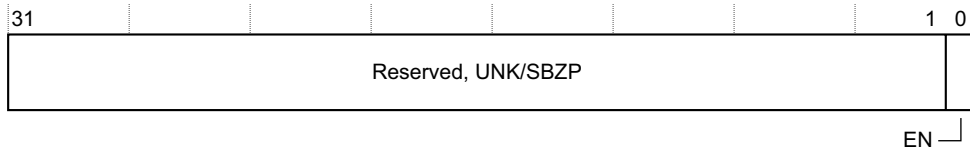

<b>Bits[31:1]</b>	Reserved, UNK/SBZP.
<b>EN, bit[0]</b>	User mode access enable bit. The possible values of this bit are: <ul style="list-style-type: none"><li><b>0</b> User mode access to the Performance Monitors disabled.</li><li><b>1</b> User mode access to the Performance Monitors enabled.</li></ul>

Some MCR and MRC instruction accesses to the Performance Monitors are UNDEFINED in User mode when the EN bit is set to 0. For more information, see [Access permissions on page C12-2328](#).

### Accessing the PMUSERENR

To access the PMUSERENR, read or write the CP15 registers with <opc1> set to 0, <CRn> set to c9, <CRm> set to c14, and <opc2> set to 0. For example:

```
MRC p15, 0, <Rt>, c9, c14, 0 : Read PMUSERENR into Rt  
MCR p15, 0, <Rt>, c9, c14, 0 : Write Rt to PMUSERENR
```

## B6.1.82 PMXEVNTR, Performance Monitors Event Count Register, PMSA

When accessed through the CP15 interface, the PMXEVNTR characteristics are:

<b>Purpose</b>	The PMXEVNTR reads or writes the value of the selected event counter, PMNx. <a href="#">PMSELR.SEL</a> determines which event counter is selected. This register is a Performance Monitors register.
<b>Usage constraints</b>	The PMXEVNTR is accessible in: <ul style="list-style-type: none"> <li>• all PL1 modes</li> <li>• User mode when <a href="#">PMUSERENR.EN</a> is set to 1.</li> </ul> If <a href="#">PMSELR.SEL</a> selects a counter that is not accessible then reads and writes of PMXEVNTR are UNPREDICTABLE. This applies if <a href="#">PMSELR.SEL</a> is larger than the number of implemented counters. For more information, see <a href="#">Counter access on page C12-2312</a> and <a href="#">Access permissions on page C12-2328</a> .
<b>Configurations</b>	Implemented only as part of the Performance Monitors Extension. The VMSA and PMSA definitions of the register fields are identical.
<b>Attributes</b>	A 32-bit RW register with a reset value that is UNKNOWN on a non-debug logic reset. See also <a href="#">Power domains and Performance Monitors registers reset on page C12-2327</a> . <a href="#">Table C12-7 on page C12-2327</a> shows the CP15 encodings of all of the Performance Monitors registers.

———— **Note** ————

[Differences in the memory-mapped views of the Performance Monitors registers on page AppxB-2352](#) describes how the characteristics of the PMXEVNTR differ when it is accessed through an external debug interface or a memory-mapped interface.

The PMXEVNTR bit assignments are:

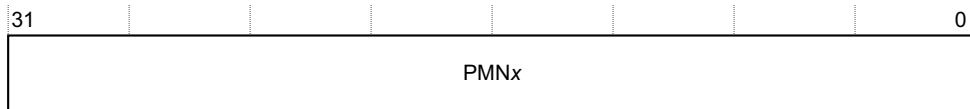

**PMNX, bits[31:0]** Value of the selected event counter, PMNx.

———— **Note** ————

Software can write to the PMXEVNTR even when the counter is disabled. This is true regardless of why the counter is disabled, which can be any of:

- because 1 has been written to the appropriate bit in the [PMCNTENCLR](#) register
- because the [PMCR.E](#) bit is set to 0
- by the non-invasive debug authentication.

### Accessing the PMXEVNTR

To access the PMXEVNTR:

1. Update the [PMSELR](#) to select the required event counter, PMNx.
2. Read or write the CP15 registers with <opc1> set to 0, <CRn> set to c9, <CRm> set to c13, and <opc2> set to 2. For example:

```
MRC p15, 0, <Rt>, c9, c13, 2 : Read PMXEVNTR into Rt
MCR p15, 0, <Rt>, c9, c13, 2 : Write Rt to PMXEVNTR
```

## B6.1.83 PMXEVTYPER, Performance Monitors Event Type Select Register, PMSA

When accessed through the CP15 interface, the PMXEVTYPER characteristics are:

**Purpose** When [PMSELR.SEL](#) selects an event counter, PMN<sub>x</sub>, PMXEVTYPER configures which event increments that event counter.  
 In PMUv2 PMXEVTYPER also determines the modes in which PMN<sub>x</sub> or [PMCCNTR](#) increments.  
 The [PMSELR.SEL](#) determines which event counter is selected, or if [PMCCNTR](#) is selected.

———— **Note** —————

A [PMSELR.SEL](#) value of 0b11111:

- in PMUv1, is reserved
- in PMUv2, selects the PMXEVTYPER for [PMCCNTR](#).

—————

This register is a Performance Monitors register.

**Usage constraints** The PMXEVTYPER is accessible in:

- all PL1 modes
- User mode when [PMUSERENR.EN](#) == 1.

If [PMSELR.SEL](#) selects a counter that is not accessible, then reads and writes of PMXEVTYPER are UNPREDICTABLE.

This applies:

- in an implementation that includes PMUv1, if [PMSELR.SEL](#) is larger than the number of implemented counters
- in an implementation that includes PMUv2, if [PMSELR.SEL](#) is larger than the number of implemented counters, but not 0b11111.

For more information, see [Counter access on page C12-2312](#) and [Access permissions on page C12-2328](#).

**Configurations** Implemented only as part of the Performance Monitors Extension.  
 In PMUv1, the VMSA and PMSA definitions of the register fields are identical.

**Attributes** A 32-bit RW register. See [PMXEVTYPER reset values on page B6-1925](#) for information about the non-debug logic reset value. See also [Power domains and Performance Monitors registers reset on page C12-2327](#).  
[Table C12-7 on page C12-2327](#) shows the CP15 encodings of all of the Performance Monitors registers.

———— **Note** —————

[Differences in the memory-mapped views of the Performance Monitors registers on page AppxB-2352](#) describes how the characteristics of the PMXEVTYPER differ when it is accessed through an external debug interface or a memory-mapped interface.

In PMUv1, the PMXEVTYPER bit assignments are:

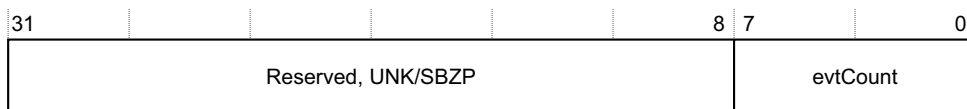

**Bits[31:8]** Reserved, UNK/SBZP.

**evtCount, bits[7:0]** Event to count. The event number of the event that is counted by the selected event counter, PMN<sub>x</sub>. For more information, see [Event numbers on page B6-1925](#).



In PMUv2, in a PMSA implementation, the PMXEVTYPER bit assignments are:

31	30	29	8	7	0
P	U	Reserved, UNK/SBZP			evtCount

**P, bit[31]** Privileged execution filtering bit. Controls counting when execution is at PL1. The possible values of this bit are:

- 0** Count events when executing at PL1.
- 1** Do not count events when executing at PL1.

**U, bit[30]** Unprivileged execution filtering bit. Controls counting when execution is at PL0. The possible values of this bit are:

- 0** Count events when executing at PL0.
- 1** Do not count events when executing at PL0.

**Bits[29:8]** Reserved, UNK/SBZP.

**evtCount, bits[7:0]** Event to count. The event number of the event that is counted by the selected event counter, PMNx. For more information, see [Event numbers](#).

This field is reserved when [PMSELR.SEL](#) is set to 31, to select [PMCCNTR](#).

ARM strongly recommends that software does not program both PMXEVTYPER.P and PMXEVTYPER.U to 1. That is, ARM recommends that software does not use these bits to disable counting.

———— **Note** —————

- In some documentation published before issue C.a of this manual, the PMXEVTYPER register accessed when [PMSELR.SEL](#) is set to 31 is described as the PMCCFILTR.
- In issue C.a of this manual, the P bit is called the PL1 bit.

### PMXEVTYPER reset values

Immediately after a non-debug logic reset:

- The values of the instances of PMXEVTYPER that relate to a event counter are UNKNOWN. That is, if *m* is one less than the number of implemented event counters, the non-debug reset values of PMXEVTYPER0 to PMXEVTYPER*m* are UNKNOWN.
- In PMUv2, the reset values of the defined fields of the instance of PMXEVTYPER that relates to the cycle counter are zero. That is, the non-debug reset value of PMXEVTYPER31.{P, U} is {0, 0}.

### Event numbers

The PMXEVTYPER uses event numbers to determine the event that causes an event counter to increment. These event numbers are split into two ranges:

- 0x00–0x3F** Common features. Reserved for the specified events. When an ARMv7 processor supports monitoring of an event that is assigned a number in this range, if possible it must use that number for the event. Unassigned values are reserved and might be used for additional common events in future versions of the architecture. For more information about the assigned values in the common features range, see [Common event numbers on page C12-2316](#).
- 0x40–0xFF** IMPLEMENTATION DEFINED features. For more information, see [IMPLEMENTATION DEFINED event numbers on page C12-2325](#).

## Accessing the PMXEVTYPER

To access the PMXEVTYPER:

1. Update the [PMSELR](#) to select the required event counter, PMNx, or, in PMUv2, [PMCCNTR](#).
2. Read or write the CP15 registers with <opc1> set to 0, <CRn> set to c9, <CRm> set to c13, and <opc2> set to 1. For example:

```
MRC p15, 0, <Rt>, c9, c13, 1 : Read PMXEVTYPER into Rt  
MCR p15, 0, <Rt>, c9, c13, 1 : Write Rt to PMXEVTYPER
```

## B6.1.84 REVIDR, Revision ID Register, PMSA

The REVIDR characteristics are:

<b>Purpose</b>	The REVIDR provides implementation-specific minor revision information that can only be interpreted in conjunction with the <a href="#">MIDR</a> . This register is part of the Identification registers functional group.
<b>Usage constraints</b>	Only accessible from PL1 or higher.
<b>Configurations</b>	An optional register. When REVIDR is not implemented, its encoding is an alias of the <a href="#">MIDR</a> . This register is not implemented in architecture versions before ARMv7.
<b>Attributes</b>	A 32-bit RO register with an IMPLEMENTATION DEFINED value. See also <a href="#">Reset behavior of CP14 and CP15 registers on page B5-1776</a> . <a href="#">Table B5-13 on page B5-1798</a> shows the encodings of all of the registers in the Identification registers functional group.

The REVIDR bit assignments are IMPLEMENTATION DEFINED.

### ———— Note ————

To determine whether REVIDR is implemented, software can:

- Read [MIDR](#).
- Read REVIDR.
- Compare the two values. If they are identical, REVIDR is not implemented.

### Accessing the REVIDR

To access REVIDR, software reads the CP15 registers with <opc1> set to 0, <CRn> set to c0, <CRm> set to c0, and <opc2> set to 6. For example:

MRC p15, 0, <Rt>, c0, c0, 6 ; Read REVIDR into Rt

## B6.1.85 RGNR, MPU Region Number Register, PMSA

The RGNR characteristics are:

<b>Purpose</b>	<p>The RGNR defines the current memory region in:</p> <ul style="list-style-type: none"> <li>• the MPU data or unified address map</li> <li>• the MPU instruction address map, if the implementation supports separate data and instruction address maps.</li> </ul> <p>The value in the RGNR identifies the memory region description accessed by:</p> <ul style="list-style-type: none"> <li>• the <a href="#">DRBAR</a>, <a href="#">DRSR</a>, and <a href="#">DRACR</a></li> <li>• the <a href="#">IRBAR</a>, <a href="#">IRSR</a>, and <a href="#">IRACR</a>, if the implementation supports separate data and instruction address maps.</li> </ul> <p>This register is part of the MMU control registers functional group.</p>
<b>Usage constraints</b>	<p>Only accessible from PL1.</p> <p>Used in conjunction with the other MPU Memory region programming registers, see <a href="#">Programming the MPU region attributes on page B5-1761</a>.</p>
<b>Configurations</b>	Always implemented.
<b>Attributes</b>	<p>A 32-bit RW register with an UNKNOWN reset value. See also <a href="#">Reset behavior of CP14 and CP15 registers on page B5-1776</a>.</p> <p><a href="#">Table B5-14 on page B5-1799</a> shows the encodings of all of the registers in the MMU control registers functional group.</p>

The RGNR bit assignments are:

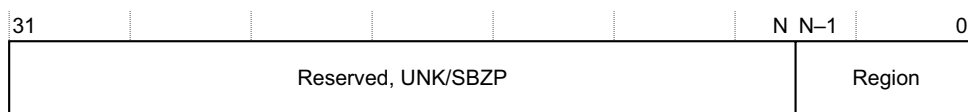

**Bit[31:N]** Reserved, UNK/SBZP.

**Region, bits[N-1:0]**

The number of the current region in the Data or Unified address map, and in the Instruction address map if the MPU implements separate Data and Instruction address maps.

The value of N is  $\text{Log}_2(\text{Number of regions supported})$ , rounded up to an integer.

Memory region numbering starts at 0 and goes up to one less than the number of regions supported.

Writing a value to this register that is greater than or equal to the number of memory regions supported has UNPREDICTABLE results.

In the context of the RGNR description, when the MPU implements separate Data and Instruction address maps:

- There is only a single MPU Region Number Register, and the current region number is always identical for both address maps. This might mean that the current region number is valid for one address map but invalid for the other map.
- The number of memory regions supported is the greater of:
  - number of Data memory regions supported
  - number of Instruction memory regions supported.

For more information see [Programming the MPU region attributes on page B5-1761](#).

## **Accessing the RGNR**

To access the RGNR, software reads or writes the CP15 registers with <opc1> set to 0, <CRn> set to c6, <CRm> set to c2, and <opc2> set to 0. For example:

```
MRC p15, 0, <Rt>, c6, c2, 0 ; Read RGNR into Rt  
MCR p15, 0, <Rt>, c6, c2, 0 ; Write Rt to RGNR
```

### B6.1.86 SCTLR, System Control Register, PMSA

The SCTLR characteristics are:

- Purpose** The SCTLR provides the top level control of the system, including its memory system. This register is part of the MMU control registers functional group.
- Usage constraints** Only accessible from PL1.  
Control bits in the SCTLR that are not applicable to a PMSA implementation read as the value that most closely reflects the implementation, and ignore writes.  
In ARMv7, some bits in the register are read-only. These bits relate to non-configurable features of an ARMv7 implementation, and are provided for compatibility with previous versions of the architecture.
- Configurations** Always implemented.
- Attributes** A 32-bit RW register with an IMPLEMENTATION DEFINED reset value, see [Reset value of the SCTLR on page B6-1934](#). See also [Reset behavior of CP14 and CP15 registers on page B5-1776](#).  
[Table B5-14 on page B5-1799](#) shows the encodings of all of the registers in the MMU control registers functional group.

In an ARMv7-R implementation the SCTLR bit assignments are:

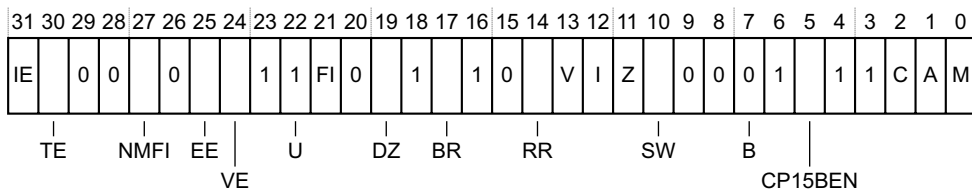

- IE, bit[31]** Instruction Endianness. This bit indicates the endianness of the instructions issued to the processor. The possible values of this bit are:
  - 0** Little-endian byte ordering in the instructions.
  - 1** Big-endian byte ordering in the instructions.
 When set to 1, this bit causes the byte order of instructions to be reversed at runtime.  
 This bit is read-only. It is IMPLEMENTATION DEFINED which instruction endianness is used by an ARMv7-R implementation, and this bit must indicate the implemented endianness.  
 If IE == 1 and EE == 0, behavior is UNPREDICTABLE.
- TE, bit[30]** Thumb Exception enable. This bit controls whether exceptions are taken in ARM or Thumb state. The possible values of this bit are:
  - 0** Exceptions, including reset, taken in ARM state.
  - 1** Exceptions, including reset, taken in Thumb state.
 An implementation can include a configuration input signal that determines the reset value of the TE bit. If the implementation does not include a configuration signal for this purpose then this bit resets to zero in an ARMv7-R implementation.  
 For more information about the use of this bit, see [Instruction set state on exception entry on page B1-1181](#).
- Bits[29:28]** Reserved, RAZ/SBZP.

**NMFI, bit[27]**

*Non-maskable FIQ* (NMFI) support. The possible values of this bit are:

- 0** Software can mask FIQs by setting the [CPSR.F](#) bit to 1.
- 1** Software cannot set the [CPSR.F](#) bit to 1. This means software cannot mask FIQs.

This bit is read-only. It is IMPLEMENTATION DEFINED whether an implementation supports NMFIs. This bit is:

- RAZ if NMFIs are not supported
- determined by a configuration input signal if NMFIs are supported.

For more information, see [Non-maskable FIQs on page B1-1151](#).

**Bit[26]** Reserved, RAZ/SBZP.

**EE, bit[25]** Exception Endianness bit. This bit defines the value of the [CPSR.E](#) bit on entry to an exception vector, including reset. The possible values of this bit are:

- 0** Little-endian.
- 1** Big-endian.

This is a read/write bit. An implementation can include a configuration input signal that determines the reset value of the EE bit. If the implementation does not include a configuration signal for this purpose then this bit resets to zero.

If IE == 1 and EE == 0, behavior is UNPREDICTABLE.

**VE, bit[24]** Interrupt Vectors Enable bit. This bit controls the vectors used for the FIQ and IRQ interrupts. The permitted values of this bit are:

- 0** Use the FIQ and IRQ vectors from the vector table, see the V bit entry.
- 1** Use the IMPLEMENTATION DEFINED values for the FIQ and IRQ vectors.

For more information, see [Vectored interrupt support on page B1-1167](#).

If the implementation does not support IMPLEMENTATION DEFINED FIQ and IRQ vectors then this bit is RAZ/WI.

From the introduction of the Virtualization Extensions, ARM deprecates any use of this bit.

**Bit[23]** Reserved, RAO/SBOP.

**U, bit[22]** In ARMv7 this bit is RAO/SBOP, indicating use of the alignment model described in [Alignment support on page A3-108](#).

For details of this bit in earlier versions of the architecture see [Alignment on page AppxL-2504](#).

**FI, bit[21]** Fast interrupts configuration enable bit. The permitted values of this bit are:

- 0** All performance features enabled.
- 1** Low interrupt latency configuration. Some performance features disabled.

Setting this bit to 1 can reduce the interrupt latency in an implementation, by disabling IMPLEMENTATION DEFINED performance features.

If the implementation does not support a mechanism for selecting a low interrupt latency configuration this bit is RAZ/WI.

For more information, see [Low interrupt latency configuration on page B1-1197](#).

**Bit[20]** Reserved, RAZ/SBZP.

- DZ, bit[19]** Divide by Zero fault enable bit. Any ARMv7-R implementation includes instructions to perform unsigned and signed division, see [Divide instructions on page A4-172](#). This bit controls whether an integer divide by zero causes an Undefined Instruction exception:
- 0** Divide by zero returns the result zero, and no exception is taken.
- 1** Attempting a divide by zero causes an Undefined Instruction exception on the SDIV or UDIV instruction.

———— **Note** —————

An ARMv7-A implementation that supports integer divide instructions does not support generation of an Undefined Instruction exception on a divide by zero.

- Bit[18]** Reserved, RAO/SBOP.
- BR, bit[17]** Background Region bit. When the MPU is enabled this bit controls how an access that does not map to any MPU memory region is handled:
- 0** Any access to an address that is not mapped to an MPU region generates a Background fault memory abort. This is the PMSAv6 behavior.
- 1** The default memory map is used as a background region:
- a PL1 access to an address that does not map to an MPU region takes the properties defined for that address in the default memory map
  - an unprivileged access to an address that does not map to an MPU region generates a Background fault memory abort.

For more information, see [Using the default memory map as a background region on page B5-1756](#).

- Bit[16]** Reserved, RAO/SBOP.

- Bit[15]** Reserved, RAZ/SBZP.

- RR, bit[14]** Round Robin bit. If the cache implementation supports the use of an alternative replacement strategy that has a more easily predictable worst-case performance, this bit controls whether it is used. The possible values of this bit are:

**0** Normal replacement strategy, for example, random replacement.

**1** Predictable strategy, for example, round-robin replacement.

The RR bit must reset to 0.

The replacement strategy associated with each value of the RR bit is IMPLEMENTATION DEFINED.

If the implementation does not support multiple IMPLEMENTATION DEFINED replacement strategies this bit is RAZ/WI.

- V, bit[13]** Vectors bit. This bit selects the base address of the exception vectors. The possible values of this bit are:

**0** Low exception vectors, base address 0x00000000.

**1** High exception vectors (Hivecs), base address 0xFFFF0000.

For more information, see [Exception vectors and the exception base address on page B1-1164](#).

———— **Note** —————

ARM deprecates the use of the Hivecs setting,  $V == 1$ , in an ARMv7-R implementation.

An implementation can include a configuration input signal that determines the reset value of the V bit. If the implementation does not include a configuration signal for this purpose then this bit resets to zero.



- I, bit[12]** Instruction cache enable bit. This is a global enable bit for instruction caches. The possible values of this bit are:
- 0** Instruction caches disabled.
  - 1** Instruction caches enabled.
- If the system does not implement any instruction caches that can be accessed by the processor, at any level of the memory hierarchy, this bit is RAZ/WI.
- If the system implements any instruction caches that can be accessed by the processor then it must be possible to disable them by setting this bit to 0.
- [Cache enabling and disabling on page B2-1270](#) describes the effect of enabling the caches.
- Z, bit[11]** Branch prediction enable bit. The possible values of this bit are:
- 0** Program flow prediction disabled.
  - 1** Program flow prediction enabled.
- Setting this bit to 1 enables branch prediction, also called program flow prediction.
- If program flow prediction cannot be disabled, this bit is RAO/WI.
- If the implementation does not support program flow prediction then this bit is RAZ/WI.
- SW, bit[10]** SWP/SWPB enable bit. This bit enables the use of SWP and SWPB instructions. The possible values of this bit are:
- 0** SWP and SWPB are UNDEFINED.
  - 1** SWP and SWPB perform as described in [SWP, SWPB on page A8-722](#).
- This bit is added as part of the Multiprocessing Extensions.
- From the introduction of the Virtualization Extensions, support for the SWP and SWPB instructions is OPTIONAL and deprecated. In an implementation that does include the SWP and SWPB instructions, the SW bit is RAZ/WI.
- 
- Note**
- Although the Virtualization Extensions cannot form part of an ARMv7-R implementation, from their introduction the SWP and SWPB instructions become OPTIONAL and deprecated, meaning ARM recommends that an ARMv7-R implementation does not include support for these instructions, see [OPTIONAL](#). This is the only effect of the Virtualization Extensions on ARMv7-R.
  - When use of this bit is supported, at reset, this bit disables SWP and SWPB. This means that operating systems have to choose to use SWP and SWPB.
- 
- Bits[9:8]** Reserved, RAZ/SBZP.
- B, bit[7]** In ARMv7 this bit is RAZ/SBZP, indicating use of the endianness model described in [Endian support on page A3-110](#).
- For details of this bit in earlier versions of the architecture see:
- for ARMv6, [Endian support on page AppxL-2505](#)
  - for ARMv4 and ARMv5, [Endian support on page AppxO-2591](#).
- Bit[6]** Reserved, RAO/SBOP.

### CP15BEN, bit[5]

CP15 barrier enable. If implemented, this is an enable bit for the CP15 DMB, DSB, and ISB barrier operations, and the possible values of this bit are:

- 0** CP15 barrier operations disabled. Their encodings are UNDEFINED.
- 1** CP15 barrier operations enabled.

This bit is optional. If not implemented, bit[5] is RAO/WI.

If this bit is implemented, its reset value is 1.

#### ————— **Note** —————

This bit is first defined with the introduction of the Virtualization Extensions. However, it can be implemented on any ARMv7-A or ARMv7-R processor.

For more information about these operations see [Data and instruction barrier operations, PMSA on page B6-1943](#).

**Bits[4:3]** Reserved, RAO/SBOP.

**C, bit[2]** Cache enable bit. This is a global enable bit for data and unified caches. The possible values of this bit are:

- 0** Data and unified caches disabled.
- 1** Data and unified caches enabled.

If the system does not implement any data or unified caches that can be accessed by the processor, at any level of the memory hierarchy, this bit is RAZ/WI.

If the system implements any data or unified caches that can be accessed by the processor then it must be possible to disable them by setting this bit to 0.

For more information about the effect of this bit see [Cache enabling and disabling on page B2-1270](#).

**A, bit[1]** Alignment bit. This is the enable bit for Alignment fault checking. The possible values of this bit are:

- 0** Alignment fault checking disabled.
- 1** Alignment fault checking enabled.

For more information, see [Unaligned data access on page A3-108](#).

**M, bit[0]** MPU enable bit. This is a global enable bit for the MPU. The possible values of this bit are:

- 0** MPU disabled.
- 1** MPU enabled.

For more information, see [Enabling and disabling the MPU on page B5-1756](#).

## Reset value of the SCTLR

The SCTLR has an IMPLEMENTATION DEFINED reset value. There are different types of bit in the SCTLR:

- Some bits are defined as RAZ or RAO, and have the same value in all PMSAv7 implementations. [Figure B6-1 on page B6-1935](#) shows the values of these bits.
- Some bits are read-only and either:
  - have an IMPLEMENTATION DEFINED value
  - have a value that is determined by a configuration input signal.
- Some bits are read/write and either:
  - reset to zero
  - reset to an IMPLEMENTATION DEFINED value
  - reset to a value that is determined by a configuration input signal.

Figure B6-1 shows the reset value, or how the reset value is defined, for each bit of the SCTLR. It also shows the possible values of each half byte of the register.

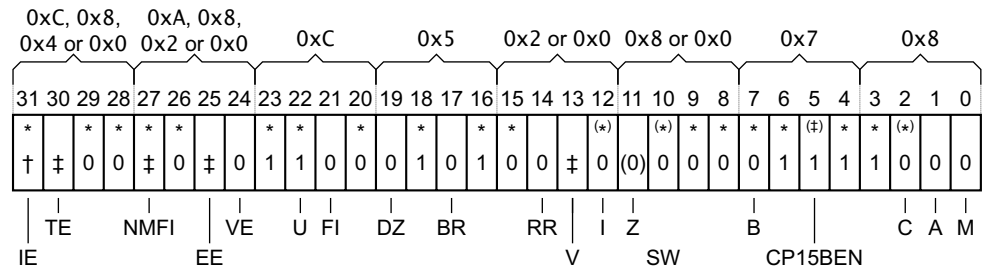

- \* Read-only bits, including RAZ and RAO bits.
- (\*) Can be RAZ. Otherwise read/write, resets to 0.
- † Value is IMPLEMENTATION DEFINED.
- (†) Can be read-only, with IMPLEMENTATION DEFINED value. Otherwise resets to 0.
- (‡) Can be read-only, RAO. Otherwise resets to 1.
- ‡ Value or reset value can depend on configuration input. Otherwise RAZ or resets to 0.

Figure B6-1 Reset value of the SCTLR, PMSAv7

### Accessing the SCTLR

To access SCTLR, software reads or writes the CP15 registers with <opc1> set to 0, <CRn> set to c1, <CRm> set to c0, and <opc2> set to 0. For example:

```
MRC p15, 0, <Rt>, c1, c0, 0 ; Read SCTLR into Rt
MCR p15, 0, <Rt>, c1, c0, 0 ; Write Rt to SCTLR
```

———— **Note** ————

Additional configuration and control bits might be added to the SCTLR in future versions of the ARM architecture. ARM strongly recommends that software always uses a read, modify, write sequence to update the SCTLR. This prevents software modifying any bit that is currently unallocated, and minimizes the chance of the register update having undesired side-effects.

## B6.1.87 TCMTR, TCM Type Register, PMSA

The TCMTR characteristics are:

<b>Purpose</b>	The TCMTR provides information about the implementation of the TCM. This register is part of the Identification registers functional group.
<b>Usage constraints</b>	Only accessible from PL1.
<b>Configurations</b>	In ARMv7: <ul style="list-style-type: none"> <li>• this register must be implemented</li> <li>• when the ARMv7 format is used, the meaning of register bits[28:0] is IMPLEMENTATION DEFINED</li> <li>• the ARMv6 format of the register remains a valid usage model</li> <li>• if no TCMs are implemented the ARMv6 format is used, to indicate zero-sized TCMs.</li> </ul>
<b>Attributes</b>	A 32-bit RO register with an IMPLEMENTATION DEFINED value. See also <a href="#">Reset behavior of CP14 and CP15 registers on page B5-1776</a> . <a href="#">Table B5-13 on page B5-1798</a> shows the encodings of all of the registers in the Identification registers functional group.

In the ARMv7 format, the TCMTR bit assignments are:

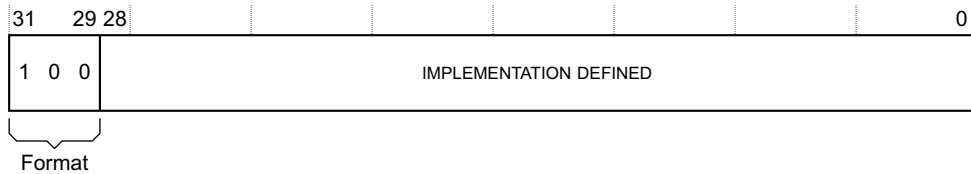

### Format, bits[31:29]

Indicates the implemented TCMTR format. The possible values of this are:

0b000 ARMv6 format, or no TCMs implemented. For more information, see the description of TCMTR in [Appendix L ARMv6 Differences](#).

0b100 ARMv7 format.

All other values are reserved.

**Bits[28:0]** IMPLEMENTATION DEFINED in the ARMv7 register format.

If no TCMs are implemented, the TCMTR must be implemented with the ARMv6 format. In this format the TCMTR bit assignments are:

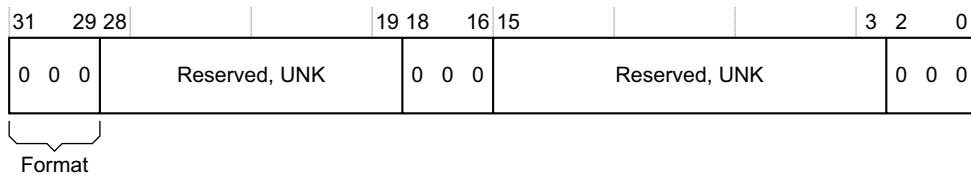

### Accessing the TCMTR

To access the TCMTR, software reads the CP15 registers with <opc1> set to 0, <CRn> set to c0, <CRm> set to c0, and <opc2> set to 2. For example:

MRC p15, 0, <Rt>, c0, c0, 2 ; Read TCMTR into Rt

## B6.1.88 TEECR, ThumbEE Configuration Register, PMSA

The TEECR characteristics are:

<b>Purpose</b>	The TEECR controls unprivileged access to the <a href="#">TEEHBR</a> . This register is a ThumbEE register.
<b>Usage constraints</b>	Access rights depend on the execution privilege: <ul style="list-style-type: none"> <li>• the result of an unprivileged write to the register is UNDEFINED</li> <li>• unprivileged reads, and reads and writes at PL1 or higher, are permitted.</li> </ul>
<b>Configurations</b>	The VMSA and PMSA definitions of the register fields are identical. Implemented in any system that includes the ThumbEE Extension.
<b>Attributes</b>	A 32-bit RW register that resets to zero. <a href="#">Table A2-14 on page A2-95</a> shows the encodings of all of the ThumbEE registers.

The TEECR bit assignments are:

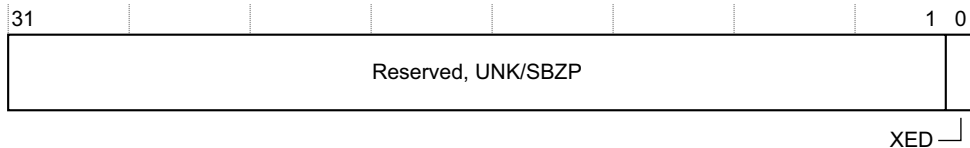

<b>Bits[31:1]</b>	Reserved, UNK/SBZP.
<b>XED, bit[0]</b>	Execution Environment Disable bit. Controls unprivileged access to the ThumbEE Handler Base Register: <ul style="list-style-type: none"> <li><b>0</b> Unprivileged access permitted.</li> <li><b>1</b> Unprivileged access disabled.</li> </ul>

The effects of a write to this register on ThumbEE configuration are only guaranteed to be visible to subsequent instructions after the execution of a context synchronization operation. However, a read of this register always returns the value most recently written to the register.

———— **Note** ————

See [Context synchronization operation](#) for the definition of this term.

### Accessing the TEECR

To access the TEECR, software reads or writes the CP14 registers with <opc1> set to 6, <CRn> set to c0, <CRm> set to c0, and <opc2> set to 0. For example:

```
MRC p14, 6, <Rt>, c0, c0, 0 ; Read TEECR into Rt
MCR p14, 6, <Rt>, c0, c0, 0 ; Write Rt to TEECR
```

## B6.1.89 TEEHBR, ThumbEE Handler Base Register, PMSA

The TEEHBR characteristics are:

- Purpose** The TEEHBR holds the base address for ThumbEE handlers.  
 This register is a ThumbEE register.
- Usage constraints** Access rights depend on the execution privilege and the value of TEECR.XED:
- accesses at PL1 or higher are always permitted
  - when TEECR.XED is 0, unprivileged accesses are permitted
  - when TEECR.XED is 1, the result of an unprivileged access is UNDEFINED.
- Configurations** The VMSA and PMSA definitions of the register fields are identical.  
 Implemented in any system that implements the ThumbEE Extension.  
 In an implementation that includes the Security Extensions, TEEHBR is a Common register.
- Attributes** A 32-bit RW register with an UNKNOWN reset value.  
[Table A2-14 on page A2-95](#) shows the encodings of all of the ThumbEE registers.

The TEEHBR bit assignments are:

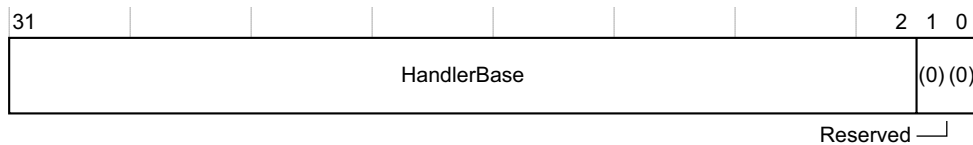

### HandlerBase, bits[31:2]

The address of the ThumbEE Handler\_00 implementation. This is the address of the first of the ThumbEE handlers.

### Bits[1:0]

Reserved, UNK/SBZP.

The effects of a write to this register on ThumbEE handler entry are only guaranteed to be visible to subsequent instructions after the execution of a context synchronization operation. However, a read of this register always returns the value most recently written to the register.

### Accessing the TEEHBR

To access the TEEHBR, software reads or writes the CP14 registers with <opc1> set to 6, <CRn> set to c1, <CRm> set to c0, and <opc2> set to 0. For example:

```
MRC p14, 6, <Rt>, c1, c0, 0 ; Read TEEHBR into Rt
MCR p14, 6, <Rt>, c1, c0, 0 ; Write Rt to TEEHBR
```

## B6.1.90 TPIDRPRW, PL1 only Thread ID Register, PMSA

The TPIDRPRW register characteristics are:

<b>Purpose</b>	Provides a location where software executing at PL1 can store thread identifying information that is not visible to unprivileged software, for OS management purposes. This register is part of the Miscellaneous operations functional group.
<b>Usage constraints</b>	The TPIDRPRW is only accessible from PL1. Processor hardware never updates this register.
<b>Configurations</b>	Not implemented in architecture versions before ARMv7.
<b>Attributes</b>	A 32-bit RW register with an UNKNOWN reset value. See also <a href="#">Reset behavior of CP14 and CP15 registers on page B5-1776</a> . <a href="#">Table B5-19 on page B5-1802</a> shows the encodings of all of the registers in the Miscellaneous operations functional group.

### Accessing the TPIDRPRW register

To access the TPIDRPRW register, software reads or writes the CP15 registers with <opc1> set to 0, <CRn> set to c13, <CRm> set to c0, and <opc2> set to 4.

For example:

```
MRC p15, 0, <Rt>, c13, c0, 4 ; Read TPIDRPRW into Rt  
MCR p15, 0, <Rt>, c13, c0, 4 ; Write Rt to TPIDRPRW
```

## B6.1.91 TPIDRURO, User Read-Only Thread ID Register, PMSA

The TPIDRURO register characteristics are:

<b>Purpose</b>	Provides a location where software executing at PL1 can store thread identifying information that is visible to unprivileged software, for OS management purposes. This register is part of the Miscellaneous operations functional group.
<b>Usage constraints</b>	The TPIDRURO is read-only in User mode. Processor hardware never updates this register.
<b>Configurations</b>	Not implemented in architecture versions before ARMv7.
<b>Attributes</b>	A 32-bit RW register with an UNKNOWN reset value. See also <a href="#">Reset behavior of CP14 and CP15 registers on page B5-1776</a> . <a href="#">Table B5-19 on page B5-1802</a> shows the encodings of all of the registers in the Miscellaneous operations functional group.

### Accessing the TPIDRURO register

To access the TPIDRURO register, software reads or writes the CP15 registers with <opc1> set to 0, <CRn> set to c13, <CRm> set to c0, and <opc2> set to 3.

For example:

```
MRC p15, 0, <Rt>, c13, c0, 3 ; Read TPIDRURO into Rt  
MCR p15, 0, <Rt>, c13, c0, 3 ; Write Rt to TPIDRURO
```

## B6.1.92 TPIDRURW, User Read/Write Thread ID Register, PMSA

The TPIDRURW register characteristics are:

<b>Purpose</b>	Provides a location where software running in User mode can store thread identifying information, for OS management purposes. This register is part of the Miscellaneous operations functional group.
<b>Usage constraints</b>	No usage constraints. The TPIDRURW is accessible at all levels of privilege. Processor hardware never updates this register.
<b>Configurations</b>	Not implemented in architecture versions before ARMv7.
<b>Attributes</b>	A 32-bit RW register with an UNKNOWN reset value. See also <a href="#">Reset behavior of CP14 and CP15 registers on page B5-1776</a> . <a href="#">Table B5-19 on page B5-1802</a> shows the encodings of all of the registers in the Miscellaneous operations functional group.

### Accessing the TPIDRURW register

To access the TPIDRURW register, software reads or writes the CP15 registers with <opc1> set to 0, <CRn> set to c13, <CRm> set to c0, and <opc2> set to 2.

For example:

```
MRC p15, 0, <Rt>, c13, c0, 2 ; Read TPIDRURW into Rt  
MCR p15, 0, <Rt>, c13, c0, 2 ; Write Rt to TPIDRURW
```



## B6.2 PMSA system control operations described by function

This section describes the system control operations that are available in a PMSA implementation and that are described as part of a functional group. Architecturally-defined operations have an entry, under the operation name, in *PMSA System control registers descriptions, in register order* on page B6-1808, that references the appropriate functional description in this section.

This section contains the following subsections:

- [Cache and branch predictor maintenance operations, PMSA](#)
- [Data and instruction barrier operations, PMSA](#) on page B6-1943
- [Cache and TCM lockdown registers, PMSA](#) on page B6-1944
- [DMA support, PMSA](#) on page B6-1945.

### B6.2.1 Cache and branch predictor maintenance operations, PMSA

This section describes the cache and branch predictor maintenance operations. These are:

- 32-bit write-only operations
- can be executed only by software executing at PL1.

[Table B5-18](#) on page B5-1801 shows the encodings for these operations.

For more information about the terms used in this section see [Terms used in describing the maintenance operations](#) on page B2-1274.

#### ———— Note ————

- The architecture includes branch predictor operations with cache maintenance operations because they operate in a similar way.
- ARMv7 introduces significant changes in the CP15 c7 operations. Most of these changes are because ARMv7 introduces support for multiple levels of cache. This section only describes the ARMv7 requirements for these operations. For details of these operations in previous versions of the architecture see:
  - [CP15 c7, Cache and branch predictor operations](#) on page AppxL-2531 for ARMv6
  - [CP15 c7, Cache and branch predictor operations](#) on page AppxO-2628 for ARMv4 and ARMv5.

The Multiprocessing Extensions change the set of caches affected by these operations, see [Scope of cache and branch predictor maintenance operations](#) on page B2-1280.

See [The interaction of cache lockdown with cache maintenance operations](#) on page B2-1287 for information about the interaction of these maintenance operations with cache lockdown.

[Table B6-19](#) lists these operations. For the entries in the table:

- The *Rt data* column specifies what data is required in the register Rt specified by the MCR instruction that performs the operation, see [Data formats for the cache and branch predictor operations](#) on page B6-1942.
- [Terms used in describing the maintenance operations](#) on page B2-1274 describes Address, point of coherency (PoC) and point of unification (PoU).

**Table B6-19 CP15 c7 cache and branch predictor maintenance operations, PMSA**

Operation	Type	Description	Rt data
<a href="#">ICIALUIS</a>	WO	Invalidate all instruction caches to PoU Inner Shareable. If branch predictors are architecturally-visible, also flushes branch predictors. <sup>a</sup>	Ignored
<a href="#">BPIALLIS</a>	WO	Invalidate all entries from branch predictors Inner Shareable.	Ignored
<a href="#">ICIALLU</a>	WO	Invalidate all instruction caches to PoU. If branch predictors are architecturally-visible, also flushes branch predictors. <sup>a</sup>	Ignored

**Table B6-19 CP15 c7 cache and branch predictor maintenance operations, PMSA (continued)**

Operation	Type	Description	Rt data
ICIMVAU	WO	Invalidate instruction cache line by address to PoU. <sup>a, b</sup>	Address
BPIALL	WO	Invalidate all entries from branch predictors.	Ignored
BPIMVA	WO	Invalidate address from branch predictors. <sup>b</sup>	Address
DCIMVAC	WO	Invalidate data or unified cache line by address to PoC. <sup>b</sup>	Address
DCISW	WO	Invalidate data or unified cache line by set/way.	Set/way
DCCMVAC	WO	Clean data or unified cache line by address to PoC. <sup>b</sup>	Address
DCCSW	WO	Clean data or unified cache line by set/way.	Set/way
DCCMVAU	WO	Clean data or unified cache line by address to PoU. <sup>b</sup>	Address
DCCIMVAC	WO	Clean and invalidate data or unified cache line by address to PoC. <sup>b</sup>	Address
DCCISW	WO	Clean and invalidate data or unified cache line by set/way.	Set/way

a. Only applies to separate instruction caches, does not apply to unified caches.

b. In general descriptions of the cache operations, these functions are described as operating *by MVA* (Modified Virtual Address). In a PMSA implementation the MVA and the PA have the same value, and so the functions operate using a physical address in the memory map.

Branch predictor maintenance operations can perform a NOP if the operation of Branch Prediction hardware is not visible architecturally.

### Data formats for the cache and branch predictor operations

Table B6-19 on page B6-1941 shows three possibilities for the data in the register Rt specified by the MCR instruction. These are described in the following subsections:

- *Ignored*
- *Address*
- *Set/way*.

#### **Ignored**

The value in the register specified by the MCR instruction is ignored. Software does not have to write a value to the register before issuing the MCR instruction.

#### **Address**

In general descriptions of the maintenance operations, operations that require a memory address are described as operating *by MVA*. For more information, see [Terms used in describing the maintenance operations on page B2-1274](#). In a PMSA implementation, these operations require the physical address in the memory map. When the data is stated to be an address, it does not have to be cache line aligned.

#### **Set/way**

For a set/way operation, the data identifies the cache line that the operation is to be applied to by specifying:

- the cache set the line belongs to
- the way number of the line in the set
- the cache level.



In ARMv7, ARM deprecates any use of these CP15 c7 operations, and strongly recommends that software uses the ISB, DSB, and DMB instructions instead.

———— **Note** ————

- In ARMv6 and earlier documentation, the Instruction Synchronization Barrier operation is referred to as a Prefetch Flush.
- In versions of the ARM architecture before ARMv6 the Data Synchronization Barrier operation is described as a *Data Write Barrier* (DWB).

If the implementation supports the [SCTLR.CP15BEN](#) bit and this bit is set to 0, these operations are disabled and their encodings are UNDEFINED.

### **CP15ISB, Instruction Synchronization Barrier operation**

In ARMv7, use the ISB instruction to perform an Instruction Synchronization Barrier, see [ISB on page A8-389](#).

The deprecated CP15 c7 encoding for an Instruction Synchronization Barrier is an MCR instruction with <opc1> set to 0, <CRn> set to c7, <CRm> set to c5, and <opc2> set to 4.

### **CP15DSB, Data Synchronization Barrier operation**

In ARMv7, use the DSB instruction to perform a Data Synchronization Barrier, see [DSB on page A8-380](#).

The deprecated CP15 c7 encoding for a Data Synchronization Barrier is an MCR instruction with <opc1> set to 0, <CRn> set to c7, <CRm> set to c10, and <opc2> set to 4. This operation performs the full system barrier performed by the DSB instruction.

### **CP15DMB, Data Memory Barrier operation**

In ARMv7, use the DMB instruction to perform a Data Memory Barrier, see [DMB on page A8-378](#).

The deprecated CP15 c7 encoding for a Data Memory Barrier is an MCR instruction with <opc1> set to 0, <CRn> set to c7, <CRm> set to c10, and <opc2> set to 5. This operation performs the full system barrier performed by the DMB instruction.

## **B6.2.3 Cache and TCM lockdown registers, PMSA**

Some CP15 c9 encodings are reserved for IMPLEMENTATION DEFINED memory system functions, in particular:

- cache control, including lockdown
- TCM control, including lockdown
- branch predictor control.

The reserved encodings support implementations that are compatible with previous versions of the ARM architecture, in particular with the ARMv6 requirements. For details of the ARMv6 implementation see [CP15 c9, Cache lockdown support on page AppxL-2537](#).

In ARMv6, CP15 c9 provides cache lockdown functions. With the ARMv7 abstraction of the hierarchical memory model, for CP15 c9, all encodings with CRm = {c0-c2, c5-c8} are reserved for IMPLEMENTATION DEFINED cache, branch predictor and TCM operations.

The naming and behavior of registers or operations defined in these regions is IMPLEMENTATION DEFINED.

## B6.2.4 DMA support, PMSA

Some CP15 c11 encodings are reserved for IMPLEMENTATION DEFINED registers or operations to provide DMA support. The reserved encodings are those 32-bit CP15 accesses with  $CRn=c11$ ,  $opc1=\{0-7\}$ ,  $CRm=\{c0-c8, c15\}$ ,  $opc2=\{0-7\}$ .

All other CP15 c11 encodings are UNPREDICTABLE, see [Accesses to unallocated CP14 and CP15 encodings on page B5-1774](#).

The reserved encodings permit implementations that are compatible with previous versions of the ARM architecture, in particular with the ARMv6 implementations of DMA support for TCMs described in *The ARM Architecture Reference Manual* (DDI 0100). As stated in [Appendix L ARMv6 Differences](#), ARM considers this support to be an IMPLEMENTATION DEFINED feature of those ARMv6 implementations.

The naming and behavior of registers or operations defined in these encoding regions is IMPLEMENTATION DEFINED.



# Chapter B7

## The CPUID Identification Scheme

This chapter describes the CPUID scheme introduced as a requirement in ARMv7. This scheme provides registers that identify the architecture version and many features of the processor implementation. This chapter also describes the registers that identify the implemented Advanced SIMD and Floating-point Extension features, if any.

This chapter contains the following sections:

- [Introduction to the CPUID scheme on page B7-1948](#)
- [The CPUID registers on page B7-1949](#)
- [Advanced SIMD and Floating-point Extension feature identification registers on page B7-1955.](#)

---

### Note

---

- The other chapters of this manual describe the permitted combinations of architectural features for the ARMv7-A and ARMv7-R architecture profiles, and some of the appendixes give this information for previous versions of the architecture. Typically, permitted features are associated with a named architecture version, or version and profile, such as ARMv7-A or ARMv6.

The CPUID scheme is a mechanism for describing these permitted combinations in a way that software can use to determine the capabilities of the hardware it is running on.

The CPUID scheme does not extend the permitted combinations of architectural features beyond those associated with named architecture versions and profiles. The fact that the CPUID scheme can describe other combinations does not imply that those combinations are permitted ARM architecture variants.

- Both [Chapter B4 System Control Registers in a VMSA implementation](#) and [Chapter B6 System Control Registers in a PMSA implementation](#) include the descriptions of the CPUID registers. These registers are included in both VMSA and PMSA implementations, and the bit assignments are identical in VMSA and PMSA implementations. However, most register references in this chapter link to the register descriptions in [Chapter B4](#).
-

## B7.1 Introduction to the CPUID scheme

In ARM architecture versions before ARMv7, the architecture version is indicated by the Architecture field in the Main ID Register, see either:

- [MIDR, Main ID Register; VMSA on page B4-1648](#)
- [MIDR, Main ID Register; PMSA on page B6-1892](#).

The ARMv7 architecture implements an extended processor identification scheme, using a number of registers in CP15 c0. ARMv7 requires the use of this scheme, and use of the scheme is indicated by a value of 0xF in the Architecture field of the Main ID Register.

———— **Note** —————

Some ARMv6 processors implemented the scheme before its formal adoption in the architecture.

The CPUID scheme provides information about the implemented:

- processor features
- debug features
- auxiliary features, in particular IMPLEMENTATION DEFINED features
- memory model features
- instruction set features.

The following sections give more information about the CPUID registers:

- [Organization of the CPUID registers on page B7-1949](#)
- [General properties of the CPUID registers on page B7-1950](#).

[The CPUID registers on page B7-1949](#) gives detailed descriptions of the registers.

This chapter also describes the identification registers for any Advanced SIMD or Floating-point Extension implementation. These are registers in the shared register space for the Advanced SIMD and Floating-point Extensions, in CP 10 and CP 11. [Advanced SIMD and Floating-point Extension feature identification registers on page B7-1955](#) describes these registers.



## B7.2 The CPUID registers

The CPUID registers consist of:

- Two Processor Feature Registers that give information about the programmers' model and top-level information about the instruction set implementation.
- One Debug Feature Register that gives top level information about the debug system for the processor.
- One Auxiliary Feature Register that gives information about the IMPLEMENTATION DEFINED features of the processor.
- Four Memory Model Feature registers, that give general information about the implemented memory model and memory management support, including the supported cache and TLB operations.
- Six Instruction Set Attribute registers, that give information about the instruction sets implemented by the processor.

### B7.2.1 Organization of the CPUID registers

Figure B7-1 shows the CPUID registers and their encodings in CP15. Two of the encodings shown, with  $\langle CRm \rangle == c2$  and  $\langle opc2 \rangle == \{6, 7\}$ , are reserved for future expansion of the CPUID scheme. In addition, all CP15  $c0$  encodings with  $\langle CRm \rangle == \{c3-c7\}$  and  $\langle opc2 \rangle == \{0-7\}$  are reserved for future expansion of the scheme. These reserved encodings must be RAZ.

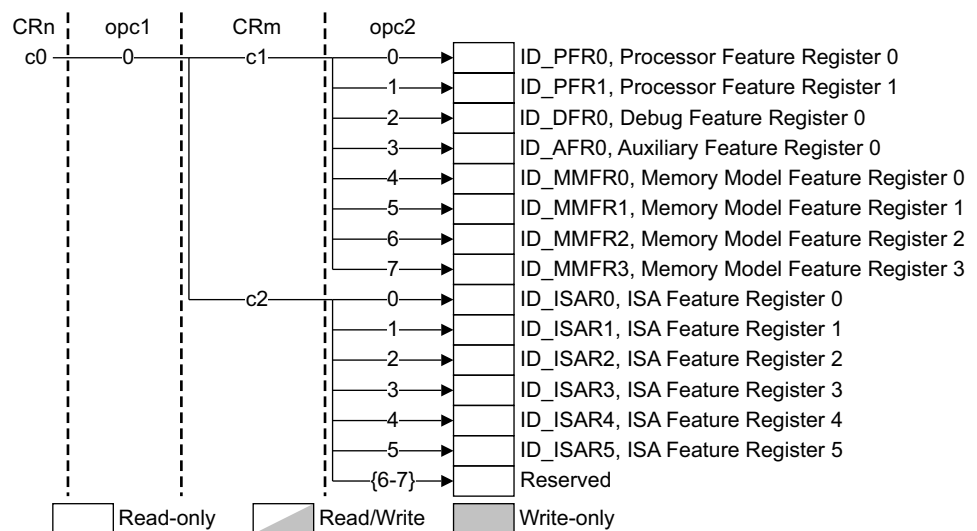

Figure B7-1 CPUID register encodings

Table B7-1 lists the CPUID registers and shows where each register is described in full

**Table B7-1 CPUID register summary**

Name, VMSA <sup>a</sup>	Name, PMSA <sup>a</sup>	opc1	CRm	opc2	Type	Description
ID_PFR0	ID_PFR0	0	c1	0	RO	Processor Feature Register 0
ID_PFR1	ID_PFR1			1	RO	Processor Feature Register 1
ID_DFR0	ID_DFR0			2	RO	Debug Feature Register 0
ID_AFR0	ID_AFR0			3	RO	Auxiliary Feature Register 0
ID_MMFR0	ID_MMFR0			4	RO	Memory Model Feature Register 0
ID_MMFR1	ID_MMFR1			5	RO	Memory Model Feature Register 1
ID_MMFR2	ID_MMFR2			6	RO	Memory Model Feature Register 2
ID_MMFR3	ID_MMFR3			7	RO	Memory Model Feature Register 3
ID_ISAR0	ID_ISAR0		c2	0	RO	Instruction Set Attribute Register 0
ID_ISAR1	ID_ISAR1			1	RO	Instruction Set Attribute Register 1
ID_ISAR2	ID_ISAR2			2	RO	Instruction Set Attribute Register 2
ID_ISAR3	ID_ISAR3			3	RO	Instruction Set Attribute Register 3
ID_ISAR4	ID_ISAR4			4	RO	Instruction Set Attribute Register 4
ID_ISAR5	ID_ISAR5			5	RO	Instruction Set Attribute Register 5
-	-			{6-7}	-	Reserved

a. VMSA and PMSA definitions of the register fields are identical. These columns link to the descriptions in [Chapter B4](#) and [Chapter B6](#).

### General properties of the CPUID registers

All of the CPUID registers are 32-bit read-only registers. Each register is divided into eight 4-bit fields, and the possible field values are defined individually for each field. Some registers do not use all of these fields.

#### B7.2.2 About the Instruction Set Attribute registers

The Instruction Set Attribute registers, ID\_ISAR0 to ID\_ISAR5, provide information about the instruction sets implemented by the processor. The instruction set is divided into:

- The basic instructions, for the ARM, Thumb, and ThumbEE instruction sets. If ID\_PFR0 indicates that an instruction set is implemented, then all basic instructions that have encodings in that instruction set must be implemented.
- The non-basic instructions. The Instruction Set Attribute registers indicate which of these instructions are implemented.

[Instruction set descriptions in the CPUID scheme on page B7-1951](#) describes the division of the instruction set into basic and non-basic instructions.

[Summary of Instruction Set Attribute register attribute fields on page B7-1952](#) lists all of the attributes and shows which register holds each attribute.

## Instruction set descriptions in the CPUID scheme

The following subsections describe how the CPUID scheme describes the instruction set, and how instructions are classified as either basic or non-basic:

- [General rules for instruction classification](#)
- [Data-processing instructions](#)
- [Multiply instructions](#)
- [Branches](#)
- [Load or Store single word instructions on page B7-1952](#)
- [Load or Store multiple word instructions on page B7-1952](#)
- [Q flag support in the PSRs on page B7-1952.](#)

### General rules for instruction classification

Two general rules apply to the description of instruction classification given in this section:

1. The rules about an instruction being basic do not guarantee that it is available in any particular instruction set. For example, the rules given in this section classify `MOV R0, #123456789` as a basic instruction, but this instruction is not available in any existing ARM instruction set.
2. Whether an instruction is conditional or unconditional never makes any difference to whether it is a basic instruction.

### Data-processing instructions

The data-processing instructions are:

ADC	ADD	AND	ASR	BIC	CMN	CMP	EOR	LSL	LSR	MOV	MVN
NEG	ORN	ORR	ROR	RRX	RSB	RSC	SBC	SUB	TEQ	TST	

An instruction from this group is a basic instruction if these conditions both apply:

- The second source operand, or the only source operand of a `MOV` or `MVN` instruction, is an immediate or an unshifted register.

———— **Note** —————

A `MOV` instruction with a shifted register source operand must be treated as the equivalent `ASR`, `LSL`, `LSR`, `ROR`, or `RRX` instruction, see [MOV \(shifted register\) on page A8-490](#).

- The instruction is not one of the exception return instructions described in [SUBS PC, LR \(Thumb\) on page B9-2008](#) and [SUBS PC, LR and related instructions \(ARM\) on page B9-2010](#).

If either of these conditions does not apply then the instruction is a non-basic instruction. The [ID\\_ISAR2.PSR\\_AR\\_instrs](#) and [ID\\_ISAR4.WithShifts\\_instrs](#) attributes show the implemented non-basic data-processing instructions.

### Multiply instructions

The classification of multiply instructions is:

- `MUL` instructions are always basic instructions
- all other multiply instructions, and all multiply accumulate instructions, are non-basic instructions.

### Branches

All `B` and `BL` instructions are basic instructions.

### Load or Store single word instructions

The instructions in this group are:

LDR LDRB LDRH LDRSB LDRSH STR STRB STRH

An instruction in this group is a basic instruction if its addressing mode is one of these forms:

- [Rn, #immediate]
- [Rn, #-immediate]
- [Rn, Rm]
- [Rn, -Rm].

A Load or Store single word instruction with any other addressing mode is a non-basic instruction. The [ID\\_ISAR4](#).{WithShifts\_instrs, Writeback\_instrs, Unpriv\_instrs} attributes show the support for these non-basic addressing modes.

### Load or Store multiple word instructions

The Load or Store multiple word instructions are:

LDM<mode> STM<mode> PUSH POP

A limited number of variants of these instructions are non-basic. The [ID\\_ISAR1](#).Except\_instrs attribute shows whether these instructions are implemented. For more information about these non-basic instructions see the [ID\\_ISAR1](#) field description.

All other forms of these instructions are always basic instructions.

### Q flag support in the PSRs

The Q flag is present in the [CPSR](#) and [SPSRs](#) when one or more of these conditions applies:

- [ID\\_ISAR2](#).MultS\_instrs  $\geq 2$
- [ID\\_ISAR3](#).Saturate\_instrs  $\geq 1$
- [ID\\_ISAR3](#).SIMD\_instrs  $\geq 1$ .

### Summary of Instruction Set Attribute register attribute fields

The Instruction Set Attribute registers use a set of attributes to indicate the non-basic instructions implemented by the processor. The descriptions of the non-basic instructions in [Instruction set descriptions in the CPUID scheme on page B7-1951](#) include the attribute or attributes that indicate support for each category of non-basic instructions. [Table B7-2](#) lists all of the attributes in alphabetical order, and shows which Instruction Set Attribute register holds each attribute, by links to the register descriptions in [Chapter B4 System Control Registers in a VMSA implementation](#) and [Chapter B6 System Control Registers in a PMSA implementation](#).

#### ————— Note —————

The register definitions are identical in the VMSA and PMSA chapters. However, some register field descriptions include Notes on constraints that apply to the corresponding memory system.

**Table B7-2** Alphabetic list of Instruction Set Attribute registers attribute fields

Attribute field	Register, VMSA	Register, PMSA
Barrier_instrs	<a href="#">ID_ISAR4</a>	<a href="#">ID_ISAR4</a>
BitCount_instrs	<a href="#">ID_ISAR0</a>	<a href="#">ID_ISAR0</a>
Bitfield_instrs	<a href="#">ID_ISAR0</a>	<a href="#">ID_ISAR0</a>
CmpBranch_instrs	<a href="#">ID_ISAR0</a>	<a href="#">ID_ISAR0</a>

**Table B7-2 Alphabetic list of Instruction Set Attribute registers attribute fields (continued)**

<b>Attribute field</b>	<b>Register, VMSA</b>	<b>Register, PMSA</b>
Coproc_instrs	ID_ISAR0	ID_ISAR0
Debug_instrs	ID_ISAR0	ID_ISAR0
Divide_instrs	ID_ISAR0	ID_ISAR0
Endian_instrs	ID_ISAR1	ID_ISAR1
Except_AR_instrs	ID_ISAR1	ID_ISAR1
Except_instrs	ID_ISAR1	ID_ISAR1
Extend_instrs	ID_ISAR1	ID_ISAR1
IfThen_instrs	ID_ISAR1	ID_ISAR1
Immediate_instrs	ID_ISAR1	ID_ISAR1
Interwork_instrs	ID_ISAR1	ID_ISAR1
Jazelle_instrs	ID_ISAR1	ID_ISAR1
LoadStore_instrs	ID_ISAR2	ID_ISAR2
MemHint_instrs	ID_ISAR2	ID_ISAR2
Mult_instrs	ID_ISAR2	ID_ISAR2
MultiAccessInt_instrs	ID_ISAR2	ID_ISAR2
MultS_instrs	ID_ISAR2	ID_ISAR2
MultU_instrs	ID_ISAR2	ID_ISAR2
PSR_AR_instrs	ID_ISAR2	ID_ISAR2
PSR_M_instrs	ID_ISAR4	ID_ISAR4
Reversal_instrs	ID_ISAR2	ID_ISAR2
Saturate_instrs	ID_ISAR3	ID_ISAR3
SIMD_instrs	ID_ISAR3	ID_ISAR3
SMC_instrs	ID_ISAR4	ID_ISAR4
SWP_frac	ID_ISAR4	ID_ISAR4
SVC_instrs	ID_ISAR3	ID_ISAR3
Swap_instrs	ID_ISAR0	ID_ISAR0
SynchPrim_instrs	ID_ISAR3	ID_ISAR3
SynchPrim_instrs_frac	ID_ISAR4	ID_ISAR4
TabBranch_instrs	ID_ISAR3	ID_ISAR3
ThumbCopy_instrs	ID_ISAR3	ID_ISAR3
ThumbEE_extn_instrs	ID_ISAR3	ID_ISAR3
TrueNOP_instrs	ID_ISAR3	ID_ISAR3

**Table B7-2 Alphabetic list of Instruction Set Attribute registers attribute fields (continued)**

<b>Attribute field</b>	<b>Register, VMSA</b>	<b>Register, PMSA</b>
Unpriv_instrs	ID_ISAR4	ID_ISAR4
WithShifts_instrs	ID_ISAR4	ID_ISAR4
Writeback_instrs	ID_ISAR4	ID_ISAR4

## B7.3 Advanced SIMD and Floating-point Extension feature identification registers

In the ARMv7-A and ARMv7-R architecture profiles, when an implementation includes one or both of the OPTIONAL Advanced SIMD and Floating-point Extensions, the feature identification registers for the extensions are implemented in a common register block with the Advanced SIMD and Floating-point Extension system registers. The Advanced SIMD and Floating-point Extensions are implemented using coprocessors CP10 and CP11, and software uses the coprocessor instructions VMRS and VMSR instructions to access the registers. For more information, see [Advanced SIMD and Floating-point Extension system registers on page B1-1235](#).

### B7.3.1 About the Media and VFP Feature registers

The Media and VFP Feature registers describe the features provided by the Advanced SIMD and Floating-point Extensions, when an implementation includes either or both of these extensions. For details of the implementation options for these extensions see [Advanced SIMD and Floating-point Extensions on page A2-54](#).

In VFPv2, it is IMPLEMENTATION DEFINED whether the Media and VFP Feature registers are implemented.

———— **Note** —————

Often, the complete implementation of a Floating-point (VFP) architecture uses support code to provide some floating-point functionality. In such an implementation, only the support code can provide full details of the supported features. In this case the Media and VFP Feature registers are not used directly.

—————





# Chapter B8

## The Generic Timer

This chapter describes the implementation of the ARM Generic Timer as an OPTIONAL extension to an ARMv7-A or ARMv7-R processor implementation. It includes the definition of the system control register interface to an ARM Generic Timer.

It contains the following sections:

- [About the Generic Timer](#) on page B8-1958
- [Generic Timer registers summary](#) on page B8-1967.

[Appendix E System Level Implementation of the Generic Timer](#) describes the system level implementation of the Generic Timer.

———— **Note** —————

Both [Chapter B4 System Control Registers in a VMSA implementation](#) and [Chapter B6 System Control Registers in a PMSA implementation](#) include the descriptions of the Generic Timer CP15 registers. Most of the registers are included in both VMSA and PMSA implementations, and for these registers the bit assignments are identical in VMSA and PMSA implementations. However, most register references in this chapter link to the register descriptions in [Chapter B4](#).

---

## B8.1 About the Generic Timer

Figure B8-1 shows an example system-on-chip that uses the Generic Timer as a system timer. In this figure:

- This manual defines the architecture of the individual processors in the multiprocessor blocks.
- The *ARM Generic Interrupt Controller Architecture Specification* defines a possible architecture for the GICs.
- Generic Timer functionality is distributed across multiple components.

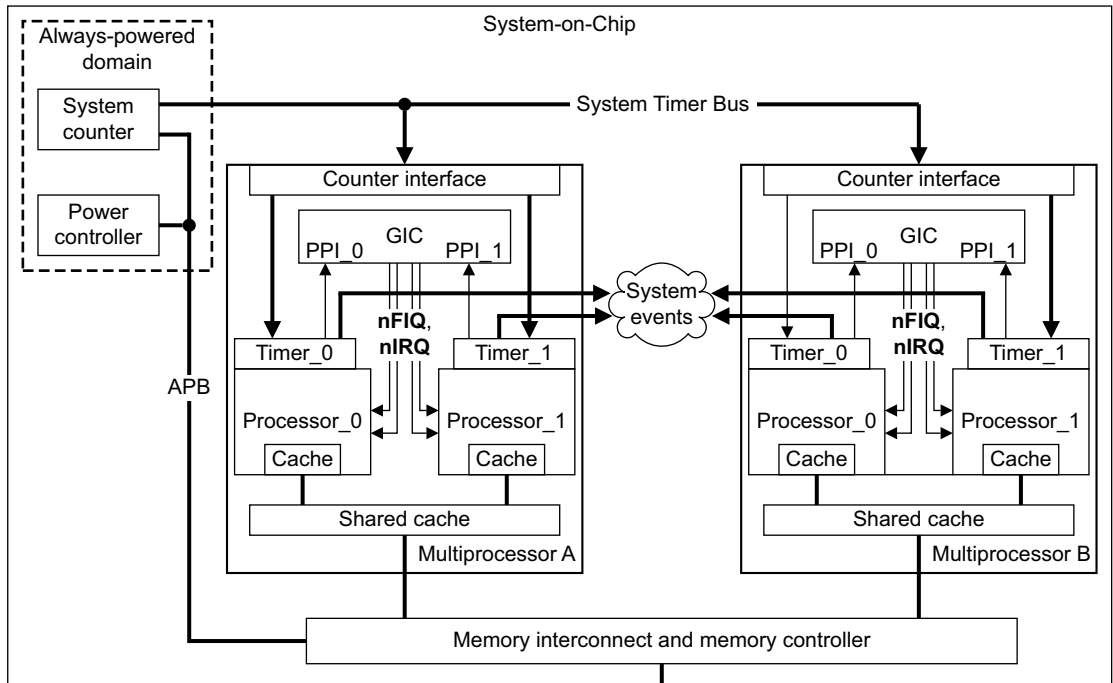

Figure B8-1 Generic Timer example

This chapter:

- Gives a general description of the Generic Timer.
- Defines the system control register interface to the Generic Timer. Each processor shown in Figure B8-1 includes an implementation of this interface.

The Generic Timer:

- Provides a system counter, that measures the passing of time in real-time.
- In a system that includes support for virtualization, support *virtual counters* that measure the passing of virtual time. That is, a virtual counter can measure the passing of time on a particular virtual machine.
- Provides timers, that can assert a timer output signal after a period of time has passed. The timers:
  - Can be used as count-up or as count-down timers.
  - In a component that supports virtualization, can operate in real-time or in virtual-time.

———— **Note** ————

A timer output signal can be used as a level-sensitive interrupt signal.

## B8.1.1 System counter

The Generic Timer provides a system counter with the following specification:

<b>Width</b>	At least 56 bits wide. The value returned by any 64-bit read of the counter is zero-extended to 64 bits.
<b>Frequency</b>	Increments at a fixed frequency, typically in the range 1-50MHz. Can support one or more alternative operating modes in which it increments by larger amounts at a lower frequency, typically for power-saving.
<b>Roll-over</b>	Roll-over time of not less than 40 years.
<b>Accuracy</b>	ARM does not specify a required accuracy, but recommends that the counter does not gain or lose more than ten seconds in a 24-hour period. Use of lower-frequency modes must not affect the implemented accuracy.
<b>Start-up</b>	Starts operating from zero.

The system counter must provide a uniform view of system time. More precisely, it must be impossible for the following sequence of events to show system time going backwards:

1. Device A reads the time from the system counter.
2. Device A communicates with another agent in the system, Device B.
3. After recognizing the communication from Device A, Device B reads the time from the system counter.

The system counter must be implemented in an always-on power domain.

To support lower-power operating modes, the counter can increment by larger amounts at a lower frequency. For example, a 10MHz system counter might either increment either:

- By 1 at 10MHz.
- By 500 at 20KHz, when the system lowers the clock frequency, to reduce power consumption.

In this case, the counter must support transitions between high-frequency, high-precision operation, and lower-frequency, lower-precision operation, without any impact on the required accuracy of the counter.

Software can access the [CNTFRQ](#) register to read the clock frequency of the system counter, and software with sufficient privilege can modify the value of this register. For more information, see [Initializing and reading the system counter frequency](#).

The mechanism by which the count from the system counter is distributed to system components is IMPLEMENTATION DEFINED, but each processor with a system control register interface to the system counter must include a counter input that can capture each increment of the counter.

### ———— Note —————

So that the system counter can be clocked independently from the processor, the count value might be distributed using a Gray code sequence. [Gray-count scheme for timer distribution scheme on page AppxE-2425](#) gives more information about this possibility.

## Initializing and reading the system counter frequency

Typically, the system drives the system counter at a fixed frequency and the [CNTFRQ](#) register must be programmed to this value during the system boot process. In an implementation that supports the ARM Security Extensions, only software executing in a Secure PL1 mode can write to [CNTFRQ](#). If a system permits any configuration of the system counter frequency then it must ensure that [CNTFRQ](#) is always programmed to the correct system counter frequency.

### ———— Note —————

The [CNTFRQ](#) register is UNKNOWN at reset, and therefore the counter frequency must be written to [CNTFRQ](#) as part of the system boot process.

Software can read the [CNTFRQ](#) register, to determine the current system counter frequency, in the following states and modes:

- Non-secure PL2 mode.
- Secure and Non-secure PL1 modes.
- When [CNTKCTL.PL0PCTEN](#) is set to 1, Secure and Non-secure PL0 modes.

### Memory-mapped controls of the system counter

Some system counter controls are accessible only through the memory-mapped interface to the system counter. These controls are:

- Enabling and disabling the counter.
- Setting the counter value.
- Changing the operating mode, to change the update frequency and increment value.
- Enabling Halt-on-debug, that a debugger can then use to suspend counting.

For descriptions of these controls, see [Appendix E System Level Implementation of the Generic Timer](#).

## B8.1.2 The physical counter

The processor provides a physical counter that contains the count value of the system counter. The [CNTPCT](#) register holds the current physical counter value.

### Accessing the physical counter

Software with sufficient privilege can read [CNTPCT](#) using a 64-bit system control register read.

In an implementation that does not include the Virtualization Extensions, [CNTPCT](#) is always accessible from PL1 modes, regardless of the security state.

In an implementation that includes the Virtualization Extensions, [CNTPCT](#):

- Is always accessible from Secure PL1 modes, and from Non-secure Hyp mode.
- Is accessible from Non-secure PL1 modes only when [CNTHCTL.PL1PCTEN](#) is set to 1. When [CNTHCTL.PL1PCTEN](#) is set to 0, any attempt to access [CNTPCT](#) from a Non-secure PL1 mode generates a Hyp Trap exception, see [Hyp Trap exception on page B1-1208](#).

In addition, when [CNTKCTL.PL0PCTEN](#) is set to 1, if [CNTPCT](#) is accessible from PL1 modes in the current security state then it is also accessible from PL0 mode in that security state.

When [CNTKCTL.PL0PCTEN](#) is set to 0, any attempt to access [CNTPCT](#) from a PL0 mode generates an Undefined Instruction exception.

In an implementation that includes the Virtualization Extensions:

- The [CNTKCTL](#) control has priority over the [CNTHCTL](#) control. When both of the following apply, this means that an attempt to access [CNTPCT](#) from the Non-secure PL0 mode generates an Undefined Instruction exception:
  - [CNTHCTL.PL1PCTEN](#) is set to 0, to disable accesses from Non-secure PL1 modes
  - [CNTKCTL.PL0PCTEN](#) is set to 0, to disable accesses from PL0 modes.
- When PL0 accesses are enabled, the [CNTHCTL](#) applies to Non-secure PL0 accesses. When both of the following apply, this means that an attempt to access [CNTPCT](#) from the Non-secure PL0 mode generates a Hyp Trap exception:
  - [CNTHCTL.PL1PCTEN](#) is set to 0, to disable accesses from Non-secure PL1 modes
  - [CNTKCTL.PL0PCTEN](#) is set to 1, to enable accesses from PL0 modes.

Reads of [CNTPCT](#) can occur speculatively and out of order relative to other instructions executed on the same processor. For example, if a read from memory is used to obtain a signal from another agent that indicates that [CNTPCT](#) must be read, an ISB must be used to ensure that the read of [CNTPCT](#) occurs after the signal has been read from memory, as shown in the following code sequence:

```

loop      ; polling for some communication to indicate a requirement to read the timer
LDR R1, [R2]
CMP R1, #1
BNE loop
ISB      ; without this, CNTPCT might be read before the memory location in [R2]
         ; has had the value 1 written to it
MRRC p15, 0, R1, R2, c14 ; Read 64-bit CNTPCT into R1 (low word) and R2 (high word)

```

### B8.1.3 The virtual counter

An implementation of the Generic Timer always includes a virtual counter, that indicates virtual time:

- In a processor implementation that does not include the Virtualization Extensions, virtual time is identical to physical time, and the virtual counter contains the same value as the physical counter.
- In a processor implementation that includes the Virtualization Extensions, the virtual counter contains the value of the physical counter minus a 64-bit virtual offset. When executing in a Non-secure PL1 or PL0 mode, the virtual offset value relates to the current virtual machine.

In a processor implementation that includes the Virtualization Extensions, the `CNTVOFF` register contains the virtual offset. `CNTVOFF` is only accessible from Hyp mode, or from Monitor mode when `SCR.NS` is set to 1.

#### ———— Note ————

All implementations of the Generic Timer include the virtual counter. However, only a system that supports virtualization provides a clear distinction between physical time and virtual time, and:

- In a system that supports virtualization, `CNTVOFF` is implemented as a RW register.
- In a system that does not support virtualization:
  - If the system includes the Security Extensions, accesses to `CNTVOFF` from Secure Monitor mode are UNPREDICTABLE.
  - The virtual counter behaves as if `CNTVOFF` is zero.

See *Status of the CNTVOFF register* on page B8-1968 for more information.

The `CNTVCT` register holds the current virtual counter value.

### Accessing the virtual counter

Software with sufficient privilege can read `CNTVCT` using a 64-bit system control register read.

`CNTVCT` is always accessible from Secure PL1 modes, and from Non-secure PL1 and PL2 modes.

In addition, when `CNTKCTL.PL0VCTEN` is set to 1, `CNTVCT` is accessible from PL0 modes.

When `CNTKCTL.PL0VCTEN` is set to 0, any attempt to access `CNTVCT` from a PL0 mode generates an Undefined Instruction exception.

Reads of `CNTVCT` can occur speculatively and out of order relative to other instructions executed on the same processor. For example, if a read from memory is used to obtain a signal from another agent that indicates that `CNTVCT` must be read, an ISB must be used to ensure that the read of `CNTVCT` occurs after the signal has been read from memory, as shown in the following code sequence:

```

loop      ; polling for some communication to indicate a requirement to read the timer
LDR R1, [R2]
CMP R1, #1
BNE loop
ISB      ; without this, CNTVCT might be read before the memory location in [R2]
         ; has had the value 1 written to it
MRRC p15, 1, R1, R2, c14 ; Read 64-bit CNTVCT into R1 (low word) and R2 (high word)

```

## B8.1.4 Event streams

An implementation that includes the Generic Timer can use the system counter to generate one or more *event streams*, to generate periodic wake-up events as part of the mechanism described in [Wait For Event and Send Event](#) on page B1-1199.

———— **Note** —————

An event stream might be used:

- To impose a time-out on a Wait For Event polling loop.
- To safeguard against any programming error that means an expected event is not generated.

An event stream is configured by:

- Selecting which bit, from the bottom 16 bits of a counter, generates the event. This determines the frequency of the events in the stream.
- Selecting whether the event is generated on each 0 to 1 transition, or each 1 to 0 transition, of the selected counter bit.

The `CNTKCTL`.{EVNTEN, EVNTDIR, EVNTI} fields define an event stream that is generated from the virtual counter.

In an implementation that includes the Virtualization Extensions, the `CNTHCTL`.{EVNTEN, EVNTDIR, EVNTI} fields define an event stream that is generated from the physical counter.

The operation of an event stream is as follows:

- The pseudocode variables `PreviousCNTVCT` and `PreviousCNTPCT` are initialized as:  

```
// Variables used for generation of the timer event stream.  
bits(64) PreviousCNTVCT = bits(64) UNKNOWN;  
bits(64) PreviousCNTPCT = bits(64) UNKNOWN;
```
- The pseudocode functions `TestEventCNTV()` and `TestEventCNTP()` are called on each cycle of the processor clock.
- The `TestEventCNTx()` pseudocode template defines the functions `TestEventCNTV()` and `TestEventCNTP()`:

```
// TestEventCNTx()  
// =====  
  
// Template for the TestEventCNTV() and TestEventCNTP() functions:  
// CNTxCT      is CNTVCT      or CNTPCT      64-bit count value  
// CNTxCTL     is CNTVCTL     or CNTPCTL     Control register  
// PreviousCNTxCT is PreviousCNTVCT or PreviousCNTPCT  
  
TestEventCNTx()  
  if CNTxCTL.EVNTEN == '1' then  
    n = UInt(CNTxCTL.EVNTI);  
    SampleBit = CNTxCT<n>;  
    PreviousBit = PreviousCNTxCT<n>;  
  
    if CNTxCTL.EVNTDIR == '0' then  
      if PreviousBit == '0' && SampleBit == '1' then SendEvent();  
    else  
      if PreviousBit == '1' && SampleBit == '0' then SendEvent();  
  
  PreviousCNTxCT = CNTxCT;  
  
  return;
```

## B8.1.5 Timers

The number of timers provided by an implementation of the Generic Timer depends on whether the implementation includes the Security Extensions and the Virtualization Extensions, as follows:

### Security Extensions not implemented

The implementation provides a physical timer and a virtual timer.

### Security Extensions implemented, Virtualization Extensions not implemented

The implementation provides:

- A Non-secure physical timer.
- A Secure physical timer.
- A virtual timer.

### Virtualization Extensions implemented

The implementation provides:

- A Non-secure PL1 physical timer.
- A Secure PL1 physical timer.
- A Non-secure PL2 physical timer.
- A virtual timer.

The output of each implemented timer:

- Provides an output signal to the system.
- If the processor interfaces to a *Generic Interrupt Controller (GIC)*, signals a *Private Peripheral Interrupt (PPI)* to that GIC. In a multiprocessor implementation, each processor must use the same interrupt number for each timer.

Each timer is implemented as three registers:

- A 64-bit CompareValue register, that provides a 64-bit unsigned upcounter.
- A 32-bit TimerValue register, that provides a 32-bit signed downcounter.
- A 32-bit Control register.

In a processor implementation that includes the Security Extensions, the registers for the PL1 physical timer are Banked, to provide the Secure and Non-secure implementations of the timer. [Table B8-1](#) shows the Timer registers.

**Table B8-1 Timer registers summary for the Generic Timer**

	PL1 physical timer <sup>a</sup>	PL2 physical timer <sup>b</sup>	Virtual timer
CompareValue register	CNTP_CVAL	CNTHP_CVAL	CNTV_CVAL
TimerValue register	CNTP_TVAL	CNTHP_TVAL	CNTV_TVAL
Control register	CNTP_CTL	CNTHP_CTL	CNTV_CTL

a. Registers are Banked in a processor implementation that includes the Security Extensions.

b. Implemented only in a processor implementation that includes the Virtualization Extensions.

[Table B8-2 on page B8-1967](#) includes references to the descriptions of these registers.

The following sections describe the operation of the timers:

- [Accessing the timer registers on page B8-1964.](#)
- [Operation of the CompareValue views of the timers on page B8-1964.](#)
- [Operation of the TimerValue views of the timers on page B8-1965.](#)
- [Operation of the timer output signal on page B8-1966.](#)

## Accessing the timer registers

For each timer, all timer registers have the same access permissions, as follows:

**PL1 physical timer** Accessible from PL1 modes, except that if the implementation includes the Virtualization Extensions, Non-secure software executing at PL2 controls access from Non-secure PL1 modes.

When access from PL1 modes is permitted, `CNTKCTL.PLOPTEN` determines whether the registers are accessible from PL0 modes. If an access is not permitted because `CNTKCTL.PLOPTEN` is set to 0, an attempted access from a PL0 mode generates an Undefined Instruction exception.

If the implementation includes the Security Extensions:

- Except for accesses from Monitor mode, accesses are to the registers for the current security state.
- For accesses from Monitor mode, the value of `SCR.NS` determines whether accesses are to the Secure or the Non-secure registers.

If the implementation includes the Virtualization Extensions:

- The Non-secure registers are accessible from Hyp mode.
- `CNTHCTL.NSPLITPEN` determines whether the Non-secure registers are accessible from Non-secure PL1 modes. If this bit is set to 1, to enable access from Non-secure PL1 modes, `CNTKCTL.PLOPTEN` determines whether the registers are accessible from Non-secure PL0 modes.

If an access is not permitted because `CNTHCTL.NSPLITPEN` is set to 0, an attempted access from a Non-secure PL1 or PL0 mode generates a Hyp Trap exception. However, if `CNTKCTL.PLOPTEN` is set to 0, this control takes priority, and an attempted access from PL0 generates an Undefined Instruction exception.

**Virtual timer** Accessible from Secure and Non-secure PL1 modes, and from Hyp mode. `CNTKCTL.PLOVTEN` determines whether the registers are accessible from PL0 modes. If an access is not permitted because `CNTKCTL.PLOVTEN` is set to 0, an attempted access from a PL0 mode generates an Undefined Instruction exception.

**PL2 physical timer** Accessible from Non-secure Hyp mode, and from Secure Monitor mode when `SCR.NS` is set to 1.

## Operation of the CompareValue views of the timers

The CompareValue view of a timer operates as a 64-bit upcounter. The timer condition is met when the appropriate counter reaches the value programmed into a CompareValue register. When the timer condition is met, the timer output signal is asserted only if the timer is enabled and the signal is not masked in the corresponding timer control register, `CNTP_CTL`, `CNTHP_CTL`, or `CNTV_CTL`.

### ————— Note —————

- The timer output signal can be used as a level-sensitive interrupt signal.
- In the pseudocode description of the operation of the CompareValue view, `EventTriggered` indicates whether the timer condition is met. It does not indicate whether the timer output signal is asserted.

The operation of this view of a timer is:

$$\text{EventTriggered} = (((\text{Counter}[63:0] - \text{Offset}[63:0])[63:0] - \text{CompareValue}[63:0]) \geq 0)$$

Where:

`EventTriggered` Is TRUE if the condition for this timer is met, and FALSE otherwise.



Counter The physical counter value, that can be read from the [CNTPCT](#) register.

———— **Note** —————

The virtual counter value, that can be read from the [CNTVCT](#) register, is the value:  
(Counter - Offset)

Offset For a physical timer, and for the virtual timer in an implementation that does not include the Virtualization Extensions, Offset is zero. For the virtual timer in an implementation that includes the Virtualization Extensions, Offset is the virtual offset, held in the [CNTVOFF](#) register.

CompareValue The value of the appropriate CompareValue register, [CNTP\\_CVAL](#), [CNTHP\\_CVAL](#), or [CNTV\\_CVAL](#).

In this view of a timer, Counter, Offset, and CompareValue are all 64-bit unsigned values.

———— **Note** —————

This means that the timer condition for a timer with a CompareValue of, or close to, 0xFFFFFFFFFFFFFFFF might never be met. However, there is no practical requirement to use values close to the counter wrap value.

### Operation of the TimerValue views of the timers

The TimerValue view of a timer operates as a signed 32-bit downcounter. A TimerValue register is programmed with a count value. This value decrements on each increment of the appropriate counter, and the timer condition is met when the value reaches zero. When the timer condition is met, the timer output signal is asserted only if the timer is enabled and the signal is not masked in the corresponding timer control register, [CNTP\\_CTL](#), [CNTHP\\_CTL](#), or [CNTV\\_CTL](#).

———— **Note** —————

- The timer output signal can be used as a level-sensitive interrupt signal.
- In the pseudocode description of the operation of the CompareValue view, EventTriggered indicates whether the timer condition is met. It does not indicate whether the timer output signal is asserted.

This view of a timer depends on the following behavior of accesses to TimerValue registers:

**Reads** TimerValue = (CompareValue - (Counter - Offset))[31:0]

**Writes** CompareValue = ((Counter - Offset)[63:0] + SignExtend(TimerValue))[63:0]

Where the arguments have the definitions used in [Operation of the CompareValue views of the timers on page B8-1964](#), and in addition:

TimerValue The value of a TimerValue register, [CNTP\\_TVAL](#), [CNTHP\\_TVAL](#), or [CNTV\\_TVAL](#).

The operation of this view of a timer is, effectively:

$$\text{EventTriggered} = (\text{TimerValue} \leq 0)$$

In this view of a timer, all values are signed, in standard two's complement form.

After the timer condition is met, a read of a TimerValue register indicates the time since the condition was met.

———— **Note** —————

Programming TimerValue to a negative number with magnitude greater than (Counter-Offset) can lead to an arithmetic overflow that causes the CompareValue to be an extremely large positive value. This potentially means the timer condition is not met for an extremely long period of time.

## Operation of the timer output signal

The timer output signal is asserted whenever all of the following conditions are met:

- At least one of the timer conditions is met, see *Operation of the CompareValue views of the timers* on page B8-1964 and *Operation of the TimerValue views of the timers* on page B8-1965.
- In the timer control register `CNTP_CTL`, `CNTHP_CTL`, or `CNTV_CTL`:
  - The timer is enabled.
  - The timer output signal is not masked.

This means that, to deassert the timer output signal, software must do one of the following:

- Reprogram the timer registers so that neither of the timer conditions is met.
- Mask the timer output signal, in the timer control register.
- Disable the timer, in the timer control register.

## B8.2 Generic Timer registers summary

Table B8-2 shows the CP15 registers in an implementation that includes the Generic Timer Extension. The set of registers implemented depends on whether the implementation also includes the Virtualization Extensions.

**Table B8-2 Generic Timer registers**

Name, VMSA <sup>a</sup>	Name, PMSA <sup>a</sup>	CRn	opc1	CRm	opc2	Width	Type	Description
CNTRQ	CNTRQ	c14	0	c0	0	32-bit	RW	Counter Frequency register
CNTPCT	CNTPCT	-	0	c14	-	64-bit	RO	Physical Count register
CNTKCTL	CNTKCTL	c14	0	c1	0	32-bit	RW	Timer PL1 Control register
CNTP_TVAL	CNTP_TVAL			c2	0	32-bit	RW	PL1 Physical TimerValue register
CNTP_CTL	CNTP_CTL				1	32-bit	RW	PL1 Physical Timer Control register
CNTV_TVAL	CNTV_TVAL			c3	0	32-bit	RW	Virtual TimerValue register
CNTV_CTL	CNTV_CTL				1	32-bit	RW	Virtual Timer Control register
CNTVCT	CNTVCT	-	1	c14	-	64-bit	RO	Virtual Count register
CNTP_CVAL	CNTP_CVAL		2			64-bit	RW	PL1 Physical Timer CompareValue register
CNTV_CVAL	CNTV_CVAL		3			64-bit	RW	Virtual Timer CompareValue register
CNTVOFF <sup>b</sup>	._b		4			64-bit	RW <sup>b</sup>	Virtual Offset register
CNTHCTL <sup>c</sup>	._c	c14	4	c1	0	32-bit	RW	Timer PL2 Control register
CNTHP_TVAL <sup>c</sup>	._c			c2	0	32-bit	RW	PL2 Physical TimerValue register
CNTHP_CTL <sup>c</sup>	._c				1	32-bit	RW	PL2 Physical Timer Control register
CNTHP_CVAL <sup>c</sup>	._c	-	6	c14	-	64-bit	RW	PL2 Physical Timer CompareValue register

- For registers that are included in a PMSA implementation, the VMSA and PMSA definitions of the register fields are identical. These columns link to the descriptions in [Chapter B4](#) and [Chapter B6](#).
- Implemented as a RW register only as part of the Virtualization Extensions. For more information, see [Status of the CNTVOFF register on page B8-1968](#).
- Implemented only as part of the Virtualization Extensions. Otherwise, encoding is unallocated and UNDEFINED, see [Accesses to unallocated CP14 and CP15 encodings on page B3-1447](#) or [Accesses to unallocated CP14 and CP15 encodings on page B5-1774](#). This means the encoding is unallocated and UNDEFINED in a PMSA implementation.

### B8.2.1 Status of the CNTVOFF register

All implementations of the Generic Timers Extension include the virtual counter. Therefore, conceptually, all implementations include the **CNTVOFF** register that defines the *virtual offset* between the physical count and the virtual count. In an implementation that does not support virtualization, this offset is zero. **CNTVOFF** is defined as a PL2-mode register, see [Banked PL2-mode CP15 read/write registers on page B3-1454](#). This means:

- In an implementation that includes the Virtualization Extensions, **CNTVOFF** is a RW register, accessible from Non-secure Hyp mode, and from Secure Monitor mode when **SCR.NS** is set to 1. An MCRR or MRRC to the **CNTVOFF** encoding is UNDEFINED if executed in Monitor mode when **SCR.NS** is set to 0.
- In an implementation that includes the Security Extensions but does not include the Virtualization Extensions, an MCRR or MRRC to the **CNTVOFF** encoding is UNPREDICTABLE if executed in Monitor mode, regardless of the value of **SCR.NS**.
- In any implementation that includes the Security Extensions, any MCRR or MRRC to the **CNTVOFF** encoding is UNDEFINED if executed in a mode other than Monitor mode, see [Banked PL2-mode CP15 read/write registers on page B3-1454](#).
- In an implementation that does not include the Security Extensions, including any PMSA implementation, although the register is conceptually present, there is no way of accessing it. The MCRR and MRRC instruction encodings for the register are UNDEFINED.

In all cases where the **CNTVOFF** register is not defined as a RW register, the virtual counter uses a fixed virtual offset value of zero.

# Chapter B9

## System Instructions

This chapter describes the instructions that are only available, or that behave differently, when executed at PL1 or higher. It contains the following sections:

- [General restrictions on system instructions on page B9-1970](#)
- [Encoding and use of Banked register transfer instructions on page B9-1971](#)
- [Alphabetical list of instructions on page B9-1976.](#)

## B9.1 General restrictions on system instructions

This section describes some restrictions that apply to a number of system instructions. The descriptions of the individual instructions refer to the following subsections when they apply:

- [Restrictions on exception return instructions](#)
- [Restrictions on updates to the CPSR.M field.](#)

### B9.1.1 Restrictions on exception return instructions

A system instruction that is an exception return instruction is UNPREDICTABLE if:

- It is executed in User mode.
- For an exception return instruction other than RFE, it is executed in System mode.
- It is executed in ThumbEE state.
- It attempts to return to Hyp mode and ThumbEE state.
- The [SPSR](#) value it restores to the [CPSR](#) is not permitted because of the restrictions described in [Restrictions on updates to the CPSR.M field.](#)

———— **Note** —————

An exception return instruction that is executed in Hyp mode can set [CPSR.M](#) to a value other than '11010', the value for Hyp mode. However, this does not apply to the following exception return instructions, because the instructions are UNDEFINED in Hyp mode:

- LDM (exception return)
- SUBS PC, LR, #<const> with a nonzero constant.

### B9.1.2 Restrictions on updates to the CPSR.M field

A system instruction that updates the [CPSR.M](#) field is UNPREDICTABLE if it attempts to change to a mode that is not accessible from the context in which the instruction is executed. This means that a system instruction is UNPREDICTABLE if it:

- Attempts to change [CPSR.M](#) to a value that does not correspond to a processor mode. [Table B1-1 on page B1-1139](#) shows the values of M that correspond to a processor mode.
- Is executed in Non-secure state and attempts to either:
  - Set [CPSR.M](#) to '10110', the value for Monitor mode.
  - Set [CPSR.M](#) to '10001', the value for FIQ mode, when [NSACR.RFR](#) is set to 1.
- Attempts to set [CPSR.M](#) to '11010', the value for Hyp mode, when any of the following applies:
  - It is executed in a Non-secure mode other than Hyp mode.
  - It is executed in a Secure mode other than Monitor mode.
  - It is executed in Monitor mode when [SCR.NS](#) is set to 0.
  - It is executed in Monitor mode and it is not an exception return instruction.
- Is not an exception return instruction, and is executed in Hyp mode, and attempts to set [CPSR.M](#) to a value other than '11010', the value for Hyp mode.

## B9.2 Encoding and use of Banked register transfer instructions

Software executing at PL1 or higher can use the MRS (Banked register) and MSR (Banked register) instructions to transfer values between the ARM core registers and Special registers. One particular use of these instructions is for a hypervisor to save or restore the register values of a Guest OS. The following sections give more information about these instructions:

- [Register arguments in the Banked register transfer instructions](#)
- [Usage restrictions on the Banked register transfer instructions on page B9-1972](#)
- [Encoding the register argument in the Banked register transfer instructions on page B9-1973](#)
- [Pseudocode support for the Banked register transfer instructions on page B9-1974.](#)

For descriptions of the instructions see [MRS \(Banked register\) on page B9-1990](#) and [MSR \(Banked register\) on page B9-1992](#).

### B9.2.1 Register arguments in the Banked register transfer instructions

Figure B9-1 shows the Banked ARM core registers and Special registers:

		Associated mode							
		User or System	Hyp	Supervisor	Abort	Undefined	Monitor	IRQ	FIQ
ARM core registers	R8_usr								R8_fiq
	R9_usr								R9_fiq
	R10_usr								R10_fiq
	R11_usr								R11_fiq
	R12_usr								R12_fiq
	SP_usr	SP_hyp	SP_svc	SP_abt	SP_und	SP_mon	SP_irq	SP_fiq	
LR_usr		LR_svc	LR_abt	LR_und	LR_mon	LR_irq	LR_fiq		
Special registers		SPSR_hyp	SPSR_svc	SPSR_abt	SPSR_und	SPSR_mon	SPSR_irq	SPSR_fiq	
		ELR_hyp							

For the ARM core registers, if no other register is shown, the *current mode register* is the `_usr` register. So, for example, the full set of current mode registers, including the registers that are not banked:

- For Hyp mode, is {R0\_usr - R12\_usr, SP\_hyp, LR\_usr, SPSR\_hyp, ELR\_hyp}.
- For Abort mode, is {R0\_usr - R12\_usr, SP\_abt, LR\_abt, SPSR\_abt}.

**Figure B9-1 Banking of ARM core registers and Special registers**

Figure B9-1 is based on [Figure B1-1 on page B1-1141](#), that shows the complete set of ARM core registers and Special registers accessible in each mode.

#### Note

- System mode uses the same set of registers as User mode. Neither of these modes can access an **SPSR**, except that System mode can use the MRS (Banked register) and MSR (Banked register) instructions to access some **SPSRs**, as described in [Usage restrictions on the Banked register transfer instructions on page B9-1972](#).
- ARM core registers R0-R7, that are not Banked, cannot be accessed using the MRS (Banked register) and MSR (Banked register) instructions.

Software using an MRS (Banked register) or MSR (Banked register) instruction specifies one of these registers using a name shown in [Figure B9-1](#), or an alternative name for SP or LR. These registers can be grouped as follows:

- R8-R12** Each of these registers has two Banked copies, `_usr` and `_fiq`, for example R8\_usr and R8\_fiq.
- SP** There is a Banked copy of SP for every mode except System mode. For example, SP\_svc is the SP for Supervisor mode.
- LR** There is a Banked copy of LR for every mode except System mode and Hyp mode. For example, LR\_svc is the SP for Supervisor mode.

- SPSR** There is a Banked copy of [SPSR](#) for every mode except System mode and User mode.
- ELR\_hyp** Except for the operations provided by MRS (Banked register) and MSR (Banked register), [ELR\\_hyp](#) is accessible only from Hyp mode. It is not Banked.

## B9.2.2 Usage restrictions on the Banked register transfer instructions

When software uses an MRS (Banked register) or MSR (Banked register) instruction, the current mode determines the permitted values of the register argument. This determination depends on the rules that an MRS (Banked register) or MSR (Banked register) instruction cannot access:

- A register that is not accessible from the current privilege level and security state. This means that, for example:
  - Non-secure software executing at PL1 or PL2 cannot access any Monitor mode registers
  - Non-secure software executing at PL1 cannot access any Hyp mode registers
  - except in Monitor mode, Secure software cannot access any Hyp mode registers.
- A register that can be accessed, from the current mode, using a different instruction.

### ———— Note —————

[NSACR.RFR](#) determines whether FIQ mode registers are accessible in Non-secure state.

This means that, for each mode, the registers that cannot be accessed are as follows:

**Hyp mode** The current mode registers R8\_usr-R12\_usr, SP\_hyp, LR\_usr, and SPSR\_hyp.  
The Monitor mode registers SP\_mon, LR\_mon, and SPSR\_mon.  
If [NSACR.RFR](#) is set to 1, the FIQ mode registers R8\_fiq-R12\_fiq, SP\_fiq, LR\_fiq, and SPSR\_fiq.

**Monitor mode** The current mode registers R8\_usr-R12\_usr, SP\_mon, LR\_mon, and SPSR\_mon.

**FIQ mode** The current mode registers R8\_fiq-R12\_fiq, SP\_fiq, LR\_fiq, and SPSR\_fiq.  
The Hyp mode registers SP\_hyp, SPSR\_hyp, and [ELR\\_hyp](#).  
In Non-secure state, the Monitor mode registers SP\_mon, LR\_mon, and SPSR\_mon.

### ———— Note —————

If [NSACR.RFR](#) is set to 1, the processor cannot be in FIQ mode in Non-secure state.

**System mode** The current mode registers R8\_usr-R12\_usr, SP\_usr, and LR\_usr.  
The Hyp mode registers SP\_hyp, SPSR\_hyp, and [ELR\\_hyp](#).  
In Non-secure state:

- the Monitor mode registers SP\_mon, LR\_mon, and SPSR\_mon
- if [NSACR.RFR](#) is set to 1, the FIQ mode registers R8\_fiq-R12\_fiq, SP\_fiq, LR\_fiq, and SPSR\_fiq.

### **Supervisor mode, Abort mode, Undefined mode, and IRQ mode**

The current mode registers R8\_usr-R12\_usr, SP\_<current\_mode>, LR\_<current\_mode>, and SPSR\_<current\_mode>.

The Hyp mode registers SP\_hyp, SPSR\_hyp, and [ELR\\_hyp](#).

In Non-secure state:

- the Monitor mode registers SP\_mon, LR\_mon, and SPSR\_mon
- if [NSACR.RFR](#) is set to 1, the FIQ mode registers R8\_fiq-R12\_fiq, SP\_fiq, LR\_fiq, and SPSR\_fiq.

**User mode** MRS (Banked register) and MSR (Banked register) instructions are always UNPREDICTABLE.



In Debug state, the behavior of these instructions is identical to their behavior in Non-debug state.

If software attempts to use an MRS (Banked register) or MSR (Banked register) instruction to access a register from a state from which this section states that the register cannot be accessed, the MRS or MSR instruction is UNPREDICTABLE. For more information, see:

- [Encoding the register argument in the Banked register transfer instructions.](#)
- [Pseudocode support for the Banked register transfer instructions on page B9-1974.](#)
- [MRS \(Banked register\) on page B9-1990.](#)
- [MSR \(Banked register\) on page B9-1992.](#)

———— **Note** —————

UNPREDICTABLE behavior must not give access to registers that are associated with a mode that cannot be entered, from the current mode, using a CPS or MSR instruction.

### B9.2.3 Encoding the register argument in the Banked register transfer instructions

The MRS (Banked register) and MSR (Banked register) instructions include a 5-bit field, SYSm, and an R bit, that together encode the register argument for the instruction.

When the R bit is set to 0, the argument is a register other than a Banked copy of the SPSR, and [Table B9-1](#) shows how the SYSm field defines the required register argument.

**Table B9-1 Banked register encodings when R==0**

SYSm<4:3>				
SYSm<2:0>	0b00	0b01	0b10	0b11
0b000	R8_usr	R8_fiq	LR_irq	UNPREDICTABLE
0b001	R9_usr	R9_fiq	SP_irq	UNPREDICTABLE
0b010	R10_usr	R10_fiq	LR_svc	UNPREDICTABLE
0b011	R11_usr	R11_fiq	SP_svc	UNPREDICTABLE
0b100	R12_usr	R12_fiq	LR_abt	LR_mon
0b101	SP_usr	SP_fiq	SP_abt	SP_mon
0b110	LR_usr	LR_fiq	LR_und	<a href="#">ELR_hyp</a>
0b111	UNPREDICTABLE	UNPREDICTABLE	SP_und	SP_hyp

When the R bit is set to 1, the argument is a Banked copy of the SPSR, and [Table B9-2](#) shows how the SYSm field defines the required register argument.

**Table B9-2 Banked register encodings when R==1**

SYSm<4:3>				
SYSm<2:0>	0b00	0b01	0b10	0b11
0b000	UNPREDICTABLE	UNPREDICTABLE	SPSR_irq	UNPREDICTABLE
0b001	UNPREDICTABLE	UNPREDICTABLE	UNPREDICTABLE	UNPREDICTABLE
0b010	UNPREDICTABLE	UNPREDICTABLE	SPSR_svc	UNPREDICTABLE
0b011	UNPREDICTABLE	UNPREDICTABLE	UNPREDICTABLE	UNPREDICTABLE

**Table B9-2 Banked register encodings when R=1 (continued)**

<b>SYSm&lt;4:3&gt;</b>				
<b>SYSm&lt;2:0&gt;</b>	0b00	0b01	0b10	0b11
0b100	UNPREDICTABLE	UNPREDICTABLE	SPSR_abt	SPSR_mon
0b101	UNPREDICTABLE	UNPREDICTABLE	UNPREDICTABLE	UNPREDICTABLE
0b110	UNPREDICTABLE	SPSR_fiq	SPSR_und	SPSR_hyp
0b111	UNPREDICTABLE	UNPREDICTABLE	UNPREDICTABLE	UNPREDICTABLE

### B9.2.4 Pseudocode support for the Banked register transfer instructions

The pseudocode functions `BankedRegisterAccessValid()` and `SPSRAccessValid()` check the validity of MRS (Banked register) and MSR (Banked register) accesses. That is, they filter the accesses that are UNPREDICTABLE either because:

- they attempt to access a register that *Usage restrictions on the Banked register transfer instructions on page B9-1972* shows is not accessible
- they use an `SYSm<4:0>` encoding that *Encoding the register argument in the Banked register transfer instructions on page B9-1973* shows as UNPREDICTABLE.

`BankedRegisterAccessValid()` applies to accesses to the Banked ARM core registers, or to `ELR_hyp`, and `SPSRAccessValid()` applies to accesses to the `SPSRs`.

```
// BankedRegisterAccessValid()
// =====
// Checks for MRS (Banked register) or MSR (Banked register) accesses to registers
// other than the SPSRs that are invalid. This includes ELR_hyp accesses.

BankedRegisterAccessValid(bits(5) SYSm, bits(5) mode)

  if SYSm<4:3> == '00' then // User mode registers
    if SYSm<2:0> == '111' then
      UNPREDICTABLE;
    elseif SYSm<2:0> == '110' then // LR_usr
      if mode IN {'11010', '11111'} then // Not from Hyp or System mode
        UNPREDICTABLE;
      elseif SYSm<2:0> == '101' then // SP_usr
        if mode == '11111' then // Not from System mode
          UNPREDICTABLE;
        elseif mode != '10001' then // FIQ mode only
          UNPREDICTABLE;

    elseif SYSm<4:3> == '01' then // FIQ mode registers
      if SYSm<2:0> == '111' || mode == '10001' || (NSACR.RFR == '1' && !IsSecure()) then
        UNPREDICTABLE;

    elseif SYSm<4:3> == '11' then // Registers for Monitor or Hyp mode
      if SYSm<2> == '0' then
        UNPREDICTABLE;
      elseif SYSm<1> == '0' then // LR_mon or SP_mon
        if !IsSecure() || mode == '10110' then // Not from Non-secure or Monitor mode
          UNPREDICTABLE;
        elseif SYSm<0> == '0' then // ELR_hyp, only from Monitor or Hyp mode
          if !(mode == '10110') OR (mode == '11010') then
            UNPREDICTABLE;
          else // SP_hyp, only from Monitor mode
            if mode != '10110' then
              UNPREDICTABLE;

  return;
```

```
// SPSRaccessValid()
// =====
// Checks for MRS (Banked register) or MSR (Banked register) accesses to the SPSRs
// that are UNPREDICTABLE.

SPSRaccessValid(bits(5) SYSm, bits(5) mode)
case SYSm of
  when '01110' // SPSR_fiq
    if (!IsSecure() && NSACR.RFR == '1') || mode == '10001' then
      UNPREDICTABLE; // 10001 is FIQ mode
  when '10000' // SPSR_irq
    if mode == '10010' then UNPREDICTABLE; // 10010 is IRQ mode
  when '10010' // SPSR_svc
    if mode == '10011' then UNPREDICTABLE; // 10011 is Supervisor mode
  when '10100' // SPSR_abt
    if mode == '10111' then UNPREDICTABLE; // 10111 is Abort mode
  when '10110' // SPSR_und
    if mode == '11011' then UNPREDICTABLE; // 11011 is Undefined mode
  when '11100' // SPSR_mon
    if mode == '10110' || !IsSecure() then UNPREDICTABLE; // 10110 is Monitor mode
  when '11110' // SPSR_hyp
    if mode != '10110' then UNPREDICTABLE; // Only from Monitor mode
  otherwise
    UNPREDICTABLE;

return;
```

## B9.3 Alphabetical list of instructions

This section lists every instruction that behaves differently when executed at PL1 or higher, or that is only available at PL1 or higher. For information about privilege levels see [Processor privilege levels, execution privilege, and access privilege on page A3-141](#).

### B9.3.1 CPS (Thumb)

Change Processor State changes one or more of the **CPSR**.{A, I, F} interrupt mask bits and the **CPSR.M** mode field, without changing the other **CPSR** bits.

CPS is treated as NOP if executed in User mode.

CPS is UNPREDICTABLE if it is either:

- attempting to change to a mode that is not permitted in the context in which it is executed, see [Restrictions on updates to the CPSR.M field on page B9-1970](#)
- executed in Debug state.

#### Encoding T1 ARMv6\*, ARMv7

CPS<effect> <iflags> Not permitted in IT block.

15	14	13	12	11	10	9	8	7	6	5	4	3	2	1	0
1	0	1	1	0	1	1	0	0	1	1	im	(0)	A	I	F

```
if A:I:F == '000' then UNPREDICTABLE;
enable = (im == '0'); disable = (im == '1'); changemode = FALSE;
affectA = (A == '1'); affectI = (I == '1'); affectF = (F == '1');
if InITBlock() then UNPREDICTABLE;
```

#### Encoding T2 ARMv6T2, ARMv7

CPS<effect>.W <iflags>{, #<mode>} Not permitted in IT block.

CPS #<mode> Not permitted in IT block.

15	14	13	12	11	10	9	8	7	6	5	4	3	2	1	0	15	14	13	12	11	10	9	8	7	6	5	4	3	2	1	0
1	1	1	1	0	0	1	1	1	0	1	0	(1)	(1)	(1)	(1)	1	0	(0)	0	(0)	imod	M	A	I	F	mode					

```
if imod == '00' && M == '0' then SEE "Hint instructions";
if mode != '00000' && M == '0' then UNPREDICTABLE;
if (imod<1> == '1' && A:I:F == '000') || (imod<1> == '0' && A:I:F != '000') then UNPREDICTABLE;
enable = (imod == '10'); disable = (imod == '11'); changemode = (M == '1');
affectA = (A == '1'); affectI = (I == '1'); affectF = (F == '1');
if imod == '01' || InITBlock() then UNPREDICTABLE;
```

#### Hint instructions

In encoding T2, if the **imod** field is '00' and the **M** bit is '0', a hint instruction is encoded. To determine which hint instruction, see [Change Processor State, and hints on page A6-236](#).

## Assembler syntax

```
CPS<effect>{<q>} <iflags> {, #<mode>}
CPS{<q>} #<mode>
```

where:

- <effect> The effect required on the A, I, and F bits in the **CPSR**. This is one of:
- IE Interrupt Enable. This sets the specified bits to 0.
  - ID Interrupt Disable. This sets the specified bits to 1.
- If <effect> is specified, the bits to be affected are specified by <iflags>. The mode can optionally be changed by specifying a mode number as <mode>.
- If <effect> is not specified, then:
- <iflags> is not specified and interrupt settings are not changed
  - <mode> specifies the new mode number.
- <q> See *Standard assembler syntax fields on page A8-287*. A CPS instruction must be unconditional.
- <iflags> Is a sequence of one or more of the following, specifying which interrupt mask bits are affected:
- a Sets the A bit in the instruction, causing the specified effect on **CPSR.A**, the asynchronous abort bit.
  - i Sets the I bit in the instruction, causing the specified effect on **CPSR.I**, the IRQ interrupt bit.
  - f Sets the F bit in the instruction, causing the specified effect on **CPSR.F**, the FIQ interrupt bit.
- <mode> The number of the mode to change to. If this option is omitted, no mode change occurs.

## Operation

```
EncodingSpecificOperations();
if CurrentModeIsNotUser() then
  cpsr_val = CPSR;
  if enable then
    if affectA then cpsr_val<8> = '0';
    if affectI then cpsr_val<7> = '0';
    if affectF then cpsr_val<6> = '0';
  if disable then
    if affectA then cpsr_val<8> = '1';
    if affectI then cpsr_val<7> = '1';
    if affectF then cpsr_val<6> = '1';
  if changemode then
    cpsr_val<4:0> = mode;

// CPSRWriteByInstr() checks for illegal mode changes
CPSRWriteByInstr(cpsr_val, '1111', FALSE);
if CPSR<4:0> == '11010' && CPSR.J == '1' && CPSR.T == '1' then UNPREDICTABLE;
```

## Exceptions

None.

### B9.3.2 CPS (ARM)

Change Processor State changes one or more of the **CPSR**.{A, I, F} interrupt mask bits and the **CPSR.M** mode field, without changing the other **CPSR** bits.

CPS is treated as NOP if executed in User mode.

CPS is UNPREDICTABLE if it is either:

- attempting to change to a mode that is not permitted in the context in which it is executed, see [Restrictions on updates to the CPSR.M field on page B9-1970](#)
- executed in Debug state.

#### Encoding A1 ARMv6\*, ARMv7

CPS<effect> <iflags>{, #<mode>}

CPS #<mode>

31	30	29	28	27	26	25	24	23	22	21	20	19	18	17	16	15	14	13	12	11	10	9	8	7	6	5	4	3	2	1	0
1	1	1	1	0	0	0	1	0	0	0	0	imod	M	0	(0)	(0)	(0)	(0)	(0)	(0)	(0)	(0)	A	I	F	0	mode				

```

if mode != '00000' && M == '0' then UNPREDICTABLE;
if (imod<1> == '1' && A:I:F == '000') || (imod<1> == '0' && A:I:F != '000') then UNPREDICTABLE;
enable = (imod == '10'); disable = (imod == '11'); changemode = (M == '1');
affectA = (A == '1'); affectI = (I == '1'); affectF = (F == '1');
if (imod == '00' && M == '0') || imod == '01' then UNPREDICTABLE;
    
```

## Assembler syntax

```
CPS<effect>{<q>} <iflags> {, #<mode>}
CPS{<q>} #<mode>
```

where:

- <effect> The effect required on the A, I, and F bits in the **CPSR**. This is one of:
- IE Interrupt Enable. This sets the specified bits to 0.
  - ID Interrupt Disable. This sets the specified bits to 1.
- If <effect> is specified, the bits to be affected are specified by <iflags>. The mode can optionally be changed by specifying a mode number as <mode>.
- If <effect> is not specified, then:
- <iflags> is not specified and interrupt settings are not changed
  - <mode> specifies the new mode number.
- <q> See [Standard assembler syntax fields on page A8-287](#). A CPS instruction must be unconditional.
- <iflags> Is a sequence of one or more of the following, specifying which interrupt mask bits are affected:
- a Sets the A bit in the instruction, causing the specified effect on **CPSR.A**, the asynchronous abort bit.
  - i Sets the I bit in the instruction, causing the specified effect on **CPSR.I**, the IRQ interrupt bit.
  - f Sets the F bit in the instruction, causing the specified effect on **CPSR.F**, the FIQ interrupt bit.
- <mode> The number of the mode to change to. If this option is omitted, no mode change occurs.

## Operation

```
EncodingSpecificOperations();
if CurrentModeIsNotUser() then
  cpsr_val = CPSR;
  if enable then
    if affectA then cpsr_val<8> = '0';
    if affectI then cpsr_val<7> = '0';
    if affectF then cpsr_val<6> = '0';
  if disable then
    if affectA then cpsr_val<8> = '1';
    if affectI then cpsr_val<7> = '1';
    if affectF then cpsr_val<6> = '1';
  if changemode then
    cpsr_val<4:0> = mode;

// CPSRWriteByInstr() checks for illegal mode changes
CPSRWriteByInstr(cpsr_val, '1111', FALSE);
```

## Exceptions

None.

### B9.3.3 ERET

When executed in Hyp mode, Exception Return loads the PC from [ELR\\_hyp](#) and loads the CPSR from SPSR\_hyp.

When executed in a Secure or Non-secure PL1 mode, ERET behaves as:

- MOVN PC, LR in the ARM instruction set, see [SUBS PC, LR and related instructions \(ARM\)](#) on page B9-2010
- the equivalent SUBS PC, LR, #0 in the Thumb instruction set, see [SUBS PC, LR \(Thumb\)](#) on page B9-2008.

ERET is UNPREDICTABLE:

- in the cases described in [Restrictions on exception return instructions](#) on page B9-1970
- if it is executed in Debug state.

———— **Note** —————

In an implementation that includes the Virtualization Extensions:

- The T1 encoding of ERET is not a new encoding but, is the preferred synonym of SUBS PC, LR, #0 in the Thumb instruction set. See [SUBS PC, LR \(Thumb\)](#) on page B9-2008 for more information.
- Because ERET is the preferred encoding, when decoding Thumb instructions, a disassembler will report an ERET where the original assembler code used SUBS PC, LR, #0.

**Encoding T1** ARMv6T2, ARMv7VE, see syntax rows.

SUBS PC, LR, #0 ARMv6T2, ARMv7  
 ERET<C> ARMv7VE

15	14	13	12	11	10	9	8	7	6	5	4	3	2	1	0	15	14	13	12	11	10	9	8	7	6	5	4	3	2	1	0
1	1	1	1	0	0	1	1	1	1	0	1	(1)	(1)	(1)	(0)	1	0	(0)	0	(1)	(1)	(1)	(1)	imm8							

if imm8 != '00000000' then SEE SUBS PC, LR and related instructions;

**Encoding A1** ARMv7VE

ERET<C>

31	30	29	28	27	26	25	24	23	22	21	20	19	18	17	16	15	14	13	12	11	10	9	8	7	6	5	4	3	2	1	0
cond		0	0	0	1	0	1	1	0	(0)	(0)	(0)	(0)	(0)	(0)	(0)	(0)	(0)	(0)	(0)	(0)	(0)	(0)	0	1	1	0	(1)	(1)	(1)	(0)

// No additional decoding required



## Assembler syntax

ERET{<c>}{<q>}

where:

<c>, <q> See [Standard assembler syntax fields on page A8-287](#).

## Operation

```
if ConditionPassed() then
    EncodingSpecificOperations();
    if (CurrentModeIsUserOrSystem() || CurrentInstrSet() == InstrSet_ThumbEE) then
        UNPREDICTABLE;
    else
        new_pc_value = if CurrentModeIsHyp() then ELR_hyp else R[14];
        CPSRWriteByInstr(SPSR[], '1111', TRUE);
        if CPSR<4:0> == '11010' && CPSR.J == '1' && CPSR.T == '1' then
            UNPREDICTABLE; // Cannot return to Hyp mode and ThumbEE state
        else
            BranchWritePC(new_pc_value);
```

## Exceptions

None.

### B9.3.4 HVC

Hypervisor Call causes a Hypervisor Call exception. For more information see [Hypervisor Call \(HVC\) exception on page B1-1211](#). Non-secure software executing at PL1 can use this instruction to call the hypervisor to request a service.

The HVC instruction is:

- UNDEFINED in Secure state, and in User mode in Non-secure state
- when SCR.HCE is set to 0, UNDEFINED in Non-secure PL1 modes and UNPREDICTABLE in Hyp mode
- UNPREDICTABLE in Debug state.

On executing an HVC instruction, the HSR reports the exception as a Hypervisor Call exception, using the EC value 0x12, and captures the value of the immediate argument, see [Use of the HSR on page B3-1424](#).

#### Encoding T1 ARMv7VE

HVC #<imm>

15	14	13	12	11	10	9	8	7	6	5	4	3	2	1	0	15	14	13	12	11	10	9	8	7	6	5	4	3	2	1	0
1	1	1	1	0	1	1	1	1	1	1	0	imm4				1	0	0	0	imm12											

```
if InITBlock() then UNPREDICTABLE;
imm16 = imm4:imm12;
// imm16 is for assembly/disassembly. It is reported in the HSR but otherwise is ignored by
// hardware. An HVC handler might interpret imm16, for example to determine the required service.
```

#### Encoding A1 ARMv7VE

HVC #<imm>

31	30	29	28	27	26	25	24	23	22	21	20	19	18	17	16	15	14	13	12	11	10	9	8	7	6	5	4	3	2	1	0
cond				0	0	0	1	0	1	0	0	imm12										0	1	1	1	imm4					

```
if cond != 1110 then UNPREDICTABLE;
imm16 = imm12:imm4;
// imm16 is for assembly/disassembly. It is reported in the HSR but otherwise is ignored by
// hardware. An HVC handler might interpret imm16, for example to determine the required service.
```

## Assembler syntax

HVC{<q>} {#}<imm16>

where:

<q> See *Standard assembler syntax fields* on page A8-287. An HVC instruction must be unconditional.

<imm16> Specifies a 16-bit immediate constant.

## Operation

```
EncodingSpecificOperations();
if !HasVirtExt() || IsSecure() || !CurrentModeIsNotUser() then
    UNDEFINED;
elseif SCR.HCE == '0' then
    if CurrentModeIsHyp() then
        UNPREDICTABLE;
    else
        UNDEFINED;
else
    CallHypervisor(imm16);
```

## Exceptions

Hypervisor Call.

### B9.3.5 LDM (exception return)

Load Multiple (exception return) loads multiple registers from consecutive memory locations using an address from a base register. The **SPSR** of the current mode is copied to the **CPSR**. An address adjusted by the size of the data loaded can optionally be written back to the base register.

The registers loaded include the PC. The word loaded for the PC is treated as an address and a branch occurs to that address.

LDM (exception return) is:

- UNDEFINED in Hyp mode
- UNPREDICTABLE in:
  - the cases described in *Restrictions on exception return instructions on page B9-1970*
  - Debug state.

#### Encoding A1 ARMv4\*, ARMv5T\*, ARMv6\*, ARMv7

LDM{<amode>}<c> <Rn>{!}, <registers\_with\_pc>^

31	30	29	28	27	26	25	24	23	22	21	20	19	18	17	16	15	14	13	12	11	10	9	8	7	6	5	4	3	2	1	0
cond		1	0	0	P	U	1	W	1	Rn							1	register_list													

```
n = UInt(Rn); registers = register_list;
wback = (W == '1'); increment = (U == '1'); wordhigher = (P == U);
if n == 15 then UNPREDICTABLE;
if wback && registers<n> == '1' && ArchVersion() >= 7 then UNPREDICTABLE;
```

#### Assembler syntax

LDM{<amode>}{<c>}{<q>} <Rn>{!}, <registers\_with\_pc>^

where:

<amode> is one of:

- DA Decrement After. The consecutive memory addresses end at the address in the base register. Encoded as P = 0, U = 0.
- FA Full Ascending. For this instruction, a synonym for DA.
- DB Decrement Before. The consecutive memory addresses end one word below the address in the base register. Encoded as P = 1, U = 0.
- EA Empty Ascending. For this instruction, a synonym for DB.
- IA Increment After. The consecutive memory addresses start at the address in the base register. This is the default. Encoded as P = 0, U = 1.
- FD Full Descending. For this instruction, a synonym for IA.
- IB Increment Before. The consecutive memory addresses start one word above the address in the base register. Encoded as P = 1, U = 1.
- ED Empty Descending. For this instruction, a synonym for IB.

<c>, <q> See *Standard assembler syntax fields on page A8-287*.

<Rn> The base register. This register can be the SP.

! Causes the instruction to write a modified value back to <Rn>. Encoded as W = 1.  
 If ! is omitted, the instruction does not change <Rn> in this way. Encoded as W = 0.

<registers\_with\_pc>

Is a list of one or more registers, separated by commas and surrounded by { and }. It specifies the set of registers to be loaded. The registers are loaded with the lowest-numbered register from the lowest memory address, through to the highest-numbered register from the highest memory address. The PC must be specified in the register list, and the instruction causes a branch to the address (data) loaded into the PC. See also *Encoding of lists of ARM core registers on page A8-295*.

The pre-UAL syntax LDM<c>{<amode>} is equivalent to LDM{<amode>}<c>.

———— **Note** —————

Instructions with similar syntax but without the PC included in the registers list are described in *LDM (User registers) on page B9-1986*.

**Operation**

```

if ConditionPassed() then
  EncodingSpecificOperations();
  if CurrentModeIsHyp() then
    UNDEFINED;
  elsif (CurrentModeIsUserOrSystem() || CurrentInstrSet() == InstrSet_ThumbEE) then
    UNPREDICTABLE;
  else
    length = 4*BitCount(registers) + 4;
    address = if increment then R[n] else R[n]-length;
    if wordhigher then address = address+4;
    for i = 0 to 14
      if registers<i> == '1' then
        R[i] = MemA[address,4]; address = address + 4;
    new_pc_value = MemA[address,4];
    if wback && registers<n> == '0' then R[n] = if increment then R[n]+length else R[n]-length;
    if wback && registers<n> == '1' then R[n] = bits(32) UNKNOWN;
    CPSRWriteByInstr(SPSR[], '1111', TRUE);
    if CPSR<4:0> == '11010' && CPSR.J == '1' && CPSR.T == '1' then
      UNPREDICTABLE;
    else
      BranchWritePC(new_pc_value);
  
```

**Exceptions**

Data Abort.

### B9.3.6 LDM (User registers)

In a PL1 mode other than System mode, Load Multiple (User registers) loads multiple User mode registers from consecutive memory locations using an address from a base register. The registers loaded cannot include the PC. The processor reads the base register value normally, using the current mode to determine the correct Banked version of the register. This instruction cannot writeback to the base register.

LDM (user registers) is UNDEFINED in Hyp mode, and UNPREDICTABLE in User and System modes.

**Encoding A1** ARMv4\*, ARMv5T\*, ARMv6\*, ARMv7

LDM{<amode>}<c> <Rn>, <registers\_without\_pc>^

31	30	29	28	27	26	25	24	23	22	21	20	19	18	17	16	15	14	13	12	11	10	9	8	7	6	5	4	3	2	1	0
cond		1	0	0	P	U	1	(0)	1	Rn							0	register_list													

n = UInt(Rn); registers = register\_list; increment = (U == '1'); wordhigher = (P == U);  
 if n == 15 || BitCount(registers) < 1 then UNPREDICTABLE;

## Assembler syntax

LDM{<amode>}{<c>}{<q>} <Rn>, <registers\_without\_pc>^

where:

<amode> is one of:

- DA Decrement After. The consecutive memory addresses end at the address in the base register. Encoded as P = 0, U = 0.
- FA Full Ascending. For this instruction, a synonym for DA.
- DB Decrement Before. The consecutive memory addresses end one word below the address in the base register. Encoded as P = 1, U = 0.
- EA Empty Ascending. For this instruction, a synonym for DB.
- IA Increment After. The consecutive memory addresses start at the address in the base register. This is the default. Encoded as P = 0, U = 1.
- FD Full Descending. For this instruction, a synonym for IA.
- IB Increment Before. The consecutive memory addresses start one word above the address in the base register. Encoded as P = 1, U = 1.
- ED Empty Descending. For this instruction, a synonym for IB.

<c>, <q> See [Standard assembler syntax fields on page A8-287](#).

<Rn> The base register. This register can be the SP.

<registers\_without\_pc>

Is a list of one or more registers, separated by commas and surrounded by { and }. It specifies the set of registers to be loaded by the LDM instruction. The registers are loaded with the lowest-numbered register from the lowest memory address, through to the highest-numbered register from the highest memory address. The PC must not be in the register list. See also [Encoding of lists of ARM core registers on page A8-295](#).

The pre-UAL syntax LDM<c>{<amode>} is equivalent to LDM{<amode>}<c>.

### ———— Note ————

Instructions with similar syntax but with the PC included in <registers\_without\_pc> are described in [LDM \(exception return\) on page B9-1984](#).

## Operation

```

if ConditionPassed() then
    EncodingSpecificOperations();
    if CurrentModeIsHyp() then UNDEFINED;
    elsif CurrentModeIsUserOrSystem() then UNPREDICTABLE;
    else
        length = 4*BitCount(registers);
        address = if increment then R[n] else R[n]-length;
        if wordhigher then address = address+4;
        for i = 0 to 14
            if registers<i> == '1' then // Load User mode ('10000') register
                Rmode[i, '10000'] = MemA[address,4]; address = address + 4;
  
```

## Exceptions

Data Abort.

### B9.3.7 LDRBT, LDRHT, LDRSBT, LDRSHT, and LDRT

Even when executed at PL1 or higher, loads from memory by these instructions are restricted in the same way as unprivileged loads from memory. The MemA\_unpriv[] and MemU\_unpriv[] pseudocode functions describe this restriction. For more information see *Aligned memory accesses* on page B2-1294 and *Unaligned memory accesses* on page B2-1295.

These instructions are UNPREDICTABLE in Hyp mode.

For descriptions of the instructions see:

- [LDRBT](#) on page A8-424
- [LDRHT](#) on page A8-448
- [LDRSBT](#) on page A8-456
- [LDRSHT](#) on page A8-464
- [LDRT](#) on page A8-466.

### B9.3.8 MRS

Move to Register from Special register moves the value from the [CPSR](#) or [SPSR](#) of the current mode into an ARM core register.

An MRS that accesses the [SPSR](#) is UNPREDICTABLE if executed in User or System mode.

An MRS that is executed in User mode and accesses the [CPSR](#) returns an UNKNOWN value for the [CPSR](#). {E, A, I, F, M} fields.

———— **Note** —————

[MRS](#) on page A8-496 describes the valid application level uses of the MRS instruction.

#### Encoding T1 ARMv6T2, ARMv7

MRS<c> <Rd>, <spec\_reg>

15	14	13	12	11	10	9	8	7	6	5	4	3	2	1	0	15	14	13	12	11	10	9	8	7	6	5	4	3	2	1	0
1	1	1	1	0	0	1	1	1	1	1	R	(1)	(1)	(1)	(1)	1	0	(0)	0	Rd	(0)	(0)	0	(0)	(0)	(0)	(0)	(0)			

d = UInt(Rd); read\_spsr = (R == '1');  
 if d IN {13,15} then UNPREDICTABLE;

#### Encoding A1 ARMv4\*, ARMv5T\*, ARMv6\*, ARMv7

MRS<c> <Rd>, <spec\_reg>

31	30	29	28	27	26	25	24	23	22	21	20	19	18	17	16	15	14	13	12	11	10	9	8	7	6	5	4	3	2	1	0
cond	0	0	0	1	0	R	0	0	(1)	(1)	(1)	(1)	Rd	(0)	(0)	0	(0)	0	0	0	0	0	0	0	0	0	(0)	(0)	(0)	(0)	

d = UInt(Rd); read\_spsr = (R == '1');  
 if d == 15 then UNPREDICTABLE;



## Assembler syntax

MRS{<c>}{<q>} <Rd>, <spec\_reg>

where:

<c>, <q> See [Standard assembler syntax fields](#) on page A8-287.

<Rd> The destination register.

<spec\_reg> Is one of:

- APSR
- CPSR
- SPSR.

ARM recommends that software uses the APSR form when only the N, Z, C, V, Q, or GE[3:0] bits of the read value are going to be used, see [The Application Program Status Register \(APSR\)](#) on page A2-49.

## Operation

```
if ConditionPassed() then
  EncodingSpecificOperations();
  if read_spsr then
    if CurrentModeIsUserOrSystem() then
      UNPREDICTABLE;
    else
      R[d] = SPSR[];
  else
    // CPSR is read with execution state bits other than E masked out.
    R[d] = CPSR AND '11111000 11111111 00000011 11011111';
    if !CurrentModeIsNotUser() then
      // If accessed from User mode return UNKNOWN values for M, bits<4:0>,
      // and for the E, A, I, F bits, bits<9:6>
      R[d]<4:0> = bits(5) UNKNOWN;
      R[d]<9:6> = bits(4) UNKNOWN;
```

## Exceptions

None.

### B9.3.9 MRS (Banked register)

Move to Register from Banked or Special register moves the value from the Banked ARM core register or [SPSR](#) of the specified mode, or the value of [ELR\\_hyp](#), to an ARM core register.

MRS (Banked register) is UNPREDICTABLE if executed in User mode.

The effect of using an MRS (Banked register) instruction with a register argument that is not valid for the current mode is UNPREDICTABLE. For more information see [Usage restrictions on the Banked register transfer instructions on page B9-1972](#).

#### Encoding T1 ARMv7VE

MRS<c> <Rd>, <banked\_reg>

15	14	13	12	11	10	9	8	7	6	5	4	3	2	1	0	15	14	13	12	11	10	9	8	7	6	5	4	3	2	1	0
1	1	1	1	0	0	1	1	1	1	1	R	m1				1	0	(0)	0	Rd				(0)	(0)	1	m	(0)	(0)	(0)	(0)

```
d = UInt(Rd); read_spsr = (R == '1');
if d IN {13,15} then UNPREDICTABLE;
SYSm = m:m1;
```

#### Encoding A1 ARMv7VE

MRS<c> <Rd>, <banked\_reg>

31	30	29	28	27	26	25	24	23	22	21	20	19	18	17	16	15	14	13	12	11	10	9	8	7	6	5	4	3	2	1	0
cond		0	0	0	1	0	R	0	0	m1				Rd				(0)	(0)	1	m	0	0	0	0	(0)	(0)	(0)	(0)		

```
d = UInt(Rd); read_spsr = (R == '1');
if d == 15 then UNPREDICTABLE;
SYSm = m:m1;
```

### Assembler syntax

MRS{<c>}{<q>} <Rd>, <banked\_reg>

where:

<c>, <q> See [Standard assembler syntax fields on page A8-287](#).

<Rd> The destination register.

<banked\_reg> Is one of:

- <Rm>\_<mode>, encoded with R==0.
- ELR\_hyp, encoded with R==0.
- SPSR\_<mode>, encoded with R==1.

For a full description of the encoding of this field, see [Encoding and use of Banked register transfer instructions on page B9-1971](#).

## Operation

```

if ConditionPassed() then
    EncodingSpecificOperations();
    if !CurrentModeIsNotUser() then
        UNPREDICTABLE;
    else
        mode = CPSR.M;
        if read_spsr then
            SPSRAccessValid(SYSm, mode); // Check for UNPREDICTABLE cases
            case SYSm of
                when '01110' R[d] = SPSR_fiq;
                when '10000' R[d] = SPSR_irq;
                when '10010' R[d] = SPSR_svc;
                when '10100' R[d] = SPSR_abt;
                when '10110' R[d] = SPSR_und;
                when '11100' R[d] = SPSR_mon;
                when '11110' R[d] = SPSR_hyp;
            else
                BankedRegisterAccessValid(SYSm, mode); // Check for UNPREDICTABLE cases

        if SYSm<4:3> == '00' then // Access the User registers
            m = UInt(SYSm<2:0>) + 8;
            R[d] = Rmode[m,'10000'];
        elsif SYSm<4:3> == '01' then // Access the FIQ registers
            m = UInt(SYSm<2:0>) + 8;
            R[d] = Rmode[m,'10001'];
        elsif SYSm<4:3> == '11' then
            if SYSm<1> == '0' then // Access Monitor registers
                m = 14 - UInt(SYSm<0>); // LR when SYSm<0> == 0, otherwise SP
                R[d] = Rmode[m,'10110'];
            else // Access Hyp registers
                if SYSm<0> == '1' then // access SP_hyp
                    R[d] = Rmode[13,'11010'];
                else
                    R[d] = ELR_hyp;
            else // Other Banked registers
                bits(5) targetmode; // (SYSm<4:3> == '10' case)
                targetmode<0> = SYSm<2> OR SYSm<1>;
                targetmode<1> = '1';
                targetmode<2> = SYSm<2> AND NOT SYSm<1>;
                targetmode<3> = SYSm<2> AND SYSm<1>;
                targetmode<4> = '1';
                if mode == targetmode then
                    UNPREDICTABLE;
                else
                    m = 14 - UInt(SYSm<0>); // LR when SYSm<0> == 0, otherwise SP
                    R[d] = Rmode[m,targetmode];

```

## Exceptions

None.

### B9.3.10 MSR (Banked register)

Move to Banked or Special register from ARM core register moves the value of an ARM core register to the Banked ARM core register or [SPSR](#) of the specified mode, or to [ELR\\_hyp](#).

MSR (Banked register) is UNPREDICTABLE if executed in User mode.

The effect of using an MSR (Banked register) instruction with a register argument that is not valid for the current mode is UNPREDICTABLE. For more information see [Usage restrictions on the Banked register transfer instructions on page B9-1972](#).

#### Encoding T1 ARMv7VE

MSR<c> <banked\_reg>, <Rn>

15	14	13	12	11	10	9	8	7	6	5	4	3	2	1	0	15	14	13	12	11	10	9	8	7	6	5	4	3	2	1	0
1	1	1	1	0	0	1	1	1	0	0	R		Rn			1	0	(0)	(0)			m1		(0)	(0)	1	m	(0)	(0)	(0)	(0)

```
n = UInt(Rn); write_spsr = (R == '1');
if n IN {13,15} then UNPREDICTABLE;
SYSm = m:m1;
```

#### Encoding A1 ARMv7VE

MSR<c> <banked\_reg>, <Rn>

31	30	29	28	27	26	25	24	23	22	21	20	19	18	17	16	15	14	13	12	11	10	9	8	7	6	5	4	3	2	1	0
cond		0	0	0	1	0	R	1	0		m1	(1)	(1)	(1)	(1)	(0)	(0)	1	m	0	0	0	0							Rn	

```
n = UInt(Rn); write_spsr = (R == '1');
if n == 15 then UNPREDICTABLE;
SYSm = m:m1;
```

### Assembler syntax

MSR{<c>}{<q>} <banked\_reg>, <Rn>

where:

<c>, <q> See [Standard assembler syntax fields on page A8-287](#).

<banked\_reg> Is one of:

- <Rm>\_<mode>, encoded with R==0.
- ELR\_hyp, encoded with R==0.
- SPSR\_<mode>, encoded with R==1.

For a full description of the encoding of this field, see [Encoding and use of Banked register transfer instructions on page B9-1971](#).

<Rn> Is the ARM core register to be transferred to <banked\_reg>.

## Operation

```

if ConditionPassed() then
  EncodingSpecificOperations();
  if !CurrentModeIsNotUser() then
    UNPREDICTABLE;
  else
    mode = CPSR.M;
    if write_spsr then
      SPSRaccessValid(SYSm, mode); // Check for UNPREDICTABLE cases
      case SYSm of
        when '01110' SPSR_fiq = R[n];
        when '10000' SPSR_irq = R[n];
        when '10010' SPSR_svc = R[n];
        when '10100' SPSR_abt = R[n];
        when '10110' SPSR_und = R[n];
        when '11100' SPSR_mon = R[n];
        when '11110' SPSR_hyp = R[n];
      else
        BankedRegisterAccessValid(SYSm, mode); // Check for UNPREDICTABLE cases

    if SYSm<4:3> == '00' then // Access the User registers
      m = UInt(SYSm<2:0>) + 8;
      Rmode[m, '10000'] = R[n];
    elseif SYSm<4:3> == '01' then // Access the FIQ registers
      m = UInt(SYSm<2:0>) + 8;
      Rmode[m, '10001'] = R[n];
    elseif SYSm<4:3> == '11' then
      if SYSm<1> == '0' then // Access Monitor registers
        m = 14 - UInt(SYSm<0>); // LR when SYSm<0> == 0, otherwise SP
        Rmode[m, '10110'] = R[n];
      else // Access Hyp registers
        if SYSm<0> == '1' then // access SP_hyp
          Rmode[13, '11010'] = R[n];
        else
          ELR_hyp = R[n];
      else // Other Banked registers
        bits(5) targetmode; // (SYSm<4:3> == '10' case)
        targetmode<0> = SYSm<2> OR SYSm<1>;
        targetmode<1> = '1';
        targetmode<2> = SYSm<2> AND NOT SYSm<1>;
        targetmode<3> = SYSm<2> AND SYSm<1>;
        targetmode<4> = '1';
        if mode == targetmode then
          UNPREDICTABLE;
        else
          m = 14 - UInt(SYSm<0>); // LR when SYSm<0> == 0, otherwise SP
          Rmode[m, targetmode] = R[n];
  
```

## Exceptions

None.

### B9.3.11 MSR (immediate)

Move immediate value to Special register moves selected bits of an immediate value to the **CPSR** or the **SPSR** of the current mode.

MSR (immediate) is UNPREDICTABLE if:

- In Non-debug state, it is attempting to update the **CPSR**, and that update would change to a mode that is not permitted in the context in which the instruction is executed, see *Restrictions on updates to the CPSR.M field* on page B9-1970.
- In Debug state, it is attempting an update to the **CPSR** with a <fields> value that is not <fsxc>. See *Behavior of MRS and MSR instructions that access the CPSR in Debug state* on page C5-2097.

An MSR (immediate) executed in User mode:

- is UNPREDICTABLE if it attempts to update the **SPSR**
- otherwise, does not update any **CPSR** field that is accessible only at PL1 or higher,

———— **Note** —————

[MSR \(immediate\) on page A8-498](#) describes the valid application level uses of the MSR (immediate) instruction.

An MSR (immediate) executed in System mode is UNPREDICTABLE if it attempts to update the **SPSR**.

#### Encoding A1 ARMv4\*, ARMv5T\*, ARMv6\*, ARMv7

MSR<c> <spec\_reg>, #<const>

31	30	29	28	27	26	25	24	23	22	21	20	19	18	17	16	15	14	13	12	11	10	9	8	7	6	5	4	3	2	1	0
cond				0	0	1	1	0	R	1	0	mask				(1)	(1)	(1)	(1)	imm12											

```
if mask == '0000' && R == '0' then SEE "Related encodings";
imm32 = ARMEExpandImm(imm12); write_spsr = (R == '1');
if mask == '0000' then UNPREDICTABLE;
```

**Related encodings** See [MSR \(immediate\), and hints on page A5-206](#).

## Assembler syntax

MSR{<c>}{<q>} <spec\_reg>, #<const>

where:

<c>, <q> See *Standard assembler syntax fields* on page A8-287.

<spec\_reg> Is one of:

- APSR\_<bits>
- CPSR\_<fields>
- SPSR\_<fields>.

ARM recommends the APSR forms when only the N, Z, C, V, Q, and GE[3:0] bits are being written. For more information, see *The Application Program Status Register (APSR)* on page A2-49.

<const> The immediate value to be transferred to <spec\_reg>. See *Modified immediate constants in ARM instructions* on page A5-200 for the range of values.

<bits> Is one of nzcvsq, g, or nzcvsqg.

In the A and R profiles:

- APSR\_nzcvsq is the same as CPSR\_f (mask == '1000')
- APSR\_g is the same as CPSR\_s (mask == '0100')
- APSR\_nzcvsqg is the same as CPSR\_fs (mask == '1100').

<fields> Is a sequence of one or more of the following:

- c mask<0> = '1' to enable writing of bits<7:0> of the destination PSR
- x mask<1> = '1' to enable writing of bits<15:8> of the destination PSR
- s mask<2> = '1' to enable writing of bits<23:16> of the destination PSR
- f mask<3> = '1' to enable writing of bits<31:24> of the destination PSR.

## Operation

```
if ConditionPassed() then
    EncodingSpecificOperations();
    if write_spsr then
        SPSRWriteByInstr(imm32, mask);
    else
        CPSRWriteByInstr(imm32, mask, FALSE); // Does not affect execution state bits other than E
        if CPSR<4:0> == '11010' && CPSR.J == '1' && CPSR.T == '1' then UNPREDICTABLE;
```

## Exceptions

None.

## E bit

The CPSR.E bit is writable from any mode using an MSR instruction. ARM deprecates using this to change its value. Use the SETEND instruction instead.

### B9.3.12 MSR (register)

Move to Special register from ARM core register moves the value of an ARM core register to the **CPSR** or the **SPSR** of the current mode.

MSR (register) is UNPREDICTABLE if:

- In Non-debug state, it is attempting to update the **CPSR**, and that update would change to a mode that is not permitted in the context in which the instruction is executed, see *Restrictions on updates to the CPSR.M field on page B9-1970*.
- In Debug state, it is attempting an update to the **CPSR** with a <fields> value that is not <fsxc>. See *Behavior of MRS and MSR instructions that access the CPSR in Debug state on page C5-2097*.

An MSR (register) executed in User mode:

- is UNPREDICTABLE if it attempts to update the **SPSR**
- otherwise, does not update any **CPSR** field that is accessible only at PL1 or higher,

———— **Note** —————

*MSR (register) on page A8-500* describes the valid application level uses of the MSR (register) instruction.

An MSR (register) executed in System mode is UNPREDICTABLE if it attempts to update the **SPSR**.

#### Encoding T1 ARMv6T2, ARMv7

MSR<c> <spec\_reg>, <Rn>

15	14	13	12	11	10	9	8	7	6	5	4	3	2	1	0	15	14	13	12	11	10	9	8	7	6	5	4	3	2	1	0
1	1	1	1	0	0	1	1	1	0	0	R		Rn			1	0	(0)	0			mask		(0)	(0)	0	(0)	(0)	(0)	(0)	(0)

```
n = UInt(Rn); write_spsr = (R == '1');
if mask == '0000' then UNPREDICTABLE;
if n IN {13,15} then UNPREDICTABLE;
```

#### Encoding A1 ARMv4\*, ARMv5T\*, ARMv6\*, ARMv7

MSR<c> <spec\_reg>, <Rn>

31	30	29	28	27	26	25	24	23	22	21	20	19	18	17	16	15	14	13	12	11	10	9	8	7	6	5	4	3	2	1	0
cond		0	0	0	1	0	R	1	0		mask		(1)	(1)	(1)	(1)	(0)	(0)	0	(0)	0	(0)	0	0	0	0			Rn		

```
n = UInt(Rn); write_spsr = (R == '1');
if mask == '0000' then UNPREDICTABLE;
if n == 15 then UNPREDICTABLE;
```



## Assembler syntax

MSR{<c>}{<q>} <spec\_reg>, <Rn>

where:

<c>, <q> See *Standard assembler syntax fields* on page A8-287.

<spec\_reg> Is one of:

- APSR\_<bits>
- CPSR\_<fields>
- SPSR\_<fields>.

ARM recommends the APSR forms when only the N, Z, C, V, Q, and GE[3:0] bits are being written. For more information, see *The Application Program Status Register (APSR)* on page A2-49.

<Rn> Is the ARM core register to be transferred to <spec\_reg>.

<bits> Is one of nzcvcq, g, or nzcvcqg.

In the A and R profiles:

- APSR\_nzcvcq is the same as CPSR\_f (mask == '1000')
- APSR\_g is the same as CPSR\_s (mask == '0100')
- APSR\_nzcvcqg is the same as CPSR\_fs (mask == '1100').

<fields> Is a sequence of one or more of the following:

- |   |  |
|---|--|
| c | mask<0> = '1' to enable writing of bits<7:0> of the destination PSR    |
| x | mask<1> = '1' to enable writing of bits<15:8> of the destination PSR   |
| s | mask<2> = '1' to enable writing of bits<23:16> of the destination PSR  |
| f | mask<3> = '1' to enable writing of bits<31:24> of the destination PSR. |

## Operation

```

if ConditionPassed() then
    EncodingSpecificOperations();
    if write_spsr then
        SPSRWriteByInstr(R[n], mask);
    else
        CPSRWriteByInstr(R[n], mask, FALSE); // Does not affect execution state bits other than E
        if CPSR<4:0> == '11010' && CPSR.J == '1' && CPSR.T == '1' then UNPREDICTABLE;
  
```

## Exceptions

None.

## E bit

The CPSR.E bit is writable from any mode using an MSR instruction. ARM deprecates using this to change its value. Use the SETEND instruction instead.

### B9.3.13 RFE

Return From Exception loads the PC and the CPSR from the word at the specified address and the following word respectively. For information about memory accesses see *Memory accesses* on page A8-294.

RFE is:

- UNDEFINED in Hyp mode.
- UNPREDICTABLE in:
  - The cases described in *Restrictions on exception return instructions* on page B9-1970.

———— **Note** —————

As identified in *Restrictions on exception return instructions* on page B9-1970, RFE differs from other exception return instructions in that it can be executed in System mode.

- Debug state.

**Encoding T1**          ARMv6T2, ARMv7

RFEDB<c> <Rn>{!} Outside or last in IT block

15	14	13	12	11	10	9	8	7	6	5	4	3	2	1	0	15	14	13	12	11	10	9	8	7	6	5	4	3	2	1	0
1	1	1	0	1	0	0	0	0	0	W	1				Rn	(1)	(1)	(0)	(0)	(0)	(0)	(0)	(0)	(0)	(0)	(0)	(0)	(0)	(0)		

```
if CurrentInstrSet() == InstrSet_ThumbEE then UNPREDICTABLE;
n = UInt(Rn); wback = (W == '1'); increment = FALSE; wordhigher = FALSE;
if n == 15 then UNPREDICTABLE;
if InITBlock() && !LastInITBlock() then UNPREDICTABLE;
```

**Encoding T2**          ARMv6T2, ARMv7

RFE{IA}<c> <Rn>{!} Outside or last in IT block

15	14	13	12	11	10	9	8	7	6	5	4	3	2	1	0	15	14	13	12	11	10	9	8	7	6	5	4	3	2	1	0
1	1	1	0	1	0	0	1	1	0	W	1				Rn	(1)	(1)	(0)	(0)	(0)	(0)	(0)	(0)	(0)	(0)	(0)	(0)	(0)			

```
if CurrentInstrSet() == InstrSet_ThumbEE then UNPREDICTABLE;
n = UInt(Rn); wback = (W == '1'); increment = TRUE; wordhigher = FALSE;
if n == 15 then UNPREDICTABLE;
if InITBlock() && !LastInITBlock() then UNPREDICTABLE;
```

**Encoding A1**          ARMv6\*, ARMv7

RFE{<amode>} <Rn>{!}

31	30	29	28	27	26	25	24	23	22	21	20	19	18	17	16	15	14	13	12	11	10	9	8	7	6	5	4	3	2	1	0	
1	1	1	1	1	0	0	P	U	0	W	1					Rn	(0)	(0)	(0)	(0)	(1)	(0)	(1)	(0)	(0)	(0)	(0)	(0)	(0)	(0)	(0)	(0)

```
n = UInt(Rn);
wback = (W == '1'); inc = (U == '1'); wordhigher = (P == U);
if n == 15 then UNPREDICTABLE;
```

## Assembler syntax

RFE{<amode>}{<C>}{<q>} <Rn>{!}

where:

<amode>	is one of:
DA	Decrement After. ARM instructions only. The consecutive memory addresses end at the address in the base register. Encoded as P = 0, U = 0 in encoding A1.
DB	Decrement Before. The consecutive memory addresses end one word below the address in the base register. Encoding T1, or encoding A1 with P = 1, U = 0.
IA	Increment After. The consecutive memory addresses start at the address in the base register. This is the default. Encoding T2, or encoding A1 with P = 0, U = 1.
IB	Increment Before. ARM instructions only. The consecutive memory addresses start one word above the address in the base register. Encoded as P = 1, U = 1 in encoding A1.
<C>, <q>	See <a href="#">Standard assembler syntax fields on page A8-287</a> . An ARM RFE instruction must be unconditional.
<Rn>	The base register.
!	Causes the instruction to write a modified value back to <Rn>. If ! is omitted, the instruction does not change <Rn>.

RFEFA, RFEFA, RFEFD, and RFEED are pseudo-instructions for RFEDA, RFEDB, RFEIA, and RFEIB respectively, referring to their use for popping data from Full Ascending, Empty Ascending, Full Descending, and Empty Descending stacks.

## Operation

```

if ConditionPassed() then
    EncodingSpecificOperations();
    if CurrentModeIsHyp() then
        UNDEFINED;
    elseif (!CurrentModeIsNotUser() || CurrentInstrSet() == InstrSet_ThumbEE) then
        UNPREDICTABLE;
    else
        address = if increment then R[n] else R[n]-8;
        if wordhigher then address = address+4;
        if wback then R[n] = if increment then R[n]+8 else R[n]-8;
        new_pc_value = MemA[address,4];
        CPSRWriteByInstr(MemA[address+4,4], '1111', TRUE);
        if CPSR<4:0> == '11010' && CPSR.J == '1' && CPSR.T == '1' then
            UNPREDICTABLE;
        else
            BranchWritePC(new_pc_value);
  
```

## Exceptions

Data Abort.

### B9.3.14 SMC (previously SMI)

Secure Monitor Call causes a Secure Monitor Call exception. For more information see [Secure Monitor Call \(SMC\) exception on page B1-1210](#).

SMC is available only from software executing at PL1 or higher. It is UNDEFINED in User mode.

In an implementation that includes the Virtualization Extensions:

- If `HCR.TSC` is set to 1, execution of an SMC instruction in a Non-secure PL1 mode generates a Hyp Trap exception, regardless of the value of `SCR.SCD`. For more information see [Trapping use of the SMC instruction on page B1-1254](#).
- Otherwise, when `SCR.SCD` is set to 1, the SMC instruction is:
  - UNDEFINED in Non-secure state
  - UNPREDICTABLE if executed in a Secure PL1 mode.

#### Encoding T1 Security Extensions (not in ARMv6K)

SMC<c> #<imm4>

15	14	13	12	11	10	9	8	7	6	5	4	3	2	1	0	15	14	13	12	11	10	9	8	7	6	5	4	3	2	1	0
1	1	1	1	0	1	1	1	1	1	1	1	imm4				1	0	0	0	(0)	(0)	(0)	(0)	(0)	(0)	(0)	(0)	(0)	(0)	(0)	

```
imm32 = ZeroExtend(imm4, 32);
// imm32 is for assembly/disassembly only and is ignored by hardware
if InITBlock() && !LastInITBlock() then UNPREDICTABLE;
```

#### Encoding A1 Security Extensions

SMC<c> #<imm4>

31	30	29	28	27	26	25	24	23	22	21	20	19	18	17	16	15	14	13	12	11	10	9	8	7	6	5	4	3	2	1	0	
cond				0	0	0	1	0	1	1	0	(0)	(0)	(0)	(0)	(0)	(0)	(0)	(0)	(0)	(0)	(0)	(0)	(0)	0	1	1	1	imm4			

```
imm32 = ZeroExtend(imm4, 32);
// imm32 is for assembly/disassembly only and is ignored by hardware
```

## Assembler syntax

SMC{<c>}{<q>} {#}<imm4>

where:

<c>, <q> See *Standard assembler syntax fields* on page A8-287.

<imm4> Is a 4-bit immediate value. This is ignored by the ARM processor. The Secure Monitor Call exception handler (Secure Monitor code) can use this value to determine what service is being requested, but ARM does not recommend this.

The pre-UAL syntax SMI<c> is equivalent to SMC<c>.

## Operation

```
if ConditionPassed() then
    EncodingSpecificOperations();
    if HaveSecurityExt() && CurrentModeIsNotUser() then
        if HaveVirtExt() && !IsSecure() && !CurrentModeIsHyp() && HCR.TSC == '1' then
            HSRString = Zeros(25);
            WriteHSR('010011', HSRString);
            TakeHypTrapException();
        else
            if SCR.SCD == '1' then
                if IsSecure() then
                    UNPREDICTABLE;
                else
                    UNDEFINED;
            else
                TakeSMCEXception();
    else
        UNDEFINED;
```

## Exceptions

Secure Monitor Call, Hyp Trap.

### B9.3.15 SRS (Thumb)

Store Return State stores the LR and SPSR of the current mode to the stack of a specified mode. For information about memory accesses see *Memory accesses* on page A8-294.

SRS is:

- UNDEFINED in Hyp mode
- UNPREDICTABLE if:
  - it is executed in ThumbEE state
  - it is executed in User or System mode
  - it attempts to store the Monitor mode SP when in Non-secure state
  - NSACR.RFR is set to 1 and it attempts to store the FIQ mode SP when in Non-secure state
  - it attempts to store the Hyp mode SP.

#### Encoding T1 ARMv6T2, ARMv7

SRSDB<c> SP{!}, #<mode>

15	14	13	12	11	10	9	8	7	6	5	4	3	2	1	0	15	14	13	12	11	10	9	8	7	6	5	4	3	2	1	0
1	1	1	0	1	0	0	0	0	W	0	(1)	(1)	(0)	(1)	(1)	(1)	(0)	(0)	(0)	(0)	(0)	(0)	(0)	(0)	(0)	(0)	(0)	(0)	mode		

if CurrentInstrSet() == InstrSet\_ThumbEE then UNPREDICTABLE;  
 wback = (W == '1'); increment = FALSE; wordhigher = FALSE;

#### Encoding T2 ARMv6T2, ARMv7

SRS{IA}<c> SP{!}, #<mode>

15	14	13	12	11	10	9	8	7	6	5	4	3	2	1	0	15	14	13	12	11	10	9	8	7	6	5	4	3	2	1	0
1	1	1	0	1	0	0	1	1	0	W	0	(1)	(1)	(0)	(1)	(1)	(1)	(0)	(0)	(0)	(0)	(0)	(0)	(0)	(0)	(0)	(0)	mode			

if CurrentInstrSet() == InstrSet\_ThumbEE then UNPREDICTABLE;  
 wback = (W == '1'); increment = TRUE; wordhigher = FALSE;

## Assembler syntax

SRS{<amode>}{<c>}{<q>} SP{!}, #<mode>

where:

<amode>	is one of:
DB	Decrement Before. The consecutive memory addresses end one word below the address in the base register. Encoding T1.
IA	Increment After. The consecutive memory addresses start at the address in the base register. This is the default. Encoding T2.
<c>, <q>	See <i>Standard assembler syntax fields</i> on page A8-287.
!	Causes the instruction to write a modified value back to the base register (encoded as W = 1). If ! is omitted, the instruction does not change the base register (encoded as W = 0).
<mode>	The number of the mode whose Banked SP is used as the base register. For details of processor modes and their numbers see <i>ARM processor modes</i> on page B1-1139.

SRSIA is a pseudo-instruction for SRSDB, and SRSFD is a pseudo-instruction for SRSDB, referring to their use for pushing data onto Empty Ascending and Full Descending stacks.

## Operation

```

if ConditionPassed() then
    EncodingSpecificOperations();
    if CurrentModeIsHyp() then
        UNDEFINED;
    elseif CurrentModeIsUserOrSystem() then
        UNPREDICTABLE;
    elseif mode == '11010' then // Check for attempt to access Hyp mode ('11010') SP
        UNPREDICTABLE;
    else
        if !IsSecure() then
            // In Non-secure state, check for attempts to access Monitor mode ('10110'), or FIQ when the
            // Security Extensions are reserving the FIQ registers. The definition of UNPREDICTABLE does
            // not permit this to be a security hole.
            if mode == '10110' || (mode == '10001' && NSACR.RFR == '1') then
                UNPREDICTABLE;
            base = Rmode[13,mode];
            address = if increment then base else base-8;
            if wordhigher then address = address+4;
            MemA[address,4] = LR;
            MemA[address+4,4] = SPSR[];
            if wback then Rmode[13,mode] = if increment then base+8 else base-8;
  
```

## Exceptions

Data Abort.

### B9.3.16 SRS (ARM)

Store Return State stores the LR and SPSR of the current mode to the stack of a specified mode. For information about memory accesses see *Memory accesses* on page A8-294.

SRS is:

- UNDEFINED in Hyp mode
- UNPREDICTABLE if:
  - it is executed in User or System mode
  - it attempts to store the Monitor mode SP when in Non-secure state
  - NSACR.RFR is set to 1 and it attempts to store the FIQ mode SP when in Non-secure state
  - if it attempts to store the Hyp mode SP.

#### Encoding A1 ARMv6\*, ARMv7

SRS{<amode>} SP{!}, #<mode>

31	30	29	28	27	26	25	24	23	22	21	20	19	18	17	16	15	14	13	12	11	10	9	8	7	6	5	4	3	2	1	0
1	1	1	1	1	0	0	P	U	1	W	0	(1)	(1)	(0)	(1)	(0)	(0)	(0)	(0)	(0)	(1)	(0)	(1)	(0)	(0)	(0)	mode				

wback = (W == '1'); inc = (U == '1'); wordhigher = (P == U);



## Assembler syntax

SRS{<amode>}{<C>}{<q>} SP{!}, #<mode>

where:

<amode>	is one of:
DA	Decrement After. The consecutive memory addresses end at the address in the base register. Encoded as P = 0, U = 0.
DB	Decrement Before. The consecutive memory addresses end one word below the address in the base register. Encoded as P = 1, U = 0.
IA	Increment After. The consecutive memory addresses start at the address in the base register. This is the default. Encoded as P = 0, U = 1.
IB	Increment Before. ARM instructions only. The consecutive memory addresses start one word above the address in the base register. Encoded as P = 1, U = 1.
<C>, <q>	See <a href="#">Standard assembler syntax fields on page A8-287</a> . In the ARM instruction set, an SRS instruction must be unconditional.
!	Causes the instruction to write a modified value back to the base register (encoded as W = 1). If ! is omitted, the instruction does not change the base register (encoded as W = 0).
<mode>	The number of the mode whose Banked SP is used as the base register. For details of processor modes and their numbers see <a href="#">ARM processor modes on page B1-1139</a> .

SRSFA, SRSEA, SRSFD, and SRSED are pseudo-instructions for SRSIB, SRSIA, SRSDB, and SRSDA respectively, referring to their use for pushing data onto Full Ascending, Empty Ascending, Full Descending, and Empty Descending stacks.

## Operation

```

if ConditionPassed() then
    EncodingSpecificOperations();
    if CurrentModeIsHyp() then
        UNDEFINED;
    elsif CurrentModeIsUserOrSystem() then
        UNPREDICTABLE;
    elsif mode == '11010' then // Check for attempt to access Hyp mode ('11010') SP
        UNPREDICTABLE;
    else
        if !IsSecure() then
            // In Non-secure state, check for attempts to access Monitor mode ('10110'), or FIQ when the
            // Security Extensions are reserving the FIQ registers. The definition of UNPREDICTABLE does
            // not permit this to be a security hole.
            if mode == '10110' || (mode == '10001' && NSACR.RFR == '1') then
                UNPREDICTABLE;
            base = Rmode[13,mode];
            address = if increment then base else base-8;
            if wordhigher then address = address+4;
            MemA[address,4] = LR;
            MemA[address+4,4] = SPSR[];
            if wback then Rmode[13,mode] = if increment then base+8 else base-8;
  
```

## Exceptions

Data Abort.

### B9.3.17 STM (User registers)

In a PL1 mode other than System mode, Store Multiple (user registers) stores multiple User mode registers to consecutive memory locations using an address from a base register. The processor reads the base register value normally, using the current mode to determine the correct Banked version of the register. This instruction cannot writeback to the base register.

STM (User registers) is UNDEFINED in Hyp mode, and UNPREDICTABLE in User or System modes.

**Encoding A1** ARMv4\*, ARMv5T\*, ARMv6\*, ARMv7

STM{<amode>}<c> <Rn>, <registers>^

31	30	29	28	27	26	25	24	23	22	21	20	19	18	17	16	15	14	13	12	11	10	9	8	7	6	5	4	3	2	1	0		
cond		1	0	0	P	U	1	(0)	0	Rn								register_list															

n = UInt(Rn); registers = register\_list; increment = (U == '1'); wordhigher = (P == U);  
 if n == 15 || BitCount(registers) < 1 then UNPREDICTABLE;

## Assembler syntax

STM{<amode>}{<c>}{<q>} <Rn>, <registers>^

where:

<amode>	is one of:
DA	Decrement After. The consecutive memory addresses end at the address in the base register. Encoded as P = 0, U = 0.
ED	Empty Descending. For this instruction, a synonym for DA.
DB	Decrement Before. The consecutive memory addresses end one word below the address in the base register. Encoded as P = 1, U = 0.
FD	Full Descending. For this instruction, a synonym for DB.
IA	Increment After. The consecutive memory addresses start at the address in the base register. This is the default. Encoded as P = 0, U = 1.
EA	Empty Ascending. For this instruction, a synonym for IA.
IB	Increment Before. The consecutive memory addresses start one word above the address in the base register. Encoded as P = 1, U = 1.
FA	Full Ascending. For this instruction, a synonym for IB.
<c>, <q>	See <a href="#">Standard assembler syntax fields on page A8-287</a> .
<Rn>	The base register. This register can be the SP.
<registers>	Is a list of one or more registers, separated by commas and surrounded by { and }. It specifies the set of registers to be stored by the STM instruction. The registers are stored with the lowest-numbered register to the lowest memory address, through to the highest-numbered register to the highest memory address. See also <a href="#">Encoding of lists of ARM core registers on page A8-295</a> .

The pre-UAL syntax STM<c>{<amode>} is equivalent to STM{<amode>}<c>.

## Operation

```

if ConditionPassed() then
    EncodingSpecificOperations();
    if CurrentModeIsHyp() then
        UNDEFINED;
    elsif CurrentModeIsUserOrSystem() then
        UNPREDICTABLE;
    else
        length = 4*BitCount(registers);
        address = if increment then R[n] else R[n]-length;
        if wordhigher then address = address+4;
        for i = 0 to 14
            if registers<i> == '1' then // Store User mode ('10000') register
                MemA[address,4] = Rmode[i, '10000'];
                address = address + 4;
            if registers<15> == '1' then
                MemA[address,4] = PCStoreValue();
  
```

## Exceptions

Data Abort.

### B9.3.18 STRBT, STRHT, and STRT

Even in Secure and Non-secure PL1 modes, stores to memory by these instructions are restricted in the same way as unprivileged stores to memory. The MemA\_unpriv[] and MemU\_unpriv[] pseudocode functions describe this restriction. For more information see [Aligned memory accesses on page B2-1294](#) and [Unaligned memory accesses on page B2-1295](#).

These instructions are UNPREDICTABLE in Hyp mode.

For descriptions of the instructions see:

- [STRBT on page A8-684](#)
- [STRHT on page A8-704](#)
- [STRT on page A8-706](#).

### B9.3.19 SUBS PC, LR (Thumb)

The SUBS PC, LR, #<const> instruction provides an exception return without the use of the stack. It subtracts the immediate constant from LR, branches to the resulting address, and also copies the SPSR to the CPSR.

————— **Note** —————

- The instruction SUBS PC, LR, #0 is equivalent to MOVS PC, LR and ERET.
- For an implementation that includes the Virtualization Extensions, ERET is the preferred disassembly of the T1 encoding defined in this section. Therefore, a disassembler might report an ERET where the original assembler code used SUBS PC, LR, #0.

When executing in Hyp mode:

- the encoding for SUBS PC, LR, #0 is the encoding of the ERET instruction, see [ERET on page B9-1980](#)
- SUBS PC, LR, #<const> with a nonzero constant is UNDEFINED.

SUBS PC, LR, #<const> is UNPREDICTABLE:

- in the cases described in [Restrictions on exception return instructions on page B9-1970](#)
- if it is executed in Debug state.

**Encoding T1** ARMv6T2, ARMv7

SUBS<c> PC, LR, #<imm8> Outside or last in IT block

15	14	13	12	11	10	9	8	7	6	5	4	3	2	1	0	15	14	13	12	11	10	9	8	7	6	5	4	3	2	1	0
1	1	1	1	0	0	1	1	1	1	0	1	(1)	(1)	(1)	(0)	1	0	(0)	0	(1)	(1)	(1)	(1)	imm8							

```

if IsZero(imm8) then SEE ERET;
if CurrentInstrSet() == InstrSet_ThumbEE then UNPREDICTABLE;
if CurrentModeIsHyp() then UNDEFINED; // UNDEFINED in Hyp mode when not ERET
n = 14; imm32 = ZeroExtend(imm8, 32);
if InITBlock() && !LastInITBlock() then UNPREDICTABLE;
  
```

## Assembler syntax

SUBS{<c>}{<q>} PC, LR, #<const>

where:

<c>, <q> See *Standard assembler syntax fields* on page A8-287.

<const> The immediate constant, in the range 0-255.

In the Thumb instruction set, MOVS{<c>}{<q>} PC, LR is a pseudo-instruction for SUBS{<c>}{<q>} PC, LR, #0.

## Operation

```
if ConditionPassed() then
    EncodingSpecificOperations();
    if (CurrentModeIsUserOrSystem() || CurrentInstrSet() == InstrSet_ThumbEE) then
        UNPREDICTABLE;
    else
        operand2 = imm32;
        (result, -, -) = AddWithCarry(R[n], NOT(operand2), '1');
        CPSRWriteByInstr(SPSR[], '1111', TRUE);
        if CPSR<4:0> == '11010' && CPSR.J == '1' && CPSR.T == '1' then
            UNPREDICTABLE;
        else
            BranchWritePC(result);
```

## Exceptions

None.

### B9.3.20 SUBS PC, LR and related instructions (ARM)

The SUBS PC, LR, #<const> instruction provides an exception return without the use of the stack. It subtracts the immediate constant from LR, branches to the resulting address, and also copies the SPSR to the CPSR. The ARM instruction set contains similar instructions based on other data-processing operations, or with a wider range of operands, or both. ARM deprecates using these other instructions, except for MOVS PC, LR.

All of these instructions are:

- UNDEFINED in Hyp mode
- UNPREDICTABLE:
  - in the cases described in [Restrictions on exception return instructions on page B9-1970](#)
  - if executed in Debug state.

#### Encoding A1 ARMv4\*, ARMv5T\*, ARMv6\*, ARMv7

<opc1>S<c> PC, <Rn>, #<const>

<opc2>S<c> PC, #<const>

31	30	29	28	27	26	25	24	23	22	21	20	19	18	17	16	15	14	13	12	11	10	9	8	7	6	5	4	3	2	1	0
cond			0	0	1	opcode			1	Rn			1				imm12														

n = UInt(Rn); imm32 = ARMEExpandImm(imm12); register\_form = FALSE;

#### Encoding A2 ARMv4\*, ARMv5T\*, ARMv6\*, ARMv7

<opc1>S<c> PC, <Rn>, <Rm>{, <shift>}

<opc2>S<c> PC, <Rm>{, <shift>}

<opc3>S<c> PC, <Rn>, #<const>

RRXS<c> PC, <Rn>

31	30	29	28	27	26	25	24	23	22	21	20	19	18	17	16	15	14	13	12	11	10	9	8	7	6	5	4	3	2	1	0
cond			0	0	0	opcode			1	Rn			1				imm5					type	0	Rm							

n = UInt(Rn); m = UInt(Rm); register\_form = TRUE;  
 (shift\_t, shift\_n) = DecodeImmShift(type, imm5);

#### Assembler syntax

SUBS{<c>}{<q>} PC, LR, #<const>	Encoding A1
<opc1>S{<c>}{<q>} PC, <Rn>, #<const>	Encoding A1
<opc1>S{<c>}{<q>} PC, <Rn>, <Rm> {, <shift>}	Encoding A2, deprecated
<opc2>S{<c>}{<q>} PC, #<const>	Encoding A1, deprecated
<opc2>S{<c>}{<q>} PC, <Rm> {, <shift>}	Encoding A2
<opc3>S{<c>}{<q>} PC, <Rn>, #<const>	Encoding A2, deprecated
RRXS{<c>}{<q>} PC, <Rn>	Encoding A2, deprecated

where:

- <c>, <q> See [Standard assembler syntax fields on page A8-287](#).
- <opc1> The operation. <opc1> is one of ADC, ADD, AND, BIC, EOR, ORR, RSB, RSC, SBC, and SUB. ARM deprecates the use of all of these operations except SUB.
- <opc2> The operation. <opc2> is MOV or MVN. ARM deprecates the use of MOV.
- <opc3> The operation. <opc3> is ASR, LSL, LSR, or ROR. ARM deprecates the use of all of these operations.
- <Rn> The first operand register. ARM deprecates the use of any register except LR.
- <const> The immediate constant. See [Modified immediate constants in ARM instructions on page A5-200](#) for the range of available values.

<Rm> The optionally shifted second or only operand register. ARM deprecates the use of any register except LR.

<shift> The shift to apply to the value read from <Rm>. If absent, no shift is applied. [Constant shifts on page A8-291](#) describes the shifts and how they are encoded. ARM deprecates the use of <shift>.

The required operation, <opc1>, <opc2>, <opc3>, or RRRXS, is encoded in the opcode field of the instruction, and in some cases in the imm5 field of encoding T2. For the opcode values for different operations see [Operation](#).

The pre-UAL syntax <opc1><c>S is equivalent to <opc1>S<c>. The pre-UAL syntax <opc2><c>S is equivalent to <opc2>S<c>.

## Operation

```

if ConditionPassed() then
    EncodingSpecificOperations();
    if CurrentModeIsHyp() then
        UNDEFINED;
    elsif CurrentModeIsUserOrSystem() then
        UNPREDICTABLE;
    else
        operand2 = if register_form then Shift(R[m], shift_t, shift_n, APSR.C) else imm32;
        case opcode of
            when '0000' result = R[n] AND operand2; // AND
            when '0001' result = R[n] EOR operand2; // EOR
            when '0010' (result, -, -) = AddWithCarry(R[n], NOT(operand2), '1'); // SUB
            when '0011' (result, -, -) = AddWithCarry(NOT(R[n]), operand2, '1'); // RSB
            when '0100' (result, -, -) = AddWithCarry(R[n], operand2, '0'); // ADD
            when '0101' (result, -, -) = AddWithCarry(R[n], operand2, APSR.C); // ADC
            when '0110' (result, -, -) = AddWithCarry(R[n], NOT(operand2), APSR.C); // SBC
            when '0111' (result, -, -) = AddWithCarry(NOT(R[n]), operand2, APSR.C); // RSC
            when '1100' result = R[n] OR operand2; // ORR
            when '1101' // MOV, if NOT(register_form)
                // Otherwise, ASR, LSL, LSR, ROR, or RRX, and
                // DecodeImmShift() decodes the different shifts
                result = operand2;
            when '1110' result = R[n] AND NOT(operand2); // BIC
            when '1111' result = NOT(operand2); // MVN
        CPSRWriteByInstr(SPSR[], '1111', TRUE);
        // Return to Hyp mode in ThumbEE is UNPREDICTABLE
        if CPSR<4:0> == '11010' && CPSR.J == '1' && CPSR.T == '1' then
            UNPREDICTABLE;
        else
            BranchWritePC(result);
  
```

## Exceptions

None.

### B9.3.21 VMRS

Move to ARM core register from Advanced SIMD and Floating-point Extension System Register moves the value of an extension system register to an ARM core register. When the specified Floating-point Extension System Register is the **FPSCR**, a form of the instruction transfers the **FPSCR**.{N, Z, C, V} condition flags to the **APSR**.{N, Z, C, V} condition flags.

Depending on settings in the **CPACR**, **NSACR**, **HCPTR**, and **FPEXC** registers, and the security state and mode in which the instruction is executed, an attempt to execute a **VMRS** instruction might be **UNDEFINED**, or trapped to Hyp mode. [Summary of general controls of CP10 and CP11 functionality on page B1-1230](#) and [Summary of access controls for Advanced SIMD functionality on page B1-1232](#) summarize these controls.

When these settings permit the execution of floating-point and Advanced SIMD instructions, if the specified Floating-point Extension System Register is not the **FPSCR**, the instruction is **UNDEFINED** if executed in User mode.

In an implementation that includes the Virtualization Extensions, when **HCR.TID0** is set to 1, any **VMRS** access to **FPSID** from a Non-secure PL1 mode, that would be permitted if **HCR.TID0** was set to 0, generates a Hyp Trap exception. For more information, see [ID group 0, Primary device identification registers on page B1-1251](#).

———— **Note** —————

- [VMRS on page A8-954](#) describes the valid application level uses of the **VMRS** instruction
- for simplicity, the **VMRS** pseudocode does not show the possible trap to Hyp mode.

#### Encoding T1/A1 VFPv2, VFPv3, VFPv4, Advanced SIMD

VMRS<c> <Rt>, <spec\_reg>

15	14	13	12	11	10	9	8	7	6	5	4	3	2	1	0	15	14	13	12	11	10	9	8	7	6	5	4	3	2	1	0
1	1	1	0	1	1	1	0	1	1	1	1	reg			Rt		1	0	1	0	(0)	(0)	(0)	1	(0)	(0)	(0)	(0)			
31	30	29	28	27	26	25	24	23	22	21	20	19	18	17	16	15	14	13	12	11	10	9	8	7	6	5	4	3	2	1	0
cond			1	1	1	0	1	1	1	1	reg			Rt		1	0	1	0	(0)	(0)	(0)	1	(0)	(0)	(0)	(0)				

```
t = UInt(Rt);
if t == 13 && CurrentInstrSet() != InstrSet_ARM then UNPREDICTABLE;
if t == 15 && reg != '0001' then UNPREDICTABLE;
```



## Assembler syntax

VMRS{<c>}{<q>} <Rt>, <spec\_reg>

where:

<c>, <q> See [Standard assembler syntax fields on page A8-287](#).

<Rt> The destination ARM core register. This register can be R0-R14.

If <spec\_reg> is FPSCR, it is also permitted to be APSR\_nzcv, encoded as Rt = '1111'. This instruction transfers the **FPSCR**.{N, Z, C, V} condition flags to the **APSR**.{N, Z, C, V} condition flags.

<spec\_reg> Is one of:

FPSID	reg = '0000'
FPSCR	reg = '0001'
MVFR1	reg = '0110'
MVFR0	reg = '0111'
FPEXC	reg = '1000'

If the Common VFP subarchitecture is implemented, see [Subarchitecture additions to the Floating-point Extension system registers on page AppxF-2439](#) for additional values of <spec\_reg>.

The pre-UAL instruction FMSTAT is equivalent to VMRS APSR\_nzcv, FPSCR.

## Operation

```

if ConditionPassed() then
    EncodingSpecificOperations();
    if reg == '0001' then // FPSCR
        CheckVFPEEnabled(TRUE); SerializeVFP(); VFPExcBarrier();
        if t == 15 then
            APSR.N = FPSCR.N; APSR.Z = FPSCR.Z; APSR.C = FPSCR.C; APSR.V = FPSCR.V;
        else
            R[t] = FPSCR;
    else // Non-FPSCR registers are accessible only at PL1 or above and not affected by FPEXC.EN
        CheckVFPEEnabled(FALSE);
        if !CurrentModeIsNotUser() then
            UNDEFINED;
        else
            case reg of
                when '0000' SerializeVFP(); R[t] = FPSID;
                // Pseudocode does not consider possible trap of Non-secure FPSID access to Hyp mode
                // '0001' already handled
                when '001x', '010x' UNPREDICTABLE;
                when '0110' SerializeVFP(); R[t] = MVFR1;
                when '0111' SerializeVFP(); R[t] = MVFR0;
                when '1000' SerializeVFP(); R[t] = FPEXC;
                otherwise SUBARCHITECTURE_DEFINED register access;
  
```

## Exceptions

Undefined Instruction, Hyp Trap.

### B9.3.22 VMSR

Move to Advanced SIMD and Floating-point Extension System Register from ARM core register moves the value of an ARM core register to a Floating-point system register.

Depending on settings in the CPACR, NSACR, HCPTR, and FPEXC registers, and the security state and mode in which the instruction is executed, an attempt to execute a VMSR instruction might be UNDEFINED, or trapped to Hyp mode. *Summary of general controls of CP10 and CP11 functionality on page B1-1230* and *Summary of access controls for Advanced SIMD functionality on page B1-1232* summarize these controls.

When these settings permit the execution of floating-point and Advanced SIMD instructions, if the specified Floating-point Extension System Register is not the FPSCR, the instruction is UNDEFINED if executed in User mode.

———— **Note** —————

*VMSR on page A8-956* describes the valid application level uses of the VMSR instruction.

#### Encoding T1/A1 VFPv2, VFPv3, VFPv4, Advanced SIMD

VMSR<c> <spec\_reg>, <Rt>

15	14	13	12	11	10	9	8	7	6	5	4	3	2	1	0	15	14	13	12	11	10	9	8	7	6	5	4	3	2	1	0
1	1	1	0	1	1	1	0	1	1	1	0	reg				Rt	1	0	1	0	(0)	(0)	(0)	1	(0)	(0)	(0)	(0)			
31	30	29	28	27	26	25	24	23	22	21	20	19	18	17	16	15	14	13	12	11	10	9	8	7	6	5	4	3	2	1	0
cond		1	1	1	0	1	1	1	0	reg				Rt	1	0	1	0	(0)	(0)	(0)	1	(0)	(0)	(0)	(0)					

```
t = UInt(Rt);
if t == 15 || (t == 13 && CurrentInstrSet() != InstrSet_ARM) then UNPREDICTABLE;
```

## Assembler syntax

VMSR{<c>}{<q>} <spec\_reg>, <Rt>

where:

<c>, <q> See *Standard assembler syntax fields* on page A8-287.

<spec\_reg> Is one of:

FPSID reg = '0000'  
 FPSCR reg = '0001'  
 FPEXC reg = '1000'.

If the Common VFP subarchitecture is implemented, see *Subarchitecture additions to the Floating-point Extension system registers* on page AppxF-2439 for additional values of <spec\_reg>.

<Rt> The ARM core register to be transferred to <spec\_reg>.

## Operation

```

if ConditionPassed() then
  EncodingSpecificOperations();
  if reg == '0001' then // FPSCR
    CheckVFPEEnabled(TRUE); SerializeVFP(); VFPEXCBarrier();
    FPSCR = R[t];
  else // Non-FPSCR registers are accessible only at PL1 or above and not affected by FPEXC.EN
    CheckVFPEEnabled(FALSE);
    if !CurrentModeIsNotUser() then
      UNDEFINED;
    else
      case reg of
        when '0000' SerializeVFP(); //FPSID is read-only
        // '0001' already dealt with above
        when "001x", "01xx" UNPREDICTABLE;
        when '1000' SerializeVFP(); FPEXC = R[t];
        otherwise SUBARCHITECTURE_DEFINED register access;
  
```

## Exceptions

Undefined Instruction, Hyp Trap.



# Part C

## **Debug Architecture**



# Chapter C1

## Introduction to the ARM Debug Architecture

This chapter introduces part C of this manual, and the ARM Debug architecture for ARMv7. It contains the following sections:

- *Scope of part C of this manual* on page C1-2020
- *About the ARM Debug architecture* on page C1-2021
- *Security Extensions and debug* on page C1-2025
- *Register interfaces* on page C1-2026.

## C1.1 Scope of part C of this manual

Part C of this manual defines the debug features of ARMv7. It describes the following versions of the Debug architecture:

- v7 Debug, first defined in issue A of this manual
- v7.1 Debug, first defined in issue C.a of this manual, and required by any ARMv7 implementation that includes the Virtualization Extensions.

Any processor that implements the ARMv7 architecture must implement a version of ARMv7 Debug.

———— **Note** —————

In issues A and B of this manual, this chapter included information about:

- The debug architectures for ARMv6, v6 Debug and v6.1 Debug. This information is now in [Appendix M v6 Debug and v6.1 Debug Differences](#).
- Secure User halting debug, see [Support for Secure User halting debug](#).

---

*Major differences between the ARMv6 and ARMv7 Debug architectures on page AppxM-2548 summarizes the features introduced in v7 Debug.*

### C1.1.1 Support for Secure User halting debug

On a processor that includes the Security Extensions, *Secure User halting debug* (SUHD) refers to permitting those debug events that cause entry to Debug state in Secure User mode when invasive debug is not permitted in Secure PL1 modes. For a processor that implements the Security Extensions, the architectural requirements for SUHD are:

**v6.1 Debug** Required.

**v7 Debug** A permitted option. When v7 Debug is implemented, ARM deprecates any use of SUHD.

**v7.1 Debug** Not permitted.

Part C of this manual describes only ARMv7 debug implementations that do not implement SUHD. [Appendix N Secure User Halting Debug](#) describes SUHD.



## C1.2 About the ARM Debug architecture

ARM processors implement two types of debug support:

- Invasive debug** All debug features that permit modification of processor state. For more information, see [Invasive debug](#).
- Non-invasive debug** All debug features that permit data and program flow observation. For more information, see [Non-invasive debug on page C1-2022](#).

The following sections introduce invasive and non-invasive debug. [Summary of the ARM debug component descriptions on page C1-2024](#) gives a summary of the rest of part C of this manual.

### C1.2.1 Invasive debug

The invasive debug component of the Debug architecture is intended primarily for run-control debugging.

#### ———— Note —————

This part of this manual often refers to invasive debug simply as debug. For example, debug events, debug exceptions, and Debug state are all part of the invasive debug component.

Software can use the programmers' model to manage and control *debug events*. Watchpoints and breakpoints are two examples of debug events. [Chapter C3 Debug Events](#) describes these events.

A debugger programs the *Debug Status and Control Register*, [DBGDSCR](#), to configure which debug-mode is used:

#### Monitor debug-mode

In Monitor debug-mode, a debug event causes a *debug exception* to occur:

- a debug exception that relates to instruction execution generates a Prefetch Abort exception
- a debug exception that relates to a data access generates a Data Abort exception.

[Chapter C4 Debug Exceptions](#) describes these exceptions.

#### Halting debug-mode

In Halting debug-mode, a debug event causes the processor to enter *Debug state*. In Debug state, the processor stops executing instructions from the location indicated by the program counter, but is instead controlled through the external debug interface, in particular using the *Instruction Transfer Register*, [DBGITR](#). This enables an external agent, such as a debugger, to interrogate processor context, and control all subsequent instruction execution. Because the processor is stopped, it ignores the system and cannot service interrupts.

[Chapter C5 Debug State](#) describes this state.

A debug solution can use a mixture of the two methods, for example to support an OS or RTOS with both:

- *Running System Debug* (RSD) using Monitor debug-mode
- Halting debug-mode support available as a fallback for system failure and boot time debug.

The architecture supports the ability to switch between these two debug-modes.

When no debug-mode is selected, debug is restricted to monitor solutions. Such a monitor might use standard system features, such as a UART or Ethernet connection, to communicate with a debug host. Alternatively, it might use the *Debug Communications Channel* (DCC) as an out-of-band communications channel to the host. Using the DCC minimizes the system resources required for debug.

The Debug architecture provides a software interface that includes:

- a *Debug Identification Register*, [DBGDIDR](#)
- status and control registers, including the *Debug Status and Control Register*, [DBGDSCR](#)
- hardware breakpoint and watchpoint support
- the DCC
- features to support the debug of reset, powerdown and the operating system.

The Debug architecture requires an external debug interface that supports the debug programmers' model.

### Description of invasive debug features

The following chapters describe the invasive debug component:

- [Chapter C2 Invasive Debug Authentication](#)
- [Chapter C3 Debug Events](#)
- [Chapter C4 Debug Exceptions](#)
- [Chapter C5 Debug State](#).

In addition, see:

- [Chapter C6 Debug Register Interfaces](#) for a description of the register interfaces to the debug components
- [Chapter C11 The Debug Registers](#) for descriptions of the registers that configure and control debug operations
- [Appendix A Recommended External Debug Interface](#) for a description of the recommended external interface to the debug components.

### C1.2.2 Non-invasive debug

Non-invasive debug includes all debug features that permit data and program flow to be observed, but that do not permit modification of the main processor state.

The Debug architecture defines the following areas of non-invasive debug:

- Instruction trace and, in some implementations, data trace. Trace support is typically implemented using a trace macrocell, see [Trace](#).
- Sample-based profiling, see [Sample-based profiling on page C1-2023](#).
- Performance monitors, see [Performance monitors on page C1-2023](#).

A processor implementation might include other forms of non-invasive debug.

[Chapter C9 Non-invasive Debug Authentication](#) describes the authentication of non-invasive debug operations.

### Trace

Trace support is an architecture extension. This manual describes such an extension as a trace macrocell. A trace macrocell constructs a real-time trace stream corresponding to the operation of the processor. How the trace stream is handled is IMPLEMENTATION DEFINED. For example, the trace stream might be:

- stored locally in an *Embedded Trace Buffer* (ETB) for independent download and analysis
- exported directly through a trace port to a *Trace Port Analyzer* (TPA) and its associated host-based trace debug tools.

Typically, use of a trace macrocell is non-invasive. Development tools can connect to the trace macrocell, configure it, capture trace and download the trace without affecting the operation of the processor in any way. A trace macrocell provides an enhanced level of runtime system observation and debug granularity. It is particularly useful when:

- Stopping the processor affects the behavior of the system.
- By the time a problem is detected the visible state is insufficient to be able to determine its cause. Trace provides a mechanism for system logging and back tracing of faults.

Trace might also perform analysis of software running on the processor, such as performance analysis or code coverage analysis.

Typically, a trace architecture defines:

- the trace macrocell programmers' model
- permitted trace protocol formats
- the physical trace port connector.

The following documents define the ARM trace architectures:

- *Embedded Trace Macrocell Architecture Specification*
- *CoreSight Program Flow Trace Architecture Specification*.

The ARM trace architectures have a common identification mechanism. This means development tools can detect which architecture is implemented.

## Sample-based profiling

Sample-based profiling is an OPTIONAL non-invasive component of the Debug architecture, that enables debug software to profile a program. For more information, see [Chapter C10 Sample-based Profiling](#).

## Performance monitors

The ARMv7 architecture defines an OPTIONAL Performance Monitors Extension. The basic form of this is:

- A cycle counter, with the ability to count every cycle or every sixty-fourth cycle.
- A number of event counters. Software can program the event counted by each counter:
  - Previous implementations provided up to four counters
  - In ARMv7, space is provided for up to 31 counters. The actual number of counters is IMPLEMENTATION DEFINED, and an identification mechanism is provided.
- Controls for
  - enabling and resetting counters
  - indicating overflows
  - enabling interrupts on overflow.

The cycle counter can be enabled independently from the event counters.

The set of events that can be monitored is divided into:

- events that are likely to be consistent across many microarchitectures
- other events, that are likely to be implementation-specific.

As a result, the architecture defines a common set of events to be used across many microarchitectures, and reserves a large space for IMPLEMENTATION DEFINED events. The full set of events for any given implementation is IMPLEMENTATION DEFINED. There is no requirement to implement any of the common set of events, but the numbers allocated for the common set of events must not be used except as defined.

[Chapter C12 The Performance Monitors Extension](#) describes this extension.

### C1.2.3 Summary of the ARM debug component descriptions

Table C1-1 shows the main debug components, and where they are described.

**Table C1-1 v7 Debug components**

Component	Debug version	Status	Type	Reference
Run-control Debug	v7 and v7.1	Required	Invasive	<a href="#">Chapter C2 Invasive Debug Authentication</a>
				<a href="#">Chapter C3 Debug Events</a>
				<a href="#">Chapter C4 Debug Exceptions</a>
				<a href="#">Chapter C5 Debug State</a>
				<a href="#">Chapter C6 Debug Register Interfaces</a>
Trace	v7 and v7.1	Optional	Non-invasive <sup>a</sup>	<a href="#">Trace on page C1-2022</a>
Sample-based profiling	v7	OPTIONAL	Non-invasive <sup>a</sup>	<a href="#">Chapter C10 Sample-based Profiling</a>
	v7.1	Required		
Performance Monitors	v7 and v7.1	OPTIONAL	Non-invasive <sup>a</sup>	<a href="#">Chapter C12 The Performance Monitors Extension</a>

a. For information about authentication of these components see [Chapter C9 Non-invasive Debug Authentication](#).

For more information, see:

- [Chapter C11 The Debug Registers](#)
- [Appendix A Recommended External Debug Interface](#).

## C1.3 Security Extensions and debug

The Security Extensions include independent controls of when:

- Debug events are enabled. The options are:
  - in all processor modes, in both Secure and Non-secure security state
  - only in Non-secure state
  - in Non-secure state and, if it will not cause entry to Debug state, in Secure User mode.
- Non-invasive debug is enabled. The options are:
  - in all processor modes, in both Secure and Non-secure security state
  - only in Non-secure state
  - in Non-secure state and in Secure User mode.

This is controlled by two bits in the Secure Debug Enable Register, and four input signals in the recommended external debug interface:

- In the Secure Debug Enable Register:
  - the *Secure User Invasive Debug Enable* bit, **SDER.SUIDEN**
  - the *Secure User Non-invasive Debug Enable* bit, **SDER.SUNIDEN**
- in the recommended external debug interface:
  - the *Debug Enable* signal, **DBGEN**
  - the *Non-Invasive Debug Enable* signal, **NIDEN**
  - the *Secure PL1 Invasive Debug Enable* signal, **SPIDEN**
  - the *Secure PL1 Non-Invasive Debug Enable* signal, **SPNIDEN**.

For more information, see:

- [Chapter C2 Invasive Debug Authentication](#)
- [Chapter C9 Non-invasive Debug Authentication](#)
- Secure Debug Enable Register, [SDER](#) for details of the SUIDEN and SUNIDEN bits
- [Authentication signals on page AppxA-2338](#) for details of the **DBGEN**, **NIDEN**, **SPIDEN** and **SPNIDEN** signals.

## C1.4 Register interfaces

This section introduces the debug register interfaces defined by v7 Debug and v7.1 Debug. The most important distinction is between:

- the external debug interface, that defines how an external debugger can access the debug resources
- the processor interface, that describes how an ARMv7 processor can access its own debug resources.

ARM strongly recommends an external debug interface based on the *ARM Debug Interface v5 Architecture Specification* (ADIV5). This interface supports external debug over powerdown of the processor.

Although the ADIV5 interface is not required for compliance with ARMv7, the ARM debug tools require this interface to be implemented.

ADIV5 supports both a JTAG wire interface and a low pin-count *Serial Wire Debug* (SWD) interface. The ARM debug tools support either wire interface.

An ADIV5 interface enables a debug object, such as an ARM processor, to abstract a set of resources as a memory-mapped peripheral. Accesses to debug resources are made as 32-bit read or write transfers. The debug architecture supports debug of powerdown by permitting accesses to certain resources to return an error response if the resource is unavailable, just as a memory-mapped peripheral can return a slave-generated error response in exceptional circumstances.

The debug architecture requires that some debug registers are accessible to software executing on the processor, so that the debug architecture can be used by a self-hosted debug monitor. To meet this requirement:

- v7.1 Debug** Requires these debug registers to be accessible using CP14 register accesses.
- v7 Debug** Requires a subset of these debug registers to be accessible using CP14 accesses, and the remainder of these registers to be accessible from one or both of the following:
  - the CP14 interface
  - a memory-mapped debug register interface.

For more information, see [Chapter C6 Debug Register Interfaces](#).

If an implementation includes an optional trace macrocell, the appropriate trace architecture specification defines the interface to the trace macrocell registers. The ARM trace macrocell architectures, referred to in [Trace on page C1-2022](#), define optional CP14 and memory-mapped interfaces to the registers. v7 Debug requires that, if an ARM trace macrocell implements the CP14 register interface, the v7 Debug implementation must provide CP14 access to all the registers for which [Table C6-5 on page C6-2128](#) has a *Yes* entry in the *CP14 or MM* column.

ARM recommends that, if an implementation includes a memory-mapped interface to either the trace registers or the debug registers, it implements memory-mapped interfaces to both sets of registers.

The OPTIONAL Performance Monitors Extension:

- requires a CP15 register interface
- also defines an optional memory-mapped register interface.

# Chapter C2

## Invasive Debug Authentication

This chapter describes the authentication controls on invasive debug operations. It contains the following sections:

- [About invasive debug authentication on page C2-2028](#)
- [Invasive debug with no Security Extensions on page C2-2029](#)
- [Invasive debug with the Security Extensions on page C2-2031](#)
- [Invasive debug authentication security considerations on page C2-2033.](#)

———— **Note** —————

For information about using the interface to control non-invasive debug see [Chapter C9 Non-invasive Debug Authentication](#).

This chapter describes only ARMv7 debug implementations that do not implement Secure User Halting (SUHD). [Appendix N Secure User Halting Debug](#) describes SUHD.

---

## C2.1 About invasive debug authentication

Debug events include software and halting debug events. [About debug events on page C3-2036](#) gives an overview of all debug events.

Invasive debug authentication controls whether an debug event:

- causes the processor to enter Debug state
- generates a debug exception
- is ignored
- becomes pending.

See [Chapter C3 Debug Events](#) for information on how debug events are generated, and their effects.

---

### Note

- The recommended external debug interface provides an authentication interface that controls both invasive debug and non-invasive debug, as described in [Authentication signals on page AppxA-2338](#). This chapter describes how you can use this interface to control invasive debug. For more information about using the authentication signals see [Changing the authentication signals on page AppxA-2338](#).
- As well as the authentication controls, the effect of debug events can be changed by the OS Lock and, in v7.1 Debug, the OS Double Lock. See [Chapter C7 Debug Reset and Powerdown Support](#) for details.

---

Invasive debug authentication can be controlled dynamically, meaning that the effect of a debug event can change while the processor is running, or when the processor is in Debug state.

The following signals, register fields, and processor states control invasive debug authentication:

**DBGEN** The Debug Enable signal enables invasive debug.

**SPIDEN** In an implementation that includes the Security Extensions, the Secure PL1 Invasive Debug Enable signal enables debug events in Secure PL1 modes.

#### **DBGDSCR.HDBGen**

Enables Halting debug-mode.

#### **DBGDSCR.MDBGen**

Enables Monitor debug-mode.

#### **SDER.SUIDEN**

In an implementation that includes the Security Extensions, when Monitor debug-mode is selected, the Secure User Invasive Debug enable bit enables debug events in the Secure PL0 mode.

**Privilege level** In an implementation that includes the Security Extensions, the privilege level of source of the debug event can affect how the debug event is handled.

If the implementation also includes the Virtualization Extensions, then debug events at PL2 are handled differently in Monitor debug-mode.

**Security state** In an implementation that includes the Security Extensions, the security state of the processor affects how the debug event is handled.

The following sections show how the controls are used, with and without the Security Extensions:

- [Invasive debug with no Security Extensions on page C2-2029](#)
- [Invasive debug with the Security Extensions on page C2-2031](#).



## C2.2 Invasive debug with no Security Extensions

If an implementation does not include the Security Extensions, the **DBGEN** signal controls whether invasive debug is enabled or not:

- If **DBGEN** is LOW, all Software and Halting debug events are disabled, except the BKPT instruction debug event, which remains enabled and generates a debug exception.
- If **DBGEN** is HIGH, all Software and Halting debug events are enabled.

The result of a debug event depends on the current debug-mode:

### Halting debug-mode

All debug events cause the processor to enter Debug state.

### Monitor debug-mode

Halting debug events cause the processor to enter Debug state.

Software debug events generate a debug exception.

### No debug-mode set

Halting debug events cause the processor to enter Debug state.

The BKPT instruction debug event generates a debug exception.

All other Software debug events are ignored.

See [Chapter C3 Debug Events](#) for more information on how debug events are defined, and the types of debug exceptions that are generated.

See [Chapter C7 Debug Reset and Powerdown Support](#) for details of how the OS Lock and OS Double Lock can affect the outcome of a debug event.

[Figure C2-1 on page C2-2030](#) shows how **DBGEN** and the debug-mode, configured by the **DBGDSCR**.{MDBGen, HDBGen} bits, determine the outcome of an debug event.

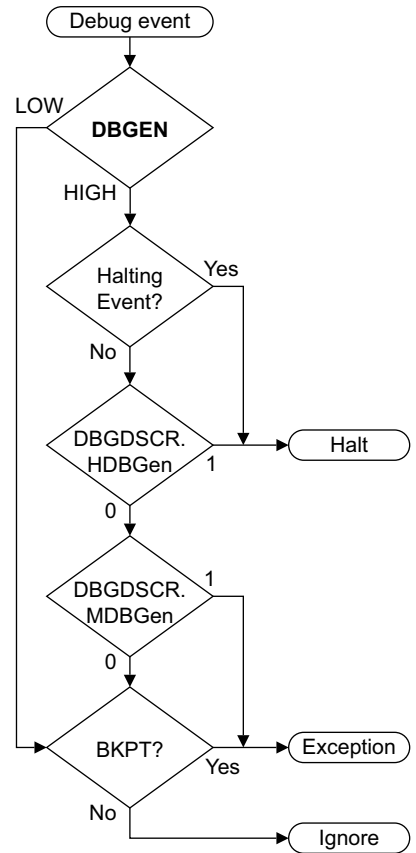

Figure C2-1 Invasive debug authentication with no Security Extensions

## C2.3 Invasive debug with the Security Extensions

If an implementation includes the Security Extensions, the **DBGEN** signal controls whether invasive debug is enabled or not:

- If **DBGEN** is LOW, all Software and Halting debug events are disabled, except the BKPT instruction debug event, which remains enabled and generates a debug exception.
- If **DBGEN** is HIGH, the effect of a debug event is determined by the **SPIDEN** signal, **SDER.SUIDEN**, and the privilege level and security state of the processor.

When **DBGEN** is HIGH, the result of a debug event also depends on the current debug-mode and the type of debug event, as shown in the following sections.

See [Chapter C3 Debug Events](#) for more information on how debug events are defined, and the types of debug exceptions that are generated.

See [Chapter C7 Debug Reset and Powerdown Support](#) for details of how the OS Lock and OS Double Lock can affect the outcome of a debug event.

### C2.3.1 Halting debug events

A Halting debug event causes the processor to enter Debug state, except when the processor is in Secure state and **SPIDEN** is LOW. In this case the Halting debug event becomes pending. See [Halting debug events on page C3-2073](#) for details on how pending events are handled.

### C2.3.2 BKPT instruction debug event

A BKPT instruction causes the processor to enter Debug state in the following cases:

- in Halting debug-mode, in Non-secure state, at any privilege level including PL2
- in Halting debug-mode, in Secure state, and **SPIDEN** is HIGH.

Otherwise, a BKPT instruction generates a debug exception.

### C2.3.3 Other Software debug events

The results of the Breakpoint, Watchpoint, and Vector catch debug events depend on the debug-mode, as shown below:

#### Halting debug-mode

The other Software debug events cause the processor to enter Debug state, except when in Secure state, and **SPIDEN** is LOW, when the events are ignored.

#### Monitor debug-mode

The other Software debug events generate a debug exception, apart from the following cases:

- in PL2, the event is ignored
- in PL1, in Secure state, and **SPIDEN** is LOW, the event is ignored
- in PL0, in Secure state, **SPIDEN** is LOW, and **SDER.SUIDEN**==0, the event is ignored.

#### No debug-mode set

The other Software debug events are ignored.

### C2.3.4 Summary of invasive debug authentication with the Security Extensions

Figure C2-2 shows how **DBGEN** and other settings determine the outcome of a debug event.

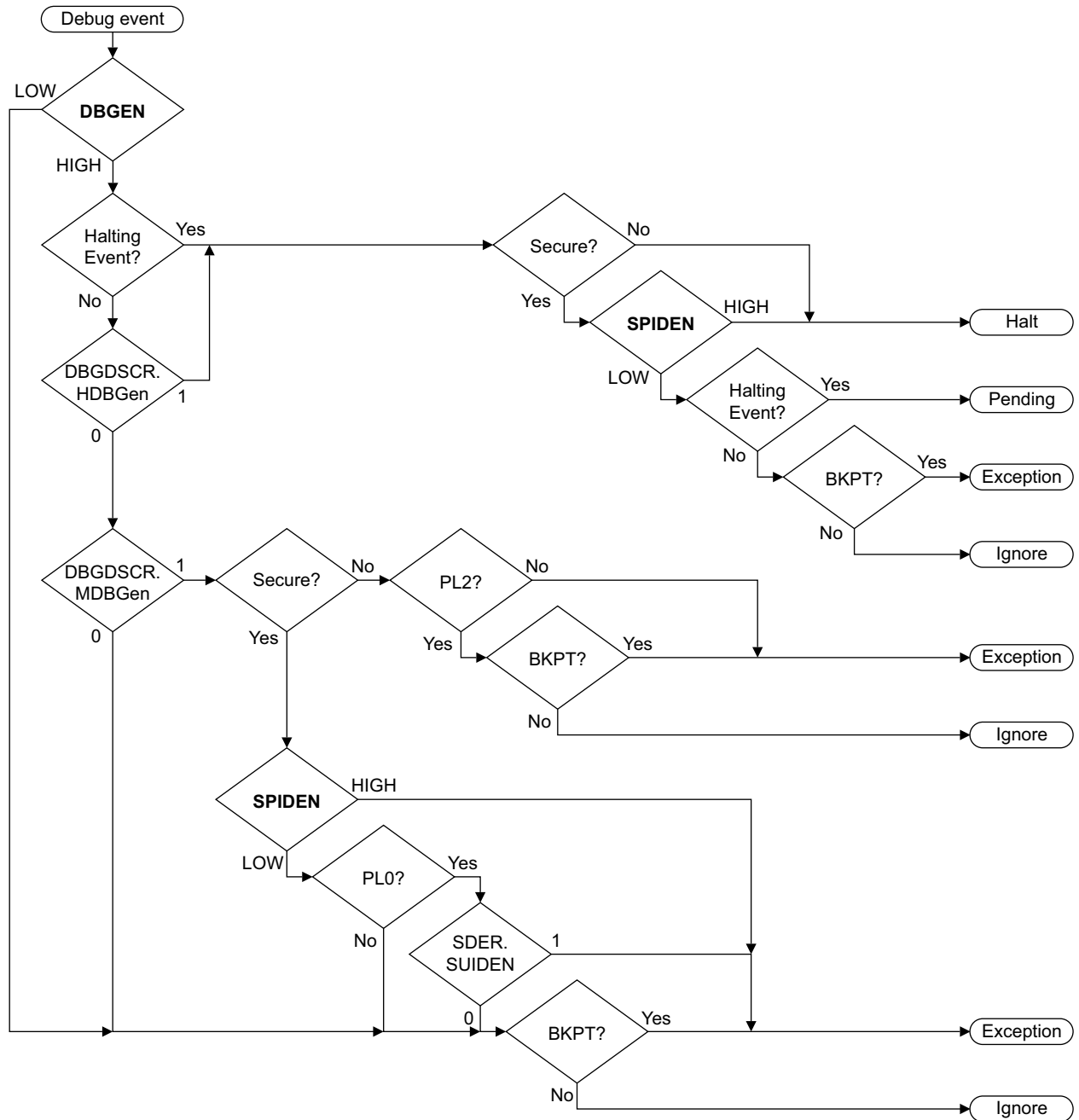

Figure C2-2 Invasive debug authentication with the Security Extensions

## C2.4 Invasive debug authentication security considerations

Invasive and non-invasive debug authentication mean a developer can protect Secure processing from direct observation or invasion by a debugger that they do not trust.

———— **Note** ————

System designers must be aware that security attacks can be aided by the invasive and non-invasive debug facilities. For example, Debug state or the `DBGDSCR.INTdis` bit might be used for a denial of service attack, and the Non-secure performance monitors might be used for measuring the side-effects of Secure processing on Non-secure software.

ARM recommends that, where such attacks are a concern, invasive and non-invasive debug are disabled in all modes. However system designers must be aware of the limitations on the protection that debug authentication can provide, because similar attacks can be made by running malicious software on the processor in Non-secure state.

———— **Caution** ————

When Secure debugging is enabled, Secure operations are visible to the external debugger, and in some cases to software running in Non-secure state.

ARM recommends that devices are split into development and production devices:

- Development devices can have secure debugging enabled by authorized developers. All secure data must be replaced by test data suitable for development purposes, where there are no security issues if the test data is disclosed.
- Production devices can never have secure debugging enabled. These devices are loaded with the real secure data.

For more information about the authentication interface and its control, see the *CoreSight Architecture Specification*.



# Chapter C3

## Debug Events

This chapter describes debug events. Debug events trigger invasive debug operations. It contains the following sections:

- *About debug events on page C3-2036*
- *BKPT instruction debug events on page C3-2038*
- *Breakpoint debug events on page C3-2039*
- *Watchpoint debug events on page C3-2057*
- *Vector catch debug events on page C3-2065*
- *Halting debug events on page C3-2073*
- *Generation of debug events on page C3-2074*
- *Debug event prioritization on page C3-2076*
- *Pseudocode details of Software debug events on page C3-2078.*

## C3.1 About debug events

A debug event can be either:

- A Software debug event, which is one of the following:
  - BKPT instruction** Causes a software breakpoint to occur. For more information, see [BKPT instruction debug events on page C3-2038](#)
  - Breakpoint** Based on instruction address match, instruction address mismatch, or context match. For more information, see [Breakpoint debug events on page C3-2039](#).
  - Watchpoint** Based on data address match. For more information, see [Watchpoint debug events on page C3-2057](#).
  - Vector catch** Trap of exceptions based on vector address or exception type. For more information, see [Vector catch debug events on page C3-2065](#).

See also [Pseudocode details of Software debug events on page C3-2078](#).

- A Halting debug event, which is one of the following:
  - External Debug Request** The system requests the processor to enter Debug state.
  - Halt Request** The debugger requests the processor to enter Debug state by writing to the [DBGDRCR.HRQ](#), Halt request bit.
  - OS Unlock Catch** The OS Lock is unlocked. This event is enabled in [DBGECR](#). See [Halting debug events on page C3-2073](#) for more information.

A processor responds to a debug event in one of the following ways:

- Ignores the debug event.
- Takes a debug exception, see [Chapter C4 Debug Exceptions](#).
- Enters Debug state, see [Chapter C5 Debug State](#).
- Marks the event as pending. This only occurs when invasive debug is enabled, but entering Debug state is not permitted. See [Halting debug events on page C3-2073](#) for more information.

The response depends on whether invasive debug is enabled, and the debug-mode selected. This is shown in [Table C3-1](#) and in [Figure C3-1 on page C3-2037](#). In an implementation that includes the Security Extensions, the response is changed by the security settings. See [Invasive debug with the Security Extensions on page C2-2031](#) for details.

**Table C3-1 Processor behavior on debug events**

Event	Invasive debug disabled	Invasive debug enabled, debug-mode:		
		None	Monitor	Halting
BKPT	Debug exception	Debug exception	Debug exception	Debug state entry
Breakpoint, Watchpoint, or Vector catch	Ignored	Ignored	Debug exception	Debug state entry
Halting	Ignored	Debug state entry	Debug state entry	Debug state entry

For more detailed information on setting the configuration and debug event behavior, see [Generation of debug events on page C3-2074](#).

See [Chapter C7 Debug Reset and Powerdown Support](#) for details of how the OS Lock and OS Double Lock can affect the outcome of a debug event.



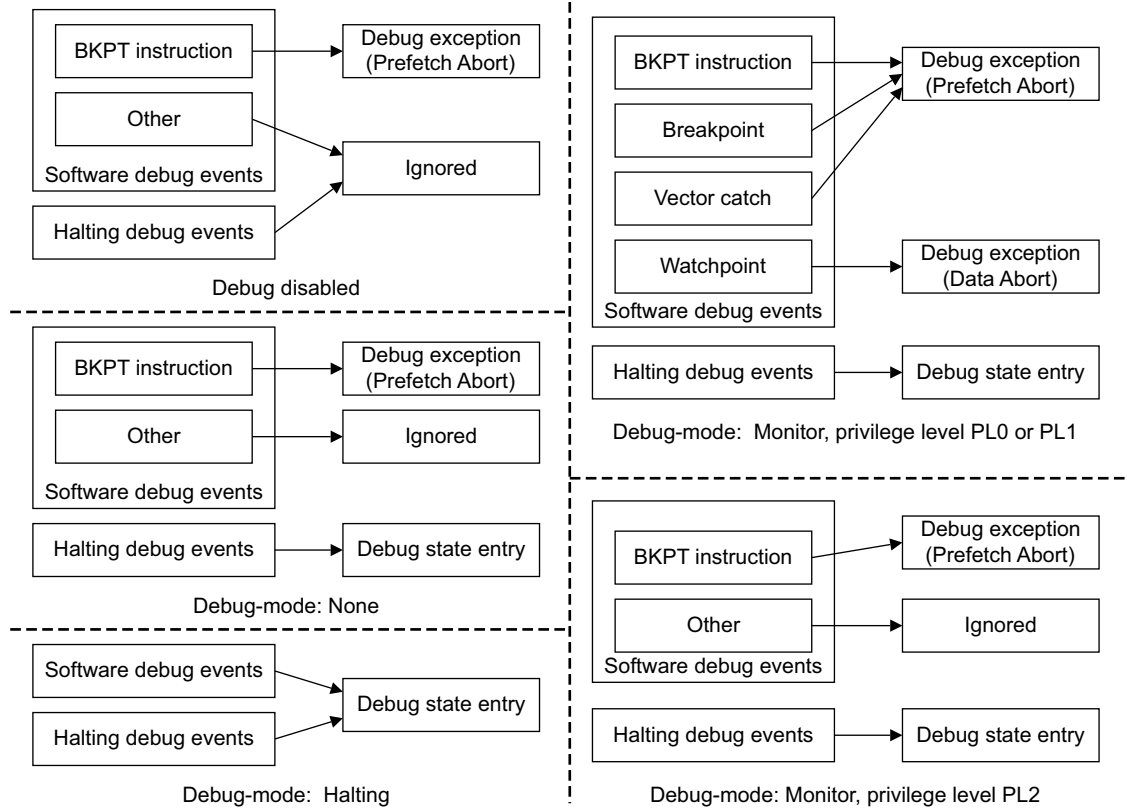

**Figure C3-1 Processor behavior on debug events**

*Avoiding debug exceptions that might cause UNPREDICTABLE behavior on page C4-2090* describes cases where a debugger, or a debug monitor, must be careful not to define Software debug events that might cause UNPREDICTABLE behavior.

## C3.2 BKPT instruction debug events

A BKPT instruction debug event occurs when a BKPT instruction is committed for execution. BKPT is an unconditional instruction.

BKPT instruction debug events are synchronous. That is, the debug event acts like an exception that cancels the BKPT instruction.

A BKPT instruction debug event generates a Prefetch Abort exception, except when Halting debug-mode is enabled, when a BKPT instruction debug event causes the processor to enter Debug state. For more information, see [Generation of debug events on page C3-2074](#) and [Chapter C5 Debug State](#).

On a BKPT instruction debug event, the `DBGDSCR.MOE`, Method of debug entry, field is set to BKPT instruction debug event. See [DBGDSCR, Debug Status and Control Register on page C11-2241](#).

For details of the BKPT instruction and its encodings in the ARM and Thumb instruction sets see [BKPT on page A8-346](#).

### C3.3 Breakpoint debug events

To define a Breakpoint debug event, a debugger programs two or three registers to create a *breakpoint*. Each breakpoint comprises:

- a *Breakpoint Control Register*, [DBGBCR](#), that holds control information for the breakpoint
- a *Breakpoint Value Register*, [DBGBVR](#), that holds the value used in breakpoint matching. This can be an instruction address or a value for Context matching
- optionally, in an implementation that includes the Virtualization Extensions, a *Breakpoint Extended Value Register*, [DBGXVR](#), that holds a *Virtual machine identifier* (VMID) for Context matching.

The number of breakpoints that can be created is specified by the [DBGDIDR](#).BRPs field, and can be between 2 and 16. See [DBGDIDR, Debug ID Register on page C11-2229](#) for details.

For each breakpoint, the associated registers are numbered, from 0 to 15, for example, [DBGBCR3](#), [DBGBVR3](#), and optionally, [DBGXVR3](#) define breakpoint 3. For details of the breakpoint registers see:

- [DBGBVR, Breakpoint Value Registers on page C11-2216](#)
- [DBGBCR, Breakpoint Control Registers on page C11-2211](#)
- [DBGXVR, Breakpoint Extended Value Registers on page C11-2217](#).

A debugger can define a Breakpoint debug event:

- Based on a comparison of an instruction address with the value held in a [DBGBVR](#). The address in the [DBGBVR](#) must be the virtual address of the instruction.
- Based on a comparison of one or both of:
  - the Context ID with the value held in a [DBGBVR](#)
  - the VMID with the value held in a [DBGXVR](#).

For more information, see [Context matching comparisons for debug event generation on page C3-2051](#).

Some breakpoints might not support Context matching. The [DBGDIDR](#).CTX\_CMPs field specifies the number of breakpoints that support Context matching.

- By linking one breakpoint to a second breakpoint, to define a single Breakpoint debug event. One breakpoint defines an instruction address match, and the second breakpoint defines a Context match.

In all cases, the [DBGBCR](#) defines some additional conditions that must be met for the breakpoint to generate a Breakpoint debug event, including whether the breakpoint is enabled.

The terms *hit* and *miss* describe whether the conditions defined in the breakpoint are met:

- a hit occurs when the conditions are met
- a miss occurs when a condition is not met, meaning the processor does not generate a debug event.

Hit and miss can also describe part of the defined conditions, for example the required address comparison either hits or misses.

The following sections describe Breakpoint debug events:

- [Generation of Breakpoint debug events on page C3-2040](#)
- [Breakpoint types defined by the DBGBCR on page C3-2040](#)
- [Conditions for debug event generation defined by the DBGBCR on page C3-2044](#)
- [Byte address selection and masking defined by the DBGBCR on page C3-2045](#)
- [Instruction address comparisons for debug event generation on page C3-2046](#)
- [Context matching comparisons for debug event generation on page C3-2051](#)
- [Linked comparisons for debug event generation on page C3-2053](#)
- [Summary of breakpoint generation options on page C3-2055](#).

### C3.3.1 Generation of Breakpoint debug events

For each instruction in the program flow, the debug logic tests all the breakpoints. For each breakpoint, the debug logic generates a Breakpoint debug event only if all of the following apply:

- When the breakpoint is tested, the conditions specified in the [DBGBCR](#) are met, see *Conditions for debug event generation defined by the DBGBCR on page C3-2044*.
- The comparison with the value in the [DBGBVR](#) is successful.
- If the breakpoint is linked to a second breakpoint, the comparison made by the second breakpoint is successful.
- The instruction is committed for execution.

———— **Note** —————

The processor tests for any possible Breakpoint debug events before executing an instruction. The debug logic might test a breakpoint when an instruction is fetched speculatively. However, it does not generate a Breakpoint debug event if the instruction is not committed for execution.

If all of these conditions are met, the debug logic generates the Breakpoint debug event regardless of whether the instruction passes its condition code check. The debug logic generates the debug event regardless of the type of instruction.

For more information about the possible comparisons, see *Breakpoint types defined by the DBGBCR*.

Breakpoint debug events are synchronous. That is, the debug event acts like an exception that cancels the breakpointed instruction.

When invasive debug is enabled and Monitor debug-mode is selected, and if debug events are permitted, a Breakpoint debug event generates a Prefetch Abort exception. For more information, see *Generation of debug events on page C3-2074*.

When invasive debug is enabled and Halting debug-mode is selected, and if Breakpoint debug events are permitted, a Breakpoint debug event causes the processor to enter Debug state. See *Chapter C5 Debug State*.

On a Breakpoint debug event, the [DBGDSCR.MOE](#), Method of debug entry, field is set to Breakpoint debug event. See *DBGDSCR, Debug Status and Control Register on page C11-2241*.

### C3.3.2 Breakpoint types defined by the DBGBCR

The different types of breakpoint, and how breakpoints can be linked, are controlled by the following field in the [DBGBCR](#):

#### Breakpoint type, BT

Defines the breakpoint type, that can be:

- an instruction address match
- an instruction address mismatch
- a Context match.

In addition, an instruction address match or mismatch breakpoint can be linked to a Context match breakpoint. The Breakpoint type specifies if the breakpoint is unlinked or linked.

The supported BT values and associated Breakpoint types are:

#### 0b0000, Unlinked instruction address match

Generation of the breakpoint depends on both:

- the [DBGBCR](#). {SSC, HMC, PMC} controls described in *Conditions for debug event generation defined by the DBGBCR on page C3-2044*
- a successful address match comparison, as described in *Instruction address comparisons for debug event generation on page C3-2046*.

This breakpoint is not linked to any other breakpoint or watchpoint. `DBGBCR.LBN` must be programmed to `0b0000`, otherwise the generation of Breakpoint debug events by this breakpoint is UNPREDICTABLE.

#### 0b0001, Linked instruction address match

Generation of a breakpoint depends on all of:

- the `DBGBCR`.{SSC, HMC, PMC} controls described in *Conditions for debug event generation defined by the DBGBCR on page C3-2044*
- a successful address match comparison using the `DBGBVR` for this breakpoint, as described in *Instruction address comparisons for debug event generation on page C3-2046*
- a successful context match defined by the breakpoint indicated by `DBGBCR.LBN`.

#### ———— Note —————

This BT value is used to program the breakpoint that defines the instruction address match.

For more information, see *Linked comparisons for debug event generation on page C3-2053*.

#### 0b0010, Unlinked Context ID match

Generation of the breakpoint depends on both:

- the `DBGBCR`.{SSC, HMC, PMC} controls described in *Conditions for debug event generation defined by the DBGBCR on page C3-2044*
- a successful Context ID match, as described in *Context matching comparisons for debug event generation on page C3-2051*.

This breakpoint is not linked to any other breakpoint or watchpoint. `DBGBCR.LBN` must be programmed to `0b0000`, otherwise the generation of Breakpoint debug events by this breakpoint is UNPREDICTABLE.

`DBGBCR.BAS` must be programmed to `0b1111`, otherwise the generation of Breakpoint debug events by this breakpoint is UNPREDICTABLE.

See *UNPREDICTABLE cases when Monitor debug-mode is selected on page C3-2045* for additional restrictions for this type of breakpoint when using Monitor debug-mode.

#### 0b0011, Linked Context ID match

Either:

- generation of a breakpoint depends on both:
  - a successful instruction address match, or a successful instruction address mismatch, defined by a breakpoint that is linked to this breakpoint
  - a successful Context ID match defined by this breakpoint
- generation of a watchpoint depends on both:
  - a successful data address match defined by a watchpoint that is linked to this breakpoint, see *Generation of Watchpoint debug events on page C3-2057*
  - a successful Context ID match defined by this breakpoint.

#### ———— Note —————

- This BT value is used when programming the breakpoint that defines the Context ID match part of a Linked Context ID match breakpoint or watchpoint.
- This breakpoint can define the Context ID match part of multiple Context ID match breakpoints and watchpoints.
- Linking is defined in the linked Breakpoint or Watchpoint definitions, not in this breakpoint definition.

*Context matching comparisons for debug event generation on page C3-2051* describes the requirements for a successful Context ID match by this breakpoint.

**DBGBCR.BAS** must be programmed to 0b1111 and **DBGBCR.LBN** must be programmed to 0b0000, otherwise the generation of Breakpoint or Watchpoint debug events by breakpoints and watchpoints linked to this breakpoint is UNPREDICTABLE.

If no breakpoint or watchpoint of the correct type is linked to this breakpoint, no Breakpoint or Watchpoint debug events are generated for this breakpoint.

For more information, see [Linked comparisons for debug event generation on page C3-2053](#).

#### 0b0100, Unlinked instruction address mismatch

Generation of the breakpoint depends on both:

- the **DBGBCR**.{SSC, HMC, PMC} controls described in [Conditions for debug event generation defined by the DBGBCR on page C3-2044](#)
- a successful address mismatch comparison, as described in [Instruction address comparisons for debug event generation on page C3-2046](#).

This breakpoint is not linked to any other breakpoint or watchpoint. **DBGBCR.LBN** must be programmed to 0b0000, otherwise the generation of Breakpoint debug events by this breakpoint is UNPREDICTABLE.

See [UNPREDICTABLE cases when Monitor debug-mode is selected on page C3-2045](#) for additional restrictions for this type of breakpoint when using Monitor debug-mode.

#### 0b0101, Linked instruction address mismatch

Generation of a breakpoint depends on all of:

- the **DBGBCR**.{SSC, HMC, PMC} controls described in [Conditions for debug event generation defined by the DBGBCR on page C3-2044](#)
- a successful address mismatch comparison using the **DBGBVR** for this breakpoint, as described in [Instruction address comparisons for debug event generation on page C3-2046](#)
- a successful context match defined by the breakpoint indicated by **DBGBCR.LBN**.

#### ————— Note —————

This BT value is used to program the breakpoint that defines the instruction address mismatch.

For more information, see [Linked comparisons for debug event generation on page C3-2053](#).

See [UNPREDICTABLE cases when Monitor debug-mode is selected on page C3-2045](#) for additional restrictions for this type of breakpoint when using Monitor debug-mode.

#### 0b1000, Unlinked VMID match

Generation of the breakpoint depends on both:

- the **DBGBCR**.{SSC, HMC, PMC} controls described in [Conditions for debug event generation defined by the DBGBCR on page C3-2044](#)
- a successful VMID match, as described in [Context matching comparisons for debug event generation on page C3-2051](#).

**DBGBCR.BAS** must be programmed to 0b1111, **DBGBCR.LBN** must be programmed to 0b0000, and the associated **DBGBVR** must be programmed to 0x00000000, otherwise the generation of Breakpoint debug events by this breakpoint is UNPREDICTABLE.

See [UNPREDICTABLE cases when Monitor debug-mode is selected on page C3-2045](#) for additional restrictions for this type of breakpoint when using Monitor debug-mode.

This breakpoint type is supported only if the implementation includes the Virtualization Extensions.

#### 0b1001, Linked VMID match

Either:

- generation of a breakpoint depends on both:
  - a successful instruction address match, or a successful instruction address mismatch, defined by a breakpoint that is linked to this breakpoint
  - a successful VMID match defined by this breakpoint
- generation of a watchpoint depends on both:
  - a successful data address match defined by a watchpoint that is linked to this breakpoint, see [Generation of Watchpoint debug events on page C3-2057](#)
  - a successful VMID match defined by this breakpoint.

---

#### Note

- This BT value is used when programming the breakpoint that defines the VMID match part of a Linked VMID match breakpoint or watchpoint.
- This breakpoint can define the VMID match part of multiple VMID match breakpoints and watchpoints.
- Linking is defined in the linked Breakpoint or Watchpoint definitions, not in this breakpoint definition.

---

[Context matching comparisons for debug event generation on page C3-2051](#) describes the requirements for a successful VMID match by this breakpoint.

DBGBCR.BAS must be programmed to 0b1111, DBGBCR.LBN must be programmed to 0b0000, and the associated DBGBVR must be programmed to 0x00000000, otherwise the generation of Breakpoint and Watchpoint debug events by breakpoints and watchpoints linked to this breakpoint is UNPREDICTABLE.

If no breakpoint or watchpoint of the correct type is linked to this breakpoint, no Breakpoint or Watchpoint debug events are generated for this breakpoint.

For more information see [Linked comparisons for debug event generation on page C3-2053](#).

This breakpoint type is supported only if the implementation includes the Virtualization Extensions.

#### 0b1010, Unlinked VMID match and Context ID match

Generation of the breakpoint depends on all of:

- the DBGBCR.{SSC, HMC, PMC} controls described in [Conditions for debug event generation defined by the DBGBCR on page C3-2044](#)
- a successful Context ID match, defined by this breakpoint
- a successful VMID match, defined by this breakpoint.

[Context matching comparisons for debug event generation on page C3-2051](#) describes the requirements for a successful Context ID match and a successful VMID match by this breakpoint.

DBGBCR.BAS must be programmed to 0b1111 and DBGBCR.LBN must be programmed to 0b0000, otherwise the generation of Breakpoint debug events by this breakpoint is UNPREDICTABLE.

If no breakpoint or watchpoint of the correct type is linked to this breakpoint, no Breakpoint or Watchpoint debug events are generated for this breakpoint.

See [UNPREDICTABLE cases when Monitor debug-mode is selected on page C3-2045](#) for additional restrictions for this type of breakpoint when using Monitor debug-mode.

This breakpoint type is supported only if the implementation includes the Virtualization Extensions.

### 0b1011, Linked VMID and Context ID match, only available with Virtualization Extensions

Either:

- generation of a breakpoint depends on all of:
  - a successful instruction address match, or a successful instruction address mismatch, defined by a breakpoint that is linked to this breakpoint
  - a successful Context ID match, defined by this breakpoint
  - a successful VMID match, defined by this breakpoint.
- generation of a watchpoint depends on all of:
  - a successful data address match defined by a watchpoint that is linked to this breakpoint, see [Generation of Watchpoint debug events on page C3-2057](#)
  - a successful Context ID match, defined by this breakpoint
  - a successful VMID match, defined by this breakpoint.

[Context matching comparisons for debug event generation on page C3-2051](#) describes the requirements for a successful Context ID match and a successful VMID match by this breakpoint.

If no breakpoint or watchpoint of the correct type is linked to this breakpoint, no Breakpoint or Watchpoint debug events are generated for this breakpoint.

#### Note

- This BT value is used when programming the breakpoint that defines the VMID and Context ID match parts of a Linked VMID and Context ID match breakpoint or watchpoint.
- This breakpoint can define the VMID and Context ID match parts of multiple Context ID match breakpoints and watchpoints.
- Linking is defined in the linked Breakpoint or Watchpoint definitions, not in this breakpoint definition.

[DBGBCR.BAS](#) must be programmed to 0b1111 and [DBGBCR.LBN](#) must be programmed to 0b0000, otherwise the generation of Breakpoint and Watchpoint debug events by breakpoints and watchpoints linked to this breakpoint is UNPREDICTABLE.

For more information see [Linked comparisons for debug event generation on page C3-2053](#).

This breakpoint type is supported only if the implementation includes the Virtualization Extensions.

### C3.3.3 Conditions for debug event generation defined by the DBGBCR

For each breakpoint, the [DBGBCR](#) defines some general properties of the breakpoint, including some conditions for generating a Breakpoint debug event, using the following register fields:

**Enable, E** Controls whether the breakpoint is enabled. A breakpoint never generates a Breakpoint debug event if the breakpoint is disabled.

#### Linked breakpoint number, LBN

If the breakpoint is a linked instruction address match or mismatch breakpoint, this field gives the number of the linked breakpoint.

When two breakpoints are linked to define a single Breakpoint debug event, the breakpoint that defines the address comparison also defines the privileged mode control, Hyp mode control, and security state control.

For more information, see [Linked comparisons for debug event generation on page C3-2053](#).



### Privileged mode control, PMC

Controls whether the breakpoint defines a Breakpoint debug event that can occur:

- only in User mode
- only in a PL1 mode
- only in User, System or Supervisor modes
- in any mode.

### Security state control, SSC

If the implementation includes the Security Extensions, this field controls whether the Breakpoint debug event can occur only in Secure state, only in Non-secure state, or in either security state. The comparison is made with the security state of the processor, not the NS attribute of the instruction fetch access.

### Hyp mode control, HMC

If the implementation includes the Virtualization Extensions, this field controls whether the Breakpoint debug event can or cannot occur in Hyp mode.

For more information about the [DBGBCR](#).{PMC, SSC, HMC} fields, and valid combinations of their values, see [Breakpoint state control fields on page C11-2215](#).

## UNPREDICTABLE cases when Monitor debug-mode is selected

When invasive debug is enabled and Monitor debug-mode is selected, in Secure state and in Non-secure state when debug events are not routed to PL2, the behavior on the following events is UNPREDICTABLE in PL1 and PL0 modes, and can lead to an unrecoverable state:

- Unlinked Context match Breakpoint debug events that are configured to be generated at PL1.
- Linked or unlinked instruction address mismatch Breakpoint debug events that are configured to be generated at PL1.

### C3.3.4 Byte address selection and masking defined by the DBGBCR

The [DBGBCR](#).{MASK, BAS} fields define byte address selection or masking as follows:

- For an instruction address comparison, a debugger can use one of these fields to specify how the address in the [DBGBVR](#) is used in the comparison. That is, it can either:
  - Use the Byte address selection field, [DBGBCR BAS](#), to specify the bytes in the [DBGBVR](#) that are used in the comparison. In this case, if [DBGBCR MASK](#) is implemented, the debugger must also program [DBGBCR MASK](#) to `0b00000`, so that no mask is set.
  - Use the [DBGBCR.MASK](#) field, if it is implemented, to define an address mask, that specifies the low-order bits of the instruction address and [DBGBVR](#) values that are excluded from the comparison. In this case it must also program [DBGBCR BAS](#) to `0b1111`, to disable any byte address selection.

———— **Note** —————

For instruction address comparison:

- A debugger can use either byte address selection or address range masking, if it is implemented. However, it must not attempt to use both at the same time
- The address in the [DBGBVR](#) must be word-aligned.

- For a Context ID comparison, if the [DBGBCR.MASK](#) field is implemented, a debugger can use it to exclude the bottom 8 bits of the [CONTEXTIDR](#) value from the comparison.

———— **Note** —————

v7 Debug and v7.1 Debug deprecate any use of the [DBGBCR.MASK](#) field.

For more information, see *Instruction address comparisons for debug event generation* and *Context matching comparisons for debug event generation* on page C3-2051.

### C3.3.5 Instruction address comparisons for debug event generation

The result of an address comparison depends on the value in the [DBGBVR](#) either matching or mismatching the instruction address.

When a debugger programs the [DBGBCR](#) for an instruction address match or mismatch, the debug logic generates a Breakpoint debug event only if all the other conditions for the breakpoint are met, and the address comparison is successful. That is, all other conditions are met and, taking account of any masking, or byte address selection:

- for an address match, the instruction address value equals the value in the [DBGBVR](#)
- for an address mismatch, the instruction address value does not equal the value in the [DBGBVR](#).

The following subsections give more information about the address comparisons:

- *Condition for breakpoint generation on address match, with byte address selection*
- *Condition for breakpoint generation on address mismatch, with byte address selection* on page C3-2047
- *Breakpoint address range masking behavior* on page C3-2049.

[DBGBVR](#) values must be word-aligned, and [DBGBVR](#)[1:0] are never used for address comparison.

#### ———— Note —————

A debugger can use address mismatch to generate a Breakpoint debug event when the processor executes any instruction other than the instruction indicated by the [DBGBVR](#) within the context specified by the [DBGBCR](#) and an option linked Context matching breakpoint. The debugger can use this for single-stepping, for breakpointing all instructions outside a range of instruction addresses, or for breakpointing all instructions in a given context.

#### Condition for breakpoint generation on address match, with byte address selection

When a debugger programs a breakpoint for instruction address match, without address range masking, and all other conditions for generating a breakpoint are met, the debug logic generates a Breakpoint debug event only if both:

- bits[31:2] of the address are equal to the value of bits[31:2] of [DBGBVR](#)
- [DBGBCR](#).BAS, the Byte address select field, is programmed for an instruction address match for the current Instruction set state and address[1:0] value. See *Byte address selection behavior on instruction address match or mismatch* on page C3-2047.

#### ———— Note —————

When programming a breakpoint for instruction address comparison without address range masking the debugger must set [DBGBCR](#).MASK, the Address range mask field, to zero.

### Condition for breakpoint generation on address mismatch, with byte address selection

When a debugger programs a breakpoint for instruction address mismatch, without address range masking, and all other conditions for generating a breakpoint are met, the debug logic generates a Breakpoint debug event only if either:

- bits[31:2] of the address are not equal to the value of bits[31:2] of **DBGBVR**
- **DBGBCR.BAS**, the Byte address select field, is programmed for an instruction address mismatch for the current Instruction set state and address[1:0] value. See *Byte address selection behavior on instruction address match or mismatch*.

———— **Note** ————

When programming a breakpoint for instruction address comparison without address range masking the debugger must set **DBGBCR.MASK**, the Address range mask field, to zero.

### Byte address selection behavior on instruction address match or mismatch

A debugger programs **DBGBVR** with a word address. If the debugger programs the breakpoint instruction address match or mismatch, it can program **DBGBCR.BAS**, the Byte address select field, so that the breakpoint hits only if certain byte addresses are accessed. The exact interpretation depends on the processor instruction set state, as indicated by the **CPSR**.{J, T} bits, and on the bottom two bits of the address. [Table C3-2](#) shows the operation of byte address range masking using the **DBGBCR.BAS** field.

**Table C3-2 Effect of byte address selection on Breakpoint generation**

Instruction set state <sup>a</sup>	Instruction address <sup>b</sup>	DBGBCR.BAS, byte address select	Breakpoint programmed for		
			Match	Mismatch	
Any	Any address	0b0000	Miss	Hit	
ARM	<b>DBGBVR</b> [31:2]:00	0b1111	Hit	Miss	
		0b0000	Miss	Hit	
		Any other value	UNPREDICTABLE		
	Any other address	0bxxxx	Miss	Hit	
Thumb or ThumbEE	<b>DBGBVR</b> [31:2]:00	0bxx11	Hit	Miss	
		0bxx10	UNPREDICTABLE		
		0bxx01	UNPREDICTABLE		
		0bxx00	Miss	Hit	
		<b>DBGBVR</b> [31:2]:10	0b11xx	Hit	Miss
	<b>DBGBVR</b> [31:2]:10	0b10xx	UNPREDICTABLE		
		0b01xx	UNPREDICTABLE		
		0b00xx	Miss	Hit	
		Any other address	0bxxxx	Miss	Hit

**Table C3-2 Effect of byte address selection on Breakpoint generation (continued)**

Instruction set state <sup>a</sup>	Instruction address <sup>b</sup>	DBGBCR.BAS, byte address select	Breakpoint programmed for	
			Match	Mismatch
Jazelle	DBGBVR[31:2]:00	0bxxx1	Hit	Miss
		0bxxx0	Miss	Hit
	DBGBVR[31:2]:01	0bxx1x	Hit	Miss
		0bxx0x	Miss	Hit
	DBGBVR[31:2]:10	0bx1xx	Hit	Miss
		0bx0xx	Miss	Hit
	DBGBVR[31:2]:11	0b1xxx	Hit	Miss
		0b0xxx	Miss	Hit
	Any other address	0bxxxx	Miss	Hit

- a. As indicated by the CPSR.{J, T} bits.  
b. For more information see the Note that follows this table.

In a processor with a trivial implementation of the Jazelle extension, generation of Breakpoint debug events is UNPREDICTABLE, and the value of a subsequent read from DBGBCR.BAS is UNKNOWN, if the value written to DBGBCR.BAS has either DBGBCR.BAS[3] != DBGBCR.BAS[2], or DBGBCR.BAS[1] != DBGBCR.BAS[0]. For a description of the trivial implementation of the Jazelle extension see *Trivial implementation of the Jazelle extension* on page B1-1244.

**Note**

- In Table C3-2 on page C3-2047, the instruction address value is the address of the first byte of the instruction. For more information, including what happens when the breakpoint does not match all bytes of an instruction, see *Instruction address comparisons in different instruction set states* on page C3-2049.
- In the ARMv7-R profile, the value of the Instruction Endianness bit, SCTL.R.IE, does not affect the generation of Breakpoint debug events. For more information about instruction endianness. See *Instruction endianness* on page A3-111.

When address range matching is not being used, the debugger can set DBGBCR.BAS to zero when using a mismatch breakpoint to set a breakpoint that hits on every address comparison. Otherwise, the debugger must use DBGBCR.BAS to precisely specify a single instruction. ARM deprecates using DBGBCR.BAS to define a single breakpoint that covers more than one instruction.

**Note**

Using DBGBCR.BAS to define a single breakpoint that covers more than one instruction is possible only when setting breakpoints on Thumb or ThumbEE instructions, or on Java bytecodes.

See *Instruction address comparisons in different instruction set states* on page C3-2049 for more information about how the instruction set state affects how a debugger must define a breakpoint.

For examples of how to program a breakpoint using byte address selection see *Instruction address comparison programming examples* on page C3-2050.

## Breakpoint address range masking behavior

Support for breakpoint address range masking is OPTIONAL and deprecated, and:

- `DBGBCR.MASK` is RAZ/WI if the implementation does not support breakpoint address range masking and either:
  - `DBGDIDR.DEVID_imp` is RAZ
  - `DBGDIDR.DEVID_imp` is RAO and `DBGDEVID.{CIDMask, BPAAddrMask}` are both RAZ.
- Otherwise:
  - `DBGDEVID.BPAAddrMask` indicates whether the implementation supports breakpoint address range masking.
  - If the implementation does not support breakpoint address range masking and does not support Context ID masking then `DBGBCR.MASK` is UNK/SBZP.

In an implementation that supports breakpoint address range masking:

- When a debugger programs a breakpoint for instruction address matching, the debug logic masks the comparison using the value held in `DBGBCR.MASK`, the address range mask field.
- A debugger can use the MASK field when programming the breakpoint for instruction address mismatch, that is, when `DBGBCR.MASK != 0b00000` and the Breakpoint type is Instruction address mismatch. In this case, the address comparison part of breakpoint generation hits for all addresses outside the masked address region.

To use breakpoint address range masking, the debugger must also set `DBGBCR.BAS`, the Byte address select field, to `0b1111`.

ARM deprecates any use of breakpoint address range masking.

### ———— Note —————

There is no encoding for a full 32-bit mask. This mask would have the effect of setting a breakpoint that hits on every address comparison, and a debugger can achieve this by setting:

- `DBGBCR.BT`, Breakpoint type field, to either `0b0100` or `0b0101` to select an instruction address mismatch
- `DBGBCR.BAS`, Byte address select field, to `0b0000`.

## Instruction address comparisons in different instruction set states

Whether the current instruction set is *fixed-length* or *variable-length* affects the behavior of instruction address comparisons.

The ARM instruction set is a fixed-length instruction set. In the ARM instruction set the size of each instruction is one word, and ARM instructions are always word-aligned. The Thumb and ThumbEE instruction sets, and Java bytecodes, are variable-length instruction sets. In the Thumb and ThumbEE instruction sets the size of each instruction is either one or two halfwords, and Thumb and ThumbEE instructions are always halfword-aligned. A Java bytecode and associated parameters can be one or more bytes, at any address alignment.

The generation of a Breakpoint debug event can be UNPREDICTABLE, depending on the instruction set type. That is, it is UNPREDICTABLE whether the breakpoint generates a Breakpoint debug event under the following conditions:

### For ARM instructions

If `DBGBCR.MASK == 0b00000` and `DBGBCR.BAS != 0b1111`.

#### For Thumb and ThumbEE instructions

- If `DBGBCR.MASK == 0b00000` and:
  - for an instruction at a word-aligned address, `DBGBCR.BAS[1:0] != 0b11`
  - for an instruction not at a word-aligned address, `DBGBCR.BAS[3:2] != 0b11`.
- Unless `DBGBCR.MASK == 0b00000` and `DBGBCR.BT` specifies an address mismatch breakpoint, if the first halfword of a 32-bit instruction misses and the second halfword hits.

———— **Note** —————

For an unmasked address mismatch breakpoint, a hit on the second halfword is ignored.

#### For Java bytecodes

Unless `DBGBCR.MASK == 0b00000` and `DBGBCR.BT` specifies an address mismatch breakpoint, if the first byte of the Java bytecode and associated parameters misses but a subsequent byte hits.

———— **Note** —————

For an unmasked address mismatch breakpoint, a hit on the second or any subsequent byte is ignored.

### Instruction address comparison programming examples

———— **Note** —————

The examples given in this subsection also work with earlier versions of the Debug architecture. See [Instruction address comparison programming examples for ARMv6 on page AppxM-2552](#) for more information.

- To breakpoint on a Java bytecode at address `0x8001`, a debugger must set `DBGBVR` to `0x8000` and `DBGBCR.BAS`, Byte address select field, to `0b0010`.
- To breakpoint on a 16-bit Thumb or ThumbEE instruction starting at address `0x8002`, a debugger must set `DBGBVR` to `0x8000` and `DBGBCR.BAS` to `0b1100`.
- To breakpoint on an ARM instruction starting at address `0x8004`, a debugger must set `DBGBVR` to `0x8004` and `DBGBCR.BAS` to `0b1111`.
- A debugger sets a breakpoint on a 32-bit Thumb instruction, or on a 16-bit or a 32-bit ThumbEE instruction, in exactly the same way as on a 16-bit Thumb instruction. For example, to breakpoint on a 16-bit or a 32-bit Thumb or ThumbEE instruction starting at address `0x8000`, the debugger must set `DBGBVR` to `0x8000` and `DBGBCR.BAS` to `0b0011`.

———— **Note** —————

When programming `DBGBVR` for instruction address match or mismatch, the debugger must program `DBGBVR[1:0]` to `0b00`, otherwise Breakpoint debug event generation is UNPREDICTABLE.

### Use of instruction address mismatch breakpoints for single-stepping

Programming a breakpoint for instruction address mismatch with byte address selection means it can be used for single stepping. On branching into the mode and state in which the target instruction address matches the breakpoint, the target instruction is executed and a Breakpoint debug event is generated on the next instruction.

If an exception is taken the behavior depends on the `DBGBCR`. {SSC, HMC, PMC} breakpoint conditions, and on any linked Context matching breakpoint. By programming these such that the breakpoint only matches in certain modes, states and contexts, the breakpoint can provide the illusion of stepping over exceptions.

If the target instruction address does not match the breakpoint, a Breakpoint debug event is generated immediately. For example, this happens when returning from an exception handler to the next instruction, such as might happen when stepping an SVC instruction.

However, it is UNPREDICTABLE whether a Breakpoint debug event is generated on the next instruction if any of:

- The instruction branches to itself, so the instruction address continues to match the breakpoint. This means that the instruction is re-executed an UNKNOWN, possibly infinite, number of times before the Breakpoint debug event is generated unless the instruction stops branching to itself, for example because of an exception. Such instructions include branches and load instructions that write the PC.
- The breakpoint also matches the address of the next instruction. For example, if the instructions are a pair of 16-bit Thumb instructions packed into a single word and `DBGBCR.BAS` field of the breakpoint is 0b1111.
- Another instruction address mismatch breakpoint matches the address of the next instruction.

If another breakpoint generates a Breakpoint debug event on the target instruction, or a Vector catch debug event is generated by the target instruction, then it is UNPREDICTABLE whether the instruction is stepped or the debug event is taken.

By programming the `DBGBCR.BAS` field in the breakpoint to 0b0000, no target address can match the breakpoint. This has the effect of setting a breakpoint that hits on every address comparison.

### C3.3.6 Context matching comparisons for debug event generation

The result of a Context matching comparison depends on either or both of:

- The value in the `DBGBVR` matching the Context ID, held in the `CONTEXTIDR`.
- The value in the `DBGXVR` matching the virtual machine identifier held in the `VTTBR.VMID` field.

———— **Note** —————

- Context matching is only available for a set number of breakpoints, which can be discovered by reading `DBGDIDR.CTX_CMPs`.
- VMID comparison is only available in an implementation that includes the Virtualization Extensions.

A debugger programs `DBGBCR.BT` for one of the following Context matches:

- a Context ID match
- a VMID match
- a Context ID match and a VMID match.

The debug logic generates a Breakpoint debug event only if all other conditions for breakpoint are met, and the Context match comparison is successful.

———— **Note** —————

- A debugger cannot define a Breakpoint debug event based on a Context ID mismatch.
- A debugger cannot define a Breakpoint debug event based on a VMID mismatch.
- A debugger must program `DBGBCR.BAS` to 0b1111 for all Context match comparisons.
- A debugger can link a breakpoint programmed for linked Context matching to any number of:
  - Breakpoints programmed for Linked instruction address match or mismatch
  - Watchpoints programmed for Linked data address match.

This means a debugger can use a single breakpoint to define the Context match for multiple breakpoints and watchpoints.

### Condition for breakpoint generation on Context ID match in a PMSA implementation

In a PMSA implementation, when a debugger programs a breakpoint for a Context ID match, and all other conditions for generating a breakpoint are met, the debug logic generates a Breakpoint debug event only if bits[31:0] of the `CONTEXTIDR` are equal to the value of bits[31:0] of `DBGBVR`. A PMSA implementation does not support Context ID masking. This means that `DBGDEVID.CIDMask` is RAZ in a PMSAv7 implementation that includes the `DBGDEVID` register.

### Condition for breakpoint generation on Context ID match in a VMSA implementation

In a VMSA implementation, when using the Short-descriptor translation table format, the `CONTEXTIDR` includes two fields:

- the Process Identifier, `PROCID`, bits[31:8]
- the Address Space Identifier, `ASID`, bits[7:0].

In the lifetime of a process, some operating systems may use different ASID values, resulting in different `CONTEXTIDR` values. When using the Long-descriptor translation table format, the ASID is specified by a TTBR register.

It is IMPLEMENTATION DEFINED whether a VMSAv7 implementation supports Context ID masking. If `DBGDIDR.DEVID_imp` is RAZ, or `DBGDEVID.CIDMask` is RAZ, then the implementation does not support Context ID masking.

In an implementation that supports Context ID masking, `DBGBCR.MASK`, the address range mask field, can be programmed so that only the `PROCID` field is used for the Context ID match.

When a debugger programs a breakpoint for a Context ID match, and all other conditions for generating the breakpoint are met, the debug logic generates a Breakpoint debug event only if either:

- `CONTEXTIDR`[31:0], the `PROCID` and `ASID` fields, is equal to the value of `DBGBVR`[31:0], and `DBGBCR.MASK` is set to `0b00000`
- in an implementation that supports Context ID masking, `CONTEXTIDR`[31:8], the `PROCID` field, is equal to the value of `DBGBVR`[31:8], and `DBGBCR.MASK` is set to `0b01000`.

In an implementation that includes the Virtualization Extensions, Context ID matches never occur when executing at Non-secure PL2.

Context ID masking operates regardless of the translation table format being used. However, ARM deprecates any use of Context ID masking when using the Long-descriptor translation table format.

#### ———— Note —————

The generation of a Breakpoint debug event is UNPREDICTABLE unless either:

- `DBGBCR.MASK` is set to `0b00000`
- `DBGBCR.MASK` is set to `0b01000` and Context ID masking is supported.

### Condition for breakpoint generation on VMID match

VMID matching is only available in a VMSA implementation that includes the Virtualization Extensions.

When a debugger programs a breakpoint for a VMID match, and all other conditions for generating a breakpoint are met, the debug logic generates a Breakpoint debug event only if `VTTBR.VMID` is equal to `DBGBXVR.VMID`.

VMID matches never occur when executing in Secure state or at Non-secure PL2.



### Condition for breakpoint generation on Context ID match and VMID match

Combined Context ID and VMID matching is only available in a VMSA implementation that includes the Virtualization Extensions.

When a debugger programs a breakpoint for a Context ID and VMID match, and all other conditions for generating a breakpoint are met, the debug logic generates a Breakpoint debug event only if both:

- One of the following conditions is true:
  - bits[31:0] of the `CONTEXTIDR`, that is PROCID and ASID, are equal to the value of bits[31:0] of `DBGBVR`, and `DBGBCR.MASK` is set to `0b00000`
  - bits[31:8] of the `CONTEXTIDR`, that is PROCID only, are equal to the value of bits[31:8] of `DBGBVR`, `DBGBCR.MASK` is set to `0b01000`, and Context ID masking is supported.  
See [Condition for breakpoint generation on Context ID match in a VMSA implementation on page C3-2052](#) for more information on Context ID masking.
- `VTTBR.VMID` is equal to `DBGBXVR.VMID`.

### C3.3.7 Linked comparisons for debug event generation

For linked comparisons, a comparison includes a Context match, defined by a breakpoint, with an address comparison defined by another breakpoint or watchpoint linked to the Context match, comprising:

- another breakpoint, programmed to define a linked instruction address match
- another breakpoint, programmed to define a linked instruction address mismatch
- a watchpoint, programmed to define a linked data address match.

The debug logic generates a Breakpoint or Watchpoint debug event only if both:

- the defined Context matches
- a defined instruction address match or mismatch, or a defined data address match.

In this description:

- breakpoint *m* is programmed to define the Context match
- breakpoint *n* is programmed to define a linked instruction address match or mismatch, and is linked to breakpoint *m*
- watchpoint *n* is programmed to define a linked data address match, and is linked to breakpoint *m*.

If there are no breakpoints and no watchpoints linked to breakpoint *m* then breakpoint *m* cannot generate any debug events. The rest of this description assumes at least one breakpoint or watchpoint is linked to breakpoint *m*.

The programming requirements of the different comparisons are:

#### Programming breakpoint *m* to define the Context match part of the linked Context match

- if required, program `DBGBVRm` with the Context ID to be matched
- if required, program `DBGBXVRm.VMID` with the VMID to be matched
- program `DBGBCRm.BT`, Breakpoint type, to one of:
  - `0b0011`, linked Context ID comparison
  - `0b1010`, linked VMID comparison
  - `0b1011`, linked Context ID and VMID comparison
- program either:
  - `DBGBCRm.MASK` with `0b01000`, ignore ASID
  - `DBGBCRm.MASK` with `0b00000`, mask not defined
- program `DBGBCRm.LBN`, Linked breakpoint number, to `0b0000`, linked breakpoint number not defined
- program `DBGBCRm.SSC`, Security state control, to `0b00`

- program `DBGBCR $m$ .BAS`, Byte address select, to `0b1111`, byte address select not defined
- program `DBGBCR $m$ .PMC`, Privileged mode control, to `0b11`
- if the implementation includes the Virtualization Extensions, program `DBGBCR $m$ .HMC`, Hyp mode control, to `0`.

#### Programming breakpoint $n$ to define the instruction address match or mismatch part of a linked Context match

- program `DBGBVR $n$ [31:2]` with the address for comparison, and `DBGBVR $n$ [1:0]` to `0b00`
- program `DBGBCR $n$ .BT`, Breakpoint type, to either:
  - `0b0001`, for linked instruction address match
  - `0b0101`, for linked instruction address mismatch
- program either:
  - `DBGBCR $n$ .MASK` with the required address range mask, and `DBGBCR $n$ .BAS` to `0b1111`
  - `DBGBCR $n$ .BAS` with the required Byte address select value, and `DBGBCR $n$ .MASK` to `0b000000`
- program `DBGBCR $n$ .LBN`, Linked breakpoint number, to  $m$ , the number of the breakpoint that defines the Context match
- if required, program `DBGBCR $n$ .SSC`, Security state control, `DBGBCR $n$ .PMC`, Privileged mode control and, if the implementation includes the Virtualization Extensions, `DBGBCR $n$ .HMC`, Hyp mode control, to include the state of the processor in the comparison.

#### Programming watchpoint $n$ to define the data address match part of a linked Context match

- program `DBGWVR $n$ [31:2]` with the address for comparison, and `DBGWVR $n$ [1:0]` to `0b00`
- program `DBGWCR $n$ .WT`, Watchpoint type, to `1`, to enable linking
- program one of the following:
  - `DBGWCR $n$ .MASK` with the required address range mask, and `DBGWCR $n$ .BAS` to `0b1111`, if the implementation uses 4-bit WCR byte select fields
  - `DBGWCR $n$ .MASK` with the required address range mask, and `DBGWCR $n$ .BAS` to `0b11111111`, if the implementation uses 8-bit WCR byte select fields
  - `DBGBCR $n$ .BAS` with the required Byte address select value, and `DBGBCR $n$ .MASK` to `0b000000`
- program `DBGWCR $n$ .LBN`, Linked breakpoint number to  $m$ , the number of the breakpoint that defines the Context match
- if required, program `DBGWCR $n$ .SSC`, Security state control, `DBGWCR $n$ .PAC`, Privileged access control, and, if the implementation includes the Virtualization Extensions, `DBGWCR $n$ .HMC`, Hyp mode control, to include the state of the processor in the comparison
- if required, program `DBGWCR $n$ .LSC`, Load/store access control, to include the type of the data access in the comparison.

With linked comparisons, whether a Breakpoint or Watchpoint debug event is generated is UNPREDICTABLE if:

- the programming of the `DBGBCR`, `DBGBVR`, `DBGWCR` and `DBGWVR` registers does not meet the requirements of the comparison, as defined in this section
- breakpoint  $n$  is linked to breakpoint  $m$  but is not programmed for Linked instruction address match or Linked instruction address mismatch
- watchpoint  $n$  is linked to breakpoint  $m$  but is not programmed to enable linking
- watchpoint  $n$  or breakpoint  $n$  is linked to breakpoint  $m$  and either:
  - breakpoint  $m$  does not support Linked Context matching
  - breakpoint  $m$  is not programmed for Linked Context matching.

In addition:

- for any linked comparisons to succeed, the debugger must program `DBGBCRm.E` to 1 to enable the Context match
- for a linked instruction address comparison to succeed, the debugger must program `DBGBCRn.E` to 1, to enable the address comparison
- for a linked data address comparison to succeed, the debugger must program `DBGWCRn.E` to 1, to enable the address comparison.

---

**Note**

- For linked breakpoints, if the debugger does not enable both breakpoints, breakpoint *n* never generates a Breakpoint debug event.
  - For linked watchpoints, if the debugger does not enable both breakpoint *m* and watchpoint *n*, watchpoint *n* never generates a Watchpoint debug event.
- 

### C3.3.8 Summary of breakpoint generation options

Table C3-3 on page C3-2056 shows which values are compared and which are not for each type of breakpoint. In this table:

- Entries in **bold monospaced** indicate an element of the comparison that is made. Reading across the *Comparison* columns for a row of the table gives the comparison to be made. For example, for the Linked instruction address mismatch (0b0101), the comparison is:  
 Not (**Equals**[Address] AND **Selected**[Byte address]) AND **Match**[State] AND **Link**[Linked Breakpoint]
- The Breakpoint type bits are in `DBGBCR.BT`, the Breakpoint type field. The Breakpoint type field is 3 bits, unless the implementation includes the Virtualization Extensions, when it is 4 bits, to include VMID matching.
- The address comparison matches address[31:2] against `DBGBVR[31:2]`, taking account of any address range masking. See *Breakpoint address range masking behavior* on page C3-2049.
- The Byte address selection matches address [1:0] against `DBGBCR.BAS`. See *Byte address selection behavior on instruction address match or mismatch* on page C3-2047.
- The Context ID comparison matches `CONTEXTIDR[31:0]` against `DBGBVR[31:0]`. Optionally, in a VMSA implementation, the Context ID comparison only matches `CONTEXTIDR.PROCID` against `DBGBVR[31:8]`, taking into account any masking. See *Context matching comparisons for debug event generation* on page C3-2051.
- For a VMSA implementation that includes the Virtualization Extensions, the VMID comparison matches `VTTBR.VMID` against `DBGXVR.VMID`. See *Context matching comparisons for debug event generation* on page C3-2051.
- The State comparison is the processor state comparison, made according to the values of `DBGBCR.SSC`, Security state control, `DBGBCR.HMC`, Hyp mode control, and `DBGBCR.PMC`, Privileged mode control.

The tables assume the debugger performs all breakpoint programming correctly.

**Table C3-3 Breakpoint type bits summary**

Breakpoint type	Description	Comparison					
		Address	Byte address select	Context ID	VMID	State	Linked
0b0000	Address match	Equals	AND Selected			AND Match	
0b0001	Linked address match	Equals	AND Selected			AND Match	AND Link
0b0010	Context ID match <sup>a</sup>			Equals		AND Match	
0b0011	Linked Context ID match <sup>a</sup>			Equals			AND Link
0b0100	Address mismatch <sup>a</sup>	Not (Equals	AND Selected)			AND Match	
0b0101	Linked address mismatch <sup>a</sup>	Not (Equals	AND Selected)			AND Match	AND Link
0b011x	Reserved	-	-	-	-	-	-
0b1000	VMID match <sup>a</sup>				Equals	AND Match	
0b1001	Linked VMID match				Equals		AND Link
0b1010	Context ID + VMID match <sup>a</sup>			Equals	Equals	AND Match	
0b1011	Linked Context ID + VMID match			Equals	Equals		AND Link
0b11xx	Reserved	-	-	-	-	-	-

a. When Monitor debug-mode is selected, take care when programming `DBGBCR.PMC`, Privileged mode control. For more information see *UNPREDICTABLE cases when Monitor debug-mode is selected* on page C3-2045.

The `BreakpointMatch()` pseudocode function describes breakpoint generation. See *Breakpoints and Vector catches* on page C3-2078.

## C3.4 Watchpoint debug events

To define a Watchpoint debug event, a debugger programs a pair of registers to create a watchpoint. Each watchpoint comprises:

- a *Watchpoint Control Register*, [DBGWCR](#), which holds control information for the watchpoint
- a *Watchpoint Value Register*, [DBGWVR](#), which holds the address used in watchpoint matching.

The [DBGDIDR.WRPs](#) field specifies the number of watchpoints implemented. See [DBGDIDR, Debug ID Register on page C11-2229](#), and can be between 1 and 16.

For each watchpoint, the associated registers are numbered, from 0 to 15. For example, [DBGWCR3](#), and [DBGWVR3](#) define watchpoint 3. For details of the Watchpoint registers see:

- [DBGWVR, Watchpoint Value Registers on page C11-2297](#)
- [DBGWCR, Watchpoint Control Registers on page C11-2291](#).

A debugger can define a Watchpoint debug event:

- Based on comparison of a data address with the value held in a [DBGWVR](#). The address in the [DBGWVR](#) must be the virtual address of the data.
- By linking a watchpoint to a breakpoint, to define a single Watchpoint debug event. The watchpoint holds a data address for comparison, and the breakpoint holds a Context match value. For more information, see [Linked comparisons for debug event generation on page C3-2053](#).

In all cases, the [DBGWCR](#) defines some additional conditions that must be met for the watchpoint to generate a Watchpoint debug event, including whether the watchpoint is enabled.

The terms *hit* and *miss* describe whether the conditions defined in the watchpoint are met. See [Breakpoint debug events on page C3-2039](#) for more information.

The following sections describe Watchpoint debug events:

- [Generation of Watchpoint debug events](#)
- [Conditions for debug event generation defined by the DBGWCR on page C3-2059](#)
- [Byte address selection and masking defined by the DBGWCR on page C3-2060](#)
- [Synchronous and asynchronous Watchpoint debug events on page C3-2062](#).

### C3.4.1 Generation of Watchpoint debug events

For a given watchpoint, the debug logic generates a Watchpoint debug event only if all of the following apply:

- When the processor tests the watchpoint, all the conditions of [DBGWCR](#) are met, see [Conditions for debug event generation defined by the DBGWCR on page C3-2059](#).
- The data address used with either byte address selection or address range masking, matches the value in [DBGWVR](#).
- If the watchpoint is linked to a breakpoint for Context matching, then the comparison made by the breakpoint is successful.
- The instruction that initiated the memory access is committed for execution. The debug logic generates a Watchpoint debug event only if the instruction passes its condition code check.

For more information about the comparisons that might be required for a linked breakpoint, see:

- [Breakpoint debug events on page C3-2039](#)
- [Linked comparisons for debug event generation on page C3-2053](#)

Any instruction that is defined as a memory access instruction can generate a Watchpoint debug event. For information about which instructions are memory accesses see [Reads and writes on page A3-145](#). Watchpoint debug event generation can be conditional on whether the memory access is a load access or a store access.

For a Store-Exclusive instruction, if the target address of the instruction would generate a Watchpoint debug event, but no write to memory occurs because the check of whether the Store-Exclusive operation has control of the exclusive monitors fails, then it is IMPLEMENTATION DEFINED whether the debug logic generates the Watchpoint debug event.

For each of the memory hint instructions, PLD, PLDW, and PLI, it is IMPLEMENTATION DEFINED whether the instruction generates Watchpoint debug events. If the instruction can generate Watchpoint debug events and the other conditions for generating a Watchpoint debug event are met, the behavior must be:

- For the PLI instruction:
  - the debug logic does not generate a watchpoint in a situation where, if the instruction was a real fetch rather than a hint, the real fetch would generate a Prefetch Abort exception
  - in all other situations the debug logic generates a Watchpoint debug event.
- For the PLD and PLDW instructions:
  - the debug logic does not generate a watchpoint in a situation where, if the instruction was a real memory access rather than a hint, the real memory access would generate a Data Abort exception
  - in all other situations the debug logic generates a Watchpoint debug event.
- When watchpoint generation is conditional on the type of memory access, a memory hint instruction is treated as generating a load access.

It is IMPLEMENTATION DEFINED whether the following cache maintenance operations can generate Watchpoint debug events:

- Clean data or unified cache line by MVA to PoU, DCCMVAU
- Clean data or unified cache line by MVA to PoC, DCCMVAC
- Invalidate data or unified cache line by MVA to PoC, DCIMVAC
- Invalidate instruction cache line by MVA to PoU, ICIMVAU
- Clean and Invalidate data or unified cache line by MVA to PoC, DCCIMVAC.

When an implementation supports Watchpoint debug event generation by these cache maintenance operations, and the other conditions for generating a Watchpoint debug event are met, the behavior must be:

- the cache maintenance operation generates a Watchpoint debug event on a data address match, regardless of whether the data is stored in any cache
- when watchpoint generation is conditional on the type of memory access, the debug logic treats a cache maintenance operation as generating a store access.

For regular data accesses, the debug logic considers the size of the access when determining whether a watched byte is being accessed. The size of the access is IMPLEMENTATION DEFINED for:

- memory hint instructions, PLD, PLDW, and PLI
- cache maintenance operations.

Instruction fetches do not generate Watchpoint debug events.

Watchpoint debug events are precise and can be *synchronous* or *asynchronous*:

- a synchronous Watchpoint debug event acts like a synchronous abort exception on the memory access instruction itself
- an asynchronous Watchpoint debug event acts like a precise asynchronous abort exception that cancels a later instruction.

For more information, see [Synchronous and asynchronous Watchpoint debug events](#) on page C3-2062.

For the ordering of debug events, ARMv7 requires that the following apply:

- Regardless of the actual ordering of memory accesses, Watchpoint debug events must be taken in program order. See [Debug event prioritization on page C3-2076](#).
- Watchpoint debug events must behave as if the processor tested for any possible Watchpoint debug event before the memory access was observed, regardless of whether the Watchpoint debug event is synchronous or asynchronous. See [Generation of debug events on page C3-2074](#).

### C3.4.2 Conditions for debug event generation defined by the DBGWCR

For each watchpoint, the **DBGWCR** defines some general properties of the watchpoint, including some conditions for generating a Watchpoint debug event, using the following register fields:

#### Watchpoint type, WT

A data address match watchpoint can be linked to a Context match breakpoint. The WT bit indicates whether the watchpoint is unlinked or linked.

#### Linked breakpoint number, LBN

If the watchpoint is a linked data address match watchpoint, this field gives the number of the linked Context match breakpoint.

When a watchpoint is linked to a Context match breakpoint to define a single Watchpoint debug event, the watchpoint defines the privileged mode control, Hyp mode control, and security state control.

For more information see [Linked comparisons for debug event generation on page C3-2053](#).

#### Security state control, SSC

If the implementation includes the Security Extensions, this field controls whether the Watchpoint debug event can occur only in Secure state, only in Non-secure state, or in either security state. The comparison is made with the security state of the processor, not the NS attribute of the data access.

#### Hyp mode control, HMC

If the implementation includes the Virtualization Extensions, this field controls whether the Watchpoint debug event can or cannot occur in Hyp mode.

#### Load/store access control, LSC

Controls whether the data accesses that can generate a Watchpoint debug event are:

- only load, Load-Exclusive, and swap accesses
- only store, Store-Exclusive, and swap accesses
- all accesses.

#### Privileged access control, PAC

Controls whether the data accesses that can generate a Watchpoint debug event are:

- Only unprivileged data accesses. This includes accesses by LDRT, STRT, and related instructions made by software executing at PL1.
- Only privileged data accesses. This includes any data access by software executing at PL2.
- All data accesses.

**Enable, E** Controls whether the watchpoint is enabled. A watchpoint never generates a Watchpoint debug event if the watchpoint is disabled.

For more information about the **DBGWCR**. {SSC, HMC, PAC} fields, and valid combinations of their values, see [Watchpoint state control fields on page C11-2294](#).

### C3.4.3 Byte address selection and masking defined by the DBGWCR

For a data access comparison, when the **DBGWVR** must specify a word-aligned address, one of the following fields in the **DBGWCR** specifies how the debug logic uses that address in the comparison:

#### Byte address select, **BAS**

Specifies the bytes in the word at the address. If the address is doubleword-aligned then it is IMPLEMENTATION DEFINED whether **BAS** can specify all eight bytes in the doubleword at the address.

#### Address range mask, **MASK**

Specifies the low-order bits of the data address and **DBGWVR** values that are excluded from the comparison.

Implementation of the **MASK** field is OPTIONAL in v7 Debug and required in v7.1 Debug.

For more information, see *Byte address selection behavior on data address match* and *Watchpoint address range masking behavior on page C3-2062*.

#### ———— **Note** —————

For data address comparison, a debugger must use either byte address selection or address range masking to restrict the comparison made. However, it cannot use both at the same time.

### Byte address selection behavior on data address match

For each watchpoint, the debugger programs the **DBGWVR** with a word-aligned address. It can program the Byte address select bits of the **DBGWCR** so that the watchpoint hits if only certain bytes of the watched address are accessed:

- in an implementation that supports a 4-bit Byte address select field, the debugger can program **DBGWCR.BAS** to enable the watchpoint to hit on any access to one or more of the four bytes starting at the word-aligned address in the associated **DBGWVR**
- in an implementation that supports an 8-bit Byte address select field, the debugger can program **DBGWCR.BAS** to enable the watchpoint to hit on any access to one or more of the eight bytes starting at the doubleword-aligned address in the associated **DBGWVR**.

For example, if the debugger sets a watchpoint on all of the bytes in the word starting at 0x1000, and unaligned accesses are enabled, the debug logic generates a match on a word access of address 0xFFD, because both the word being watched and the word being accessed contain the byte at 0x1000.

In all cases, the debug logic generates a Watchpoint debug event if an access hits any byte being watched, even if:

- the access size is smaller or larger than the size of the region being watched
- the access is unaligned, and the base address of the access is not in the word or doubleword of memory addressed by **DBGWVR**.

[Table C3-4](#) and [Table C3-5 on page C3-2061](#) show the meaning of the Byte address select values. [Table C3-4](#) shows the values that a debugger can program in any implementation.

**Table C3-4 Byte address select values, word-aligned address**

<b>DBGWCR.BAS value</b>	<b>Description</b>
0b0000000	Watchpoint never hits
0bxxxxxx1	Watchpoint hits if byte at address <b>DBGWVR</b> [31:2]:00 is accessed



**Table C3-4 Byte address select values, word-aligned address (continued)**

DBGWCR.BAS value	Description
0bxxxxx1x	Watchpoint hits if byte at address <a href="#">DBGWVR[31:2]:01</a> is accessed
0bxxxxx1xx	Watchpoint hits if byte at address <a href="#">DBGWVR[31:2]:10</a> is accessed
0bxxxx1xxx	Watchpoint hits if byte at address <a href="#">DBGWVR[31:2]:11</a> is accessed

Whether an implementation uses a 4-bit or an 8-bit Byte address select field is IMPLEMENTATION DEFINED:

- If the implementation uses a 4-bit Byte address select field, then [DBGWCR.BAS\[7:4\]](#) is RAZ/WI.
- If the implementation uses an 8-bit Byte address select field, then a debugger can program [DBGWCR.BAS\[7:0\]](#) and, for a given watchpoint:
  - The debugger can program the [DBGWVR](#) with a doubleword-aligned address, with [DBGWVR\[2\]](#) set to 0. In this case it can program [DBGWCR.BAS](#) to match any of the 8 bytes in that doubleword value.
  - If [DBGWVR\[2\]](#) is set to 1, indicating a word-aligned address that is not doubleword-aligned, then the debugger must program [DBGWCR.BAS\[7:4\]](#) with zero. If [DBGWVR\[2\]](#) is set to 1 and [DBGWCR.BAS\[7:4\]](#) is not set to 0b0000, the generation of Watchpoint debug events by this watchpoint is UNPREDICTABLE.

[Table C3-5](#) shows the additional Byte address select field encodings that are available, when [DBGWVR\[2\]](#) = 0, on an implementation that supports an 8-bit Byte address select field.

**Table C3-5 Additional Byte address select values, doubleword-aligned address**

DBGWCR.BAS value	Description
0bxxx1xxxx	Watchpoint hits if byte at address <a href="#">DBGWVR[31:3]:100</a> is accessed
0bxx1xxxxx	Watchpoint hits if byte at address <a href="#">DBGWVR[31:3]:101</a> is accessed
0bx1xxxxxx	Watchpoint hits if byte at address <a href="#">DBGWVR[31:3]:110</a> is accessed
0b1xxxxxxx	Watchpoint hits if byte at address <a href="#">DBGWVR[31:3]:111</a> is accessed

———— **Note** ————

Debuggers can use the same programming model on implementations that support:

- an 8-bit Byte address select field, [DBGWCR.BAS\[7:0\]](#)
- a 4-bit Byte address select field, [DBGWCR.BAS\[3:0\]](#).

This is because, on an implementation that supports only a 4-bit Byte address select field, writes to [DBGWCR\[7:4\]](#) are ignored.

Using the [DBGWCRn.BAS](#) field, a debugger can use a single watchpoint to set a watchpoint either:

- on any single byte within the naturally-aligned word or doubleword indicated by [DBGWVRn](#)
- on multiple contiguous bytes within the naturally-aligned word or doubleword indicated by [DBGWVRn](#).

ARM deprecates using [DBGWCR.BAS](#) to set watchpoints on multiple non-contiguous bytes within the word or doubleword indicated by [DBGWVR](#). Whenever there is a requirement to set watchpoints on non-contiguous blocks of memory, ARM strongly recommends that a debugger always uses a different watchpoint for each watchpointed block, even if multiple blocks are in a single naturally-aligned word or doubleword.

———— **Note** ————

In this context, a block of memory might be a single byte.

## Watchpoint address range masking behavior

In v7 Debug, support for watchpoint address range masking is `OPTIONAL`, meaning ARM recommends that it is supported, but the architecture does not require it to be supported. This means:

- `DBGWCR.MASK` is RAZ/WI if the implementation does not support watchpoint address range masking and either:
  - `DBGDIDR.DEVID_imp` is RAZ
  - `DBGDIDR.DEVID_imp` is RAO and `DBGDEVID.WPAddrMask` is RAZ
- Otherwise, `DBGDEVID.WPAddrMask` indicates whether the implementation supports watchpoint address range masking. If `DBGDEVID.WPAddrMask` is RAZ, `DBGWCR.MASK` is UNK/SBZP.

In v7.1 Debug, watchpoint address range masking must be supported and `DBGDEVID.WPAddrMask` must read as `0b0001`.

In an implementation that supports watchpoint address range masking, the debug logic masks the watchpoint comparison using the value held in `DBGWCR.MASK`, the address range mask field.

To use watchpoint address range masking, the debugger must also set `DBGWCR.BAS`, the Byte address select field, to:

- `0b1111`, if a 4-bit Byte address select field is implemented
- `0b11111111`, if an 8-bit Byte address select field is implemented.

### ————— Note —————

- There is no encoding for a full 32-bit mask.
- To define a watchpoint that hits on any access to a doubleword-aligned region of size 8 bytes, ARM recommends that debuggers set:
  - `DBGWCR.MASK` to `0b00011`, indicating an address range mask of `0x00000007`
  - `DBGWCR.BAS`, Byte address select field, to `0b11111111`.

This setting is compatible with both implementations with an 8-bit Byte address select field and implementations with a 4-bit Byte address select field, because implementations with a 4-bit Byte address select field ignore writes to `DBGWCR.BAS[7:4]`

## C3.4.4 Synchronous and asynchronous Watchpoint debug events

ARMv7 permits watchpoints to be either *synchronous* or *asynchronous*. An implementation can implement synchronous watchpoints, asynchronous watchpoints, or both. It is `IMPLEMENTATION DEFINED` under what circumstances a watchpoint is synchronous or asynchronous.

### Synchronous Watchpoint debug events

A synchronous Watchpoint debug event acts like a synchronous abort, taken before any following instructions or exceptions have altered the state of the processor.

When invasive debug is enabled and Watchpoint debug events are permitted, a synchronous Watchpoint debug event:

- Is ignored if Halting debug-mode and Monitor debug-mode are both disabled.
- Otherwise:
  - If Halting debug-mode is enabled, causes the processor to enter Debug state. For more information, see [Chapter C5 Debug State](#).
  - If Monitor debug-mode is enabled, generates a synchronous Data Abort exception. For more information, see [Generation of debug events on page C3-2074](#).

See [Effects of data-aborted instructions on page B1-1216](#) for information about the effect of the watchpointed instruction on the memory locations and registers it accesses, and on the exclusive monitors.

If an instruction that generates multiple memory accesses addresses Device or Strongly-ordered memory, and execution of the instruction generates a Watchpoint debug event on an access other than the first access generated by the instruction, then:

- the order and number of memory accesses can differ from that required by the memory type
- memory accesses might be repeated.

[Example C3-1](#) describes one case of how this can happen. The LDM, STM, and LDC instructions are examples of instructions that cause multiple memory operations.

### Example C3-1 Illegal memory accesses caused by a watchpoint on Device or Strongly-ordered memory

---

If the first memory operation of an STM instruction does not generate a Watchpoint, but the second memory operation of that instruction generates a synchronous Watchpoint debug event, then when the instruction is re-tried following processing of the debug event, the first memory operation is repeated. This behavior is not normally permitted for accesses to Device or Strongly-ordered memory.

---

#### ———— Note ————

[Example C3-1](#) describes a simple case of a watchpoint generating an illegal memory access. However, other illegal access cases are possible, including cases where an illegal access occurs regardless of whether the original instruction is retried. Ensuring that the watchpoint is generated on the first access made by any instruction that generates multiple memory accesses avoids these possible illegal accesses.

---

ARM strongly recommends that a debugger does not set a watchpoint on any address in a region of Device or Strongly-ordered memory that the watchpointed instruction might access other than as the first memory access that it generates. A debugger can use the address range masking features of watchpoints to set a watchpoint on an entire region of Device or Strongly-ordered memory, ensuring a synchronous Watchpoint debug event is taken on the first access made by such an instruction.

On a synchronous Watchpoint debug event, the `DBGDSCR.MOE`, Method of debug entry field, is set to Synchronous watchpoint debug event. See [DBGDSCR, Debug Status and Control Register on page C11-2241](#).

### Asynchronous Watchpoint debug events

An asynchronous Watchpoint debug event acts like a precise asynchronous abort. Its behavior is:

- The watchpointed instruction *must* have completed, and other instructions that followed it, in program order, might have completed.
- The processor must take the watchpoint before it takes any exceptions that occur in program order after the watchpoint is triggered.
- All the registers written by the watchpointed instruction are updated.
- Any memory accessed by the watchpointed instruction is updated.

#### ———— Note ————

When `SCTLR.FI` is set to 1, to enable the low interrupt latency configuration, an implementation can permit interrupts and asynchronous aborts to be taken during a sequence of memory transactions generated by a load/store instruction. For more information, see [Low interrupt latency configuration on page B1-1197](#). This means an exception can be generated after the watchpoint is generated, but before the instruction completes. In this case, the exception is taken, and the watchpoint is regenerated when the exception handler completes and re-executes the instruction. This means that a write might update the memory location without the watchpoint being taken.

Low interrupt latency configuration does not permit an asynchronous watchpoint to be taken before the instruction completes.

---

When invasive debug is enabled and Watchpoint debug events are permitted, an asynchronous Watchpoint debug event:

- Is ignored if Halting debug-mode and Monitor debug-mode are both disabled.
- Otherwise:
  - If Halting debug-mode is enabled, causes the processor to enter Debug state. For more information, see [Chapter C5 Debug State](#).
  - If Monitor debug-mode is enabled, generates a precise asynchronous Data Abort exception. For more information, see [Generation of debug events on page C3-2074](#).

An asynchronous Watchpoint debug event is not an external abort or an asynchronous abort. An asynchronous Watchpoint debug event:

- is not affected by the [SCR.EA](#) bit
- is not ignored when the [CPSR.A](#) bit is set to 1.

On an asynchronous Watchpoint debug event, the [DBGDSCR.MOE](#), Method of debug entry field, is set to Asynchronous watchpoint debug event.

## C3.5 Vector catch debug events

The Vector Catch Register, [DBGVCR](#), controls Vector catch debug events, which trap exceptions based on the vector address or exception type. This section gives general information about Vector catch debug events.

Vector catch debug events are generated in one of the following ways:

**Address matching** A debug event occurs if the virtual address of an instruction matches the vector address for an exception. The debug event occurs when the instruction is committed for execution, regardless of whether the instruction passes its condition code check.

[Vector catch using address matching on page C3-2067](#) described this method of generating Vector catch debug events.

**Exception trapping** A debug event occurs when an exception occurs. This feature is only available in v7.1 Debug.

[Vector catch using exception trapping on page C3-2071](#) described this method of generating Vector catch debug events.

### ———— Note —————

An enabled address-matching Vector catch catches any access to the corresponding vector address. An enabled exception-trapping Vector catch catches any exception that would be handled using the corresponding vector address. This means that, in an implementation that includes the Virtualization Extensions, Vector catch applied to Virtual IRQs, Virtual FIQs, and Virtual Aborts, as well to the physical exceptions.

For more information on exception handling and vectoring see [Exception handling on page B1-1164](#).

If [DBGDIDR.DEVID\\_imp](#) is RAZ, meaning [DBGDEVID](#) is not implemented, then the Address matching form of Vector catch is implemented. Otherwise, the Debug Device ID Register, [DBGDEVID](#), indicates the implemented form of Vector catch.

In both cases, the processor checks that the value of the appropriate bit of the [DBGVCR](#) is 1, indicating that vector catch is enabled for that vector or exception.

The behavior of Vector catch when using address matching or exception trapping differs in the following ways:

- In address matching, any instruction address that matches with a vector address, generates a debug event, provided all other conditions are met. Testing does not check if the instruction is executed as a result of an exception entry.  
That is, there might be spurious Vector catch debug events that are not generated by exceptions, but by branches to the exception vector address. For example, on return from a nested exception or when simulating an exception entry.
- In exception trapping, matches only occur as part of exception entry, meaning Vector catch debug events are not generated for other branches to the exception vectors.
- In address matching, the Vector catch debug event has lower priority than a Prefetch Abort exception generated by the instruction fetch from the vector address. The exception entry can also be abandoned to take a pending asynchronous exception. In both cases the Vector catch debug event will be generated again when the nested exception handler branches back to the exception address.
- In exception trapping, the Vector catch is outside the scope of the prioritization described in [Exception priority order on page B1-1168](#) and [Debug event prioritization on page C3-2076](#), because it causes a debug event as part of the exception entry for an exception that has been prioritized as described in those sections.

ARM deprecates any use of Vector catch when Monitor debug-mode is selected.

The following sections describe Vector catch debug events

- [Generation of Vector catch debug events on page C3-2066](#)
- [Vector catch using address matching on page C3-2067](#)
- [Vector catch using exception trapping on page C3-2071](#).

### C3.5.1 Generation of Vector catch debug events

If all the conditions for a Vector catch debug event are met, the debug logic generates the event regardless of the mode in which the processor is executing:

- When using address matching, the debug logic tests for any possible Vector catch debug events before the processor executes the instruction. See [Vector catch using address matching on page C3-2067](#) for details.
- When using exception trapping, the debug logic tests for any possible Vector catch debug events when the exception is generated. See [Vector catch using exception trapping on page C3-2071](#) for details.

When invasive debug is enabled and Vector catch debug events are permitted, a Vector catch debug event:

- Causes the processor to enter Debug state when Halting debug-mode is enabled. See [Chapter C5 Debug State](#).
- Generates a Prefetch Abort exception when Monitor debug-mode is enabled. For more information, see [Generation of debug events on page C3-2074](#).
- Is ignored if Halting debug-mode and Monitor debug-mode are both disabled.

On a Vector catch debug event, the `DBGDSCR.MOE`, Method of debug entry field, is set to Vector catch debug event.

———— **Note** —————

A Vector catch debug event is taken only when the instruction is committed for execution and therefore might not be taken if another exception occurs. See [Debug event prioritization on page C3-2076](#).

When invasive debug is enabled and Monitor debug-mode is selected, the behavior of a Vector catch debug event defined on the Prefetch Abort vector or the Data Abort vector is UNPREDICTABLE, and can lead to an unrecoverable state, if either:

- the processor is in Secure state
- the processor is in a Non-secure PL1 or PL0 mode and debug events from these modes are not routed to PL2.

This applies to both address matching and exception trap Vector catch debug events.

ARM deprecates any use of Vector catch when Monitor debug mode is selected.

#### Monitor debug-mode Vector catch on Secure Monitor Call

If Vector catch is used when invasive debug is enabled and Monitor debug-mode is selected, care must be taken if programming a Vector catch debug event on the Secure Monitor Call vector. If such an event is programmed, the following sequence can occur:

1. Non-secure code executes an SMC instruction.
2. The processor takes the Secure Monitor Call exception, branching to the Secure Monitor Call vector in Monitor mode. The value of the `SCR.NS` bit is 1, indicating the SMC was executed in Non-secure state.
3. The processor takes the Vector catch debug event. Although `SCR.NS` is set to 1, the processor is in the Secure state because it is in Monitor mode.
4. The processor jumps to the Secure Prefetch Abort vector, and sets `SCR.NS` to 0.

———— **Note** —————

Taking an abort in Secure state sets `SCR.NS` to 0.

5. The exception handler at the Secure Prefetch Abort exception handler can tell a Vector catch debug event occurred, and can determine the address of the SMC instruction from `LR_mon`. However, it cannot determine whether that is a Secure or Non-secure address.

Therefore, ARM recommends that debuggers do not program a Vector catch debug event on the Secure Monitor Call vector when invasive debug is enabled and Monitor debug-mode is selected.

———— **Note** ————

This is not a security issue, because the sequence given here can only occur when invasive debug is enabled for Secure PL1 mode.

### C3.5.2 Vector catch using address matching

For Vector catch debug events, other than the Reset Vector catch, the debug logic determines whether to generate a Vector catch debug event by comparing the address of every instruction committed for execution with an address from a set of vector addresses for which Vector catch is enabled. The set of vector addresses used depends on which extensions the implementation includes:

- If the implementation does not include the Security Extensions, the debug logic compares every instruction fetch, in all modes, with the *Local vector addresses*.
- If the implementation includes the Security Extensions, the debug logic compares:
  - every Secure instruction fetch at PL0 and PL1 with both the *Secure Local vector addresses* and the *Monitor vector addresses*.
  - every Non-secure instruction fetch at PL0 and PL1 with the *Non-secure Local vector addresses*.
  - every Non-secure instruction fetch at PL2 with the *Hyp vector addresses*, if the implementation includes the Virtualization Extensions.

For Reset Vector catch debug events, if enabled, the debug logic determines whether to generate a Vector catch debug event by comparing the address of every instruction committed for execution at PL0 or PL1 against a single *Reset vector address*. See [Reset Vector catch using address matching on page C3-2071](#).

#### Vector address sets

Vector catch is enabled by bits in the **DBGVCR**. The following tables show these controls, and the caught vectors, for each of the possible vector address sets.

##### Local vector addresses

The Local vector addresses are used if the implementation does not include the Security Extensions. [Table C3-6](#) shows the vector addresses that are used. The vector addresses used depends on whether the **SCTLR.V** bit is set for low or high exception vectors.

**Table C3-6 Local vector addresses**

Vector catch enable		Exception vectors	
<b>DBGVCR</b> control bit	Exception	Low, <b>SCTLR.V</b> == 0	High, <b>SCTLR.V</b> == 1
SF	FIQ interrupt	0x0000001C	0xFFFF001C
SI	IRQ interrupt	0x00000018	0xFFFF0018
SD	Data Abort	0x00000010	0xFFFF0010
SA	Prefetch Abort	0x0000000C	0xFFFF000C
SS	Supervisor Call	0x00000008	0xFFFF0008
SU	Undefined Instruction	0x00000004	0xFFFF0004

### Secure Local vector addresses

If the implementation includes the Security Extensions, the Secure Local vector addresses are used, along with the Monitor vector addresses, for every Secure instruction fetch at PL0 and PL1.

Table C3-7 shows the vector addresses used. If **SCTLR.V** is set for low exception vectors, then the address is Vector\_Base Address field in the Secure copy of the Vector Base Address Register, **VBAR<sub>S</sub>**, combined with the offset shown in the table.

**Table C3-7 Secure Local vector addresses**

Vector catch enable		Configured exception vectors	
DBGVCR control bit	Exception	Low, <b>SCTLR.V == 0</b>	High, <b>SCTLR.V == 1</b>
SF	FIQ interrupt	<b>VBAR<sub>S</sub></b> + 0x0000001C	0xFFFF001C
SI	IRQ interrupt	<b>VBAR<sub>S</sub></b> + 0x00000018	0xFFFF0018
SD	Data Abort	<b>VBAR<sub>S</sub></b> + 0x00000010	0xFFFF0010
SA	Prefetch Abort	<b>VBAR<sub>S</sub></b> + 0x0000000C	0xFFFF000C
SS	Supervisor Call	<b>VBAR<sub>S</sub></b> + 0x00000008	0xFFFF0008
SU	Undefined Instruction	<b>VBAR<sub>S</sub></b> + 0x00000004	0xFFFF0004

### Non-secure Local vector addresses

If the implementation includes the Security Extensions, the Non-secure Local vector addresses are used for every Non-secure instruction fetch at PL0 and PL1.

Table C3-8 shows the vector addresses used. If **SCTLR.V** is set for low exception vectors, then the address is Vector\_Base Address field in the Non-secure copy of the Vector Base Address Register, **VBAR<sub>NS</sub>**, combined with the offset shown in the table.

**Table C3-8 Non-secure Local vector addresses**

Vector catch enable		Configured exception vectors	
DBGVCR control bit	Exception	Low, <b>SCTLR.V == 0</b>	High, <b>SCTLR.V == 1</b>
NSF	FIQ interrupt	<b>VBAR<sub>NS</sub></b> + 0x0000001C	0xFFFF001C
NSI	IRQ interrupt	<b>VBAR<sub>NS</sub></b> + 0x00000018	0xFFFF0018
NSD	Data Abort	<b>VBAR<sub>NS</sub></b> + 0x00000010	0xFFFF0010
NSP	Prefetch Abort	<b>VBAR<sub>NS</sub></b> + 0x0000000C	0xFFFF000C
NSS	Supervisor Call	<b>VBAR<sub>NS</sub></b> + 0x00000008	0xFFFF0008
NSU	Undefined Instruction	<b>VBAR<sub>NS</sub></b> + 0x00000004	0xFFFF0004



### Monitor vector addresses

If the implementation includes the Security Extensions, the Monitor vector addresses are used, along with the Secure Local vector addresses, for every Secure instruction fetch at PL0 and PL1.

Table C3-9 shows the vector addresses used. The address is Vector\_Base Address field in the Monitor Vector Base Address Register (MVBAR), combined with the offset shown in the table.

**Table C3-9 Monitor vector addresses**

Vector catch enable		Monitor vector addresses
DBGVCR control bit	Exception	
MF	FIQ interrupt	MVBAR + 0x0000001C
MI	IRQ interrupt	MVBAR + 0x00000018
MD	Data Abort	MVBAR + 0x00000010
MP	Prefetch Abort	MVBAR + 0x0000000C
MS	Secure Monitor Call	MVBAR + 0x00000008

### Hyp vector addresses

If the implementation includes the Virtualization Extensions, the Hyp vector addresses are used for every Non-secure instruction fetch at PL2.

Table C3-10 shows the vector addresses used. The address is Vector\_Base Address field in the Hyp Vector Base Address Register, HVBAR, combined with the offset shown in the table.

**Table C3-10 Hyp vector addresses**

Vector catch enable		Hyp vector addresses
DBGVCR control bit	Exception	
NSHF	FIQ interrupt	HVBAR + 0x0000001C
NSHI	IRQ interrupt	HVBAR + 0x00000018
NSHE	Hyp Trap, or Hyp mode entry <sup>a</sup>	HVBAR + 0x00000014
NSHD	Data Abort, from Hyp mode	HVBAR + 0x00000010
NSHP	Prefetch Abort, from Hyp mode	HVBAR + 0x0000000C
NSHC	Hypervisor Call, from Hyp mode	HVBAR + 0x00000008
NSHU	Undefined Instruction, from Hyp mode	HVBAR + 0x00000004

a. For more information, see *Use of offset 0x14 in the Hyp vector table on page B1-1167*.

### Generating Vector catch debug events using address matching

The debug logic generates a Vector catch debug event when all of the following apply:

- The address of an instruction matches a vector address.
- The instruction is committed for execution.
- The appropriate bit in the DBGVCR is set to 1.

Any instruction address match with an exception vector address triggers a Vector catch debug event. Testing for possible Vector catch debug events does not check whether the instruction is executed as a result of an exception entry.

Whether the debug logic generates a Vector catch debug event for an instruction is UNPREDICTABLE if:

- The exception vector address is word-aligned, the instruction address is not the exception vector address, but one of the following applies:
  - the instruction is a Thumb or ThumbEE instruction, and the instruction address is (exception vector address + 2)
  - the instruction is a 32-bit Thumb or ThumbEE instruction, and the instruction address is (exception vector address - 2)
  - the instruction is a Java bytecode, and at least one byte of the Java bytecode and its associated parameters is in the word of memory at the exception vector address.
- The exception vector address is not word-aligned but is halfword-aligned, the instruction address is not the exception vector address, but one of the following applies:
  - the instruction is an ARM instruction, or a 32-bit Thumb or ThumbEE instruction, and the instruction address is (exception vector address - 2)
  - the instruction is a Java bytecode, and at least one byte of the Java bytecode and its associated parameters is in the halfword of memory at the exception vector address.

———— **Note** —————

Normally, exception vector addresses must be word-aligned. However, when `SCTLR.VE` is set to 1, enabling vectored interrupt support, the exception vector address for one or both of the IRQ and FIQ vectors might not be word-aligned. Support for exception vector addresses that are not word-aligned is IMPLEMENTATION DEFINED. See [Vectored interrupt support on page B1-1167](#).

### **Address matching when an implementation includes the Security Extensions**

Generation of Vector catch debug events also depends on the security state of the processor:

- the Non-secure state Vector catches are generated only in Non-secure PL0 and Non-secure PL1 modes
- the Secure state Vector catches are generated only in Secure state.

If Reset Vector catch is enabled, when using address matching, the debug logic generates Reset Vector catches regardless of the security state of the processor.

Generation of Vector catch debug events using address matching takes no account of the `SCR`. {IRQ, FIQ, EA} values. For example, if the `DBGVCR` is programmed to catch Secure state IRQs on the Monitor mode vector, by setting `DBGVCR.MI` to 1, and the processor is in the Secure state, the debug logic generates a Vector catch debug event on any instruction fetch from (`MVBAR + 0x18`). It generates this debug event even if `SCR.IRQ` is programmed for IRQs to be taken to IRQ mode.

In addition, a debugger might need to consider the implications of the `SCR` on a Vector catch debug event set on the FIQ vector, when all of the following apply:

- the `SCR.FW` bit set to 0, so the `CPSR.F` bit cannot be modified in Non-secure state
- the `SCR.FIQ` bit set to 0, so that FIQs are taken to FIQ mode
- the address matching form of Vector catch implemented, or Monitor debug-mode selected.

With this configuration, if an FIQ occurs in Non-secure state, the processor does not set `CPSR.F` to 1 to disable FIQs, and so the processor repeatedly takes the FIQ exception.

It might not be possible to debug this situation using the Vector catch on FIQ because the instruction at the FIQ exception vector is never committed for execution and therefore the debug event never occurs.

### **Address matching when an implementation includes the Virtualization Extensions**

When an implementation includes the Virtualization Extensions, the addresses used for comparison are both:

- as described for the Security Extensions
- the Hyp vector addresses for every Non-secure instruction fetch at PL2.

Reset Vector catches are only generated in PL0 and PL1 modes. See also [Reset Vector catch using address matching on page C3-2071](#).

Generation of Vector catch debug events using address matching takes no account of the values of HCR.{IMO, FMO, AMO}. For example, if the [DBGVCR](#) is programmed to catch Hyp mode IRQs, by setting [DBGVCR.NSHI](#) to 1, and the processor is in the Non-secure PL2 mode, the debug logic generates a Vector catch debug event on any instruction fetch from ([HVBAR](#) + 0x18). It generates this debug event even if [HCR.IMO](#) is programmed for physical IRQs to be taken to a PL1 mode.

### Reset Vector catch using address matching

The value of the Reset vector is:

- 0x00000000 if [SCTLR.V](#)==0
- 0xFFFF0000 if [SCTLR.V](#)==1.

That is, it is always independent of the [Vector\\_Base\\_Address](#) field in the [VBAR](#), [MVBAR](#), or [HVBAR](#) registers.

An implementation can include a configuration input signal that determines the reset value of the [SCTLR.V](#) bit. For the Reset vector only, it is IMPLEMENTATION DEFINED whether the value of the Reset vector address depends on this reset value or on the current value of [SCTLR.V](#).

When Reset Vector catch is enabled, the address comparison is made for all instructions executed at PL0 or at PL1. If the implementation includes the Security Extension they are made in both security states.

### Vector catch using address matching and vectored interrupt support

The ARM architecture provides support for vectored interrupts, where an interrupt controller provides the interrupt vector address directly to the processor. The mechanism for defining the vectors is IMPLEMENTATION DEFINED. Software enables the use of vectored interrupts by setting the [SCTLR.VE](#) bit to 1.

From the introduction of the Virtualization Extensions, ARM deprecates any use of the [SCTLR.VE](#) bit.

For more information see [Vectored interrupt support on page B1-1167](#).

If [SCTLR.VE](#) is set to 1, then the Local vector addresses for interrupts are the addresses supplied by the interrupt controller. In this case:

- if the interrupt controller has not supplied an interrupt address to the processor since vectored interrupt support was enabled then the debug logic does not generate any Vector catch debug events using Local vector addresses
- if Vector catch on a particular interrupt vector is otherwise enabled and permitted, it is UNPREDICTABLE whether the debug logic generates a Vector catch debug event when the address of an instruction matches that Local vector address if either:
  - Vector catch on that vector was not enabled, or not permitted, when the interrupt controller supplied the corresponding vector address to the processor
  - Vector catch on that vector has been disabled, or become not permitted, since the interrupt controller supplied the corresponding vector address to the processor.

## C3.5.3 Vector catch using exception trapping

When the supported form of Vector catch is exception trapping, the taking of an exception generates a Vector catch debug event. This means that, when a trapped exception is generated:

1. The exception entry for that exception is performed, see [Overview of exception entry on page B1-1170](#).
2. The Vector catch debug event is generated.

The processor does not execute any instructions between these two stages.

#### ————— Note —————

- The exception trapping form is only available in v7.1 Debug.
- Because the generation of the Vector catch debug event always occurs as an additional step at the end of an exception entry, the exception trap form of Vector catch debug events is outside the scope of [Exception priority order on page B1-1168](#)

If the implementation does not include the Security Extensions, the debug logic determines whether to generate a Vector catch debug event by comparing the type of exception with a control bit in the [DBGVCR](#). The exceptions trapped are:

- those shown in [Table C3-6 on page C3-2067](#)
- Reset, controlled by [DBGVCR.R](#).

If the implementation includes the Security Extensions, the debug logic determines whether to generate a Vector catch debug event using the following bits in the [DBGVCR](#):

- The following sets of bits:
  - A set for exceptions taken to Non-secure PL1 modes. The exceptions trapped are shown in [Table C3-8 on page C3-2068](#).
  - A set for exceptions taken to Secure PL1 modes other than Monitor mode. The exceptions trapped are shown in [Table C3-7 on page C3-2068](#).
  - A set for exceptions taken to Monitor mode. The exceptions trapped are shown in [Table C3-9 on page C3-2069](#).
- [DBGVCR.R](#), that controls trapping of the Reset exception. When Vector catch using exception trapping is implemented, Reset can be trapped only in Secure state.

———— **Note** ————

By contrast, when Vector catch using address matching is implemented, Reset Vector catches can be generated in either security state.

If the implementation includes the Virtualization Extensions, the debug logic also uses an additional set of bits in the [DBGVCR](#):

- A set for exceptions taken to Hyp mode. The exceptions trapped are shown in [Table C3-10 on page C3-2069](#).

———— **Note** ————

The determination of whether a vector is trapped takes account of where the exception is routed, as well as the exception type. For example, when [HCR.TGE](#) is set to 1, an Undefined Instruction generated in the Non-secure PL0 mode is routed to Hyp mode. Therefore, whether a Vector catch debug event is generated on the exception depends only on [DBGVCR.NSHE](#), and not on [DBGVCR.NSHU](#) or [DBGVCR.NSU](#), because:

- [DBGVCR.NSHU](#) controls only whether an Undefined Instruction exception taken from Hyp mode generates a Vector catch debug event
- [DBGVCR.NSU](#) controls only whether an Undefined Instruction exception not routed to Hyp mode generates a Vector catch debug event.

The debug logic generates a Vector catch debug event when all of the following apply:

- An exception is generated.
- The appropriate bit in the [DBGVCR](#) is set to 1.

When an exception is taken from Secure User mode, any corresponding Vector catch debug event is generated in a Secure PL1 mode, and therefore the debug event is taken only if debug events are permitted in Secure PL1 modes.

## C3.6 Halting debug events

A Halting debug event is one of the following:

- An External debug request debug event. This is a request from the system for the processor to enter Debug state.  
The method of generating an External debug request is IMPLEMENTATION DEFINED. Typically it is by asserting an External debug request input to the processor.
- A Halt request debug event. This occurs when the debug logic receives a Halt request command. A debugger generates a Halt request command by writing 1 to [DBGDRCR.HRQ](#), the Halt request bit.
- An OS Unlock catch debug event. This occurs when both:
  - the OS Unlock catch is enabled in the Event Catch Register
  - the OS Lock transitions from the locked to the unlocked condition.

For details see [DBGECR, Event Catch Register on page C11-2261](#) and [DBGOSLAR, OS Lock Access Register on page C11-2267](#).

If invasive debug is disabled when one of these events occurs, the request is ignored and no Halting debug event occurs. See [Chapter C2 Invasive Debug Authentication](#) for a description of when invasive debug is disabled.

While invasive debug is enabled, if a Halting debug event occurs when it is not permitted, the Halting debug event becomes pending. A Halting debug event is not permitted:

- In an implementation that includes the Security Extensions, if the processor is in Secure state, and halting debug is not permitted in Secure PL1 modes. For more information, see [Halting debug events on page C2-2031](#).
- In an implementation that has separate core and debug power domains, if the core power domain is powered down. For more information, see [Power domains and debug on page C7-2149](#).

———— **Note** —————

OS Unlock catch debug events cannot occur when the core power domain is powered down.

- In v7.1 Debug implementation, if the [DBGPRSR.DLK](#) bit is set to 1.

If a Halting debug event is pending, the processor enters Debug state when the Halting debug event becomes permitted. A Halting debug event can only occur and become pending while invasive debug is enabled and the debug logic is powered up. However, if after the Halting debug event occurred and became pending:

- Invasive debug is disabled, whether the event remains pending is UNPREDICTABLE.
- The debug power domain is powered down, or the debug logic in the debug power domain is reset, the processor must remove any pending Halt request debug event. Whether it must remove a pending External debug request debug event is IMPLEMENTATION DEFINED.

———— **Note** —————

The IMPLEMENTATION DEFINED details of an External debug request implementation might specify that the peripheral driving the request keeps the request pending until the processor acknowledges the request by entering Debug state. Such a system typically holds the pending request over a debug logic reset.

- The core power domain is powered down, or the debug logic in the core power domain is reset, the processor must remove any pending OS Unlock catch debug event.

If a Halting debug event occurs when debug is enabled and the event is permitted, or a Halting debug event becomes permitted while it is pending, then Debug state is entered by the end of the next context synchronization operation.

See [Run-control and cross-triggering signals on page AppxA-2340](#) for details of the recommended external debug interface.

## C3.7 Generation of debug events

The generation of BKPT, Breakpoint, Watchpoint, and Vector catch debug events can depend on the context of the processor, including:

- the current processor mode
- the settings in system registers, including [CONTEXTIDR](#), [VBAR](#), [MVBAR](#), and [HVBAR](#)
- the security state, if the implementation includes Security Extensions

The generation of debug events also depends on the state of the debug logic:

- Breakpoint debug events depend on the settings of the relevant breakpoint
- Watchpoint debug events depend on the settings of the relevant watchpoint
- Linked Breakpoint or Watchpoint debug events depend on the settings of the linked breakpoint
- Vector catch debug events depend on the settings in the [DBGVCR](#)
- OS Unlock catch debug events depend on the setting of the *Event Catch Register*, [DBGECR](#).

In addition, as shown in [Table C3-1 on page C3-2036](#), the processing of debug events depends on:

- the invasive debug authentication settings, see [Chapter C2 Invasive Debug Authentication](#)
- the values of the [DBGDSCR.HDBGen](#), Halting debug enable, and [DBGDSCR.MDBGen](#), Monitor debug enable, see [DBGDSCR, Debug Status and Control Register on page C11-2241](#).

The following operations are guaranteed to affect the generation and processing of debug events by the end of the next context synchronization operation:

- Context changing operations, including:
  - mode changes
  - writes to system registers
  - security state changes.
- Operations that change the state of the debug logic, including:
  - writes to debug registers
  - changes to the authentication signals.

To ensure an operation has completed before a particular event or piece of code is debugged you must include a context synchronization operation after the operation. In the absence of a context synchronization operation, it is UNPREDICTABLE when the operation takes effect. Between such an operation and the end of the next context synchronization operation it is UNPREDICTABLE whether the generation and processing of debug events depends on the old or the new context. [Example C3-2](#) describes such a case.

### Example C3-2 Unpredictability in debug event generation

---

A breakpoint is set at an address programmed in a [DBGBVR](#) and configured through a [DBGBCR](#). In this example:

- [DBGBCR](#) is programmed to only match in User, Supervisor or System modes
- the address in the [DBGBVR](#) is the address of an instruction in an exception handler routine normally entered from the Prefetch Abort exception vector in Abort mode, but located after that handler switches from Abort mode to Supervisor mode using a CPS instruction.

If there is no context synchronization operation between the CPS instruction and the instruction at the breakpoint address, it is UNPREDICTABLE whether a breakpoint debug event is generated, even though the instruction is executed in Supervisor mode.

Such a context synchronization operation is usually not required to ensure correct operation of the program. In this example because the program is switching between two PL1 modes an ISB is not required to ensure correct operation of the memory system.

---

---

**Note**

---

Usually, an exception return sequence is a context change operation as well as a context synchronization operation, in which case the context change operation is guaranteed to take effect on the debug logic by the end of that exception return sequence.

---

ARMv7 does not require that such changes take effect on instruction fetches from the memory system, or on memory accesses made by the processor, at the same point as they take effect on the debug logic. The only architectural requirement is that such a change executed before a context synchronization operation must be visible to both the memory system and the debug logic for all instructions executed after the context synchronization operation. This requirement is described earlier in this section.

The processor must test for any possible:

- Watchpoint debug event before a memory access operation is observed
- Breakpoint debug event before the instruction is executed, that is, before the instruction has any effect on the architectural state of the processor.
- Vector catch debug event after any exception has had its effect on the architectural state of the processor and before the instruction at the vector has executed, that is, before the instruction has any effect on the architectural state of the processor.

As a result, for an instruction that modifies the context in which the processor tests for debug events, the processor must test for all possible debug events using the context before the memory access operation is observed or the instruction executes. For example:

- In a debug implementation that uses the memory-mapped interface, a write to the [DBGWCR](#) to enable a watchpoint on a the virtual address of the [DBGWCR](#) itself must not trigger the watchpoint.  
Conversely, a write to the [DBGWCR](#) to disable the same watchpoint must trigger the watchpoint. For more information, see [Debug exceptions in debug monitors on page C4-2090](#).
- An instruction that writes to a [DBGBCR](#) or [DBGVCR](#) to enable a debug event on the virtual address of the instruction itself must not trigger the debug event.  
Conversely, a write to the [DBGBCR](#) or [DBGVCR](#) to disable the same debug event must trigger the debug event.

## C3.8 Debug event prioritization

Debug events can be synchronous or asynchronous:

- Breakpoint, Vector catch, BKPT instruction, and synchronous Watchpoint debug events are all synchronous debug events
- asynchronous Watchpoint debug events and all Halting debug events are asynchronous debug events.

A single instruction can generate a number of synchronous debug events. It can also generate a number of synchronous exceptions. The behavior described in [Exception priority order on page B1-1168](#) applies to those exceptions and debug events. In addition:

- An instruction fetch that generates an MMU fault, MPU fault, or synchronous external abort cannot generate a Breakpoint debug event.
- An instruction fetch from an exception vector address that generates an MMU fault, MPU fault, or synchronous external abort cannot generate an address matching Vector catch debug event.

———— **Note** —————

If fetching a single instruction generates debug events or aborts on more than one instruction fetch, the architecture does not define any prioritization between those debug events and aborts. See also [Single-copy atomicity on page A3-127](#).

- If a single instruction fetch has more than one of the following debug events associated with it, it is UNPREDICTABLE which is taken:
  - Breakpoint debug event
  - Address matching Vector catch debug event.
- A memory access that generates an MMU fault or an MPU fault cannot generate a Watchpoint debug event.
- If a single instruction generates aborts or Watchpoint debug events on more than one memory access, the architecture does not define any prioritization between those aborts or Watchpoint debug events.

The Exception trapping form of the Vector catch debug event, introduced in v7.1 Debug, causes a debug event as a result of trapping an exception that has been prioritized as described in [Exception priority order on page B1-1168](#) and this section. This means it is outside the scope of the description in this section. For more information see [Vector catch debug events on page C3-2065](#).

———— **Note** —————

- If such a Vector catch debug event is generated, whether the processor makes an instruction fetch request from the exception vector address is UNPREDICTABLE.
- In v7 Debug, the only supported Vector catch debug events are address matching Vector catch debug events.

The ARM architecture does not define when asynchronous debug events other than asynchronous Watchpoint debug events are taken. Therefore the prioritization of asynchronous debug events other than asynchronous Watchpoint debug events is IMPLEMENTATION DEFINED.

Debug events must be taken in the execution order of the sequential execution model. This means that if an instruction causes a debug event then that event must be taken before any debug event on any instruction that, in the sequential execution model, would execute after that instruction.

If the execution of an instruction generates an asynchronous Watchpoint debug event:

- the asynchronous Watchpoint debug event must not be taken if the instruction also generates any synchronous debug event
- if the instruction does not generate any synchronous debug event, then the asynchronous Watchpoint debug event must be taken before any subsequent:
  - synchronous or asynchronous debug event



- synchronous or asynchronous precise exception.

If the execution of an instruction generates an asynchronous Watchpoint debug event but the processor takes an imprecise asynchronous Data Abort exception before taking the debug event, it is UNPREDICTABLE whether it takes the debug event.

———— **Note** —————

The definition of UNPREDICTABLE requires that, when invasive debug is disabled or not permitted in Secure PL1 modes, the debug event is not taken if, as a result of taking the imprecise exception, `SCR.NS` is 0. This is because taking the debug event would be a security hole.

If the taking of an exception generates an Exception trapping form of the Vector catch debug event, then the Vector catch debug event must be taken before any subsequent asynchronous precise exception.

## C3.9 Pseudocode details of Software debug events

The following subsections give pseudocode details of Software debug events:

- [Debug events](#)
- [Breakpoints and Vector catches](#)
- [Watchpoints on page C3-2085](#).

### C3.9.1 Debug events

The following functions cause the corresponding debug events to occur:

```
BKPTInstrDebugEvent()  
BreakpointDebugEvent()  
VectorCatchDebugEvent()  
WatchpointDebugEvent()
```

If the debug event is not permitted, it is ignored by the processor.

### C3.9.2 Breakpoints and Vector catches

If invasive debug is enabled, on each instruction the `Debug_CheckInstruction()` function checks for Breakpoint and Vector catch matches. If a match is found the function calls `BreakpointDebugEvent()` or `VectorCatchDebugEvent()`. If the debug event is not permitted, it is ignored by the processor.

On a simple sequential execution model, the `Debug_CheckInstruction()` call for an instruction occurs just before the operation pseudocode for the instruction is executed, and any call it generates to `BreakpointDebugEvent()` or `VectorCatchDebugEvent()` must happen at that time. However, the architecture does not define when the checks for Breakpoint and Vector catch matches are made, other than that they must be made at or before that time. Therefore an implementation can perform the checks much earlier in an instruction pipeline, marking the instruction as breakpointed, and cause the marked instruction to call `BreakpointDebugEvent()` or `VectorCatchDebugEvent()` if and when it is about to execute.

The `BreakpointMatch()` function checks an individual breakpoint match. To check for a match, this function calls the `BreakpointValueMatch()` and `BreakpointWatchpointStateMatch()` functions, that in turn, if necessary call the `BreakpointLinkMatch()` function to check whether the linked breakpoint matches.

For all functions in this subsection, between a context changing operation and a context synchronization operation, it is UNPREDICTABLE whether the values of `CurrentModeIsNotUser()`, `CPSR.M`, `CurrentInstrSet()`, `FindSecure()`, and the `CONTEXTIDR` used by `BreakpointMatch()`, `BreakpointValueMatch()`, `BreakpointWatchpointStateMatch()`, `BreakpointLinkMatch()`, and `VCRMatch()` are the old or the new values.

```
// Debug_CheckInstruction()  
// =====  
  
Debug_CheckInstruction(bits(32) address, integer length)  
    // Do nothing if debug disabled.  
    if DBGDSCR.HDBGGen == '0' && DBGDSCR.MDBGGen == '0' then return;  
  
    case CurrentInstrSet() of  
        when InstrSet_ARM  
            step = 4;  
        when InstrSet_Thumb, InstrSet_ThumbEE  
            step = 2;  
        when InstrSet_Jazelle  
            step = 1;  
    length = length / step;  
  
    vcr_match = FALSE;  
    breakpoint_match = FALSE;  
  
    // Each unit of the instruction is checked against the VCR and the breakpoints.  
    // VCRMatch() and BreakpointMatch() might return UNKNOWN, as in some cases the  
    // generation of Debug events is UNPREDICTABLE.  
    for W = 0 to length-1
```

```

// This code only illustrates the address-matching form of Vector catch.
vcr_match = VCRMatch(address, W == 0) || vcr_match;

// This code does not take into account the case where a mismatch breakpoint
// does not match the address of an instruction but another breakpoint or
// Vector catch does match the instruction. In that situation, generation of
// the Debug event is UNPREDICTABLE.
for N = 0 to UInt(DBGDIDR.BRPs)
    breakpoint_match = BreakpointMatch(N, address, W == 0) || breakpoint_match;

address = address + step;

// A suitable debug event occurs if there has been a Breakpoint match or a VCR match. If
// both have occurred, just one debug event occurs, and its type is IMPLEMENTATION
// DEFINED.
if vcr_match || breakpoint_match then
    if !vcr_match then BreakpointDebugEvent();
    elseif !breakpoint_match then VectorCatchDebugEvent();
    else IMPLEMENTATION_DEFINED either BreakpointDebugEvent() or VectorCatchDebugEvent();

return;

// BreakpointMatch()
// =====

boolean BreakpointMatch(integer N, bits(32) address, boolean first)
    assert N <= UInt(DBGDIDR.BRPs);

    // If this breakpoint is not enabled, return immediately.
    if DBGBCR[N].E == '0' then return FALSE;

    state_match = BreakpointWatchpointStateMatch(DBGBCR[N].SSC, DBGBCR[N].HMC, DBGBCR[N].PMC,
        DBGBCR[N].BT IN "0x01" /*linked*/,
        DBGBCR[N].LBN, FALSE/*T*/, TRUE/*allow_SSU*/);

    (BVR_match, mon_debug_ok) = BreakpointValueMatch(N, FALSE/*linked_to*/, address, first);

    match = BVR_match && state_match;

    // When Monitor debug-mode is configured some types of event are UNPREDICTABLE.
    if match && !mon_debug_ok && DBGDSCR.MDBGGen == '1' && DBGDSCR.HDBGGen == '0' then
        // If Virtualization Extensions are implemented, then these cases are only
        // UNPREDICTABLE if the debug exception is not routed to PL2.
        if !HaveVirtExt() || IsSecure() || CurrentModeIsHyp() || HDCR.TDE == '0' then
            UNPREDICTABLE;

    return match;

// BreakpointLinkMatch()
// =====

boolean BreakpointLinkMatch(integer M)
    if M > UInt(DBGDIDR.BRPs) || M < UInt(DBGDIDR.BRPs - DBGDIDR.CTX_CMPs) then
        unk_match = TRUE;
    elseif DBGBCR[M].E == '0' then return FALSE;

    // Check all control fields are set to their required values
    if DBGBCR[M].PMC != '11' then unk_match = TRUE;
    if DBGBCR[M].BAS != '1111' then unk_match = TRUE;
    if DBGBCR[M].SSC != '00' then unk_match = TRUE;
    if DBGBCR[M].HMC != '0' then unk_match = TRUE;
    if DBGBCR[M].LBN != '0000' then unk_match = TRUE;

    // Check this is configured as a linked context matching breakpoint
    if DBGBCR[M].BT IN "0x0x" then unk_match = TRUE; // Address matching
    if DBGBCR[M].BT<0> != '1' then unk_match = TRUE; // Not linked

    if unk_match then

```

```

        return boolean UNKNOWN;
    else
        (match,-) = BreakpointValueMatch(M, TRUE, bits(32) UNKNOWN, boolean UNKNOWN);
        return match;

// BreakpointValueMatch()
// =====

(boolean,boolean) BreakpointValueMatch(integer N, boolean linked_to, bits(32) address,
boolean first)
    assert N <= UInt(DBGDIDR.BRPs);

// Returns a tuple of (match,mon_debug_ok)

// Decode the breakpoint type
match_addr = DBGBCR[N].BT<3,1> == '00';
match_vmid = DBGBCR[N].BT<3> == '1';
mismatch   = DBGBCR[N].BT<2> == '1';
match_cid  = DBGBCR[N].BT<1> == '1';
linked     = DBGBCR[N].BT<0> == '1';

// Linked context match does not match directly, only via link, so terminate early
if !linked_to && linked && !match_addr then return (FALSE,TRUE);

// BreakpointLinkMatch ensures this function is not called if the breakpoint linked
// to is not configured for Linked context match
if match_addr then assert !linked_to;

// Address mask
case DBGBCR[N].MASK of
    when '00000'
        if match_addr then
            // This implies no mask, but the byte address is always dealt with by
            // byte_select_match, so the mask always has the bottom two bits set.
            mask = ZeroExtend('11', 32);
        else
            mask = Zeros(32);
    when '00001','00010'
        unk_match = TRUE;
    otherwise
        mask = ZeroExtend(Ones(UInt(DBGBCR[N].MASK)), 32);
        if !IsOnes(DBGBCR[N].BAS) then unk_match = TRUE;

// Mismatch address and Unlinked context match are not okay in certain conditions
mon_debug_ok = (if match_addr then !mismatch else linked);

if match_addr then
    // If address masking is not implemented, the mask must be zero
    if DBGDEVID.BPAddrMask == '1111' && !IsZero(mask) then unk_match = TRUE;
elseif match_cid then
    // If context ID masking is not implemented, the mask must be zero
    // If context ID masking is implemented, the mask must be zero or 0xFF
    if DBGDEVID.CIDMask == '0000' then
        if !IsZero(mask) then unk_match = TRUE;
    elseif !IsZero(mask<31:8>) && !(IsZero(mask<7:0>) || IsOnes(mask<7:0>)) then
        unk_match = TRUE;
else
    // If neither address nor Context ID matching, then mask must be zero
    if !IsZero(mask) then unk_match = TRUE;

// Masked bits of the DBG BVR must be zero
if (match_addr || match_cid) && !IsZero(DBGBVR[N] AND mask) then
    unk_match = TRUE;

// Do the actual comparison
if match_addr then
    // Byte address select

```

```

byte = UInt(address<1:0>);
byte_select_match = (DBGBCR[N].BAS<byte> == '1');

// In ARM, Thumb and ThumbEE instruction sets, BAS must match for all bytes
// of the word or halfword (as appropriate). Otherwise a match is UNPREDICTABLE.
if CurrentInstrSet() == InstrSet_ARM then
    assert byte == 0;
    if !(DBGBCR[N].BAS IN {'0000','1111'}) then unk_match = TRUE;
elseif CurrentInstrSet() IN {InstrSet_Thumb, InstrSet_ThumbEE} then
    assert byte IN {0,2};
    if !(DBGBCR[N].BAS<byte+1:byte> IN {'00','11'}) then unk_match = TRUE;

match = (address AND NOT(mask)) == DBGVBR[N] && byte_select_match;
else
    // For context-matching breakpoints, this must be a context-aware breakpoint and
    // BAS must be all-ones.
    if N < UInt(DBGIDR.BRPs - DBGIDR.CTX_CMPs) || !IsOnes(DBGBCR[N].BAS) then
        unk_match = TRUE;
    if match_cid then
        match = (!CurrentModeIsHyp()) && (CONTEXTIDR AND NOT(mask)) == DBGVBR[N];
    else
        // If not matching address or context ID, DBGVBRn must be zero.
        if !IsZero(DBGVBR[N]) then unk_match = TRUE;
        match = TRUE;

if match_vmid then
    if !HaveVirtExt() then unk_match = TRUE;
    match = match && !IsSecure() && !CurrentModeIsHyp() && VTTBR.VMID == DBGXVR[N].VMID;

// Invert if this is a mismatch address match
if mismatch then
    match = !match;
    if !match_addr then unk_match = TRUE;

// If this is not the first unit of the instruction and there is an address match, then
// the breakpoint match is UNPREDICTABLE, except in the "single-step" case where it is a
// mismatch breakpoint without a range set. If there is a match on the first unit of the
// instruction, that will override the UNKNOWN case here. In the single-step case, matches
// on the subsequent units of the instruction are ignored.
if match && !first then
    if mismatch && DBGBCR[N].MASK == '0000' then // Single-step case
        match = FALSE;
    else
        unk_match = TRUE;

if unk_match then
    return (boolean UNKNOWN,mon_debug_ok);
else
    return (match,mon_debug_ok);

// BreakpointWatchpointStateMatch()
// =====

boolean BreakpointWatchpointStateMatch(bits(2) SSC, bit HMC, bits(2) PxC, boolean linked,
                                        bits(4) LBN, boolean T, boolean allow_Ssu)
// 'SSC', 'HMC', 'PxC' and 'LBN' are the SSC, HMC, PMC (breakpoints) or PAC (watchpoints)
// and LBN control fields from the DBGBCR (breakpoints) or DBGWCR (watchpoints)
// 'linked' indicates this is a linked address matching type
// 'T' is guaranteed to be FALSE for a Breakpoint
// 'allow_Ssu' is guaranteed to be FALSE for a Watchpoint

if !HaveVirtExt() then assert HMC == '0'; // Field is reserved
if !HaveSecurityExt() then assert SSC == '00'; // Field is reserved

// Check for illegal combinations of HMC, SSC, PxC and LBN fields
if HMC == '1' then
    case SSC of
        when "0x" if PxC<0> == '0' then unk_match = TRUE;

```

```

        when '10' unk_match = TRUE;
        when '11' if PxC != '00' then unk_match = TRUE;
    elsif SSC == '11' then
        unk_match = TRUE;
    if !linked && LBN != '0000' then unk_match = TRUE;

// Security state
case SSC of
    when '00' secure_state_match = TRUE;           // Any state (or no Security Extensions)
    when '01' secure_state_match = !IsSecure();    // Non-secure only
    when '10' secure_state_match = IsSecure();    // Secure only
    when '11' secure_state_match = TRUE;         // Any state

// Privilege control match (breakpoints) or privilege access match (watchpoints)
PL0_match = PxC<1> == '1';
PL1_match = PxC<0> == '1';
PL2_match = HMC == '1';
SSU_match = HMC == '0' && PxC == '00' && SSC != '11';

if SSU_match then
    if !allow_SSU then
        unk_match= TRUE; priv_match = FALSE;
    else
        priv_match = CPSR.M IN {'10000'/*User*/, '10011'/*Svc*/, '11111'/*System*};
elseif CurrentModeIsHyp() then
    priv_match = PL2_match;
elseif CurrentModeIsNotUser() && !T then
    priv_match = PL1_match;
else
    priv_match = PL0_match;

// If linked (and not linked to), check the linked BRP.
linked_match = !linked || BreakpointLinkMatch(UInt(LBN));

if unk_match then
    return boolean UNKNOWN;
else
    return priv_match && secure_state_match && linked_match;

```

When vectored interrupt support is enabled, the following variables record information about the most recent IRQ and FIQ interrupts, for use by the VCRMatch() pseudocode function. These variables are updated by the VCR\_OnTakingInterrupt() function, that is called each time the processor takes an IRQ or FIQ interrupt exception.

```

// Variables used to record information about the most recent IRQ and FIQ interrupts.
bits(32) VCR_Recent_IRQ_S;
bits(32) VCR_Recent_IRQ_NS;
bits(32) VCR_Recent_FIQ_S;
bits(32) VCR_Recent_FIQ_NS;
boolean VCR_Recent_IRQ_S_Valid;
boolean VCR_Recent_IRQ_NS_Valid;
boolean VCR_Recent_FIQ_S_Valid;
boolean VCR_Recent_FIQ_NS_Valid;

// VCR_OnTakingInterrupt()
// =====

VCR_OnTakingInterrupt(bits(32) vector, boolean FIQnIRQ)
    if SCTL.R.VE == '1' then
        if FIQnIRQ && IsSecure() then
            if DBGVCR.SF == '0' || (HaveSecurityExt() && SCR.FIQ == '1') then
                IMPLEMENTATION_DEFINED whether the variables are updated;
            else
                VCR_Recent_FIQ_S = vector;
                VCR_Recent_FIQ_S_Valid = TRUE;
        elseif FIQnIRQ && !IsSecure() then
            if DBGVCR.NSF == '0' || (HaveSecurityExt() && SCR.FIQ == '1') then
                IMPLEMENTATION_DEFINED whether the variables are updated;
            else

```

```

        VCR_Recent_FIQ_NS = vector;
        VCR_Recent_FIQ_NS_Valid = TRUE;
    elsif !FIQnIRQ && IsSecure() then
        if DBGVCR.SI == '0' || (HaveSecurityExt() && SCR.IRQ == '1') then
            IMPLEMENTATION_DEFINED whether the variables are updated;
        else
            VCR_Recent_IRQ_S = vector;
            VCR_Recent_IRQ_S_Valid = TRUE;
    elsif !FIQnIRQ && !IsSecure() then
        if DBGVCR.NSI == '0' || (HaveSecurityExt() && SCR.IRQ == '1') then
            IMPLEMENTATION_DEFINED whether the variables are updated;
        else
            VCR_Recent_IRQ_NS = vector;
            VCR_Recent_IRQ_NS_Valid = TRUE;

return;

```

When address matching Vector catch is implemented, the VCRMatch() function checks for a Vector catch debug event.

———— **Note** ————

When Exception trapping Vector catch is implemented, the Vector catch debug event is generated on taking the exception. This form of Vector catch does not require a pseudocode description.

```

// VCRMatch()
// =====

boolean VCRMatch(bits(32) address, boolean first)
    a_match = FALSE; // Boolean for a match on an abort vector
    match = FALSE; // Boolean for a match on any other vector

    // Check for reset matches
    // In v7 Debug this check is made regardless of the security state.
    if DBGVCR.R == '1' && !CurrentModeIsHyp() then
        // It is IMPLEMENTATION_DEFINED whether the reset catch matches against a
        // vector address generated by the current value of SCTL.R, or the value
        // this register will take at reset, usually determined by a configuration
        // input signal.
        if IMPLEMENTATION_DEFINED condition then
            reset_vector = IMPLEMENTATION_DEFINED reset vector address;
        else
            reset_vector = if SCTL.R == '1' then Ones(16):Zeros(16) else Zeros(32);
        match = match || VCRVectorMatch(address, first, reset_vector);

    base = ExcVectorBase();

    if IsSecure() then
        // Check for Secure matches
        match = match ||
            (DBGVCR.SU == '1' && VCRVectorMatch(address, first, base+4)) ||
            (DBGVCR.SS == '1' && VCRVectorMatch(address, first, base+8));
        a_match = a_match ||
            (DBGVCR.SP == '1' && VCRVectorMatch(address, first, base+12)) ||
            (DBGVCR.SD == '1' && VCRVectorMatch(address, first, base+16));

        // Check for interrupt vector matches
        if SCTL.R.VE == '0' then
            VCR_Recent_IRQ_S_Valid = FALSE; VCR_Recent_FIQ_S_Valid = FALSE;
            match = match ||
                (DBGVCR.SI == '1' && VCRVectorMatch(address, first, base+24)) ||
                (DBGVCR.SF == '1' && VCRVectorMatch(address, first, base+28));
        else
            if HaveSecurityExt() && SCR.IRQ == '1' then
                IMPLEMENTATION_DEFINED what test is made, if any;
            elsif VCR_Recent_IRQ_S_Valid && DBGVCR.SI == '1' then

```

```

        match = match || VCRVectorMatch(address, first, VCR_Recent_IRQ_S);

    if HaveSecurityExt() && SCR.FIQ == '1' then
        IMPLEMENTATION_DEFINED what test is made, if any;
    elsif VCR_Recent_FIQ_S_Valid && DBGVCR.SF == '1' then
        match = match || VCRVectorMatch(address, first, VCR_Recent_FIQ_S);

    // If we have the Security Extensions then also check for Monitor matches.
    if HaveSecurityExt() then
        match = match ||
            (DBGVCR.MS == '1' && VCRVectorMatch(address, first, MVBAR+8)) ||
            (DBGVCR.MI == '1' && VCRVectorMatch(address, first, MVBAR+24)) ||
            (DBGVCR.MF == '1' && VCRVectorMatch(address, first, MVBAR+28));
        a_match = a_match ||
            (DBGVCR.MP == '1' && VCRVectorMatch(address, first, MVBAR+12)) ||
            (DBGVCR.MD == '1' && VCRVectorMatch(address, first, MVBAR+16));

    elsif CurrentModeIsHyp() then
        // If we have the Virtualization Extensions and are in Non-secure Hyp mode,
        // then check for Hyp matches. These always update 'match,' not 'a_match'.
        match = match ||
            (DBGVCR.NSHU == '1' && VCRVectorMatch(address, first, HVBAR+4)) ||
            (DBGVCR.NSHC == '1' && VCRVectorMatch(address, first, HVBAR+8)) ||
            (DBGVCR.NSHP == '1' && VCRVectorMatch(address, first, HVBAR+12)) ||
            (DBGVCR.NSHD == '1' && VCRVectorMatch(address, first, HVBAR+16)) ||
            (DBGVCR.NSHE == '1' && VCRVectorMatch(address, first, HVBAR+20)) ||
            (DBGVCR.NSHI == '1' && VCRVectorMatch(address, first, HVBAR+24)) ||
            (DBGVCR.NSHF == '1' && VCRVectorMatch(address, first, HVBAR+28));
    else
        // Check for Non-secure, non-Hyp mode matches
        match = match ||
            (DBGVCR.NSU == '1' && VCRVectorMatch(address, first, base+4)) ||
            (DBGVCR.NSS == '1' && VCRVectorMatch(address, first, base+8));
        a_match = a_match ||
            (DBGVCR.NSP == '1' && VCRVectorMatch(address, first, base+12)) ||
            (DBGVCR.NSD == '1' && VCRVectorMatch(address, first, base+16));

        // Check for interrupt vector matches
        if SCTL.R.VE == '0' then
            VCR_Recent_IRQ_NS_Valid = FALSE; VCR_Recent_FIQ_NS_Valid = FALSE;
            match = match ||
                (DBGVCR.NSI == '1' && VCRVectorMatch(address, first, base+24)) ||
                (DBGVCR.NSF == '1' && VCRVectorMatch(address, first, base+28));
        else
            if HaveSecurityExt() && SCR.IRQ == '1' then
                IMPLEMENTATION_DEFINED what test is made, if any;
            elsif VCR_Recent_IRQ_NS_Valid && DBGVCR.NSI == '1' then
                match = match || VCRVectorMatch(address, first, VCR_Recent_IRQ_NS);

            if HaveSecurityExt() && SCR.FIQ == '1' then
                IMPLEMENTATION_DEFINED what test is made, if any;
            elsif VCR_Recent_FIQ_NS_Valid && DBGVCR.NSF == '1' then
                match = match || VCRVectorMatch(address, first, VCR_Recent_FIQ_NS);

        // When Monitor debug-mode is configured, abort Vector catches are UNPREDICTABLE
        // in v7 Debug if not trapped into Hyp mode.
        if a_match && DBGDSCR.MDBGGen == '1' && DBGDSCR.HDBGGen == '0' &&
            (!HaveVirtExt() || HDCR.TDE == '0') then UNPREDICTABLE;

    return match || a_match;

// VCRVectorMatch()
// =====

boolean VCRVectorMatch(bits(32) iaddr, boolean first, bits(32) eaddr)
// The result of this function says whether iaddr and eaddr match for Vector catch:
// TRUE          if they definitely match
// boolean UNKNOWN if it is UNPREDICTABLE whether they match

```



```

// FALSE          if they definitely do not match

match = FALSE;
unk_match = FALSE;

if eaddr<31:2> == iaddr<31:2> then
    if eaddr<1:0> == iaddr<1:0> then
        // Exact address match is a definite match if on the first unit of the instruction,
        // otherwise an UNPREDICTABLE match.
        if first then match = TRUE; else unk_match = TRUE;
    else
        // Check for other cases of UNPREDICTABLE matches.
        case CurrentInstrSet() of
            when InstrSet_ARM
                unk_match = TRUE;
            when InstrSet_Thumb, InstrSet_ThumbEE
                if iaddr<1> == eaddr<1> then unk_match = TRUE;
                if iaddr<1:0> == '10' && eaddr<1:0> == '00' then unk_match = TRUE;
            when InstrSet_Jazelle
                if eaddr<1:0> == '00' then unk_match = TRUE;
                if eaddr<1:0> == '10' && iaddr<1:0> == '11' then unk_match = TRUE;

if match then
    return TRUE;
elsif unk_match then
    return boolean UNKNOWN;
else
    return FALSE;

```

### C3.9.3 Watchpoints

If invasive debug is enabled, the `Debug_CheckDataAccess()` function checks watchpoint matches for each data access. If the implementation includes IMPLEMENTATION DEFINED support for watchpoint generation on memory hint operations, or on cache maintenance operations, the function also checks for watchpoint matches on the appropriate operations. If a match is found the function calls `WatchpointDebugEvent()`. If the debug event is not permitted, it is ignored by the processor.

On a simple sequential execution model, the processor performs the `Debug_CheckDataAccess()` test before the data access, and:

- for a synchronous watchpoint, if the processor takes the Watchpoint debug event then it does not perform the data access
- for an asynchronous watchpoint, the processor does not take the Watchpoint debug event until after the instruction that causes the data access is complete.

For more information see *Synchronous and asynchronous Watchpoint debug events* on page C3-2062.

The `WatchpointMatch()` function checks an individual watchpoint match. To check for a match, this function calls the `BreakpointWatchpointStateMatch()` function, which in turn, if necessary calls the `BreakpointLinkMatch()` function to check whether the linked breakpoint matches.

It is IMPLEMENTATION DEFINED whether watchpoint matching uses eight bits or four bits for byte address select. The `HaveEightBitWatchpointBAS()` function returns TRUE if it uses eight bits and FALSE if it uses four bits.

```
boolean HaveEightBitWatchpointBAS()
```

For these functions the parameters `read`, `write`, `privileged` and `secure` are determined at the point the access is made, and not from the state of the processor at the point where `WatchpointMatch` is executed. For SWP and SWPB, `read = write = TRUE`.

```
// Debug_CheckDataAccess()
// =====
```

```
boolean Debug_CheckDataAccess(bits(32) address, integer size, boolean T,
                               boolean read, boolean write)
```

```

// Do nothing if debug disabled;
if DBGDSCR.HDBGGen == '0' && DBGDSCR.MDBGGen == '0' then return;

match = FALSE;
// Each byte accessed by the data access is checked
for byte = address to address + size - 1
    for N = 0 to UInt(DBGDIDR.WRPs)
        if WatchpointMatch(N, byte, T, read, write) then match = TRUE;

if match then WatchpointDebugEvent();
return;
// WatchpointMatch()
// =====

boolean WatchpointMatch(integer N, bits(32) address, boolean T, boolean read, boolean write)
    assert N <= UInt(DBGDIDR.WRPs);

// If watchpoint is not enabled, return immediately
if DBGWCR[N].E == '0' then return FALSE; // Not enabled

unk_match = FALSE;

// Check security state, Hyp mode, privilege state
state_match = BreakpointWatchpointStateMatch(DBGWCR[N].SSC, DBGWCR[N].HMC, DBGWCR[N].PAC,
        DBGWCR[N].WT == '1', DBGWCR[N].LBN, T, FALSE);

// Load/store control
case DBGWCR[N].LSC of
    when '00' unk_match = TRUE; load_store_match = FALSE;
    when '01' load_store_match = read;
    when '10' load_store_match = write;
    when '11' load_store_match = TRUE;

// Address comparison
case DBGWCR[N].MASK of
    when '0000' // No mask
        // If implementation includes 8 byte address select bits, DBGWVR[N]<2> == '1'
        // selects 4-bit byte address select behavior.
        if DBGWVR[N]<2> == '1' then
            nbits = 2;
            if !IsZero(DBGWCR[N].BAS<7:4>) then unk_match = TRUE;
        else
            nbits = (if HaveEightBitWatchpointBAS() then 3 else 2);
            mask = ZeroExtend(Ones(nbits), 32);
            if !IsZero(DBGWVR[N]<1:0>) then unk_match = TRUE;
            byte = UInt(address<nbits-1:0>);
            WVR_match = (address AND NOT(mask)) == DBGWVR[N] && DBGWCR[N].BAS<byte> == '1';

    when '0001', '0010' // Reserved
        unk_match = TRUE;

    otherwise // Masked address check
        mask = ZeroExtend(Ones(UInt(DBGWCR[N]<28:24>)), 32);
        if !IsZero(DBGWVR[N] AND mask) then unk_match = TRUE;
        if !IsOnes(DBGWCR[N].BAS<3:0>) then unk_match = TRUE;
        if HaveEightBitWatchpointBAS() && !IsOnes(DBGWCR[N].BAS<7:4>) then
            unk_match = TRUE;
        WVR_match = (address AND NOT(mask)) == DBGWVR[N];

match = WVR_match && state_match && load_store_match;

if unk_match then
    return boolean UNKNOWN;
else
    return match;

```

# Chapter C4

## Debug Exceptions

This chapter describes debug exceptions, that handle Software debug events. It contains the following section:

- [About debug exceptions on page C4-2088](#)
- [Avoiding debug exceptions that might cause UNPREDICTABLE behavior on page C4-2090.](#)

## C4.1 About debug exceptions

A debug exception is taken when:

- A permitted Breakpoint, Vector catch or Watchpoint debug event occurs when invasive debug is enabled and Monitor debug-mode is selected.

Software configures the processor to use Monitor debug-mode by setting `DBGDSCR.MDBGen`, Monitor debug-mode enable, to 1. See *DBGDSCR, Debug Status and Control Register* on page C11-2241. If `DBGDSCR.HDBGen`, Halting debug-mode enable, is also set to 1, then the processor is configured to use Halting debug-mode, that is, HDBGen has priority over MDBGen.

- A BKPT instruction debug event occurs and Halting debug-mode is not selected.

For more information, see [Table C3-1 on page C3-2036](#). When programming events, software must ensure the processor cannot be left in an unrecoverable state. See *Avoiding debug exceptions that might cause UNPREDICTABLE behavior* on page C4-2090 and *UNPREDICTABLE cases when Monitor debug-mode is selected* on page C3-2045.

How the processor handles the debug exception depends on the cause of the exception, and is described in:

- [Debug exception on BKPT instruction, Breakpoint, or Vector catch debug events](#)
- [Debug exception on Watchpoint debug event](#) on page C4-2089.

Halting debug events never cause a debug exception.

When the processor is in Hyp mode, the only permitted debug exception is the debug exception on a BKPT instruction.

### C4.1.1 Debug exception on BKPT instruction, Breakpoint, or Vector catch debug events

If the cause of the debug exception is a BKPT instruction, Breakpoint, or a Vector catch debug event, then a Prefetch Abort exception is generated

However, in an implementation that includes the Virtualization Extensions, when `HDCR.TDE` is set to 1, when the processor is executing in a Non-secure PL1 or PL0 mode, these debug exceptions generate a Hyp Trap exception, instead of a Prefetch Abort exception. For more information, see [Routing Debug exceptions to Hyp mode](#) on page B1-1193 and [Hyp Trap exception](#) on page B1-1208.

When an exception is generated on a BKPT instruction, Breakpoint, or a Vector catch debug event, then:

- The `DBGDSCR.MOE` bits are set as shown in [Table C11-22 on page C11-2255](#).
- The exception is reported as described in:
  - [Reporting exceptions taken to PL1 modes](#) on page B3-1410, for an exception taken to a PL1 mode in a VMSA implementation
  - [Reporting exceptions taken to the Non-secure PL2 mode](#) on page B3-1420, for an exception taken to the PL2 mode in a VMSA implementation
  - [Prefetch Abort exceptions](#) on page B5-1769, for a PMSA implementation.

#### ———— Note —————

In a VMSA implementation that includes the Virtualization Extensions, debug exceptions on Breakpoint or Vector catch debug events are not permitted in Hyp mode.

The Prefetch Abort exception handler must check the `IFSR` bits, or the `HSR`.`IFSC` bits, to find out whether the exception entry was caused by a debug exception. If it was, typically the handler branches to the debug monitor.

See also [Prefetch Abort exception](#) on page B1-1212.

## C4.1.2 Debug exception on Watchpoint debug event

If the cause of the debug exception is a Watchpoint debug event, then a Data Abort exception is generated.

However, in an implementation that includes the Virtualization Extensions, when `HDCR.TDE` is set to 1, when the processor is executing in a Non-secure PL1 or PL0 mode, a debug exception on a Watchpoint debug event generates a Hyp Trap exception, instead of a Data Abort exception. For more information, see [Routing Debug exceptions to Hyp mode on page B1-1193](#) and [Hyp Trap exception on page B1-1208](#).

When a Data Abort exception is generated on a debug event, then:

- The `DBGDSCR.MOE` bits are set to either to Asynchronous Watchpoint Occurred or to Synchronous Watchpoint Occurred.

———— **Note** —————

The `CPSR.A` bit has no effect on the taking of an exception generated by a Watchpoint debug event, regardless of whether that exception is asynchronous or synchronous.

- The exception is reported as described in:
  - [Reporting exceptions taken to PL1 modes on page B3-1410](#), for an exception taken to a PL1 mode in a VMSA implementation
  - [Reporting exceptions taken to the Non-secure PL2 mode on page B3-1420](#), for an exception taken to the PL2 mode in a VMSA implementation
  - [Data Abort exceptions on page B5-1767](#), for a PMSA implementation.

———— **Note** —————

In a VMSA implementation that includes the Virtualization Extensions, Debug exceptions on Watchpoint debug events are not permitted in Hyp mode.

When the Watchpoint debug event generates a Data Abort exception, the Data Abort exception handler must check the `DFSR` bits, or the `HSR.DFSC` bits, to find out whether the exception entry was caused by a debug exception. If it was, typically the handler branches to the debug monitor.

For more information, see [Data Abort exception on page B1-1214](#) and [Synchronous and asynchronous Watchpoint debug events on page C3-2062](#).

## C4.2 Avoiding debug exceptions that might cause UNPREDICTABLE behavior

A debugger or debug monitor must avoid defining a Software debug event that, when generated, might overwrite context and therefore cause UNPREDICTABLE behavior. The following subsections give more information:

- [Debug exceptions in exception handlers](#)
- [Debug exceptions in debug monitors](#).

### C4.2.1 Debug exceptions in exception handlers

A debugger should take care when setting a Breakpoint or BKPT instruction debug event inside a Prefetch Abort or Data Abort exception handler, or when setting a Watchpoint debug event on a data address that might be accessed by any of these handlers.

In general, only set a Breakpoint or BKPT instruction debug event inside an exception handler at a point after the handler has saved the context that would be corrupted by a debug event.

Otherwise, a debug exception might occur before the handler has saved the context of the abort, causing the context to be overwritten. This loss of context results in UNPREDICTABLE software behavior. The context that might be corrupted by such an event includes LR\_abt, SPSR\_abt, [IFAR](#), [DFAR](#), and [DFSR](#).

### C4.2.2 Debug exceptions in debug monitors

Because debug exceptions generate Data Abort or Prefetch Abort exceptions, the precautions outlined in the section [Debug exceptions in exception handlers](#) also apply to debug monitors. ARM strongly recommends that, when programming breakpoints and watchpoints, great care is taken to avoid them being generated in the debug monitor.

The section [Generation of debug events on page C3-2074](#) identifies two problem cases:

- A write to the [DBGWCR](#) using a memory-mapped register interface for a watchpoint set on the address of that [DBGWCR](#), to disable that watchpoint, triggers the watchpoint.  
In this case:
  - if watchpoints are asynchronous, the write to the [DBGWCR](#) still takes place and the watchpoint is disabled. The debug software must then deal with the re-entrant debug exception
  - if watchpoints are synchronous the value in the [DBGWCR](#) after the watchpoint is signaled is unchanged, and the debug event is left enabled.
- An instruction that disables a breakpoint on that instruction triggers the breakpoint.  
In this case, the debug exception is taken before the debug event is disabled.

In both of these cases it might be impossible to recover.

# Chapter C5

## Debug State

This chapter describes Debug state, which is entered if a debug event occurs under certain conditions. It contains the following sections:

- *About Debug state on page C5-2092*
- *Entering Debug state on page C5-2093*
- *Executing instructions in Debug state on page C5-2096*
- *Behavior of non-invasive debug in Debug state on page C5-2104*
- *Exceptions in Debug state on page C5-2105*
- *Memory system behavior in Debug state on page C5-2109*
- *Exiting Debug state on page C5-2110.*

## C5.1 About Debug state

When invasive debug is enabled, the processor switches to a special state called Debug state if one of the following happens:

- a permitted Software debug event occurs and Halting debug-mode is selected
- a permitted Halting debug event occurs
- a Halting debug event becomes permitted while it is pending.

For more information about Debug state, see [State on page B1-1135](#). In Debug state, control of the processor passes to an external agent.

### ————— Note —————

The external agent is usually a debugger. However it might be some other agent connecting to the debug port of the processor. This could be another processor in the same *System on Chip* (SoC) device. In part C of this manual this agent is often referred to as a debugger.

Software configures the processor to use Halting debug-mode by setting `DBGDSCR.HDBGen`, Halting debug-mode enable, to 1, see [DBGDSCR, Debug Status and Control Register on page C11-2241](#).

Parts A and B of this manual describe how an ARMv7 processor behaves when it is not in Debug state, that is, when it is in Non-debug state. In Debug state, the processor behavior changes as follows:

- PC accesses behave as described in [Behavior of reads of the PC in Debug state on page C5-2100](#).
- `CPSR` accesses behave as described in [Behavior of MRS and MSR instructions that access the CPSR in Debug state on page C5-2097](#).
- The debugger can force the processor to execute instructions by writing to the *Instruction Transfer Register*, `DBGITR`, see [Executing instructions in Debug state on page C5-2096](#).
- The processor can execute only instructions from the ARM instruction set.
- The rules about modes and execution privilege are different to those in Non-debug state, see [Executing instructions in Debug state on page C5-2096](#).
- Non-invasive debug features are disabled, see [Behavior of non-invasive debug in Debug state on page C5-2104](#).
- Exceptions are treated as described in [Exceptions in Debug state on page C5-2105](#). Debug events and interrupts are ignored.
- If the implementation supports *Direct Memory Access* (DMA) to *Tightly Coupled Memory* (TCM), its behavior is IMPLEMENTATION DEFINED.
- If the implementation includes a cache or other local memory that it keeps coherent with other memories in the system during normal operation, it must continue to service coherency requests from the other memories.

Once a processor has entered Debug state it remains in Debug state until either it receives a signal to exit Debug state or a Reset exception occurs. For more information see [Exiting Debug state on page C5-2110](#).



## C5.2 Entering Debug state

*About Debug state on page C5-2092* describes the situations that cause the processor to switch to Debug state.

On entering Debug state the processor follows this sequence:

1. The processor signals to the system that it is entering Debug state, if it implements this signaling. Details of the signaling method, including whether it is implemented, are IMPLEMENTATION DEFINED.
2. Processing halts, meaning the processor flushes the instruction pipeline and does not fetch any more instructions from memory.
3. The processor is ready for an external agent to take control. It enters Debug state and:
  - Signals to the system that it is in Debug state. Details of the signaling method, including whether it is implemented, are IMPLEMENTATION DEFINED.
  - Sets:
    - the `DBGDSCR.HALTED` bit to 1
    - the `DBGDSCR.MOE` field as shown in [Table C11-22 on page C11-2255](#).

During this sequence, the processor might:

- First, ensure that all Non-debug state memory operations complete.
- Signal to the system that all Non-debug state memory operations are complete. Details of this signaling, including whether it is implemented, are IMPLEMENTATION DEFINED.
- Set the `DBGDSCR.ADAdiscard` bit to 1.

However, how the processor handles memory accesses that are outstanding at Debug state entry is IMPLEMENTATION DEFINED. For more information see *Asynchronous aborts and Debug state entry on page C5-2094*.

The following sections describe the effect of Debug state entry on registers:

- *Effect of entering Debug state on ARM core registers and program status registers*
- *Effect of entering Debug state on CP15 registers and the `DBGWFAR` on page C5-2094*.

---

### Note

- The recommended external debug interface includes an implementation of the signaling described in this section. For more information see *Run-control and cross-triggering signals on page AppxA-2340* and *DBGACK and DBGCPUDONE on page AppxA-2342*.
  - Entering Debug state does not ensure that the effect of any context changing operation performed before Debug state entry is visible to instructions executed in Debug state.
- 

### C5.2.1 Effect of entering Debug state on ARM core registers and program status registers

The values of the following do not change on entering Debug state:

- the ARM core registers R0-R12, SP, and LR
- all the program status registers, including the `CPSR`, the `SPSRs`, and, on an implementation that includes the Virtualization Extensions, `ELR_hyp`.

On entry to Debug state, the value of the PC is the *preferred return address* for a return to Non-debug state, and the `CPSR` is the value that the instruction at the preferred return address would have been executed with, if the debug event had not caused entry to Debug state.

---

### Note

This means that, on entry to Debug state, the `CPSR.IT` bits apply to the instruction at the return address.

---

For more information about the behavior and use of the PC and CPSR in Debug state see *Executing instructions in Debug state* on page C5-2096 and *Exiting Debug state* on page C5-2110.

## C5.2.2 Effect of entering Debug state on CP15 registers and the DBGW FAR

The actions taken on entering Debug state depend on what caused the Debug state entry:

- If Debug state was entered following a Watchpoint debug event, then, in v7 Debug and for asynchronous Watchpoint debug events, the *Watchpoint Fault Address Register*, **DBGW FAR**, is updated with the virtual address of the instruction that accessed the watchpointed address, plus an offset that depends on the instruction set state of the processor when the debug event was generated:
  - 8 in ARM state
  - 4 in Thumb and ThumbEE states
  - IMPLEMENTATION DEFINED in Jazelle state.

In v7.1 Debug, for synchronous Watchpoint debug events, the **DBGW FAR** is UNKNOWN.

- Otherwise, the **DBGW FAR** is unchanged on entry to Debug state.

### ———— Note ————

In v7 Debug, if a watchpoint is synchronous:

- both the PC and **DBGW FAR** indicate the address of the instruction that triggered the watchpoint
- ARM deprecates using **DBGW FAR** to determine the address of the instruction that triggered the watchpoint.

In v7.1 Debug, only the PC indicates the address of the instruction that triggered the watchpoint.

All CP15 registers are unchanged on entry to Debug state.

## C5.2.3 Asynchronous aborts and Debug state entry

On entry to Debug state, it is IMPLEMENTATION DEFINED whether a processor ensures that all memory operations complete and that all possible outstanding asynchronous aborts have been recognized before it signals that it has entered Debug state.

The value of the **DBGDSCR.ADA**discard bit indicates the behavior on entry to Debug state:

- In v7 Debug, this bit applies to all asynchronous aborts.
- In v7.1 Debug, this bit applies only to external asynchronous aborts, and it is IMPLEMENTATION DEFINED which external asynchronous aborts are discarded when the bit is set to 1.

### ———— Note ————

In v7.1 Debug, **DBGDSCR.ADA**discard indicates a request to discard external asynchronous aborts caused by debugger activity, that is, caused by instructions issued through **DBGITR**. An external asynchronous abort is not discarded if either:

- the processor determines that the asynchronous abort is not caused by an instruction issued through **DBGITR**
- the processor cannot determine whether the asynchronous abort was caused by an instruction issued through **DBGITR**, or was caused by other system activity.

How a processor makes such determinations is IMPLEMENTATION DEFINED.

The possible values of **DBGDSCR.ADA**discard are:

### If **DBGDSCR.ADA**discard == 1

The processor has ensured that all possible outstanding asynchronous aborts, to which the value of this bit applies, have been recognized, and the debugger has no additional action to take.

If, on entry to Debug state, the processor logic automatically checks that any outstanding asynchronous aborts to which the value of this bit applies have been recognized, and sets `DBGDSCR.ADAdiscard` to 1, then `DBGDSCR.ADAdiscard` is implemented as a read-only bit.

**If `DBGDSCR.ADAdiscard == 0`**

The following sequence must occur:

1. The debugger must execute an IMPLEMENTATION DEFINED sequence to determine whether all possible outstanding asynchronous aborts, to which the value of this bit applies, have been recognized.

An asynchronous abort recognized as a result of this sequence is not acted on immediately. Instead, the processor latches the abort event and its type. The asynchronous abort is acted on when the processor exits Debug state.

2. Either the processor or the debugger must set `DBGDSCR.ADAdiscard` to 1.

The possible ways of meeting this requirement are:

- The processor automatically sets this bit to 1 on detecting the execution of the IMPLEMENTATION DEFINED sequence. In this case, `DBGDSCR.ADAdiscard` is implemented as a read-only bit.
- The IMPLEMENTATION DEFINED sequence sets `DBGDSCR.ADAdiscard` to 1, using the processor interface to the debug resources. In this case, `DBGDSCR.ADAdiscard` is implemented as a read/write bit.

It is IMPLEMENTATION DEFINED which of these is required.

When the processor has completed all Non-debug state memory operations it signals this to the system. In an implementation where, on entering Debug state, the processor does not ensure that all Non-debug state memory operations are complete, it does not signal the system until all these operations have completed. This completion might be linked to the debugger executing the IMPLEMENTATION DEFINED sequence that determines whether all possible outstanding asynchronous aborts, to which the value of `DBGDSCR.ADAdiscard` applies, have been recognized.

However, the method of signaling to the system that Non-debug state memory operations are complete, including whether any such method is implemented, is IMPLEMENTATION DEFINED.

## C5.3 Executing instructions in Debug state

In Debug state the processor executes instructions issued through the *Instruction Transfer Register*, **DBGITR**. A debugger enables this mechanism by setting **DBGDSCR.ITRen**, to 1. For more information, see [Chapter C8 The Debug Communications Channel and Instruction Transfer Register](#).

The following conditions apply to executing instructions through **DBGITR**:

- The processor interprets instructions issued through the **DBGITR** as ARM instruction set opcodes, regardless of the setting of the **CPSR**.{J, T} bits. However, if **CPSR**.{J, T} are not set to {0, 0}, the values for ARM state, some instructions might not function correctly. In particular, some aspects of the behavior of instructions that read or write the PC are determined by the actual values of the **CPSR**.{J, T} bits. For more information, see [Behavior of Data-processing instructions that access the PC in Debug state on page C5-2100](#).

Some ARM instructions are UNPREDICTABLE if executed in Debug state. This list identifies these instructions.

Otherwise, except for the specific cases identified in this list, instructions executed in Debug state operate as specified for their operation in ARM state.

———— **Note** —————

Operation as specified for ARM state means that, in any pseudocode description of instruction operation, a call of `CurrentInstrSet()` returns the value `InstrSet_ARM`, regardless of the values of the **CPSR**.{J, T} bits.

- The PC does not increment on instruction execution.
- Instruction execution ignores the **CPSR.IT** execution state bits. This means that the value of **CPSR.IT** has no effect on whether any instruction issued through the **DBGITR** fails its condition code check. However, any instruction issued through the **DBGITR** is treated as ARM instruction set opcode, and if an instruction includes a condition code this is treated as it would be in ARM state, see [Conditional execution on page A4-161](#) and [Conditional execution on page A8-288](#).

The **CPSR.IT** execution state bits are preserved and do not change when instructions are executed, unless an MSR instruction explicitly modifies these bits, as described in [Behavior of MRS and MSR instructions that access the CPSR in Debug state on page C5-2097](#).

- All memory read and memory write instructions with the PC as the base address register use an UNKNOWN value for the base address.
- The following instructions are UNPREDICTABLE in Debug state:
  - Instructions that load a value from memory into the PC.
  - Conditional instructions that write explicitly to the PC.
  - The branch instructions B, BL, BLX (immediate), BLX (register), BX, and BXJ.
  - The hint instructions WFI, WFE and YIELD.
  - The **CPSR**-modifying instructions CPS and SETEND.
  - All forms of MSR CPSR except for MSR CPSR\_fsrc. For more information, see [Behavior of MRS and MSR instructions that access the CPSR in Debug state on page C5-2097](#).
  - The exception return instructions LDM (exception return), RFE, and ERET.
  - The exception-generating instructions SVC, HVC, and SMC.
  - The software breakpoint instruction, BKPT.

———— **Note** —————

The definition of UNPREDICTABLE means that an UNPREDICTABLE instruction executed in Debug state must not put the processor into a state or mode in which debug is not permitted, or change the state of any register that cannot be accessed from the current state and mode.

[Altering CPSR privileged bits in Debug state on page C5-2098](#) and [Behavior of Data-processing instructions that access the PC in Debug state on page C5-2100](#) define other cases where instructions are UNPREDICTABLE.

- There are differences in the forms of the MSR instruction that updates the CPSR, and in the behavior of accesses to the privileged bits of the CPSR, see [Behavior of MRS and MSR instructions that access the CPSR in Debug state](#).
- There are differences in the behavior of data-processing instructions that access the PC, including additional restrictions on writes to the PC, see [Behavior of Data-processing instructions that access the PC in Debug state on page C5-2100](#).
- The privilege of User mode accesses to CP14 and CP15 registers is escalated to PL1. In all other respects, the behavior of coprocessor and Advanced SIMD instructions in Debug state is identical to their behavior in Non-debug state. For more information, see [Behavior of coprocessor and Advanced SIMD instructions in Debug state on page C5-2102](#).  
However, a coprocessor can impose additional constraints or usage guidelines for executing coprocessor instructions in Debug state. For example a coprocessor that signals internal exception conditions asynchronously using the Undefined Instruction exception, as described in [Undefined Instruction exception on page B1-1205](#), might require particular sequences of instructions to avoid the corruption of coprocessor state associated with the exception condition. See [Context switching on page AppxF-2438](#) for the requirements for executing floating-point instructions in Debug state.
- The rules for accessing memory, and ARM core registers other than the PC, are the same in Debug state as in Non-debug state. For more information, see [Accessing memory and ARM core registers in Debug state on page C5-2103](#).

### C5.3.1 Behavior of MRS and MSR instructions that access the CPSR in Debug state

In Debug state, MRS and MSR instructions that read and write an SPSR, and, in an implementation that includes the Virtualization Extensions, the MRS (Banked register) and MSR (Banked register) instructions, behave as they do in Non-debug state. However, the behavior of MRS and MSR instructions that read and write the CPSR are different in Debug state:

- The restrictions on updates to the privileged CPSR bits are less restrictive in Debug state than they are in Non-debug state, see [Altering CPSR privileged bits in Debug state on page C5-2098](#).
- In Non-debug state:
  - the execution state bits, other than the E bit, are RAZ when read by an MRS instruction
  - writes to the execution state bits, other than the E bit, by an MSR instruction are ignored.
- in Debug state:
  - An MSR instruction that does not write to all fields of the CPSR is UNPREDICTABLE. This means that, in Debug state the only form of the MSR instruction that can update the CPSR is MSR CPSR\_fsrc.
  - The execution state bits return their correct values when read by an MRS instruction.
  - Writes to the execution state bits by an MSR instruction update the execution state bits.

In addition, in Debug state:

- if a debugger uses an MSR instruction to directly modify the execution state bits of the CPSR, it must then perform a context synchronization operation by executing an ISB instruction
- if an MRS instruction reads the CPSR after an MSR writes the execution state bits, and before an ISB instruction, the value returned is UNKNOWN
- if the processor exits Debug state after an MSR writes the execution state bits, and before an ISB instruction, the behavior of the processor is UNPREDICTABLE.

## Altering CPSR privileged bits in Debug state

The **CPSR** privileged bits are the **CPSR** bits that, in Non-debug state, can only be written at PL1 or higher.

In Debug state, MSR CPSR\_fsxc is the only form of the MSR instruction that can modify the **CPSR**, and this form of the instruction can modify the **CPSR** privileged bits. The following gives more information about the permitted updates, including any restrictions that apply:

### When the implementation includes the Security Extensions

When the processor is in Non-secure state and Debug state, in the following cases the MSR instruction that attempts to change the **CPSR** is UNPREDICTABLE:

- if invasive debug is not permitted in Secure PL1 modes, and the MSR attempts to set the **CPSR.M** field to 0b10110, Monitor mode
- if **NSACR.RFR** is set to 1, the MSR attempts to set the **CPSR.M** field to 0b10001, FIQ mode.

#### ———— Note ————

The definition of UNPREDICTABLE means that, in these cases, if the processor is in Non-secure state:

- it must not enter Monitor mode
- if **NSACR.RFR** is set to 1, it must not enter FIQ mode.

In any update to the **CPSR**, the **SCR.{AW, FW}** and **SCTLR.NMFI** bits have the same effects on writes to the **CPSR.{A, F}** bits as they do in Non-debug state, see *Asynchronous exception masking* on page B1-1183 and *Non-maskable FIQs* on page B1-1151.

### When the implementation includes the Virtualization Extensions

#### ———— Note ————

A processor that implements the Virtualization Extensions must implement the Security Extensions, and therefore all the restrictions associated with the Security Extensions apply to any implementation that includes the Virtualization Extensions.

When the processor is in Non-secure state and Debug state:

- A write that sets **CPSR.M** to 0b11010, the value for Hyp mode, is:
  - UNPREDICTABLE if either **SCR.NS** is set to 0, indicating Secure state, or the values written to **CPSR.{J, T}** are {1, 1}, indicating ThumbEE state
  - otherwise, permitted.
- If the processor is in Hyp mode, a write that sets **CPSR.M** to a value other than 0b11010, the value for Hyp mode, is:
  - UNPREDICTABLE if it does not meet the restrictions on changes to **CPSR.M** that apply to any implementation that includes the Security Extensions
  - otherwise, permitted.

### When the implementation does not include the Security Extensions

Any **CPSR** update that is permitted in software executing at PL1 or higher when in Non-debug state, is permitted in Debug state.

#### ———— Note ————

In all cases, when the processor is in User mode in Debug state, ARM deprecates updating any **CPSR** privileged bits other than the M field.

### **Being in Debug state when invasive halting debug is disabled or not permitted**

A processor can be in Debug state when the current mode, security state or debug authentication signals indicate that, in Non-debug state, debug events would be ignored. The situations where this can occur are:

- Between a change in the debug authentication signals and the end of the next context synchronization operation. At this point it is UNPREDICTABLE whether the behavior of any debug event that is generated follows the old or the new authentication signal settings. For more information see [Generation of debug events on page C3-2074](#).
- Because it is possible to change the authentication signals while in Debug state. If this happens, the processor remains in Debug state, but the operations available to the processor might change. For more information see [Changing the authentication signals on page AppxA-2338](#).

For example, in a system using the recommended authentication interface, the following sequence of events can occur:

1. The processor is in a Secure PL1 mode and invasive halting debug is permitted in Secure PL1 modes.
2. An instruction is fetched that matches all the conditions for a breakpoint to occur.
3. That instruction is committed for execution.
4. At the same time, an external device writes to the peripheral that controls the enable signal for invasive halting debug in Secure PL1 modes, causing it to deassert that signal.
5. The signal changes, but the processor is already committed to entering Debug state.
6. The processor enters Debug state and is in a Secure PL1 mode, even though invasive halting debug is not permitted in Secure PL1 modes.

If this series of events occurs, a write to the [CPSR](#) to change to another Secure PL1 mode, including Monitor mode, is UNPREDICTABLE, even though the processor is in a Secure PL1 mode. In addition, if the processor exits Secure state or moves to Secure User mode, it might not be able to return to a Secure PL1 mode.

See [Chapter C2 Invasive Debug Authentication](#) for a description of when invasive debug is disabled.

### C5.3.2 Behavior of Data-processing instructions that access the PC in Debug state

The following subsections describe the behavior of permitted reads and writes of the PC in Debug state:

- [Behavior of reads of the PC in Debug state](#)
- [Behavior of writes to the PC in Debug state on page C5-2101.](#)

#### Behavior of reads of the PC in Debug state

Immediately after the processor enters Debug state, a read of the PC returns a *preferred return address* (PRA) plus an offset. The PRA depends on the type of debug event that caused the entry to Debug state, and the offset depends on the instruction set state of the processor when it entered Debug state. [Table C5-1](#) shows the values returned by a read of the PC. The PRA is the address of the first instruction that the processor must execute on exit from Debug state, if program execution is to continue from where it stopped. For more information, see [Exception return on page B1-1193](#).

**Table C5-1 PC value while in Debug state**

Debug event	PC value, for instruction set state on Debug entry			Meaning of PRA obtained from PC read
	ARM	Thumb, ThumbEE	Jazelle <sup>a</sup>	
Breakpoint	PRA + 8	PRA + 4	PRA + Offset	Breakpointed instruction address
Synchronous Watchpoint	PRA + 8	PRA + 4	PRA + Offset	Address of the instruction that triggered the watchpoint <sup>b</sup>
Asynchronous Watchpoint	PRA + 8	PRA + 4	PRA + Offset	Instruction address at which to restart <sup>c</sup>
BKPT instruction	PRA + 8	PRA + 4	PRA + Offset	BKPT instruction address
Vector catch	PRA + 8	PRA + 4	PRA + Offset	Vector address
External debug request	PRA + 8	PRA + 4	PRA + Offset	Instruction address at which to restart
Halt request	PRA + 8	PRA + 4	PRA + Offset	Instruction address at which to restart
OS Unlock catch	PRA + 8	PRA + 4	PRA + Offset	Instruction address at which to restart

- In the Jazelle entries, *Offset* is an IMPLEMENTATION DEFINED value that is constant and documented.
- Returning to PRA has the effect of retrying the instruction. This can have implications under the memory order model. See [Synchronous and asynchronous Watchpoint debug events on page C3-2062](#).
- PRA is not the address of the instruction that triggered the watchpoint, but one that was executed some number of instructions later. The address of the instruction that triggered the watchpoint can be discovered from the value in the [DBGWFR](#).

While the processor is in Debug state, any read of the PC returns the appropriate value from [Table C5-1](#), provided no instruction executed in Debug state either:

- explicitly update the PC
- updates the [CPSR](#).

However, if an instruction executed in Debug state has updated the [CPSR](#), or explicitly updated the PC, any subsequent read of the PC returns an UNKNOWN value. For more information see [Executing instructions in Debug state on page C5-2096](#).



While the processor is in Debug state, any value read from the PC is aligned according to the rules of the instruction set state indicated by the CPSR.{J, T} execution state bits, regardless of the fact that the processor only executes the ARM instruction set in Debug state. This means that:

- if CPSR.{J, T} is {0, 0}, indicating ARM state, bits[1:0] of the value read from the PC are 0b00
- if CPSR.{J, T} is {x, 1}, indicating Thumb state or ThumbEE state, bit[0] of the value read from the PC is 0
- if CPSR.{J, T} is {1, 0}, indicating Jazelle state, no alignment is applied to the value read from the PC.

When executed in Non-debug state, some instructions perform an additional alignment of the PC value as part of their operation. This additional alignment is shown in their operation pseudocode. When one of these instructions is executed in Debug state, it is UNPREDICTABLE whether this additional alignment is performed. For more information about the instructions that perform this additional alignment see [Use of labels in UAL instruction syntax on page A4-162](#).

[CPSR and PC values on exit from Debug state on page C5-2111](#) describes the PC value used on exiting Debug state.

### Behavior of writes to the PC in Debug state

The ARM encodings of the instructions ADC, ADD, AND, ASR, BIC, EOR, LSL, LSR, MOV, MVN, ORR, ROR, RRX, RSB, RSC, SBC, and SUB write to the PC if their Rd field is 0b1111. When in Non-debug state, these ARM instruction encodings can be executed only in the ARM instruction set state, and their behavior is described in:

- [SUBS PC, LR and related instructions \(ARM\) on page B9-2010](#), if the S bit of the instruction is 1.
- [Chapter A8 Instruction Details](#), if the S bit of the instruction is 0. The ALUWritePC() pseudocode function describes these operations, see [Pseudocode details of operations on ARM core registers on page A2-47](#).

In Debug state, the behavior of these ARM instruction encodings is as follows:

- If the S bit of the instruction is 1, behavior is UNPREDICTABLE.
- If the S bit of the instruction is 0, the instruction can be executed regardless of the instruction set state indicated by CPSR.{J, T}, and its behavior is either an explicit write to the PC, or UNPREDICTABLE, depending on both:
  - the instruction set state, as indicated by the CPSR.{J, T} bits
  - the value of bits[1:0] of the result calculated by the instruction.

[Table C5-2](#) shows this behavior.

**Table C5-2 Debug state rules for data-processing instructions that write to the PC**

CPSR.{J, T}	Instruction set state	result<1:0>	Operation <sup>a</sup>
00	ARM	00	BranchTo(result<31:2>:'00') <sup>b</sup>
		x1	UNPREDICTABLE <sup>c</sup>
		10	UNPREDICTABLE
x1	Thumb or ThumbEE	x0	UNPREDICTABLE <sup>c</sup>
		x1	BranchTo(result<31:1>:'0') <sup>b</sup>
10	Jazelle	xx	BranchTo(result<31:0>) <sup>b</sup>

- a. Pseudocode description of behavior, when the behavior is not UNPREDICTABLE.
- b. [Pseudocode details of ARM core register operations on page B1-1144](#) defines the BranchTo() pseudocode function.
- c. In these cases, the behavior is changed from the behavior in Non-debug state. In all other cases, the behavior described is unchanged from the behavior in Non-debug state.

### C5.3.3 Behavior of coprocessor and Advanced SIMD instructions in Debug state

The following sections describe the behavior of the coprocessor and Advanced SIMD instructions in Debug state:

- [Instructions for CP0 to CP13, and Advanced SIMD instructions](#)
- [Instructions for CP14 and CP15.](#)

#### Instructions for CP0 to CP13, and Advanced SIMD instructions

This subsection describes:

- Coprocessor instructions for CP0 to CP13. These include the instructions provided by the Floating-point Extension.
- In an implementation that includes the Advanced SIMD Extension, the instruction encodings described in [Advanced SIMD data-processing instructions on page A7-261](#) and [Advanced SIMD element or structure load/store instructions on page A7-275.](#)

Access controls for these instructions in Debug state are the same as in Non-debug state, see [Access controls on CP0 to CP13 on page B1-1226](#) and [Enabling Advanced SIMD and floating-point support on page B1-1228.](#)

#### Instructions for CP14 and CP15

This subsection describes the behavior of coprocessor instructions that access the internal coprocessors CP14 and CP15. Support for SUHD significantly changes the information given here, see [Coprocessor instructions for CP14 and CP15 when SUHD is supported on page AppxN-2583.](#)

In Debug state, if the processor is in User mode, for accesses to CP14 and CP15 registers the privilege level is escalated to PL1. This means that, in Debug state in User mode:

- Instructions that access CP14 or CP15 registers that are not UNDEFINED and not UNPREDICTABLE if executed at PL1 in the current security state in Non-debug state are permitted. There is no requirement to change to a mode with a higher level of privilege before issuing the instruction, even if the target register cannot be accessed from User mode in Non-debug state.
- Any CP14 or CP15 register access instruction that is UNDEFINED if executed at PL1 in the current security state in Non-debug state is UNDEFINED, and generates an Undefined Instruction exception. For details of how Undefined Instruction exceptions are handled in Debug state see [Exceptions in Debug state on page C5-2105.](#)
- Any CP14 or CP15 register access instruction that is UNPREDICTABLE if executed at PL1 in the current security state in Non-debug state is UNPREDICTABLE.

#### ———— Note —————

Except for accesses to the [DBGDTRRX](#)int and [DBGDTRTX](#)int registers, ARM deprecates accessing any CP14 or CP15 register from User mode in Debug state if that register cannot be accessed from User mode in Non-debug state.

Otherwise, the current mode and security state define the privilege level and access controls for accessing these registers from Debug state, and:

- If the implementation includes the Security Extensions, any access to a Banked CP15 register accesses the copy for the current security state. If the processor is in Monitor mode, the Non-debug state rules for accessing CP15 registers in Monitor mode apply.
- If the implementation includes the Virtualization Extensions, then in Non-secure PL0 and PL1 modes:
  - reads of [MIDR](#) return the value of [VPIDR](#)
  - reads of [MPIDR](#) return the value of [VMPIDR](#).

These rules mean that, for example:

- If the processor is stopped in Non-secure state and invasive debug is not permitted in Secure PL1 modes, then the debugger has access only to those CP15 registers accessible in Non-secure state in Non-debug mode.
- If the processor is stopped with invasive debug permitted in Secure PL1 modes, then the debugger has access to all CP15 registers. If the processor is in Non-secure state, the debugger can switch the processor to Monitor mode to access the SCR.NS bit, to give access to all CP15 registers.

Chapter C2 *Invasive Debug Authentication* describes when invasive debug is permitted in Secure PL1 modes.

In Debug state, the CP15SDISABLE input to the processor operates in exactly the same way as in Non-debug state, see *The CP15SDISABLE input* on page B3-1458.

### C5.3.4 Accessing memory and ARM core registers in Debug state

The rules for accessing memory, and ARM core registers other than the PC, are the same in Debug state as in Non-debug state. For example, if CPSR.M indicates that the processor is in Supervisor mode:

- reads of ARM core registers return the Supervisor mode registers
- normal load and store operations make privileged memory accesses
- the instructions LDRT, LDRBT, LDRHT, LDRSBT, LDRSHT, STRT, STRBT, and STRHT make unprivileged memory accesses.

———— **Note** —————

On a processor that implements the Security Extensions, the values of LR\_mon and SPSR\_mon are UNKNOWN when the processor is in Non-secure state. This means that if a processor in Debug state is in Non-secure state and the debugger sets CPSR.M to 0b10110, Monitor mode, subsequent reads of LR\_mon and SPSR\_mon return UNKNOWN values.

—————

## C5.4 Behavior of non-invasive debug in Debug state

The following sections describe the effects of being in Debug state on the non-invasive debug components:

- [Trace on page C9-2185](#)
- [Reads of the Program Counter Sampling Register on page C10-2189](#)
- [Effects of non-invasive debug authentication on the Performance Monitors on page C12-2302.](#)

———— **Note** —————

When the [DBGDSCR.DBGack](#) bit, Force Debug Acknowledge, is set to 1 and the processor is in Non-debug state, the behavior of non-invasive debug features is IMPLEMENTATION DEFINED. However, in this case non-invasive debug features must behave either as if in Debug state or as if Non-debug state.

---

## C5.5 Exceptions in Debug state

When the processor is in Debug state, exceptions are handled as follows:

**Reset** On a Reset exception, the processor exits Debug state. The reset handler runs in Non-debug state, see [Reset on page B1-1204](#).

———— **Note** —————

This only applies to a reset that in Non-debug state would cause a Reset exception. It does not apply to a debug logic reset. For more information on debug logic reset, see [Reset and debug on page C7-2160](#).

**Prefetch Abort**

A Prefetch Abort exception cannot be generated because no instructions are fetched in Debug state.

**Supervisor Call**

The SVC instruction is UNPREDICTABLE.

**Hypervisor Call**

The HVC instruction is UNPREDICTABLE.

**Secure Monitor Call**

The SMC instruction is UNPREDICTABLE.

**BKPT** The BKPT instruction is UNPREDICTABLE.

**Debug events** Debug events are ignored in Debug state.

**Interrupts** IRQ and FIQ exceptions are disabled and not taken in Debug state.

———— **Note** —————

This behavior does not depend on the values of the [CPSR](#).{I, F} bits, and the values of these bits are not changed on entering Debug state.

However, if the *Interrupt Status Register (ISR)* is implemented, the [ISR](#).I and [ISR](#).F bits continue to reflect the values of the IRQ and FIQ inputs to the processor.

**Hyp Trap** Hyp Trap exceptions are ignored in Debug state. However, Undefined Instruction exceptions in Hyp mode caused by the values of [HCPTR](#).{TCPn, TASE, TTA} are not ignored.

———— **Note** —————

Because a hypervisor can use [HCPTR](#) to implement lazy context switching, when the processor is in a Non-secure mode other than Hyp mode, a debugger must check [HCPTR](#) before reading what might be stale register data.

**Undefined Instruction**

In Debug state, Undefined Instruction exceptions are generated for the same reasons as in Non-debug state.

When an Undefined Instruction exception is generated in Debug state, the processor takes the exception as follows:

- PC, [CPSR](#), [SPSR\\_und](#), [LR\\_und](#), [SCR](#).NS, and [DBGDSCR](#).MOE are unchanged. If the implementation includes the Virtualization Extensions are implemented, [HSR](#) is unchanged.
- The processor remains in Debug state.
- [DBGDSCR](#).UND\_1, the Sticky Undefined Instruction bit, is set to 1.

For more information, see the description of the [DBGDSCR](#).UND\_1 bit.

### Synchronous Data Abort

In Debug state, a synchronous abort on a data access generates a Data Abort exception.

When a Data Abort exception is generated synchronously in Debug state, the processor takes the exception as follows:

- PC, **CPSR**, **SPSR\_abt**, **LR\_abt**, **SCR.NS**, and **DBGDSCR.MOE** are unchanged.
- The processor remains in Debug state.
- **DBGDSCR.SDABORT\_1**, the Sticky Synchronous Data Abort bit, is set to 1.
- A fault status register and a fault address register are updated:
  - If the implementation does not include the Virtualization Extensions, the **DFSR** and **DFAR** are updated. However, if the implementation supports Secure User halting debug, there are some situations in which it is IMPLEMENTATION DEFINED whether **DFSR** and **DFAR** are updated, see *Effect of SUHD on exception handling in Debug state on page AppxN-2585*.
  - If the implementation includes the Virtualization Extensions, and the processor is in Secure state, the **DFSR** and **DFAR** are updated.
  - If the implementation includes the Virtualization Extensions, and the processor is in Non-secure state, *Handling of synchronous Data Aborts in Non-secure state, Virtualization Extensions on page C5-2107* describes which registers are updated.
- If the **ISR** is implemented, the **ISR.A** bit is not changed, because no abort is pending.

See also the description of the **SDABORT\_1** bit in *DBGDSCR, Debug Status and Control Register on page C11-2241*.

### Asynchronous abort

When an asynchronous abort is signaled in Debug state, no Data Abort exception is generated and the processor behaves as follows:

- The setting of the **CPSR.A** bit is ignored.
- PC, **CPSR**, **SPSR\_abt**, **LR\_abt**, **SCR.NS**, and **DBGDSCR.MOE** are unchanged.
- The processor remains in Debug state.
- The **DFSR** is unchanged.
- Other behavior depends on the value of **DBGDSCR.ADAdiscard**, and for some asynchronous aborts on the Debug architecture version. This is because, as described in *Asynchronous aborts and Debug state entry on page C5-2094*:
  - in v7 Debug, **DBGDSCR.ADAdiscard** applies to all asynchronous aborts
  - in v7.1 Debug, **DBGDSCR.ADAdiscard** applies only to external asynchronous aborts, and when this bit is set to 1 it is IMPLEMENTATION DEFINED which external asynchronous aborts are discarded.

#### When **DBGDSCR.ADAdiscard** is 0

- **DBGDSCR.ADABORT\_1** is unchanged
- on exit from Debug state, this asynchronous abort is acted on
- if the asynchronous abort is an external asynchronous abort, and the **ISR** is implemented, **ISR.A** is set to 1 indicating that an external abort is pending.

#### When **DBGDSCR.ADAdiscard** is 1

- **DBGDSCR.ADABORT\_1**, the Sticky Asynchronous Abort bit, is set to 1.
- In v7 Debug, and in v7.1 Debug for an asynchronous abort to which **ADAdiscard** applies:
  - on exit from Debug state, this asynchronous abort is not acted on
  - if the **ISR** is implemented, the **ISR.A** bit is not changed, because no abort is pending.

- In v7.1 Debug for an asynchronous abort to which ADAdiscard does not apply:
  - on exit from Debug state, this asynchronous abort is acted on
  - if the asynchronous abort is an external asynchronous abort, and the ISR is implemented, the ISR.A bit is set to 1 indicating that an external abort is pending.

See also:

- [Asynchronous aborts and Debug state entry on page C5-2094](#)
- [Effect of asynchronous aborts when the processor is in Debug state on page C5-2108](#)
- [Effect of asynchronous aborts on exiting Debug state on page C5-2111.](#)

---

**Note**

In Debug state, all instructions operate as specified for ARM state. Therefore, ThumbEE null check faults cannot occur in Debug state.

---

### C5.5.1 Handling of synchronous Data Aborts in Non-secure state, Virtualization Extensions

The Virtualization Extensions have no effect on the handling of synchronous Data Abort exceptions in Debug State if the processor is in Secure state. In this state, on a synchronous Data Abort exception, the [DFSR](#) and [DFAR](#) are updated.

When in Debug state and Non-secure state, the fault that caused the synchronous Data Abort exception determines which registers are updated, as follows:

#### Synchronous Data Abort exceptions that update the Non-secure [DFSR](#) and [DFAR](#)

In Debug state and Non-secure state, the following synchronous Data Abort exceptions update the [DFSR](#) and [DFAR](#):

- When [HCR.TGE](#) is set to 0, any Alignment fault, other than an Alignment fault caused by an unaligned access to Device or Strongly-ordered memory, that is generated in a Non-secure mode other than Hyp mode.
- Any Alignment fault that occurs, when in a Non-secure mode other than Hyp mode, because the PL1&0 stage 1 translation identifies the target of an unaligned access as Device or Strongly-ordered memory.
- Any MMU fault from a stage 1 address translation in the Non-secure PL1&0 translation regime.

---

**Note**

MMU faults do not include Alignment faults.

---

- When [HCR.TGE](#) is set to 0, any external abort from a Non-secure mode other than Hyp mode, except for an external abort on a stage 2 translation in the Non-secure PL1&0 translation regime.
- Any virtual abort.

#### Synchronous Data Abort exceptions that update the [HSR](#) and [HDFAR](#)

In Debug state and Non-secure state, the following synchronous Data Abort exceptions update the [HSR](#) and [HDFAR](#):

- When [HCR.TGE](#) is set to 1, any Alignment fault, other than an Alignment fault caused by an unaligned access to Device or Strongly-ordered memory, that is generated in a Non-secure mode other than Hyp mode.
- Any Alignment fault that occurs, when in a Non-secure mode other than Hyp mode, because the PL1&0 stage 2 translation identifies the target of an unaligned access as Device or Strongly-ordered memory.

- Any MMU fault from a stage 2 address translation in the Non-secure PL1&0 translation regime.
- **Note** —————
- MMU faults do not include Alignment faults.
- 
- Any MMU fault or Translation fault from a stage 1 address translation in the Non-secure PL2 translation regime.
  - Any synchronous external abort:
    - when [HCR.TGE](#) is set to 1, that is generated in a Non-secure mode other than Hyp mode
    - that is generated in Hyp mode
    - that occurs on a stage 2 address translation.

For a synchronous Data Abort exception generated in a Non-secure PL0 or PL1 mode, an external debugger can use [DBGDSCR.FS](#) and [HCR.TGE](#) to determine whether a Data Abort exception updated the [DFSR](#) and [DFAR](#), or updated the [HSR](#) and [HDFAR](#).

When in Debug state and Non-secure state, an abort never updates the Secure [DFSR](#) or [IFSR](#).

## C5.5.2 Effect of asynchronous aborts when the processor is in Debug state

While the processor is in Debug state and [DBGDSCR.ADAdiscard](#) is set to 1, [DBGDSCR.ADABORT\\_1](#), the Sticky Asynchronous Abort bit, is set to 1 by any asynchronous abort that occurs.

———— **Note** —————

- In v7 Debug, when [DBGDSCR.ADAdiscard](#) is set to 1, any asynchronous abort that occurs while the processor is in Debug state is discarded. However, v7.1 Debug restricts the asynchronous aborts that are discarded when [ADAdiscard](#) is set to 1, as described in [Asynchronous aborts and Debug state entry on page C5-2094](#).
- In issue B of this manual, some descriptions of the behavior of [DBGDSCR.ADABORT\\_1](#) when [DBGDSCR.ADAdiscard](#) is set to 1 refer to [ADABORT\\_1](#) being set to 1 when an asynchronous abort is discarded, but v7 Debug requires all asynchronous aborts to be discarded when [DBGDSCR.ADAdiscard](#) is set to 1. v7.1 Debug changes the required effect of setting [DBGDSCR.ADAdiscard](#) to 1, but does not change the behavior of [DBGDSCR.ADABORT\\_1](#).

---

An asynchronous abort that is discarded has no other effect on the state of the processor. The cause and type of the abort are not recorded. On a processor that implements the Security Extensions, because the abort does not become pending, if the asynchronous abort is an external asynchronous abort, the [ISR.A](#) bit is not updated.

———— **Note** —————

The [ISR](#) is implemented only on processors that include the Security Extensions.

---

A discarded asynchronous abort does not overwrite any asynchronous abort that was latched before or during the entry to Debug state sequence. This means the processor does not discard the latched abort if it detects another asynchronous abort while [DBGDSCR.ADAdiscard](#) is set to 1. The processor acts on the latched abort on exit from Debug state. On a processor that implements the Security Extensions, if the asynchronous abort is an external asynchronous abort the [ISR.A](#) bit reads as 1, indicating that an external abort is pending.



## C5.6 Memory system behavior in Debug state

The Debug architecture places requirements on the memory system. In particular, memory coherency must be maintained during debugging.

In v7 Debug, a debugger can use the Debug State Cache Control Register, [DBGDSCCR](#) and the Debug State MMU Control Register, [DBGDSMCR](#) to reduce the possible impact of debugging on the memory system.

———— **Note** —————

- There can be IMPLEMENTATION DEFINED limits on the behavior of [DBGDSCCR](#) and [DBGDSMCR](#), and v7.1 Debug does not support these registers.
- Any debug implementation can include IMPLEMENTATION DEFINED support for cache behavior override and, on a VMSA implementation, for TLB debug control.

In Debug state, reads must behave as in Non-debug state:

- cache hits return data from the cache
- cache misses fetch from external memory.

A debugger must use cache, branch predictor, and TLB maintenance operations to:

- maintain coherency between instruction and data memory
- maintain coherency in a multiprocessor system.

For an implementation that includes SUHD, see [Memory system behavior in Debug state when SUHD is supported on page AppxN-2583](#) for additional restrictions on the interaction between the debug architecture and the memory system.

## C5.7 Exiting Debug state

The processor exits Debug state:

- on a Reset exception, see *Exceptions in Debug state on page C5-2105*
- when it receives a restart request.

A restart request can be one of the following:

- An External Restart request. This is a request from the system for the processor to exit Debug state. The External Restart request enables multiple processors to be restarted synchronously.  
The External Restart request is generated by IMPLEMENTATION DEFINED means. Typically this is by asserting an External Restart request input to the processor.
- A restart request command. A debugger issues a restart request command by writing 1 to `DBGDRCCR.RRQ`, the Restart request bit.

The result is UNPREDICTABLE if the processor is signaled to exit Debug state when any of the following is true:

- The sticky exception bits, `DBGDSCR[8:6]`, are not set to `0b000`.

———— **Note** —————

The debugger clears the sticky exception bits to 0 by writing 1 to the `DBGDRCCR.CSE`, the Clear Sticky Exception Flags bit. This operation can be combined with the restart request command.

- The Execute ARM Instruction Enable bit, `DBGDSCR.ITRen`, is set to 1.
- The Latched Instruction Complete bit, `DBGDSCR.InstrCompl_1`, is set to 0, or an instruction issued through the `DBGITR` has not completed its changes to the architectural state of the processor.

———— **Note** —————

The `InstrCompl` flag, that indicates that execution of all instructions issued through the `DBGITR` is complete, is not visible in any register. To check the value of the `InstrCompl` flag, software must read `DBGDSCR.ext`. This copies the value of `InstrCompl` to `DBGDSCR.InstrCompl_1`, and returns the updated value of `InstrCompl_1`.

On receipt of a restart request, the processor performs a sequence of operations to exit Debug state.

If `DBGDSCR` is read during the restart sequence, `DBGDSCR.RESTARTED` must read as 0 and `DBGDSCR.HALTED` must read as 1. At all other times `DBGDSCR.RESTARTED` must read as 1.

On completion of the restart sequence, the processor exits Debug state:

- `DBGDSCR.HALTED` is set to 0.
- The processor stops ignoring debug events and starts executing instructions from the restart address held in the PC, in the mode and instruction set state indicated by the current value of the `CPSR`, as described in *CPSR and PC values on exit from Debug state on page C5-2111*.
- Unless the `DBGDSCR.DBGack` bit is set to 1, the processor signals to the system that it is in Non-debug state. Details of this signaling method, including whether it is implemented, are IMPLEMENTATION DEFINED.

———— **Note** ————

Exiting Debug state is not a context synchronization or memory barrier operation. This means that:

- If a debugger executes any context changing operations in Debug state, it must perform a context synchronization operation by executing an ISB instruction before exiting Debug state.
- If the debugger executes any memory access instructions in Debug state, it must execute a Data Synchronization Barrier (DSB) instruction before exiting Debug state, to ensure those accesses are complete. This DSB might form part of the IMPLEMENTATION DEFINED sequence of instructions required to ensure that the processor has recognized any asynchronous aborts, as described in *Effect of asynchronous aborts on exiting Debug state*.

For details of the recommended external debug interface, see *Run-control and cross-triggering signals* on page AppxA-2340 and *DBGACK and DBGCPUDONE* on page AppxA-2342.

### C5.7.1 CPSR and PC values on exit from Debug state

When the processor exits Debug state, Non-debug state execution restarts as follows:

- The mode and state of the processor are determined by the last value written to the **CPSR** while the processor was in Debug state, or, if no values were written to the **CPSR** while in Debug state, by the value of the **CPSR** on entry to Debug state. In either case, this includes restarting the IT state machine for Thumb instructions, with the current value applying to the first value executed.
- The address at which execution restarts is determined as follows:
  - if, while in Debug state, there was a write to the **CPSR** without a subsequent write to the PC, the address at which execution restarts is UNKNOWN
  - in v7 Debug, if, while in Debug state, there was no write to the PC, the address at which execution restarts is UNKNOWN
  - in v7.1 Debug, if, while in Debug state, there was no write to the PC, the address at which execution restarts is the PRA shown in [Table C5-1 on page C5-2100](#), without any offset
  - otherwise, execution restarts at the last address written to the PC while in Debug state.

### C5.7.2 Effect of asynchronous aborts on exiting Debug state

If the debugger has executed any memory access instructions, before exiting Debug state it must issue an IMPLEMENTATION DEFINED sequence of operations that ensures that any asynchronous aborts to which **DBGDSCR.ADAdiscard** applies have been recognized and discarded.

———— **Note** ————

In v7 Debug, **DBGDSCR.ADAdiscard** applies to all asynchronous aborts. However, in v7.1 Debug the scope of this bit is restricted as described in *Asynchronous aborts and Debug state entry* on page C5-2094.

On exit from Debug state, the processor automatically clears **DBGDSCR.ADAdiscard** to 0.

If an asynchronous abort is pending then the processor acts on the asynchronous abort on exit from Debug state:

- if the **CPSR.A** bit is 1, the abort is pending, and is taken when the A bit is cleared to 0
- if the **CPSR.A** bit is 0, the abort is taken by the processor.

For details of the recommended external debug interface, see *Run-control and cross-triggering signals* on page AppxA-2340 and *DBGACK and DBGCPUDONE* on page AppxA-2342.



# Chapter C6

## Debug Register Interfaces

This chapter describes the debug register interfaces. It contains the following sections:

- *About the debug register interfaces* on page C6-2114
- *Synchronization of debug register updates* on page C6-2115
- *Access permissions* on page C6-2117
- *The CP14 debug register interface* on page C6-2121
- *The memory-mapped and recommended external debug interfaces* on page C6-2126
- *Summary of the v7 Debug register interfaces* on page C6-2128
- *Summary of the v7.1 Debug register interfaces* on page C6-2137.

## C6.1 About the debug register interfaces

The Debug architecture defines a set of debug registers. [Chapter C11 The Debug Registers](#) describes the registers in detail.

The debug register interfaces provide access to these registers. This chapter describes the different possible implementations of the debug register interfaces.

The debug register interfaces provide access to the debug registers from:

- software running on the processor, see [Processor interfaces to the debug registers](#)
- an external debugger, see [External debug interface to the debug registers](#)
- optionally, other processors in a multiprocessor system.

### C6.1.1 Processor interfaces to the debug registers

The possible interfaces between the software running on the processor and the debug registers are:

- The CP14 interface. This provides access to a subset of the debug registers through a set of coprocessor instructions. These registers and this interface must be implemented by all processors. See [CP14 debug register interface accesses on page C6-2122](#).
- The memory-mapped interface. This is an optional interface that provides memory-mapped access to a subset of the debug registers. When it is implemented, it is IMPLEMENTATION DEFINED whether the memory-mapped interface is visible only to the processor in which the debug registers are implemented, or is also visible to other processors in the system.

See [The memory-mapped and recommended external debug interfaces on page C6-2126](#).

In v7 and v7.1 Debug, there are different registers and requirements for which registers are required in each interface. These are described in [Summary of the v7 Debug register interfaces on page C6-2128](#) and [Summary of the v7.1 Debug register interfaces on page C6-2137](#).

### C6.1.2 External debug interface to the debug registers

Every debug implementation must include an external debug interface. This interface gives an external debugger access to a subset of the debug registers through a *Debug Access Port* (DAP). This interface is IMPLEMENTATION DEFINED, and provides a memory-mapped view of the debug registers. For details of the interface recommended by ARM see the *ARM Debug Interface v5 Architecture Specification*.

The Debug architecture does not require implementation of the recommended interface. However:

- the ARM debug tools require the recommended interface
- ARM recommends this interface for compatibility with other tool chains.

See [The memory-mapped and recommended external debug interfaces on page C6-2126](#).

## C6.2 Synchronization of debug register updates

The debug registers are system control registers. For general information about the synchronization of register changes, see:

- [Synchronization of changes to system control registers on page B3-1461](#) for VMSA implementations
- [Synchronization of changes to system control registers on page B5-1777](#) for PMSA implementations.

Additional synchronization requirements apply to some debug register accesses, as described in:

- [Synchronization of accesses to the Debug Communications Channel.](#)
- [Synchronization requirements for memory-mapped register interfaces.](#)

### C6.2.1 Synchronization of accesses to the Debug Communications Channel

In Debug state, special rules apply to maintain communication between a debugger and the processor debug logic. This means the effects of any completed MCR or MRC access to the [DBGDTRTXint](#) or [DBGDTRRXint](#) registers must be observable to reads and writes of [DBGDSCRExt](#), [DBGITR](#), [DBGDTRTXext](#), and [DBGDTRRXext](#), without any explicit context synchronization operation. For more information, see [Chapter C8 The Debug Communications Channel and Instruction Transfer Register](#).

### C6.2.2 Synchronization requirements for memory-mapped register interfaces

———— **Note** —————

Except where it refers to specific features of the memory-mapped interfaces to the debug registers, the section applies to all memory-mapped register interfaces described in this manual. That is, it applies to memory-mapped accesses to:

- the debug registers
- the Performance Monitors registers, see [Appendix B Recommended Memory-mapped and External Debug Interfaces for the Performance Monitors](#)
- the Generic Timer registers, see [Appendix E System Level Implementation of the Generic Timer](#).

For a memory-mapped register interface, the following synchronization rules apply:

- All memory-mapped registers must be mapped to Strongly-ordered or Device memory, otherwise the effect of any access to the memory-mapped debug registers is UNPREDICTABLE.

———— **Note** —————

Memory-mapped registers might not be idempotent for reads or writes, meaning a repeated access might not have the same result each time. Therefore, the region of memory occupied by the registers must not be marked as Normal memory, because the memory order model permits accesses to Normal memory locations that are not appropriate for such registers.

- Any change to a memory-mapped register that appears in program order after an explicit memory operation is guaranteed not to affect that previous memory operation only if the order is guaranteed by the memory order model or by the use of memory barrier operations between the memory operation and the register change.
- A DSB operation causes the completion of all writes to memory-mapped registers that appear in program order before the DSB.
- With respect to other accesses by the same processor to the memory-mapped registers, all accesses to memory-mapped registers take effect in the order in which the accesses occur, as determined by the memory order model and the use of memory barrier operations.
- Any completed access to a memory-mapped register becomes visible at some point, but a context synchronization operation might be required to guarantee that the effects of the access are visible to subsequent instructions, see [Synchronization of changes to system control registers on page B3-1461](#). In

particular, a context synchronization operation is required to guarantee that a memory-mapped update to the debug registers affects the generation of Software debug events and OS Unlock catch debug events by subsequent instructions. For more information see [Generation of debug events on page C3-2074](#).

Otherwise, reads and writes to memory-mapped debug registers have their effects on completion of the read or write operation.

Synchronization between register updates made through an external debug interface and updates made by software running on the processor is IMPLEMENTATION DEFINED. However:

- If the external debug interface is implemented through the same port as the memory-mapped interface, then updates made through the external debug interface have the same properties as updates made through the memory-mapped interface. Any guarantees of ordering or completion of accesses made through the external debug interface are IMPLEMENTATION DEFINED. For more information, see [Recommended debug slave port on page AppxA-2344](#).
- As described in [Synchronization of accesses to the Debug Communications Channel on page C6-2115](#), in Debug state, the effect of any completed MCR or MRC access to the `DBGDTRXint` or `DBGDTRRXint` registers must be observable immediately to reads and writes of `DBGDSCRExt`, `DBGITR`, `DBGDTRXext`, and `DBGDTRRXext`, without any explicit context synchronization operation.



## C6.3 Access permissions

This section describes the basic concepts of the access permissions model for debug registers.

The restrictions for accessing the registers divide into the following categories:

### Privilege level of the access

The Debug architecture requires some of the following accesses to be at PL1 or higher:

- accesses from processors in the system to the memory-mapped registers
- accesses to coprocessor registers.

For more information, see [Permissions in relation to the privilege level of the access](#).

### Locks

Can lock out different parts of the register map so they cannot be accessed.

For more information, see [Permissions in relation to locks on page C6-2118](#).

### Powerdown

Registers in the core power domain cannot be accessed when that domain is powered down.

For more information, see [Permissions in relation to powerdown on page C6-2119](#).

The access permission and the effect of the various controls on the registers are summarized in:

- [Summary of the v7 Debug register interfaces on page C6-2128](#).
- [Summary of the v7.1 Debug register interfaces on page C6-2137](#).

If software does not have permission to access a register, the access causes an error. The nature of this error depends on the interface:

- For the CP14 interface, the error is an UNDEFINED instruction, which causes an Undefined Instruction exception.
- For the memory-mapped interface, the error is IMPLEMENTATION DEFINED, but the access must either be ignored or signaled to the processor as an external abort.
- For the external debug interface, the error must be signaled to the debugger by the Debug Access Port. With an ADIV5 implementation, this means the error sets a sticky flag in the DAP.

In addition to the required access permissions for the debug registers, in an implementation the includes the Virtualization Extensions, when the processor is in Non-secure state and executing software at PL0 or PL1, an access to a CP14 debug register that is permitted by the access permissions described in this section can generate a Hyp Trap exception. For more information, see [Trapping CP14 accesses to debug registers on page B1-1259](#).

Holding the processor in warm reset, whether by using an external warm reset signal or by using the *Device Powerdown and Reset Control Register*, **DBGPRCR**, does not affect the behavior of the memory-mapped or external debug interface. The Hold core warm reset control bit of the register enables an external debugger to keep the processor in warm reset while programming other debug registers.

### C6.3.1 Permissions in relation to the privilege level of the access

For the CP14 interface, software executing at PL1 or higher can control access from PL0 to a subset of the registers, defined in [CP14 debug register interface accesses on page C6-2122](#). The remaining CP14 debug registers can be accessed only by software executing at PL1 or higher.

For the memory-mapped interface, it is IMPLEMENTATION DEFINED whether the system restricts register accesses, for example by not permitting accesses from PL0. However, ARM strongly recommends that systems do not impose stronger restrictions, such as only permitting Secure PL1 accesses.

#### ———— Note ————

Such an access restriction relates to the privilege level of the initiator of the access, not to the current mode of the processor being accessed.

## C6.3.2 Permissions in relation to locks

A debugger or an operating system can lock the debug registers, to restrict access to these registers.

The Debug architecture provides the following locks. Some of the locks only apply to some interfaces:

### Software Lock

The Software Lock only applies to accesses made through the memory-mapped interface.

By default, software is locked out so the debug registers cannot be modified. A debug monitor must leave this lock set when not accessing the debug registers, to reduce the chance of errant software modifying debug settings. When this lock is set, and all other controls permit access to the registers, when using the memory-mapped interface to access the debug registers:

- Reads return the value of the register, but with no side-effects.
- Writes are ignored, and have no side effects.

For more information see [DBGLAR, Lock Access Register on page C11-2264](#) and [DBGLSR, Lock Status Register on page C11-2265](#).

### OS Lock

An OS must set this lock on the debug registers before starting an OS Save or OS Restore sequence, so that software, other than the software performing the OS Save or OS Restore sequence, cannot read or write these registers during the sequence.

Because the OS Save and Restore operations are different in v7 Debug and v7.1 Debug, the effects on register accesses in the different interfaces is different.

For details of the effects in v7 Debug see:

- [v7 Debug register access in the CP14 interface on page C6-2130](#)
- [v7 Debug register access in the memory-mapped and external debug interfaces on page C6-2132](#)

For details of the effects in v7.1 Debug see:

- [v7.1 Debug register access in the CP14 interface on page C6-2139](#)
- [v7.1 Debug register access in the memory-mapped and external debug interfaces on page C6-2141](#)

### ———— Note —————

An external debugger can clear this lock at any time, even if an OS Save or OS Restore operation is in progress.

For more information see [DBGOSLAR, OS Lock Access Register on page C11-2267](#) and [DBGOSLSR, OS Lock Status Register on page C11-2268](#).

### OS Double Lock

v7.1 Debug only. This locks out an external debugger completely. This lock must not be set at any time other than immediately before a powerdown sequence. Halting debug events are ignored and the memory-mapped interface and the external debug interface in the core power domain are forced to be idle.

The processor ignores the OS Double Lock control setting if either of the following applies:

- [DBGPRCR.CORENPDRQ](#), Core no powerdown request, is set to 1
- the processor is in Debug state.

The status of this lock can be read from [DBGPRSR.DLK](#), OS Double Lock status bit.

For more information see [DBGOSDLR, OS Double Lock Register on page C11-2266](#), [DBGPRCR, Device Powerdown and Reset Control Register on page C11-2278](#), and [DBGPRSR, Device Powerdown and Reset Status Register on page C11-2282](#).

### Debug Software Enable

This controls access to all debug registers through the memory-mapped interface, and access to certain debug registers through the CP14 interface.

An external debugger can use the Debug Software Enable function to control access by a debug monitor or other software running on the system. When the Debug Software Enable function is on, normal access is permitted. When the function is off access is denied.

In v7.1 Debug, if the Debug Software Enable function is off when the OS Lock is set, the setting is ignored and normal access is permitted.

The Debug Software Enable is a required function of the Debug Access Port, and is implemented as part of the ARM Debug Interface v5. For more information see the *ARM Debug Interface v5 Architecture Specification*, and *DBGSWENABLE* on page AppxA-2349.

---

#### Note

- The Software Lock and Debug Software Enable are always in the debug power domain. The Software Lock is set by a debug logic reset.
  - In v7 Debug, the OS Lock is in the debug power domain. The OS Lock is set to an IMPLEMENTATION DEFINED value by a debug logic reset. See *DBGOSLOCKINIT* on page AppxA-2347.
  - In v7.1 Debug, the OS Lock and OS Double Lock are in the core power domain. The OS Lock is set by a core powerup reset. The OS Double Lock is cleared by a non-debug logic reset.
  - On a SinglePower system, over a powerdown:
    - the Software Lock and OS Lock are lost
    - it is IMPLEMENTATION DEFINED whether the Debug Software Enable is lost, because it is IMPLEMENTATION DEFINED whether the single processor power domain includes the Debug Access Port.
- 

### C6.3.3 Permissions in relation to powerdown

Accesses made through all interfaces are affected if the core power domain or the debug power domain are powered down, and are described in the following sections.

#### Core power domain powered down

Accesses cannot be made through the CP14 interface when the core power domain is powered down.

Access to registers in the core power domain is not possible when the domain is powered down. Any access to these registers is ignored, and the system returns an error.

---

#### Note

Returning this error response, rather than ignoring writes, means that the debugger and the debug monitor detect the debug session interruption as soon as it occurs. This makes re-starting the session, after powerup, considerably easier.

---

When the core power domain powers down, *DBGPRSR.SPD*, the Sticky Powerdown status bit, is set to 1. This bit remains set to 1 until it is cleared to 0 by a read of the *DBGPRSR* after the core power domain has powered up. If the register is read while the core power domain is still powered down, the bit remains set to 1.

A debugger can poll the *DBGPRSR* to determine whether the core power domain is powered down. However, so that a debugger does not need to continually poll this register to test whether the values of debug registers in the core power domain have been lost, the architecture provides additional mechanisms to detect that the core power domain has powered down. The mechanism depends on the debug architecture version:

**v7 Debug** When *DBGPRSR.SPD* is 1 the behavior is as if the core power domain is powered down, meaning the processor ignores accesses to registers in the core power domain and the system returns an error.

**v7.1 Debug** The OS Lock is set on a core powerup reset, meaning that accesses from the external debug interface to registers in the core power domain will return errors until the OS Lock is explicitly cleared. For more information see [Permissions in relation to locks on page C6-2118](#).

---

**Note**

- In v7 Debug, the OS Lock is maintained over core powerdown, meaning it is set after powerup only if software had set it before powerdown.
- In v7.1 Debug `DBGPRSR.SPD` does not affect register accesses and is provided for information only.
- This behavior is useful because when the external debugger tries to access a register whose contents might have been lost by a powerdown, it gets the same response regardless of whether the core power domain is currently powered down or has powered back up. This means that, if the external debugger does not access the external debug interface during the window where the core power domain is powered down, the processor still reports the occurrence of the powerdown event.

---

### Debug logic domain powered down

Access to all debug registers is not possible if the debug logic is powered down. In this situation:

- When the debug power domain is powered down the system must respond to any access made through the memory-mapped or external debug interface. ARM recommends that the system generates an error response.
- In v7 Debug, accesses through the CP14 interface are UNPREDICTABLE.
- In v7.1 Debug, accesses through the CP14 interface are unaffected.

The debug logic is powered down:

- when the debug power domain is powered down, in an implementation with separate core and debug power domains
- when the processor is powered down, in a SinglePower implementation.

## C6.4 The CP14 debug register interface

The following subsections describe the CP14 debug register interfaces:

- [Using CP14 to access debug registers](#)
- [CP14 debug register interface accesses on page C6-2122](#)
- [CP14 interface instruction arguments on page C6-2124.](#)

### C6.4.1 Using CP14 to access debug registers

Accesses to registers that are visible in the CP14 interface generally use the following coprocessor instructions:

- MRC for read accesses
- MCR for write accesses.

In addition, the following coprocessors instructions are defined for specific registers accesses:

MRRC	read access to the <i>Debug ROM Address Register</i> , <b>DBGDRAR</b> , and the <i>Debug Self Address Offset Register</i> , <b>DBGDSAR</b> , in an implementation that includes the Large Physical Address Extension.
STC	read access to the Host to Target Data Transfer Register, <b>DBGDTRRXint</b>
LDC	write access to the Target to Host Data Transfer Register, <b>DBGDTRTXint</b>

#### Form of MRC and MCR instructions

The form of the MRC and MCR instructions used for accessing debug registers through the CP14 interface is:

```
MRC p14, 0, <Rt>, <CRn>, <CRm>, <opc2> ; Read
MCR p14, 0, <Rt>, <CRn>, <CRm>, <opc2> ; Write
```

Where <Rt> refers to any of the ARM core registers R0-R14. Use of R13 is UNPREDICTABLE in Thumb and ThumbEE states, and is deprecated in ARM state. <CRn>, <CRm>, and <opc2> are mapped from the debug register number as shown in [Figure C6-1](#)

The use of the MRC APSR\_nzcv form of the MRC instruction is permitted for reads of the **DBGDSCRint** only. Use with other registers is UNPREDICTABLE. See [CP14 interface 32-bit access instructions, required in all versions of the Debug architecture on page C6-2122](#) for more information.

For accesses to the debug registers, <CRn> <= 0b0111 and therefore bit[10] of the value in the figure is 0.

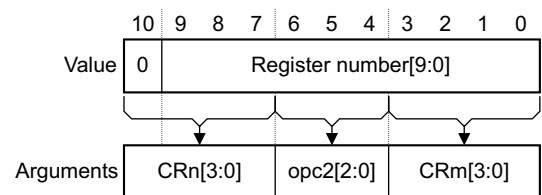

**Figure C6-1 Mapping from debug register number to CP14 instruction arguments**

[Figure C6-2](#) shows this mapping for register 194.

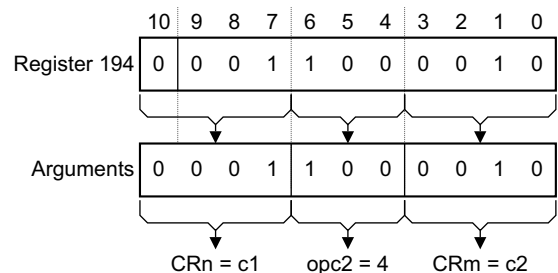

**Figure C6-2 Register mapping example, register 194**

The mapping in [Figure C6-2 on page C6-2121](#) means that the instruction to read register 194 is:

```
MRC p14, 0, <Rt>, c1, c2, 4 ; Read DBG0SSRR
```

An implementation that includes the Large Physical Address Extensions extends the [DBGDRAR](#) and [DBGDSAR](#) registers to 64 bits. In such an implementation, the MRC instruction that reads the register returns bits[31:0] of the register.

[Table C6-3 on page C6-2124](#) lists all registers visible in the CP14 interface, with their associated instruction arguments.

### Form of the MRRC instruction, when supported

In an implementation that includes the Large Physical Address Extension, the form of the MRRC instruction used for accessing all 64 bits of a 64-bit debug register through the CP14 interface is:

```
MRRC p14, 0, <Rt>, <Rt2>, <CRm> ; Read
```

As [Table C6-2 on page C6-2123](#) shows, the only 64-bit registers are [DBGDRAR](#) and [DBGDSAR](#). <CRm> is c1 for accesses to [DBGDRAR](#) and c2 for accesses to [DBGDSAR](#).

### Form of the STC and LDC instructions

The form of the STC and LDC instructions used for accessing the [DBGDTRRXint](#) and [DBGDTRTXint](#) registers through the CP14 interface is:

```
STC p14, c5, <addr_mode> ; Read DBGDTRRXint
LDC p14, c5, <addr_mode> ; Write DBGDTRTXint
```

## C6.4.2 CP14 debug register interface accesses

[Table C6-1](#) shows the debug instructions that make 32-bit register accesses and must be implemented in all versions of the Debug architecture.

**Table C6-1 CP14 interface 32-bit access instructions, required in all versions of the Debug architecture**

Instruction	Register:		
	Name	Number	Description
MRC p14, 0, <Rt>, c0, c0, 0	<a href="#">DBGDIDR</a>	0	<a href="#">DBGDIDR, Debug ID Register on page C11-2229</a>
MRC p14, 0, <Rt>, c0, c1, 0 MRC p14, 0, APSR_nzcv, c0, c1, 0 <sup>a</sup>	<a href="#">DBGDSCRint</a>	1	<a href="#">DBGDSCR internal view. See <i>DBGDSCR, Debug Status and Control Register on page C11-2241</i></a>
MRC p14, 0, <Rt>, c1, c0, 0	<a href="#">DBGDRAR</a>	128	<a href="#">DBGDRAR, Debug ROM Address Register on page C11-2232</a>
MRC p14, 0, <Rt>, c2, c0, 0	<a href="#">DBGDSAR</a>	256	<a href="#">DBGDSAR, Debug Self Address Offset Register on page C11-2237</a>
MCR p14, 0, <Rt>, c0, c5, 0 LDC p14, c5, <addr_mode>	<a href="#">DBGDTRTXint</a>	5	<a href="#">DBGDTRTX internal view. See <i>DBGDTRTX, Target to Host Data Transfer register on page C11-2260</i></a>
MRC p14, 0, <Rt>, c0, c5, 0 STC p14, c5, <addr_mode>	<a href="#">DBGDTRRXint</a>	5	<a href="#">DBGDTRRX internal view. See <i>DBGDTRRX, Host to Target Data Transfer register on page C11-2259</i></a>

a. Transfers [DBGDSCR\[31:28\]](#) to the N, Z, C and V condition flags. For more information, see [Program Status Registers \(PSRs\) on page B1-1147](#).

Table C6-2 shows the debug instructions that make 64-bit register accesses and must be implemented, for any version of the Debug architecture, if the implementation includes the Large Physical Address Extension.

**Table C6-2 CP14 interface 64-bit access instructions, Large Physical Address Extensions**

Instruction	Register:		
	Name	Number	Description
MRRC p14, 0, <Rt>, <Rt2>, c1	DBGDRAR	128	<i>DBGDRAR, Debug ROM Address Register on page C11-2232</i>
MRRC p14, 0, <Rt>, <Rt2>, c2	DBGDSAR	256	<i>DBGDSAR, Debug Self Address Offset Register on page C11-2237</i>

For more information about register internal and external views see *Internal and external views of the DBGDSCR and the DCC registers on page C8-2165*.

This baseline CP14 interface is sufficient to boot-strap access to the register file, and enables software to determine the version of the debug architecture implemented, and, for v7 Debug only, whether software access to the remaining debug registers must use the CP14 interface or the memory-mapped interface.

### v7 Debug deprecated uses of the CP14 interface

ARM deprecates using the CP14 interface to:

- access the [DBGDRCR](#), see *DBGDRCR, Debug Run Control Register on page C11-2234*
- access the [DBGECR](#), see *DBGECR, Event Catch Register on page C11-2261*
- access registers other than [DBGDTRRXint](#) and [DBGDTRTXint](#) in Debug state at PL0
- write to [DBGPRCR.HCWR](#), Hold core warm reset bit, or [DBGPRCR.CWRR](#), Core warm reset request bit.

### C6.4.3 CP14 interface instruction arguments

*Form of MRC and MCR instructions on page C6-2121* describes the form of the MCR and MRC instructions used for making 32-bit accesses to CP14 registers. *Table C6-3* shows the instruction arguments required for accesses to each register than can be visible in the CP14 interface.

**Table C6-3 Mapping of CP14 MCR and MRC instruction arguments to registers**

Register number	CRn	opc2	CRm	Access	Register name	Description
0	c0	0	c0	RO	<a href="#">DBGDIDR</a>	Debug ID
1	c0	0	c1	RO	<a href="#">DBGDSCR</a> <sub>int</sub>	Debug Status and Control internal
5	c0	0	c5	RO	<a href="#">DBGDTRRX</a> <sub>int</sub>	Host to Target Data Transfer internal
5	c0	0	c5	WO	<a href="#">DBGDTRTX</a> <sub>int</sub>	Target to Host Data Transfer internal
6	c0	0	c6	RW	<a href="#">DBGWFCR</a>	Watchpoint Fault Address
7	c0	0	c7	RW	<a href="#">DBGVCR</a>	Vector Catch
9	c0	0	c9	RW	<a href="#">DBGECR</a> <sup>a</sup>	Event Catch
10	c0	0	c10	RW	<a href="#">DBGDSCCR</a> <sup>b</sup>	Debug State Cache Control
11	c0	0	c11	RW	<a href="#">DBGDSMCR</a> <sup>b</sup>	Debug State MMU Control
32	c0	2	c0	RW	<a href="#">DBGDTRRX</a> <sub>ext</sub>	Host to Target Data Transfer external
34	c0	2	c2	RW	<a href="#">DBGDSCR</a> <sub>ext</sub>	Debug Status and Control external
35	c0	2	c3	RW	<a href="#">DBGDTRTX</a> <sub>ext</sub>	Target to Host Data Transfer external
36	c0	2	c4	RW	<a href="#">DBGDRCR</a> <sup>a</sup>	Debug Run Control
64-79	c0	4	c0-15	RW	<a href="#">DBGBVR</a> <sub>m</sub>	Breakpoint Value
80-95	c0	5	c0-15	RW	<a href="#">DBGBCR</a> <sub>m</sub>	Breakpoint Control
96-111	c0	6	c0-15	RW	<a href="#">DBGWVR</a> <sub>m</sub>	Watchpoint Value
112-127	c0	7	c0-15	RW	<a href="#">DBGWCR</a> <sub>m</sub>	Watchpoint Control
128	c1	0	c0	RO	<a href="#">DBGDRAR</a>	Debug ROM Address
144-159	c1	1	c0-15	RW	<a href="#">DBGBXVR</a> <sub>m</sub> <sup>c</sup>	Breakpoint Extended Value
192	c1	4	c0	WO	<a href="#">DBGOSLAR</a>	OS Lock Access
193	c1	4	c1	RO	<a href="#">DBGOSLSR</a>	OS Lock Status
194	c1	4	c2	RW	<a href="#">DBGOSSRR</a> <sup>b</sup>	OS Save and Restore
195	c1	4	c3	RW	<a href="#">DBGOSDLR</a> <sup>d</sup>	OS Double Lock
196	c1	4	c4	RW	<a href="#">DBGPRCR</a>	Device Powerdown and Reset Control
197	c1	4	c5	RO	<a href="#">DBGPRSR</a> <sup>a</sup>	Device Powerdown and Reset Status
256	c2	0	c0	RO	<a href="#">DBGDSAR</a>	Debug Self Address Offset
512-575	c4	0-3	c0-15	IMP DEF	-	IMPLEMENTATION DEFINED
928-959	c7	2-3	c0-15	IMP DEF	-	Integration registers
960	c7	4	c0	IMP DEF	<a href="#">DBGITCTRL</a>	Integration Mode Control



**Table C6-3 Mapping of CP14 MCR and MRC instruction arguments to registers (continued)**

Register number	CRn	opc2	CRm	Access	Register name	Description
1000	c7	6	c8	RW	<a href="#">DBGCLAIMSET</a>	Claim Tag Set
1001	c7	6	c9	RW	<a href="#">DBGCLAIMCLR</a>	Claim Tag Clear
1006	c7	6	c14	RO	<a href="#">DBGAUTHSTATUS</a>	Authentication Status
1008	c7	7	c0	RO	DBGDEVID2 <sup>d</sup>	Contents reserved, RAZ
1009	c7	7	c1	RO	<a href="#">DBGDEVID1</a> <sup>d</sup>	Device ID 1
1010	c7	7	c2	RO	<a href="#">DBGDEVID</a>	Device ID 0

- a. v7 Debug only. In v7.1 Debug, the register is not visible in the CP14 interface.
- b. v7 Debug only. The register is not implemented in v7.1 Debug.
- c. Virtualization Extensions only.
- d. v7.1Debug only.

*Form of the MRRC instruction, when supported on page C6-2122* describes the form of the MRRC instruction used for reading a 64-bit CP14 register, in an implementation that includes the Large Physical Address Extension.

[Table C6-4](#) shows the instruction arguments required for accesses to the 64-bit registers that can be visible in the CP14 interface.

**Table C6-4 Mapping of CP14 MRRC instruction arguments to registers, Large Physical Address Extension**

Register number	CRm	Access	Register name	Description
128	c1	RO	<a href="#">DBGDRAR</a>	Debug ROM Address, 64-bit register
256	c2	RO	<a href="#">DBGDSAR</a>	Debug Self Address Offset, 64-bit register

## C6.5 The memory-mapped and recommended external debug interfaces

The external debug interface is IMPLEMENTATION DEFINED. This section describes the ARM recommendations for this interface.

The memory-mapped interface to the debug registers is optional.

As defined in *CP14 debug register interface accesses* on page C6-2122, for all ARMv7 debug implementations, there is a small subset of debug registers that must be visible in the CP14 register interface.

In v7 Debug, in addition, a larger subset of debug registers must be accessible to software running on the processor, and it is IMPLEMENTATION DEFINED whether these registers are visible in the CP14 interface or in the memory-mapped interface. For v7 Debug, [Table C6-5 on page C6-2128](#) shows these register subsets.

In v7.1 Debug, [Table C6-8 on page C6-2137](#) shows which registers are visible in the different interfaces, and where it is IMPLEMENTATION DEFINED if a register is visible.

The Debug architecture defines both the memory-mapped interface and the recommended external debug interface as an addressable register file mapped onto a region of memory.

This section describes:

- the view of the debug registers from the processor through the memory-mapped interface
- the recommended external debug interface.

### C6.5.1 Register map

The register map occupies 4KB of physical address space. The base address is IMPLEMENTATION DEFINED and must be aligned to a 4KB boundary.

———— **Note** ————

All memory-mapped debug registers must be mapped to Strongly-ordered or Device memory, see *Synchronization of debug register updates* on page C6-2115. In a system that implements PMSAv7 this requirement applies even when the MPU is disabled.

Each register is mapped at an offset that is the register number multiplied by 4, the size of a word. For example, [DBGWVR7](#), register 103, is mapped at offset 0x19C (412).

See *Debug registers summary* on page C11-2193 for the complete list of debug registers.

### C6.5.2 Shared interface port for the memory-mapped and external debug interfaces

Which components in a system can access the memory-mapped interface is IMPLEMENTATION DEFINED. Typically, the processor itself and other processors in the system can access this interface. An external debugger might be able to access the debug registers through the memory-mapped interface, as well as through the external debug interface.

Because the memory-mapped interface and external debug interface share the same memory map and many of the same properties, both interfaces can be implemented as a single physical interface port to the processor.

When the memory-mapped interface and external debug interface are implemented as a single physical interface port, the debug logic must be able to distinguish between accesses from:

- an external debugger
- software running on a processor, including the ARM processor itself, in the target system.

For example, the Software Lock does not affect accesses by an external debugger.

The recommended memory-mapped interface and the external debug interface use the **PADDRDBG[31]** signal to distinguish between these accesses, see *PADDRDBG* on page AppxA-2344.

### C6.5.3 Endianness

The recommended memory-mapped and external debug interface port, referred to as the debug port, only supports word accesses, and has a fixed byte order. The debug port ignores bits[1:0] of the address, and these bits are not present in the recommended debug port interface.

To connect to an external debugger, the debug port must connect to a *Debug Access Port* (DAP). The DAP and the interface between the DAP and the debug port form part of the external debug interface, and must support word accesses from the external debugger to the debug registers.

ARM recommends that the DAP and its interface to the debug port are provided by an *ARM Debug Interface v5* (ADIV5) DAP. An ADIV5 implementation must ensure that it preserves the bit order of a 32-bit access by the debugger, through the DAP, to the debug registers. The *ARM Debug Interface v5 Architecture Specification* defines this interface.

If an implementation also includes a memory-mapped interface, the system must support word accesses to the debug registers. When accessing the debug registers, the behavior of an access that is not word-sized is UNPREDICTABLE. The detailed behavior of any connection between a system bus and the debug port is outside the scope of the architecture. The ADIV5 DAP specification includes an optional bridge that can connect a system bus to the interface between the DAP and the debug port.

Accesses to registers made through the debug port are not affected by the endianness configuration of the processor in which the registers are implemented. However, they are affected by the endianness configuration of the bus master making the access, and by the nature and configuration of the fabric that connects the two.

When describing accesses to the debug registers through the memory-mapped and external debug interfaces, this manual assumes that the external interface to the debug port is little-endian. For example, if a processor configured for little-endian operation uses a LDR instruction to access its own [DBGDIDR](#) through the memory-mapped interface, the destination register for the instruction returns the bit pattern defined by [DBGDIDR](#).

A memory-mapped interface to the debug registers is a memory-mapped peripheral, and therefore the endianness of this interface is IMPLEMENTATION DEFINED. However, all of the debug registers in single processor, when accessed through such an interface, have the same endianness.

Software might read the any of the Debug Component ID Registers, [DBGCID0](#), [DBGCID1](#), [DBGCID2](#), or [DBGCID3](#), to determine the endianness of the memory-mapped interface. See [About the Debug Component Identification Registers](#) on page C11-2208.

## C6.6 Summary of the v7 Debug register interfaces

This section shows how the v7 Debug registers can be accessed through the different interfaces, and how the access is affected by the privilege level, locks, and powerdown settings:

- [v7 Debug register visibility in the different interfaces](#)
- [v7 Debug register access in the CP14 interface on page C6-2130](#)
- [v7 Debug register access in the memory-mapped and external debug interfaces on page C6-2132](#)
- [Accesses to reserved and unallocated registers, v7 Debug on page C6-2135.](#)

### C6.6.1 v7 Debug register visibility in the different interfaces

Table C6-5 shows the required visibility of the debug registers in a v7 Debug implementation, as follows:

- A group of debug registers must be visible in the CP14 interface. The *CP14* column identifies the registers in this group.
- A group of debug registers must be visible in either the CP14 interface or the memory-mapped interface. The *CP14 or MM* column identifies the registers in this group, and:
  - These registers can be visible in both of these interfaces.
  - If all of these registers are visible in the CP14 interface then implementation of the memory-mapped interface is optional. *DBGDIDR*.Version indicates whether the CP14 interface is extended to provide access to these registers.
  - If the memory-mapped interface is implemented then all of these registers must be visible in the memory-mapped interface. Therefore, all of these registers also have a Yes entry in the *MM* column.
- A group of debug registers must be visible in the external debug interface. The *ED* column identifies the registers in this group.
- A group of debug registers must be visible in the memory-mapped interface if that interface is implemented. The *MM* column identifies the registers in this group. This includes all the registers in the *CP14 or MM* group.

In Table C6-5:

- Yes** Indicates that the register is part of the group.
- Optional** Indicates that, in v7 Debug, it is IMPLEMENTATION DEFINED whether the register is implemented. If it is implemented, then unless otherwise indicated by a footnote to the *Optional* entry, it must be part of the group. Where appropriate, the register description gives more information about whether an implementation should include the register.
- Indicates that the register is not part of the group.

**Table C6-5 v7 Debug registers required visibility**

Number	Name	Description	Required in:			
			CP14	CP14 or MM	ED	MM
0	<a href="#">DBGDIDR</a>	Debug ID	Yes	-	Yes	Yes
1	<a href="#">DBGDSCR</a> int	Debug Status and Control	Yes	-	-	-
5	<a href="#">DBGDTRTX</a> int, WO	Host to Target Data Transfer	Yes	-	-	-
	<a href="#">DBGDTRRX</a> int, RO	Target to Host Data Transfer	Yes	-	-	-
6	<a href="#">DBGWFA</a> R	Watchpoint Fault Address	-	Yes	Yes	Yes
7	<a href="#">DBGVCR</a>	Vector Catch	-	Yes	Yes	Yes
9	<a href="#">DBGECR</a>	Event Catch	-	Optional	Optional	Optional

Table C6-5 v7 Debug registers required visibility (continued)

Number	Name	Description	Required in:			
			CP14	CP14 or MM	ED	MM
10	<a href="#">DBGDSCCR</a>	Debug State Cache Control	-	Yes	Yes	Yes
11	<a href="#">DBGDSMCR</a>	Debug State MMU Control	-	Yes	Yes	Yes
32	<a href="#">DBGDTRRX</a> ext	Host to Target Data Transfer	-	Yes	Yes	Yes
33	<a href="#">DBGITR</a> , WO	Instruction Transfer	-	-	Yes	Yes
	<a href="#">DBGPCSR</a> , RO	Program Counter Sampling	-	-	Optional <sup>a</sup>	Optional <sup>a</sup>
34	<a href="#">DBGDSCR</a> ext	Debug Status and Control	-	Yes	Yes	Yes
35	<a href="#">DBGDTRTX</a> ext	Target to Host Data Transfer	-	Yes	Yes	Yes
36	<a href="#">DBGDRCR</a>	Debug Run Control	-	Yes	Yes	Yes
40	<a href="#">DBGPCSR</a>	Program Counter Sampling	-	-	Optional	Optional
41	<a href="#">DBGCIDSR</a>	Context ID Sampling	-	-	Optional	Optional
42	<a href="#">DBGVIDSR</a>	Virtualization ID Sampling	-	-	Optional	Optional
64-79	<a href="#">DBGBVR</a> m	Breakpoint Value	-	Yes	Yes	Yes
80-95	<a href="#">DBGBCR</a> m	Breakpoint Control	-	Yes	Yes	Yes
96-111	<a href="#">DBGWVR</a> m	Watchpoint Value	-	Yes	Yes	Yes
112-127	<a href="#">DBGWCR</a> m	Watchpoint Control	-	Yes	Yes	Yes
128	<a href="#">DBGDRAR</a>	Debug ROM Address	Yes	-	-	-
192	<a href="#">DBGOSLAR</a>	OS Lock Access	-	Optional	Optional	Optional
193	<a href="#">DBGOSLSR</a>	OS Lock Status	-	Yes	Yes	Yes
194	<a href="#">DBGOSSRR</a>	OS Save and Restore	-	Optional	Optional	Optional
196	<a href="#">DBGPRCR</a>	Powerdown and Reset Control	-	Yes	Yes	Yes
197	<a href="#">DBGPRSR</a>	Powerdown and Reset Status	-	Yes	Yes	Yes
256	<a href="#">DBGDSAR</a>	Debug Self Address Offset	Yes	-	-	-
512-575	-	IMPLEMENTATION DEFINED	-	Optional <sup>b</sup>	Optional <sup>b</sup>	Optional <sup>b</sup>
832-895	Various	Processor ID registers	-	-	Yes	Yes
928-959	Various	Integration registers	-	Optional <sup>b</sup>	Optional <sup>b</sup>	Optional <sup>b</sup>
960	<a href="#">DBGITCTRL</a>	Integration Mode Control	-	Optional <sup>b</sup>	Optional <sup>b</sup>	Optional <sup>b</sup>
1000	<a href="#">DBGCLAIMSET</a>	Claim Tag Set	-	Yes	Yes	Yes
1001	<a href="#">DBGCLAIMCLR</a>	Claim Tag Clear	-	Yes	Yes	Yes
1004	<a href="#">DBGLAR</a>	Lock Access	-	-	-	Yes
1005	<a href="#">DBGLSR</a>	Lock Status	-	-	-	Yes
1006	<a href="#">DBGAUTHSTATUS</a>	Authentication Status	-	Yes	Yes	Yes

**Table C6-5 v7 Debug registers required visibility (continued)**

Number	Name	Description	Required in:			
			CP14	CP14 or MM	ED	MM
1008	DBGDEVID2	Debug Device ID 2	-	-	UNK/SBZP <sup>c</sup>	UNK/SBZP <sup>c</sup>
1009	<a href="#">DBGDEVID1</a>	Debug Device ID 1	-	-	Optional <sup>c</sup>	Optional <sup>c</sup>
1010	<a href="#">DBGDEVID</a>	Debug Device ID	-	Optional	Optional <sup>c</sup>	Optional <sup>c</sup>
1011	<a href="#">DBGDEVTYPE</a>	Device Type	-	-	Yes	Yes
1012-1019	<a href="#">DBGPID0-DBGPID4</a>	Debug Peripheral ID	-	-	Yes	Yes
1020-1023	<a href="#">DBGCID0-DBGCID3</a>	Debug Component ID	-	-	Yes	Yes

- When the [DBGPCSR](#) is visible as register 40, ARM deprecates accessing the [DBGPCSR](#) as register 33, and strongly recommends that the register is accessed only as register 40.
- Visibility and access is IMPLEMENTATION DEFINED.
- In the memory-mapped interface and the external interface, software cannot distinguish between a register location being reserved and the register being implemented with all fields RAZ.

### C6.6.2 v7 Debug register access in the CP14 interface

This section summarizes register access in the CP14 interface for v7 Debug. See [The CP14 debug register interface on page C6-2121](#) and [CP14 interface instruction arguments on page C6-2124](#) for more information on the CP14 interface.

In v7 Debug, access to the debug registers visible in the CP14 interface is affected by:

- privilege level
- Debug state
- the Debug Software Enable function
- [DBGDSCR.UDCCdis](#), User mode access to DCC disable bit
- OS Lock, if the OS Save and Restore mechanism is implemented
- [DBGPRSR.SPD](#), Sticky powerdown status bit.

In addition, in v7 Debug, all register accesses through the CP14 interface are UNPREDICTABLE when the debug power domain is powered down.

[Table C6-6 on page C6-2131](#) shows the default access to the registers visible in the CP14 interface. The default access shows the access when all locks are off, and the access is made when either:

- the processor is in Debug state
- the processor is in Non-debug state, and the privilege level is PL1.

The access in the CP14 interface is affected by various locks and settings and combinations of these. These are shown in the table headings in [Table C6-6 on page C6-2131](#) as:

<b>DSE</b>	Debug Software Enable function. If the function is off, access to certain registers becomes UNDEFINED.
<b>PL0</b>	When the processor is in Non-debug state and the privilege level is PL0, access to certain registers becomes UNDEFINED.
<b>UDCC</b>	When the processor is in Non-debug state, the privilege level is PL0, and the User mode access to DCC disable bit, <a href="#">DBGDSCR.UDCCdis</a> , is set to 1, the access to certain registers becomes UNDEFINED.

**OSL** If the OS Save and Restore mechanism is implemented, and the OS Lock is set, access to certain registers becomes UNDEFINED or UNPREDICTABLE.

———— **Note** ————

It is not possible to access CP14 registers in Debug state when the OS Lock is set, since when the OS Lock is set accesses to the DBGITR through the memory-mapped or external debug interfaces return an error, so it is not possible to execute CP14 instructions.

**SPD** When the Sticky Powerdown status bit, **DBGPRSR.SPD**, is set to 1, access to certain registers becomes UNDEFINED or UNPREDICTABLE.

Table C6-6 uses the following abbreviations:

**UND** UNDEFINED  
**UNP** UNPREDICTABLE  
**IMP DEF** IMPLEMENTATION DEFINED.

In addition, in Table C6-6, an entry of - indicates that the control has no effect on the behavior of accesses to that register. This means:

- If no other control affects the behavior, the *Default access* behavior applies.
- However, another control might determine the behavior. For example, for **DBGDSCRint**:
  - the *DSE*, *PL0*, and *SPD* controls have no effect on the behavior
  - if the *OSL* control is set, all accesses are UNPREDICTABLE, except for accesses that the UDCC control make UNDEFINED.

If a register is not shown in Table C6-6 it is not visible in the CP14 interface, and any access is treated as an access to an unallocated CP14 register encoding, see *Accesses to reserved and unallocated registers, v7 Debug* on page C6-2135.

**Table C6-6 v7 Debug CP14 interface access behavior**

Register number	Register name	Default access	DSE	PL0	UDCC	OSL	SPD
0	<b>DBGDIDR</b>	RO <sup>a</sup>	-	-	UND	-	-
1	<b>DBGDSCRint</b>	RO <sup>a</sup>	-	-	UND	UNP <sup>b</sup>	-
5	<b>DBGDTRRXint</b>	RO	-	-	UND	UNP <sup>b</sup>	-
	<b>DBGDTRTXint</b>	WO	-	-	UND	UNP <sup>b</sup>	-
6	<b>DBGWFAR</b>	RW <sup>a</sup>	UND	UND	UND	UND	UND
7	<b>DBGVCR</b>	RW <sup>a</sup>	UND	UND	UND	UND	UND
9	<b>DBGECR</b>	RW <sup>a</sup>	UND	UND	UND	-	-
10	<b>DBGDSCCR</b>	RW <sup>a</sup>	UND	UND	UND	UND	UND
11	<b>DBGDSMCR</b>	RW <sup>a</sup>	UND	UND	UND	UND	UND
32	<b>DBGDTRRXext</b>	RW <sup>a</sup>	UND	UND	UND	UND	UND
34	<b>DBGDSCRext</b>	RW <sup>a</sup>	UND	UND	UND	UND	UND
35	<b>DBGDTRTXext</b>	RW <sup>a</sup>	UND	UND	UND	UND	UND
36	<b>DBGDRCR</b>	WO <sup>a</sup>	UND	UND	UND	-	-
64-79	<b>DBGBVRm</b>	RW <sup>a</sup>	UND	UND	UND	UND	UND

**Table C6-6 v7 Debug CP14 interface access behavior (continued)**

Register number	Register name	Default access	DSE	PL0	UDCC	OSL	SPD
80-95	<a href="#">DBGBCR<sub>m</sub></a>	RW <sup>a</sup>	UND	UND	UND	UND	UND
96-111	<a href="#">DBGWVR<sub>m</sub></a>	RW <sup>a</sup>	UND	UND	UND	UND	UND
112-127	<a href="#">DBGWCR<sub>m</sub></a>	RW <sup>a</sup>	UND	UND	UND	UND	UND
128	<a href="#">DBGDRAR</a>	RO <sup>a</sup>	-	-	UND	RO <sup>c</sup>	-
192	<a href="#">DBGOSLAR<sup>d</sup></a>	WO <sup>a</sup>	-	UND	UND	-	-
193	<a href="#">DBGOSLSR</a>	RO <sup>a</sup>	-	UND	UND	-	-
194	<a href="#">DBGOSSRR<sup>d</sup></a>	UNP	-	UND	UND	RW	-
196	<a href="#">DBGPRCR</a>	RW <sup>a</sup>	UND	UND	UND	-	-
197	<a href="#">DBGPRSR</a>	RO <sup>a</sup>	-	UND	UND	-	-
256	<a href="#">DBGDSAR</a>	RO <sup>a</sup>	-	-	UND	RO <sup>c</sup>	-
512-575	IMPLEMENTATION DEFINED	IMP DEF	UND	IMP DEF	IMP DEF	IMP DEF	IMP DEF
928-959	Integration registers	IMP DEF	UND	UND	UND	IMP DEF	IMP DEF
960	<a href="#">DBGITCTRL</a>	IMP DEF	UND	UND	UND	IMP DEF	IMP DEF
1000	<a href="#">DBGCLAIMSET</a>	RW <sup>a</sup>	UND	UND	UND	-	-
1001	<a href="#">DBGCLAIMCLR</a>	RW <sup>a</sup>	UND	UND	UND	-	-
1006	<a href="#">DBGAUTHSTATUS</a>	RO <sup>a</sup>	UND	UND	UND	-	-
1010	<a href="#">DBGDEVID</a>	RO <sup>a</sup>	UND	UND	UND	-	-

- ARM deprecates the use of this register from privilege level PL0 in Debug state.
- Access is UNDEFINED if privilege level is PL0, in Non-debug state, and [DBGDSCR](#).UDCCdis is set to 1.
- If the memory-mapped interface is not implemented then, if the privilege level is PL0, and [DBGDSCR](#).UDCCdis is set to 1, the access is UNDEFINED, otherwise the access is UNPREDICTABLE.
- Access to this register is always UNPREDICTABLE if the implementation does not include the OS Save and Restore mechanism.

### C6.6.3 v7 Debug register access in the memory-mapped and external debug interfaces

This section summarizes register access in the memory-mapped interface and external debug interface for v7 Debug. See [The memory-mapped and recommended external debug interfaces on page C6-2126](#) for more information on the interfaces.

In v7 Debug, access to the debug registers visible in the memory-mapped and external debug interfaces is affected by:

- Core and debug power domain settings.  
If the debug power domain is powered down, any access to a register through either register interface produces an error.  
If a single power domain is implemented and is powered down, any access to a register through either register interface produces an error.  
If the core power domain is powered down, access to some registers through either interface produces an error, as shown in [Table C6-7 on page C6-2134](#).
- Debug Software Enable function. If this function is off, access through the memory-mapped interface produces an error. Access through the external debug interface is unaffected.



- Software Lock. If all other controls permit access to the registers, and the Software Lock is set, access to all registers through the memory-mapped interface is restricted as follows:
  - Reads return the value of the register, but with no side-effects.
  - Writes are ignored, and have no side effects.

For more information about the behavior of the accesses, see [Table C6-7 on page C6-2134](#).

Access to the **DBGLAR**, which sets and releases the Software Lock, is not affected.

Access through the external debug interface is not affected by the Software Lock.

- Sticky powerdown setting, if implemented. If **DBGPRSR.SPD**, the Sticky powerdown status bit, is set to 1, access to some registers through either interface produces an error, as shown in [Table C6-7 on page C6-2134](#).
- OS Lock. If the OS Save and Restore mechanism is implemented, and the OS Lock is set, access to some registers through either interface is affected, as shown in [Table C6-7 on page C6-2134](#).

For the accesses that produce an error response, the error response is IMPLEMENTATION DEFINED:

- For the memory-mapped interface, the error is IMPLEMENTATION DEFINED, but the access must either be ignored or signaled to the processor as an external abort
- For the external debug interface, the error must be signaled to the debugger by the Debug Access Port. With an ADIV5 implementation, this means the error sets a sticky flag in the DAP.

[Table C6-7 on page C6-2134](#) shows the default access to the registers visible in the memory-mapped and external debug interfaces. The access in the memory-mapped and external debug interfaces is affected by various locks and settings and combinations of these. These are shown in the table headings in [Table C6-7 on page C6-2134](#) as:

<b>CPD</b>	When core power domain is powered down, accesses to some registers through either interface produce an error.
<b>SPD</b>	When <b>DBGPRSR.SPD</b> , the Sticky powerdown status bit, is set to 1, accesses to some registers through either interface produce an error.
<b>OSL</b>	When the OS Lock is set, accesses to some registers through either interface produce an error.
<b>SLK</b>	When the Software Lock is set, if all other controls permit accesses to the registers, accesses through the memory-mapped interface are read-only and have no side-effects. An access that is UNPREDICTABLE is guaranteed not to perform a register write.

[Table C6-7 on page C6-2134](#) uses the following abbreviations:

<b>Err</b>	Error. If multiple conditions apply to an access, Err has priority over any other possible outcome.
<b>UNP</b>	UNPREDICTABLE.
<b>IMP DEF</b>	IMPLEMENTATION DEFINED.

In addition, in [Table C6-7 on page C6-2134](#), an entry of - indicates that the control has no effect on the behavior of accesses to that register. This means:

- If no other control affects the behavior, the *Default access* behavior applies.
- However, another control might determine the behavior. For example, in an implantation that includes the OS Save and Restore mechanism, for **DBGOSLAR**:
  - the *SPD* and *OSL* controls have no effect on the behavior
  - if the *CPD* control applies, all accesses are UNPREDICTABLE.

If a register is not shown in [Table C6-7 on page C6-2134](#) it is not visible in the memory-mapped interface or in the external debug interface, and any access to it is treated as an access to a reserved register. [Accesses to reserved and unallocated registers, v7 Debug on page C6-2135](#) describes the behavior of accesses to reserved register addresses.

**Table C6-7 v7 Debug memory-mapped and external debug interfaces access behavior**

Register number	Offset	Register name	Default access	CPD	SPD	OSL	SLK <sup>a</sup>
0	0x000	DBGDIDR	RO	-	-	-	-
6	0x018	DBGWFAR	RW	Err	Err	Err	RO
7	0x01C	DBGVCR	RW	Err	Err	Err	RO
9	0x024	DBGECR	RW	-	-	-	RO
10	0x028	DBGDSCCR	RW	Err	Err	Err	RO
11	0x02C	DBGDSMCR	RW	Err	Err	Err	RO
32	0x080	DBGDTRRXext	RW	Err	Err	Err	RO <sup>b</sup>
33	0x084	DBGPCSR	RO	Err	Err	Err	RO <sup>b</sup>
	0x084	DBGITR	WO <sup>c</sup>	Err	Err	Err	WI
34	0x088	DBGDSCRExt	RW	Err	Err	Err	RO <sup>b</sup>
35	0x08C	DBGDTRTXext	RW	Err	Err	Err	RO <sup>b</sup>
36	0x090	DBGDRCR	WO	WO <sup>d</sup>	-	-	WI
40	0x0A0	DBGPCSR	RO	Err	Err	Err	RO <sup>b</sup>
41	0x0A4	DBGCIDSR	RO	Err	Err	Err	-
42	0x0A8	DBGVIDSR	RO	Err	Err	Err	-
64-79	0x100-0x13C	DBGBVRm	RW	Err	Err	Err	RO
80-95	0x140-0x17C	DBGBCRm	RW	Err	Err	Err	RO
96-111	0x180-0x1BC	DBGWVRm	RW	Err	Err	Err	RO
112-127	0x1C0-0x1FC	DBGWCRm	RW	Err	Err	Err	RO
192	0x300	DBGOSLAR <sup>e</sup>	WO	UNP	-	-	WI <sup>a</sup>
193	0x304	DBGOSLSR	RO	-	-	-	-
194	0x308	DBGOSSRR <sup>e</sup>	UNP	-	-	RW or RAZ/WI <sup>f</sup>	RO <sup>b</sup>
196	0x310	DBGPRCR	RW	-	-	-	RO
197	0x314	DBGPRSR	RO	RO <sup>d</sup>	RO <sup>d</sup>	-	RO <sup>b</sup>
512-575	0x800-0x8FC	IMPLEMENTATION DEFINED	IMP DEF	IMP DEF	IMP DEF	IMP DEF	IMP DEF <sup>a</sup>
832-895	0xD00-0xDFC	Processor IDs	RO	-	-	-	-
928-959	0xE80-0xEFC	Integration registers	IMP DEF	IMP DEF	IMP DEF	IMP DEF	IMP DEF <sup>a</sup>
960	0xF00	DBGITCTRL	IMP DEF	IMP DEF	IMP DEF	IMP DEF	IMP DEF <sup>a</sup>
1000	0xFA0	DBGCLAIMSET	RW	-	-	-	RO
1001	0xFA4	DBGCLAIMCLR	RW	-	-	-	RO

**Table C6-7 v7 Debug memory-mapped and external debug interfaces access behavior (continued)**

Register number	Offset	Register name	Default access	CPD	SPD	OSL	SLK <sup>a</sup>
1004	0xFB0	<a href="#">DBGLAR</a> <sup>g</sup>	WO	-	-	-	- <sup>g</sup>
1005	0xFB4	<a href="#">DBGLSR</a> <sup>g</sup>	RO	-	-	-	-
1006	0xFB8	<a href="#">DBGAUTHSTATUS</a>	RO	-	-	-	-
1008	0xFC0	<a href="#">DBGDEVID2</a>	RO	-	-	-	-
1009	0xFC4	<a href="#">DBGDEVID1</a>	RO	-	-	-	-
1010	0xFC8	<a href="#">DBGDEVID</a>	RO	-	-	-	-
1011	0xFCC	<a href="#">DBGDEVTYPE</a>	RO	-	-	-	-
1012-1019	0xFD0-0xFEC	<a href="#">DBGPID0</a> - <a href="#">DBGPID4</a>	RO	-	-	-	-
1020-1023	0xFF0-0xFFC	<a href="#">DBGCID0</a> - <a href="#">DBGCID3</a>	RO	-	-	-	-

- a. *SLK* has no effect on accesses through the external debug interface. For the memory-mapped interface, when the Software Lock is set, accesses to registers other than [DBGLAR](#) is restricted so that at least writes are ignored and reads have no side-effects. This applies even when the access is UNPREDICTABLE or IMPLEMENTATION DEFINED. [DBGLAR](#) is always WO in the memory-mapped interface, regardless of the state of the Software Lock.
- b. A read returns the value of the register, but any other side-effect of the read is suppressed.
- c. [DBGITR](#) can only be accessed in Debug state. See *Behavior of accesses to the DBGITR* on page C8-2174 for more information.
- d. This condition changes the behavior of accesses to the register. For more information, see the register description.
- e. Access to this register is always UNPREDICTABLE if the implementation does not include the OS Save and Restore mechanism.
- f. In an implementation that includes the OS Save and Restore mechanism, if [DBGOSSRR](#) is not visible in the memory-mapped and external debug interfaces, it is RAZ/WI when the OS Lock is set.
- g. Only visible in the memory-mapped interface. Access is UNPREDICTABLE in the external debug interface.

## C6.6.4 Accesses to reserved and unallocated registers, v7 Debug

For v7 Debug, the following subsections describe the behavior of accesses to reserved registers in the memory-mapped and external debug interfaces, and to unallocated CP14 debug register encodings:

- [Accesses to reserved registers in the memory-mapped interface, v7 Debug](#)
- [Accesses to reserved registers in the external debug interface, v7 Debug on page C6-2136](#)
- [Access to unallocated CP14 debug register encodings, v7 Debug on page C6-2136.](#)

### ————— Note —————

Unimplemented breakpoint and watchpoint registers are reserved registers.

## Accesses to reserved registers in the memory-mapped interface, v7 Debug

When the Debug Software Enable function is disabling software access to the debug registers, any access to a reserved register through the memory-mapped interface returns an error response. This includes accesses to reserved registers in the management registers space, register numbers 832-1023.

When the Debug Software Enable function is not disabling software access to the debug registers:

- Reserved registers in the management registers space, except for reserved registers in the IMPLEMENTATION DEFINED integration registers space, are UNK/SBZP.

- For all other reserved registers, it is UNPREDICTABLE whether a register access returns an error response if any of the following applies:
    - The core power domain is powered down.
    - [DBGPRSR.SPD](#), the Sticky powerdown status bit, is set to 1.
    - The OS Lock is implemented and is set.
    - The Software Lock is set.
- If none of these applies then the reserved register is UNK/SBZP.

### Accesses to reserved registers in the external debug interface, v7 Debug

Reserved registers in the management registers space, register numbers 832-1023, except for reserved registers in the IMPLEMENTATION DEFINED integration registers space, are UNK/SBZP.

For all other reserved registers:

- It is UNPREDICTABLE whether a register access returns an error response if any of the following applies:
  - The core power domain is powered down.
  - [DBGPRSR.SPD](#), the Sticky powerdown status bit, is set to 1.
  - The OS Lock is implemented and is set.
- If none of these applies then the reserved register is UNK/SBZP.

### Access to unallocated CP14 debug register encodings, v7 Debug

In v7 Debug, the behavior of accesses to unallocated CP14 debug register encodings depends on:

- Whether the implementation includes all of the CP14 debug registers, as indicated by the [DBGDIDR.Version](#) field.
- Whether the Debug Software Enable function permits software access to the debug registers, see [Permissions in relation to locks on page C6-2118](#).

This means that accesses to unallocated CP14 debug register encodings, from PL1 or higher, are:

- UNPREDICTABLE if any of the following applies:
  - [DBGDIDR.Version](#) is 0b0100, indicating that only the baseline CP14 registers are implemented.
  - The register encoding has CRn >= 0b1000.
  - The Debug Software Enable function permits access to the debug registers.
- Otherwise, UNDEFINED.

---

#### Note

As stated in [General behavior of system control registers on page B3-1446](#) and [General behavior of system control registers on page B5-1774](#), all MRC and MCR accesses to unallocated CP14 register encodings from User mode are UNDEFINED.

---

## C6.7 Summary of the v7.1 Debug register interfaces

The following sections show how the v7.1 Debug registers can be accessed through the different interfaces, and how the access is affected by the privilege level, locks, and powerdown settings:

- [v7.1 Debug register visibility in the different interfaces](#)
- [v7.1 Debug register access in the CP14 interface on page C6-2139](#)
- [v7.1 Debug register access in the memory-mapped and external debug interfaces on page C6-2141](#)
- [Access to reserved and unallocated registers, v7.1 Debug on page C6-2144.](#)

### C6.7.1 v7.1 Debug register visibility in the different interfaces

Table C6-8 shows the required visibility of the debug registers in a v7.1 Debug implementation, as follows:

- A group of debug registers must be visible in the CP14 interface. The *CP14* column identifies the registers in this group.
- A group of debug registers must be visible in the external debug interface. The *ED* column identifies the registers in this group.
- If the memory-mapped debug interface is implemented, a group of debug registers must be visible in that interface. The *MM* column identifies the registers in this group.

In Table C6-8:

- Yes** Indicates that the register is part of the group.
- Optional** Indicates that, in v7.1 Debug, it is IMPLEMENTATION DEFINED whether the register is implemented. If it is implemented, then unless otherwise indicated by a footnote to the *Optional* entry, it must be part of the group.
- Indicates that the register is not part of the group.

**Table C6-8 v7.1 Debug register visibility**

Register number	Name	Description	Interface		
			CP14	ED	MM
0	<a href="#">DBGDIDR</a>	Debug ID	Yes	Yes	Yes
1	<a href="#">DBGDSCR</a> int	Debug Status and Control	Yes	-	-
5	<a href="#">DBGDTRTX</a> int, WO	Target to Host Data Transfer	Yes	-	-
	<a href="#">DBGDTRRX</a> int, RO	Host to Target Data Transfer	Yes	-	-
6	<a href="#">DBGWFAR</a>	Watchpoint Fault Address	Yes	Yes	Yes
7	<a href="#">DBGVCR</a>	Vector Catch	Yes	Yes	Yes
9	<a href="#">DBGECR</a>	Event Catch	-	Yes	Yes
32	<a href="#">DBGDTRRX</a> ext	Host to Target Data Transfer	Yes	Yes	Yes
33	<a href="#">DBGITR</a> , WO	Instruction Transfer	-	Yes	Yes
	<a href="#">DBGPCSR</a> , RO	Program Counter Sampling	-	OPTIONAL <sup>a</sup>	OPTIONAL <sup>a</sup>
34	<a href="#">DBGDSCR</a> ext	Debug Status and Control	Yes	Yes	Yes
35	<a href="#">DBGDTRTX</a> ext	Target to Host Data Transfer	Yes	Yes	Yes
36	<a href="#">DBGDRCR</a>	Debug Run Control	-	Yes	Yes

Table C6-8 v7.1 Debug register visibility (continued)

Register number	Name	Description	Interface		
			CP14	ED	MM
37	<a href="#">DBGEACR</a>	External Auxiliary Control	-	Yes	Yes
40	<a href="#">DBGPCSR</a>	Program Counter Sampling	-	Optional	Optional
41	<a href="#">DBGCIDSR</a>	Context ID Sampling	-	Optional	Optional
42	<a href="#">DBGVIDSR</a>	Virtualization ID Sampling	-	Optional	Optional
64-79	<a href="#">DBGBVRm</a>	Breakpoint Value	Yes	Yes	Yes
80-95	<a href="#">DBGBCRm</a>	Breakpoint Control	Yes	Yes	Yes
96-111	<a href="#">DBGWVRm</a>	Watchpoint Value	Yes	Yes	Yes
112-127	<a href="#">DBGWCRm</a>	Watchpoint Control	Yes	Yes	Yes
128	<a href="#">DBGDRAR</a>	Debug ROM Address	Yes	-	-
144-159	<a href="#">DBGBXVRm</a>	Breakpoint Extended Value <sup>b</sup>	Yes <sup>b</sup>	Yes <sup>b</sup>	Yes <sup>b</sup>
192	<a href="#">DBGOSLAR</a>	OS Lock Access	Yes	Yes	Yes
193	<a href="#">DBGOSLSR</a>	OS Lock Status	Yes	Yes	Yes
195	<a href="#">DBGOSDLR</a>	OS Double Lock	Yes	-	-
196	<a href="#">DBGPRCR</a>	Powerdown and Reset Control	Yes <sup>c</sup>	Yes	Yes
197	<a href="#">DBGPRSR</a>	Powerdown and Reset Status	-	Yes	Yes
256	<a href="#">DBGDSAR</a>	Debug Self Address Offset	Yes	-	-
512-575	-	IMPLEMENTATION DEFINED	Optional <sup>d</sup>	Optional <sup>d</sup>	Optional <sup>d</sup>
832-895	Various	Processor IDs	-	Yes	Yes
928-959	Various	Integration registers	Optional <sup>d</sup>	Optional <sup>d</sup>	Optional <sup>d</sup>
960	<a href="#">DBGITCTRL</a>	Integration Mode Control	Optional <sup>d</sup>	Optional <sup>d</sup>	Optional <sup>d</sup>
1000	<a href="#">DBGCLAIMSET</a>	Claim Tag Set	Yes	Yes	Yes
1001	<a href="#">DBGCLAIMCLR</a>	Claim Tag Clear	Yes	Yes	Yes
1004	<a href="#">DBGLAR</a>	Lock Access	-	-	Yes
1005	<a href="#">DBGLSR</a>	Lock Status	-	-	Yes
1006	<a href="#">DBGAUTHSTATUS</a>	Authentication Status	Yes	Yes	Yes
1008	DBGDEVID2	Debug Device ID 2	UNK/SBZP	UNK/SBZP	UNK/SBZP
1009	<a href="#">DBGDEVID1</a>	Debug Device ID 1	Yes	Yes	Yes
1010	<a href="#">DBGDEVID</a>	Debug Device ID	Yes	Yes	Yes
1011	<a href="#">DBGDEVTYPE</a>	Device Type	-	Yes	Yes

Table C6-8 v7.1 Debug register visibility (continued)

Register number	Name	Description	Interface		
			CP14	ED	MM
1012-1019	DBGPID0-DBGPID4	Debug Peripheral ID	-	Yes	Yes
1020-1023	DBGCID0-DBGCID3	Debug Component ID	-	Yes	Yes

- a. Implementation of an alias of [DBGPCSR](#) as register 33 is OPTIONAL and deprecated. This means ARM deprecates accessing the [DBGPCSR](#) as register 33, and strongly recommends that the register is accessed only as register 40.
- b. Only in an implementation that includes the Virtualization Extensions.
- c. Only some bits are visible in the CP14 interface. For more information, see the register description.
- d. Visibility and access is IMPLEMENTATION DEFINED.

## C6.7.2 v7.1 Debug register access in the CP14 interface

This section summarizes register access in the CP14 interface for v7.1 Debug. See [The CP14 debug register interface on page C6-2121](#) and [CP14 interface instruction arguments on page C6-2124](#) for more information on the CP14 interface.

In v7.1 Debug, access to debug registers visible in the CP14 interface is affected by:

- Privilege level.
- Debug state.
- The Debug Software Enable function.
- [DBGDSCR.UDCCdis](#), User mode access to DCC disable bit.
- OS Lock.
- OS Double Lock.

In an implementation that includes the Virtualization Extensions, in Non-secure state when executing at PL1 or PL0, an access to a CP14 debug register that is permitted by the access permissions described in this section can generate a Hyp Trap exception. For more information, see [Trapping CP14 accesses to debug registers on page B1-1259](#).

Access is not affected by the Software Lock setting. This only applies to registers in the memory-mapped interface.

[Table C6-9 on page C6-2140](#) shows the default access to the registers visible in the CP14 interface. The default access shows the access when all locks are off, and the access is made when one of the following applies:

- The processor is in Debug state.
- The processor is in Non-debug state, and one of the following applies:
  - The processor does not include the Security Extensions, and the privilege level is PL1.
  - The processor is in Secure state, and the privilege level is PL1.
  - The processor is in Non-secure state, and does not include the Virtualization Extensions, and the privilege level is PL1.
  - The processor is in Non-secure state, and the privilege level is PL2.

[Table C6-9 on page C6-2140](#) also shows how the access is affected by the various locks and settings. These are shown in the table headings as:

**Hyp trap** In an implementation that includes the Virtualization Extensions, a Non-secure access from PL0 or PL1 to a register that is not UNDEFINED and is not UNPREDICTABLE generates a Hyp Trap exception if the [HDCR](#) bit shown in this column is set to 1. For more information, see [Trapping CP14 accesses to debug registers on page B1-1259](#). Accesses from PL2, Hyp mode, are unaffected by [HDCR](#) bit settings.

**DSE** When the Debug Software Enable function is off, and the OS Lock is not set, access to some registers becomes UNDEFINED.

- PL0** When the processor is in Non-debug state and the privilege level is PL0, access to some registers becomes UNDEFINED.
- UDCC** When the processor is in Non-debug state, the privilege level is PL0, and the User mode access to DCC disable bit, [DBGDSCR.UDCCdis](#), is set to 1, then the access to some registers becomes UNDEFINED. Access to the IMPLEMENTATION DEFINED registers in the range 512-575 is IMPLEMENTATION DEFINED.
- OSL** When the OS Lock is set, access to some registers is modified or becomes UNPREDICTABLE.

———— **Note** —————

It is not possible to access CP14 registers in Debug state when the OS Lock is set, since when the OS Lock is set accesses to the DBGITR through the memory-mapped or external debug interfaces return an error, so it is not possible to execute CP14 instructions.

- OSDL** When [DBGPRSR.DLK](#), the OS Double Lock status bit, is set to 1, access to some registers becomes UNPREDICTABLE.

For more information about the behavior of CP14 accesses when in Debug state, see [Behavior of coprocessor and Advanced SIMD instructions in Debug state on page C5-2102](#).

Table C6-9 uses the following abbreviations:

- UND** UNDEFINED  
**UNP** UNPREDICTABLE  
**IMP DEF** IMPLEMENTATION DEFINED.

In addition, in [Table C6-9](#), an entry of - indicates that the control has no effect on the behavior of accesses to that register.

If a register is not shown in [Table C6-9](#) it is not visible in the CP14 interface, and any access to it is treated as an access to an unallocated register encoding, see [Access to reserved and unallocated registers, v7.1 Debug on page C6-2144](#).

**Table C6-9 v7.1 Debug CP14 interface access behavior**

Register number	Register name	Default access	Hyp trap	DSE	PL0	UDCC	OSL	OSDL
0	<a href="#">DBGDIDR</a>	RO <sup>b</sup>	TDA	-	-	UND	-	-
1	<a href="#">DBGDSCR</a> <sub>int</sub>	RO <sup>b</sup>	TDA	-	-	UND	UNP <sup>a</sup>	UNP <sup>a</sup>
5	<a href="#">DBGDTRRX</a> <sub>int</sub>	RO	TDA	-	-	UND	UNP <sup>a</sup>	UNP <sup>a</sup>
	<a href="#">DBGDTRTX</a> <sub>int</sub>	WO	TDA	-	-	UND	UNP <sup>a</sup>	UNP <sup>a</sup>
6	<a href="#">DBGWFAR</a>	RW <sup>b</sup>	TDA	UND	UND	UND	-	UNP
7	<a href="#">DBGVCR</a>	RW <sup>b</sup>	TDA	UND	UND	UND	-	UNP
32	<a href="#">DBGDTRRX</a> <sub>ext</sub>	RW <sup>b</sup>	TDA	UND	UND	UND	RW <sup>c</sup>	UNP
34	<a href="#">DBGDSCR</a> <sub>ext</sub>	RW <sup>b</sup>	TDA	UND	UND	UND	RW <sup>c</sup>	UNP
35	<a href="#">DBGDTRTX</a> <sub>ext</sub>	RW <sup>b</sup>	TDA	UND	UND	UND	RW <sup>c</sup>	UNP
64-79	<a href="#">DBGBVR</a> <sub>m</sub>	RW <sup>b</sup>	TDA	UND	UND	UND	-	UNP
80-95	<a href="#">DBGBCR</a> <sub>m</sub>	RW <sup>b</sup>	TDA	UND	UND	UND	-	UNP
96-111	<a href="#">DBGWVR</a> <sub>m</sub>	RW <sup>b</sup>	TDA	UND	UND	UND	-	UNP



Table C6-9 v7.1 Debug CP14 interface access behavior (continued)

Register number	Register name	Default access	Hyp trap	DSE	PL0	UDCC	OSL	OSDL
112-127	<a href="#">DBGWCRm</a>	RW <sup>b</sup>	TDA	UND	UND	UND	-	UNP
128	<a href="#">DBGDRAR</a>	RO <sup>b</sup>	TDRA	-	-	UND	-	-
144-159	<a href="#">DBGBXVRm</a>	RW <sup>b</sup>	TDA	UND	UND	UND	-	UNP
192	<a href="#">DBGOSLAR</a>	WO <sup>b</sup>	TDOSA	-	UND	UND	-	UNP
193	<a href="#">DBGOSLSR</a>	RO <sup>b</sup>	TDOSA	-	UND	UND	-	UNP
195	<a href="#">DBGOSDLR</a>	RW <sup>b</sup>	TDOSA	-	UND	UND	-	-
196	<a href="#">DBGPRCR<sup>d</sup></a>	RW <sup>b</sup>	TDOSA	UND	UND	UND	-	UNP
256	<a href="#">DBGDSAR</a>	RO <sup>b</sup>	TDRA	-	-	UND	-	-
512-575	IMPLEMENTATION DEFINED	IMP DEF	Various <sup>e</sup>	UND	IMP DEF	IMP DEF	IMP DEF	IMP DEF
928-959	Integration registers	IMP DEF	TDOSA	UND	UND	UND	IMP DEF	IMP DEF
960	<a href="#">DBGITCTRL</a>	IMP DEF	TDOSA	UND	UND	UND	IMP DEF	IMP DEF
1000	<a href="#">DBGCLAIMSET</a>	RW <sup>b</sup>	TDA	UND	UND	UND	-	UNP
1001	<a href="#">DBGCLAIMCLR</a>	RW <sup>b</sup>	TDA	UND	UND	UND	-	UNP
1006	<a href="#">DBGAUTHSTATUS</a>	RO <sup>b</sup>	TDA	UND	UND	UND	-	UNP
1008	DBGDEVID2	RO <sup>b</sup>	TDA	UND	UND	UND	-	UNP
1009	<a href="#">DBGDEVID1</a>	RO <sup>b</sup>	TDA	UND	UND	UND	-	UNP
1010	<a href="#">DBGDEVID</a>	RO <sup>b</sup>	TDA	UND	UND	UND	-	UNP

- a. Access is UNDEFINED if in Non-debug state, executing at PL0, and [DBGDSCR.UDCCdis](#) is set to 1.
- b. ARM deprecates the use of this register from privilege level PL0 in Debug state.
- c. The behavior on reads and writes is changed. For more information, see the register description.
- d. Only some bits are visible in the CP14 interface. See [DBGPRCR, Device Powerdown and Reset Control Register](#) on page C11-2278 for details.
- e. In an implementation that includes the Virtualization Extensions, ARM strongly recommends that any IMPLEMENTATION DEFINED register is implemented with an [HDCR](#). {TDA, TDRA, TDOSA}, that depends on the function of register, so that Non-secure PL1 or PL0 accesses to the register can be trapped to Hyp mode.

### C6.7.3 v7.1 Debug register access in the memory-mapped and external debug interfaces

This section summarizes register access in the memory-mapped interface and external debug interface for v7.1 Debug. See [The memory-mapped and recommended external debug interfaces](#) on page C6-2126 for more information on the interfaces.

In v7.1 Debug, access to the debug registers visible in the memory-mapped and external debug interfaces is affected by:

- The core and debug power domain settings.  
If the debug power domain is powered down, any access to a register through either register interface produces an error.

If the core power domain is powered down, access to some registers through either interface produces an error, as shown in [Table C6-10 on page C6-2143](#).

- The Debug Software Enable function. If this function is off, any access through the memory-mapped interface produces an error. Access through the external debug interface is unaffected.
- Software Lock. If all other controls permit access to the registers, and the Software Lock is set, access to all registers through the memory-mapped interface is restricted as follows:
  - Reads return the value of the register, but with no side-effects.
  - Writes are ignored, and have no side-effects.

For more information about the behavior of the accesses, see [Table C6-10 on page C6-2143](#).

Access to the `DBGLAR`, which sets and releases the Software Lock, is not affected.

Access through the external debug interface is not affected by the Software Lock.

- The OS Lock. If the OS Lock is set, access to some registers through the external debug interface produces an error, as shown in [Table C6-10 on page C6-2143](#).  
Access through the memory-mapped interface is affected for the `DBGDTRRExt`, `DBGDSCRExt`, and `DBGDTRTXExt`, as [Table C6-10 on page C6-2143](#) shows.
- The OS Double Lock. If `DBGPRSR.DLK`, the OS Double Lock status bit, is set to 1, access to some registers through either interface produces an error, as [Table C6-10 on page C6-2143](#) shows.

For the accesses that produce an error response, the error response is IMPLEMENTATION DEFINED:

- For the memory-mapped interface, the error is IMPLEMENTATION DEFINED, but the access must either be ignored or signaled to the processor as an external abort.
- For the external debug interface, the error must be signaled to the debugger by the Debug Access Port. With an ADIV5 implementation, this means the error sets a sticky flag in the DAP.

[Table C6-10 on page C6-2143](#) shows the default access to the registers visible in the memory-mapped and external debug interfaces. The access in the memory-mapped and external debug interfaces is affected by various locks and settings and combinations of these. These are shown in the table headings in [Table C6-10 on page C6-2143](#) as:

#### CPD or OSDL

When core power is off, or `DBGPRSR.DLK`, the OS Double Lock status bit, is set to 1, then an access to some registers, through either interface, produces an error.

**OSL, ED** When the OS Lock is set, the behavior of accesses to some registers through the external debug interface are affected.

**OSL, MM** When the OS Lock is set, the behavior of accesses to some registers through the memory-mapped interface are affected.

**SLK** When the Software Lock is set, if all other controls permit accesses to the registers, accesses through the memory-mapped interface are read-only and have no side-effects. An access that is UNPREDICTABLE is guaranteed not to perform a register write.

[Table C6-10 on page C6-2143](#) uses the following abbreviations:

<b>Err</b>	Error.
<b>UNP</b>	UNPREDICTABLE
<b>IMP DEF</b>	IMPLEMENTATION DEFINED

In addition, in [Table C6-10 on page C6-2143](#), an entry of - indicates that the control has no effect on the behavior of accesses to that register.

If a register is not shown in Table C6-10 it is not visible in the memory-mapped interface or the external debug interface, and any access is treated as an access to a reserved register. *Access to reserved and unallocated registers, v7.1 Debug on page C6-2144* describes the behavior of accesses to reserved register addresses.

**Table C6-10 v7.1 Debug memory-mapped and external debug interfaces access behavior**

Register number	Offset	Register name	Default access	CPD or OSDL	OSL, ED	OSL, MM	SLK <sup>a</sup>
0	0x000	DBGDIDR	RO	-	-	-	-
6	0x018	DBGWFAR	RW	Err	Err	-	RO
7	0x01C	DBGVCR	RW	Err	Err	-	RO
9	0x024	DBGECR	RW	-	-	-	RO
32	0x080	DBGDTRRX <sub>ext</sub>	RW	Err	Err	RW <sup>b</sup>	RO <sup>a</sup>
33	0x084	DBGITR	WO <sup>c</sup>	Err	Err	UNP <sup>c</sup>	WI
		DBGPCSR <sup>d</sup>	RO	Err	Err	-	RO <sup>a</sup>
34	0x088	DBGDSCR <sub>ext</sub>	RW	Err	Err	RW <sup>b</sup>	RO <sup>a</sup>
35	0x08C	DBGDTRTX <sub>ext</sub>	RW	Err	Err	RW <sup>b</sup>	RO <sup>a</sup>
36	0x094	DBGDRCR	WO	WO <sup>b</sup>	-	-	WI
37	0x094	DBGEACR	RW	IMP DEF	IMP DEF	-	RO
40	0x0A0	DBGPCSR	RO	Err	Err	-	RO <sup>a</sup>
41	0x0A4	DBGCIDSR	RO	Err	Err	-	-
42	0x0A8	DBGVIDSR	RO	Err	Err	-	-
64-79	0x100-0x13C	DBGBVR <sub>m</sub>	RW	Err	Err	-	RO
80-95	0x140-0x17C	DBGBCR <sub>m</sub>	RW	Err	Err	-	RO
96-111	0x180-0x1BC	DBGWVR <sub>m</sub>	RW	Err	Err	-	RO
112-127	0x1C0-0x1FC	DBGWCR <sub>m</sub>	RW	Err	Err	-	RO
144-159	0x240-0x27C	DBGXVR <sub>m</sub>	RW	Err	Err	-	RO
192	0x300	DBGOSLAR	WO	Err	-	-	WI
193	0x304	DBGOSLSR	RO	RO <sup>b</sup>	-	-	-
196	0x310	DBGPRCR	RW	RW <sup>b</sup>	RW <sup>b</sup>	-	RO
197	0x314	DBGPRSR	RO	RO <sup>b</sup>	-	-	RO <sup>a</sup>
512-575	0x800-0x8FC	IMPLEMENTATION DEFINED	IMP DEF	IMP DEF	IMP DEF	IMP DEF	IMP DEF <sup>a</sup>
832-895	0xD00-0xDFC	Processor IDs	RO	-	-	-	-
928-959	0xE80-0xEFC	Integration registers	IMP DEF	IMP DEF	IMP DEF	IMP DEF	IMP DEF <sup>a</sup>
960	0xF00	DBGITCTRL	IMP DEF	IMP DEF	IMP DEF	IMP DEF	IMP DEF <sup>a</sup>
1000	0xFA0	DBGCLAIMSET	RW	Err	Err	-	RO

**Table C6-10 v7.1 Debug memory-mapped and external debug interfaces access behavior (continued)**

Register number	Offset	Register name	Default access	CPD or OSDL	OSL, ED	OSL, MM	SLK <sup>a</sup>
1001	0xFA4	<a href="#">DBGCLAIMCLR</a>	RW	Err	Err	-	RO
1004	0xFB0	<a href="#">DBGLAR</a> <sup>e</sup>	WO	-	UNP <sup>e</sup>	_ <sup>e</sup>	_ <sup>e</sup>
1005	0xFB4	<a href="#">DBGLSR</a> <sup>e</sup>	RO	-	UNP <sup>e</sup>	_ <sup>e</sup>	-
1006	0xFB8	<a href="#">DBGAUTHSTATUS</a>	RO	-	-	-	-
1008	0xFC0	<a href="#">DBGDEVID2</a>	RO	-	-	-	-
1009	0xFC4	<a href="#">DBGDEVID1</a>	RO	-	-	-	-
1010	0xFC8	<a href="#">DBGDEVID</a>	RO	-	-	-	-
1011	0xFCC	<a href="#">DBGDEVTYPE</a>	RO	-	-	-	-
1012-1019	0xFD0-0xFEC	<a href="#">DBGPID0 - DBGPID4</a>	RO	-	-	-	-
1020-1023	0xFF0-0xFFC	<a href="#">DBGCID0 - DBGCID3</a>	RO	-	-	-	-

- SLK* has no effect on accesses through the external debug interface. For the memory-mapped interface, when the Software Lock is set, accesses to registers other than [DBGLAR](#) is restricted so that at least writes are ignored and reads have no side-effects. This applies even when the access is UNPREDICTABLE or IMPLEMENTATION DEFINED. [DBGLAR](#) is always WO in the memory-mapped interface, regardless of the state of the Software Lock.
- This condition changes the behavior of accesses to the register. For more information see the register description.
- Only accessible when in Debug state. See [Behavior of accesses to the DBGITR on page C8-2174](#) for more information.
- When the [DBGPCSR](#) is visible as register 40, ARM deprecates accessing the [DBGPCSR](#) as register 33, and strongly recommends that the register is accessed only as register 40.
- Only visible in the memory-mapped interface. Accesses are UNPREDICTABLE in the external debug interface.

#### C6.7.4 Access to reserved and unallocated registers, v7.1 Debug

For v7.1 Debug, the following subsections describe the behavior of accesses to reserved registers in the memory-mapped and external debug interfaces, and to unallocated CP14 debug register encodings:

- [Accesses to reserved registers in the memory-mapped interface, v7.1 Debug](#)
- [Accesses to reserved registers in the external debug interface, v7.1 Debug on page C6-2145](#)
- [Access to unallocated CP14 debug register encodings, v7.1 Debug on page C6-2145.](#)

———— **Note** —————

Unimplemented breakpoint and watchpoint registers are reserved registers.

#### Accesses to reserved registers in the memory-mapped interface, v7.1 Debug

When the Debug Software Enable function is disabling software access to the debug registers, any access to a reserved register through the memory-mapped interface returns an error response. This includes accesses to reserved registers in the management registers space, register numbers 832-1023.

When the Debug Software Enable function is not disabling software access to the debug registers:

- Reserved registers in the management registers space, except for reserved registers in the IMPLEMENTATION DEFINED integration registers space, are UNK/SBZP.

- For all other reserved registers, it is UNPREDICTABLE whether a register access returns an error response if any of the following applies:
    - the core power domain is powered down
    - [DBGPRSR.DLK](#), the OS Double Lock status bit, is set to 1
    - the Software Lock is set.
- If none of these applies then the reserved register is UNK/SBZP.

### Accesses to reserved registers in the external debug interface, v7.1 Debug

Reserved registers in the management registers space, register numbers 832-1023, except for reserved registers in the IMPLEMENTATION DEFINED integration registers space, are UNK/SBZP.

For all other reserved registers:

- if any of the following applies, it is UNPREDICTABLE whether a register access returns an error response:
  - the core power domain is powered down
  - [DBGPRSR.DLK](#), the OS Double Lock status bit, is set to 1.
- if none of these applies then the reserved register is UNK/SBZP.

### Access to unallocated CP14 debug register encodings, v7.1 Debug

In v7.1 Debug, accesses to unallocated CP14 debug register encodings are UNPREDICTABLE at PL1 or higher.

———— **Note** —————

As stated in [General behavior of system control registers on page B3-1446](#) and [General behavior of system control registers on page B5-1774](#), all MRC and MCR accesses to unallocated CP14 register encodings from User mode are UNDEFINED.

---



# Chapter C7

## Debug Reset and Powerdown Support

This chapter describes the reset and powerdown support in the Debug architecture. It contains the following sections:

- *Debug guidelines for systems with energy management capability* on page C7-2148
- *Power domains and debug* on page C7-2149
- *The OS Save and Restore mechanism* on page C7-2152
- *Reset and debug* on page C7-2160.

## C7.1 Debug guidelines for systems with energy management capability

A processor implementation can include energy management capabilities. This section describes how to debug software running on such an implementation.

The Debug architecture only defines how to debug software running on a system where:

- only the operating system takes energy-saving measures
- the operating system takes energy-saving measures only when the processor is in an idle state.

### ———— Note ————

In particular, the Debug architecture does not specify how to debug software on a system that dynamically adjusts the energy consumption to the load. How to debug software on such a system is IMPLEMENTATION DEFINED.

The measures that the OS can take to save energy in an idle state can be split in two groups:

**Standby** The OS takes some measures, including using IMPLEMENTATION DEFINED measures, to reduce energy consumption. The processor preserves the processor state, including the debug logic state. Changing from standby to normal operation does not involve a reset of the processor.

For more information about architecturally-defined standby states, see [Wait For Event and Send Event on page B1-1199](#) and [Wait For Interrupt on page B1-1202](#).

**Powerdown** The OS takes some measures to reduce energy consumption. These measures mean the processor cannot preserve the processor state, and therefore the measures must include the OS saving any processor state it requires to be preserved over the powerdown. Changing from powerdown to normal operation must include:

- a reset of the processor, after the power level has been restored
- the OS restoring the saved processor state.

Standby is the least invasive OS energy saving state. Standby implies only that the processor is unavailable, and does not clear any debug settings. For standby, the Debug architecture requires only the following:

- If the processor is in standby, when invasive debug is enabled, if a permitted asynchronous debug event occurs the processor must exit standby to handle the debug event. If the processor executed a WFE or WFI instruction to enter standby then it retires that instruction.
- If the processor is in standby and the external debug or memory-mapped interface is accessed, the processor must respond to that access. ARM recommends that, if the processor executed a WFI or WFE instruction to enter standby, then it does not retire that instruction.

The Debug architecture includes features that can aid software debugging in a system that dynamically powers down the processor. The following sections describe the use of these features.



## C7.2 Power domains and debug

This section discusses how the debug registers can be split between different power domains to implement support for external debug over powerdown and re-powering of the processor.

---

### Note

- External debug over powerdown refers only to debug by an external debugger. This requires architectural support to keep the *Debug Communications Channel* (DCC) and other interfaces to the external debugger working over a powerdown.
  - Self-hosted debug over powerdown refers only to debug by a self-hosted debug tool. This requires keeping the debug resources required by the self-hosted debug tool alive over powerdown, and does not require any specific support from the Debug architecture.
- 

In v7 Debug, it is IMPLEMENTATION DEFINED whether a processor supports external debug over powerdown:

- external debug over powerdown requires the processor to implement the features summarized in this section
- when an implementation includes the features required for external debug over powerdown, it is IMPLEMENTATION DEFINED whether a system that includes that processor supports external debug over powerdown
- usually, a system that does not support external debug over powerdown implements a single power domain.

---

### Note

A processor with a single power domain cannot support external debug over powerdown.

---

In v7.1 Debug, the features required for external debug over powerdown are required. The features required for external debug over powerdown are different from those required for v7 Debug, and are described in more detail later in this chapter. However, it is IMPLEMENTATION DEFINED whether a system that includes the processor supports external debug over powerdown.

The number of power domains supported by a processor is IMPLEMENTATION DEFINED. However, ARM recommends that at least two are implemented to provide support for external debug over powerdown. The two power domains required for this are:

- a *debug power domain*
- a *core power domain*.

The debug power domain contains the external debug interface control logic and a subset of the debug resources. This subset is determined by physical placement constraints and other considerations that are explained in this chapter. [Figure C7-1 on page C7-2151](#) shows an example of such a system. For example, this arrangement is useful for debugging a system where several processors connect to the same debug bus and where one or more of the processors can powerdown at any time. It has two advantages:

- The debug bus remains available if the core power domain powers down:
  - if the debugger tries to access the processor with the core power domain powered down, the external debug interface can return a slave-generated error response, instead of this access locking the system
  - if the debugger tries to access another processor, the access proceeds normally.

The debug bus might be, for example, an AMBA *Advanced Peripheral Bus* (APB3) or internal debug bus.

- Some debug registers are unaffected by powerdown. This means that a debugger can, for example, identify the processor while the core power domain is powered down.

To provide full support for external debug over powerdown and re-powering of the processor, and to rationalize the split between the core and debug power domains in the register map, the following registers must be in the debug power domain:

- *Event Catch Register*, [DBGECR](#).
- *Debug Run Control Register*, [DBGDRCR](#).
- *OS Lock Status Register*, [DBGOSLSR](#).  
In v7 Debug, the OS Lock Status is in the debug power domain.  
In v7.1 Debug, although [DBGOSLSR](#) is in the debug power domain, the OS Lock Status is in the core power domain. This means [DBGOSLSR.OSLK](#) is:
  - UNKNOWN when the core power domain is powered down
  - reset to 1 by a core powerup reset.
- *OS Save and Restore Register*, [DBGOSRRR](#), in v7 Debug only,
- *Device Powerdown and Reset Control Register*, [DBGPRCR](#),  
In v7.1 Debug, [DBGPRCR.CORENPDRQ](#), the Core no powerdown request bit, is implemented in the core power domain.
- *Claim Tag Set Register*, [DBGCLAIMSET](#), in v7 Debug only,
- *Claim Tag Clear Register*, [DBGCLAIMCLR](#), in v7 Debug only.
- *Lock Access Register*, [DBGLAR](#).
- *Lock Status Register*, [DBGLSR](#).
- *Authentication Status Register*, [DBGAUTHSTATUS](#).

The following read-only registers, whose values are fixed, or whose values are fixed when the core power domain is powered down, can be implemented in either or both power domains:

- *Debug ID Register*, [DBGDIDR](#).
- The registers described in [Processor identification registers on page C11-2203](#).
- *Device Powerdown and Reset Status Register*, [DBGPRSR](#).
- *Debug Device ID register*, [DBGDEVID](#).
- *Debug Device ID register 1*, [DBGDEVID1](#).
- *Device Type Register*, [DBGDEVTYPE](#).
- Peripheral ID and Component ID registers. See [Other Debug management registers on page C11-2205](#).

For all other registers, including any IMPLEMENTATION DEFINED registers, it is IMPLEMENTATION DEFINED whether the register is implemented in the core or the debug power domain.

[Figure C7-1 on page C7-2151](#) shows the recommended power domain split. There are small differences in the recommended power domain split between v7 Debug and v7.1 Debug which are described in detail later in this chapter.

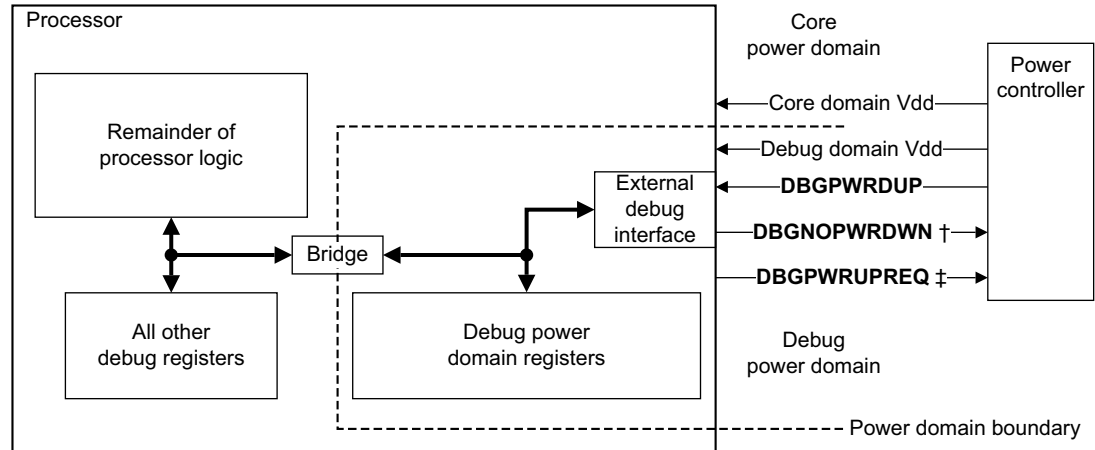

† In v7.1 **DBGNOPWRDWN** comes from the core power domain

‡ In v7.1 Debug only

**Figure C7-1 Recommended power domain split between core and debug power domains**

The signals **DBGPWRUPREQ**, **DBGNOPWRDWN**, and **DBGPWRDUP** shown in Figure C7-1 provide an interface between the power controller and the processor debug logic that is in the debug power domain. They are part of the recommended interface, see [Appendix A Recommended External Debug Interface](#). With this interface:

- the external debugger can request the power controller to emulate powerdown, simplifying the requirements on software by sacrificing entirely realistic behavior
- the external debugger can request the power controller to powerup the core power domain
- the external debug interface knows when the core power domain is powered down, and can communicate this information to the external debugger.

[DBGNOPWRDWN](#) on page AppxA-2346 and [DBGPWRDUP](#) on page AppxA-2347 describe these signals.

Debug behavior over powerdown depends on the debug version, as follows:

**v7 Debug** If the core power domain is not being powered down at the same time as the debug power domain then invasive debug must be disabled before power is removed from the debug power domain. The behavior of the debug logic, and in particular the generation of debug events, is UNPREDICTABLE if invasive debug is enabled when the debug power domain is not powered. Disabling invasive debug ensures that debug events are ignored by the processor. For more information, see [Chapter C2 Invasive Debug Authentication](#).

Reads and writes of debug registers through all interfaces when the debug power domain is powered down are UNPREDICTABLE.

**v7.1 Debug** Powering down the debug power domain does not affect invasive debug enable.

Reads and writes of debug registers through the memory-mapped and external debug interfaces when the debug power domain is powered down return an error. Reads and writes through the CP14 interface are unaffected, so the use of Monitor debug-mode is unaffected.

The performance monitors must be implemented in the core power domain, and must continue to operate when the debug power domain is powered down, see [Chapter C12 The Performance Monitors Extension](#).

Unless otherwise indicated, descriptions in the rest of this part of this manual assume that two power domains are implemented as described in this section, and that therefore the implementation supports external debug over powerdown. However, the descriptions identify features that are not required for an implementation with a single power domain, a *SinglePower* implementation, and indicate the differences in behavior of such a system. A *SinglePower* implementation cannot support external debug over powerdown.

## C7.3 The OS Save and Restore mechanism

The requirements for an implementation that supports external debug over powerdown are:

- The operating system must be able to save and restore the debug logic state over a powerdown. The OS Save and Restore mechanism meets this requirement.
- A debugger must be able to detect that a processor has powered down. For more information, see [Permissions in relation to powerdown on page C6-2119](#).

The OS Save and Restore mechanism enables an operating system to save the debug registers before powerdown and restore them when power is restored.

In v7 Debug:

- If an implementation supports external debug over powerdown, then it must implement the OS Save and Restore mechanism.
- On a SinglePower implementation, and on any other implementation that does not support external debug over powerdown, it is IMPLEMENTATION DEFINED whether the OS Save and Restore mechanism is implemented.
- If an implementation does not support the OS Save and Restore mechanism:
  - it must implement [DBGOSLSR.OSLM](#) as RAZ
  - accesses to the other OS Save and Restore mechanism registers are UNPREDICTABLE.

In v7.1 Debug, all mechanisms required for external debug over powerdown are required by the architecture.

The following sections describe the OS Save and Restore mechanism:

- [The debug logic state to preserve over a powerdown](#)
- [v7 Debug OS Save and Restore on page C7-2154](#)
- [v7.1 Debug OS Save and Restore on page C7-2157](#).

[Appendix D Example OS Save and Restore Sequences for External Debug Over Powerdown](#) gives software examples of the OS Save and Restore processes, for v7 Debug and v7.1 Debug.

### C7.3.1 The debug logic state to preserve over a powerdown

For debug over powerdown, software must preserve the following state:

- debug registers in the core power domain that are writable.
- certain bits in the [DBGDSCR](#).

[Table C7-1 on page C7-2153](#) shows the different requirements for self-hosted debug over powerdown and external debug over powerdown:

- In v7 Debug, the requirements for external debug over powerdown apply to the implementation of the OS Save and Restore mechanism.
- In v7.1 Debug, the requirements for external debug over powerdown apply to the software making use of the OS Save and Restore mechanism.
- The self-hosted column lists registers that software must preserve over powerdown so that it can support self-hosted debug over powerdown. This does not require use of the OS Save and Restore mechanism.

The software does not have to preserve any debug logic state that is not lost when the core power domain is powered down. That is, it does not have to preserve any debug logic state that is in the debug power domain, see [Power domains and debug on page C7-2149](#).

**Table C7-1 Register state to save, for debug over powerdown**

Register	Field <sup>a</sup>	Description	Self-hosted	External	Notes	
DBGDSCR	RXfull	Debug Status and Control	No	Yes	See <i>DCC registers</i> on page C7-2154	
	TXfull		No	Yes		
	RXfull_1		No	Yes		
	TXfull_1		No	Yes		
	ExtDCCmode		No	Yes		-
	MDBGen		Yes	Yes		
	HDBGen		No	Yes		
	ITRen		No	Yes		
	UDCCdis		Yes	Yes		
	INTdis		No	Yes		
	DBGack		No	Yes		
	MOE	Yes	Yes			
DBGWFAR		Watchpoint Fault Address	Yes	Yes	-	
DBGBCRs		Breakpoint Control	Yes	Yes	-	
DBGBVRs		Breakpoint Value	Yes	Yes	-	
DBGBXVRs		Breakpoint Extended Value	Yes	Yes	Virtualization Extensions only	
DBGWVRs		Watchpoint Value	Yes	Yes	-	
DBGWCRs		Watchpoint Control	Yes	Yes	-	
DBGVCR		Vector Catch	Yes	Yes	-	
DBGDSCCR		Debug State Cache Control	No	Yes	In v7 Debug only	
DBGDSMCR		Debug State MMU Control	No	Yes	In v7 Debug only	
DBGCLAIMSET		Claim Tag Set	No	Yes	See <i>Claim Tag registers</i> on page C7-2154	
DBGCLAIMCLR		Claim Tag Clear	No	Yes		
DBGDTRTX		Target to Host Data Transfer	No	Yes	See <i>DCC registers</i> on page C7-2154	
DBGDTRRX		Host to Target Data Transfer	No	Yes		

a. **DBGDSCR** only. For all other registers, the same requirement applies to the entire register.

The restore sequence always overwrites the debug registers with the values that were saved. In particular, the values of the **DBGDTRTX** and **DBGDTRRX** registers, and of the DCC status bits, are set to the saved values when the restore sequence completes.

If there are valid values in the debug registers immediately before the restore sequence then those values are lost.

## Claim Tag registers

In v7 Debug, these registers are in the debug power domain so their values do not have to be preserved.

In v7.1 Debug, these registers are in the core power domain so their values must be preserved. Use [DBGCLAIMCLR](#) to read the values in the save sequence, and [DBGCLAIMSET](#) to write the values in the restore sequence.

## DCC registers

For external debug over powerdown, software must preserve the status of the *Debug Communications Channel* (DCC). This means it must preserve:

- The data transfer registers [DBGDTRTX](#) and [DBGDTRRX](#), subject to the values of [DBGDSCR.TXfull](#) and [DBGDSCR.RXfull](#) when the save sequence is performed:
  - if [DBGDSCR.TXfull](#) is set to 1 then the value of [DBGDTRTX](#) must be saved and restored
  - if [DBGDSCR.RXfull](#) is set to 1 then the value of [DBGDTRRX](#) must be saved and restored.If either of these bits is not set to 1 when the OS Save sequence is performed then the value of the corresponding register is UNKNOWN after the OS Restore sequence.
- The DCC status bits, [DBGDSCR.{TXfull, TXfull\\_1, RXfull, RXfull\\_1}](#).

### C7.3.2 v7 Debug OS Save and Restore

In v7 Debug the following registers provide the OS Save and Restore mechanism:

- the *OS Save and Restore Register*, [DBGOSSRR](#), that is accessed to save or restore the contents of the debug registers
- the *OS Lock Access Register*, [DBGOSLAR](#), sets the OS Lock to restrict access to debug registers before starting an OS Save sequence, and releases the OS Lock after an OS Restore sequence
- the *OS Lock Status Register*, [DBGOSLSR](#), shows the status of the OS Lock
- the *Event Catch Register*, [DBGECR](#), generates a debug event when the OS Lock is cleared.

Software can read the [DBGOSLSR](#) to detect whether the v7 Debug OS Save and Restore mechanism is implemented. If it is not implemented the read of the [DBGOSLSR](#) returns a value of 0 for [DBGOSLSR.OSLM\[0\]](#).

The following subsections describe the v7 Debug OS Save and Restore mechanism:

- [v7 Debug OS Save sequence](#)
- [v7 Debug OS Restore sequence on page C7-2155](#)
- [v7 Debug behavior when the OS Lock is set on page C7-2155](#)
- [v7 Debug behavior when the OS Lock is cleared on page C7-2156](#)
- [Behavior of the DBG OSSRR on page C7-2156](#)
- [Removing power from a v7 Debug implementation on page C7-2157.](#)

## v7 Debug OS Save sequence

To preserve the debug logic state over a powerdown, this state must be saved to non-volatile storage. This means the OS Save sequence must:

1. Set the OS Lock by writing the key value, 0xC5ACCE55, to the [DBGOSLAR](#). This also initializes the [DBGOSSRR](#).
2. If using the CP14 interface, execute an ISB instruction.
3. Perform an initial read of [DBGOSSRR](#). This returns the number of reads of the [DBGOSSRR](#) that are required to save the entire debug logic state.

Record this number in the non-volatile storage.

4. Perform additional reads of [DBGOSSRR](#), as indicated in step 3, and record each value, in order, in the non-volatile storage.
5. Leave the OS Lock set, to prevent any changes to the debug registers.

### v7 Debug OS Restore sequence

After a powerdown, to restore the debug logic state from the non-volatile storage, the OS Restore sequence must:

1. Set the OS Lock by writing the key value, `0xC5ACCE55`, to the [DBGOSLAR](#). This also initializes the [DBGOSSRR](#).
2. If using the CP14 interface, execute an ISB instruction.
3. Read [DBGPRSR](#), to clear the Sticky Powerdown status bit.
4. If using the CP14 interface, execute an ISB instruction.
5. Perform an initial read of [DBGOSSRR](#) and discard the value returned.
6. From the non-volatile storage, retrieve the number that was recorded in step 3 of the OS Save sequence. This value indicates the number of writes of [DBGOSSRR](#) that are required to restore the entire debug logic state.
7. Perform a word read from the non-volatile storage and then write the value to [DBGOSSRR](#). Repeat this step until the number of writes to [DBGOSSRR](#) matches the value retrieved at step 6. At this point, all of the debug logic state saved to non-volatile memory by the OS save sequence has been restored.
8. If using the CP14 interface, execute an ISB instruction.
9. Clear the OS Lock by writing any non-key value to the [DBGOSLAR](#).
10. If using the memory-mapped interface, execute a DSB instruction.
11. Execute a [Context synchronization operation](#) before using the debug registers.

#### ———— Note —————

The number of accesses required, and the order and interpretation of the data are IMPLEMENTATION DEFINED, but the number of accesses and the order of the data must be the same for the OS Save and OS Restore sequences. Software must ensure that the OS Restore mechanism writes values back to the [DBGOSSRR](#) in the same order that it read them in the OS Save mechanism. That is, the first item read in the OS Save mechanism must be the first item written in the OS Restore mechanism.

### v7 Debug behavior when the OS Lock is set

The main purpose of the OS Lock is to prevent updates to debug registers during an OS Save or OS Restore operation. In a v7 Debug implementation, the state of the OS Lock is IMPLEMENTATION DEFINED on a debug logic reset.

When the OS Lock is set:

- Access to debug registers through all interfaces is restricted to prevent modification of the registers that are being saved or restored. For more information, see [v7 Debug register access in the CP14 interface on page C6-2130](#) and [v7 Debug register access in the memory-mapped and external debug interfaces on page C6-2132](#).
- [DBGOSSRR](#) can be used to read and write registers without side-effects, so the current debug state can be saved or restored, including restoring fields in the [DBGDSCR](#) that are normally read-only.

- The effect of the OS Lock on Software debug events is IMPLEMENTATION DEFINED, but an implementation must either:
  - For any Software debug event, depending on the currently-selected debug-mode, either generate a debug exception or enter Debug state.
  - Regardless of the currently-selected debug-mode, ignore any Software debug event other than a BKPT instruction debug event. This is because the generation of the debug event uses the debug registers that are being restored. However, on a BKPT instruction debug event the implementation must generate a debug exception.

The OS Lock has no effect on Halting debug events.

### v7 Debug behavior when the OS Lock is cleared

When the OS Lock is cleared, an OS Unlock catch debug event is generated if `DBGECR.OUCE`, the OS Unlock catch enable bit, is set to 1. See *Halting debug events* on page C3-2073.

The debug logic state of the processor is unchanged if the OS Lock is cleared during or following an OS Save sequence. The sequence is restarted the next time the OS Lock is set.

### Behavior of the DBGOSSRR

The `DBGOSSRR` works in conjunction with an internal sequence counter, so that a series of reads or writes of this register saves or restores the complete debug logic state of the processor. The processor loses this state when it is powered down. Writing the key, `0xC5ACCE55`, to the `DBGOSLAR` resets the internal sequence counter to the start of the sequence.

The first access to the `DBGOSSRR` following the reset of the internal sequence counter must be a read:

- when performing an OS Save sequence this read returns the number of reads from the `DBGOSSRR` that are required to save the entire debug logic state
- when performing an OS Restore sequence the value returned by this read is UNKNOWN.

The result of issuing a write to the `DBGOSSRR` following a reset of the internal sequence counter is UNPREDICTABLE.

#### ————— Note —————

An implementation that includes the OS Save and Restore mechanism might not provide access to the `DBGOSSRR` through the external debug interface. In this case:

- the `DBGOSLSR`, `DBGOSLAR`, and `DBGECR` are accessible through the external debug interface
- through the external debug interface, the `DBGOSSRR` is RAZ/WI
- because the first read of the `DBGOSSRR` through the external debug interface returns zero, this correctly indicates that the debug registers cannot be saved or restored through the external debug interface.

The subsequent accesses to the `DBGOSSRR` must be either all reads or all writes. Behavior is UNPREDICTABLE if any of the following are true:

- reads and writes are mixed
- more accesses are performed than the number of registers to be saved or restored, as returned by the first read in the OS Save sequence
- the subsequent accesses are writes, but the OS Lock is cleared with fewer writes performed than the number of registers to be restored.

When the core power domain is powered down or when the OS Lock is not set, reads of `DBGOSSRR` return an UNKNOWN value and writes are UNPREDICTABLE.



## Removing power from a v7 Debug implementation

ARM strongly recommends that v7 Debug implementations provide an IMPLEMENTATION DEFINED mechanism that can be used, before removing power from the debug power domain, to both:

- force the debug interfaces into a quiescent state
- cause the debug logic to ignore Halting debug events.

---

### Note

- The v7.1 Debug OS Double Lock mechanism, described in [Behavior when the OS Double Lock is set on page C7-2159](#), might be used as a model for this mechanism,
  - This mechanism might be implemented using IMPLEMENTATION DEFINED registers, or using appropriate handshake signals.
- 

### C7.3.3 v7.1 Debug OS Save and Restore

In v7.1 Debug the following registers provide the OS Save and Restore mechanism:

- The *OS Lock Access Register*, [DBGOSLAR](#), sets the OS Lock to restrict access to debug registers before starting an OS Save sequence, and releases the OS Lock after an OS Restore sequence.
- The *OS Lock Status Register*, [DBGOSLSR](#), shows the status of the OS Lock.
- The *Event Catch Register*, [DBGECR](#), generates a debug event when the OS Lock is cleared.
- The *OS Double Lock Register*, [DBGOSDLR](#), locks out an external debugger entirely. Only used immediately before a powerdown sequence.

Software can read the [DBGOSLSR](#) to detect whether the v7.1 Debug OS Save and Restore mechanism is implemented. If it is implemented the read of the [DBGOSLSR](#) returns a value of 0b10 for [DBGOSLSR.OSLM](#).

The following subsections describe the v7.1 Debug OS Save and Restore mechanism:

- [v7.1 Debug OS Save sequence](#)
- [v7.1 Debug OS Restore sequence on page C7-2158](#)
- [v7.1 Debug behavior when the OS Lock is set on page C7-2158](#)
- [v7.1 Debug behavior when the OS Lock is cleared on page C7-2158](#)
- [Behavior when the OS Double Lock is set on page C7-2159](#).

#### v7.1 Debug OS Save sequence

To preserve the debug logic state over a powerdown, this state must be saved to non-volatile storage. This means the OS Save sequence must:

1. Set the OS Lock by writing the key value, 0xC5ACCE55, to the [DBGOSLAR](#).
2. Execute an ISB instruction.
3. Walk through the registers listed in [The debug logic state to preserve over a powerdown on page C7-2152](#), and save the values to the non-volatile storage.
4. Leave the OS Lock set, to prevent any changes to the debug registers.

Before removing power from the core power domain, software must:

1. Set the OS Double Lock, by writing 1 to [DBGOSDLR.DLK](#).
2. Execute a [Context synchronization operation](#).

### v7.1 Debug OS Restore sequence

After a powerdown, to restore the debug logic state from the non-volatile storage, the OS Restore sequence must:

1. Set the OS Lock by writing the key value, 0xC5ACCE55, to the [DBGOSLAR](#). The lock is set by the core powerup reset, but this ensures it is set.
2. Execute an ISB instruction.
3. Walk through the registers listed in [The debug logic state to preserve over a powerdown on page C7-2152](#), and restore the values from the non-volatile storage.
4. Execute an ISB instruction.
5. Clear the OS Lock by writing any non-key value to the [DBGOSLAR](#).
6. Execute a [Context synchronization operation](#).

### v7.1 Debug behavior when the OS Lock is set

The main purpose of the OS Lock is to prevent updates to debug registers during an OS Save or OS Restore operation. In a v7.1 Debug implementation, the OS Lock is set on a core powerup reset.

When the OS Lock is set:

- Access to debug registers through the CP14 interface and memory-mapped interface is mainly unchanged, except that:
    - for accesses through the CP14 interface, the Debug Software Enable function is ignored
    - the registers can be read and written without side-effects
    - fields in [DBGDSCR](#)ext that are normally UNKNOWN or read-only when accessed using the CP14 interface become read/write.
- These changes mean the current state can be saved or restored. For more information, see [v7.1 Debug register access in the CP14 interface on page C6-2139](#) and [v7.1 Debug register access in the memory-mapped and external debug interfaces on page C6-2141](#).
- Access to debug registers through external debug interface is restricted to prevent an external debugger modifying the registers that are being saved or restored.
  - Software debug events other than BKPT instruction debug events are ignored.
  - Regardless of the currently-selected debug-mode, BKPT instruction debug events generate a debug exception.

The OS Lock has no effect on Halting debug events.

### v7.1 Debug behavior when the OS Lock is cleared

When the OS Lock is cleared, an OS Unlock catch debug event is generated if [DBGECR](#).OUCE, the OS Unlock catch enable bit, is set to 1. See [Halting debug events on page C3-2073](#).

## Behavior when the OS Double Lock is set

OS Double Lock is implemented only as part of a v7.1 Debug implementation.

The OS Double Lock is set immediately before a powerdown sequence. When the OS Double Lock is set:

- Access to most debug registers through the CP14 interface is UNPREDICTABLE. For more information, see [v7.1 Debug register access in the CP14 interface on page C6-2139](#).
- Access to debug registers through the external debug and memory-mapped interfaces is restricted, so that these interfaces are quiescent prior to removing power. For more information, see [v7.1 Debug register access in the memory-mapped and external debug interfaces on page C6-2141](#).

———— **Note** —————

A debug register access might be in progress when software sets [DBGOSDLR.DLK](#) to 1. An implementation must not permit the synchronization of setting the OS Double Lock to stall indefinitely waiting for that access to complete. This means that any debug register access that is in progress when software sets [DBGOSDLR.DLK](#) to 1 must complete or return an error as soon as possible. A [Context synchronization operation](#) is required to synchronize a change to [DBGOSDLR](#).

- Software debug events, other than BKPT instruction debug events, are ignored.
- Halting debug events do not cause entry to Debug state, and become pending. See [Halting debug events on page C3-2073](#) for more information about pending Halting debug events.

———— **Note** —————

Pending Halting debug events might be lost when core power is removed.

- No asynchronous debug events are WFI or WFE wake-up events, see [Halting debug events on page C3-2073](#).

Software must synchronize the update to [DBGOSDLR](#) before it indicates to the system that power can be removed. Typically, software indicates that power can be removed by entering the Wait For Interrupt state, see [Wait For Interrupt on page B1-1202](#), and if this method is used, software must synchronize the [DBGOSDLR](#) update before issuing the WFI instruction.

[DBGOSDLR.DLK](#) is ignored and the OS Double Lock is not set if either:

- the processor is in Debug state
- [DBGPRCR.CORENPDRQ](#), Core no powerdown request bit, is set to 1.

———— **Note** —————

It is possible to enter Debug state with [DBGOSDLR.DLK](#), OS Double Lock control bit, set to 1. This is because a [Context synchronization operation](#) is required to ensure the OS Double Lock is set, meaning that Debug state might be entered before the [DBGOSDLR](#) update is synchronized. A processor implementation must not permit entry to Debug state once the write to [DBGOSDLR.DLK](#) has been synchronized by a [Context synchronization operation](#).

## C7.4 Reset and debug

The processor reset scheme is IMPLEMENTATION DEFINED. The ARM architecture, described in parts A and B of this manual, does not define different levels of reset. However, in a typical system, there are a number of reasons why multiple levels of reset might exist. In particular, for debug:

- In any reset scheme, a debugger must be able to debug the reset sequence. This requires support for:
  - setting the debug register values while the processor is in a reset state
  - a processor reset not resetting the debug register values.

For more information see [Debug register accesses when the implementation is in a non-debug logic reset state on page C7-2161](#).

- Providing separate power domains means you might need to reset the debug logic independently from the logic in the core power domain.

For these reasons, v7 Debug introduces a distinction between *debug logic reset* and *non-debug logic reset*. These resets can be applied independently. The reset descriptions in parts A and B of this manual describe the non-debug logic reset. Part C describes the debug logic reset and its interaction with the non-debug logic reset. The following sections give more information about this:

- [Recommended reset scheme](#)
- [Debug register accesses when the implementation is in a non-debug logic reset state on page C7-2161](#)
- [Debug register accesses when the implementation is in a non-debug logic reset state on page C7-2161](#).

### C7.4.1 Recommended reset scheme

ARM recommends use of the following reset signals for an implementation that supports these independent resets:

<b>nSYSPORESET</b>	System powerup reset signal. This signal must be asserted LOW on powerup of both the core power domain and the debug power domain. It sets both non-debug logic and debug logic, in both the core power domain and the debug power domain, to a known state.
<b>nCOREPORESET</b>	Core powerup reset signal. If the core power domain is powered down while the system is still powered up, this signal must be asserted LOW when the core power domain is powered back up. It sets both non-debug logic and debug logic in the core power domain to a known state. Also, this reset initializes the debug registers that are in the core power domain.
<b>nRESET</b>	Warm reset signal. This signal is asserted LOW to generate a warm reset, that is, a reset where the system wants to set the processor to a known state but the reset has nothing to do with any powerdown, for example a watchdog reset. It sets parts of the non-debug logic to a known state. This reset must not affect any debug session.
<b>PRESETDBGn</b>	Debug logic reset signal. The debugger asserts this signal LOW to set parts of the debug logic to a known state. This signal must be asserted LOW on powerup of the debug logic.

In the recommended reset scheme, the **PRESETDBGn** reset signal can be asserted at any time, not just at powerup. This signal has similar effects to **nSYSPORESET**, that is, it clears all debug registers, unless otherwise noted by the register definition. For more information, see [Appendix A Recommended External Debug Interface](#).

However, asynchronously asserting **PRESETDBGn** can lead to UNPREDICTABLE behavior. For example, the reset might change the values of debug registers that are in use or will be used by software.

For more information about this reset scheme, contact ARM.

[Table C7-2 on page C7-2161](#) summarizes the recommended reset scheme.

Table C7-2 Recommended reset scheme

Signal	Debug power domain	Core power domain	
	Debug logic	Debug logic	Non-debug logic
<b>nSYSPORESET</b>	Reset	Reset <sup>a</sup>	Reset
<b>nCOREPORESET</b>	Not reset	Reset <sup>a</sup>	Reset
<b>nRESET</b>	Not reset	Not reset	Reset
<b>PRESETDBGn</b>	Reset	Reset <sup>a</sup>	Not reset

a. If the core power domain is not powered, or in v7 Debug only if the Sticky Powerdown status bit **DBGPRSR.SPD** is set to 1, it is UNPREDICTABLE whether the registers are reset. If power is not applied to the core power domain, **nCOREPORESET** must be driven LOW when power is restored to the core power domain. This resets these registers.

For a SinglePower system, ARM recommends implementing only **nSYSPORESET**, **nRESET**, and **PRESETDBGn**.

#### C7.4.2 Debug register accesses when the implementation is in a non-debug logic reset state

It must be possible to write to a debug register if the following conditions are met:

1. The debug logic in the debug power domain is not in reset. That is, the debug logic reset is not asserted.
2. The register being written to is not itself being reset. For example, when a warm reset is asserted, it is not a register in the core power domain that is reset by a warm reset.

When condition 1 is met, if the register being written to is being reset, then the write to the register is accepted. However when the reset of that register is deasserted the value of that register is:

- its architecturally-defined reset value, if the architecture defines a reset value for the register
- UNKNOWN, otherwise.

This means that, while the processor is in a warm reset, a debugger can write to the debug registers that are in the core power domain but are not reset by a warm reset.

A debugger can set **DBGPRCR.HCWR** to hold the processor in a warm reset. It might do this while it writes to debug registers that are not reset by a warm reset.

#### C7.4.3 Debug behavior when the implementation is in a debug logic reset state

Table C7-2 shows how the debug logic can be split across two power domains, meaning some debug registers are implemented in the debug power domain, and other debug registers are implemented in the core power domain.

As long as a debug logic reset is asserted:

- any access to a register that is in debug logic reset, using any interface to the debug registers, is UNPREDICTABLE, except for CP14 reads of the read-only registers **DBGDIDR**, **DBGDSAR**, and **DBGDRAR**
- if the debug power domain is in debug logic reset, or in a SinglePower system, any access through the external debug register interface, or through the memory-mapped debug register interface, is UNPREDICTABLE
- it is UNPREDICTABLE whether a debug event that would have been generated by the state of the debug logic immediately before the debug logic reset is generated
- the debug logic must not generate any debug event that would not have been generated if the system was not in debug logic reset.



# Chapter C8

## The Debug Communications Channel and Instruction Transfer Register

This section describes communication between a debugger and the processor debug logic, using the *Debug Communications Channel* (DCC) and the *Instruction Transfer Register*, [DBGITR](#). It contains the following sections:

- [About the DCC and DBGITR on page C8-2164](#)
- [Operation of the DCC and Instruction Transfer Register on page C8-2167](#)
- [Behavior of accesses to the DCC registers and DBGITR on page C8-2171.](#)
- [Synchronization of accesses to the DCC and the DBGITR on page C8-2176.](#)

## C8.1 About the DCC and DBGITR

This section introduces the *Debug Communications Channel* (DCC) and the *Instruction Transfer Register*, [DBGITR](#).

The DCC provides a communications channel between:

- an external debugger, described as the *debug host*
- the debug implementation on the processor, described as the *debug target*.

Debug software can use the DCC to transfer a data word between the debug host and debug target using:

- the *Host to Target Data Transfer Register*, [DBGDTRRX](#)
- the *Target to Host Data Transfer Register*, [DBGDTRTX](#).

In addition, when the processor is in Debug state, debug software can use the [DBGITR](#) to transfer an ARM instruction to the processor for execution.

A debugger can use the DCC and [DBGITR](#) to examine and modify the state of the processor.

Bits in the *Debug Status and Control Register*, [DBGDSCR](#), control the operation of the DCC and [DBGITR](#). Some bits provide software control of these features, and other bits are status bits that affect operation. The [DBGDSCR](#) sets the External DCC access mode that controls the access mode for the external views of the DCC registers and the [DBGITR](#).

For more information see:

- [DCC overview](#)
- [DBGITR overview on page C8-2165](#)
- [Internal and external views of the DBGDSCR and the DCC registers on page C8-2165](#).

The remainder of this chapter describes how the DCC and [DBGITR](#) operate, and the relation between them.

### C8.1.1 DCC overview

The DCC comprises two registers, and a set of status bits in the [DBGDSCR](#):

- The [DBGDTRRX](#)
- The [DBGDTRTX](#)
- The following status bits in the [DBGDSCR](#):
  - RXfull and RXfull\_l, indicating the [DBGDTRRX](#) status
  - TXfull and TXfull\_l, indicating the [DBGDTRTX](#) status.

RXfull\_l is a latched copy of the RXfull bit, and TXfull\_l is a latched copy of the TXfull bit.

In addition, the following [DBGDSCR](#) fields control features of the DCC:

- [DBGDSCR.ExtDCCmode](#) controls the External DCC access mode. The possible modes are:

#### **Non-blocking**

If the DCC cannot perform a requested transfer it ignores the transfer request. If the debug logic cannot issue the [DBGITR](#) instruction for execution it ignores a write to [DBGITR](#). This is the default external access mode.

#### **Stall**

If the DCC cannot perform a requested transfer, or the debug logic cannot issue the [DBGITR](#) instruction for execution, the associated register access stalls until the debug logic can perform the required operation.

#### **Fast**

A debugger can use Fast mode to issue a single instruction multiple times, without updating [DBGITR](#). If the DCC cannot perform a requested transfer, the associated register access stalls. Also, a write to [DBGITR](#) can stall.

[Operation of the External DCC access modes on page C8-2167](#) gives more information about each of the access modes.

- [DBGDSCR.UDCCdis](#) controls User mode access to the DCC.



## C8.1.2 DBGITR overview

*DBGITR, Instruction Transfer Register* on page C11-2263 describes the **DBGITR**.

**DBGDSCR.InstrCompl\_1** is a latched status bit that indicates when the processor has completed execution of an instruction issued through the **DBGITR**, see *DBGDSCR, Debug Status and Control Register* on page C11-2241.

———— **Note** —————

The internal **InstrCompl** flag indicates when the processor has completed execution of an instruction issued through the **DBGITR**. **InstrCompl** is not visible in any register, but **DBGDSCR.InstrCompl\_1** is a latched copy of this internal flag.

In addition, the **DBGDSCR.ITRen** bit enables the execution of ARM instructions through the **DBGITR**.

The external DCC access mode affects the behavior of writes to the **DBGITR**, see *Operation of the DCC and Instruction Transfer Register* on page C8-2167.

*The Sticky Synchronous Data Abort bit and issuing instructions from DBGITR* on page C8-2170 describes the conditions under which an instruction, held in **DBGITR**, is issued for execution.

The behavior of accesses to **DBGITR** is restricted by various locks and processor states. See *Accesses to the registers in v7.1 Debug* on page C8-2171 for details.

## C8.1.3 Internal and external views of the DBGDSCR and the DCC registers

A debug implementation provides internal and external views of each of the registers **DBGDSCR**, **DBGDTRTX** and **DBGDTRRX**, see [Figure C8-1](#). The *int* and *ext* suffixes denote the internal and external views. The differences between these views relate to the handling of the DCC, and in particular the **TXfull**, **RXfull**, and **InstrCompl\_1** status bits. The view names *internal* and *external* are based on the DCC usage model.

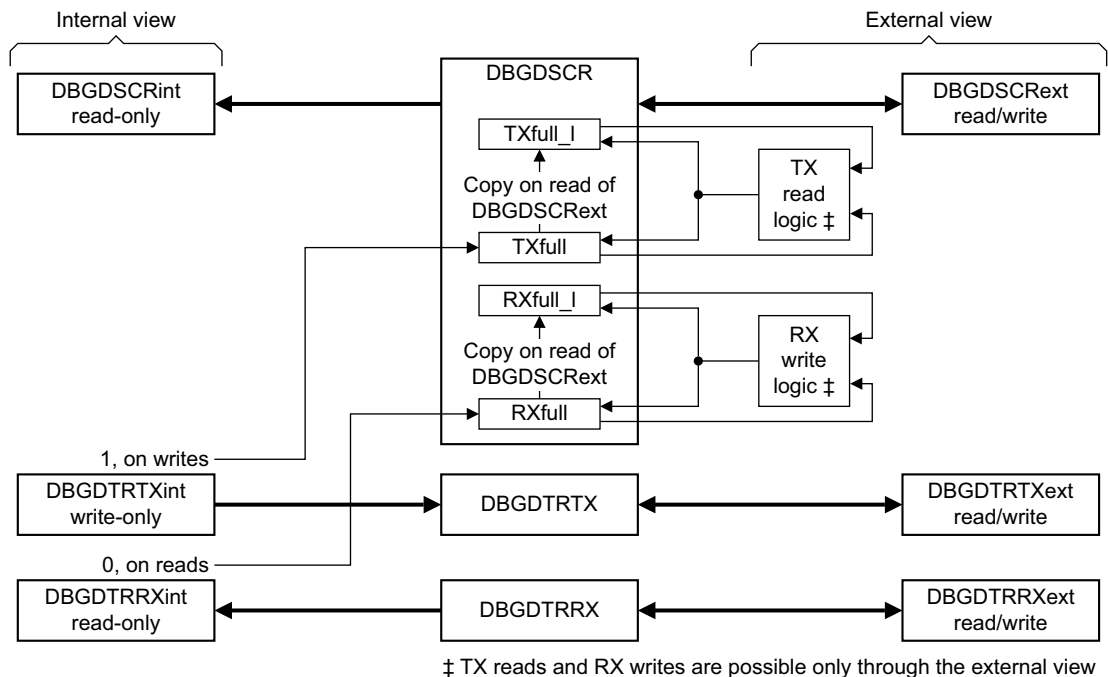

**Figure C8-1 Internal (int) and external (ext) views of the DCC registers**

In the **DBGDSCR**, in addition to the updates to **TXfull\_I** and **RXfull\_I** shown in [Figure C8-1](#), a read of **DBGDSCRext** copies the internal **InstrCompl** flag to the **InstrCompl\_1** bit, see *DBGDSCR, Debug Status and Control Register* on page C11-2241. The value of **InstrCompl\_1** is visible only in the **DBGDSCRext** view.

Software can access [DBGDSCRint](#), [DBGDTRRXint](#), and [DBGDTRTXint](#) only through the CP14 interface, see [CP14 debug register interface accesses on page C6-2122](#).

Software can access [DBGDSCRext](#), [DBGDTRRXext](#), and [DBGDTRTXext](#) through:

- the CP14 interface:
  - in v7 Debug it is IMPLEMENTATION DEFINED if these registers are visible in the CP14 interface
  - in v7.1 Debug these registers are required in the CP14 interface
- the memory-mapped interface, if implemented
- the external debug interface.

The behavior of accesses to these registers is restricted by various locks and processor states. For more information, see:

- [Accesses to the registers in v7 Debug on page C8-2171](#)
- [Accesses to the registers in v7.1 Debug on page C8-2171](#).

If at any given time software attempts to access [DBGDSCRext](#), [DBGDTRRXext](#), or [DBGDTRTXext](#) through more than one interface the behavior is UNPREDICTABLE. If an implementation provides a single port to handle external debug interface accesses and memory-mapped interface accesses, that port might serialize accesses to the registers from the two interfaces. However, the effects of reads and writes to these registers are such that the behavior observed from either interface is UNPREDICTABLE.

———— **Note** —————

- [DBGDSCRint](#) and [DBGDSCRext](#) only provide different views onto the underlying [DBGDSCR](#)
  - [DBGDTRRXint](#) and [DBGDTRRXext](#) only provide different views onto the underlying [DBGDTRRX](#) register
  - [DBGDTRTXint](#) and [DBGDTRTXext](#) only provide different views onto the underlying [DBGDTRTX](#) register.
-

## C8.2 Operation of the DCC and Instruction Transfer Register

This section describes the operation of the DCC and Instruction Transfer Register:

- [General operation of the DCC and Instruction Transfer Register](#) introduces these operations
- [Operation of the External DCC access modes](#) gives a full description of each of the External DCC access modes.

### C8.2.1 General operation of the DCC and Instruction Transfer Register

The debug logic includes a number of controls on the operation of the DCC registers and the [DBGITR](#). The External DCC access mode determines how external accesses to the DCC and [DBGITR](#) behave, when other controls permit an operation. The function of the [DBGDSCR](#) status bits is:

- [RXfull](#) and [RXfull\\_1](#) control whether the processor can accept a write to [DBGDTRRXext](#), and the behavior when it cannot accept a write.
- [TXfull](#) and [TXfull\\_1](#) control whether the processor can accept a read of [DBGDTRTXext](#), and the behavior when it cannot accept a read.
- The internal [InstrComp\\_1](#) flag controls whether the processor can accept a write to [DBGITR](#). In Fast mode the [InstrComp\\_1](#) flag also controls whether the processor can accept writes to [DBGDTRRXext](#) and reads from [DBGDTRTXext](#).

### C8.2.2 Operation of the External DCC access modes

This section describes the operation of each of the External DCC access modes. For descriptions of the registers used in these operations see:

- [DBGDSCR, Debug Status and Control Register on page C11-2241](#)
- [DBGDTRRX, Host to Target Data Transfer register on page C11-2259](#)
- [DBGDTRTX, Target to Host Data Transfer register on page C11-2260](#)
- [DBGITR, Instruction Transfer Register on page C11-2263](#).

The [DBGDSCR.ExtDCCmode](#) field determines the External DCC access mode. The following subsections describe these modes:

- [Non-blocking mode on page C8-2168](#)
- [Stall mode on page C8-2168](#)
- [Fast mode on page C8-2168](#).

Non-blocking mode is the default mode. Inappropriate use of the other modes can deadlock the memory-mapped or external debug interface.

#### ———— **Note** —————

The [DBGDSCR.ExtDCCmode](#) field has no effect on accesses to [DBGDTRRXint](#) and [DBGDTRTXint](#).

The descriptions in this section assume that any required access and operation is permitted. For more information about permitted accesses to the Debug registers see:

- [Summary of the v7 Debug register interfaces on page C6-2128](#)
- [Summary of the v7.1 Debug register interfaces on page C6-2137](#).

For all of these modes:

- [The Sticky Synchronous Data Abort bit and issuing instructions from DBGITR on page C8-2170](#) describes when instructions are issued from [DBGITR](#) for execution
- [Behavior of accesses to the DCC registers and DBGITR on page C8-2171](#) summarizes the behavior of the register accesses.

## Non-blocking mode

In Non-blocking mode:

- if RXfull\_1 is 1, writes to [DBGDTRRXext](#) are ignored
- if InstrCompl\_1 is 0, writes to [DBGITR](#) are ignored
- if TXfull\_1 is 0, reads from [DBGDTRTXext](#) are ignored, and the reads return UNKNOWN values.

Following a successful write to [DBGDTRRXext](#), the RXfull and RXfull\_1 bits are set to 1.

Following a successful read from [DBGDTRTXext](#), the TXfull and TXfull\_1 bits are set to 0.

Following a successful write to [DBGITR](#), the internal InstrCompl flag and the InstrCompl\_1 bit are set to 0.

A debugger accessing a DCC register or [DBGITR](#) must first read [DBGDSCRext](#). This has the side-effect of copying RXfull and TXfull to RXfull\_1 and TXfull\_1, and setting InstrCompl\_1 to the current value of the internal InstrCompl flag. The debugger can then use the returned value to determine whether a subsequent access to these registers will be ignored.

## Stall mode

In Stall mode:

- the effect of any access to [DBGDTRRXext](#) or [DBGDTRTXext](#) through the CP14 interface is UNPREDICTABLE.
- accesses through the external debug interface or the memory-mapped interface stall as follows:
  - if RXfull is 1, any write to [DBGDTRRXext](#) stalls until RXfull is 0
  - if InstrCompl is 0, any write to [DBGITR](#) stalls until InstrCompl is 1
  - if TXfull is 0, any read from [DBGDTRTXext](#) stalls until TXfull is 1.

If an access is stalled in this way software cannot access any of the debug registers until the stalled [DBGDTRRXext](#), [DBGDTRTXext](#), or [DBGITR](#) access completes. For more information about stalled accesses see [Stalling of accesses to the DCC registers on page C8-2170](#).

Following a write to [DBGDTRRXext](#) or [DBGITR](#), or a read from [DBGDTRTXext](#), the internal InstrCompl flag, and the InstrCompl\_1, RXfull, RXfull\_1, TXfull, and TXfull\_1 bits, are set as described in [Non-blocking mode](#).

### ———— Note —————

- Whether an access stalls depends on the value of the RXfull or TXfull status bit, or the internal InstrCompl flag, not on the corresponding latched bits.
- The Non-blocking mode rules for ignoring accesses based on the values of the latched bits InstrCompl\_1, RXfull\_1, and TXfull\_1 do not apply in Stall mode.

When the processor is in Non-debug state, software can program the [DBGDSCR.ExtDCCmode](#) field to select Stall mode. However, because Stall mode blocks the interface to the debug registers until the processor issues the correct MCR or MRC instruction to unblock the access, ARM recommends that you do not use Stall mode in cases where the external debugger does not have complete control over the instructions executing on the processor.

## Fast mode

A debugger can use Fast mode to make the processor execute a single instruction repeatedly, without reloading the [DBGITR](#). However, if [DBGDSCR.ExtDCCmode](#) is programmed to select Fast mode, the result of writing to [DBGITR](#), writing to [DBGDTRRXext](#), or reading [DBGDTRTXext](#), is UNPREDICTABLE if either:

- [DBGDSCR.ITRen](#) is 0
- the processor is in Non-debug state.

In Fast mode:

- A write to the **DBGITR** does not trigger an instruction for execution. Instead, the debug logic latches the instruction written to **DBGITR**, and retains this value until either a new value is written to **DBGITR**, or software changes the access mode. If the processor is executing a previously-issued instruction when the debugger writes to **DBGITR**, the write must not affect the execution of that instruction. To achieve this requirement, an implementation can stall the write to **DBGITR** until **InstrCompl** is set to 1.
- The effect of any access to **DBGDTRRXext** or **DBGDTRTXext** through the CP14 interface is UNPREDICTABLE.
- For accesses through the external debug interface or the memory-mapped interface:
  - when an instruction is latched, any read of **DBGDTRTXext** or write to **DBGDTRRXext** causes the processor to execute the latched instruction, as described in this subsection
  - when no instruction is latched, the effect of any access to **DBGDTRRXext** or **DBGDTRTXext** is UNPREDICTABLE.
- A write to **DBGDTRRXext**:
  - does not complete until **InstrCompl** is set to 1
  - writes the data to the **DBGDTRRX**
  - issues the instruction last written to **DBGITR**.

If **RXfull** is set to 1 before the write, then after the write the values of **DBGDTRRX**, the **DBGDSCR.RXfull** bit, and the **DBGDSCR.RXfull\_1** bit, are UNKNOWN.

If the issued instruction reads from **DBGDTRRXint**, the instruction reads the value written to **DBGDTRRXext** by the write that triggered the instruction issue. The issued instruction does not complete until **RXfull** is set to 0. This means that **InstrCompl** remains set to 0 until **RXfull** is set to 0, to indicate that the processor is ready to accept another write to **DBGDTRRXext**.

- A read from **DBGDTRTXext**:
  - does not complete until **InstrCompl** is set to 1
  - returns the data from the **DBGDTRTX**
  - issues the instruction last written to the **DBGITR**.

If **TXfull** is set to 0 before the read, then the read returns an UNKNOWN value, and after the read the values of **DBGDTRTX**, the **DBGDSCR.TXfull** bit, and the **DBGDSCR.TXfull\_1** bit, are UNKNOWN.

If the issued instruction writes to **DBGDTRTXint**, the instruction does not affect the value returned from this read of **DBGDTRTXext**. That is, this instruction can write the next **DBGDTRTXext** value to be read. The issued instruction does not complete until **TXfull** is set to 1. This means that **InstrCompl** remains set to 0 until **TXfull** is set to 1, to indicate that the processor is ready to accept another read from **DBGDTRTXext**.

If a Fast mode access is stalled, software cannot access any of the debug registers until the stalled **DBGDTRRXext**, **DBGDTRTXext**, or **DBGITR** access completes. For more information about stalled accesses see *Stalling of accesses to the DCC registers* on page C8-2170.

———— **Note** —————

The Non-blocking mode rules for ignoring accesses based on the values of the latched bits **InstrCompl\_1**, **RXfull\_1** and **TXfull\_1** do not apply in Fast mode.

Following a write to **DBGDTRRXext** or **DBGITR**, or a read from **DBGDTRTXext**, the internal **InstrCompl** flag, and the **InstrCompl\_1**, **RXfull**, **RXfull\_1**, **TXfull**, and **TXfull\_1** bits, are set as described in *Non-blocking mode* on page C8-2168.

## Stalling of accesses to the DCC registers

In Stall mode and Fast mode, accesses to the DCC registers can stall:

- The mechanism by which an access is stalled by the external debug interface must be defined by the documentation of that interface. For details of how accesses are stalled by the recommended ARM Debug Interface v5, see the *ARM Debug Interface v5 Architecture Specification*.
- The mechanism by which an access is stalled by the memory-mapped interface is IMPLEMENTATION DEFINED.
- A stall is a side-effect of an access. If the debug logic is in a state where an access must have no side-effects, the access does not stall. For more information about debug logic states in which accesses have no side-effects see:
  - [Summary of the v7 Debug register interfaces on page C6-2128](#)
  - [Summary of the v7.1 Debug register interfaces on page C6-2137](#).

## The Sticky Synchronous Data Abort bit and issuing instructions from DBGITR

The sections *Non-blocking mode* on page C8-2168, *Stall mode* on page C8-2168, and *Fast mode* on page C8-2168 describe the operations that can cause an instruction to be issued from **DBGITR**, for execution. The instruction is issued only if the Sticky Synchronous Data Abort bit, **DBGDSCR.SDABORT\_1**, is set to 0. When this bit is set to 0, the instruction is issued:

- in Non-blocking mode and in Stall mode, on a write to **DBGITR**
- in Fast mode on:
  - a write to **DBGDTRRXext**
  - a read from **DBGTRTXext**.

When **DBGDSCR.SDABORT\_1** is set to 1, no instruction is issued for execution. That means that, for an operation that would issue an instruction when **DBGDSCR.SDABORT\_1** is set to 0:

- the internal InstrCompl flag and the InstrCompl\_1 bit are unchanged
- in Fast mode:
  - for a write to **DBGDTRRXext**, the write completes immediately, the processor ignores the write, and the values of **DBGTRRX**, **RXfull**, and **RXfull\_1** become UNKNOWN
  - for a read from **DBGTRTXext**, the read completes immediately, the value returned is UNKNOWN, and the values of **DBGTRTX**, **TXfull**, and **TXfull\_1** become UNKNOWN
  - for a write to **DBGITR**, the write completes immediately, and the processor can ignore the write.
- in Non-blocking or Stall mode, a write to **DBGITR** completes immediately, and the processor must ignore the write.

This behavior means an external debugger can issue a series of memory access instructions without checking for a synchronous Data Abort exception after each instruction issue.

In Fast mode, if a debugger writes to **DBGITR** when **DBGDSCR.SDABORT\_1** is set to 1, the value of the latched instruction becomes UNKNOWN. This means that, when **DBGDSCR.SDABORT\_1** is cleared to 0, if the DCC remains in Fast mode, the instruction issued on a write to **DBGDTRRXext** or a read from **DBGTRTXext** is also UNKNOWN.

### ———— Note —————

The values of the Sticky Asynchronous Abort and Sticky Undefined Instruction bits, **DBGDSCR.ADABORT\_1** and **DBGDSCR.UND\_1**, have no effect on whether instructions are issued from the **DBGITR**.

For more information about the **SDABORT\_1** bit see *DBGDSCR, Debug Status and Control Register* on page C11-2241.

## C8.3 Behavior of accesses to the DCC registers and DBGITR

The following sections describe the behavior of accesses to the internal and external views of the DCC registers, `DBGDSCRext`, and to the `DBGITR`:

- [Accesses to the registers in v7 Debug](#)
- [Accesses to the registers in v7.1 Debug](#)
- [Behavior of accesses to `DBGDTRRX` on page C8-2172](#)
- [Behavior of accesses to `DBGDTRTX` on page C8-2173](#)
- [Behavior of accesses to the `DBGITR` on page C8-2174.](#)

Access to the registers must permit reads and writes of the DCC registers and `DBGITR` to set control bits in the `DBGDSCRext`. Access can be restricted by locks, controls and traps in the different interfaces. For more information on the how the locks, controls, and traps are set, see [Access permissions on page C6-2117](#).

### C8.3.1 Accesses to the registers in v7 Debug

[Summary of the v7 Debug register interfaces on page C6-2128](#) gives full information about the behavior of debug register accesses in v7 Debug. This subsection summarizes the general rules that apply to those accesses.

In v7 Debug:

- Full register access is available through:
  - The CP14 interface when no locks or controls are set and the processor is in Non-debug state at privilege level PL1.
  - The memory-mapped and external debug interfaces when the core and debug power domains are both powered up, and no locks or controls are set, and for the `DBGITR`, the processor must be in Debug state.
- Otherwise, access to a register might be UNPREDICTABLE or generate an error.

### C8.3.2 Accesses to the registers in v7.1 Debug

[Summary of the v7.1 Debug register interfaces on page C6-2137](#) gives full information about the behavior of debug register accesses in v7.1 Debug. This subsection summarizes the general rules that apply to those accesses.

In v7.1 Debug:

- Full register access is available:
  - Through the CP14 interface when no locks, controls, or traps are set and the processor is in Non-debug state at privilege level PL1 or PL2. ARM deprecates accessing the `DBGDTRRXext` and `DBGDTRTXext` through the CP14 interface except when the OS Lock is set.
  - Through the memory-mapped and external debug interfaces when the core and debug power domains are both powered up, and no locks or controls are set, and for the `DBGITR`, the processor must be in Debug state.
- When the OS Lock is set, restricted access to `DBGDTRRXext` and `DBGDTRTXext` is available:
  - Through the CP14 interface.
  - If the Software Lock is not set, through the memory-mapped interface.

Restricted access means that register reads and writes are permitted, but the accesses do not change any status flags in the `DBGDSCR`. This level of access can be used when saving and restoring the DCC registers as part of external debug over powerdown. For more information, see [Chapter C7 Debug Reset and Powerdown Support](#).
- Otherwise, access to a registers might be UNPREDICTABLE, generate an error, or generate a Hyp Trap exception.

### C8.3.3 Behavior of accesses to DBGDTRRX

Software can access [DBGDTRRXext](#) through:

- The CP14 interface, except that:
  - in Debug state these accesses are UNPREDICTABLE
  - in v7 Debug it is IMPLEMENTATION DEFINED whether [DBGDTRRXext](#) is visible in the CP14 interface.
- The memory-mapped interface, if implemented.
- The external debug interface.

———— **Note** —————

- The value of [DBGDSCR.RXfull\\_1](#) does not affect the behavior of accesses to [DBGDTRRXint](#).
- Accesses to [DBGDTRRXint](#) do not update the value of [DBGDSCR.RXfull\\_1](#).

To access [DBGDTRRXint](#) through the CP14 interface, software reads the CP14 register using either:

- an MRC instruction with <opc1> set to 0, <CRn> set to c0, <CRm> set to c5, and <opc2> set to 0
- an STC instruction with <CRd> set to c5.

Both instructions read only one word from the [DBGDTRRXint](#) register. For example:

```
MRC p14, 0, <Rd>, c0, c5, 0 ; Read DBGDTRRXint register
STC p14, c5, [<Rn>], #4 ; Read a word from the DBGDTRRXint register and write it to memory
```

If an STC instruction that reads [DBGDTRRXint](#) generates a Data Abort exception, the contents of [DBGDTRRX](#) and the value of the [DBGDSCR.RXfull](#) bit are UNKNOWN.

The remainder of this section describes the behavior of accesses to the different views of [DBGDTRRX](#). In the tables that describe this behavior:

- The entry in the *Condition* column identifies which of the DCC status bits controls the access. The access does not depend on the value of any other DCC bits.
- The *New RXfull* and *New RXfull\_1* entries give the values of those DCC status bits after the specified access.
- [Operation of the External DCC access modes on page C8-2167](#) gives more information about the possible entries in the *Access mode* column of [Table C8-2 on page C8-2173](#).

[Table C8-1](#) shows the behavior of accesses to [DBGDTRRXint](#)

**Table C8-1 Behavior of accesses to DBGDTRRXint**

Access	Condition	Action	New RXfull
Read	RXfull == 0	Returns an UNKNOWN value.	Unchanged
	RXfull == 1	Returns <a href="#">DBGDTRRX</a> contents	0
Write	-	Not possible. There is no operation that writes to <a href="#">DBGDTRRXint</a>	-

The following sections describe possible restrictions on accesses to [DBGDTRRXext](#), and how these restrictions affect the behavior of those accesses:

- [Accesses to the registers in v7 Debug on page C8-2171](#)
- [Accesses to the registers in v7.1 Debug on page C8-2171](#).



If none of these restrictions apply, [Table C8-2](#) shows the behavior of accesses to [DBGDTRRX](#)ext.

**Table C8-2 Behavior of accesses to [DBGDTRRX](#)ext**

Access	Access mode	Condition	Action	New <a href="#">RXfull</a> and <a href="#">RXfull_I</a>
Read	-	<a href="#">RXfull</a> == 0	Returns an UNKNOWN value	Unchanged
		<a href="#">RXfull</a> == 1	Returns <a href="#">DBGDTRRX</a> contents	Unchanged
Write	Non-blocking	<a href="#">RXfull_I</a> == 0	Writes to <a href="#">DBGDTRRX</a>	1
		<a href="#">RXfull_I</a> == 1	Write is ignored.	Unchanged
	Stall	<a href="#">RXfull</a> == 0	Writes to <a href="#">DBGDTRRX</a>	1
		<a href="#">RXfull</a> == 1	Stalls until ( <a href="#">RXfull</a> == 0)	-
Fast		<a href="#">InstrCompl</a> == 0	Stalls until ( <a href="#">InstrCompl</a> == 1)	-
		<a href="#">InstrCompl</a> == 1	Writes to <a href="#">DBGDTRRX</a> and issues the instruction from the <a href="#">DBGITR</a>	1

### C8.3.4 Behavior of accesses to [DBGDTRTX](#)

Software can access [DBGDTRTX](#)ext through:

- The CP14 interface, except that:
  - in Debug state these accesses are UNPREDICTABLE
  - in v7 Debug it is IMPLEMENTATION DEFINED whether [DBGDTRTX](#)ext is visible in the CP14 interface.
- The memory-mapped interface, if implemented.
- The external debug interface.

———— **Note** ————

- The value of [DBGDSCR.TXfull\\_I](#) does not affect the behavior of accesses to [DBGDTRTX](#)int.
- Accesses to [DBGDTRTX](#)int do not affect the value of [DBGDSCR.TXfull\\_I](#).

To access the [DBGDTRTX](#)int Register through the CP14 interface, software writes the CP14 register using either:

- an MCR instruction with <opc1> set to 0, <CRn> set to c0, <CRm> set to c5, and <opc2> set to 0
- an LDC instruction with <CRd> set to c5.

Both instructions write only one word to the [DBGDTRTX](#)int Register. For example:

```
MCR p14, 0, <Rd>, c0, c5, 0 ; Write DBGDTRTXint Register
LDC p14, c5, [<Rn>], #4 ; Read a word from memory and write it to the DBGDTRTXint Register
```

If an LDC instruction that writes to [DBGDTRTX](#)int generates a Data Abort exception, the contents of [DBGDTRTX](#) and the value of the [DBGDSCR.TXfull](#) bit become UNKNOWN.

The remainder of this section describes the behavior of accesses to the different views of [DBGDTRTX](#). In the tables that describe this behavior:

- The entry in the *Condition* column identifies which of the DCC status bits controls the access. The access does not depend on the value of any other DCC bits.
- The *New [TXfull](#)* and *New [TXfull\\_I](#)* entries give the values of [DBGDSCR](#) status bits after the specified access.
- [Operation of the External DCC access modes on page C8-2167](#) gives more information about the possible entries in the *Access mode* column of [Table C8-4 on page C8-2174](#).

Table C8-3 shows the behavior of accesses to [DBGDTRTXint](#)

**Table C8-3 Behavior of accesses to [DBGDTRTXint](#)**

Access	Condition	Action	New TXfull
Read	-	Not possible. There is no operation that reads from <a href="#">DBGDTRTXint</a> .	-
Write	TXfull == 0	Writes value to <a href="#">DBGDTRTX</a> .	1
	TXfull == 1	UNPREDICTABLE.	-

The following sections describe possible restrictions on accesses to [DBGDTRTXext](#), and how these restrictions affect the behavior of those accesses:

- [Accesses to the registers in v7 Debug on page C8-2171](#)
- [Accesses to the registers in v7.1 Debug on page C8-2171.](#)

If none of these restrictions apply, [Table C8-4](#) shows the behavior of accesses to [DBGDTRTXext](#).

**Table C8-4 Behavior of accesses to [DBGDTRTXext](#)**

Access	Access mode	Condition	Action	New TXfull and TXfull_I
Write	x	-	Updates <a href="#">DBGDTRTX</a> value <sup>a</sup>	Unchanged
Read	Non-blocking	TXfull_I == 0	Returns an UNKNOWN value.	Unchanged
		TXfull_I == 1	Returns <a href="#">DBGDTRTX</a> contents	0
	Stall	TXfull == 0	Stalls until (TXfull == 1)	-
		TXfull == 1	Returns <a href="#">DBGDTRTX</a> contents	0
	Fast	InstrCompl == 0	Stalls until (InstrCompl == 1)	-
		InstrCompl == 1	Returns <a href="#">DBGDTRTX</a> contents and issues the instruction in the <a href="#">DBGITR</a>	0

a. In the event of a race condition with writes to both [DBGDTRTXint](#) and [DBGDTRTXext](#) occurring, the result is UNPREDICTABLE. Software writes to [DBGDTRTXext](#) must be under controlled circumstances, for example when the processor is in Debug state.

### C8.3.5 Behavior of accesses to the [DBGITR](#)

Writes to the [DBGITR](#) are UNPREDICTABLE when either of the following apply:

- the processor is in Non-debug state
- [DBGDSCR.ITRen](#) is set to 0.

———— **Note** ————

This means that, if invasive debug is disabled or halting debug is not permitted in the current state, the write to [DBGITR](#) must not be permitted to alter the behavior of the program executing in Non-debug state.

[Table C8-5 on page C8-2175](#) shows the behavior of writes to the [DBGITR](#) when all of the following apply:

- The processor is in Debug state.
- [DBGDSCR.ITRen](#) is set to 1.

- [Accesses to the registers in v7 Debug on page C8-2171](#) or [Accesses to the registers in v7.1 Debug on page C8-2171](#) do not apply.
- The Sticky Synchronous Data Abort bit, `DBGDSCR.SDABORT_1`, is set to 0. For more information see [The Sticky Synchronous Data Abort bit and issuing instructions from DBGITR on page C8-2170](#).

In this table:

- The entry in the *Condition* column identifies which of the DCC status bits controls the access. The access does not depend on the value of any other status bits.
- The *New InstrCompl* and *New InstrCompl\_1* entries give the values of the internal `InstrCompl` flag and the `InstrCompl_1` bit after the specified access.
- [Operation of the External DCC access modes on page C8-2167](#) gives more information about the entries in the *Access mode* column.

**Table C8-5 Behavior of write accesses to DBGITR**

Access mode	Condition	Effect	New InstrCompl and InstrCompl_1
Non-blocking	<code>InstrCompl_1 == 0</code>	Write is ignored	Unchanged
	<code>InstrCompl_1 == 1</code>	Issue instruction	0
Stall	<code>InstrCompl == 0</code>	Stall until ( <code>InstrCompl == 1</code> )	-
	<code>InstrCompl == 1</code>	Issue instruction	0
Fast	-	Save instruction in <code>DBGITR</code> <sup>a</sup>	-

- a. In Fast mode, on a write to `DBGITR` when `InstrCompl` is set to 0, an implementation can stall the write until `InstrCompl` is set to 1, but is not required to do so. See [Fast mode on page C8-2168](#).

When the processor is in Non-debug state, writes to the `DBGITR` must not have any effect on the instructions executed by the processor.

## C8.4 Synchronization of accesses to the DCC and the DBGITR

This section describes the synchronization requirements that apply for accesses to the *Debug Communications Channel* (DCC) registers summarized in [DCC overview on page C8-2164](#), and to the [DBGITR](#). These requirements are additional to the requirements described:

- For accesses using the CP14 interface, in either:
  - [Synchronization of changes to system control registers on page B3-1461](#), for VMSA implementations.
  - [Synchronization of changes to system control registers on page B5-1777](#), for PMSA implementations.
- For accesses using the external debug interface or the memory-mapped interface, in [Synchronization requirements for memory-mapped register interfaces on page C6-2115](#).

In this section, accesses from the external debug interface and the memory-mapped interface are referred to as external reads and external writes. Accesses to system registers are referred to as direct reads, direct writes, indirect reads and indirect writes.

———— **Note** —————

[Synchronization of changes to system control registers on page B3-1461](#) and [Synchronization of changes to system control registers on page B5-1777](#) describe external reads and external writes as forms of indirect reads and indirect writes. This section gives more information about external reads and external writes and their synchronization requirements.

The DCC comprises the [DBGDTRTX](#) and [DBGDTRRX](#) registers and the [DBGDSCR](#). {TXfull, RXfull, TXfull\_1, RXfull\_1} flags, and provides a communications channel, with one end operating asynchronously to the other. Any implementation must respect the ordering of accesses to these registers in order to maintain correct behavior of the DCC.

Accesses to [DBGDTRRXext](#) and [DBGDTRTXext](#) are asynchronous to direct reads of [DBGDTRRXint](#) and direct writes to [DBGDTRTXint](#) made through the CP14 interface. The direct reads and direct writes indirectly write to the DCC flags in the [DBGDSCR](#). The external reads and external writes read the DCC flags to implement the current External DCC access mode, specified by [DBGDSCR.ExtDCCmode](#), see [DCC overview on page C8-2164](#).

### C8.4.1 DCC accesses in Non-debug state

In Non-debug state:

- If a direct read of [DBGDSCRint](#) returns an RXfull value of 1, then a following direct read of [DBGDTRRXint](#) returns valid data and indirectly writes 0 to [DBGDSCRint.RXfull](#) as a side-effect.
- If a direct read of [DBGDSCRint](#) returns a TXfull value of 0, then a following direct write to [DBGDTRTXint](#) writes the intended value, and indirectly writes 1 to [DBGDSCRint.TXfull](#) as a side-effect.

No context synchronization operation is required between the [DBGDSCRint](#) access and the [DBGDTRRXint](#) or [DBGDTRTXint](#) access. The action of the External DCC access modes prevent intervening external reads and external writes affecting the outcome of the second access.

Because the direct read of [DBGDTRRXint](#) is an indirect write to [DBGDSCRint.RXfull](#), it must not be executed speculatively before the read of [DBGDSCRint](#), meaning it must not return a speculative value for [DBGDTRRX](#) that predates the RXfull flag value returned by the read of [DBGDSCRint](#). The direct write to [DBGDTRTXint](#) must not be executed speculatively.

Direct reads of [DBGDTRRXint](#) and [DBGDSCRint](#) occur in program order with respect to other direct reads of the same register using the same encoding.

All accesses must be observable in the same order by all observers.

———— **Note** —————

This requirement applies only for ordered accesses. It does not create order where order does not otherwise exist.

The following accesses have an implied order:

- In the simple sequential execution of the program, the indirect write to the DCC flags in the `DBGDSCR` occurs immediately after the direct access to `DBGDTRRXint` or `DBGDTRTXint`.
- In the simple sequential execution model, the check of the DCC flags in the `DBGDSCR` occurs immediately before an external read of `DBGDTRTXext` or external write of `DBGDTRRXext`. If the external access is successful, the update of the DCC flags then occurs immediately after the `DBGDTRRXext` or `DBGDTRTXext` access.

The effect of this ordering depends on the External DCC access mode specified by `DBGDSCR.ExtDCCmode`:

#### Non-blocking mode

- Following a direct read of `DBGDTRRXint` made when `RXfull` is set to 1, if an external read of `DBGDSCRext` returns 0 for both `RXfull` and `RXfull_1`, the value written by a following external write to `DBGDTRRXext` does not affect the value returned by the previous direct read.
- Following a direct write of `DBGDTRTXint` made when `TXfull` is set to 0, if an external read of `DBGDSCRext` returns 1 for both `TXfull` and `TXfull_1`, then the value returned by a following external read of `DBGDTRTXext` must be the value written by the previous direct write.
- Following an external read of `DBGDTRTXext` made when `TXfull_1` is set to 1, if a direct read of `DBGDSCRint` returns 0 for `TXfull`, then the value returned by the external read must not be affected by a following direct write to `DBGDTRTXint`.
- Following an external write of `DBGDTRRXext` made when `RXfull_1` is set to 0, if a direct read of `DBGDSCRint` returns 1 for `RXfull`, then the value returned by a following direct read of `DBGDTRRXint` must be the value written by the previous external write.

#### Stall mode

- Following a direct read of `DBGDTRRXint` made when `RXfull` is set to 1, if an external write to `DBGDTRRXext` stalls until `RXfull` is set to 0, then the value returned by the previous direct read must not be affected by the external write.
- Following a direct write of `DBGDTRTXint` made when `TXfull` is set to 0, if an external read of `DBGDTRTXint` stalls until `TXfull` is set to 1, the value returned by the external read must be the value written by the previous direct write.
- Following a completed external read of `DBGDTRTXext`, if a direct read of `DBGDSCRint` returns 0 for `TXfull`, then the value returned by the external read must not be affected by a following direct write to `DBGDTRTXint`.
- Following a completed external write of `DBGDTRRXext`, if a direct read of `DBGDSCRint` returns 1 for `RXfull`, then the value returned by a following direct read of `DBGDTRRXint` must be the value written by the previous external write.

---

#### Note

---

Use of Fast mode is not permitted in Non-debug state.

---

Without explicit synchronization following external writes and external reads:

- A value externally written to `DBGDTRRXext` must be observable to direct reads of `DBGDTRRXint` in finite time.
- The DCC flags in the `DBGDSCR` that are updated as a side-effect of the external write or external read must be observable:
  - To direct reads of `DBGDSCRint` in finite time.
  - To subsequent external reads of `DBGDSCRext`.
  - If `DBGDSCR.ExtDCCmode` specifies Stall mode, to a subsequent external read of `DBGDTRRXext` or external write of `DBGDTRTXext` when checking the flags to determine whether to stall the access.

Explicit synchronization is required to guarantee that a direct read of `DBGDSCRint` returns up-to-date DCC flags. This means that if a signal is received from another agent that indicates that `DBGDSCRint` must be read, an ISB is required to ensure that the read of `DBGDSCRint` occurs after the signal has been received. This will also synchronize the value in `DBGDTRRXint`, if applicable. However, if that signal is an interrupt triggered by `COMMTX` or `COMMRX`, the exception entry is sufficient synchronization. For more information, see [Synchronization of DCC interrupt request signals](#).

Explicit synchronization is required following a direct read or direct write:

- To guarantee that a value directly written to `DBGDTRTXint` is observable to external reads of `DBGDTRTXext`.
- To guarantee that the indirect writes to the DCC flags in the `DBGDSCR` caused as a side-effect of the direct read or direct write have occurred, and therefore that the updated values are:
  - Observable to external reads of `DBGDSCRext`.
  - If `DBGDSCR.ExtDCCmode` specifies Stall mode, observable to an external read of `DBGDTRRXext` or an external write of `DBGDTRTXext` when checking the flags to determine whether to stall the access.
  - Returned by a following direct read of `DBGDSCRint`.

See also [Synchronization requirements for memory-mapped register interfaces on page C6-2115](#).

———— **Note** —————

These ordering rules mean that software:

- Must not read `DBGDTRRXint` without first checking `DBGDSCRint.RXfull`, or if the previously-read value of `DBGDSCRint.RXfull` is 0.  
It is not sufficient to read both registers and then later decide whether to discard the read value, as there might be an intervening write from the external debug or memory-mapped interfaces.
- Must not write `DBGDTRTXint` without first checking `DBGDSCRint.TXfull`, or if the previously-read value of `DBGDSCRint.TXfull` is 1.  
When the previous read value of `DBGDSCRint.TXfull` is 1, a write to `DBGDTRTXint` overwrites the value in `DBGDTRTX`, and the external debugger might or might not have read this value.
- Must ensure there is an explicit context synchronization operation following a DTR access, even if not immediately returning to read `DBGDSCRint` again. This synchronization operation can be an exception return.

## C8.4.2 Synchronization of DCC interrupt request signals

Following an external read or external write access to the `DBGDTRTX` or `DBGDTRRX`, the interrupt request signals, `COMMTX` and `COMMRX`, must be updated in finite time without explicit synchronization.

Also, the updated values must be observable to a direct read or direct write of `DBGDSCRint`, `DBGDTRTXint`, or `DBGDTRRXint` performed after the taking of an exception generated by the interrupt request.

After a direct read of `DBGDTRRXint` or a direct write of `DBGDTRTXint`, software must execute a context synchronization operation to ensure the interrupt request signals are updated. This synchronization operation can be an exception return.

### C8.4.3 DCC and ITR accesses in Debug state

In Debug state, more strict observability rules apply for instructions issued through **DBGITR**, to maintain communication between a debugger and the processor debug logic without requiring excessive explicit synchronization.

This means that, in Debug state:

- A direct read of **DBGDTRRXint** or a direct write of **DBGDTRTXint** by an instruction written to **DBGITR** must be observable to external reads and external writes, without explicit synchronization, in finite time. The effects that must be visible include both the effect of the direct access made by the instruction and the indirect write to the DCC flags in the **DBGDSCR**.

This means that:

- In Stall mode or Fast mode, a subsequent external read of **DBGDTRTXext** or external write of **DBGDTRRXext** will not stall indefinitely waiting for the appropriate **DBGDSCR** flag to be updated.
- In Non-blocking mode, an external debugger must check the InstrCompl\_1 and DCC flags in **DBGDSCRext** before accessing **DBGDTRTXext** or **DBGDTRRXext**.
- Successful external reads and external writes to **DBGDTRRX** or **DBGDTRTX** must be observable to an instruction subsequently written to **DBGITR**. This includes the update to the DCC flags in the **DBGDSCR**.  
This means that if the instruction is a direct read of **DBGDTRRXint** or a direct write of **DBGDTRTXint**, it observes the external write or external read without explicit synchronization and without the need to first check the DCC flags in **DBGDSCRint**.
- On completion of a successful write to **DBGITR** in Non-blocking or Stall mode, the instruction written is executed immediately without explicit synchronization. The order of external writes to **DBGITR** creates a simple sequential execution model order for the instructions.

In Fast mode, these requirements apply to the instructions latched in **DBGITR** and issued on external reads of **DBGDTRTXext** and external writes of **DBGDTRRXext**.





# Chapter C9

## Non-invasive Debug Authentication

This chapter describes the authentication controls on non-invasive debug operations. It contains the following sections:

- [About non-invasive debug authentication on page C9-2182](#)
- [Non-invasive debug authentication on page C9-2183](#)
- [Effects of non-invasive debug authentication on page C9-2185.](#)

———— **Note** —————

The recommended external debug interface provides an authentication interface that controls both invasive debug and non-invasive debug, as described in [Authentication signals on page AppxA-2338](#). This chapter describes how a system can use this interface to control non-invasive debug. For information about using the interface to control invasive debug see [Chapter C2 Invasive Debug Authentication](#).

---

## C9.1 About non-invasive debug authentication

A debugger can use the external debug interface to enable or disable Non-invasive debug. In addition, if an implementation includes the Security Extensions, signals control whether non-invasive debug operations are permitted or not permitted.

The difference between enabled and permitted is that the permitted non-invasive debug operations depend on both the processor mode and the security state. The alternatives for when non-invasive debug is permitted are:

- in all processor modes, in both Secure and Non-secure security states
- only in Non-secure state
- in Non-secure state and in Secure User mode.

Whether non-invasive debug operations are permitted in Secure User mode depends on the value of the [SDER.SUNIDEN](#) bit.

Non-invasive debug authentication can be controlled dynamically, meaning that whether non-invasive debug is permitted can change while the processor is running, or while the processor is in Debug state. For more information, see [Generation of debug events on page C3-2074](#).

In the recommended external debug interface, the signals that control the enabling and permitting of non-invasive debug are **DBGEN**, **SPIDEN**, **NIDEN** and **SPNIDEN**, see [Authentication signals on page AppxA-2338](#). **SPIDEN** and **SPNIDEN** are only implemented on processors that implement Security Extensions.

Part C of this manual assumes that the recommended external debug interface is implemented.

---

### Note

- **DBGEN** and **SPIDEN** also control invasive debug, see [About invasive debug authentication on page C2-2028](#).
- For more information about use of the authentication signals see [Changing the authentication signals on page AppxA-2338](#).

---

If the implementation includes the recommended external debug interface, when both **DBGEN** and **NIDEN** are LOW, no non-invasive debug is permitted.

[Non-invasive debug authentication on page C9-2183](#) describes non-invasive debug authentication.

The following sections describe the behavior of the non-invasive debug components when non-invasive debug is not enabled or not permitted. These sections also describe the behavior when the processor is in Debug state:

- [Trace on page C9-2185](#)
- [Reads of the Program Counter Sampling Register on page C10-2189](#)
- [Chapter C12 The Performance Monitors Extension](#).

Also see [Invasive debug authentication security considerations on page C2-2033](#) for details on how a developer can protect Secure processing from direct observation or invasion by a debugger that they do not trust.

## C9.2 Non-invasive debug authentication

This section describes non-invasive debug authentication on a processor that implements the recommended external debug interface.

On processors that do not implement Security Extensions, if **NIDEN** is asserted HIGH, non-invasive debug is enabled and permitted in all modes.

If **DBGEN** is asserted HIGH the system behaves as if **NIDEN** is asserted HIGH, regardless of the actual state of the **NIDEN** signal.

[Table C9-1](#) shows the required behavior when the implementation does not include the Security Extensions.

**Table C9-1 Non-invasive debug authentication, no Security Extensions**

<b>DBGEN</b>	<b>NIDEN</b>	<b>Modes in which non-invasive debug is permitted</b>
LOW	LOW	None. Non-invasive debug is disabled.
x	HIGH	All modes.
HIGH	LOW	All modes.

On a processor that implements the Security Extensions:

- If both **NIDEN** and **SPNIDEN** are asserted HIGH, non-invasive debug is enabled and permitted in all modes and security states.
- If **NIDEN** is HIGH and **SPNIDEN** is LOW:
  - non-invasive debug is enabled and permitted in Non-secure state
  - non-invasive debug is not permitted in Secure PL1 modes
  - whether non-invasive debug is permitted in Secure User mode depends on the value of the [SDER.SUNIDEN](#) bit.

If **DBGEN** is HIGH, the system behaves as if **NIDEN** is HIGH, regardless of the actual state of the **NIDEN** signal

If **SPIDEN** is HIGH, the system behaves as if **SPNIDEN** is HIGH, regardless of the actual state of the **SPNIDEN** signal.

[Table C9-2 on page C9-2184](#) shows the required behavior when the implementation includes the Security Extensions.

**Table C9-2 v7 Debug non-invasive debug authentication, with Security Extensions**

DBGEN	Signals			SDER.SUNIDEN	Modes in which non-invasive debug is permitted
	NIDEN	SPIDEN	SPNIDEN		
LOW	LOW	x	x	x	None. Non-invasive debug is disabled.
LOW	HIGH	LOW	LOW	0	All modes in Non-secure state
LOW	HIGH	LOW	LOW	1	All modes in Non-secure state, Secure User mode.
LOW	HIGH	LOW	HIGH	x	All modes in both security states.
LOW	HIGH	HIGH	x	x	All modes in both security states.
HIGH	x	LOW	LOW	0	All modes in Non-secure state.
HIGH	x	LOW	LOW	1	All modes in Non-secure state, Secure User mode.
HIGH	x	LOW	HIGH	x	All modes in both security states.
HIGH	x	HIGH	x	x	All modes in both security states.

———— **Note** —————

The value of the [SDER.SUNIDEN](#) bit does not have any effect on non-invasive debug.

## C9.3 Effects of non-invasive debug authentication

The following sections describe the effects of the non-invasive debug authentication on the non-invasive debug components:

- [Trace](#)
- [Reads of the Program Counter Sampling Register on page C10-2189](#)
- [Effects of non-invasive debug authentication on the Performance Monitors on page C12-2302.](#)

### C9.3.1 Trace

All instructions and data transfers are ignored by the trace device when:

- non-invasive debug is disabled
- the processor is in a mode or state where non-invasive debug is not permitted
- the processor is in Debug state.

For more information see the *Embedded Trace Macrocell Architecture Specification* and the *CoreSight Program Flow Trace Architecture Specification*.



# Chapter C10

## Sample-based Profiling

This chapter describes sample-based profiling, that is an OPTIONAL non-invasive debug component. It contains the following section:

- [Sample-based profiling on page C10-2188.](#)

## C10.1 Sample-based profiling

In both v7 Debug and v7.1 Debug, Sample-based profiling is an OPTIONAL extension to the debug architecture. It provides a mechanism for coarse-grained profiling of software executing on the processor, without changing the behavior of that software. The following sections describe this extension:

- [The implemented Sample-based profiling registers](#)
- [Reads of the Program Counter Sampling Register on page C10-2189](#)

### C10.1.1 The implemented Sample-based profiling registers

In an implementation that includes the Sample-based profiling extension, the register requirements depend on the debug architecture version, as described in:

- [Sample-based profiling registers in a v7 Debug implementation](#)
- [Sample-based profiling registers in a v7.1 Debug implementation on page C10-2189.](#)

[Determining which registers are implemented on page C10-2189](#) describes how software can determine whether an implementation supports Sample-based profiling, and if so, how the extension is implemented.

#### Sample-based profiling registers in a v7 Debug implementation

A v7 Debug implementation that includes the Sample-based profiling extension must implement the *Program Counter Sampling Register*, [DBGPCSR](#). It is IMPLEMENTATION DEFINED whether the *Context ID Sampling Register*, [DBGCIDS](#)R is implemented.

———— **Note** —————

A v7 Debug implementation that does not include the Sample-based profiling extension cannot implement [DBGPCSR](#), [DBGCIDS](#)R, or [DBGVIDSR](#).

If the [DBGCIDS](#)R is implemented and the implementation includes the Security Extensions, it is IMPLEMENTATION DEFINED whether the *Virtualization ID Sampling Register*, [DBGVIDSR](#), is implemented. Despite its name, in v7 Debug, this register only provides a Non-secure state sample bit. If an implementation includes only [DBGPCSR](#), it is IMPLEMENTATION DEFINED whether it is implemented as register 33, as register 40, or as both register 33 and register 40.

If a implementation includes [DBGPCSR](#) as both register 33 and register 40, the two register numbers are aliases of a single register. ARM deprecates reading [DBGPCSR](#) as register 33 on an implementation that also implements it as register 40.

If an implementation includes both [DBGPCSR](#) and [DBGCIDS](#)R:

- it must implement:
  - [DBGPCSR](#) as register 40
  - [DBGCIDS](#)R as register 41
- it is IMPLEMENTATION DEFINED whether it also implements [DBGPCSR](#) as register 33.

If an implementation includes [DBGPCSR](#), [DBGCIDS](#)R and [DBGVIDSR](#):

- it must implement:
  - [DBGPCSR](#) as register 40
  - [DBGCIDS](#)R as register 41
  - [DBGVIDSR](#) as register 42
- it is IMPLEMENTATION DEFINED whether it also implements [DBGPCSR](#) as register 33.



———— **Note** ————

ARM recommends that a v7 Debug implementation that includes the Sample-based profiling extension:

- implements both [DBGPCSR](#) and [DBGCIDSR](#)
- implements [DBGPCSR](#) as register 40
- in an implementation that includes the Security Extensions, implements [DBGVIDSR](#)
- also implements [DBGPCSR](#) as register 33, for backwards compatibility with implementations that implement it only as register 33.

### Sample-based profiling registers in a v7.1 Debug implementation

A v7 Debug implementation that includes the Sample-based profiling extension must implement the registers as follows:

- [DBGPCSR](#) as register 40. It is IMPLEMENTATION DEFINED if the register is also implemented as register 33.
- [DBGCIDSR](#) as register 41.
- If the implementation includes the Security Extensions, [DBGVIDSR](#) as register 42.

### Determining which registers are implemented

To determine which, if any, of the Sample-based profiling registers are implemented, and the register numbers used for any implemented registers, software can:

1. Read [DBGDIDR.PCSR\\_imp](#), to determine whether [DBGPCSR](#) is implemented as register 33.
2. Read [DBGDIDR.DEVID\\_imp](#), to determine whether [DBGDEVID](#) is implemented.

———— **Note** ————

[DBGDEVID](#) must be implemented by:

- any v7 Debug implementation that implements [DBGPCSR](#) as register 40
- all v7.1 Debug implementations.

3. If [DBGDEVID](#) is implemented, read [DBGDEVID.PCsample](#) to determine:
  - whether [DBGPCSR](#) is implemented as register 40
  - whether either, or both, of [DBGCIDSR](#) and [DBGVIDSR](#) are implemented.

## C10.1.2 Reads of the Program Counter Sampling Register

A read of the [DBGPCSR](#) normally:

- Returns a value that indicates the address of an instruction *recently executed* by the processor.  
If the processor is in Jazelle state, the significance of the value returned is IMPLEMENTATION DEFINED.
- Sets the [DBGCIDSR](#), if implemented, to the current value of the [CONTEXTIDR](#).
- Sets the [DBGVIDSR](#), if implemented, to contain:
  - the security state associated with the [DBGPCSR](#) sample
  - in an implementation that includes the Virtualization Extensions, the Hyp mode status and VMID of the most recent [DBGPCSR](#) sample.

Alternatively, when any of the following is true, and the processor is not in reset state, a read of [DBGPCSR](#) returns 0xFFFFFFFF and sets the [DBGCIDSR](#) and [DBGVIDSR](#), if implemented, to an UNKNOWN value:

- non-invasive debug is disabled
- the processor is in a mode or state where non-invasive debug is not permitted
- the processor is in Debug state.

If the processor is in reset state, a read of **DBGPCSR** returns an UNKNOWN value, and makes the values of **DBGCIDSR** and **DBGVIDSR**, if implemented, UNKNOWN. See *Reset state* on page C11-2285.

If the **DBGCIDSR** is implemented, and has not been made UNKNOWN by a read of **DBGPCSR**, reading it returns the last value to which it was set.

If the **DBGVIDSR** is implemented, and has not been made UNKNOWN by a read of **DBGPCSR**, reading it returns the last value to which it was set.

———— **Note** —————

The ARM architecture does not define *recently executed*. The delay between an instruction being executed by the processor and its address appearing in the **DBGPCSR** is not defined. For example, if a piece of software reads the **DBGPCSR** of the processor it is running on, there is no guaranteed relationship between the program counter value corresponding to that piece of software and the value read. The **DBGPCSR** is intended only for use by an external agent to provide statistical information for software profiling.

The value in the **DBGPCSR** always references a committed instruction. An implementation must not sample values that reference instructions that are fetched but not committed for execution.

If **DBGPCSR** is implemented, it must be possible to sample references to branch targets. It is IMPLEMENTATION DEFINED whether references to other instructions can be sampled. ARM recommends that a reference to any instruction can be sampled.

The branch target for a conditional branch instruction that fails its condition code check is the instruction that follows the conditional branch instruction. The branch target for an exception is the exception vector address.

If an instruction writes to the **CONTEXTIDR**, it is UNPREDICTABLE whether the **DBGCIDSR** is set to the original or new value of **CONTEXTIDR** if a read of the **DBGPCSR** samples an instruction that occurs after the write to the **CONTEXTIDR** but before the next context synchronization operation.

If an instruction writes to **VTTBR.VMID**, it is UNPREDICTABLE whether the **DBGVIDSR** is set to the original or new value of the VMID if a read of the **DBGPCSR** samples an instruction that occurs after the write to **VTTBR.VMID** but before the next context synchronization operation.

# Chapter C11

## The Debug Registers

This chapter describes the debug registers. It contains the following sections:

- *About the debug registers* on page C11-2192
- *Debug register summary* on page C11-2193
- *Debug identification registers* on page C11-2196
- *Control and status registers* on page C11-2197
- *Instruction and data transfer registers* on page C11-2198
- *Software debug event registers* on page C11-2199
- *Sample-based profiling registers* on page C11-2200
- *OS Save and Restore registers* on page C11-2201
- *Memory system control registers* on page C11-2202
- *Management registers* on page C11-2203.
- *Register descriptions, in register order* on page C11-2209.

## C11.1 About the debug registers

[Chapter C6 Debug Register Interfaces](#) describes the interfaces to the debug registers.

The debug registers are numbered sequentially from 0 to 1023. Registers 832-1023 are the *management registers*.

Debug register offsets, given in this chapter and elsewhere, refer to the offsets in the v7 Debug memory-mapped or external debug interface. The offset of a register is four times its register number.

There is a standard mapping from debug register number to coprocessor instructions in the CP14 interface, see [Using CP14 to access debug registers on page C6-2121](#).

———— **Note** —————

The [ARM Debug Interface v5 Architecture Specification](#) describes the recommended external debug interface.

### C11.1.1 Effect of the Security Extensions on the debug registers

In an implementation that includes the Security Extensions, all debug registers are Common registers, meaning they are common to the Secure and Non-secure states. For more information, see [Common system control registers on page B3-1457](#).

### C11.1.2 Registers that are not visible in a particular interface

Some debug registers, when implemented, are not visible in one or more of the debug register interfaces. The register descriptions identify these registers. See:

- [v7 Debug register visibility in the different interfaces on page C6-2128](#)
- [v7.1 Debug register visibility in the different interfaces on page C6-2137](#).

### C11.1.3 Registers that are IMPLEMENTATION DEFINED

Some debug registers, or access to the registers, are IMPLEMENTATION DEFINED. The register descriptions identify these registers.

## C11.2 Debug register summary

This manual describes the debug registers in functional groups. [Table C11-1](#) shows all of the debug registers in register number order, and the group for each register.

Except where indicated, debug registers are 32-bits wide. The Large Physical Address Extension introduces some 64-bit registers. The register summaries, and the individual register descriptions, identify these 64-bit registers.

The register descriptions are then organized in functional groups. The register group summaries list the registers in name order, so that different views or alternative implementations of the same register are grouped together, and show:

- The register name.
- The register number. If the register is not visible in the CP14 interface, or if ARM deprecates accessing the register through the CP14 interface, the register number is shown in brackets.
- The offset value, given only for a registers that is visible in the memory-mapped interface.

———— **Note** —————

A register offset is  $4 \times (\text{register number})$ .

- The default access to the register, in the *Type* column. The access can change in different interfaces and also depends on various processor states and locks. For more information see [Summary of the v7 Debug register interfaces on page C6-2128](#) and [Summary of the v7.1 Debug register interfaces on page C6-2137](#).

In addition:

- In the register diagrams, the properties of fixed bits as described in:
  - for a VMSA implementation, [Meaning of fixed bit values in register diagrams on page B3-1466](#)
  - for a PMSA implementation, [Meaning of fixed bit values in register diagrams on page B5-1783](#).
- If a register is not visible in a particular debug register interface, any corresponding register number or memory word is reserved in that interface, see [Registers that are not visible in a particular interface on page C11-2192](#).

**Table C11-1 Debug registers summary**

Register number	Name	Description	Register group
0	<a href="#">DBGDIDR</a>	Debug ID	<a href="#">Debug identification registers on page C11-2196</a>
1	<a href="#">DBGDSCR</a> internal view	Debug Status and Control	<a href="#">Control and status registers on page C11-2197</a>
2-4	-		Reserved.
5	<a href="#">DBGDTRRX</a> internal view <a href="#">DBGDTRTX</a> internal view	Host to Target Data Transfer Target to Host Data Transfer	<a href="#">Instruction and data transfer registers on page C11-2198</a>
6	<a href="#">DBGWFAR</a>	Watchpoint Fault Address	<a href="#">Control and status registers on page C11-2197</a>
7	<a href="#">DBGVCR</a>	Vector Catch	<a href="#">Software debug event registers on page C11-2199</a>
8	-	-	Reserved.
9	<a href="#">DBGECR</a>	Event Catch	<a href="#">OS Save and Restore registers on page C11-2201</a>
10	<a href="#">DBGDSCCR</a>	Debug State Cache Control	<a href="#">Memory system control registers on page C11-2202</a>
11	<a href="#">DBGDSMCR</a>	Debug State MMU Control	
12-31	-	-	Reserved.

**Table C11-1 Debug registers summary (continued)**

Register number	Name	Description	Register group
32	DBGDTRRX external view	Host to Target Data Transfer	<i>Instruction and data transfer registers on page C11-2198</i>
33	DBGITR	Instruction Transfer	
	DBGPCSR	Program Counter Sampling	<i>Sample-based profiling registers on page C11-2200</i>
34	DBGDSCR external view	Debug Status and Control	<i>Control and status registers on page C11-2197</i>
35	DBGDTRTX external view	Target to Host Data Transfer	<i>Instruction and data transfer registers on page C11-2198</i>
36	DBGDRCR	Debug Run Control	<i>Control and status registers on page C11-2197</i>
37	DBGEACR	Debug External Auxiliary Control	
38-39	-	-	Reserved.
40	DBGPCSR	Program Counter Sampling	<i>Sample-based profiling registers on page C11-2200</i>
41	DBGCIDSR	Context ID Sampling	
42	DBGVIDSR	Virtualization ID Sampling	
43-63	-	-	Reserved.
64-79	DBGBVR	Breakpoint Value	<i>Software debug event registers on page C11-2199</i>
80-95	DBGBCR	Breakpoint Control	
96-111	DBGWVR	Watchpoint Value	
112-127	DBGWCR	Watchpoint Control	
128	DBGDRAR	Debug ROM Address	<i>Debug identification registers on page C11-2196</i>
129-143	-	-	Reserved.
144-159	DBGBXVR	Breakpoint Extended Value	<i>Software debug event registers on page C11-2199</i>
160-191	-	-	Reserved.
192	DBGOSLAR	OS Lock Access	<i>OS Save and Restore registers on page C11-2201</i>
193	DBGOSLSR	OS Lock Status	
194	DBGOSSRR	OS Save and Restore	
195	DBGOSDLR	OS Double Lock	
196	DBGPRCR	Device Powerdown and Reset Control	<i>Control and status registers on page C11-2197</i>
197	DBGPRSR	Device Powerdown and Reset Status	
198-255	-	-	Reserved.
256	DBGDSAR	Debug Self Address Offset	<i>Debug identification registers on page C11-2196</i>
257-511	-	-	Reserved.

**Table C11-1 Debug registers summary (continued)**

Register number	Name	Description	Register group
512-575	-	-	IMPLEMENTATION DEFINED.
576-831	-	-	Reserved.
832-895	Processor ID registers	-	<i>Processor identification registers on page C11-2203</i>
896-927	-	-	Reserved.
928-959	-	-	Integration registers <sup>a</sup>
960	<a href="#">DBGITCTRL</a>	Integration Mode Control	<i>Other Debug management registers on page C11-2205</i>
961-999	-	-	Reserved
1000	<a href="#">DBGCLAIMSET</a>	Claim Tag Set	<i>Other Debug management registers on page C11-2205</i>
1001	<a href="#">DBGCLAIMCLR</a>	Claim Tag Clear	
1002-1003	-	-	Reserved.
1004	<a href="#">DBGLAR</a>	Lock Access	<i>Other Debug management registers on page C11-2205</i>
1005	<a href="#">DBGLSR</a>	Lock Status	
1006	<a href="#">DBGAUTHSTATUS</a>	Authentication Status	
1007	-	-	Reserved.
1008	<a href="#">DBGDEVID2</a>	Debug Device ID 2	<i>Debug identification registers on page C11-2196</i>
1009	<a href="#">DBGDEVID1</a>	Debug Device ID 1	
1010	<a href="#">DBGDEVID</a>	Debug Device ID	
1011	<a href="#">DBGDEVTYPE</a>	Device Type	<i>Other Debug management registers on page C11-2205</i>
1012-1019	<a href="#">DBGPID0 - DBGPID4</a>	Peripheral ID	
1020-1023	<a href="#">DBGCID0 - DBGCID3</a>	Component ID	

a. IMPLEMENTATION DEFINED integration registers. See the *CoreSight Architecture Specification* for more information.

## C11.3 Debug identification registers

This section describes the Debug identification registers.

### C11.3.1 About the Debug identification registers

Table C11-2 shows the Debug identification registers, in name order, and their attributes.

**Table C11-2 Debug identification registers**

Name	Register number	Offset	Type	Description
<a href="#">DBGDEVID</a>	1010	0xFC8	RO	<a href="#">DBGDEVID</a> , Debug Device ID register on page C11-2224.
<a href="#">DBGDEVID1</a>	1009	0xFC4	RO	<a href="#">DBGDEVID1</a> , Debug Device ID register 1 on page C11-2227. In v7 Debug, it is IMPLEMENTATION DEFINED whether this register is implemented, or is UNK/SBZP.
<a href="#">DBGDEVID2</a>	1008	0xFC0	RO	In v7 Debug, this register is reserved. In v7.1 Debug, this register is implemented but is for future use, so is RAZ.
<a href="#">DBGDIDR</a>	0	0x000	RO	<a href="#">DBGDIDR</a> , Debug ID Register on page C11-2229.
<a href="#">DBGDRAR</a>	128	-	RO	<a href="#">DBGDRAR</a> , Debug ROM Address Register on page C11-2232.
<a href="#">DBGDSAR</a>	256	-	RO	<a href="#">DBGDSAR</a> , Debug Self Address Offset Register on page C11-2237.



## C11.4 Control and status registers

This section describes the Debug control and status registers.

### C11.4.1 About the Debug control and status registers

Table C11-3 shows the Debug control and status registers, in name order, and their attributes. A register number in brackets, for example (36), indicates that, in a v7.1 Debug implementation, the register is not visible in the CP14 interface, see *v7.1 Debug register visibility in the different interfaces* on page C6-2137.

———— **Note** —————

For information about debug register visibility in a v7 Debug implementation, see *v7 Debug register visibility in the different interfaces* on page C6-2128.

**Table C11-3 Debug control and status registers**

Name	Register number	Offset	Type	Description	Note
<a href="#">DBGDRCR</a>	(36)	0x090	WO	<a href="#">DBGDRCR, Debug Run Control Register</a> on page C11-2234	-
<a href="#">DBGDSCR<sub>ext</sub></a>	34	0x088	RW	<a href="#">DBGDSCR, Debug Status and Control Register</a> on page C11-2241	-
<a href="#">DBGDSCR<sub>int</sub></a>	1	-	RO		
<a href="#">DBGEACR</a>	(37)	0x094	RW	<a href="#">DBGEACR, External Auxiliary Control Register</a> on page C11-2261	v7.1 Debug only
<a href="#">DBGPRCR</a>	196	0x310	RW	<a href="#">DBGPRCR, Device Powerdown and Reset Control Register</a> on page C11-2278	-
<a href="#">DBGPRSR</a>	(197)	0x314	RO	<a href="#">DBGPRSR, Device Powerdown and Reset Status Register</a> on page C11-2282	-
<a href="#">DBGWFAR</a>	6	0x018	RW	<a href="#">DBGWFAR, Watchpoint Fault Address Register</a> on page C11-2296	-

## C11.5 Instruction and data transfer registers

This section describes the registers that are can transfer data between an external debugger and the ARM processor.

### C11.5.1 About the Debug instruction transfer and data transfer registers

Table C11-4 shows the Debug instruction transfer and data transfer registers, in name order, and their attributes. A register number in brackets, for example (33), indicates that, in a v7.1 Debug implementation, the register is not visible in the CP14 interface, see *v7.1 Debug register visibility in the different interfaces* on page C6-2137.

———— **Note** —————

For information about debug register visibility in a v7 Debug implementation, see *v7 Debug register visibility in the different interfaces* on page C6-2128.

**Table C11-4 Debug instruction transfer and data transfer registers**

Name	Register number	Offset	Type	Description
DBGDTRRX internal view	5	-	RO	<a href="#">DBGDTRRX, Host to Target Data Transfer register on page C11-2259</a>
DBGDTRRX external view	32	0x080	RW	
DBGDTRTX internal view	5	-	WO	<a href="#">DBGDTRTX, Target to Host Data Transfer register on page C11-2260</a>
DBGDTRTX external view	35	0x08C	RW	
DBGITR	(33)	0x084	WO	<a href="#">DBGITR, Instruction Transfer Register on page C11-2263</a>

The [DBGDTRRX](#) and [DBGDTRTX](#) Registers, and some status bits in the [DBGDSCR](#), form the Debug Communications Channel, see *DCC overview* on page C8-2164.

## C11.6 Software debug event registers

This section describes the Software debug event registers:

### C11.6.1 About the Software debug event registers

Table C11-5 shows the Software debug event registers, in name order, and their attributes.

**Table C11-5 Software debug event registers**

Name	Register number	Offset	Type	Description	Note
<a href="#">DBGBCR</a>	80-95	0x140-0x17C	RW	<a href="#">DBGBCR, Breakpoint Control Registers on page C11-2211</a>	-
<a href="#">DBGBVR</a>	64-79	0x100-0x13C	RW	<a href="#">DBGBVR, Breakpoint Value Registers on page C11-2216</a>	-
<a href="#">DBGVCR</a>	7	0x01C	RW	<a href="#">DBGVCR, Vector Catch Register on page C11-2286</a>	-
<a href="#">DBGWCR</a>	112-127	0x1C0-0x1FC	RW	<a href="#">DBGWCR, Watchpoint Control Registers on page C11-2291</a>	-
<a href="#">DBGWVR</a>	96-111	0x180-0x1BC	RW	<a href="#">DBGWVR, Watchpoint Value Registers on page C11-2297</a>	-
<a href="#">DBGBXVR</a>	144-159	0x240-0x27C	RW	<a href="#">DBGBXVR, Breakpoint Extended Value Registers on page C11-2217</a>	Virtualization extensions only

In addition to the registers shown in Table C11-5, a debugger can use the [DBGECR](#) to enable generation of a Halting debug event when the OS Lock is cleared, see [DBGECR, Event Catch Register on page C11-2261](#). In v7 Debug this is only available if the OS Save and Restore mechanism is implemented.

## C11.7 Sample-based profiling registers

This section describes the sample-based profiling registers.

### C11.7.1 About the sample-based profiling registers

Table C11-6 shows the sample-based profiling registers, in name order, and their attributes. A register number in brackets, for example (41), indicates that, in a v7.1 Debug implementation, the register is not visible in the CP14 interface, see [v7.1 Debug register visibility in the different interfaces on page C6-2137](#).

———— **Note** —————

For information about debug register visibility in a v7 Debug implementation, see [v7 Debug register visibility in the different interfaces on page C6-2128](#).

**Table C11-6 Sample-based profiling registers**

Name	Register number	Offset	Type	Description
DBGCIDSR	(41)	0x0A4	RO	<a href="#">DBGCIDSR, Context ID Sampling Register on page C11-2221</a>
DBGPCSR	(33)	0x084	RO	<a href="#">DBGPCSR, Program Counter Sampling Register on page C11-2271</a>
	(40)	0x0A0		
DBGVIDSR	(42)	0x0A8	RO	<a href="#">DBGVIDSR, Virtualization ID Sampling Register on page C11-2289</a>

## C11.8 OS Save and Restore registers

Any implementation that does not support the OS Save and Restore mechanism must implement the [DBGOSLSR](#) with [DBGOSLSR.OSLM](#) as RAZ.

In v7 Debug, if an implementation supports external debug over powerdown, then it must implement the OS Save and Restore mechanism registers. On SinglePower systems, and on any other system that does not support external debug over powerdown, it is IMPLEMENTATION DEFINED whether the OS Save and Restore mechanism is implemented.

In v7.1 Debug, the required OS Save and Restore registers must be implemented, even in SinglePower systems.

———— **Note** —————

[DBGOSSRR](#) is a v7 Debug only register.

The OS Save and Restore mechanism includes the OS Unlock catch debug event, controlled by the [DBGECR](#).

### C11.8.1 About the OS Save and Restore registers

[Table C11-5 on page C11-2199](#) shows the OS Save and Restore registers, in name order, and their attributes. A register number in brackets, for example (9), indicates that, in a v7.1 Debug implementation, the register is not visible in the CP14 interface, see [v7.1 Debug register visibility in the different interfaces on page C6-2137](#).

———— **Note** —————

For information about debug register visibility in a v7 Debug implementation, see [v7 Debug register visibility in the different interfaces on page C6-2128](#).

**Table C11-7 OS Save and Restore registers**

Name	Register number	Offset	Type	Description	Note
<a href="#">DBGECR</a>	(9)	0x024	RW	<a href="#">DBGECR, Event Catch Register on page C11-2261</a>	-
<a href="#">DBGOSDLR</a>	195	0x30C	RW	<a href="#">DBGOSDLR, OS Double Lock Register on page C11-2266</a>	v7.1 Debug only
<a href="#">DBGOSLAR</a>	192	0x300	WO	<a href="#">DBGOSLAR, OS Lock Access Register on page C11-2267</a>	-
<a href="#">DBGOSLSR</a>	193	0x304	RO	<a href="#">DBGOSLSR, OS Lock Status Register on page C11-2268</a>	-
<a href="#">DBGOSSRR</a>	194	0x308	RW	<a href="#">DBGOSSRR, OS Save and Restore Register on page C11-2270</a>	v7 Debug only

## C11.9 Memory system control registers

This section describes the Memory system control registers. Some processor implementations include a Cache Behavior Override Register, CBOR, in an IMPLEMENTATION DEFINED region of the CP15 register space, see [Cache and TCM lockdown registers, VMSA on page B4-1750](#). The functions of the CBOR overlap with those of the Memory system control registers.

In v7.1 Debug, the Memory system control registers are not implemented.

### C11.9.1 About the Debug memory system control registers

Table C11-8 shows the Debug memory system control registers, and their attributes:

**Table C11-8 Debug memory system control registers**

Name	Register number	Offset	Type	Description	Note
<a href="#">DBGDSCCR</a>	10	0x028	RW	<a href="#">DBGDSCCR, Debug State Cache Control Register on page C11-2239</a>	v7 Debug only
<a href="#">DBGDSMCR</a>	11	0x02C	RW	<a href="#">DBGDSMCR, Debug State MMU Control Register on page C11-2257</a>	v7 Debug only

The [DBGDSCCR](#) and [DBGDSMCR](#) control cache and TLB behavior for memory operations issued by a debugger when the processor is in Debug state. A debugger can use these to request the minimum amount of intrusion to the processor caches that the implementation permits. It is IMPLEMENTATION DEFINED what levels of cache and TLB are controlled by these requests, and it is IMPLEMENTATION DEFINED to what extent the intrusion is limited.

The [DBGDSCCR](#) also provides a mechanism for a debugger to force writes to memory through to the point of coherency without the overhead of performing additional operations.

The [DBGDSCCR](#) and [DBGDSMCR](#) controls must apply for all memory operations issued in Debug state when [DBGDSCR.ADAdiscard](#), the Asynchronous Aborts Discarded bit, is set to 1. When this bit is set to 0, whether memory operations issued in Debug state are affected by the [DBGDSCCR](#) and [DBGDSMCR](#) is IMPLEMENTATION DEFINED.

## C11.10 Management registers

This section:

- Summarizes the Debug management registers. Some of these, the *processor identification registers*, are aliases of CP15 identification registers.
- Defines additional Debug management registers.

### ———— Note —————

The registers described in [Debug identification registers on page C11-2196](#) can also be considered as management registers, and some of them are in the management register space. For more information, see [Other Debug management registers on page C11-2205](#).

### C11.10.1 About the Debug management registers

This section summarizes the Debug management registers, registers 832-1023. The layout of these registers, complies with the *CoreSight Architecture Specification*. These registers are grouped as follows:

- registers 832-895, see [Processor identification registers](#)
- registers 896-1023, see [Other Debug management registers on page C11-2205](#).

#### Processor identification registers

The processor identification registers return the values stored in the Main ID and feature registers of the processor.

The processor identification registers are:

- Debug registers 832-895, at offsets 0xD00-0xDFC.
- Except for register 838, aliases of the CP15 processor identification registers.
- Read-only registers.
- In v7.1 Debug, not visible in the CP14 interface. Therefore, in [Table C11-9](#) their register numbers are shown in brackets.

### ———— Note —————

- For information about debug register visibility in a v7 Debug implementation, see [v7 Debug register visibility in the different interfaces on page C6-2128](#).
- If external debug over powerdown is supported, these registers can be implemented in either or both power domains.

[Table C11-9](#) lists the processor identification registers, in register name order. The register name entries are links to the register descriptions in [Chapter B4 System Control Registers in a VMSA implementation](#) and [Chapter B6 System Control Registers in a PMSA implementation](#).

**Table C11-9 Processor identification registers**

Register		Register number	Offset	Type <sup>a</sup>	Description
VMSA	PMSA				
<a href="#">CTR</a>	<a href="#">CTR</a>	(833)	0xD04	RO	Cache Type Register <sup>b</sup>
<a href="#">ID_AFR0</a>	<a href="#">ID_AFR0</a>	(843)	0xD2C	RO	Auxiliary Feature Register 0
<a href="#">ID_DFR0</a>	<a href="#">ID_DFR0</a>	(842)	0xD28	RO	Debug Feature Register 0
<a href="#">ID_ISAR0</a>	<a href="#">ID_ISAR0</a>	(848)	0xD40	RO	Instruction Set Attribute Register 0
<a href="#">ID_ISAR1</a>	<a href="#">ID_ISAR1</a>	(849)	0xD44	RO	Instruction Set Attribute Register 1

Table C11-9 Processor identification registers (continued)

Register		Register number	Offset	Type <sup>a</sup>	Description
VMSA	PMSA				
ID_ISAR2	ID_ISAR2	(850)	0xD48	RO	Instruction Set Attribute Register 2
ID_ISAR3	ID_ISAR3	(851)	0xD4C	RO	Instruction Set Attribute Register 3
ID_ISAR4	ID_ISAR4	(852)	0xD50	RO	Instruction Set Attribute Register 4
ID_ISAR5	ID_ISAR5	(853)	0xD54	RO	Instruction Set Attribute Register 5
ID_MMFR0	ID_MMFR0	(844)	0xD30	RO	Memory Model Feature Register 0
ID_MMFR1	ID_MMFR1	(845)	0xD34	RO	Memory Model Feature Register 1
ID_MMFR2	ID_MMFR2	(846)	0xD38	RO	Memory Model Feature Register 2
ID_MMFR3	ID_MMFR3	(847)	0xD3C	RO	Memory Model Feature Register 3
ID_PFR0	ID_PFR0	(840)	0xD20	RO	Processor Feature Register 0
ID_PFR1	ID_PFR1	(841)	0xD24	RO	Processor Feature Register 1
MIDR	MIDR	(832)	0xD00	RO	Main ID Register <sup>b</sup>
MPIDR	MPIDR	(837)	0xD14	RO	Multiprocessor Affinity Register <sup>b</sup>
Alias of MIDR	MPUIR	(836)	0xD10	RO	MPU Type Register <sup>b</sup>
TCMTR	TCMTR	(834)	0xD08	RO	TCM Type Register <sup>b</sup>
TLBTR	Alias of MIDR	(835)	0xD0C	RO	TLB Type Register <sup>b</sup>
REVIDR	REVIDR	(838)	0xD18	UNK	Revision ID Register <sup>c</sup>
Alias of MIDR	Alias of MIDR	(839)	0xD1C	RO	Alias of Main ID Register <sup>b</sup>
-	-	854-895	0xD58-0xDFC	-	Reserved

a. For more information, see [Access permissions on page C6-2117](#).

b. Except for the case described in footnote <sup>c</sup> when REVIDR is implemented, identification registers with register numbers 832-839 return the same value as a CP15 MRC instruction MRC p15, 0, <Rt>, c0, c0, <opc2>, where <opc2> = (register number - 832). In an implementation that includes the Virtualization Extensions, reads of these registers are not affected by the VPIDR or VMPIDR. That is, in Non-secure state, they return the register value that would be seen when reading the CP15 register from Hyp mode.

c. If REVIDR is not implemented this is a RO alias of the Main ID Register. However, when REVIDR is implemented, this register is UNK. The REVIDR value can be read only using the CP15 register access.

Some of these registers form part of the CPUID scheme and are described in [Chapter B7 The CPUID Identification Scheme](#). The other ARMv7 registers are described in either or both of:

- [Functional grouping of VMSAv7 system control registers on page B3-1491](#)
- [Functional grouping of PMSAv7 system control registers on page B5-1797](#).



## Other Debug management registers

Table C11-10 shows the other Debug management registers, in name order, and their attributes. A register number in brackets, for example (1020), indicates that, in a v7.1 Debug implementation, the register is not visible in the CP14 interface, see [v7.1 Debug register visibility in the different interfaces](#) on page C6-2137.

### ———— Note —————

For information about debug register visibility in a v7 Debug implementation, see [v7 Debug register visibility in the different interfaces](#) on page C6-2128.

These registers include the CoreSight Peripheral ID and Component ID registers. For more information see [About the Debug Peripheral Identification Registers](#) on page C11-2206 and [About the Debug Component Identification Registers](#) on page C11-2208. In addition, the DBGDEVID $n$  registers, described in [Debug identification registers](#) on page C11-2196, are in the CoreSight register address space and are included in Table C11-10, for completeness.

**Table C11-10 Debug management registers, other than the processor identification registers**

Name	Register number	Offset	Type	Description
DBGAUTHSTATUS	1006	0xFB8	RO	<a href="#">DBGAUTHSTATUS</a> , Authentication Status register on page C11-2209
DBGCID0	(1020)	0xFF0	RO	<a href="#">DBGCID0</a> , Debug Component ID Register 0 on page C11-2218
DBGCID1	(1021)	0xFF4	RO	<a href="#">DBGCID1</a> , Debug Component ID Register 1 on page C11-2219
DBGCID2	(1022)	0xFF8	RO	<a href="#">DBGCID2</a> , Debug Component ID Register 2 on page C11-2220
DBGCID3	(1023)	0xFFC	RO	<a href="#">DBGCID3</a> , Debug Component ID Register 3 on page C11-2220
DBGCLAIMCLR	1001	0xFA4	RW	<a href="#">DBGCLAIMCLR</a> , Claim Tag Clear register on page C11-2222
DBGCLAIMSET	1000	0xFA0	RW	<a href="#">DBGCLAIMSET</a> , Claim Tag Set register on page C11-2223
DBGDEVID	1010	0xFC8	RO	Debug Device ID registers, see <a href="#">Debug identification registers</a> on page C11-2196
DBGDEVID1	1009	0xFC4	RO	
DBGDEVID2	1008	0xFC0	RO	
DBGDEVTYPE	(1011)	0xFCC	RO	<a href="#">DBGDEVTYPE</a> , Device Type Register on page C11-2228
DBGITCTRL	960 <sup>a</sup>	0xF00	RW	<a href="#">DBGITCTRL</a> , Integration Mode Control register on page C11-2262
DBGLAR	(1004)	0xFB0	WO	<a href="#">DBGLAR</a> , Lock Access Register on page C11-2264
DBGLSR	(1005)	0xFB4	RO	<a href="#">DBGLSR</a> , Lock Status Register on page C11-2265
DBGPID0	(1016)	0xFE0	RO	<a href="#">DBGPID0</a> , Debug Peripheral ID Register 0 on page C11-2273
DBGPID1	(1017)	0xFE4	RO	<a href="#">DBGPID1</a> , Debug Peripheral ID Register 1 on page C11-2274
DBGPID2	(1018)	0xFE8	RO	<a href="#">DBGPID2</a> , Debug Peripheral ID Register 2 on page C11-2275
DBGPID3	(1019)	0xFEC	RO	<a href="#">DBGPID3</a> , Debug Peripheral ID Register 3 on page C11-2276
DBGPID4	(1012)	0xFD0	RO	<a href="#">DBGPID4</a> , Debug Peripheral ID Register 4 on page C11-2277

a. Visibility is IMPLEMENTATION DEFINED.

### C11.10.2 About the Debug Peripheral Identification Registers

The Debug Peripheral Identification Registers provide standard information required by all components that conform to the *ARM Debug Interface v5 Architecture Specification*, that implements the CoreSight identification scheme. They identify a peripheral in a particular namespace. See also the *CoreSight Architecture Specification*.

———— **Note** ————

- ARMv7 only defines Debug Peripheral ID Registers 0 to 4, and reserves space for Debug Peripheral ID Registers 5 to 7.
- The register offset order of the Debug Peripheral ID Registers does not match the numerical order ID0 to ID7, see [Table C11-11](#).

[Table C11-11](#) lists the Debug Peripheral Identification Registers in register offset order.

**Table C11-11 Debug Peripheral Identification Registers**

Register offset	Description	Reference
0xFD0	Debug Peripheral ID4	<a href="#">DBGPID4, Debug Peripheral ID Register 4 on page C11-2277</a>
0xFD4	Reserved for Debug Peripheral ID5, DBGPID5	-
0xFD8	Reserved for Debug Peripheral ID6, DBGPID6	-
0xFDC	Reserved for Debug Peripheral ID7, DBGPID7	-
0xFE0	Debug Peripheral ID0	<a href="#">DBGPID0, Debug Peripheral ID Register 0 on page C11-2273</a>
0xFE4	Debug Peripheral ID1	<a href="#">DBGPID1, Debug Peripheral ID Register 1 on page C11-2274</a>
0xFE8	Debug Peripheral ID2	<a href="#">DBGPID2, Debug Peripheral ID Register 2 on page C11-2275</a>
0xFEC	Debug Peripheral ID3	<a href="#">DBGPID3, Debug Peripheral ID Register 3 on page C11-2276</a>

Only bits[7:0] of each Debug Peripheral ID Register are used. This means that the bit assignments of each register are:

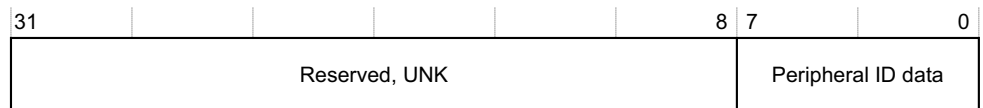

Software can consider the eight Debug Peripheral ID Registers as defining a single 64-bit Peripheral ID, as shown in [Figure C11-1](#).

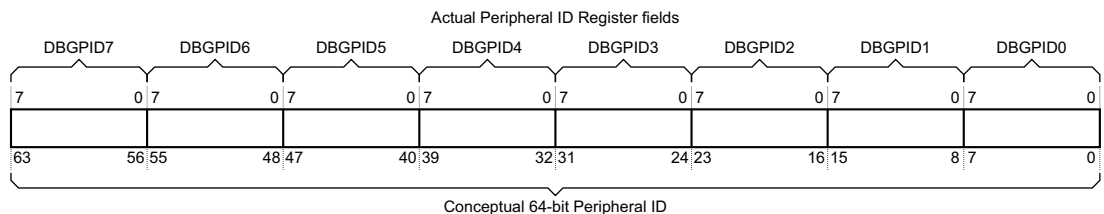
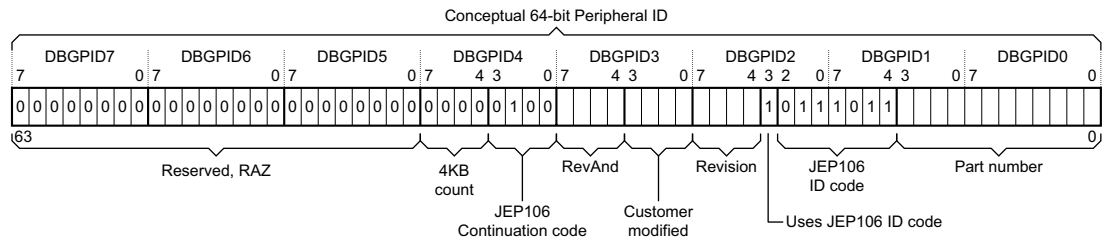

**Figure C11-1 Mapping between Debug Peripheral ID Registers and a 64-bit Peripheral ID value**

[Figure C11-2 on page C11-2207](#) shows the fields in the 64-bit Peripheral ID value, and includes the field values for fields that:

- have fixed values, including the bits that are reserved, RAZ
- have fixed values in an implementation that is designed by ARM.

For more information about the fields and their values see [Table C11-12](#).



**Figure C11-2 Peripheral ID fields, with values for a implementation designed by ARM**

[Table C11-12](#) shows the fields in the Peripheral ID.

**Table C11-12 Fields in the Debug Peripheral Identification Registers**

Name	Size	Description	Register
4KB count	4 bits	Log <sub>2</sub> of the number of 4KB blocks occupied by the implementation. In an ARMv7 implementation, the debug registers occupy a single 4KB block, so this field is always 0x0.	DBGPID4
JEP106 code	4+7 bits	Identifies the designer of the implementation. This value consists of: a 4-bit continuation code, also described as the bank number a 7-bit identification code.  For implementations designed by ARM, the continuation code is 0x4, indicating bank 5, and the identity code is 0x3B.  For more information, see <i>JEP106, Standard Manufacturers Identification Code</i> .	DBGPID1, DBGPID2, DBGPID4
RevAnd	4 bits	Manufacturing revision number. Indicates a late modification to the implementation, usually as a result of an <i>Engineering Change Order (ECO)</i> .  This field starts at 0x0 and is incremented by the integrated circuit manufacturer on metal fixes.	DBGPID3
Customer modified	4 bits	Indicates an endorsed modification to the implementation.  If the system designer cannot modify the implementation supplied by the implementation designer then this field is RAZ.	DBGPID3
Revision	4 bits	Revision number for the implementation.  Starts at 0x0 and increments by 1 at both major and minor revisions.	DBGPID2
Uses JEP106 ID code	1 bit	This bit is set to 1 when a JEP106 identification code is used.  This bit must be 1 on all ARMv7 implementations.	DBGPID2
Part number	12 bits	Part number for the implementation. Each organization designing to the ARM Debug architecture specification keeps its own part number list.	DBGPID0, DBGPID1

A component is identified uniquely by the combination of the following fields:

- JEP106 continuation code
- JEP106 identity code
- Part number
- Revision
- Customer Modified
- RevAnd.

For components with a *Component class* of 0x9, Debug component, indicated by the Component Identification Registers, multiple components can have the same Part number, provided each component has a different CoreSight *Device type*. However, ARM strongly recommends that each device has a unique Part number. For more information:

- about the Component Identification Registers, see [About the Debug Component Identification Registers](#)
- about the CoreSight Device type, see [DBGDEVTYPE, Device Type Register on page C11-2228](#)
- about CoreSight components and their identification, see the *ARM Debug Interface v5 Architecture Specification*.

### C11.10.3 About the Debug Component Identification Registers

The Debug Component Identification Registers identify the processor as an ARM Debug Interface v5 component. For more information, see the *ARM Debug Interface v5 Architecture Specification* and the *CoreSight Architecture Specification*.

The Debug Component Identification Registers occupy the last four words of the 4KB block of debug registers, see [Table C11-1 on page C11-2193](#):

[Table C11-13](#) lists the Debug Component Identification Registers, in register offset order.

**Table C11-13 Debug Component Identification Registers**

Register offset	Description	Reference
0xFF0	Debug Component ID0	<a href="#">DBGCID0, Debug Component ID Register 0 on page C11-2218</a>
0xFF4	Debug Component ID1	<a href="#">DBGCID1, Debug Component ID Register 1 on page C11-2219</a>
0xFF8	Debug Component ID2	<a href="#">DBGCID2, Debug Component ID Register 2 on page C11-2220</a>
0xFFC	Debug Component ID3	<a href="#">DBGCID3, Debug Component ID Register 3 on page C11-2220</a>

Only bits[7:0] of each Debug Component ID Register are used. This means that the bit assignments of each register are:



Software can consider the four Debug Component ID Registers as defining a single 32-bit Component ID, as shown in [Figure C11-3](#). The value of this Component ID is fixed.

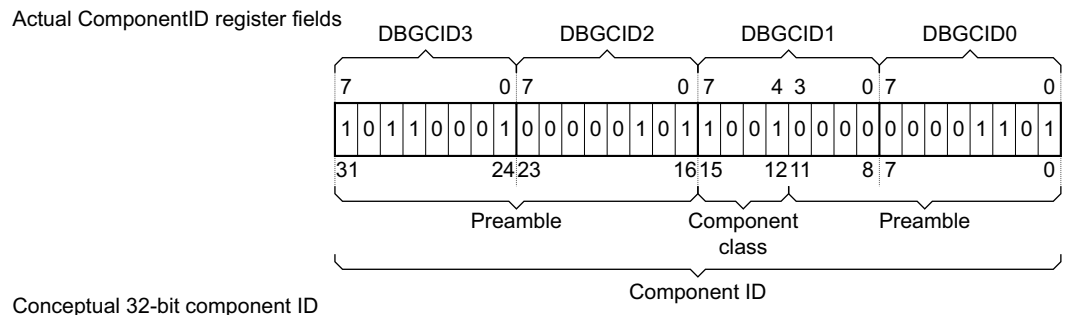

**Figure C11-3 Mapping between Debug Component ID Registers and the 32-bit Component ID value**

## C11.11 Register descriptions, in register order

The subsections in this section describe each of the debug registers. Registers are shown in register name order.

### C11.11.1 DBGAUTHSTATUS, Authentication Status register

The DBGAUTHSTATUS register characteristics are:

<b>Purpose</b>	Indicates the implemented debug authentication features and provides the current values of the configuration inputs that determine the debug permissions.
<b>Usage constraints</b>	There are no usage constraints.
<b>Configurations</b>	This register is required in all implementations. If external debug over powerdown is supported, this register must be implemented in the debug power domain. Some bit assignments differ if the implementation includes the Security Extensions. See the field descriptions for details.
<b>Attributes</b>	A 32-bit RO register. DBGAUTHSTATUS is in the <a href="#">Other Debug management registers</a> group, see the registers summary in <a href="#">Table C11-10 on page C11-2205</a> .

In an implementation that includes the Security Extensions, the DBGAUTHSTATUS register bit assignments are:

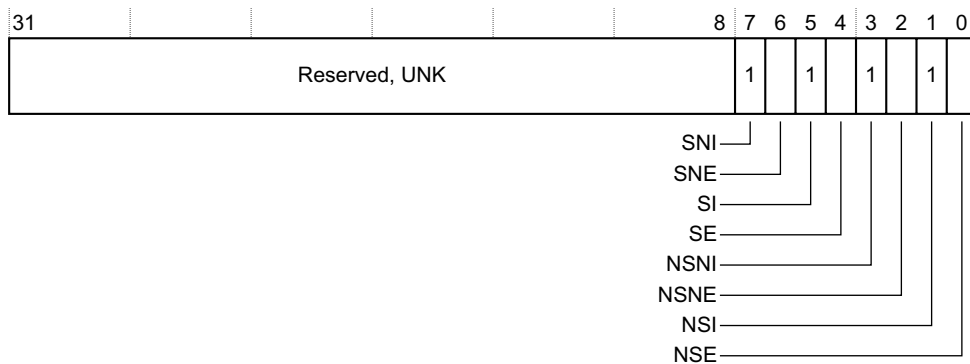

<b>Bits[31:8]</b>	Reserved, UNK.
<b>SNI, bit[7]</b>	Secure non-invasive debug features implemented. This bit is RAO, Secure non-invasive debug features are implemented.
<b>SNE, bit[6]</b>	Secure non-invasive debug enabled. This bit indicates whether non-invasive debug is permitted in Secure PL1 modes. If the implementation includes the recommended external debug interface it indicates the logical result of: <b>(DBGEN OR NIDEN) AND (SPIDEN OR SPNIDEN)</b> .
<b>SI, bit[5]</b>	Secure invasive debug features implemented. This bit is RAO, Secure invasive debug features are implemented.
<b>SE, bit[4]</b>	Secure invasive debug enabled. This bit indicates whether invasive halting debug is permitted in Secure PL1 modes. If the implementation includes the recommended external debug interface it indicates the logical result of <b>(DBGEN AND SPIDEN)</b> .
<b>NSNI, bit[3]</b>	Non-secure non-invasive debug features implemented. This bit is RAO, Non-secure non-invasive debug features are implemented.
<b>NSNE, bit[2]</b>	Non-secure non-invasive debug enabled. If the implementation includes the recommended external debug interface it indicates the logical result of <b>(DBGEN OR NIDEN)</b> .
<b>NSI, bit[1]</b>	Non-secure invasive debug features implemented. This bit is RAO, Non-secure invasive debug features are implemented.

**NSE, bit[0]** Non-secure invasive debug enabled. If the implementation includes the recommended external debug interface it indicates the logical state of the **DBGEN** signal.

In an implementation that does not include the Security Extensions, the DBGAUTHSTATUS register bit assignments are:

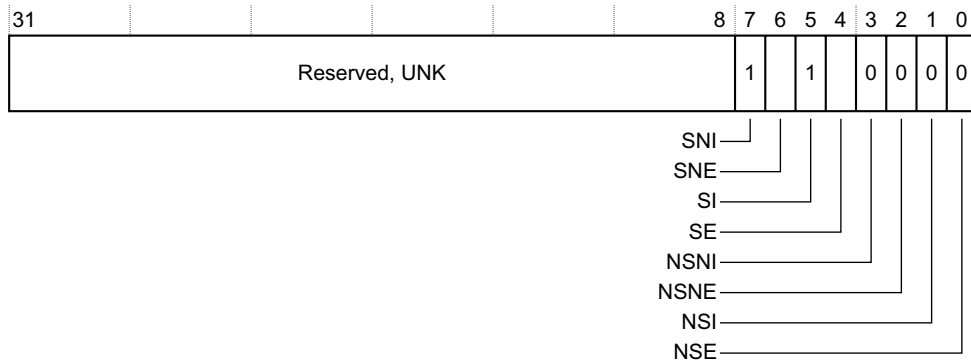

**Bits[31:8]** Reserved, UNK.

**SNI, bit[7]** Secure non-invasive debug features implemented. This bit is RAO, Secure non-invasive debug features are implemented.

**SNE, bit[6]** Secure non-invasive debug enabled. If the implementation includes the recommended external debug interface it indicates the logical result of (**DBGEN OR NIDEN**).

**SI, bit[5]** Secure invasive debug features implemented. This bit reads is RAO, Secure invasive debug features are implemented.

**SE, bit[4]** Secure invasive debug enabled. If the implementation includes the recommended external debug interface it indicates the logical state of the **DBGEN** signal.

**NSNI, bit[3]** Non-secure non-invasive debug features implemented. This bit is RAZ, Non-secure non-invasive debug features are not implemented.

**NSNE, bit[2]** Non-secure non-invasive debug enabled bit. This bit is RAZ.

**NSI, bit[1]** Non-secure invasive debug features implemented. This bit is RAZ, Non-secure invasive debug features are not implemented.

**NSE, bit[0]** Non-secure invasive debug enabled. This bit is RAZ.

**Note**

If a processor does not implement the Security Extensions, it does not recognize the existence of two security states and is described as:

- implementing Secure debug features
- not implementing any Non-secure debug features.

## C11.11.2 DBGBCR, Breakpoint Control Registers

The DBGBCR characteristics are:

<b>Purpose</b>	<p>Holds control information for a breakpoint.</p> <p>Used in conjunction with a Breakpoint Value Register, <a href="#">DBGBVR</a>. Each <a href="#">DBGBVR</a> is associated with a DBGBCR to form a breakpoint. <a href="#">DBGBVR</a><sub>n</sub> is associated with DBGBCR<sub>n</sub> to form breakpoint n.</p> <p>If the implementation includes the Virtualization Extensions, and this breakpoint supports Context matching, <a href="#">DBGBVR</a> can be associated with a Breakpoint Extended Value Register, <a href="#">DBGBXVR</a>, for VMID matching.</p>
<b>Usage constraints</b>	<p>Some breakpoints might not support Context matching. For more information, see the description of the <a href="#">DBGDIDR.CTX_CMPs</a> field.</p>
<b>Configurations</b>	<p>These registers are required in all implementations.</p> <p>The number of breakpoints is IMPLEMENTATION DEFINED, between 2 and 16, and is specified by the <a href="#">DBGDIDR.BRPs</a> field. Any registers that are not implemented are reserved.</p> <p>Some bit assignments differ if the implementation includes the Security Extensions and the Virtualization Extensions. See the field descriptions for details.</p>
<b>Attributes</b>	<p>A 32-bit RW register. DBGBCR is in the <a href="#">Software debug event registers</a> group, see the registers summary in <a href="#">Table C11-5 on page C11-2199</a>.</p> <p>The debug logic reset value of a DBGBCR is UNKNOWN.</p>

———— **Note** —————

After a debug logic reset a debugger must ensure that DBGBCR.E has a defined value for all implemented registers before it programs [DBGDSCR.MDBGen](#) or [DBGDSCR.HDBGen](#) to enable Monitor or Halting debug-mode.

The DBGBCR bit assignments are:

31	29	28		24	23		20	19		16	15	14	13	12		9	8		5	4	3	2	1	0
(0)	(0)	(0)		MASK			BT	LBN	SSC	Reserved, UNK/SBZP			BAS			(0)	(0)		PMC	E				
└ Reserved			└ HMC											└ Reserved										

### Bits[31:29, 23, 12:9, 4:3]

Reserved, UNK/SBZP.

### MASK, bits[28:24]

Address range mask. Whether masking is supported is IMPLEMENTATION DEFINED.

If an implementation does not support address range masking then this field is RAZ /WI if either of the following applies:

- the [DBGDEVID](#) register is not implemented
- the [DBGDEVID](#) register is implemented, and [DBGDEVID](#).{CIDmask, BPAddrMask} are both RAZ.

Otherwise:

- if the implementation does not support either Context ID masking or address range masking, this field is UNK/SBZP
- if Context ID masking is supported, but address range masking is not, then for breakpoints that do not support Context matching, this field is UNK/SBZP.

If address range masking is supported, this field can set a breakpoint on a range of addresses by masking lower order address bits out of the breakpoint comparison. The value of this field is the number of low order bits of the address that are masked off, except that values of 1 and 2 are reserved. Therefore, the meaning of the address range mask values for address breakpoints are:

0b00000	No mask.
0b00001	Reserved.
0b00010	Reserved.
0b00011	0x00000007 mask for instruction address, three bits masked.
0b00100	0x0000000F mask for instruction address, four bits masked.
0b00101	0x0000001F mask for instruction address, five bits masked.
.	
.	
.	
0b11111	0x7FFFFFFF mask for instruction address, 31 bits masked.

If Context ID masking is supported, this field can mask the bottom 8 bits from a CONTEXTIDR comparison. The meaning of the address range mask values for Context matching breakpoints are:

0b00000	No mask.
0b01000	0x000000FF mask for CONTEXTIDR, eight bits masked.

All other values are reserved.

ARM deprecates the use of Context ID masking when the implementation includes the Large Physical Address Extension.

A debugger must program this field to 0b00000 if either:

- this breakpoint is programmed for Context matching, and either Context ID masking is not supported or only the VMID value is being compared
- the Byte address select field is programmed to a value other than 0b1111.

If this is not done, the generation of debug events by this breakpoint is UNPREDICTABLE.

If this field is not zero, the [DBGVVR](#) bits that are not included in the comparison must be zero, otherwise the generation of debug events by this breakpoint is UNPREDICTABLE.

For more information about the use of this field see [Breakpoint address range masking behavior on page C3-2049](#) and [Context matching comparisons for debug event generation on page C3-2051](#).

### BT, bits[23:20]

Breakpoint type. This field controls the behavior of debug event generation. This includes the meaning of the value held in the associated [DBGVVR](#), indicating whether it is an instruction address match or mismatch or a Context match. It also controls whether the breakpoint is linked to another breakpoint.

[Breakpoint types on page C11-2214](#) gives the permitted values of this field.

For more information about instruction address matching and mismatching see:

- [Byte address selection behavior on instruction address match or mismatch on page C3-2047](#)
- [Breakpoint address range masking behavior on page C3-2049](#)
- [Instruction address comparisons in different instruction set states on page C3-2049](#).

See [Breakpoint types on page C11-2214](#) for detailed descriptions of the different Breakpoint types.

Reading this register returns an UNKNOWN value for this field, and the generation of debug events by this breakpoint is UNPREDICTABLE if this field is programmed to a value that is reserved or is not supported by this breakpoint.

### LBN bits[19:16]

Linked breakpoint number. If this breakpoint is programmed for Linked instruction address match or mismatch then this field must be programmed with the number of the breakpoint that holds the Context match to be used in the combined instruction address and Context comparison. Otherwise, this field must be programmed to 0b0000.



Reading this register returns an UNKNOWN value for this field, and the generation of debug events by this breakpoint is UNPREDICTABLE, if either:

- this breakpoint is not programmed for Linked instruction address match or mismatch and this field is not programmed to 0b0000
- this breakpoint is programmed for Linked instruction address match or mismatch and the breakpoint indicated by this field does not support Context matching or is not programmed for Linked Context matching, or does not exist.

See also [Generation of debug events on page C3-2074](#).

#### **SSC, bits[15:14], Implementation includes the Security Extensions**

Security state control. In an implementation that includes the Security Extensions, this field enables the breakpoint to be conditional on the security state of the processor.

This field is used with the HMC, Hyp mode control, and PMC, Privileged mode control, fields. See [Breakpoint state control fields on page C11-2215](#) for possible values.

This field must be programmed to 0b00 if DBGBCR.BT is programmed for Linked Context match. If this is not done, the generation of debug events by this breakpoint is UNPREDICTABLE.

#### **Note**

When this field is set to a value other than 0b00, the SSC field controls the processor security state in which the access matches, not the required security attribute of the access.

See also [Generation of debug events on page C3-2074](#).

#### **Bits[15:14], Implementation does not include the Security Extensions**

Reserved, UNK/SBZP.

#### **HMC, bit[13], Implementation includes the Virtualization Extensions**

Hyp mode control bit.

This field is used with the SSC, Security state control, and PMC, Privileged mode control, fields. See [Breakpoint state control fields on page C11-2215](#) for possible values.

This field must be programmed to 0 if DBGBCR.BT is programmed for Linked Context match. If this is not done, the generation of debug events by this breakpoint is UNPREDICTABLE.

#### **Bit[13], Implementation does not include the Virtualization Extensions**

Reserved, UNK/SBZP.

**BAS, bits[8:5]** Byte address select. This field enables match or mismatch comparisons on only certain bytes of the word address held in the DBGBVR. The operation of this field depends also on:

- the Breakpoint type field being programmed for instruction address match or mismatch
- the MASK field being programmed to 0b000000, no mask
- the instruction set state of the processor, indicated by the CPSR. {J, T} bits.

For details of the use of this field see [Byte address selection behavior on instruction address match or mismatch on page C3-2047](#).

This field must be programmed to 0b1111 if either:

- DBGBCR.BT is programmed for Linked or Unlinked Context ID match
- DBGBCR.MASK is programmed to a value other than 0b000000.

If this is not done, the generation of debug events by this breakpoint is UNPREDICTABLE.

**PMC, bits[2:1]**

Privileged mode control. This field enables breakpoint matching conditional on the mode of the processor.

This field is used with the SSC, Security state control, and HMC, Hyp mode control, fields. See [Breakpoint state control fields on page C11-2215](#) for possible values.

This field must be programmed to 0b11 if DBGBCR.BT is programmed for Linked Context match. If this is not done, the generation of debug events by this breakpoint is UNPREDICTABLE.

**E, bit[0]**

Breakpoint enable. The meaning of this bit is:

**0** Breakpoint disabled.

**1** Breakpoint enabled.

A breakpoint never generates debug events when it is disabled.

**Breakpoint types**

DBGBCR.BT, the Breakpoint type field, determines the type of comparison made by the breakpoint. [Table C11-14](#) shows the permitted values of this field, and their meanings.

**Table C11-14 Breakpoint types**

DBGBCR.BT	Breakpoint type	Notes
0b0000	Unlinked instruction address match	-
0b0001	Linked instruction address match	-
0b0010	Unlinked Context ID match	-
0b0011	Linked Context ID match	-
0b0100	Unlinked instruction address mismatch	-
0b0101	Linked instruction address mismatch	-
0b1000	Unlinked VMID match	Requires Virtualization Extensions <sup>a</sup>
0b1001	Linked VMID match	Requires Virtualization Extensions <sup>a</sup>
0b1010	Unlinked VMID match and Context ID match	Requires Virtualization Extensions <sup>a</sup>
0b1011	Linked VMID match and Context ID match	Requires Virtualization Extensions <sup>a</sup>

a. Only supported if the implementation includes the Virtualization Extensions. Otherwise, the BT value is reserved

All values of BT not shown in [Table C11-14](#) are reserved.

[Breakpoint debug events on page C3-2039](#) describes the generation of the different breakpoint types. In particular, [Breakpoint types defined by the DBGBCR on page C3-2040](#) gives more information about each breakpoint type, and identifies the subsections of [Chapter C3](#) that describe that breakpoint type.

## Breakpoint state control fields

Breakpoint debug event generation can be made conditional on the current state of the processor. The following fields in **DBGBCR** control the checks on the current state:

- SSC, Security state control, only if the implementation includes the Security extensions
- HMC, Hyp mode control, only if the implementation includes the Virtualization Extensions
- PMC, Privileged mode control.

Table C11-15 shows the possible values of the fields, and the modes and security states that can be tested.

**Table C11-15 Breakpoint state control**

SSC	HMC	PMC	Secure modes	Non-secure modes
0b00	0	0b00	PL0, Supervisor and System modes only	PL0, Supervisor and System modes only
0b00	0	0b01	PL1 modes only	PL1 modes only
0b00	0	0b10	PL0 mode only	PL0 mode only
0b00	0	0b11	All modes	PL1 and PL0 modes only
0b00	1	0b01	PL1 modes only	PL2 and PL1 modes only
0b00	1	0b11	All modes	All modes
0b01	0	0b00	-	PL0, Supervisor and System modes only
0b01	0	0b01	-	PL1 modes only
0b01	0	0b10	-	PL0 mode only
0b01	0	0b11	-	PL1 and PL0 modes only
0b01	1	0b01	-	PL2 and PL1 modes only
0b01	1	0b11	-	All modes
0b10	0	0b00	PL0, Supervisor and System modes only	-
0b10	0	0b01	PL1 modes only	-
0b10	0	0b10	PL0 mode only	-
0b10	0	0b11	All modes	-
0b11	1	0b00	-	PL2 mode only

———— **Note** —————

All other combinations of values are Reserved, and the generation of Breakpoint debug events by this breakpoint is UNPREDICTABLE if used.

### C11.11.3 DBGBVR, Breakpoint Value Registers

The DBGBVR characteristics are:

<b>Purpose</b>	<p>Holds a value for use in breakpoint matching, either the virtual address of an instruction, or a Context ID.</p> <p>Used in conjunction with a Breakpoint Control Register, <a href="#">DBGBCR</a>. Each DBGBVR is associated with a <a href="#">DBGBCR</a> to form a breakpoint. DBGBVR<sub>n</sub> is associated with <a href="#">DBGBCR<sub>n</sub></a> to form breakpoint n.</p> <p>If the implementation includes the Virtualization Extensions, and this breakpoint supports Context matching, <a href="#">DBGBVR</a> can be associated with a Breakpoint Extended Value Register, <a href="#">DBGXVR</a>, for Context matching.</p>
<b>Usage constraints</b>	<p>Some breakpoints might not support Context matching. For more information, see the description of the <a href="#">DBGDIDR.CTX_CMPs</a> field.</p>
<b>Configurations</b>	<p>These registers are required in all implementations.</p> <p>The number of breakpoints is IMPLEMENTATION DEFINED, between 2 and 16, and is specified by the <a href="#">DBGDIDR.BRPs</a> field. Any registers that are not implemented are reserved.</p>
<b>Attributes</b>	<p>A 32-bit RW register. DBGBVR is in the <a href="#">Software debug event registers</a> group, see the registers summary in <a href="#">Table C11-5 on page C11-2199</a>.</p> <p>The debug logic reset value of a DBGBVR is UNKNOWN.</p>

When used for address comparison the DBGBVR bit assignments are:



When used for Context ID comparison the DBGBVR bit assignments are:

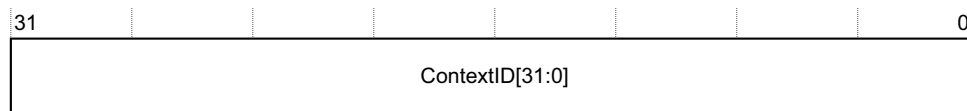

**Bits[31:2], when register is used for address comparison**

Bits[31:2] of the virtual address value for comparison.

When breakpoint address range masking is used, the masked bits of the address must be set to 0, otherwise the generation of Breakpoint debug events by this breakpoint is UNPREDICTABLE. For more information, see [Breakpoint address range masking behavior on page C3-2049](#).

**Bits[1:0], when register used for address comparison**

Must be written as 0b00, otherwise the generation of Breakpoint debug events by this breakpoint is UNPREDICTABLE.

**Bits[31:0], when register used for Context ID comparison**

Bits[31:0] of the value for comparison, ContextID[31:0].

When Context ID masking is used, bits[7:0] of this value must be set to 0, otherwise the generation of debug events by this breakpoint is UNPREDICTABLE. For more information, see [Condition for breakpoint generation on Context ID match in a VMSA implementation on page C3-2052](#).

If the breakpoint does not support Context matching then bits[1:0] are UNK/SBZP.

If the implementation includes the Virtualization Extensions, and if the breakpoint is configured for VMID comparison without Context ID comparison, DBGBVR must be programmed as zero. Otherwise the generation of debug events by this breakpoint is UNPREDICTABLE.

The debug logic generates a debug event when an instruction that matches the breakpoint is committed for execution. For more information, see [Breakpoint debug events on page C3-2039](#).

### C11.11.4 DBGBXVR, Breakpoint Extended Value Registers

The DBGBXVR characteristics are:

- Purpose** Holds a value for use in breakpoint matching, to support VMID matching. Used in conjunction with a Breakpoint Control Register [DBGBCR](#), and a Breakpoint Value Register [DBGBVR](#).
- Usage constraints** There are no usage constraints.
- Configurations** In v7 Debug, these registers are not implemented. In v7.1 Debug, these registers are only implemented if the implementation includes the Virtualization Extensions. In this case, DBGBXVR is implemented only for breakpoints that support Context matching. The total number of breakpoints is IMPLEMENTATION DEFINED, between 2 and 16, and is specified by the [DBGDIDR.BRPs](#) field. The number of Breakpoint Extended Value Registers is IMPLEMENTATION DEFINED, and is specified by the [DBGDIDR.CTX\\_CMPs](#) field. Any registers that are not implemented are reserved.
- Attributes** A 32-bit RW register. DBGBXVR is in the [Software debug event registers](#) group, see the registers summary in [Table C11-5 on page C11-2199](#).

The DBGBXVR bit assignments are:

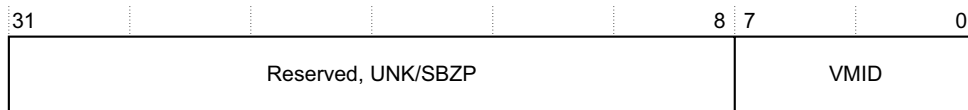

**Bits[31:8],**

Reserved, UNK/SBZP.

**VMID, bit[7:0]**

VMID value. Compared with [VTTBR.VMID](#), the virtual machine identifier field.

The debug logic generates a debug event when an instruction that matches the breakpoint is committed for execution. For more information, see [Context matching comparisons for debug event generation on page C3-2051](#).

### C11.11.5 DBGCID0, Debug Component ID Register 0

The DBGCID0 Register characteristics are:

- Purpose** Provides bits[7:0] of the 32-bit conceptual Component ID, see [Figure C11-3 on page C11-2208](#).
- Usage constraints** DBGCID0 is not visible in the CP14 interface.
- Configurations** This register is required in all implementations.  
If external debug over powerdown is supported, this register can be implemented in either or both power domains.
- Attributes** A 32-bit RO register. DBGCID0 is in the [Other Debug management registers](#) group, see the registers summary in [Table C11-10 on page C11-2205](#).

The DBGCID0 register bit assignments are:

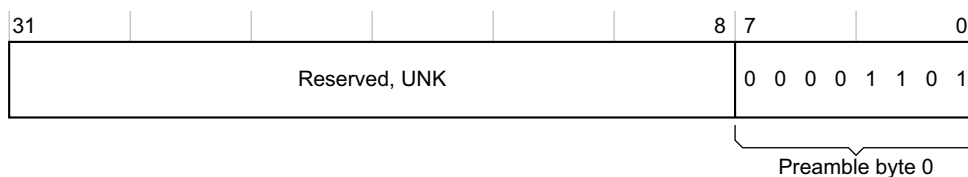

**Bits[31:8]** Reserved, UNK.

**Preamble byte 0, bits[7:0]**

This byte has the value 0x0D.

For more information, see [About the Debug Component Identification Registers on page C11-2208](#).

### C11.11.6 DBGCID1, Debug Component ID Register 1

The DBGCID1 Register characteristics are:

- Purpose** Provides bits[15:8] of the 32-bit conceptual Component ID, see [Figure C11-3 on page C11-2208](#).
- Usage constraints** DBGCID1 is not visible in the CP14 interface.
- Configurations** This register is required in all implementations.  
 If external debug over powerdown is supported, this register can be implemented in either or both power domains.
- Attributes** A 32-bit RO register. DBGCID1 is in the [Other Debug management registers](#) group, see the registers summary in [Table C11-10 on page C11-2205](#).

The DBGCID1 register bit assignments are:



**Bits[31:8]** Reserved, UNK.

**Component class, bits[7:4]**

This field has the value 0x9, indicating a debug component, with CoreSight architecture compliant management registers.

**Preamble, bits[3:0]**

This field has the value 0x0.

For more information, see [About the Debug Component Identification Registers on page C11-2208](#).

### C11.11.7 DBGCID2, Debug Component ID Register 2

The DBGCID2 Register characteristics are:

- Purpose** Provides bits[23:16] of the 32-bit conceptual Component ID, see [Figure C11-3 on page C11-2208](#).
- Usage constraints** DBGCID2 is not visible in the CP14 interface.
- Configurations** This register is required in all implementations.  
 If external debug over powerdown is supported, this register can be implemented in either or both power domains.
- Attributes** A 32-bit RO register. DBGCID2 is in the [Other Debug management registers](#) group, see the registers summary in [Table C11-10 on page C11-2205](#).

The DBGCID2 register bit assignments are:

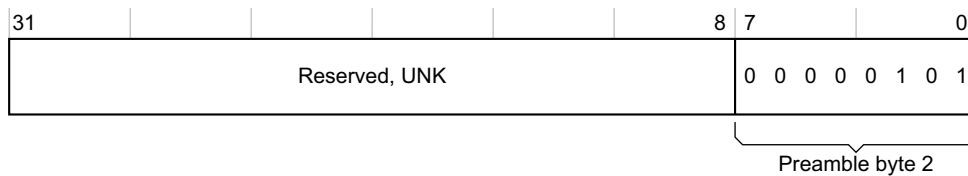

**Bits[31:8]** Reserved, UNK.

**Preamble byte 2, bits[7:0]**

This field has the value 0x05.

For more information, see [About the Debug Component Identification Registers on page C11-2208](#).

### C11.11.8 DBGCID3, Debug Component ID Register 3

The DBGCID3 Register characteristics are:

- Purpose** Provides bits[31:24] of the 32-bit conceptual Component ID, see [Figure C11-3 on page C11-2208](#).
- Usage constraints** DBGCID3 is not visible in the CP14 interface.
- Configurations** This register is required in all implementations.  
 If external debug over powerdown is supported, this register can be implemented in either or both power domains.
- Attributes** A 32-bit RO register. DBGCID3 is in the [Other Debug management registers](#) group, see the registers summary in [Table C11-10 on page C11-2205](#).

The DBGCID3 register bit assignments are:

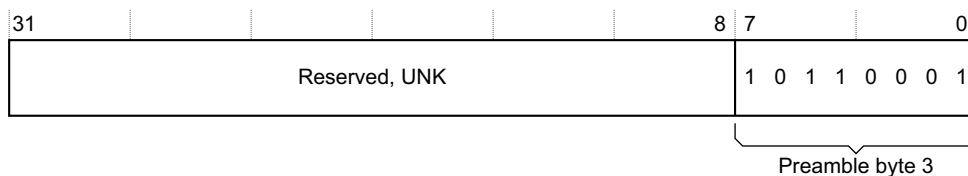

**Bits[31:8]** Reserved, UNK.

**Preamble byte 3, bits[7:0]**

This field has the value 0xB1.

For more information, see [About the Debug Component Identification Registers on page C11-2208](#).



### C11.11.9 DBGCIDSR, Context ID Sampling Register

The DBGCIDSR characteristics are:

<b>Purpose</b>	<p>Samples the CONTEXTIDR whenever the <a href="#">DBGPCSR</a> samples the program counter. This enables a debugger to associate a program counter sample with the process running on the processor.</p> <p>The DBGCIDSR is a Sample-based profiling register.</p>
<b>Usage constraints</b>	<p>Used in conjunction with the <a href="#">DBGPCSR</a>.</p> <p>DBGCIDSR is not visible in the CP14 interface.</p>
<b>Configurations</b>	<p>Implementation of the Sample-based profiling extension is OPTIONAL. In an implementation that includes the Sample-based profiling extension:</p> <ul style="list-style-type: none"> <li>• in a v7 Debug implementation, it is IMPLEMENTATION DEFINED whether DBGCIDSR is implemented</li> <li>• in a v7.1 Debug implementation, DBGCIDSR must be implemented.</li> </ul> <p>When implemented, DBGCIDSR is debug register 41.</p> <p>An implementation that does not include the Sample-based profiling extension cannot implement DBGCIDSR.</p> <p>When DBGCIDSR is not implemented, debug register 41 is reserved.</p>
<b>Attributes</b>	<p>A 32-bit RO register. DBGCIDSR is in the <a href="#">Sample-based profiling registers</a> group, see the registers summary in <a href="#">Table C11-6 on page C11-2200</a>.</p> <p>The non-debug logic reset value of the DBGCIDSR is UNKNOWN.</p>

The DBGCIDSR bit assignments are:

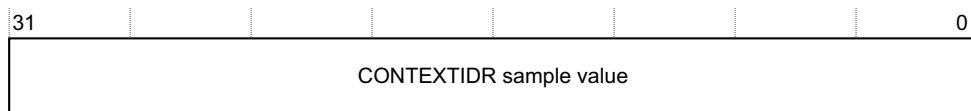

#### CONTEXTIDR sample value, bits[31:0]

The value of the Context ID Register, CONTEXTIDR, associated with the last PC sample read from [DBGPCSR](#).

*The implemented Sample-based profiling registers on page C10-2188 describes the Sample-based profiling implementation options, and how software can determine whether and how the Sample-based profiling registers are implemented.*

For more information about program counter sampling, see [Sample-based profiling on page C10-2188](#).

### C11.11.10 DBGCLAIMCLR, Claim Tag Clear register

The DBGCLAIMCLR register characteristics are:

- Purpose** Used by software to read the values of the CLAIM bits, and to clear these bits to zero. Used in conjunction with the [DBGCLAIMSET](#) register.
- Usage constraints** The architecture does not define any functionality for the CLAIM bits.
- Configurations** This register is required in all implementations.  
In v7 Debug, this register must be implemented in the debug power domain, if external debug over powerdown is supported.  
In v7.1 Debug, this register is implemented in the core power domain.
- Attributes** A 32-bit RW register. See the field descriptions for information about the reset value of the register. DBGCLAIMCLR is in the [Other Debug management registers](#) group, see the registers summary in [Table C11-10 on page C11-2205](#).

The DBGCLAIMCLR register bit assignments are:

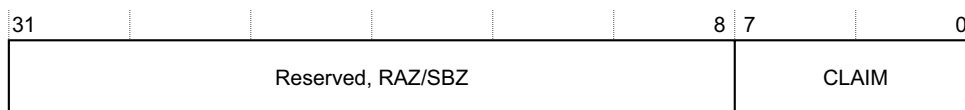

- Bits[31:8]** Reserved, RAZ/SBZ.  
Software can rely on these bits reading-as-zero, and must use a should-be-zero policy on writes. Implementations must ignore writes to these bits.

#### CLAIM, bits[7:0]

Writing a 1 to one of these bits clears the corresponding CLAIM bit to 0. A single write operation can clear multiple bits to 0.

Writing 0 to one of these bits has no effect.

Reading the register returns the current values of these bits.

The debug logic reset value of these bits is 0.

For more information about the CLAIM bits and how they might be used, see [DBGCLAIMSET, Claim Tag Set register on page C11-2223](#).

#### ———— **Note** —————

In v7.1 Debug, software routines for Save and Restore must include save and restore for the CLAIM bits.

### C11.11.11 DBGCLAIMSET, Claim Tag Set register

The DBGCLAIMSET register characteristics are:

<b>Purpose</b>	Used by software to set CLAIM bits to 1. Used in conjunction with the <a href="#">DBGCLAIMCLR</a> Register.
<b>Usage constraints</b>	The architecture does not define any functionality for the CLAIM bits.
<b>Configurations</b>	This register is required in all implementations. In v7 Debug, this register must be implemented in the debug power domain, if external debug over powerdown is supported. In v7.1 Debug, this register is implemented in the core power domain.
<b>Attributes</b>	A 32-bit RW register. DBGCLAIMSET is in the <a href="#">Other Debug management registers</a> group, see the registers summary in <a href="#">Table C11-10 on page C11-2205</a> .

The DBGCLAIMSET register bit assignments are:

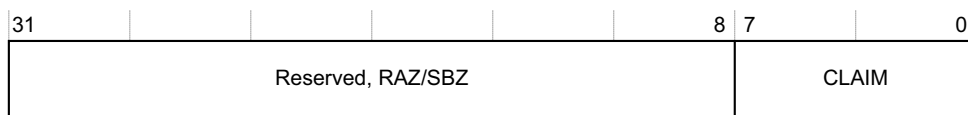

**Bits[31:8]** Reserved, RAZ/SBZ.  
Software can rely on these bits reading-as-zero, and must use a should-be-zero policy on writes. Implementations must ignore writes to these bits.

#### CLAIM, bits[7:0]

Writing a 1 to one of these bits sets the corresponding CLAIM bit to 1. A single write operation can set multiple bits to 1.

Writing 0 to one of these bits has no effect.

The CLAIM bits are RAO.

You must use the [DBGCLAIMCLR](#) register to:

- read the values of the CLAIM bits
- clear a CLAIM bit to 0.

If software reads this register, the bits that are set to 1 correspond to the implemented CLAIM bits. This enables a debugger to identify the number of CLAIM bits that are implemented.

See [DBGCLAIMCLR, Claim Tag Clear register on page C11-2222](#) for details of how to:

- clear CLAIM bits to 0
- read the current values of the CLAIM bits.

The CLAIM bits do not have any specific functionality. ARM expects the usage model to be that an external debugger and a debug monitor can set specific bits to 1 to claim the corresponding debug resources.

———— **Note** —————

In v7.1 Debug, software routines for Save and Restore must include save and restore for the CLAIM bits.

### C11.11.12 DBGDEVID, Debug Device ID register

The DBGDEVID register characteristics are:

<b>Purpose</b>	Adds to the information given by the <a href="#">DBGDIDR</a> by describing other features of the debug implementation.
<b>Usage constraints</b>	There are no usage constraints.
<b>Configurations</b>	In v7 Debug, this register is <b>OPTIONAL</b> in all implementations. In v7.1 Debug, this register is required in all implementations. If external debug over powerdown is supported, this register can be implemented in either or both power domains.
<b>Attributes</b>	A 32-bit RO register. DBGDEVID is in the <a href="#">Debug identification registers</a> group, see the registers summary in <a href="#">Table C11-2 on page C11-2196</a> .

The DBGDEVID register bit assignments are:

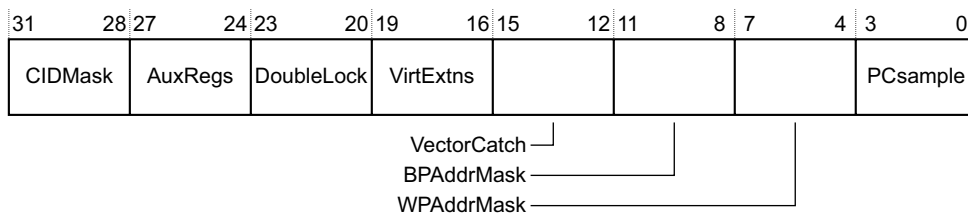

#### CIDMask, bits[31:28]

This field indicates the level of support for the Context ID matching breakpoint masking capability. The permitted values of this field are:

0b0000 Context ID masking is not implemented.

0b0001 Context ID masking is implemented. Only permitted in a VMSA implementation.

Other values are reserved.

See also the description of the BPAddrMask field.

#### AuxRegs, bits[27:24]

This field indicates the presence of the External Auxiliary Control Register, [DBGEACR](#). The permitted values of this field are:

0b0000 The DBGEACR is not present.

0b0001 The DBGEACR is present.

Other values are reserved.

In v7 Debug, this field must be 0b0000.

In v7.1 Debug, this field can take either value.

#### DoubleLock, bits[23:20]

This field indicates the presence of the [DBGOSDLR](#), OS Double Lock Register. The permitted values of this field are:

0b0000 The DBGOSDLR is not present.

0b0001 The DBGOSDLR is present.

Other values are reserved.

In v7 Debug, this field must be 0b0000.

In v7.1 Debug, this field must be 0b0001.

#### **VirtExtns, bits[19:16]**

This field indicates whether the Virtualization Extensions to Debug are implemented. The permitted values of this field are:

0b0000 The implementation does not include the Virtualization Extensions.

0b0001 The implementation includes the Virtualization Extensions.

Other values are reserved.

In v7 Debug, this field must be 0b0000.

#### **VectorCatch, bits[15:12]**

This field defines the form of Vector catch debug event implemented. The permitted values of this field are:

0b0000 Address matching form.

0b0001 Exception matching form.

Other values are reserved.

In v7 Debug, this field must be 0b0000.

#### **BPAddrMask, bits[11:8]**

This field indicates the level of support for the IVA matching breakpoint masking capability. The permitted values of this field are:

0b0000 Breakpoint address masking might be implemented.

0b0001 Breakpoint address masking is implemented.

0b1111 Breakpoint address masking is not implemented.

Other values are reserved.

In v7 Debug, all values listed in this description are permitted.

In v7.1 Debug:

- in an implementation that follows the ARM implementation recommendations, this field is 0b1111
- this field must not be 0b0000.

If Breakpoint address masking is not implemented and Context ID masking is not implemented:

- if BPAddrMask is 0b0000, then [DBGBCRn.MASK](#) is RAZ/WI
- if BPAddrMask is 0b1111, then [DBGBCRn.MASK](#) is UNK/SBZP.

ARM deprecates the use of Breakpoint address masking, and recommends that implementations do not include support for this feature.

#### **WPAAddrMask, bits[7:4]**

This field indicates the level of support for the data VA matching watchpoint masking capability. The permitted values of this field are:

0b0000 Watchpoint address masking may be implemented. If not implemented, [DBGWCRn.MASK](#) is RAZ/WI.

0b0001 Watchpoint address masking is implemented.

0b1111 Watchpoint address masking is not implemented. [DBGWCRn.MASK](#) is UNK/SBZP.

Other values are reserved.

In v7 Debug, all values listed in this description are permitted.

In v7.1 Debug, this field must be 0b0001.

### PCsample, bits[3:0]

This field indicates the level of program counter sampling support using debug registers 40, 41, and 42. The permitted values of this field are:

- 0b0000 Program Counter Sampling Register, [DBGPCSR](#), is not implemented as register 40, Context ID Sampling Register, [DBGCIDSR](#), and Virtualization ID Sampling Register, [DBGVIDSR](#), are not implemented.
- 0b0001 [DBGPCSR](#) is implemented as register 40. [DBGCIDSR](#) and [DBGVIDSR](#) are not implemented.
- 0b0010 [DBGPCSR](#) is implemented as register 40, [DBGCIDSR](#) is implemented as register 41, and [DBGVIDSR](#) is not implemented.
- 0b0011 [DBGPCSR](#) is implemented as register 40, [DBGCIDSR](#) is implemented as register 41, and [DBGVIDSR](#) is implemented as register 42. Only permitted if the implementation includes the Security Extensions.

Other values are reserved.

If an implementation does not include the Sample-based profiling extension, this field must be zero. Otherwise:

- in v7 Debug, the permitted values are:
  - 0b0001 or 0b0010 if the implementation does not include the Security Extensions
  - 0b0001, 0b0010, or 0b0011 if the implementation includes the Security Extensions.
- in v7.1 Debug, the value must be:
  - 0b0010 if the implementation does not include the Security Extensions
  - 0b0011 if the implementation includes the Security Extensions.

#### ———— Note ————

The [DBGPCSR](#) can be implemented as register 33, as register 40, or as both register 33 and register 40. The [DBGDEVID.PCsample](#) field only indicates whether it is implemented as register 40. [The implemented Sample-based profiling registers on page C10-2188](#) describes the Sample-based profiling implementation options, and how software can determine whether and how the Sample-based profiling registers are implemented.

The [DBGDIDR.DEVID\\_imp](#) bit indicates whether the [DBGDEVID](#) register is implemented, see [DBGDIDR, Debug ID Register on page C11-2229](#). If the [DBGDEVID](#) register is not implemented:

- the Program Counter Sampling Register, [DBGPCSR](#), is not implemented as register 40
- the Context ID Sampling Register, [DBGCIDSR](#), is not implemented
- the Virtualization ID Sampling Register, [DBGVIDSR](#), is not implemented.

### C11.11.13 DBGDEVID1, Debug Device ID register 1

The DBGDEVID1 characteristics are:

**Purpose** Adds to the information given by the [DBGDIDR](#) by describing other features of the debug implementation.

**Usage constraints** There are no usage constraints.

**Configurations** In v7 Debug the CP14 access instruction that corresponds to this register is always UNPREDICTABLE at PL1 or higher.

In v7.1 Debug, this register is required in all implementations.

———— **Note** —————

This register is first described in issue C.a of this manual. This means its location was previously reserved, UNK/SBZP in the memory-mapped interface and in the external debug interface.

If external debug over powerdown is supported, this register can be implemented in either or both power domains.

**Attributes** A 32-bit RO register. DBGDEVID1 is in the [Debug identification registers](#) group, see the registers summary in [Table C11-2 on page C11-2196](#).

The DBGDEVID1 bit assignments are:

31	28	27	24	23	20	19	16	15	12	11	8	7	4	3	0
UNK	UNK	UNK	UNK	UNK	UNK	UNK	UNK	UNK	UNK	UNK	UNK	UNK	UNK	UNK	UNK

|  
PCSROffset

**Bits[31:4]** Reserved, UNK.

**PCSROffset, bits[3:0]**

This field defines the offset applied to [DBGPCSR](#) samples. The permitted values of this field are:

0b0000 [DBGPCSR](#) samples are offset by a value that depends on the instruction set state.

0b0001 No offset is applied to the [DBGPCSR](#) samples.

For more information about the applied offsets, see the [DBGPCSR](#) description.

### C11.11.14 DBGDEVTYPE, Device Type Register

The DBGDEVTYPE Register characteristics are:

- Purpose** Provides the CoreSight device type information for the Debug architecture.
- Usage constraints** DBGDEVTYPE is not visible in the CP14 interface.
- Configurations** This register is required in all implementations.  
If external debug over powerdown is supported, this register can be implemented in either or both power domains.
- Attributes** A 32-bit RO register. DBGDEVTYPE is in the [Other Debug management registers](#) group, see the registers summary in [Table C11-10 on page C11-2205](#).

The DBGDEVTYPE bit assignments are:

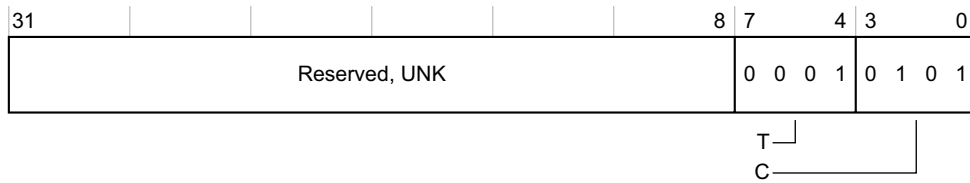

- Bits[31:8]** Reserved, UNK.
- T, bits[7:4]** Sub type. This field reads as 0x1, indicating a processor.
- C, bits[3:0]** Main class. This field reads as 0x5, indicating debug logic.

For more information about the CoreSight registers see the *CoreSight Architecture Specification*.



### C11.11.15 DBGDIDR, Debug ID Register

The DBGDIDR characteristics are:

<b>Purpose</b>	<p>Specifies:</p> <ul style="list-style-type: none"> <li>• which version of the Debug architecture is implemented</li> <li>• some features of the debug implementation.</li> </ul> <p><a href="#">DBGDEVID</a> and <a href="#">DBGDEVID1</a>, if implemented, provides more information about the debug implementation.</p>
<b>Usage constraints</b>	There are no usage constraints.
<b>Configurations</b>	<p>This register is required in all implementations.</p> <p>If external debug over powerdown is supported, this register can be implemented in either or both power domains.</p>
<b>Attributes</b>	A 32-bit RO register. DBGDIDR is in the <a href="#">Debug identification registers</a> group, see the registers summary in <a href="#">Table C11-2 on page C11-2196</a> .

The DBGDIDR bit assignments are:

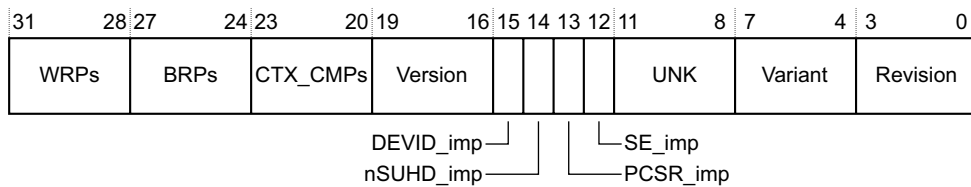

#### WRPs, bits[31:28]

The number of watchpoints implemented. The number of implemented watchpoints is one more than the value of this field. The permitted values of the field are from 0b0000 for 1 implemented watchpoint, to 0b1111 for 16 implemented watchpoints.

The minimum number of watchpoints is 1.

#### BRPs, bits[27:24]

The number of breakpoints implemented. The number of implemented breakpoints is one more than value of this field. The permitted values of the field are from 0b0001 for 2 implemented breakpoints, to 0b1111 for 16 implemented breakpoints.

The value of 0b0000 is reserved.

The minimum number of breakpoints is 2.

#### CTX\_CMPs, bits[23:20]

The number of breakpoints that can be used for Context matching. This is one more than the value of this field. The permitted values of the field are from 0b0000 for 1 Context matching breakpoint, to 0b1111 for 16 Context matching breakpoints.

The minimum number of Context matching breakpoints is 1. The value in this field cannot be greater than the value in the BRPs field.

The Context matching breakpoints *must* be the highest addressed breakpoints. For example, if six breakpoints are implemented and two are Context matching breakpoints, they must be breakpoints 4 and 5.

### Version, bits[19:16]

The Debug architecture version. The permitted values of this field are:

- 0b0001 ARMv6, v6 Debug architecture.
- 0b0010 ARMv6, v6.1 Debug architecture.
- 0b0011 ARMv7, v7 Debug architecture, with all CP14 registers implemented.
- 0b0100 ARMv7, v7 Debug architecture, with only the baseline CP14 registers implemented.
- 0b0101 ARMv7, v7.1 Debug architecture.

All other values are reserved.

### DEVID\_imp, bit[15]

Debug Device ID Register, [DBGDEVID](#), implemented. The meanings of the values of this bit are:

- 0 [DBGDEVID](#) is not implemented. Debug register 1010 is reserved.
- 1 [DBGDEVID](#) is implemented.

In v7 Debug, when this bit is set to 1:

- [DBGDEVID](#) is implemented in the external debug and memory-mapped interfaces, and in the CP14 interface
- [DBGDEVID1](#) and [DBGDEVID2](#) are implemented as RO in the external debug and memory-mapped interfaces, but are not implemented in the CP14 interface.

In v7.1 Debug [DBGDEVID](#) is always implemented, so this bit is RAO, and use of this bit by software is deprecated.

### nSUHD\_imp, bit[14]

Secure User halting debug not implemented. When the [SE\\_imp](#) bit is set to 1, indicating that the implementation includes the Security Extensions, the meanings of the values of this bit are:

- 0 Secure User halting debug is implemented.
- 1 Secure User halting debug is not implemented.

If the Security Extensions are not implemented:

- Secure User halting debug cannot be implemented
- this bit is RAZ.

See also [Appendix N Secure User Halting Debug](#).

In v7.1 Debug the value must match [DBGDIDR.SE\\_imp](#).

ARM deprecates any use of Secure User Halting Debug by software.

### PCSR\_imp, bit[13]

Program Counter Sampling Register, [DBGPCSR](#), implemented as register 33. The meanings of the values of this bit are:

- 0 [DBGPCSR](#) is not implemented as register 33.
- 1 [DBGPCSR](#) is implemented as register 33.

#### ————— Note —————

The [DBGPCSR](#) can be implemented as register 33, as register 40, or as both register 33 and register 40. [The implemented Sample-based profiling registers on page C10-2188](#) describes the Sample-based profiling implementation options, and how software can determine whether and how the Sample-based profiling registers are implemented.

The use of [DBGPCSR](#) as register 33 is deprecated.

### SE\_imp, bit[12]

Security Extensions implemented. The meanings of the values of this bit are:

- 0 The implementation does not include the Security Extensions.
- 1 The implementation includes the Security Extensions.

**Bits[11:8]** Reserved, UNK.

**Variant, bits[7:4]**

This field holds an IMPLEMENTATION DEFINED variant number. This number is incremented on functional changes. The value must match bits[23:20] of the CP15 Main ID Register.

**Revision, bits[3:0]**

This field holds an IMPLEMENTATION DEFINED revision number. This number is incremented on functional changes. Usually, this field matches the Revision field, bits[3:0] of the CP15 Main ID Register. This field is permitted to differ from [MIDR.Revision](#) only when [MIDR.Revision](#) is incremented to indicate a minor revision to functionality that has no effect on the Debug architecture, for example on an *Engineering change order* (ECO) fix. In this case the [DBGDIDR.Revision](#) value will be less than the [MIDR.Revision](#) value.

For details of the CP15 Main ID Register see:

- [MIDR, Main ID Register, VMSA on page B4-1648](#), for a VMSA implementation
- [MIDR, Main ID Register, PMSA on page B6-1892](#), for a PMSA implementation.

### C11.11.16 DBGDRAR, Debug ROM Address Register

The DBGDRAR characteristics are:

**Purpose** Defines the base physical address of a memory-mapped debug component, usually a ROM Table that locates and describes the memory-mapped debug components in the system. However, if this processor is the only memory-mapped debug component in the system, or the only memory-mapped debug component visible to this processor, then DBGDRAR defines the base physical address of this processor's debug registers.

**Usage constraints** This register is only visible in the CPI4 interface.

**Configurations** This register is required in all implementations.  
 If no memory-mapped debug components are implemented, DBGDRAR.Valid is RAZ.  
 If the implementation includes the Large Physical Address Extension, the DBGDRAR is extended to be a 64-bit register.

———— **Note** —————  
 ROM Tables only support 32-bit offsets.

Otherwise, the DBGDRAR is a 32-bit register. The 32-bit version, accessed by MRC, is always implemented.

**Attributes** A 64-bit or 32-bit RO register, see the *Configurations* description. DBGDRAR is in the [Debug identification registers](#) group, see the registers summary in [Table C11-2 on page C11-2196](#).

It is IMPLEMENTATION DEFINED how the processor determines the value that is returned as the base physical address. If the processor cannot determine the value, the Valid field in the register must be RAZ. The ARM recommended debug interface includes configuration signals to indicate both the ROM table address and whether the ROM table address is valid, see [DBGROMADDR and DBGROMADDRV on page AppxA-2348](#).

A ROM Table enables a debugger to discover other memory-mapped debug components. For more information, see the *ARM Debug Interface v5 Architecture Specification*.

The ROM Table base physical address must be aligned to a 4KB boundary. The debug component must occupy at least 4KB of physical address space, aligned to a 4KB boundary. If the debug component occupies more than 4KB of physical address space then the base physical address is at the start of the last 4KB of component address space, not the base address of the component.

#### 32-bit DBGDRAR format

The DBGDRAR 32-bit assignments are:

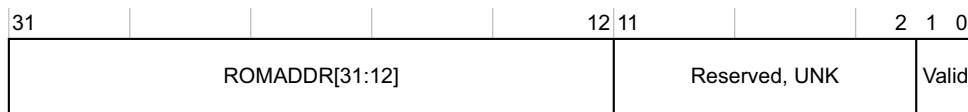

#### ROMADDR[31:12], bits[31:12]

Bits[31:12] of the debug component physical address. Bits[11:0] of the address are zero.  
 If DBGDRAR.Valid is zero the value of this field is UNKNOWN.

**Bits[11:2]** Reserved, UNK.

#### Valid, bits[1:0]

This field indicates whether the address is valid. The permitted values of this field are:  
 0b00 Address is not valid.  
 0b11 Address is valid.  
 Other values are reserved.

### 64-bit DBGDRAR format

The DBGDRAR 64-bit assignments are:

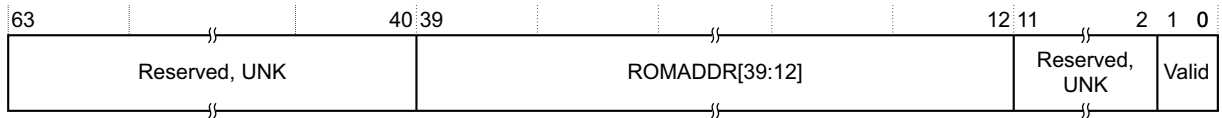

**Bits[63:40, 11:2]** Reserved, UNK.

**ROMADDR[39:12], bits[39:12]**

Bits[39:12] of the debug component physical address. Bits[11:0] of the address are zero.

If DBGDRAR.Valid is zero the value of this field is UNKNOWN.

**Valid, bits[1:0]**

This field indicates whether the ROM Table address is valid. The permitted values of this field are:

0b00 Address is not valid.

0b11 Address is valid.

Other values are reserved.

### C11.11.17 DBGDRCR, Debug Run Control Register

The DBGDRCR characteristics are:

<b>Purpose</b>	Software uses this register to: <ul style="list-style-type: none"> <li>• request the processor to enter or exit Debug state</li> <li>• clear to 0 the sticky exception bits in the <a href="#">DBGDSCR</a></li> <li>• cancel bus requests</li> <li>• clear to 0 <a href="#">DBGDSCR.PipeAdv</a>, the Sticky Pipeline Advance bit.</li> </ul>
<b>Usage constraints</b>	In v7 Debug, ARM deprecates using the CP14 interface to access DBGDRCR. In v7.1 Debug, DBGDRCR is not visible in the CP14 interface. This register is write-only. Reads through the CP14 interface in v7 Debug are UNPREDICTABLE. For reads through the memory-mapped or external debug interfaces, this register is UNK.
<b>Configurations</b>	This register is required in all implementations. If external debug over powerdown is supported, this register must be implemented in the debug power domain. However, some bits affect state that is held in the core power domain. For these bits, the effect of writing a 1 to the bit is UNPREDICTABLE: <ul style="list-style-type: none"> <li>• In any implementation when the core power domain is powered down.</li> <li>• In a v7.1 Debug implementation, when <a href="#">DBGPRSR.DLK</a> is set to 1.</li> </ul> For more information, see the field descriptions.
<b>Attributes</b>	A 32-bit WO register. DBGDRCR is in the <a href="#">Debug control and status registers</a> group, see the registers summary in <a href="#">Table C11-3 on page C11-2197</a> .

The DBGDRCR bit assignments are:

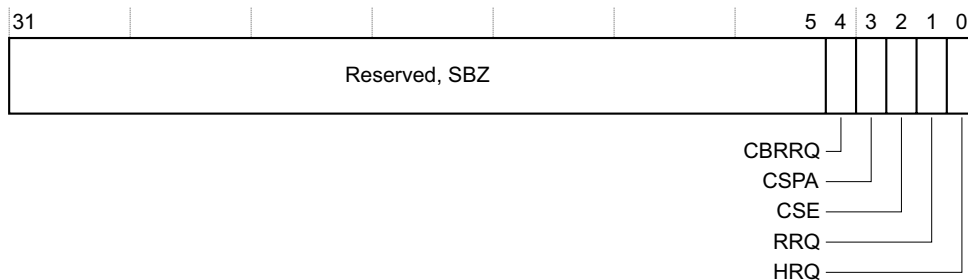

**Bits[31:5]** Reserved, SBZ.

**CBRRQ, bit[4]** Cancel Bus Requests Request. The actions on writing to this bit are:

- 0** No action.
- 1** Request cancel of pending accesses.

See [Cancel Bus Requests on page C11-2235](#). It is IMPLEMENTATION DEFINED whether this feature is supported. If this feature is not implemented, writes to this bit are ignored.

It is UNPREDICTABLE whether a write of 1 to this bit has any effect when the core power domain is powered down or, in v7.1 Debug, when [DBGPRSR.DLK](#) is set to 1.

**CSPA, bit[3]** Clear Sticky Pipeline Advance. Writing 1 to this bit clears the [DBGDSCR.PipeAdv](#) bit to 0. The actions on writing to this bit are:

- 0** No action.
- 1** Clear the [DBGDSCR.PipeAdv](#) bit to 0.

Writes to this bit are ignored:

- If the core power domain is powered down.
- In v7.1 Debug, if [DBGPRSR.DLK](#) is set to 1.

**CSE, bit[2]** Clear Sticky Exceptions. Writing 1 to this bit clears the **DBGDSCR** sticky exceptions bits to 0. The actions on writing to this bit are:

**0** No action.

**1** Clears **DBGDSCR**.{UND\_1, ADABORT\_1, SDABORT\_1} sticky exceptions bits to 0.

When the processor is in Debug state, it can exit Debug state by performing a single write to **DBGDRCR** with **DBGDRCR**.{CSE, RRQ} == 0b11. This:

- clears **DBGDSCR**.{UND\_1, ADABORT\_1, SDABORT\_1} to 0b000
- requests exit from Debug state.

If the processor is not in Debug state, writes to this bit are ignored.

———— **Note** ————

The effect of being in Non-debug state with a **DBGDSCR** sticky exceptions bit set to 1 is UNPREDICTABLE, therefore there is never a requirement for software executing in Non-debug state to write 1 to this bit.

**RRQ, bit[1]** Restart request. The actions on writing to this bit are:

**0** No action.

**1** Request exit from Debug state.

Writing 1 to this bit requests that the processor exits Debug state. This request is held until the processor exits Debug state.

Once the request has been made, the debugger can poll the **DBGDSCR**.RESTARTED bit until it reads as 1.

If the processor is not in Debug state, writes to this bit are ignored.

**HRQ, bit[0]** Halt request. The actions on writing to the this bit are:

**0** No action.

**1** Request entry to Debug state, by generating a Halt request debug event.

In an implementation that has separate core and debug power domains, a debugger can write 1 to this bit when the core domain is powered down. This makes the Halt request become pending.

If the processor is in Debug state, writes to this bit are ignored.

Once a Halt request has been made, the debugger can test for entry to Debug state as follows:

- Poll the **DBGDSCR**.HALTED bit until it reads as 1.
- In v7.1 Debug, poll the **DBGPRSR**.HALTED bit until it reads as 1. This test has the advantage that the debugger can read **DBGPRSR** when the OS Lock is set, and when the core power domain is powered down.

For more information about the effect of writing 1 to this bit, see [Halting debug events on page C3-2073](#).

## Cancel Bus Requests

When support for Cancel Bus Requests is implemented, if software writes 1 to the Cancel Bus Requests Request bit, the system cancels any pending memory accesses until Debug state is entered. This means it cancels any pending accesses to the system bus. When this request is made an implementation must abandon all data load and store accesses. It is IMPLEMENTATION DEFINED whether other accesses, including instruction fetches and cache operations, are also abandoned.

Debug state entry is the acknowledge event that clears this request.

Abandoned accesses have the following behavior:

- an abandoned data store writes an UNKNOWN value to the target address
- an abandoned data load returns an UNKNOWN value to the destination register
- an abandoned instruction fetch returns an UNKNOWN instruction for execution
- an abandoned cache operation leaves the memory system in an UNPREDICTABLE state.

However, an abandoned access does not cause any exception.

Additional memory accesses after Debug state has been entered, have UNPREDICTABLE behavior.

The number of ports on the processor and their protocols are implementation-specific and, therefore, the detailed behavior of this bit is IMPLEMENTATION DEFINED. It is also IMPLEMENTATION DEFINED whether this behavior is supported on all ports of a processor. For example, an implementation can choose not to implement this behavior on instruction fetches.

This control bit enables the debugger to release a deadlock on the system bus so that it can enter Debug state. At the point where the deadlock is released, one of the following must be pending:

- a Halt request, made by also writing 1 to DBGDRCR.HRQ
- an External debug request.

It might not be easy to infer the cause of the deadlock by reading the PC value after entering Debug state if, for example, the processor can execute beyond a deadlocked load or store.

The processor ignores any write to this bit unless invasive debug is permitted in all processor states and modes.

For details of invasive debug authentication see [Chapter C2 Invasive Debug Authentication](#).



### C11.11.18 DBGDSAR, Debug Self Address Offset Register

The DBGDSAR characteristics are:

<b>Purpose</b>	Defines the offset from the base address defined by <a href="#">DBGDRAR</a> of the physical base address of the debug registers for the processor.
<b>Usage constraints</b>	This register is only visible in the CP14 interface.  In v7.1 Debug, ARM deprecates the use of DBGDSAR. The DBGDSAR is primarily intended for self-hosted monitor debugging in a system with no CP14 interface, and v7.1 Debug does not support such implementations.
<b>Configurations</b>	This register is required in all implementations.  If <a href="#">DBGDRAR.Valid</a> is 0b00, DBGDSAR is UNKNOWN, otherwise the register is implemented as described in this section.  If no memory-mapped interface is provided, DBGDSAR.Valid is RAZ. If the base address defined by <a href="#">DBGDRAR</a> is the base address of the debug registers for the processor, then DBGDSAR.Valid is RAO and DBGDSAR.SELFOFFSET is RAZ.  In an implementation that includes the Large Physical Address Extension, the DBGDSAR is a 64-bit register.  Otherwise, the DBGDSAR is a 32-bit register. The 32-bit version, accessed by MRC, is always implemented.
<b>Attributes</b>	A 64-bit or 32-bit RO register, see the <i>Configurations</i> description. DBGDSAR is in the <a href="#">Debug identification registers</a> group, see the registers summary in <a href="#">Table C11-2 on page C11-2196</a> .

It is IMPLEMENTATION DEFINED how the processor determines the value that is returned as the debug self address offset. If the processor cannot determine the value, the Valid field in the register must be RAZ. The ARM recommended debug interface includes configuration signals to indicate both the debug self address offset and whether the debug self address offset is valid, see [DBGSELFADDR and DBGSELFADDRV on page AppxA-2348](#).

This register format applies regardless of the implemented scheme for identifying the debug self address offset.

#### 32-bit DBGDSAR format

The 32-bit DBGDSAR bit assignments are:

31		12 11		2	1	0
SELFOFFSET [31:12]			Reserved, UNK		Valid	

#### SELFOFFSET [31:12], bits[31:12]

Bits[31:12] of the two's complement offset from the base address defined by [DBGDRAR](#) to the physical address where the debug registers are mapped. Bits[11:0] of the address are zero.

If DBGDSAR.Valid is zero the value of this field is UNKNOWN.

**Bits[11:2]** Reserved, UNK.

#### Valid, bits[1:0]

This field indicates whether the debug self address offset is valid. The permitted values of this field are:

- 0b00 Offset is not valid.
- 0b11 Offset is valid.

Other values are reserved.

### 64-bit DBGDSAR format

The 64-bit DBGDSAR bit assignments are:



#### SGN, bits[63:40]

Sign extension. Each bit must be the same as DBGDSAR[39].

#### SELFOFFSET [39:12], bits[39:12]

Bits[39:12] of the two's complement offset from the base address defined by [DBGDRAR](#) to the physical address where the debug registers are mapped. Bits[11:0] of the address are zero.

If DBGDSAR.Valid is zero the value of this field is UNKNOWN.

#### Bits[11:2] Reserved, UNK.

#### Valid, bits[1:0]

This field indicates whether the debug self address offset is valid. The permitted values of this field are:

0b00 Offset is not valid.

0b11 Offset is valid.

Other values are reserved.

### C11.11.19 DBGDSCCR, Debug State Cache Control Register

The DBGDSCCR characteristics are:

<b>Purpose</b>	Controls cache behavior when the processor is in Debug state.
<b>Usage constraints</b>	There are no usage constraints.
<b>Configurations</b>	In v7 Debug, this register is required in all implementations. Some defined bits might not be implemented, unimplemented bits are RO. In v7.1 Debug, this register is not implemented.
<b>Attributes</b>	A 32-bit RW register. DBGDSCCR is in the <a href="#">Debug memory system control registers</a> group, see the registers summary in <a href="#">Table C11-8 on page C11-2202</a> . Debug logic reset values of implemented bits are UNKNOWN.

The DBGDSCCR bit assignments are:

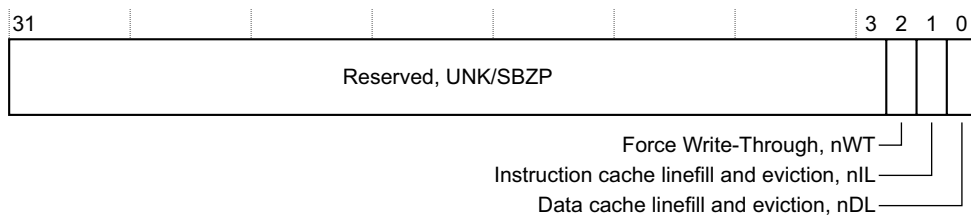

**Bits[31:3]** Reserved, UNK/SBZP.

#### Force Write-Through, nWT, bit[2]

If implemented, the possible values of this bit are:

- 0** Force Write-Through behavior for memory operations issued by a debugger when the processor is in Debug state.
- 1** Normal operation for memory operations issued by a debugger when the processor is in Debug state.

In Debug state, if the nWT bit is set to 0, when a write to memory completes the effect of the write must be visible at all levels of memory to the point of coherency. This means a debugger can write through to the point of coherency without having to perform any cache clean operations.

If implemented, the nWT control must act at all levels of memory to the point of coherency.

If the nWT control is not implemented this bit is RO, and it is IMPLEMENTATION DEFINED whether the bit is RAZ or RAO, but the processor behaves as if the bit is set to 1.

#### **Note**

The nWT bit does not force the ordering of writes, and does not force writes to complete immediately. A debugger might have to insert a barrier operations to ensure ordering.

#### Cache linefill and eviction bits, bits[1:0]

If implemented these bits are:

- nIL, bit[1]** Instruction cache, where separate data and instruction caches are implemented.
- nDL, bit[0]** Data or unified cache.

The possible values each bit are:

- 0** Request disabling of cache linefills and evictions for memory operations issued by a debugger when the processor is in Debug state.
- 1** Normal operation of cache linefills and evictions for memory operations issued by a debugger when the processor is in Debug state.

Either or both of these bits might not be implemented. A bit that is not implemented is RO, and it is IMPLEMENTATION DEFINED whether the bit is RAZ or RAO, but the processor behaves as if the bit is set to 1.

Any memory access that would be checked against a cache in Non-debug state is checked against the cache in Debug state and:

- If a match is found, the cached result is used.
- If no match is found the next level of memory is used. However, if the appropriate cache linefill and eviction bit is set to 0, the result of this access is not cached, and no cache entries are evicted.

The *next level of memory* can refer to looking in the next level of cache, or to accessing external memory, depending on the numbers of levels of cache implemented.

When the processor is in Debug state, cache maintenance operations are not affected by the nDL and nIL control bits, and have their normal architecturally-defined behavior.

The memory hint instructions PLD, PLDW, and PLI have UNPREDICTABLE behavior in Debug state when the corresponding nDL or nIL control bit is implemented and set to 0.

Because the debug logic reset values of the implemented bits are UNKNOWN, when the processor is in Debug state, before issuing instructions through the [DBGITR](#) a debugger must ensure the DBGDSCCR has a defined state.

### Permitted IMPLEMENTATION DEFINED limits

The DBGDSCCR is required. However, there can be IMPLEMENTATION DEFINED limits on its behavior. [Table C11-16](#) lists some examples of possible options for implementations.

**Table C11-16 Permitted IMPLEMENTATION DEFINED limits on DBGDSCCR behavior**

Limit	Description	Notes
Full DBGDSCCR	Bits[2:0] implemented	-
No write-back support	Bit[2] is RO <sup>a</sup>	-
No write-through support	Bit[2] is RO <sup>a</sup>	Force Write-Through feature not implemented.
No instruction cache control	Bit[1] is RO <sup>a</sup>	Instruction cache linefill and eviction disable features not implemented. Instruction fetches are disabled in Debug state. For most implementations no instruction cache accesses take place in Debug state, and nIL is not required.
Unified cache	Bit[1] is RO <sup>a</sup>	-
Cache evictions always enabled	Bits[1:0] implemented as described	nIL and nDL disable cache linefills in Debug state. However cache evictions might still take place even when these control bits are set to 0.
No linefill control	Bits[1:0] are RO <sup>a</sup>	No cache linefill and eviction disable features are implemented.

a. It is IMPLEMENTATION DEFINED whether each bit is RAZ or RAO, but the processor behaves as if each bit is set to 1.

## C11.11.20 DBGDSCR, Debug Status and Control Register

The DBGDSCR characteristics are:

<b>Purpose</b>	The main control register for the debug implementation.
<b>Usage constraints</b>	The debug implementation provides internal and external views of the DBGDSCR, DBGDSCRint and DBGDSCRext. The behavior of the register on reads of the DBGDSCR is different for the two views. For more information, see the register field descriptions and <a href="#">Internal and external views of the DBGDSCR and the DCC registers on page C8-2165</a> .
<b>Configurations</b>	This register is required in all debug implementations.  Some bit assignments differ if the implementation includes the Virtualization Extensions. See the field descriptions for details.
<b>Attributes</b>	A 32-bit register that is RW in the external view, and RO in the internal view. DBGDSCR is in the <a href="#">Debug control and status registers</a> group, see the registers summary in <a href="#">Table C11-3 on page C11-2197</a> .  For more information, see <a href="#">Access to DBGDSCR bits on page C11-2251</a> .  The debug logic reset value of bits and fields in the DBGDSCR are zero, except where stated in the bit and field descriptions.

The DBGDSCR bit assignments are:

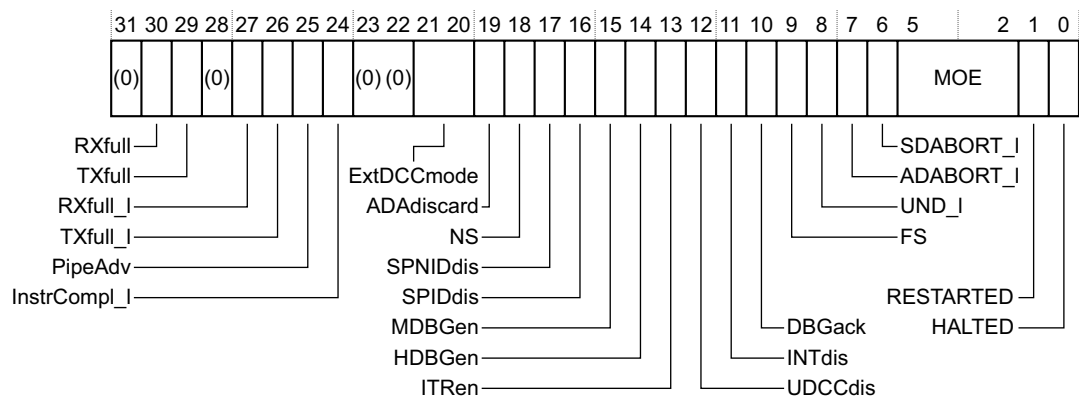

### Bits[31, 28, 23:22]

Reserved, UNK/SBZP.

### RXfull, bit[30]

**DBGDTRRX** register full. The possible values of this bit are:

- 0** DBGDTRRX register empty.
- 1** DBGDTRRX register full.

The bit is read-only except that, in a v7.1 Debug implementation, it is read/write when the OS Lock is set.

For more information about the behavior of RXfull and **DBGDTRRX**, see [Operation of the DCC and Instruction Transfer Register on page C8-2167](#).

ARM deprecates any use of a value of this bit returned by a read of DBGDSCRext using the CP14 interface, except for uses for OS save or restore in a v7.1 Debug implementation when the OS Lock is set.

### TXfull, bit[29]

DBGDTRTX register full. The possible values of this bit are:

- 0           DBGDTRTX register empty.
- 1           DBGDTRTX register full.

The bit is read-only except that, in a v7.1 Debug implementation, it is read/write when the OS Lock is set.

For more information about the behavior of TXfull and DBGDTRTX, see *Operation of the DCC and Instruction Transfer Register* on page C8-2167.

ARM deprecates any use of a value of this bit returned by a read of DBGDSCRExt using the CP14 interface, except for uses for OS save or restore in a v7.1 Debug implementation when the OS Lock is set.

### RXfull\_1, bit[27]

Latched RXfull. This controls the behavior of the processor on writes to DBGDTRRXext.

The bit is read-only except that, in a v7.1 Debug implementation, it is read/write when the OS Lock is set.

This bit is UNKNOWN:

- On reads of DBGDSCRint.
- In a v7.1 Debug implementation, on reads of DBGDSCRExt using the CP14 interface when the OS Lock is clear.

For more information about the behavior of RXfull\_1 and DBGDTRRX, see *Operation of the DCC and Instruction Transfer Register* on page C8-2167.

ARM deprecates any use of a value of this bit returned by a read of DBGDSCRExt using the CP14 interface, except for uses for OS save or restore in a v7.1 Debug implementation when the OS Lock is set.

### TXfull\_1, bit[26]

Latched TXfull. This controls the behavior of the processor on reads of DBGDTRTXext.

The bit is read-only except that, in a v7.1 Debug implementation, it is read/write when the OS Lock is set.

This bit is UNKNOWN:

- On reads of DBGDSCRint.
- In a v7.1 Debug implementation, on reads of DBGDSCRExt using the CP14 interface when the OS Lock is clear.

For more information about the behavior of TXfull\_1 and DBGDTRTX, see *Operation of the DCC and Instruction Transfer Register* on page C8-2167.

ARM deprecates any use of a value of this bit returned by a read of DBGDSCRExt using the CP14 interface, except for uses for OS save or restore in a v7.1 Debug implementation when the OS Lock is set.

### PipeAdv, bit[25]

Sticky Pipeline Advance bit. This bit is set to 1 whenever the processor pipeline advances by retiring one or more instructions. It is cleared to 0 only by a write to DBGDRCCR.CSPA.

#### ————— Note —————

The architecture does not define precisely when this bit is set to 1. It requires only that this happens periodically in Non-debug state, to indicate that software execution is progressing.

This bit is read-only.

In v7.1 Debug, this bit is UNKNOWN on reads using the CP14 interface.

This bit enables a debugger to detect that the processor is idle. In some situations this might indicate that the processor is deadlocked.

The debug logic reset value of this bit is UNKNOWN.

ARM deprecates any use of a value of this bit returned by the CP14 interface.

#### InstrCompl\_I, bit[24]

Latched Instruction Complete. This is a copy of the internal InstrCompl flag, taken on each read of DBGDSCRExt. InstrCompl signals whether the processor has completed execution of an instruction issued through DBGITR. InstrCompl is not visible directly in any register.

On a read of DBGDSCRExt when the processor is in Debug state, InstrCompl\_I always returns the current value of InstrCompl. The meanings of the values of InstrCompl\_I are:

- 0** An instruction previously issued through the DBGITR has not completed its changes to the architectural state of the processor.
- 1** All instructions previously issued through the DBGITR have completed their changes to the architectural state of the processor.

This bit is read-only.

This bit is UNKNOWN:

- When the processor is in Non-debug state.
- On reads using the CP14 interface.

Normally, InstrCompl:

- Is cleared to 0 following issue of an instruction through DBGITR.
- Becomes 1 once the instruction completes.

The taking of an exception marks the completion of the instruction. InstrCompl is set to 1 if an instruction generates an Undefined Instruction or Data Abort exception.

InstrCompl is set to 1 on entry to Debug state. For more information about the behavior of InstrCompl, InstrCompl\_I and the DBGITR when the processor is in Debug state, see [Operation of the DCC and Instruction Transfer Register on page C8-2167](#).

The debug logic reset value of this bit is UNKNOWN.

#### ExtDCCmode, bits[21:20]

External DCC access mode. This field controls the access mode for the external views of the DCC registers and the DBGITR. Possible values are:

- 0b00 Non-blocking mode.
- 0b01 Stall mode.
- 0b10 Fast mode.

The value 0b11 is reserved.

In v7.1 Debug, when the OS Lock is clear, for accesses using the CP14 interface:

- This field is UNKNOWN on reads.
- For accesses to DBGDSCRExt:
  - The field ignores writes.
  - Software must treat the field as SBZP.

For more information see [Operation of the External DCC access modes on page C8-2167](#).

ARM deprecates any use of this field by either:

- A read of DBGDSCRint.
- An access to DBGDSCRExt using the CP14 interface, except for uses for OS save or restore in a v7.1 Debug implementation when the OS Lock is set.

#### ADAdiscard, bit[19]

Asynchronous Aborts Discarded. The possible values of this bit are:

- 0** Asynchronous aborts handled normally.
- 1** On an asynchronous abort to which this bit applies, the processor sets the Sticky Asynchronous Abort bit, ADABORT\_I, to 1 but otherwise discards the abort.

———— **Note** ————

In v7 Debug this bit applies to all asynchronous aborts. v7.1 Debug restricts the asynchronous aborts to which this action applies, as described in [Asynchronous aborts and Debug state entry on page C5-2094](#).

[Asynchronous aborts and Debug state entry on page C5-2094](#) describes the conditions for setting this bit to 1.

It is IMPLEMENTATION DEFINED whether:

- This bit is read-only or read/write in Debug state.
- The hardware automatically sets this bit to 1 on entry to Debug state.

In v7.1 Debug, if this bit is RO in Debug state, then its value is UNKNOWN when read through the CP14 interface in Debug state.

For more information, see [Asynchronous aborts and Debug state entry on page C5-2094](#).

When the processor is in Non-debug state, software must treat DBGDSCR.ADAdiscard as UNK/SBZ. Setting this bit to 1 when the processor is in Non-debug state causes UNPREDICTABLE behavior.

The processor clears this bit to 0 on exit from Debug state.

**NS, bit[18]**

Non-secure state status. If the implementation includes the Security Extensions, this bit indicates whether the processor is in the Secure state. The possible values of this bit are:

- 0** The processor is in the Secure state.
- 1** The processor is in the Non-secure state.

This bit is read-only. If the processor does not implement Security Extensions, this bit is RAZ.

The debug logic reset value of this read-only status bit reflects the current status of the processor.

ARM deprecates any use of a value of this bit returned by a read using the CP14 interface.

**SPNIDdis, bit[17]**

Secure PL1 Non-Invasive Debug Disabled. This bit shows if non-invasive debug is permitted in Secure PL1 modes. The possible values of the bit are:

- 0** Non-invasive debug is permitted in Secure PL1 modes.
- 1** Non-invasive debug is not permitted in Secure PL1 modes.

This bit is read-only.

If the Security Extensions are not implemented, then PL1 modes are equivalent to Secure PL1 modes.

The debug logic reset value of this read-only status bit reflects the current status of the processor.

ARM deprecates any use of the value of this bit.

**SPIDdis, bit[16]**

Secure PL1 Invasive Debug Disabled bit. This bit shows if invasive debug is permitted in Secure PL1 modes. The possible values of the bit are:

- 0** Invasive debug is permitted in Secure PL1 modes.
- 1** Invasive debug is not permitted in Secure PL1 modes.

This bit is read-only.

If the Security Extensions are not implemented, then PL1 modes are equivalent to Secure PL1 modes.

The debug logic reset value of this read-only status bit reflects the current status of the processor.

ARM deprecates any use of the value of this bit.



### MDBGGen, bit[15]

Monitor debug-mode enable. The possible values of this bit are:

- 0** Monitor debug-mode disabled.
- 1** Monitor debug-mode enabled.

The MDBGGen bit reads as 0:

- In v7 Debug, when invasive debug is disabled in all modes and states.
- In v7.1 Debug, when both:
  - Invasive debug is disabled in all modes and states.
  - The OS Lock is clear.

In these cases, a register write updates this bit, but the bit reads as zero regardless of its programmed value.

#### ———— **Note** —————

This definition of the behavior of this bit means that whenever:

- Invasive debug is enabled but debug events are ignored because of the current mode and state, a read of the register returns the programmed value of this bit.
- At least one of the following applies, the value returned by a read of the register, and the behavior of the processor, correspond to the programmed value:
  - Invasive debug is enabled.
  - In v7.1 Debug, the OS Lock is set.

---

In v7 Debug, in a powerdown sequence, the **DBGOSSRR** saves the programmed value of the MDBGGen bit, not the value returned by reads of the **DBGDSCR**. For more information, see *The OS Save and Restore mechanism on page C7-2152*.

In v7.1 Debug, when the OS Lock is set, the MDBGGen bit is RW.

If Halting debug-mode is enabled, because the **HDBGGen** bit is set to 1, then Monitor debug-mode is disabled regardless of the value of the MDBGGen bit.

See *Chapter C2 Invasive Debug Authentication* for information about enabling invasive debug.

ARM deprecates any use of a value of this bit returned by a read of **DBGDSCRint**.

### HDBGGen, bit[14]

Halting debug-mode enable. The possible values of this bit are:

- 0** Halting debug-mode disabled.
- 1** Halting debug-mode enabled.

The HDBGGen bit reads as 0:

- In v7 Debug, in all interfaces when invasive debug is disabled in all modes and states.
- In v7.1 Debug, in the memory-mapped and external debug interfaces when both:
  - Invasive debug is disabled in all modes and states.
  - The OS Lock is clear.

In these cases, a register write updates this bit, but the bit reads as zero regardless of its programmed value.

#### ———— **Note** —————

This definition of the behavior of this bit means that for v7 Debug accesses in all interfaces, and for v7.1 Debug accesses in the memory-mapped and external debug interfaces, whenever:

- Invasive debug is enabled but debug events are ignored because of the current mode and state, a read of the register returns the programmed value of this bit.
- At least one of the following applies, the value returned by a read of the register, and the behavior of the processor, correspond to the programmed value:
  - Invasive debug is enabled.
  - In v7.1 Debug, the OS Lock is set.

In v7 Debug, in a powerdown sequence, the **DBGOSSRR** saves the programmed value of the **HDBGGen** bit, not the value returned by reads of the **DBGDSCR**. For more information, see *The OS Save and Restore mechanism on page C7-2152*.

In v7.1 Debug:

- When the OS Lock is set, this bit is RW in the CP14 and memory-mapped interfaces.
- When the OS Lock is clear, in the CP14 interface:
  - Reads of this bit return an UNKNOWN value.
  - Writes to this bit in **DBGDSCRExt** are ignored. Software must use a SBZP policy when writing to this bit in **DBGDSCRExt**.

See *Chapter C2 Invasive Debug Authentication* for information about enabling invasive debug.

ARM deprecates any use of this bit by either:

- A read of **DBGDSCRint**.
- An access to **DBGDSCRExt** using the CP14 interface, except for uses for OS save or restore in a v7.1 Debug implementation when the OS Lock is set.

### **ITRen, bit[13]**

Execute ARM instruction enable. This bit enables the execution of ARM instructions through the **DBGITR**. The possible values of this bit are:

- 0** ITR mechanism disabled.
- 1** The ITR mechanism for forcing the processor to execute instructions in Debug state via the external debug interface is enabled.

When the processor is in Non-debug state, software accessing **DBGDSCR** must treat this bit as UNK/SBZ. Setting this bit to 1 when the processor is in Non-debug state causes UNPREDICTABLE behavior.

The effect of writing to **DBGITR** when this bit is set to 0 is UNPREDICTABLE.

In v7.1 Debug, in Debug state, for accesses to **DBGDSCR** using the CP14 interface:

- This field is UNKNOWN on reads.
- For accesses to **DBGDSCRExt**:
  - The field ignores writes.
  - Software must treat the field as SBOP.

In v7 Debug, ARM deprecates setting this bit to 0 through the CP14 interface when the processor is in Debug state.

### **UDCCdis, bit[12]**

User mode access to *Debug Communications Channel* (DCC) disable. The possible values of this bit are:

- 0** User mode access to DCC enabled.
- 1** User mode access to DCC disabled.

When this bit is set to 1, if a User mode process tries to access the **DBGDIDR**, **DBGDRAR**, **DBGDSAR**, **DBGDSCRint**, **DBGDTRRXint**, or **DBGDTRTXint** through CP14 operations, an Undefined Instruction exception is generated.

#### **Note**

All other CP14 registers are UNDEFINED in User mode, regardless of the value of this bit. Therefore, setting this bit to 1 prevents User mode access to any CP14 debug register.

ARM deprecates any use of a value of this bit returned by a read of **DBGDSCRint**.

### INTdis, bit[11]

Interrupts Disable. Setting this bit to 1 masks the taking of IRQs and FIQs. The possible values of this bit are:

- 0 Interrupts enabled.
- 1 Interrupts disabled.

In v7.1 Debug, when the OS Lock is clear, for accesses using the CP14 interface:

- This field is UNKNOWN on reads.
- For accesses to DBGDSCRExt:
  - The field ignores writes.
  - Software must treat the field as SBZP.

If the external debugger needs to execute a piece of software in Non-debug state as part of the debugging process, but that software must not be interrupted, the external debugger sets this bit to 1.

For example, when single stepping instructions in a system with a periodic timer interrupt, the period of the interrupt is likely to be more frequent than the stepping frequency of the debugger. In this situation, if the debugger steps the target without setting the INTdis bit to 1 for the duration of the step, the interrupt is pending. This means that, if interrupts are enabled in the CPSR, the interrupt is taken as soon as the processor exits Debug state.

The INTdis bit is ignored if at least one of the following applies:

- DBGDSCR.{MDBGen, HDBGen} == 0b00.
- Invasive debug is disabled.

For more information about enabling invasive debug see [Chapter C2 Invasive Debug Authentication](#).

#### ———— Note ————

If implemented, the *ISR* always reflects the status of the IRQ and FIQ signals, regardless of the value of the INTdis bit.

ARM deprecates any use of a value of this bit returned by either:

- A read of DBGDSCRint.
- A read of DBGDSCRExt using the CP14 interface, except for uses for OS save or restore in a v7.1 Debug implementation when the OS Lock is set.

### DBGack, bit[10]

Force Debug Acknowledge. A debugger can use this bit to force any implemented debug acknowledge output signals to be asserted. The possible values of this bit are:

- 0 Debug acknowledge signals under normal processor control.
- 1 Debug acknowledge signals asserted, regardless of the processor state.

In v7.1 Debug, when the OS Lock is clear, for accesses using the CP14 interface:

- This field is UNKNOWN on reads.
- For accesses to DBGDSCRExt:
  - The field ignores writes.
  - Software must treat the field as SBZP.

For details of the recommended external debug interface, see [Run-control and cross-triggering signals on page AppxA-2340](#) and [DBGACK and DBGCPUDONE on page AppxA-2342](#).

If a debugger sets this bit to 1, it can then cause the processor to execute instructions in Non-debug state, while the rest of the system behaves as if the processor is in Debug state.

#### ———— Note ————

The effect of setting DBGack to 1 takes no account of whether invasive debug is enabled or permitted. This means it asserts the debug acknowledge signals regardless of the invasive debug authentication settings.

ARM deprecates any use of a value of this bit returned by either:

- A read of DBGDSCRint.
- A read of DBGDSCRExt using the CP14 interface, except for uses for OS save or restore in a v7.1 Debug implementation when the OS Lock is set.

#### Bit[9], Implementation does not include the Virtualization Extensions

Reserved, UNK/SBZP.

#### FS, bit[9], Implementation includes the Virtualization Extensions

Fault status. This bit is updated on every Data Abort exception generated in Debug state, and might indicate that the exception syndrome information was written to the PL2 exception syndrome registers. The possible values are:

- 0** Software must use the current state and mode and the value of [HCR.TGE](#) to determine which of the following sets of registers holds information about the Data Abort exception:
- The PL1 fault reporting registers, meaning the [DFSR](#) and [DFAR](#), and the [ADFSR](#) if it is implemented.
  - The PL2 fault syndrome registers, meaning the [HSR](#), [HDFAR](#), and [HPFAR](#), and the [HADFSR](#) if it is implemented.
- 1** Fault status information was written to the PL2 fault syndrome registers.

#### Note

- A Data Abort Exception always updates either the [DFSR](#) or the [HSR](#). Whether any other registers are updated depends on the cause of the exception.
- A debugger uses this bit in determining where the fault information for a Data Abort is held.

A Data Abort exception generated in Debug state in a Non-secure PL1 or PL0 mode sets this bit to:

- 1** If the exception was generated by a stage 2 abort, meaning one of:
- An MMU fault from a stage 2 address translation.
  - An Alignment fault generated because the stage 2 translation identifies the target of an unaligned access as Device or Strongly-ordered memory.
  - A synchronous external abort that occurs on a stage 2 address translation.

#### An UNKNOWN value, 0 or 1

If [HCR.TGE](#) is set to 1 and the exception was generated by one of:

- An Alignment fault other than an Alignment fault caused by an unaligned access to Device or Strongly-ordered memory.
- A synchronous external abort other than a synchronous external abort that occurs on a stage 2 address translation.

These cases always write the fault status information to the PL2 fault syndrome registers, regardless of whether they set the FS bit to 1.

- 0** For any other Data Abort exception generated in a Non-secure PL1 or PL0 mode.

A Data Abort exception generated in Debug state in the Non-secure PL2 mode sets this bit to 0.

A Data Abort exception generated in Debug state in Secure state sets this bit to 0.

For more information see [Exceptions in Debug state on page C5-2105](#).

In Debug state, for accesses using the CP14 interface:

- This field is UNKNOWN on reads.
- For accesses to DBGDSCRExt:
  - The field ignores writes.
  - Software must treat the field as SBZP.

When the processor is in Non-debug state, this bit is not set to 1 by any Data Abort exception, and this bit is UNK/SBZP.

The value of this bit is not changed by writes to [DBGDRCR.CSE](#), Clear sticky exceptions.

The debug logic reset value of this bit is UNKNOWN.

#### UND\_1, bit[8]

Sticky Undefined Instruction. This bit is set to 1 by any Undefined Instruction exceptions generated by instructions issued to the processor while in Debug state. The possible values of this bit are:

- 0** No Undefined Instruction exception has been generated since the last time this bit was cleared to 0.
- 1** An Undefined Instruction exception has been generated since the last time this bit was cleared to 0.

This bit is read-only.

In v7.1 Debug, when the processor is in Debug state, this bit is UNKNOWN on reads using the CP14 interface.

This bit is cleared to 0 by writing to [DBGDRCR.CSE](#).

Exiting Debug state with this bit set to 1 causes UNPREDICTABLE behavior.

When the processor is in Non-debug state this bit is not set to 1 by an Undefined Instruction exception.

For more information, see [Exceptions in Debug state on page C5-2105](#).

#### ADABORT\_1, bit[7]

Sticky Asynchronous Abort. When the ADAdiscard bit, bit[19], is set to 1, ADABORT\_1 is set to 1 by any asynchronous abort that occurs when the processor is in Debug state.

The possible values of this bit are:

- 0** No asynchronous abort has been generated since the last time this bit was cleared to 0.
- 1** Since the last time this bit was cleared to 0, an asynchronous abort has been generated while ADAdiscard was set to 1.

#### ———— Note —————

When ADAdiscard is set to 1, and the processor is in Debug state, any asynchronous abort sets ADABORT\_1 to 1:

- In v7 Debug the asynchronous abort is discarded.
- In v7.1 it is IMPLEMENTATION DEFINED which asynchronous aborts are discarded, but ADABORT\_1 is set to 1 regardless of whether the abort is discarded.

This bit is read-only.

In v7.1 Debug, when the processor is in Debug state, this bit is UNKNOWN on reads using the CP14 interface.

This bit is cleared to 0 by writing to [DBGDRCR.CSE](#).

Exiting Debug state with this bit set to 1 causes UNPREDICTABLE behavior.

When the processor is in Non-debug state this bit is not set to 1 by an asynchronous abort.

For more information, see the information about asynchronous aborts in [Exceptions in Debug state on page C5-2105](#).

#### SDABORT\_1, bit[6]

Sticky Synchronous Data Abort. This bit is set to 1 by any Data Abort exception that is generated synchronously when the processor is in Debug state. The possible values of this bit are:

- 0** No synchronous Data Abort exception has been generated since the last time this bit was cleared to 0.
- 1** A synchronous Data Abort exception has been generated since the last time this bit was cleared to 0.

This bit is read-only.

In v7.1 Debug, when the processor is in Debug state, this bit is UNKNOWN on reads using the CP14 interface.

The behavior of the `DBGITR` depends on the value of the `SDABORT_1` bit, see [The Sticky Synchronous Data Abort bit and issuing instructions from DBGITR on page C8-2170](#).

Exiting Debug state with this bit set to 1 causes UNPREDICTABLE behavior.

This bit is cleared to 0 by writing to `DBGDRCR.CSE`.

If the processor is in Non-debug state this bit is not set to 1 by a synchronous Data Abort exception.

For more information, see [Exceptions in Debug state on page C5-2105](#).

#### MOE, bits[5:2]

Method of Debug entry. For details of this field see [Method of Debug entry on page C11-2255](#).

#### RESTARTED, bit[1]

Processor Restarted. The possible values of this bit are:

- 0** The processor is exiting Debug state. This bit only reads as 0 between receiving a restart request, and restarting Non-debug state operation.
- 1** The processor has exited Debug state. This bit remains set to 1 if the processor re-enters Debug state.

This bit is read-only.

After making a restart request, the debugger can poll this bit until it is set to 1. At that point it knows that the restart request has taken effect and the processor has exited Debug state.

#### ———— Note —————

Polling the HALTED bit until it is set to 0 is not a reliable way for a debugger to determine whether the processor has left Debug state, because the processor might re-enter Debug state as a result of another debug event before the debugger samples the `DBGDSCR`.

See [Chapter C5 Debug State](#) for a definition of Debug state.

The debug logic reset value of this read-only status bit reflects the current status of the processor.

In v7.1 Debug, when the processor is in Debug state, the value of this bit is UNKNOWN when read using the CP14 interface.

ARM deprecates any use of a value of this bit returned by a read using the CP14 interface.

#### HALTED, bit[0]

Processor Halted. The possible values of this bit are:

- 0** The processor is in Non-debug state.
- 1** The processor is in Debug state.

#### ———— Note —————

Between receiving a restart request and restarting Non-debug state operation, the processor is in Debug state and this bit reads as 1.

This bit is read-only.

After programming a debug event, the external debugger can poll this bit until it is set to 1. At that point it knows that the processor has entered Debug state.

See [Chapter C5 Debug State](#) for a definition of Debug state.

The debug logic reset value of this read-only status bit reflects the current status of the processor.

In v7.1 Debug, when the processor is in Debug state, the value of this bit is UNKNOWN when read using the CP14 interface.

ARM deprecates any use of a value of this bit returned by a read using the CP14 interface.

## Access to DBGDSCR bits

The following tables show the behavior of access to the DBGDSCR bits:

- For a v7 Debug implementation:
  - [Table C11-17](#) shows the behavior of accesses in Non-debug state.
  - [Table C11-18 on page C11-2252](#) shows the bits with different behavior in Debug state.
- For a v7.1 Debug implementation:
  - [Table C11-19 on page C11-2253](#) shows the behavior of accesses in Non-debug state with the OS Lock clear.
  - [Table C11-20 on page C11-2254](#) shows the bits with different behavior in when the OS Lock is set.
  - [Table C11-21 on page C11-2255](#) shows the bits with different behavior in Debug state.

[Table C11-17](#) shows the behavior of accesses to each field of the DBGDSCR in v7 Debug, in Non-debug state.

**Table C11-17 DBGDSCR bit access in Non-debug state, v7 Debug**

Bits	Field name	DBGEN	DBGDSCRint	DBGDSCRext
[31]	Reserved	-	-	-
[30]	RXfull	-	RO	RO <sup>a</sup>
[29]	TXfull	-	RO	RO <sup>a</sup>
[28]	Reserved	-	-	-
[27]	RXfull_1 <sup>a</sup>	-	UNKNOWN	Same as RXfull
[26]	TXfull_1 <sup>a</sup>	-	UNKNOWN	Same as TXfull
[25]	PipeAdv <sup>a</sup>	-	RO	RO
[24]	InstrComp1_1 <sup>a, b</sup>	-	UNKNOWN	UNKNOWN
[23:22]	Reserved	-	-	-
[21:20]	ExtDCCmode <sup>a</sup>	-	RO	RW
[19]	ADAdiscard <sup>a, b</sup>	-	UNK	UNK/SBZ <sup>c</sup>
[18]	NS <sup>a</sup>	-	RO	RO
[17]	SPNIDdis <sup>a</sup>	-	RO	RO
[16]	SPIDdis <sup>a</sup>	-	RO	RO
[15]	MDBGGen	HIGH	RO <sup>a</sup>	RW
		LOW	RAZ <sup>a</sup>	Writable, RAZ <sup>d</sup>
[14]	HDBGGen <sup>a</sup>	HIGH	RO	RW
		LOW	RAZ	Writable, RAZ <sup>d</sup>
[13]	ITRen <sup>a, b</sup>	-	UNK	UNK/SBZ <sup>c</sup>
[12]	UDCCdis	-	RO <sup>a</sup>	RW
[11]	INTdis <sup>a</sup>	-	RO	RW
[10]	DBGack <sup>a</sup>	-	RO	RW

**Table C11-17 DBGDSCR bit access in Non-debug state, v7 Debug (continued)**

Bits	Field name	DBGEN	DBGDSCRint	DBGDSCRext
[9]	Reserved	-	-	-
[8]	UND_1 <sup>b</sup>	-	UNK	UNK/SBZP
[7]	ADABORT_1 <sup>b</sup>	-	UNK	UNK/SBZP
[6]	SDABORT_1 <sup>b</sup>	-	UNK	UNK/SBZP
[5:2]	MOE	-	RO	RW
[1]	RESTARTED <sup>a, b</sup>	-	RAO	RAO/WI
[0]	HALTED <sup>a, b</sup>	-	RAZ	RAZ/WI

- a. ARM deprecates some or all uses of this field, see the field description for more information.
- b. Access to this bit or field is modified in Debug state. See [Table C11-18](#) for details.
- c. See the bit description for more information about the behavior of this bit.
- d. Bit is writable, but reads-as-zero. If **DBGEN** goes HIGH, the most recently written value is exposed.

[Table C11-18](#) shows how the behavior of accesses to some fields of the DBGDSCR in v7 Debug changes when in Debug state. Fields not shown in [Table C11-18](#) behave as shown in [Table C11-17](#) on [page C11-2251](#).

**Table C11-18 DBGDSCR bits with modified access in Debug state, v7 Debug**

Bits	Field name	DBGDSCRint	DBGDSCRext
[24]	InstrCompl_1	UNKNOWN	RO <sup>a</sup>
[19]	ADAdiscard	RO	IMPLEMENTATION DEFINED <sup>b</sup>
[13]	ITRen	RO	RW
[8]	UND_1	RO	RO
[7]	ADABORT_1	RO	RO
[6]	SDABORT_1	RAZ <sup>c</sup>	RO
[1]	RESTARTED	RAO	RAO/WI <sup>d</sup>
[0]	HALTED	RAO	RAO/WI

- a. UNKNOWN when DBGDSCRext is read through the CP14 interface.
- b. It is IMPLEMENTATION DEFINED whether this bit is RO or RW.
- c. Can never read as 1 because the CP14 interface cannot be accessed when SDABORT\_1==1.
- d. Whilst exiting Debug state, this bit reads-as-zero. The CP14 interface cannot be accessed whilst exiting from Debug state.

[Table C11-19](#) on [page C11-2253](#) shows the behavior of accesses to each field of the DBGDSCR, in v7.1 Debug, when in Non-debug state, with the OS Lock clear.



**Table C11-19 DBGDSR bit access in Non-debug state with OS Lock clear, v7.1 Debug**

Bits	Field name	DBGEN	DBGDSRint, CP14 interface	DBGDSRext, CP14 interface	DBGDSRext, memory-mapped and external debug interfaces
[31]	Reserved	-	-	-	-
[30]	RXfull <sup>a</sup>	-	RO	RO <sup>b, c</sup>	RO
[29]	TXfull <sup>a</sup>	-	RO	RO <sup>b, c</sup>	RO
[28]	Reserved	-	-	-	-
[27]	RXfull_1 <sup>a</sup>	-	UNKNOWN	UNKNOWN <sup>d</sup>	Same as RXfull
[26]	TXfull_1 <sup>a</sup>	-	UNKNOWN	UNKNOWN <sup>d</sup>	Same as TXfull
[25]	PipeAdv	-	UNKNOWN	UNKNOWN <sup>d</sup>	RO
[24]	InstrCompl_1 <sup>e</sup>	-	UNKNOWN	UNKNOWN <sup>d</sup>	UNKNOWN
[23:22]	Reserved	-	-	-	-
[21:20]	ExtDCCmode <sup>a</sup>	-	UNKNOWN	UNKNOWN <sup>d</sup>	RW
[19]	ADAdiscard <sup>e</sup>	-	UNK	UNK/SBZ <sup>f</sup>	UNK/SBZ <sup>f</sup>
[18]	NS	-	RO <sup>b</sup>	RO <sup>b, c</sup>	RO
[17]	SPNIDdis	-	RO <sup>b</sup>	RO <sup>b, c</sup>	RO <sup>b</sup>
[16]	SPIDdis	-	RO <sup>b</sup>	RO <sup>b, c</sup>	RO <sup>b</sup>
[15]	MDBGen <sup>a</sup>	HIGH	RO <sup>b</sup>	RW	RW
		LOW	RAZ <sup>b</sup>	Writable, RAZ <sup>g</sup>	Writable, RAZ <sup>g</sup>
[14]	HDBGen <sup>a</sup>	HIGH	UNKNOWN	UNKNOWN <sup>d</sup>	RW
		LOW	UNKNOWN	UNKNOWN <sup>d</sup>	Writable, RAZ <sup>g</sup>
[13]	ITRen <sup>e</sup>	-	UNK	UNK/SBZ <sup>f</sup>	UNK/SBZ <sup>f</sup>
[12]	UDCCdis	-	RO <sup>b</sup>	RW	RW
[11]	INTdis <sup>a</sup>	-	UNKNOWN	UNKNOWN <sup>d</sup>	RW
[10]	DBGack <sup>a</sup>	-	UNKNOWN	UNKNOWN <sup>d</sup>	RW
[9]	FS <sup>e, h</sup>	-	UNK	UNK/SBZP	UNK/SBZP
[8]	UND_1 <sup>e</sup>	-	UNK	UNK/SBZP	UNK/SBZP
[7]	ADABORT_1 <sup>e</sup>	-	UNK	UNK/SBZP	UNK/SBZP
[6]	SDABORT_1 <sup>e</sup>	-	UNK	UNK/SBZP	UNK/SBZP
[5:2]	MOE	-	RO	RW	RW

**Table C11-19 DBGDSCR bit access in Non-debug state with OS Lock clear, v7.1 Debug (continued)**

Bits	Field name	DBGEN	DBGDSCRint, CP14 interface	DBGDSCRExt, CP14 interface	DBGDSCRExt, memory-mapped and external debug interfaces
[1]	RESTARTED <sup>e</sup>	-	UNKNOWN	UNKNOWN <sup>d</sup>	RAO/WI
[0]	HALTED <sup>e</sup>	-	UNK	UNK/SBZP	RAZ/WI

- a. Access to this bit or field is modified in the CP14 and memory-mapped interfaces with OS Lock set. See [Table C11-20](#) for details.
- b. ARM deprecates some or all uses of this field, see the field description for more information.
- c. Reads return an UNKNOWN value.
- d. Reads return an UNKNOWN value. Software must treat as SBZP on writes. Hardware must ignore writes.
- e. Access to this bit is modified in Debug state. See [Table C11-21 on page C11-2255](#) for details.
- f. See the bit description for more information about the behavior of this bit.
- g. Bit is writable, but reads-as-zero. If **DBGEN** goes HIGH, the most recently written value is exposed.
- h. Only if the implementation includes the Virtualization Extensions.

[Table C11-20](#) shows how the behavior of accesses through the CP14 and memory-mapped interface changes for some fields of the DBGDSCR in v7.1 Debug when the OS Lock is set. Fields not shown in [Table C11-20](#) behave as shown in [Table C11-19 on page C11-2253](#).

**Table C11-20 DBGDSCRExt bits with modified access when OS Lock is set, CP14 and memory-mapped interfaces, v7.1 Debug**

Bits	Field name	Access
[30]	RXfull	RW
[29]	TXfull	RW
[27]	RXfull_1	RW <sup>a</sup>
[26]	TXfull_1	RW <sup>a</sup>
[21:20]	ExtDCCmode	RW <sup>a</sup>
[15]	MDBGGen	RW <sup>b</sup>
[14]	HDBGGen	RW <sup>a, b</sup>
[11]	INTdis	RW <sup>a</sup>
[10]	DBGack	RW <sup>a</sup>

- a. OS Save and Restore software must not ascribe any meaning to these bits when saving or restoring them.
- b. When the OS Lock is set, the effect of some accesses reading as zero when **DBGEN** is LOW is disabled, see the bit descriptions for more information.

**Note**

In v7.1 Debug, when the OS Lock is set, reads of DBGDSCRint through the CP14 interface are UNPREDICTABLE, and accesses to DBGDSCRExt through the external debug interface return an error.

Table C11-21 shows how the behavior of accesses to some fields of the DBGDSCR changes in v7.1 Debug when in Debug state. Fields not shown in Table C11-21 behave as shown in Table C11-19 on page C11-2253.

**Table C11-21 DBGDSCRext bits with modified access in Debug state, v7.1 Debug**

Bit	Field name	DBGDSCRint, CP14 interface	DBGDSCRext, CP14 interface	DBGDSCRext, memory-mapped and external debug interfaces
[24]	InstrCompl_1	UNKNOWN	UNKNOWN <sup>a</sup>	RO
[19]	ADAdiscard	UNKNOWN	IMPLEMENTATION DEFINED <sup>b</sup>	IMPLEMENTATION DEFINED <sup>b</sup>
[13]	ITRen	UNKNOWN	UNKNOWN <sup>c</sup>	RW
[9]	FS	UNKNOWN	UNKNOWN <sup>a</sup>	RW
[8]	UND_1	UNKNOWN	UNKNOWN <sup>a</sup>	RO
[7]	ADABORT_1	UNKNOWN	UNKNOWN <sup>a</sup>	RO
[6]	SDABORT_1	UNKNOWN	UNKNOWN <sup>a</sup>	RO
[1]	RESTARTED	UNKNOWN	UNKNOWN <sup>a</sup>	RAO/WI <sup>d</sup>
[0]	HALTED	UNKNOWN	UNKNOWN <sup>a</sup>	RAO/WI

- a. Reads return an UNKNOWN value. Software must treat as SBZP on writes. Hardware must ignore writes.
- b. It is IMPLEMENTATION DEFINED whether this bit is RO or RW in Debug state. If the bit is RO its value is UNKNOWN when read through the CP14 interface in Debug state.
- c. Reads return an UNKNOWN value. Software must treat as SBOP on writes. Hardware must ignore writes.
- d. Whilst exiting Debug state, this bit reads-as-zero. The CP14 interface cannot be accessed whilst exiting from Debug state.

### Method of Debug entry

The DBGDSCR.MOE field indicates the method of debug entry. Table C11-22 shows the meanings of the possible values of the DBGDSCR.MOE field, and also shows the section where the corresponding debug event is described.

**Table C11-22 Meaning of Method of Debug Entry values**

MOE bits	Debug entry caused by:	Section
0b0000	Halt request debug event	<a href="#">Halting debug events on page C3-2073</a>
0b0001	Breakpoint debug event	<a href="#">Breakpoint debug events on page C3-2039</a>
0b0010	Asynchronous watchpoint debug event	<a href="#">Watchpoint debug events on page C3-2057</a>
0b0011	BKPT instruction debug event	<a href="#">BKPT instruction debug events on page C3-2038</a>
0b0100	External debug request debug event	<a href="#">Halting debug events on page C3-2073</a>
0b0101	Vector catch debug event	<a href="#">Vector catch debug events on page C3-2065</a>
0b0110, 0b0111	Reserved	-
0b1000	OS Unlock catch debug event	<a href="#">Halting debug events on page C3-2073</a>
0b1001	Reserved	-
0b1010	Synchronous watchpoint debug event	<a href="#">Watchpoint debug events on page C3-2057</a>
0b1011-0b1111	Reserved	-

A Prefetch Abort or Data Abort exception handler can determine whether a debug event occurred by checking the value of the relevant Fault Status Register, [IFSR](#) or [DFSR](#). It then uses the DBGDSCR.MOE bits to determine the specific debug event.

When debug is disabled, and when debug events are not permitted, the BKPT instruction generates a debug exception rather than being ignored. This sets the DBGDSCR.MOE and CP15 registers as if a BKPT instruction debug exception occurred. For more information, see [Debug exception on BKPT instruction, Breakpoint, or Vector catch debug events on page C4-2088](#). For security reasons, monitor software might need to check that debug was enabled and that the debug event was permitted before communicating with an external debugger.

## C11.11.21 DBGDSMCR, Debug State MMU Control Register

The DBGDSMCR characteristics are:

<b>Purpose</b>	Controls TLB behavior when the processor is in Debug state.
<b>Usage constraints</b>	There are no usage constraints.
<b>Configurations</b>	In v7 Debug, this register is required in all implementations. Some defined bits might not be implemented, unimplemented bits are RO. In v7.1 Debug, this register is not implemented.
<b>Attributes</b>	A 32-bit RW register. DBGDSMCR is in the <a href="#">Debug memory system control registers</a> group, see the registers summary in <a href="#">Table C11-8 on page C11-2202</a> . Debug logic reset values are UNKNOWN.

The DBGDSMCR bit assignments are:

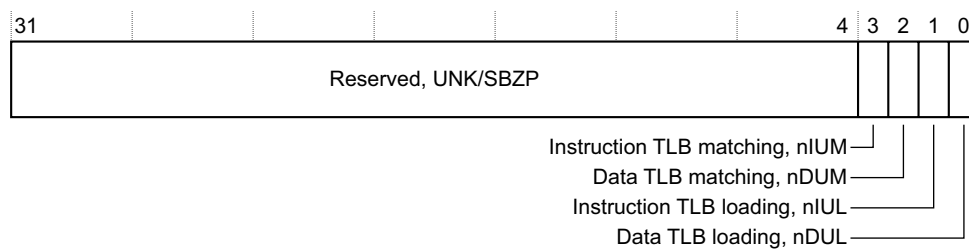

**Bits[31:4]** Reserved, UNK/SBZP.

### TLB matching bits, bits[3:2]

If implemented, these bits are:

- nIUM, bit[3]** Instruction TLB matching bit, where separate Data and Instruction TLBs are implemented.
- nDUM, bit[2]** Data or Unified TLB matching bit.

The possible values of each bit are:

- 0** Request disabling of TLB matching for memory operations issued by a debugger when the processor is in Debug state.
- 1** Normal operation of TLB matching for memory operations issued by a debugger when the processor is in Debug state.

Either or both of these bits might not be implemented. A bit that is not implemented is RO, and it is IMPLEMENTATION DEFINED whether the bit is RAZ or RAO, but the processor behaves as if the bit is set to 1.

When TLB matching is disabled:

- Any memory access that would be checked against a TLB in Non-debug state is not checked against the TLB.
- For every access the next level of translation is performed and used for the access, but the results are not cached in the TLB, and no TLB entries are evicted.

The *next level of translation* might mean looking in the next level TLB, or doing a translation table walk, depending on the numbers of levels of TLB implemented.

### ————— Note —————

If TLB matching is disabled, and TLB maintenance functions have not been correctly performed by the system being debugged, for example, if the TLB has not been flushed following a change to the translation tables, memory accesses made by the debugger might not undergo the same virtual to physical memory mappings as the application being debugged.

A debugger can create temporary alternative memory mappings by altering the contents of the external translation tables and disabling all levels of TLB matching. However, for normal debugging operations, ARM recommends that any implemented TLB matching bit is set to 1.

#### TLB loading bits, bits[1:0]

If implemented, these bits are:

**nIUL, bit[1]** Instruction TLB loading bit, where separate Data and Instruction TLBs are implemented.

**nDUL, bit[0]** Data or Unified TLB loading bit.

The possible values of each bit are:

**0** Request disabling of TLB load and flush for memory operations issued by a debugger when the processor is in Debug state.

**1** Normal operation of TLB loading and flushing for memory operations issued by a debugger when the processor is in Debug state.

Either or both of these bits might not be implemented. A bit that is not implemented is RO, and it is IMPLEMENTATION DEFINED whether the bit is RAZ or RAO, but the processor behaves as if the bit is set to 1.

When TLB load and flush is disabled, all memory accesses normally checked against a TLB are checked against the TLB. If a match is found, the cached result is used. If no match is found the next level of translation is performed, but the result is not cached in the TLB, and no TLB entries are evicted.

The *next level of translation* might mean looking in the next level TLB, or doing a translation table walk, depending on the numbers of levels of TLB implemented.

In Debug state, TLB maintenance operations are not affected by the nDUL and nIUL control bits, and have their normal architecturally-defined behavior.

Because the debug logic reset values of the implemented bits are UNKNOWN, when the processor is in Debug state, before issuing instructions through the [DBGITR](#) a debugger must ensure the DBGDSMCR has a defined state.

#### Permitted IMPLEMENTATION DEFINED limits

The DBGDSMCR is required. However, there can be IMPLEMENTATION DEFINED limits on its behavior. [Table C11-23](#) lists six permitted options for implementations. Some of these options are orthogonal.

**Table C11-23 Permitted IMPLEMENTATION DEFINED limits on DBGDSMCR behavior**

Limit	Description	Notes
Full DBGDSMCR	Bits[3:0] implemented	-
No instruction TLB controls	Bits[3, 1] are RO <sup>a</sup>	Instruction fetches disabled in Debug state. For most implementations no instruction TLB accesses take place in Debug state, and nIUL and nIUM are not required.
Unified TLB	Bits[3, 1] are RO <sup>a</sup>	-
No matching control	Bits[3:2] are RO <sup>a</sup>	TLB matching disable features not implemented.
TLB evictions always enabled	Bits[1:0] implemented as described	nIUL and nDUL disable TLB loading in Debug state. However TLB evictions can still take place even when these control bits are set to 0.
No loading control	Bits[1:0] are RO <sup>a</sup>	TLB loading disable features not implemented.

a. It is IMPLEMENTATION DEFINED whether each bit is RAZ or RAO, but the processor behaves as if each bit is set to 1.

## C11.11.22 DBGDTRRX, Host to Target Data Transfer register

The DBGDTRRX characteristics are:

- Purpose** Transfers data from an external host to the ARM processor. For example it is used by a debugger transferring commands and data to a debug target. It is a component of the *Debug Communication Channel* (DCC).
- Usage constraints** The behavior of accesses to DBGDTRRX depends on:
- which view is accessed, see *Configurations* below
  - the values of bits in the [DBGDSCR](#)
  - locks applied to the register.
- For more information, see [Behavior of accesses to DBGDTRRX on page C8-2172](#), and also [Summary of the v7 Debug register interfaces on page C6-2128](#) and [Summary of the v7.1 Debug register interfaces on page C6-2137](#).
- ARM deprecates reads and writes of the external view of this register through the CP14 interface when the OS Lock is not set.
- Configurations** This register is required in all implementations.
- All debug implementations provide both internal and external views of DBGDTRRX, see [Internal and external views of the DBGDSCR and the DCC registers on page C8-2165](#).
- Attributes** A 32-bit register that is RW in the external view and RO in the internal view. DBGDTRRX is in the [Debug instruction transfer and data transfer registers](#) group, see the registers summary in [Table C11-4 on page C11-2198](#).
- The debug logic reset value of DBGDTRRX is UNKNOWN.

The DBGDTRRX bit assignments are:

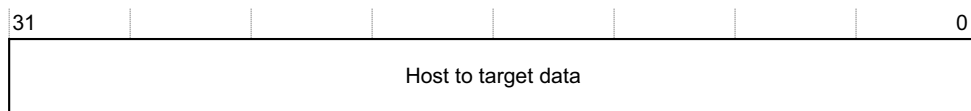

### Host to target data, bits[31:0]

One word of data for transfer from the debug host to the debug target.

For information about the behavior of accesses to DBGDTRRX see [Behavior of accesses to DBGDTRRX on page C8-2172](#).

### C11.11.23 DBGDTRTX, Target to Host Data Transfer register

The DBGDTRTX characteristics are:

**Purpose** Transfers data from the ARM processor to an external host. For example it is used by a debug target to transfer data to the debugger. It is a component of the *Debug Communication Channel* (DCC).

**Usage constraints** The behavior of accesses to DBGDTRTX depends on:

- which view is accessed, see *Configurations*
- the values of bits in the **DBGDSCR**
- locks applied to the register.

For more information, see *Behavior of accesses to DBGDTRTX* on page C8-2173, and also *Summary of the v7 Debug register interfaces* on page C6-2128 and *Summary of the v7.1 Debug register interfaces* on page C6-2137.

ARM deprecates reads and writes of the external view of this register through the CP14 interface when the OS Lock is not set.

**Configurations** This register is required in all implementations.  
All debug implementations provide both internal and external views of DBGDTRTX, see *Internal and external views of the DBGDSCR and the DCC registers* on page C8-2165.

**Attributes** A 32-bit register that is RW in the external view and WO in the internal view. DBGDTRTX is in the *Debug instruction transfer and data transfer registers* group, see the registers summary in *Table C11-4* on page C11-2198.

The debug logic reset value of DBGDTRTX is UNKNOWN.

The DBGDTRTX bit assignments are:

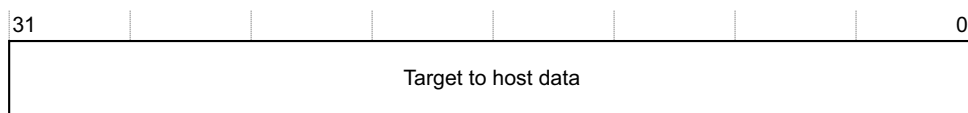

#### Target to host data, bits[31:0]

One word of data for transfer from the debug target to the debug host.

For information about the behavior of accesses to DBGDTRTX see *Behavior of accesses to DBGDTRTX* on page C8-2173.



### C11.11.24 DBGEACR, External Auxiliary Control Register

The DBGEACR characteristics are:

<b>Purpose</b>	Provides IMPLEMENTATION DEFINED control options.
<b>Usage constraints</b>	DBGEACR is not accessible from the CP14 interface.
<b>Configurations</b>	In v7 Debug, this register is not implemented. In v7.1 Debug, this is an optional register.
<b>Attributes</b>	A 32-bit RW register. DBGEACR is in the <a href="#">Debug control and status registers</a> group, see the registers summary in <a href="#">Table C11-3 on page C11-2197</a> .

Access to the DBGEACR is IMPLEMENTATION DEFINED. Any bits implemented in the core power domain will not be preserved over powerdown.

A debugger can read to [DBGDEVID.AuxRegs](#) to determine whether the DBGEACR is implemented. See [DBGDEVID, Debug Device ID register on page C11-2224](#).

The DBGEACR bit assignments are IMPLEMENTATION DEFINED.

### C11.11.25 DBGECR, Event Catch Register

The DBGECR characteristics are:

<b>Purpose</b>	Configures the debug logic to generate the OS Unlock catch debug event when the OS Lock is cleared.
<b>Usage constraints</b>	ARM deprecates using the CP14 interface to access DBGECR. In v7.1 Debug, DBGECR is not visible in the CP14 interface.
<b>Configurations</b>	In v7 Debug, this register is only implemented if the OS Save and Restore mechanism is implemented.  If external debug over powerdown is supported, this register must be implemented in the debug power domain.
<b>Attributes</b>	A 32-bit RW register. DBGECR is in the <a href="#">OS Save and Restore registers</a> group, see the registers summary in <a href="#">Table C11-7 on page C11-2201</a> .

The DBGECR bit assignments are:

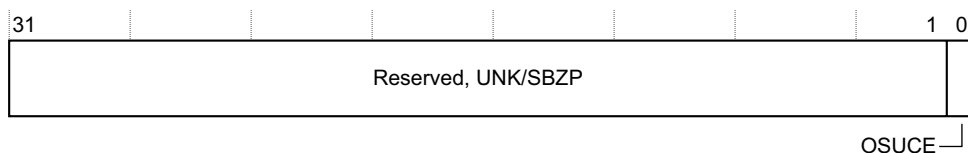

<b>Bits[31:1]</b>	Reserved, UNK/SBZP.
<b>OSUCE, bit[0]</b>	OS Unlock catch. The possible values of this bit are: <b>0</b> OS Unlock catch disabled. <b>1</b> OS Unlock catch enabled. When this bit is set to 1, an OS Unlock catch debug event is generated when the OS Lock is cleared by writing to the <a href="#">DBGOSLAR</a> . The debug logic reset value of this bit is 0. If the OS Unlock catch debug event is not supported then this bit is UNK/SBZP.

The OS Unlock catch debug event is a Halting debug event, see [Halting debug events on page C3-2073](#). If a debugger is monitoring an application running on top of an OS with OS Save and Restore capability, this event indicates the right time for the debug session to continue.

### C11.11.26 DBGITCTRL, Integration Mode Control register

The DBGITCTRL characteristics are:

- Purpose** Switches the processor from its default functional mode into *integration mode*, where test software can control directly the inputs and outputs of the processor, for integration testing or topology detection. When the processor is in integration mode, the test software uses the IMPLEMENTATION DEFINED integration registers to drive output values and to read inputs.
- Usage constraints** Access to DBGITCTRL is IMPLEMENTATION DEFINED.
- Configurations** This register is required in all implementations.
- Attributes** A 32-bit RW register. DBGITCTRL is in the [Other Debug management registers](#) group, see the registers summary in [Table C11-10 on page C11-2205](#).

The DBGITCTRL bit assignments are:

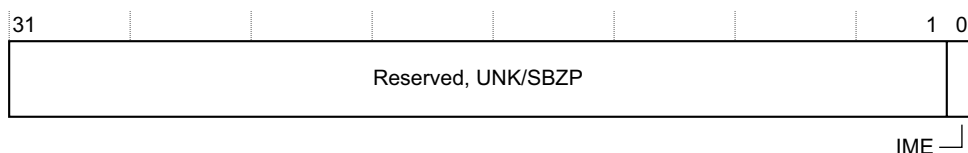

- Bits[31:1]** Reserved, UNK/SBZP.
- IME, bit[0]** Integration mode enable. The possible values of this bit are:
- 0** Normal operation.
  - 1** Integration mode enabled.
- When this bit is set to 1, the device reverts to an integration mode to enable integration testing or topology detection. The integration mode behavior is IMPLEMENTATION DEFINED.

### C11.11.27 DBGITR, Instruction Transfer Register

The DBGITR characteristics are:

**Purpose** When the processor is in Debug state, transfers an ARM instruction to the processor for execution.

**Usage constraints** Access to the DBGITR is IMPLEMENTATION DEFINED and depends on:

- the processor state
- the values of:
  - the **DBGDSCR**. {RXfull, RXfull\_1, TXfull, TXfull\_1, InstrCompl\_1, ExtDCCmode, ITRen} fields
  - the internal InstrCompl flag, see *About the DCC and DBGITR on page C8-2164*.

For more information, see *Behavior of accesses to the DBGITR on page C8-2174*.

DBGITR is not visible in the CP14 interface.

**Configurations** This register is required in all implementations.

**Attributes** A 32-bit WO register. DBGITR is in the [Debug instruction transfer and data transfer registers](#) group, see the registers summary in [Table C11-4 on page C11-2198](#).

The debug logic reset value of the DBGITR is UNKNOWN.

The DBGITR bit assignments are:

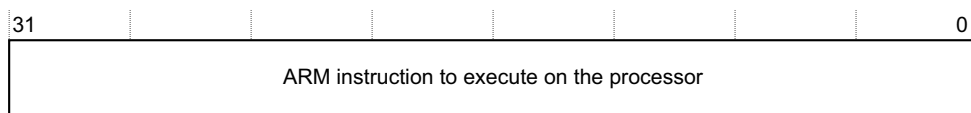

#### ARM instruction to execute on the processor, bits[31:0]

The 32-bit encoding of an ARM instruction to execute on the processor.

For information see *Behavior of accesses to the DBGITR on page C8-2174*.

### C11.11.28 DBGLAR, Lock Access Register

The DBGLAR characteristics are:

<b>Purpose</b>	Provides a Software Lock on writes to the debug registers through the memory-mapped interface. Used in conjunction with the <a href="#">DBGLSR</a> . Use the <a href="#">DBGLSR</a> to check the current status of the Software Lock.
<b>Usage constraints</b>	DBGLAR is only visible in the memory-mapped interface.
<b>Configurations</b>	This register is required in all implementations that include the memory-mapped interface. If external debug over powerdown is supported, this register must be implemented in the debug power domain.
<b>Attributes</b>	A 32-bit WO register. DBGLAR is in the <a href="#">Other Debug management registers</a> group, see the registers summary in <a href="#">Table C11-10 on page C11-2205</a> . The Software Lock is set on debug logic reset.

The DBGLAR bit assignments are:

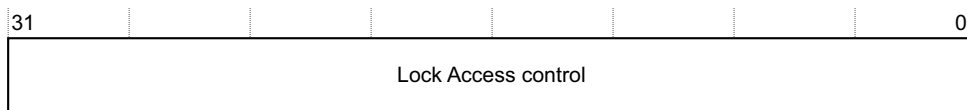

#### Lock Access control, bits[31:0]

Writing the key value `0xC5ACCE55` to this field clears the Software Lock, enabling write accesses to the debug registers through the memory-mapped interface.

Writing any other value to this field sets the Software Lock, meaning write accesses to the debug registers through the memory-mapped interface are ignored.

In an implementation with separate core and debug power domains, the Software Lock is maintained in the debug power domain. Its state is unaffected by the core power domain powering down.

#### ———— **Note** ————

- Use of this Software Lock mechanism reduces the risk of accidental damage to the contents of the debug registers. It does not, and cannot, prevent all accidental or malicious damage.
- Do not confuse the Software Lock mechanism with the OS Lock described in [The OS Save and Restore mechanism on page C7-2152](#).
- Accesses through the memory-mapped interface to locked debug registers are ignored. For more information, see [Permissions in relation to locks on page C6-2118](#).

### C11.11.29 DBGLSR, Lock Status Register

The DBGLSR characteristics are:

<b>Purpose</b>	Provides status information for the Software Lock on the debug registers. Used in conjunction with <a href="#">DBGLAR</a> . Use <a href="#">DBGLAR</a> to lock or unlock the Software Lock.
<b>Usage constraints</b>	DBGLSR is only visible in the memory-mapped interface.
<b>Configurations</b>	This register is required in all implementations that include the memory-mapped interface. If external debug over powerdown is supported, this register must be implemented in the debug power domain.
<b>Attributes</b>	A 32-bit RO register. DBGLSR is in the <a href="#">Other Debug management registers</a> group, see the registers summary in <a href="#">Table C11-10 on page C11-2205</a> .

The DBGLSR bit assignments are:

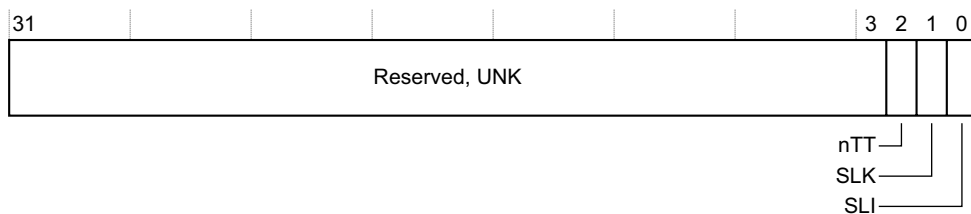

<b>Bits[31:3]</b>	Reserved, UNK.
<b>nTT, bit[2]</b>	Not 32-bit access. This bit is always RAZ. It indicates that software must perform a 32-bit access to write the key to the Lock Access Register.
<b>SLK, bit[1]</b>	Software Lock status. This bit indicates the status of the debug registers lock. The possible values are: <b>0</b> Software Lock clear. <b>1</b> Software Lock set.  The debug registers lock is set or cleared by writing to the <a href="#">DBGLAR</a> . Setting the lock restricts access to debug registers. For more information see <a href="#">Permissions in relation to locks on page C6-2118</a> . The debug logic reset value of this bit is 1.
<b>SLI, bit[0]</b>	Software Lock implemented. This bit is RAO.

For more information about the Software Lock see [DBGLAR, Lock Access Register on page C11-2264](#).

### C11.11.30 DBGOSDLR, OS Double Lock Register

The DBGOSDLR characteristics are:

- Purpose** Locks out an external debugger entirely.
- Usage constraints** This register is only visible in the CP14 interface.  
 Software must only set the OS Double Lock immediately prior to a powerdown sequence.  
 If the processor is in Debug state, or if [DBGPRCR.CORENPDRQ](#) is set to 1, then the value of [DBGOSDLR.DLK](#) is ignored, and [DBGPRSR.DLK](#) reads as 0.  
 When [DBGPRCR.CORENPDRQ](#) is set to 0 and the processor is in Non-debug state, then if [DBGOSDLR.DLK](#) is set to 1 the OS Double Lock is set, and [DBGPRSR.DLK](#) reads as 1.
- Configurations** In v7 Debug, this register is not implemented.  
 In v7.1 Debug, this register is required in all implementations.  
 This register must be implemented in the core power domain.
- Attributes** A 32-bit RW register. [DBGOSDLR](#) is in the [OS Save and Restore registers](#) group, see the registers summary in [Table C11-7 on page C11-2201](#).  
 The non-debug logic reset value of the register is zero.

The DBGOSDLR bit assignments are:

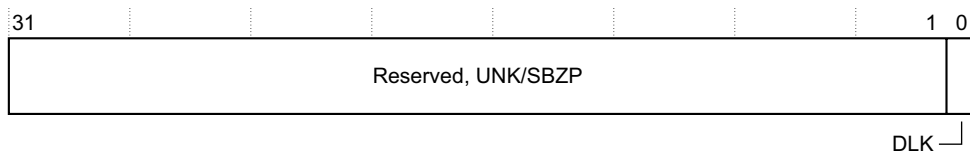

**Bits[31:1]**

Reserved, UNK/SBZP.

**DLK, bit[0]** OS Double Lock control bit. The possible values are:

- 0** OS Double Lock not set.
- 1** OS Double Lock set, if [DBGPRCR.CORENPDRQ](#) is set to 0 and the processor is in Non-debug state.

See [The OS Save and Restore mechanism on page C7-2152](#) for a description of using the OS Save and Restore mechanism registers, including the behavior when the OS Double Lock is set.

### C11.11.31 DBGOSLAR, OS Lock Access Register

The DBGOSLAR characteristics are:

<b>Purpose</b>	<p>Provides a lock for the debug registers.</p> <p>Writing the key value to the DBGOSLAR also resets the internal counter for the OS Save or OS Restore operation.</p> <p>The OS Lock may also disable Software debug events.</p> <p>Use <a href="#">DBGOSLSR</a> to check the current status of the lock.</p>
<b>Usage constraints</b>	<p>In v7 Debug, the effect of this register on Software debug events is IMPLEMENTATION DEFINED.</p>
<b>Configurations</b>	<p>In v7 Debug, this register is only implemented if the OS Save and Restore mechanism is implemented, and must be accessible when the core power domain is powered down.</p> <p>In v7.1 Debug, this register is required, and is not accessible:</p> <ul style="list-style-type: none"> <li>• When the core power domain is powered down.</li> <li>• When <a href="#">DBGPRSR.DLK</a> is set to 1.</li> </ul>
<b>Attributes</b>	<p>A 32-bit WO register. DBGOSLAR is in the <a href="#">OS Save and Restore registers</a> group, see the registers summary in <a href="#">Table C11-7</a> on <a href="#">page C11-2201</a>.</p>

The DBGOSLAR bit assignments are:



#### OS Lock Access, bits[31:0]

Writing the key value 0xC5ACCE55 to this field locks the debug registers. In v7 Debug, the write also resets the internal counter for the OS Save or OS Restore operation.

Writing any other value to this register unlocks the debug registers if they are locked.

See [The OS Save and Restore mechanism on page C7-2152](#) for a description of using the OS Save and Restore mechanism registers, including the behavior when the OS Lock is set.

In v7 Debug, it is IMPLEMENTATION DEFINED whether Software debug events are not permitted when the OS Lock is set. See [About invasive debug authentication on page C2-2028](#).

In v7.1 Debug, Software debug events are not permitted when the OS Lock is set.

If [DBGECR.OSUCE](#), OS Unlock catch, is set to 1, then when the OS Lock is cleared, an OS Unlock catch debug event is generated, see [DBGECR, Event Catch Register on page C11-2261](#).

### C11.11.32 DBGOSLSR, OS Lock Status Register

The DBGOSLSR characteristics are:

<b>Purpose</b>	Provides status information for the OS Lock.  In any implementation, software can read this register to detect whether the OS Save and Restore mechanism is implemented. If it is not implemented the read of DBGOSLSR.OSLM returns zero.
<b>Usage constraints</b>	There are no usage constraints.
<b>Configurations</b>	In v7 Debug, this register is only implemented if the OS Save and Restore mechanism is implemented, and must be implemented in the debug power domain.  In v7.1 Debug, this register is required, and if external debug over powerdown is supported it must be implemented in the debug power domain. However, DBGOSLSR.OSLK indicates state from the core power domain and is UNKNOWN when the core power domain is powered down. For more information, see the bit description.
<b>Attributes</b>	A 32-bit RO register. DBGOSLSR is in the <a href="#">OS Save and Restore registers</a> group, see the registers summary in <a href="#">Table C11-7 on page C11-2201</a> .

The DBGOSLSR bit assignments are:

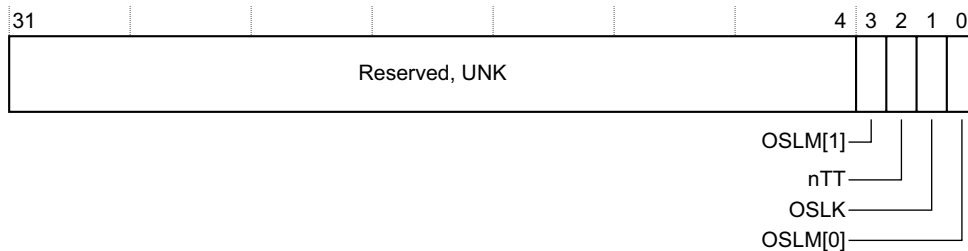

**Bits[31:4]** Reserved, UNK.

**OSLM, bits[3, 0]**

OS Lock Model implemented field. This field identifies the form of OS Save and Restore mechanism implemented. The possible values are:

- 0b00 No OS Save and Restore mechanism implemented. OS Lock not implemented. v7 Debug only.
- 0b01 OS Lock and [DBGOSSRR](#) implemented. v7 Debug only.
- 0b10 OS Lock implemented. [DBGOSSRR](#) not implemented. v7.1 Debug only.
- 0b11 Reserved.

**Note**

This field is split across two non-contiguous bits in the register.

**nTT, bit[2]** Not 32-bit access. This bit is always RAZ. It indicates that a 32-bit access is needed to write the key to the OS Lock Access Register.



**OSLK, bit[1]** OS Lock Status. The possible values are:

- 0** OS Lock not set.
- 1** OS Lock set.

If the OS Save and Restore mechanism is not implemented this bit is UNK.

The OS Lock is set or cleared by writing to the [DBGOSLAR](#).

Setting the OS Lock restricts access to debug registers. For more information see [The OS Save and Restore mechanism on page C7-2152](#).

In v7 Debug:

- The OS Lock is:
  - Maintained over core power down.
  - Readable when the core power domain is powered down.
  - Unaffected by a core powerup reset that is not also a debug logic reset.
- On a debug logic reset the state of the OS Lock and the value of this bit are IMPLEMENTATION DEFINED. If the implementation includes the recommended external debug interface they are determined by the value of the **DBGOSLOCKINIT** signal as follows:
  - LOW** The OS Lock is not set, and the Locked bit is 0.
  - HIGH** The OS Lock is set, and the Locked bit is 1.

In v7.1 Debug:

- The value of OSLK is UNKNOWN if the register is read when either:
  - The core power domain is powered down.
  - The OS Double Lock status bit, [DBGPRSR.DLK](#), is set to 1.
- The OS Lock is set to 1 on a core powerup reset.

### C11.11.33 DBGOSSRR, OS Save and Restore Register

The DBGOSSRR characteristics are:

<b>Purpose</b>	Software can save or restore the debug logic state of the processor by performing a series of reads or writes of the DBGOSSRR.  This register works in conjunction with an internal sequence counter to perform the OS Save or OS Restore operation. Writing the lock value to the <a href="#">DBGOSLAR</a> resets this counter.
<b>Usage constraints</b>	In v7 Debug, this register is only implemented if the OS Save and Restore mechanism is implemented.  In v7.1 Debug, this register is not implemented.  If external debug over powerdown is supported, this register must be implemented in the debug power domain.
<b>Configurations</b>	If the OS Save and Restore mechanism is not implemented, accesses to this register are UNPREDICTABLE.
<b>Attributes</b>	A 32-bit RW register. DBGOSSRR is in the <a href="#">OS Save and Restore registers</a> group, see the registers summary in <a href="#">Table C11-7 on page C11-2201</a> .  For more information about access permissions in an implementation that includes the OS Save and Restore mechanism but does not provide access to the DBGOSSRR through the external debug interface, see <a href="#">The OS Save and Restore mechanism on page C7-2152</a> .

The DBGOSSRR bit assignments are:

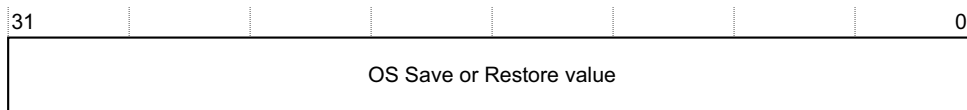

#### OS Save or Restore value, bits[31:0]

After a write to the [DBGOSLAR](#) to lock the debug registers, the first access to the DBGOSSRR must be a read:

- when performing an OS Save sequence this read returns the number of reads from the DBGOSSRR that are needed to save the entire debug logic state
- when performing an OS Restore sequence the value of this read is UNKNOWN and must be discarded.

After that first read access:

- a read of this register returns the next debug logic state value to be saved
- a write to this register restores the next debug logic state value.

Before accessing the DBGOSSRR, you must write to the [DBGOSLAR](#) to set the OS Lock. This write to the [DBGOSLAR](#) resets the internal counter for the OS Save or OS Restore operation.

The result is UNPREDICTABLE if:

- software accesses the DBGOSSRR when the OS Lock is not set
- after setting the OS Lock, the first access to the DBGOSSRR is not a read.

See [The OS Save and Restore mechanism on page C7-2152](#) for a description of using the OS Save and Restore mechanism registers.

### C11.11.34 DBGPCSR, Program Counter Sampling Register

The DBGPCSR characteristics are:

<b>Purpose</b>	Enables a debugger to sample the program counter (PC). The DBGPCSR is a Sample-based profiling register.
<b>Usage constraints</b>	ARM deprecates reading a PC sample through register 33 when the DBGPCSR is also implemented as register 40. DBGPCSR is not visible in the CP14 interface. The significance of the value returned by a read of the DBGPCSR when the processor is in Jazelle state is IMPLEMENTATION DEFINED. Reading the DBGPCSR has the side-effect of updating <a href="#">DBGCIDSR</a> and <a href="#">DBGVIDSR</a> , if they are implemented.
<b>Configurations</b>	Implementation of the Sample-based profiling extension is OPTIONAL: <ul style="list-style-type: none"> <li>• It is IMPLEMENTATION DEFINED whether DBGPCSR is: <ul style="list-style-type: none"> <li>— not implemented</li> <li>— in v7 Debug, implemented only as debug register 33, at offset 0x084</li> <li>— implemented only as debug register 40, at offset 0x0A0</li> <li>— implemented both as debug register 33 and as debug register 40.</li> </ul> </li> <li>• When DBGPCSR is implemented both as debug register 33 and as debug register 40, the two register numbers are aliases of each other.</li> </ul>
<b>Attributes</b>	A 32-bit RO register. DBGPCSR is in the <a href="#">Sample-based profiling registers</a> group, see the registers summary in <a href="#">Table C11-6 on page C11-2200</a> . On an implementation that includes the Sample-based profiling extension, a read of this register always returns a PC sample value. Therefore, it does not have a meaningful reset value.

The DBGPCSR bit assignments are:

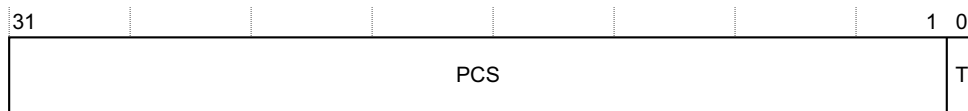

#### PCS, bits[31:1]

Program counter sample value. The sampled value of bits[31:1] of the PC. The sampled value is either the virtual address of an instruction, or the virtual address of an instruction address plus an offset that depends on the processor instruction set state.

[DBGDEVID1](#).PCSROffset indicates whether an offset is applied to the sampled addresses.

If the DBGPCSR is read when the processor is in Jazelle state, the significance of the value returned is IMPLEMENTATION DEFINED.

If the processor is in Debug state, or Non-invasive debug is not permitted, the value of DBGPCSR[31:0] returned by a read of the register is 0xFFFFFFFF, see [Reads of the Program Counter Sampling Register on page C10-2189](#).

**T, bit[0]** This bit indicates whether the sampled address is an ARM instruction, or a Thumb or ThumbEE instruction:

**0** If DBGPCSR[1] is 0, the sampled address is an ARM instruction. Otherwise, the significance of the PCS value is IMPLEMENTATION DEFINED.

**1** The sampled address is a Thumb or ThumbEE instruction.

If the DBGPCSR is read when the processor is in Jazelle state, the significance of the value returned is IMPLEMENTATION DEFINED.

See the description of the PCS field for the value returned when the processor is in Debug state or Non-invasive debug is not permitted.

———— **Note** ————

Issue C.a of this manual redefines the bit assignments of the DBGPCSR. This change simplifies the description of the behavior of the register, but does not change the functionality of the register.

A profiling tool can use the value of the T bit to calculate the instruction address as follows:

**When an offset is applied to the sampled address**

- if T is 0 and DBGPCSR[1] is 0,  $((\text{DBGPCSR}[31:2] \ll 2) - 8)$  is the address of the sampled ARM instruction
- if T is 0 and DBGPCSR[1] is 1, the instruction address is IMPLEMENTATION DEFINED
- if T is 1,  $((\text{DBGPCSR}[31:1] \ll 1) - 4)$  is the address of the sampled Thumb or ThumbEE instruction.

**When no offset is applied to the sampled address**

- if T is 0 and DBGPCSR[1] is 0,  $(\text{DBGPCSR}[31:2] \ll 2)$  is the address of the sampled ARM instruction
- if T is 0 and DBGPCSR[1] is 1, the instruction address is IMPLEMENTATION DEFINED
- if T is 1,  $(\text{DBGPCSR}[31:1] \ll 1)$  is the address of the sampled Thumb or ThumbEE instruction.

*The implemented [Sample-based profiling registers](#) on page C10-2188 describes the Sample-based profiling implementation options, and how software can determine whether and how the Sample-based profiling registers are implemented.*

For more information about program counter sampling, see [Sample-based profiling](#) on page C10-2188.

### C11.11.35 DBGPID0, Debug Peripheral ID Register 0

The DBGPID0 characteristics are:

- Purpose** Provides bits[7:0] of the 64-bit conceptual Peripheral ID, see [Figure C11-1 on page C11-2206](#).
- Usage constraints** DBGPID0 is not visible in the CP14 interface.
- Configurations** This register is required in all implementations.  
 If external debug over powerdown is supported, this register can be implemented in either or both power domains.
- Attributes** A 32-bit RO register. DBGPID0 is in the [Other Debug management registers](#) group, see the registers summary in [Table C11-10 on page C11-2205](#).

The DBGPID0 bit assignments are:



**Bits[31:8]** Reserved, UNK.

**Part number[7:0], bits[7:0]**

Bits[7:0] of the IMPLEMENTATION DEFINED part number.

For more information, see [About the Debug Peripheral Identification Registers on page C11-2206](#).



### C11.11.37 DBGPID2, Debug Peripheral ID Register 2

The DBGPID2 characteristics are:

- Purpose** Provides bits[23:16] of the 64-bit conceptual Peripheral ID, see [Figure C11-1 on page C11-2206](#).
- Usage constraints** DBGPID2 is not visible in the CP14 interface.
- Configurations** This register is required in all implementations.  
 If external debug over powerdown is supported, this register can be implemented in either or both power domains.
- Attributes** A 32-bit RO register. DBGPID2 is in the [Other Debug management registers](#) group, see the registers summary in [Table C11-10 on page C11-2205](#).

The DBGPID2 bit assignments are:



**Bits[31:8]** Reserved, UNK.

**Revision, bits[7:4]**

The IMPLEMENTATION DEFINED revision number for the implementation.

**Uses JEP106 ID code, bit[3]**

For an ARMv7 implementation this bit must be 1, indicating that the Peripheral ID uses a JEP106 ID code.

**JEP106 ID code[6:4], bits[2:0]**

Bits[6:4] of the IMPLEMENTATION DEFINED JEP106 ID code.

For an implementation designed by ARM the JEP106 ID code is 0x3B and therefore this field is 0b011.

For more information, see [About the Debug Peripheral Identification Registers on page C11-2206](#).

### C11.11.38 DBGPID3, Debug Peripheral ID Register 3

The DBGPID3 characteristics are:

- Purpose** Provides bits[31:24] of the 64-bit conceptual Peripheral ID, see [Figure C11-1 on page C11-2206](#).
- Usage constraints** DBGPID3 is not visible in the CP14 interface.
- Configurations** This register is required in all implementations.  
If external debug over powerdown is supported, this register can be implemented in either or both power domains.
- Attributes** A 32-bit RO register. DBGPID3 is in the [Other Debug management registers](#) group, see the registers summary in [Table C11-10 on page C11-2205](#).

The DBGPID3 bit assignments are:



**Bits[31:8]** Reserved, UNK.

**RevAnd, bits[7:4]**

The IMPLEMENTATION DEFINED manufacturing revision number for the implementation.

**Customer modified, bits[3:0]**

An IMPLEMENTATION DEFINED value that indicates an endorsed modification to the implementation.  
If the system designer cannot modify the implementation supplied by the processor designer then this field is RAZ.

For more information, see [About the Debug Peripheral Identification Registers on page C11-2206](#).





### C11.11.40 DBGPRCR, Device Powerdown and Reset Control Register

The DBGPRCR characteristics are:

<b>Purpose</b>	Controls processor functionality related to reset and powerdown.
<b>Usage constraints</b>	In v7 Debug, ARM deprecates using the CP14 interface to write to DBGPRCR.HCWR or DBGPRCR.CWRR. In v7.1 Debug, not all bits are visible in the CP14 interface.
<b>Configurations</b>	This register is required in all implementations. If external debug over powerdown is supported, this register must be implemented in the debug power domain. However, in v7.1 Debug, DBGPRCR.{CWRR, CORENPDRQ} indicate state from the core power domain and are UNKNOWN when the core power domain is powered down. For more information, see the bit descriptions.
<b>Attributes</b>	A 32-bit RW register. DBGPRCR is in the <a href="#">Debug control and status registers</a> group, see the registers summary in <a href="#">Table C11-3 on page C11-2197</a> . For details of the register reset value see the register bit assignments.

The DBGPRCR bit assignments are:

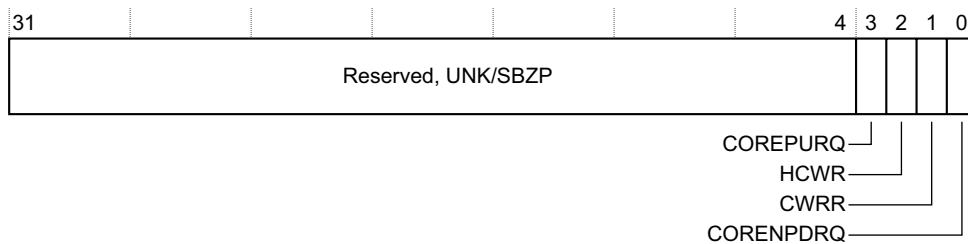

**Bits[31:4]** Reserved, UNK/SBZP.

**Bit[3], in v7 Debug**

Reserved, UNK/SBZP.

**COREPURQ, bit[3], in v7.1 Debug**

Core powerup request. A debugger can use this bit to request that the power controller powers up the core, enabling access to the debug register in the core power domain. The possible values of this bit are:

- 0** No effect.
- 1** Request the power controller to powerup the core.

In an implementation that includes the recommended external debug interface, this bit drives the **DBGPWRUPREQ** signal.

This bit is only defined for the memory-mapped and the external debug interfaces. For accesses to DBGPRCR from CP14 this bit is UNK/SBZP.

This bit can be read and written both:

- when the core power domain is powered down
- when [DBGPRSR.DLK](#) is set to 1.

On powerup the processor is reset. DBGPRCR.COREPURQ can be written with 1 at the same time as DBGPRCR.HCWR to prevent the processor taking a Reset exception immediately.

The power controller should not permit the core power domain to powerdown until this bit is cleared to zero.

This bit is set to zero on debug logic reset of the debug power domain.

Support for this bit is IMPLEMENTATION DEFINED, and may lie outside the scope of the processor implementation.

———— **Note** ————

Writes to this bit are permitted regardless of the state of any implemented invasive debug authentication. This means that a debugger can request Core powerup regardless of whether invasive debug is permitted.

**HCWR, bit[2]** Hold core warm reset. The effects of the possible values of this bit are:

- 0** Do not hold the non-debug logic reset on powerup or warm reset.
- 1** Hold the non-debug logic of the processor in reset on powerup or warm reset. The processor is held in this state until this bit is cleared to 0.

———— **Note** ————

In issue B of this manual, this bit was called the *Hold non-debug logic reset* bit. The definition of the bit, for a v7 Debug implementation, has not changed from the description given in issue B.

In v7 Debug, this bit is accessible through the CP14 interface, but ARM deprecates changing this bit through that interface.

In v7.1 Debug, this bit is only defined for the memory-mapped and the external debug interfaces. For accesses to DBGPRCR from CP14 this bit is UNK/SBZP.

This bit can be read and written both:

- when the core power domain is powered down
- when [DBGPRSR.DLK](#) is set to 1.

Hold core warm reset is an IMPLEMENTATION DEFINED feature. If it is implemented writing 1 to this bit means the non-debug logic of the processor is held in reset after a core powerup or warm reset.

———— **Note** ————

This bit never affects system powerup, because when implemented it resets to 0.

An external debugger can use this bit to prevent the processor running again before the debugger has had the chance to detect a powerdown occurrence and restore the state of the debug registers in the core power domain. Also, this bit can be used in conjunction with an external reset controller to take the processor into reset and hold it there while the rest of the system comes out of reset. This means a debugger can hold the processor in reset while programming other debug registers.

The processor ignores the value of this bit unless invasive debug is permitted in all processor states and modes.

If both features are supported, the bit can be written at the same time as the [DBGPRCR.CWRR](#), Core warm reset request bit, to force the processor into reset and hold it there, for example while programming other debug registers such as setting [DBGDRCR.HRQ](#), Halt request bit, to take the processor into Debug state on exiting reset.

———— **Note** ————

When this bit is set to 1 the processor is not held in Debug state, and cannot enter Debug state until released from reset. While the processor is held in reset it must not accept instructions issued through the [DBGITR](#).

If Hold core warm reset is not implemented this bit is RAZ/WI.

When this bit is implemented, its debug logic reset value is 0.

**CWRR, bit[1]** Core warm reset request. The actions on writing to this bit are:

- 0** No action.
- 1** Request internal reset.

———— **Note** —————

In issue B of this manual, this bit was called the *Warm reset request* bit. The definition of the bit, for a v7 Debug implementation, has not changed from the description given in issue B.

In an implementation that includes the recommended external debug interface, this bit drives the **DBGSTREQ** signal.

Reads of this bit are UNKNOWN, and writes to this bit are ignored, when any of the following apply:

- the core power domain is powered down
- in v7.1 Debug only, either:
  - **DBGPRSR.DLK**, OS Double Lock status bit, is set to 1
  - for the external debug interface, the OS Lock is set.

Otherwise, including for reads from the CP14 interface, this bit is RAZ.

Core warm reset request is an IMPLEMENTATION DEFINED feature. If an implementation does not support core warm reset request this bit is RAZ/WI.

If an implementation supports core warm reset request, writing 1 to this bit issues a request for a warm reset. Typically the request is passed to an external reset controller. This means that even when an implementation supports Core warm reset request, whether a request causes a reset might be an IMPLEMENTATION DEFINED feature of the system.

———— **Note** —————

- Software must read **DBGPRSR.SR**, Sticky Reset status bit, to determine the current reset status of the processor.
- See [Reset and debug on page C7-2160](#) for more information about warm resets.

The external debugger can use this bit to force the processor into reset if it does not have access to the warm reset signal. The reset behavior is the same as warm reset driven by the warm reset signal.

The processor ignores any write to this bit unless invasive debug is permitted in all processor states and modes.

Unless Hold core warm reset, bit[2], is set to 1, the reset must be held only for long enough to reset the processor. The processor then exits the reset state.

———— **Note** —————

If an implementation supports both features, both the Core warm reset request and Hold core warm reset bits can be set to 1 in a single write to the **DBGPRCR**. In this case the processor enters reset and is held there.

When this bit is implemented, its debug logic reset value is 0.

**CORENPDRQ, bit[0]**

Core no powerdown request. This bit requests emulation of powerdown. The possible values of this bit are:

- 0** On a powerdown request, the system powers down.
- 1** On a powerdown request, the system emulates powerdown.

———— **Note** —————

In issue B of this manual, this bit was called the *DBGnoPWRDWN* bit. The definition of the bit, for a v7 Debug implementation, has not changed from the description given in issue B.

In v7 Debug, this bit is read-write when the core power domain is powered down. The value is not lost through the powerdown.

In v7.1 Debug, this bit is UNKNOWN on reads and ignores writes when any of the following apply:

- The core power domain is powered down.  
If the CORENPDRQ bit was 1 it loses this value through the powerdown.
- [DBGPRSR.DLK](#), OS Double Lock status bit is set to 1.
- For the external debug interface, the OS Lock is set.

Emulation of powerdown is an IMPLEMENTATION DEFINED feature. If it is implemented, setting this bit to 1 requests the power controller to work in an emulation mode when it receives a powerdown request. In this emulation mode the processor is not actually powered down. In an implementation that includes the recommended external debug interface, this bit drives the **DBGNOPWRDWN** signal. For more information, see [DBGNOPWRDWN on page AppxA-2346](#).

In v7 Debug, if the processor does not implement this feature, this bit is RAZ/WI.

In v7.1 Debug, this bit is always implemented, but support for this feature is IMPLEMENTATION DEFINED.

In v7 Debug, the debug logic reset value is 0.

In v7.1 Debug, this bit is set to the value of the COREPURQ bit on core powerup reset. The value of the bit is not changed by either a warm reset or by a debug logic reset that is not also a core powerup reset.

———— **Note** ————

Writes to this bit are permitted regardless of the state of any implemented invasive debug authentication. This means that a debugger can request Core no powerdown regardless of whether invasive debug is permitted.

For details of invasive debug authentication see [Chapter C2 Invasive Debug Authentication](#).

### C11.11.41 DBGPRSR, Device Powerdown and Reset Status Register

The DBGPRSR characteristics are:

<b>Purpose</b>	Holds information about the reset and powerdown state of the processor.
<b>Usage constraints</b>	Reading this register resets some bits in the register. See the bit assignment descriptions for more information. This side effect is stopped for reads from the memory-mapped interface when the Software Lock is set. See <a href="#">Summary of the v7 Debug register interfaces on page C6-2128</a> and <a href="#">Summary of the v7 Debug register interfaces on page C6-2128</a> for details.
<b>Configurations</b>	<p>This register is required in all implementations.</p> <p>If external debug over powerdown is supported, this register must be implemented in the debug power domain. However, some bits indicate state that is held in the core power domain, and are UNKNOWN if read when the core power domain is powered down. For more information, see the bit descriptions.</p> <p>In v7.1 DBGPRSR is not visible in the CP14 interface.</p> <p>Some bit assignments differ in v7 Debug and v7.1 Debug. See below for details.</p>
<b>Attributes</b>	<p>A 32-bit RO register. DBGPRSR is in the <a href="#">Debug control and status registers</a> group, see the registers summary in <a href="#">Table C11-3 on page C11-2197</a>.</p> <p>For more information about the reset values of the bits see the register bit assignments.</p>

The DBGPRSR bit assignments are:

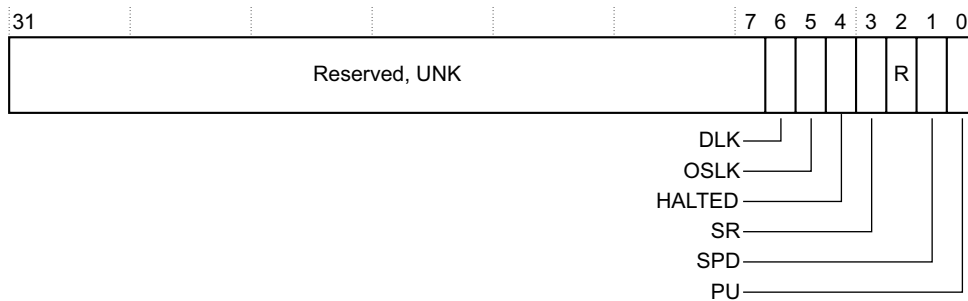

**Bits[31:7]** Reserved, UNK.

**Bits[6:4], v7 Debug**  
 Reserved, UNK.

**DLK, bit[6], v7.1 Debug**  
 OS Double Lock status. The possible values are:  
**0** OS Double Lock not set.  
**1** OS Double Lock set.

For more information, see the description of the [DBGOSDLR](#) DLK bit.

If the processor is in Debug state or if [DBGPRCR](#).CORENPDRQ is set to 1, then [DBGOSDLR](#).DLK is ignored and DBGPRSR.DLK reads as 0. Otherwise, when [DBGPRCR](#).CORENPDRQ is set to 0 and the processor is in Non-debug state, DBGPRSR.DLK reads as [DBGOSDLR](#).DLK.

This bit is UNKNOWN on reads when the core power domain is powered down, indicated by DBGPRSR.PU reading as 0.

### OSLK, bit[5], v7.1 Debug

OS Lock status. The possible values are:

- 0** OS Lock not set.
- 1** OS Lock set.

For more information, see the description of the [DBGOSLSR.OSLK](#) bit.

This bit is UNKNOWN on reads when:

- The core power domain is powered down, indicated by [DBGPRSR.PU](#) reading as 0.
- In v7.1 Debug, the OS Double Lock is set, indicated by [DBGPRSR.DLK](#) reading as 1.
- The Non-debug logic is held in reset, indicated by [DBGPRSR.R](#) reading as 1.

### HALTED, bit[4], v7.1 Debug

Halted. See [DBGDSCR.HALTED](#). The possible values are:

- 0** The processor is in Non-debug state.
- 1** The processor is in Debug state.

This bit is UNKNOWN on reads when the core power domain is powered down, indicated by [DBGPRSR.PU](#) reading as 0.

### SR, bit[3]

Sticky Reset status. The possible values are:

- 0** The non-debug logic of the processor has not been reset since the last time this register was read.
- 1** The non-debug logic of the processor has been reset since the last time this register was read.

The processor clears this bit to 0 on a read of the [DBGPRSR](#) when the non-debug logic is not in reset state.

When the non-debug logic of the processor is in reset state, the processor sets this bit to 1.

A read of [DBGPRSR](#) made when the non-debug logic of the processor is in reset state returns 1 for Sticky Reset status and does not change the value of Sticky Reset status.

A read of [DBGPRSR](#) made when the non-debug logic of the processor is not in reset state returns the current value of Sticky Reset status, and then clears Sticky Reset status to 0.

#### ———— Note —————

- [Reset state on page C11-2285](#) defines Reset state.
- On a read access, the Sticky Reset status bit can be cleared only as a side-effect of the read. When a read is made through the memory-mapped interface with the Software Lock set, side-effects are not permitted, and therefore the bit is not cleared.
- Bits[3:2] of [DBGPRSR](#) never read as 0b01.

On a debug logic reset that is not also a non-debug logic reset, the value of the SR bit is UNKNOWN.

This bit is UNKNOWN on reads when:

- The core power domain is powered down, indicated by [DBGPRSR.PU](#) reading as 0.
- In v7.1 Debug, the OS Double Lock is set, indicated by [DBGPRSR.DLK](#) reading as 1.

### R, bit[2]

Reset status. The possible values are:

- 0** The non-debug logic of the processor is not currently held in reset state.
- 1** The non-debug logic of the processor is currently held in reset state.

This bit is UNKNOWN on reads when:

- The core power domain is powered down, indicated by [DBGPRSR.PU](#) reading as 0.
- In v7.1 Debug, the OS Double Lock is set, indicated by [DBGPRSR.DLK](#) reading as 1.

#### ———— Note —————

[Reset state on page C11-2285](#) defines reset state.

A read of the DBGPRSR made when the non-debug logic of the processor is in reset state returns 1 for the Reset status.

A read of the DBGPRSR made when the non-debug logic of the processor is not in reset state returns 0 for the Reset status.

**SPD, bit[1]** Sticky Powerdown status. The possible values are:

**0** The processor has not powered down since the last time this register was read.

**1** The processor has powered down since the last time this register was read.

In a v7 Debug implementation, if the implementation does not provide separate core and debug power domains, it is IMPLEMENTATION DEFINED whether this bit is implemented. If this bit is not implemented, it is RAZ,

This bit is UNKNOWN on reads when both:

- The core power domain is powered up, indicated by DBGPRSR.PU reading as 1
- In v7.1 Debug, the OS Double Lock is set, indicated by DBGPRSR.DLK reading as 1.

This bit is cleared to 0 on a read of the DBGPRSR when the processor is in the powered up state.

———— **Note** ————

If the implementation supports separate core and debug power domains, the Sticky Powerdown status bit reflects the state of the core power domain. [Powered up state on page C11-2285](#) defines the terms powered up and powered down.

When the processor is in the powered down state, the debug logic sets the Sticky Powerdown status bit to 1.

A read of DBGPRSR made when the processor is in the powered down state returns 1 for Sticky Powerdown status and does not change the value of Sticky Powerdown status.

A read of DBGPRSR made when the processor is in the powered up state returns the current value of Sticky Powerdown status, and then clears Sticky Powerdown status to 0.

The value 0b00 for DBGPRSR[1:0], indicating certain of the debug registers cannot be accessed but have not lost their value, is not permitted.

———— **Note** ————

On a read access, the Sticky Powerdown status bit can be cleared only as a side-effect of the read. When a read is made through the memory-mapped interface with the Software Lock set, side-effects are not permitted, and therefore the bit is not cleared.

In v7 Debug, if this bit is set to 1, accesses to certain registers return an error response. For more information, see [Permissions in relation to powerdown on page C6-2119](#).

On a debug logic reset that is not also a core powerup reset, the value of the SPD bit is UNKNOWN.

**PU, bit[0]** Powerup status. The possible values are:

**0** The processor is powered down. Certain debug registers cannot be accessed.

**1** The processor is powered up. All debug registers can be accessed.

If the implementation does not provide separate core and debug power domains, this bit is RAO.

———— **Note** ————

If the implementation supports separate core and debug power domains, the Powerup status bit reflects the state of the core power domain. [Powered up state on page C11-2285](#) defines the terms powered up and powered down.

If the recommended external debug interface is implemented, the Powerup status bit reads the value of the **DBGPWRDUP** input on the external debug interface. For details of the **DBGPWRDUP** input see [DBGPWRDUP on page AppxA-2347](#).



A read of DBGPRSR made when the processor is in the powered up state returns 1 for Powerup status.

A read of DBGPRSR made when the processor is in the powered down state returns 0 for Powerup status.

For more information, see [Power domains and debug on page C7-2149](#).

## Reset state

When a reset input is asserted, the non-debug logic of the processor enters reset state. For more information see [Reset and debug on page C7-2160](#).

In addition, writing 1 to DBGPRCR.CWRR, Core warm reset request bit, might cause the non-debug logic of the processor to enter reset state, see [DBGPRCR, Device Powerdown and Reset Control Register on page C11-2278](#).

The processor stops executing instructions before it enters reset state.

After entering reset state, the non-debug logic of the processor remains in reset state until:

- all reset signals are deasserted
- [DBGPRCR.CWRR](#), Core warm reset request, is 0.

### ———— Note —————

If the reset scheme described in [Reset and debug on page C7-2160](#) is implemented, one effect of asserting the system powerup reset is to place the debug logic into a reset state. In this state the DBGPRSR is not accessible.

On exiting reset state, the processor resumes execution of instructions with the Reset exception.

## Powered up state

The processor is in the powered up state when power is on, and is in the powered down state when power is off. Changing from powered down state to powered up state requires a powerup reset of the processor.

If the implementation supports separate core and debug power domains, powered up and powered down state refer to the state of the core power domain.

Powered up status is not affected by the reset state of the processor, whether that reset is:

- a powerup reset
- a warm reset
- a reset occurring because [DBGPRCR.HCWR](#), the Hold core warm reset bit, is set to 1.

For more information, see:

- [Chapter C7 Debug Reset and Powerdown Support](#)
- [Reset and debug on page C7-2160](#), for information about powerup and warm resets.

### C11.11.42 DBGVCR, Vector Catch Register

The DBGVCR characteristics are:

- Purpose** Controls Vector catch debug events, see [Vector catch debug events on page C3-2065](#).
- Usage constraints** There are no usage constraints.
- Configurations** This register is required in all implementations.  
Some bit assignments differ in an implementation that includes the Security Extensions and Virtualization Extensions. See the field descriptions for details.
- Attributes** A 32-bit RW register. DBGVCR is in the [Software debug event registers](#) group, see the registers summary in [Table C11-5 on page C11-2199](#).  
The debug logic reset value of DBGVCR is UNKNOWN.

———— **Note** —————

After a debug logic reset a debugger must ensure that DBGVCR has a defined value for all implemented registers before it programs [DBGDSCR.MDBGen](#) or [DBGDSCR.HDBGen](#) to enable Monitor or Halting debug-mode.

The DBGVCR bit assignments are:

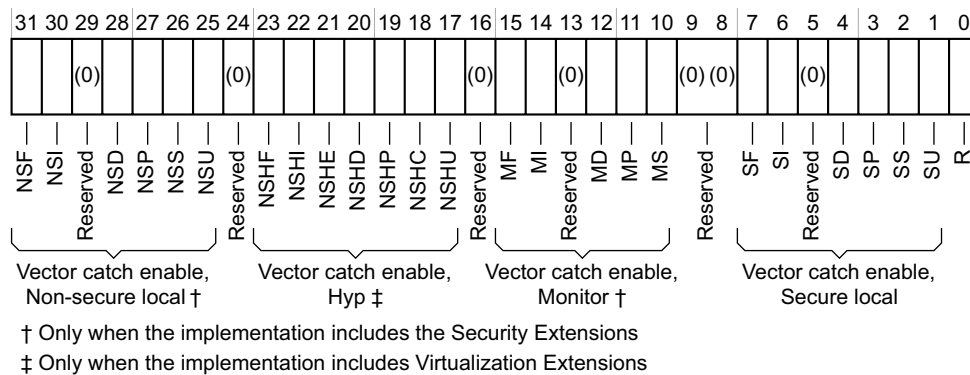

**Bits[29, 24, 16, 13, 9:8, 5]**

Reserved, UNK/SBZP.

**Bits[31:30, 28:25], Implementation includes the Security Extensions**

Non-secure local Vector catch enable bits. These are the Vector catch enable bits for exceptions taken to Non-secure PL1 modes.

The Non-secure local Vector catch enable bits are:

- NSF, bit[31]** FIQ interrupt exception Vector catch enable in Non-secure state.
- NSI, bit[30]** IRQ interrupt exception Vector catch enable in Non-secure state.
- NSD, bit[28]** Data Abort exception Vector catch enable in Non-secure state.
- NSP, bit[27]** Prefetch Abort exception Vector catch enable in Non-secure state.
- NSS, bit[26]** Supervisor Call exception Vector catch enable in Non-secure state.
- NSU, bit[25]** Undefined Instruction exception Vector catch enable in Non-secure state.

**Bits[31:30, 28:25], Implementation does not include the Security Extensions**

Reserved, UNK/SBZP.

**Bits[23:17], Implementation includes the Virtualization Extensions**

Hyp Vector catch enable bits. These are the Vector catch enable bits for exceptions taken to Hyp mode in Non-secure state.

The Hyp Vector catch enable bits are:

<b>NSHF, bit[23]</b>	FIQ interrupt exception Vector catch enable in Non-secure state.
<b>NSHI, bit[22]</b>	IRQ interrupt exception Vector catch enable in Non-secure state.
<b>NSHE, bit[21]</b>	Hyp Trap or Hyp mode entry exception Vector catch enable in Non-secure state.
<b>NSHD, bit[20]</b>	Data Abort, from Hyp mode exception Vector catch enable in Non-secure state.
<b>NSHP, bit[19]</b>	Prefetch Abort, from Hyp mode exception Vector catch enable in Non-secure state.
<b>NSHC, bit[18]</b>	Hypervisor Call, from Hyp mode exception Vector catch enable in Non-secure state.
<b>NSHU, bit[17]</b>	Undefined Instruction, from Hyp mode exception Vector catch enable in Non-secure state.

**Bits[23:17], Implementation does not include the Virtualization Extensions**

Reserved, UNK/SBZP.

**Bits[15:14, 12:10], Implementation includes the Security Extensions**

Monitor Vector catch enable bits. These are the Vector catch enable bits for exceptions taken to Monitor mode in Secure state.

The Monitor Vector catch enable bits are:

<b>MF, bit[15]</b>	FIQ interrupt exception Vector catch enable, in Secure state on Monitor mode vector.
<b>MI, bit[14]</b>	IRQ interrupt exception Vector catch enable in Secure state on Monitor mode vector.
<b>MD, bit[12]</b>	Data Abort exception Vector catch enable in Secure state on Monitor mode vector.
<b>MP, bit[11]</b>	Prefetch Abort exception Vector catch enable in Secure state on Monitor mode vector.
<b>MS, bit[10]</b>	Secure Monitor Call exception Vector catch enable in Secure state.

**Bits[15:14, 12:10], Implementation does not include the Security Extensions**

Reserved, UNK/SBZP.

**Bits[7:6, 4:1] Implementation does not include the Security Extensions**

Local Vector catch enable bits.

**Implementation includes the Security Extensions**

Secure local Vector catch enable bits. These are the Vector catch enable bits for exceptions taken to Secure state that are not taken to Monitor mode. These exceptions are taken on the Secure local vectors.

The Local Vector catch or Secure local Vector catch enable bits are:

<b>SF, bit[7]</b>	FIQ interrupt exception Vector catch enable in Secure state.
<b>SI, bit[6]</b>	IRQ interrupt exception Vector catch enable in Secure state.
<b>SD, bit[4]</b>	Data Abort exception Vector catch enable in Secure state.
<b>SP, bit[3]</b>	Prefetch Abort exception Vector catch enable in Secure state.
<b>SS, bit[2]</b>	SVC, Supervisor Call, exception Vector catch enable in Secure state.
<b>SU, bit[1]</b>	Undefined Instruction exception Vector catch enable in Secure state.

**R, bit[0]**      Reset Vector catch enable.

When Monitor debug-mode is configured and enabled, DBGVCR. {SD, SP} must be programmed to 0b00. Additionally, if the implementation includes the Security Extensions and debug exceptions are not being trapped to the Hypervisor, DBGVCR. {NSD, NSP} must be programmed to 0b00, see *UNPREDICTABLE cases when Monitor debug-mode is selected* on page C3-2045.

For more information about these Vector catch operations see *Vector catch debug events* on page C3-2065.

### C11.11.43 DBGVIDSR, Virtualization ID Sampling Register

The DBGVIDSR characteristics are:

- Purpose** Samples the VMID, Hyp mode status, and NS state whenever the [DBGPCSR](#) samples the program counter. This enables a debugger to associate a program counter sample with the virtual machine running on the processor.
- In implementations that do not include Virtualization Extensions, DBGVIDSR is a Non-secure state sample register.
- The DBGVIDSR is a Sample-based profiling register.
- Usage constraints** Used in conjunction with the [DBGPCSR](#).
- DBGVIDSR is not visible in the CP14 interface.
- Configurations** Implementation of the Sample-based profiling extension is OPTIONAL. In an implementation that includes the Sample-based profiling extension:
- DBGVIDSR is not implemented if the implementation does not include the Security Extensions
  - in an implementation that includes the Security Extensions:
    - in a v7 Debug implementation, it is IMPLEMENTATION DEFINED whether DBGVIDSR is implemented
    - in a v7.1 Debug implementation, DBGVIDSR must be implemented.
- When implemented, DBGVIDSR is debug register 42.
- An implementation that does not include the Sample-based profiling extension cannot implement DBGVIDSR.
- In an implementation that includes DBGVIDSR but does not includes the Virtualization Extensions, bits[30:0] of the register are reserved, UNK.
- When DBGVIDSR is not implemented, debug register 42 is reserved.
- Attributes** A 32-bit RO register. DBGVIDSR is in the [Sample-based profiling registers](#) group, see the registers summary in [Table C11-6 on page C11-2200](#).
- The non-debug logic reset value of the DBGVIDSR is UNKNOWN.

The DBGVIDSR bit assignments are:

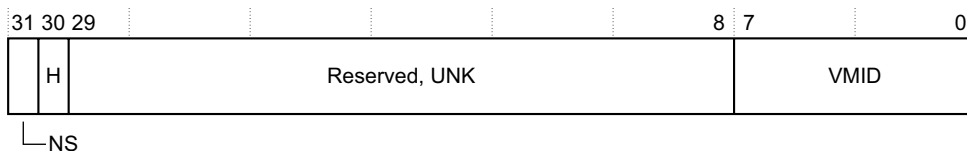

**NS, bit[31]** NS state sample. Indicates the Secure or Non-secure state associated with the last PC sample read from [DBGPCSR](#).

- 0** Secure state.
- 1** Non-secure state.

This is the NS state, not the value of the SCR.NS bit. In Monitor mode it is sampled as zero, regardless of the value of SCR.NS.

**Bit[30], Implementation does not include the Virtualization Extensions**

Reserved, UNK.

**H, bit[30], Implementation includes the Virtualization Extensions**

Hyp mode sample. Indicates whether the last PC sample read from [DBGPCSR](#) was associated with Hyp mode.

**0** Not associated with Hyp mode.

**1** Associated with Hyp mode.

If DBGVIDSR.NS is 0, then this field is UNK.

**Bits[29:8]** Reserved, UNK.

**Bits[7:0], Implementation does not include the Virtualization Extensions**

Reserved, UNK.

**VMID, bits[7:0], Implementation includes the Virtualization Extensions**

VMID sample. The value of the VMID field from the VTTBR, associated with the last PC sample read from [DBGPCSR](#). See [VTTBR, Virtualization Translation Table Base Register; Virtualization Extensions on page B4-1738](#) for more information.

If DBGVIDSR.NS is 0 or DBGVIDSR.H is 1, then this field is UNK.

[The implemented Sample-based profiling registers on page C10-2188](#) describes the Sample-based profiling implementation options, and how software can determine whether and how the Sample-based profiling registers are implemented.

For more information about program counter sampling, see [Sample-based profiling on page C10-2188](#).

## C11.11.44 DBGWCR, Watchpoint Control Registers

The DBGWCR characteristics are:

<b>Purpose</b>	<p>Holds control information for a watchpoint.</p> <p>Used in conjunction with a Watchpoint Value Register, <a href="#">DBGWVR</a>, a Watchpoint Value Register. <a href="#">DBGWVRn</a> is associated with <a href="#">DBGWCRn</a> to form watchpoint n.</p>
<b>Usage constraints</b>	There are no usage constraints.
<b>Configurations</b>	<p>These registers are required in all implementations.</p> <p>The number of watchpoints is IMPLEMENTATION DEFINED, between 1 and 16, and is specified by the <a href="#">DBGDIDR.WRPs</a> field. Any registers that are not implemented are reserved.</p> <p>Some bit assignments differ if the implementation includes the Security Extensions and Virtualization Extensions. See the field descriptions for details.</p>
<b>Attributes</b>	<p>A 32-bit RW register. <a href="#">DBGWCR</a> is in the <a href="#">Software debug event registers</a> group, see the registers summary in <a href="#">Table C11-5 on page C11-2199</a>.</p> <p>The debug logic reset value of a <a href="#">DBGWCR</a> is UNKNOWN.</p>

———— **Note** —————

After a debug logic reset a debugger must ensure that [DBGWCR.E](#) has a defined value for all implemented registers before it programs [DBGDSCR.MDBGen](#) or [DBGDSCR.HDBGen](#) to enable Monitor or Halting debug-mode.

The [DBGWCR](#) bit assignments are:

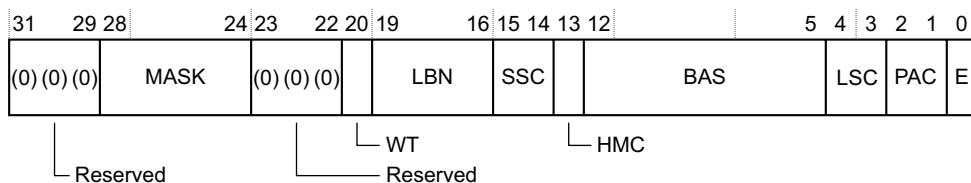

### Bits[31:29, 23:22]

Reserved, UNK/SBZP.

### MASK, bits[28:24]

Address range mask. In v7 Debug, support for watchpoint address range masking is optional. If it is not supported then:

- if the [DBGDEVID](#) register is not implemented, or [DBGDEVID.WPAddrMask](#) is 0b0000, then these bits are RAZ/WI
- otherwise, these bits are UNK/SBZP.

In v7.1 Debug, support for watchpoint address range masking is required.

If watchpoint address range masking is supported, this field can set a watchpoint on a range of addresses by masking lower order address bits out of the watchpoint comparison. The value of this field is the number of low order bits of the address that are masked off, except that values of 1 and 2 are reserved. Therefore, the meaning of Watchpoint Address range mask values are:

0b00000	No mask.
0b00001	Reserved.
0b00010	Reserved.
0b00011	0x00000007 mask for data address, three bits masked.
0b00100	0x0000000F mask for data address, four bits masked.

0b00101 0x0000001F mask for data address, five bits masked.

.  
.  
.

0b11111 0x7FFFFFFF mask for data address, 31 bits masked.

This field must be programmed to 0b00000 if either:

- DBGWCR.BAS != 0b11111111, if an 8-bit Byte address select field is implemented
- DBGWCR.BAS != 0b1111, if a 4-bit Byte address select field is implemented.

If this is not done, the generation of Watchpoint debug events by this watchpoint is UNPREDICTABLE.

If this field is not zero, the [DBGWVR](#) bits that are not included in the comparison must be zero, otherwise the generation of Watchpoint debug events by this watchpoint is UNPREDICTABLE.

To watch for an access to any byte in an doubleword-aligned region of size 8 bytes, ARM recommends that debuggers set:

- DBGWCR.MASK to 0b00011, indicating an address range mask of 0x00000007
- DBGWCR.BAS, Byte address select field to 0b11111111.

This setting is compatible with both implementations with an 8-bit Byte address select field and implementations with a 4-bit Byte address select field, because implementations with a 4-bit Byte address select field ignore writes to DBGWCR.BAS[7:4].

**WT, bit[20]** Watchpoint type. This bit is set to 1 to link the watchpoint to a breakpoint to create a linked watchpoint that requires both data address matching and Context matching. The possible values of this bit are:

- 0** Unlinked data address match.
- 1** Linked data address match.

When this bit is set to 1 the Linked breakpoint number field indicates the breakpoint to which this watchpoint is linked. For more information, see [Linked comparisons for debug event generation on page C3-2053](#).

#### **LBN, bits[19:16]**

Linked breakpoint number. If this watchpoint is programmed with the watchpoint type set to linked then this field must be programmed with the number of the breakpoint that defines the Context match to be combined with data address comparison. Otherwise, this field must be programmed to 0b0000.

Reading this register returns an UNKNOWN value for this field, and the generation of Watchpoint debug events by this watchpoint is UNPREDICTABLE, if either:

- this watchpoint does not have linking enabled and this field is not programmed to 0b0000
- this watchpoint has linking enabled and the breakpoint indicated by this field does not support Context matching, is not programmed for Context matching, or does not exist.

#### **SSC, bits[15:14], implementation includes the Security Extensions**

Security state control. This field enables the watchpoint to be conditional on the security state of the processor.

##### **Note**

As [Watchpoint state control fields on page C11-2294](#) shows, SSC controls the modes in which an access matches. Whether an access matches is not affected by the security attribute of the access.

This field is used with the HMC, Hyp mode control, and PAC, Privileged access control, fields. See [Watchpoint state control fields on page C11-2294](#) for possible values.

#### **Bits[15:14], implementation does not include the Security Extensions**

Reserved, UNK/SBZP.



**HMC, bit[13], implementation includes the Virtualization Extensions**

Hyp mode control.

This field is used with the SSC, Security state control, and PAC, Privileged access control, fields. See [Watchpoint state control fields](#) on page C11-2294 for possible values.

**Bit[13], implementation does not include the Virtualization Extensions**

Reserved, UNK/SBZP.

**BAS, bits[12:5] or bits[8:5]**

Byte address select. It is IMPLEMENTATION DEFINED whether a 4-bit or an 8-bit Byte address select field is implemented:

- an 8-bit Byte address select field is DBGWCR[12:5]
- a 4-bit Byte address select field is DBGWCR[8:5]. DBGWCR[12:9] is RAZ/WI.

A [DBGWVR](#) is programmed with a word-aligned address. This field enables the watchpoint to hit only if certain bytes of the addressed word are accessed. The watchpoint hits if an access hits any byte being watched, even if:

- the access size is larger than the size of the region being watched
- the access is unaligned, and the base address of the access is not in the same word of memory as the address in the [DBGWVR](#)
- the access size is smaller than the size of region being watched.

For details of the use of this field see [Byte address selection behavior on data address match](#) on page C3-2060.

If the MASK field is implemented and programmed to a value other than 0b00000, no mask, then this field must be programmed to:

- 0b1111, if a 4-bit Byte address select field is implemented
- 0b11111111, an 8-bit Byte address select field is implemented.

If this is not done, the generation of Watchpoint debug events by this watchpoint is UNPREDICTABLE.

ARM deprecates values of this field that set watchpoints on multiple non-contiguous bytes using a single set of watchpoint registers. [Table C11-24](#) shows examples of deprecated BAS values, and of values that are not deprecated.

**Table C11-24 Example BAS values**

BAS field	Deprecated
0b00000001	No
0b00001111	No
0b00111100	No
0b11110001	Yes
0b11110111	Yes
0b00101010	Yes
0b00000000	Yes

**LSC, bits[4:3]**

Load/store access control. This field enables watchpoint matching on the type of access being made. Possible values of this field are:

- 0b00 Reserved.
- 0b01 Match on any load, Load-Exclusive, or swap.
- 0b10 Match on any store, Store-Exclusive, or swap.
- 0b11 Match on all types of access.

If an implementation supports watchpoint generation by:

- a memory hint instruction, then that instruction is treated as generating a load access
- a cache maintenance operation, then that operation is treated as generating a store access.

**PAC, bits[2:1]** Privileged access control. This field enables watchpoint matching conditional on the mode of the processor.

This field is used with the SSC, Security state control, and HMC, Hyp mode control, fields. See [Watchpoint state control fields](#) for possible values.

**E, bit[0]**

Watchpoint enable. The meaning of this bit is:

- 0 Watchpoint disabled.
- 1 Watchpoint enabled.

A watchpoint never generates a Watchpoint debug event when it is disabled.

For more information about possible watchpoint values see [DBGWVR, Watchpoint Value Registers on page C11-2297](#).

**Watchpoint state control fields**

Watchpoint debug event generation can be made conditional on the current state of the processor. The following fields in DBGWCR check the current state:

- SSC, Security state control, if the implementation includes the Security Extensions
- HMC, Hyp mode control, if the implementation includes the Virtualization Extensions
- PAC, Privileged access control.

[Table C11-25](#) shows the possible values of the fields, and the access modes and security states that can be tested.

**Table C11-25 Watchpoint state control**

SSC	HMC	PAC	Secure modes	Non-secure modes
0b00	0	0b01	PL1 only	PL1 only
		0b10	Unprivileged only	Unprivileged only
		0b11	PL1, and unprivileged	PL1, and unprivileged
	1	0b01	PL1	PL2 and PL1
		0b11	All	All
0b01	0	0b01	-	PL1 only
		0b10	-	Unprivileged only
		0b11	-	PL1, and unprivileged
	1	0b01	-	PL2 and PL1
		0b11	-	PL2, PL1, and unprivileged

**Table C11-25 Watchpoint state control (continued)**

SSC	HMC	PAC	Secure modes	Non-secure modes
0b10	0	0b01	PL1 only	-
		0b10	Unprivileged only	-
		0b11	PL1, and unprivileged	-
0b11	1	0b00	-	PL2 only

**Note**

- In [Table C11-25 on page C11-2294](#), unprivileged means accesses made at PL0, and LDRT and STRT accesses made at PL1.
- The SSC field controls the processor security state in which the access matches, not the required security attribute of the access.
- All other combinations of values are reserved, and the generation of Watchpoint debug events by this watchpoint is UNPREDICTABLE if used.

### C11.11.45 DBGWFAR, Watchpoint Fault Address Register

The DBGWFAR characteristics are:

<b>Purpose</b>	Returns information about the address of the instruction that accessed a watchpointed address.
<b>Usage constraints</b>	<p>ARM deprecates using DBGWFAR to determine the address of the instruction that triggered a synchronous watchpoint. For more information see:</p> <ul style="list-style-type: none"> <li>• for a VMSA implementation, <a href="#">Data Abort on a Watchpoint debug event on page B3-1412</a> and <a href="#">Register updates on exception reporting at PL2 on page B3-1422</a></li> <li>• for a PMSA implementation, <a href="#">Data Abort exception on a Watchpoint debug event on page B5-1768</a></li> <li>• <a href="#">Effect of entering Debug state on CP15 registers and the DBGWFAR on page C5-2094</a></li> </ul> <p>In v7.1 Debug, DBGWFAR must not be used for synchronous watchpoints as it is UNKNOWN.</p>
<b>Configurations</b>	<p>This register is required in all implementations.</p> <p>In v7.1 Debug, if a processor never generates asynchronous watchpoints this register can be implemented as RAZ/WI.</p>
<b>Attributes</b>	<p>A 32-bit RW register. DBGWFAR is in the <a href="#">Debug control and status registers</a> group, see the registers summary in <a href="#">Table C11-3 on page C11-2197</a>.</p> <p>The debug logic reset value of the DBGWFAR is UNKNOWN.</p>

The DBGWFAR bit assignments are:

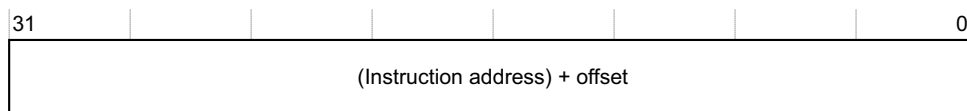

**(Instruction address) + offset, bits[31:0]**

When Watchpoint debug events are permitted, on every Watchpoint debug event the DBGWFAR is updated with the virtual address of the instruction that accessed the watchpointed address plus an offset that depends on the processor instruction set state when the instruction was executed:

- 8 if the processor was in ARM state
- 4 if the processor was in Thumb or ThumbEE state
- an IMPLEMENTATION DEFINED offset if the processor was in Jazelle state.

In v7.1 Debug, when DBGWFAR is implemented as a RW register, this field is UNKNOWN following a synchronous watchpoint. LR\_abt indicates the address of the instruction that triggered the watchpoint.

A processor with a trivial implementation of the Jazelle extension can implement DBGWFAR[0] as RAZ/WI, see [Trivial implementation of the Jazelle extension on page B1-1244](#) for more information. In such an implementation, software must use a SBZP policy when writing to DBGWFAR[0].

### C11.11.46 DBGWVR, Watchpoint Value Registers

The DBGWVR characteristics are:

- Purpose** Holds a data address value for use in watchpoint matching. The address used must be the virtual address of the data.  
Used with a Watchpoint Control Register, [DBGWCR](#), to form a watchpoint. DBGWVR<sub>n</sub> is associated with [DBGWCR<sub>n</sub>](#) to form watchpoint *n*.
- Usage constraints** There are no usage constraints.
- Configurations** These registers are required in all implementations.  
The number of watchpoints is IMPLEMENTATION DEFINED, between 1 and 16, and is specified by the [DBGDIDR.WRPs](#) field. Any registers that are not implemented are reserved.
- Attributes** A 32-bit RW register. DBGWVR is in the [Software debug event registers](#) group, see the registers summary in [Table C11-5 on page C11-2199](#).  
The debug logic reset value of a DBGWVR is UNKNOWN.

The DBGWVR bit assignments are:

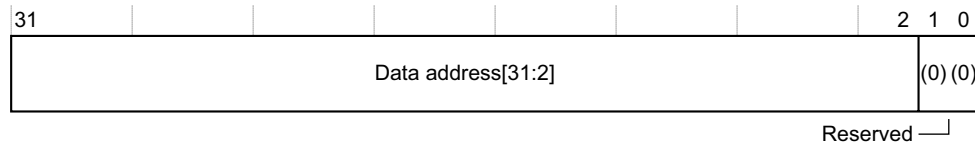

- Bits[31:2]** Bits[31:2] of the value for comparison, address[31:2].
- Bits[1:0]** Reserved, UNK/SBZP.

The debug logic generates a debug event when the watchpoint is matched. For more information, see [Watchpoint debug events on page C3-2057](#).



# Chapter C12

## The Performance Monitors Extension

This chapter describes the Performance Monitors Extension, that is an OPTIONAL non-invasive debug component. It describes version 1 and 2 of the *Performance Monitor Unit* (PMU) architecture, PMUv1 and PMUv2, and contains the following sections:

- [About the Performance Monitors](#) on page C12-2300
- [Accuracy of the Performance Monitors](#) on page C12-2304
- [Behavior on overflow](#) on page C12-2305
- [Effect of the Security Extensions and Virtualization Extensions](#) on page C12-2307
- [Event filtering, PMUv2](#) on page C12-2309
- [Counter enables](#) on page C12-2311
- [Counter access](#) on page C12-2312
- [Event numbers and mnemonics](#) on page C12-2313
- [Performance Monitors registers](#) on page C12-2326.

---

### Note

---

Both [Chapter B4 System Control Registers in a VMSA implementation](#) and [Chapter B6 System Control Registers in a PMSA implementation](#) describe the Performance Monitors Extension registers. Most of the registers are included in both VMSA and PMSA implementations, and for these registers the bit assignments are identical in VMSA and PMSA implementations. However, most register references in this chapter link to the register descriptions in [Chapter B4](#).

---

## C12.1 About the Performance Monitors

The Performance Monitors are part of the ARM Debug architecture. Many ARMv6 processors included performance monitors, but before ARMv7 they were not part of the architecture. Publication of the *ARM Architecture Reference Manual, ARMv7-A and ARMv7-R edition* was the first architectural specification of the Performance Monitors, and that specification was derived from the earlier ARM implementations. The versions of the Performance Monitors are:

- Performance Monitors Extension version 1, PMUv1
- Performance Monitors Extension version 2, PMUv2.

In ARMv7, the Performance Monitors Extension is an **OPTIONAL** feature of an implementation, but ARM strongly recommends that ARMv7-A and ARMv7-R implementations include the Performance Monitors Extension.

The basic form of the Performance Monitors is:

- A cycle counter, with the ability to count every cycle or every 64<sup>th</sup> cycle.
- A number of event counters. The event counted by each counter is programmable. ARMv7 provides space for up to 31 counters. The actual number of counters is **IMPLEMENTATION DEFINED**, and the specification includes an identification mechanism.
- Controls for:
  - Enabling and resetting counters.
  - Flagging overflows.
  - Enabling interrupts on overflow.

Monitoring software can enable the cycle counter independently of the event counters.

The events that can be monitored split into:

- Architectural and microarchitectural events that are likely to be consistent across many microarchitectures.
- Implementation-specific events.

The PMU architecture uses event numbers to identify an event. It:

- Defines event numbers for common events, for use across many architectures and microarchitectures.

———— **Note** —————

On processors that implement PMUv1, there is no requirement to implement any of the common events. Processors that implement PMUv2 must, as a minimum requirement, implement a limited subset of the common events.

- Reserves a large event number space for **IMPLEMENTATION DEFINED** events.

The full set of events for an implementation is **IMPLEMENTATION DEFINED**. ARM recommends that processors implement as many of the events as are appropriate to the architecture profile and microarchitecture of the implementation.

The event numbers of the common events are reserved for the specified events. Each of these event numbers must either:

- Be used for its assigned event.
- Not be used.

If the configuration of the event to be counted specifies an event number that is not used, or an event number for which no event is defined, then the counter never increments.

When a processor supports monitoring of an event that is assigned a common event number, ARM strongly recommends that it uses that number for the event. However, software might encounter implementations where an event assigned a number in this range is monitored using an event number from the **IMPLEMENTATION DEFINED** range.



———— **Note** ————

Future revisions of the PMU architecture might define other common event numbers. This is one reason why software must not assume that an event with an assigned common event number is never monitored using an event number from the IMPLEMENTATION DEFINED range.

ARMv7 defines the following possible interfaces to the Performance Monitors registers:

- A system control coprocessor (CP15) interface. This interface is mandatory.
- A memory-mapped interface. This interface is optional.
- An external debug interface. This interface is optional.

An operating system running on the processor can use the CP15 interface to access the counters. This supports a number of uses, including:

- dynamic compilation techniques
- energy management.

Also, if required, the operating system can enable application software to access the counters. This enables an application to monitor its own performance with fine grain control without requiring operating system support. For example, an application might implement per-function performance monitoring.

There are many situations where performance monitoring features integrated into the processor are valuable for applications and for application development. When an operating system does not use the Performance Monitors itself, ARM recommends that it enables application software access to the Performance Monitors.

To enable interaction with external monitoring, an implementation might consider additional enhancements, such as providing:

- A set of events, from which a selection can be exported onto a bus for use as external events.
- The ability to count external events. This enhancement means the processor must also implement a set of external event input signals.
- Memory-mapped and external debug access to the Performance Monitors registers. This means the counter resources can be used for system monitoring in a system where they are not used by the software running on the processor. See [Appendix B Recommended Memory-mapped and External Debug Interfaces for the Performance Monitors](#) for more information.

### **C12.1.1 About the Performance Monitors v2**

The main changes in Performance Monitors v2 are:

- Filtering of event counting by processor state. See [PMXEVTYPER, Performance Monitors Event Type Select Register, VMSA on page B4-1694](#) or [PMXEVTYPER, Performance Monitors Event Type Select Register, PMSA on page B6-1924](#).
- Changes the names of some of the events defined in PMUv1. These name changes do not affect what the event counts.
- Performance Monitors implementations must implement at least a limited subset of the common events.

### **C12.1.2 Identification of the Performance Monitors Extension version**

The introduction of PMUv2 adds a field to the CP15 Debug Feature Register 0, [ID\\_DFR0](#), to identify the Performance Monitors Extension version, see [ID\\_DFR0, Debug Feature Register 0, VMSA on page B4-1604](#).

### C12.1.3 PMU versions, and status in the ARM architecture

ARMv7 reserves CP15 registers for ARM-recommended Performance Monitors, and for IMPLEMENTATION DEFINED performance monitors, see *VMSA CP15 c9 register summary, reserved for cache and TCM control and performance monitors* on page B3-1477 or *PMSA CP15 c9 register summary, reserved for cache and TCM lockdown registers and performance monitors* on page B5-1789.

ARM strongly recommends that performance monitors are implemented using the Performance Monitors Extension described in this chapter.

———— **Note** ————

- This chapter describes PMUv1 and PMUv2. Where there are differences between the two versions, the information is described accordingly.
- If an implementation includes v7.1 Debug and also includes the PMU, then it must implement PMUv2.

### C12.1.4 Interaction with trace

It is IMPLEMENTATION DEFINED whether the processor exports counter events to a trace macrocell, or other external monitoring agent, to provide triggering information. The form of any exporting is also IMPLEMENTATION DEFINED. If implemented, this exporting might be enabled as part of the performance monitoring control functionality.

ARM recommends system designers include a mechanism for importing a set of external events to be counted, but such a feature is IMPLEMENTATION DEFINED. When implemented, this feature enables the trace module to pass in events to be counted.

### C12.1.5 Interaction with power saving operations

All counters are subject to any changes in clock frequency, including clock stopping caused by the WFI and WFE instructions.

### C12.1.6 Interaction with Save and Restore operations

For PMUv2 implementations that include the Virtualization Extensions, software can use the **PMOVSSET** register to restore the state of **PMOVSRR**.

### C12.1.7 Effects of non-invasive debug authentication on the Performance Monitors

Table C12-1 describes the behavior of the Performance Monitors when non-invasive debug is disabled or not permitted, and in Debug state.

**Table C12-1 Behavior of Performance Monitors when non-invasive debug not permitted**

Debug state	Non-invasive debug permitted <sup>a</sup>	PMCR.DP <sup>b</sup>	Event counters enabled and events exported <sup>b, c</sup>	PMCCNTR enabled
Yes	x	x	No	No
No	Yes	x	Yes	Yes
		0	No	Yes
	No	1	No	No

a. Chapter C9 *Non-invasive Debug Authentication* describes when non-invasive debug is permitted and enabled.

b. See *PMCR, Performance Monitors Control Register, VMSA* on page B4-1676, or *PMCR, Performance Monitors Control Register, PMSA* on page B6-1910. The VMSA and PMSA definitions of the DP bit are identical.

c. The events are exported only if the **PMCR.X** bit is set to 1.

———— **Note** —————

Some documentation describes the conditions under which non-invasive debug is not permitted as being defined by *prohibited software regions*, or *prohibited regions*.

---

Entry to and exit from Debug state can affect the accuracy of the Performance Monitors, see [Accuracy of the Performance Monitors on page C12-2304](#).

## C12.2 Accuracy of the Performance Monitors

The Performance Monitors provide approximately accurate count information. To keep the implementation and validation cost low, a reasonable degree of inaccuracy in the counts is acceptable. ARM does not define a *reasonable degree of inaccuracy* but recommends the following guidelines:

- Under normal operating conditions, the counters must present an accurate value of the count.
- In exceptional circumstances, such as a change in security state or other boundary condition, it is acceptable for the count to be inaccurate.
- Under very unusual nonrepeating pathological cases then counts can be inaccurate. These cases are likely to occur as a result of asynchronous exceptions, such as interrupts, where the chance of a systematic error in the count is very unlikely.

———— **Note** —————

An implementation must not introduce inaccuracies that can be triggered systematically by the execution of normal pieces of software. For example, dropping a branch count in a loop due to the structure of the loop gives a systematic error that makes the count of branch behavior very inaccurate, and this is not reasonable. However, dropping a single branch count as the result of a rare interaction with an interrupt is acceptable.

The permitted inaccuracy limits the possible uses of the Performance Monitors. In particular, the architecture does not define the point in a pipeline where the event counter is incremented, relative to the point where a read of the event counters is made. This means that pipelining effects can cause some imprecision.

A change of security state can affect the accuracy of the Performance Monitors, see [Interaction with Security Extensions on page C12-2307](#).

Entry to and exit from Debug state can also disturb the normal running of the processor, causing additional inaccuracy in the Performance Monitors. Disabling the counters while in Debug state limits the extent of this inaccuracy. An implementation can limit this inaccuracy to a greater extent, for example by disabling the counters as soon as possible during the Debug state entry sequence.

An implementation must document any particular scenarios where significant inaccuracies are expected.

## C12.3 Behavior on overflow

Events are counted in 32-bit wrapping counters. A counter *overflows* when it wraps. On a Performance Monitors counter overflow:

- An overflow status bit is set to 1. See *PMOVSr*, *Performance Monitors Overflow Flag Status Register*, *VMSA* on page B4-1683.
- An interrupt request is generated if the processor is configured to generate counter overflow interrupts. For more information, see *Generating overflow interrupt requests*.
- The counter continues counting events.

### C12.3.1 Generating overflow interrupt requests

Software can program the Performance Monitors so that an overflow interrupt request is generated when a counter overflows. See *PMINTENSEt*, *Performance Monitors Interrupt Enable Set register*, *VMSA* on page B4-1681 and *PMINTENCLR*, *Performance Monitors Interrupt Enable Clear register*, *VMSA* on page B4-1679.

———— **Note** —————

The mechanism by which an interrupt request from the Performance Monitors generates an FIQ or IRQ exception is IMPLEMENTATION DEFINED.

Software can write to the counters to control the frequency at which interrupt requests occur. For example, software might set a counter to `0xFFFF0000`, to generate another counter overflow after 65 536 increments, and reset it to this value every time an overflow interrupt occurs.

For implementations that do not include the Virtualization Extensions:

- The overflow interrupt request is a level-sensitive request.
- The processor signals a request:
  - for any given PMNx counter, when `PMOVSr[x] == 1` and `PMINTENSEt[x] == 1`
  - when `PMOVSr[31] == 1` and `PMINTENSEt[31] == 1`.
- It is IMPLEMENTATION DEFINED whether the processor signals a request when `PMCR.E == 0`.

For PMUv2 implementations that include the Virtualization Extensions:

- The overflow interrupt request is a level-sensitive request.
- The processor signals a request for any given PMNx counter, when `PMOVSr[x] == 1`, `PMINTENSEt[x] == 1` and either:
  - `x < HDCR.HPMN` and `PMCR.E == 1`
  - `x ≥ HDCR.HPMN` and `HDCR.HPME == 1`.
- The processor signals a request when `PMOVSr[31] == 1`, `PMINTENSEt[31] == 1`, and `PMCR.E == 1`.

The overflow interrupt request is active in both Secure and Non-secure states. In particular, overflow events from PMNx where `x ≥ HDCR.HPMN` can be signaled from all modes and states but only if `HDCR.HPME == 1`. The interrupt handler for the counter overflow request must cancel the interrupt request, by writing to `PMOVSr[x]` to clear the overflow bit to 0.

### C12.3.2 Pseudocode details of overflow interrupt requests

The `PMUIRQ()` pseudocode function returns a value corresponding to the level-sensitive overflow interrupt request.

```
// PMUIRQ
// =====

boolean PMUIRQ()
// Returns the state of the Performance Monitors overflow interrupt request signal.
if HaveVirtExt() then
    global_irqen = (PMCR.E == '1');
```

```
hyp_irqen = (HDCR.HPME == '1');  
else  
    global_irqen = IMPLEMENTATION_DEFINED either TRUE or (PMCR.E == '1');  
pmuirq = (global_irqen && PMINTEN<31> == '1' && PMOVSR<31> == '1'); // interrupt for PMCCNT  
  
for n = 0 to UInt(PMCR.N) - 1  
    irqen = (if HaveVirtExt() && n >= UInt(HDCR.HPMN) then hyp_irqen else global_irqen);  
    if irqen && PMINTEN<n> == '1' && PMOVSR<n> == '1' then pmuirq = TRUE;  
  
return pmuirq;
```

## C12.4 Effect of the Security Extensions and Virtualization Extensions

This section describes the effects of the Security Extensions and Virtualization Extensions on the Performance Monitors. It contains the following subsections:

- [Interaction with Security Extensions](#)
- [Interaction with Virtualization Extensions](#) on page C12-2308.

### C12.4.1 Interaction with Security Extensions

The Performance Monitors provide a non-invasive debug feature, and therefore are controlled by the non-invasive debug authentication signals. [About non-invasive debug authentication](#) on page C9-2182 describes how the Security Extensions interact with non-invasive debug.

[Effects of non-invasive debug authentication on the Performance Monitors](#) on page C12-2302 describes the behavior of the Performance Monitors when any of the following applies:

- non-invasive debug is disabled
- the processor is in a mode or state where non-invasive debug is not permitted
- the processor is in Debug state.

The `PMCR.DP` bit controls whether the non-invasive debug authentication signals control the operation of the Cycle Counter Register, `PMCCNTR`. The effect of the `PMCR.DP` bit is as follows:

- 0 `PMCCNTR` counting operates regardless of the non-invasive debug authentication settings.
- 1 `PMCCNTR` counting is disabled when non-invasive debug is not permitted.

———— **Note** —————

Controls in the:

- `PMCR`, and the `PMCNTENCLR` and `PMCNTENSET` registers can disable the event counters and the `PMCCNTR`
- `PMXEVTYPER` registers, if PMUv2 is implemented, can filter out events and cycles based on processor mode and security state.

This disabling of counters or filtering of events takes precedence over the authentication controls.

The Performance Monitors registers are Common registers, see [Common system control registers](#) on page B3-1457. They are always accessible regardless of the values of the authentication signals and the `SDER.SUNIDEN` bit. Authentication controls whether the counters count events. It does not control access to the Performance Monitors registers.

The Performance Monitors are not intended to be completely accurate, see [Accuracy of the Performance Monitors](#) on page C12-2304. In particular, some inaccuracy is permitted at the point of changing security state. However, to avoid information leaking from the Secure state, the permitted inaccuracy is that:

- Some transactions that should be counted, according to the Performance Monitors configuration, might not be counted.
- Wherever possible, transactions that the Performance Monitors configuration prohibits from being counted must not be counted, but if they are counted then that counting must not degrade security.

### C12.4.2 Interaction with Virtualization Extensions

If an implementation includes the Virtualization Extensions and also includes the Performance Monitors Extension, then it must implement PMUv2.

In PMUv2, in an implementation that includes the Virtualization Extensions, Non-secure software executing at PL2 can:

- Trap any attempt by the Guest OS to access the PMU. This means the hypervisor can identify which Guest OSs are using the PMU and intelligently employ switching of the PMU state.
- Use the [PMOVSSET](#) register to restore the state of [PMOVS](#).
- Trap accesses to the *Performance Monitors Control Register* ([PMCR](#)), so that it can fully virtualize the PMU identity registers, [PMCR.IMP](#) and [PMCR.IDCODE](#).
- Reserve the highest-numbered counters for its own use by overriding the value of [PMCR.N](#) seen by the Guest OS. The processor implementation must not permit a Guest OS to access the reserved counters.

The [HDCR](#) controls virtualization. For more information see:

- [Counter enables on page C12-2311](#)
- [Counter access on page C12-2312](#).



## C12.5 Event filtering, PMUv2

PMUv2 can filter events by various combination of:

- privilege level, for example PL0, Non-secure PL1, PL2, or Secure PL1
- security state such as Secure or Non-secure.

This gives software more flexibility for counting events across multiple processes.

### C12.5.1 Accuracy of event filtering

The PMU architecture does not require event filtering to be accurate. Normally, it is acceptable for an event to leak through from one state to another.

For most events, it is acceptable that, during a transition between states, events generated by instructions executed in one state are counted in the other state. The following sections describe the cases where event counts must not leak into the wrong state:

- *Exception-related events*
- *Software increment events.*

#### Exception-related events

The PMU must filter events related to exceptions and exception handling according to the mode from which the exception was taken. These events are:

- exception taken
- instruction architecturally executed, condition code check pass, exception return
- instruction architecturally executed, condition code check pass, write to [CONTEXTIDR](#)
- instruction architecturally executed, condition code check pass, write to translation table base.

It is not acceptable for the PMU to count an exception after it had been taken because this could systematically report a result of zero exceptions in User mode. Similarly, it is not acceptable for the PMU to count exception returns or writes to [CONTEXTIDR](#) after the return from the exception.

———— **Note** —————

Unprivileged software cannot write to [CONTEXTIDR](#).

#### Software increment events

The PMU must filter software increment events according to the mode in which the software increment occurred. Software increment counting must also be precise, meaning the PMU must count every architecturally-executed software increment event, and must not count any speculatively-executed software increment.

Software increment events must also be counted without the need for synchronization barriers. Although the event is a write to a CP15 register, the state is not updated so a barrier is unnecessary. For example, two software increments executed without an intervening barrier must increment the event counter twice.

### C12.5.2 Pseudocode details of event filtering

The CounterEnabled() pseudocode function returns TRUE if PMN<sub>x</sub> counts events in the current mode and state.

```
// CounterEnabled
// =====

boolean CounterEnabled(integer n)
    assert n == 31 || n < UInt(PMCR.N);

    // Returns TRUE if and only if PMNn should count events in the current mode and state.
    // n == 31 is used to mean PMCCNTR, the cycle counter.

    filter = PMXEVTYPEN[n]<31:27>;
```

```
H = (if HaveVirtExt() then filter<0> else '0');
P = filter<4>;
U = filter<3>;

if !IsSecure() then
    kpmuen = DBGAUTHSTATUS.NSNE == '1' || (n == 31 && PMCR.DP == '0');
    upmuen = kpmuen;
    P = P EOR filter<2>;
    U = U EOR filter<1>;
else
    kpmuen = DBGAUTHSTATUS.SNE == '1' || (n == 31 && PMCR.DP == '0');
    upmuen = (kpmuen ||
              (HaveSecurityExt() && DBGAUTHSTATUS.NSNE == '1' && SDER.SUNIDEN == '1'));

E = (if !HaveVirtExt() || n == 31 || n < UInt(HDCR.HPMN) then PMCR.E else HDCR.HPME);

if CurrentModeIsHyp()      then enable = kpmuen && H == '1';
elseif CurrentModeIsNotUser() then enable = kpmuen && P == '0';
else                       enable = upmuen && U == '0';

return enable && E == '1' && PMCNTEN<n> == '1' && DBGDSCR.HALTED == '0';
```

## C12.6 Counter enables

If the processor does not implement the Virtualization Extensions, the **PMCR.E** bit is a global counter enable bit, and **PMCNTENSET** provides an enable bit for each counter, as [Table C12-2](#) shows.

**Table C12-2 Event counter enables when an implementation does not include the Virtualization Extensions**

<b>PMCR.E</b>	<b>PMCNTENSET[x] = 0</b>	<b>PMCNTENSET[x] = 1</b>
0	PMNx disabled	PMNx disabled
1	PMNx disabled	PMNx enabled

For more information about the enable bits, see *PMCR, Performance Monitors Control Register, VMSA* on page B4-1676, and *PMCNTENSET, Performance Monitors Count Enable Set register, VMSA* on page B4-1674.

If the implementation includes the Virtualization Extensions, then in addition to the **PMCR.E** and **PMCNTENSET** enable bits:

- The **HDCR.HPME** bit overrides the value of the **PMCR.E** bit for counters configured for access in Hyp mode.
- The **HDCR.HPMN** bit specifies the number of performance counters that the Guest OS can access. The minimum permitted value of **HDCR.HPMN** is 1, meaning there must be at least one counter that the Guest OS can access.

[Table C12-3](#) shows the combined effect of all the counter enable controls.

**Table C12-3 Event counter enables when an implementation includes the Virtualization Extensions**

		<b>PMCNTENSET[x] = 0</b>		<b>PMCNTENSET[x] = 1</b>	
<b>HDCR.HPME</b>	<b>PMCR.E</b>		<b>x &lt; HDCR.HPMN</b>	<b>x ≥ HDCR.HPMN</b>	
0	0	PMNx disabled	PMNx disabled	PMNx disabled	
0	1	PMNx disabled	PMNx enabled	PMNx disabled	
1	0	PMNx disabled	PMNx disabled	PMNx enabled	
1	1	PMNx disabled	PMNx enabled	PMNx enabled	

———— **Note** —————

The effect of **HDCR.HPME** and **HDCR.HPMN** on the counter enables applies in both security states. However, in Secure state the value returned for **PMCR.N** is not affected by **HDCR.HPMN**.

The Virtualization Extensions do not affect the enabling of **PMCCNTR**. [Table C12-4](#) shows the **PMCCNTR** enables, for all implementations.

**Table C12-4 Cycle counter enables**

<b>PMCR.E</b>	<b>PMCNTENSET[31] = 0</b>	<b>PMCNTENSET[31] = 1</b>
0	<b>PMCCNTR</b> disabled	<b>PMCCNTR</b> disabled
1	<b>PMCCNTR</b> disabled	<b>PMCCNTR</b> enabled

## C12.7 Counter access

Counters are accessible in Secure PL1 modes and Hyp mode. If the hypervisor uses `HDCR.HPMN` to reserve an event counter, software cannot access that counter from Non-secure PL1 modes or from Non-secure User mode. See [HDCR, Hyp Debug Configuration Register, Virtualization Extensions on page B4-1583](#) for more information.

———— **Note** —————

This section describes a counter as being accessible from a particular mode and state. However, access to the registers are subject to the access permissions described in [Access permissions on page C12-2328](#). In particular, accesses from a PL0 mode might be UNDEFINED and accesses from Non-secure PL1 and PL0 modes might cause a Hyp Trap exception.

### C12.7.1 PMNx event counters

For a processor that implements the Virtualization Extensions, [Table C12-5](#) shows how the values of the `HDCR.HPMN` field controls the behavior of accesses to the PMNx event counter registers.

**Table C12-5 Result of PMNx event counter accesses**

$x < \text{HDCR.HPMN}$	Secure modes		Non-secure modes		
	PL1	PL0	PL2	PL1	PL0
Yes	Succeeds	Succeeds	Succeeds	Succeeds	Succeeds
No	Succeeds	Succeeds	Succeeds	No access	No access

Where [Table C12-5](#) shows no access:

- if `PMSELR.SEL` is  $x$  then:
  - a read of `PMXEVTYPER` or `PMXEVCNTR` returns UNKNOWN
  - a write to `PMXEVTYPER` or `PMXEVCNTR` is UNPREDICTABLE.
- `PMOVSRR[x]`, `PMOVSSET[x]`, `PMCNTENSET[x]`, `PMCNTENCLR[x]`, `PMINTENSET[x]`, and `PMINTENCLR[x]` are RAZ/WI
- writes to `PMSWINC[x]` are ignored
- a write of 1 to `PMCR.P` does not reset PMNx.

———— **Note** —————

In Secure state, and in the Non-secure PL2 mode, the value of `HDCR.HPMN` does not affect the value returned for `PMCR.N`.

### C12.7.2 CCNT cycle counter

The PMU does not provide any control that a hypervisor can use to reserve the cycle counter for its own use. The only control over the cycle counter is an access permission control for User mode. See [Access permissions on page C12-2328](#).

## C12.8 Event numbers and mnemonics

The following sections describe the event numbers, and the mnemonics for the events:

- [Definition of terms](#)
- [Common event numbers on page C12-2316](#)
- [Common architectural event numbers on page C12-2317](#)
- [Common microarchitectural event numbers on page C12-2320](#)
- [Required events on page C12-2325](#)
- [IMPLEMENTATION DEFINED event numbers on page C12-2325](#).

---

### Note

In this section, references to Performance Monitors registers refer to the descriptions of those registers in [Chapter B4 System Control Registers in a VMSA implementation](#). As [CP15 c9 performance monitors registers on page C12-2326](#) shows, most of these registers are also described in [Chapter B6 System Control Registers in a PMSA implementation](#).

---

### C12.8.1 Definition of terms

#### Speculatively executed

Many events relate to speculatively executed instructions. Here, speculatively executed means the processor did some work associated with one or more instructions but the instructions were not necessarily architecturally executed.

An instruction might create one or more *microarchitectural operations* ( $\mu$ -ops) at any point in the execution pipeline. For the purpose of event counting, the  $\mu$ -ops are also counted. An architecture instruction might create more than one speculatively executed instruction.  $\mu$ -ops might also be removed or merged in the execution stream, so an architecture instruction might create no speculatively executed instructions. Any arbitrary translation of architecture instructions to an equivalent sequence of  $\mu$ -ops is permitted.

This means there is no architecturally guaranteed relationship between a speculatively executed  $\mu$ -op and an architecturally executed instruction.

The counting of speculatively executed instructions can indicate the workload on the processor. However, there is no requirement for operations to represent similar amounts of work, and there is no requirement for direct comparisons between different microarchitectures to be meaningful.

The results of such an operation can also be discarded, if it transpires that the operation was not required, such as a mispredicted branch. Therefore, the operation is speculatively executed.

For example, an implementation can split an LDM instruction of six registers into six  $\mu$ -ops, one for each load, and a seventh address-generation operation to determine the base address or writeback address. Also, for doubleword alignment, the six load  $\mu$ -ops might combine into four operations, that is, a word load, two doubleword loads, and a second word load. This single instruction can then be counted as five, or possibly six, events:

- 4  $\times$  Instruction speculatively executed - Load
- 1  $\times$  Instruction speculatively executed - Integer data processing
- 1  $\times$  Instruction speculatively executed - Software change of the PC, if the PC was one of the six registers in the LDM instruction.

Different groups of events are permitted to have different IMPLEMENTATION DEFINED definitions of speculatively executed. Such groups share a common base type, which the event name denotes. Each of the events in the previous example are of the base type, Instruction speculatively executed.

For groups of events with a common base type, speculatively executed operations are all counted on the same basis, which normally means at the same point in the pipeline. It is possible to compare the counts and make meaningful observations about the program being profiled.

Within these groups, events are commonly defined with reference to a particular architecture instruction or group of instructions. In the case of speculatively executed operations this means operations with semantics that map to that type of instruction.

### Instruction memory access

A processor acquires instructions for execution through instruction fetches. Instruction fetches might be due to:

- fetching instructions that are architecturally executed
- the result of the execution of an instruction preload instruction, PLI
- speculation that a particular instruction might be executed in the future.

The relationship between the fetch of an individual instruction and an instruction memory access is IMPLEMENTATION DEFINED. For example, an implementation might fetch many instructions including a non-integer number of instructions in a single instruction memory access.

### Memory-read operations

A processor accesses memory through memory-read and memory-write operations. A memory-read operation might be due to:

- the result of an architecturally executed memory-reading instructions
- the result of a speculatively executed memory-reading instructions
- a translation table walk.

For levels of cache hierarchy beyond the Level 1 caches, memory-read operations also include accesses made as part of a refill of another cache closer to the processor. Such refills might be due to:

- memory-read operations or memory-write operations that miss in the cache
- the execution of a data preload instruction, PLD or PLDW
- or a unified cache, the execution of an instruction preload instruction, PLI
- the execution of a cache maintenance operation

———— **Note** ————

A preload instruction or cache maintenance operation is not, in itself, an access to that cache. However, it might generate cache refills which are then treated as memory-read operations beyond that cache.

- speculation that a future instruction might access the memory location.

This list is not exhaustive.

The relationship between memory-reading instructions and memory-read operations is IMPLEMENTATION DEFINED. For example, for some implementations an LDM instruction that reads two registers might generate one memory-read operation if the address is doubleword-aligned, but for other addresses it generates two memory-read operations.

### Memory-write operations

Memory-write operations might be due to:

- the result of an architecturally executed memory-writing instructions
- the result of a speculatively executed memory-writing instructions.

———— **Note** ————

Speculatively executed memory-writing instructions that do not become architecturally executed must not alter the architecturally defined view of memory. They can, however, generate a memory-write operation that is later undone in some implementation-specific way.

For levels of cache hierarchy beyond the Level 1 caches, memory-write operations also include accesses made as part of a write-back from another cache closer to the processor. Such write-backs might be due to:

- evicting a dirty line from the cache, to allocate a cache line for a cache refill, see memory-read operations
- the execution of a cache maintenance operation

———— **Note** ————

A cache maintenance operation is not in itself an access to that cache. However, it might generate write-backs which are then treated as memory-write operations beyond that cache.

- the result of a coherency request from another processor.

This list is not exhaustive.

The relationship between memory-writing instructions and memory-write operations is IMPLEMENTATION DEFINED. For example, for some implementations an STM instruction that writes two registers might generate one memory-write operation if the address is doubleword-aligned, but for other addresses it generates two memory-write operations. In other implementations, the result of two STR instructions that write to adjacent memory might be merged into a single memory-write operation.

———— **Note** ————

The data written back from a cache that is shared with other processors might not be data that was written by the processor that performs the operation that leads to the write-back. Nevertheless, the event is counted as a write-back event for that processor.

### Instruction architecturally executed

*Instruction architecturally executed* is a class of event that counts for each instruction of the specified type. Architecturally executed means that the program flow is such that the counted instruction would be executed in a sequential execution of the program. Therefore an instruction that has been executed and retired is defined to be *architecturally executed*. In processors that perform speculative execution, an instruction is not architecturally executed if the processor discards the results of the speculative execution.

Each architecturally executed instruction is counted once, even if the implementation splits the instruction into multiple operations. Instructions that have no visible effect on the architectural state of the processor are architecturally executed if they form part of the architecturally executed program flow. The point where such instructions are retired is IMPLEMENTATION DEFINED.

Examples of instructions that have no visible effect are:

- a NOP
- a conditional instruction that fails its condition code check
- a Compare and Branch on Zero, CBZ, instruction that does not branch
- a Compare and Branch on Nonzero, CBNZ, instruction that does not branch.

The point at which an event causes an event counter to be updated is not defined.

Unless otherwise stated, all instructions of the specified type are counted even if they have no visible effect on the architectural state of the processor. This includes a conditional instruction that fails its condition code check.

For events that count only the execution of instructions that update context state, such as writes to the [CONTEXTIDR](#), if such an instruction is executed twice without an intervening context synchronization operation, it is UNPREDICTABLE whether the first instruction is counted if it is UNPREDICTABLE whether this instruction had any effect on the context state.

———— **Note** ————

See [Context synchronization operation](#) for the definition of this term.

### Instruction architecturally executed, condition code check pass

*Instruction architecturally executed, condition code check pass* is a class of events that explicitly do not occur for:

- a conditional instruction that fails its condition code check
- a Compare and Branch on Zero, CBZ, instruction that does not branch
- a Compare and Branch on Nonzero, CBNZ, instruction that does not branch
- a Store-Exclusive instruction that does not write to memory.

Otherwise, the definition of architecturally executed is the same as for *Instruction architecturally executed*.

## C12.8.2 Common event numbers

Table C12-6 lists the PMU architectural and microarchitectural event numbers in event number order.

**Table C12-6 PMU event numbers**

Event number	Event type	Event mnemonic	Description
0x00	Architectural	SW_INCR	Instruction architecturally executed, condition code check pass, software increment
0x01	Microarchitectural	L1I_CACHE_REFILL	Level 1 instruction cache refill
0x02	Microarchitectural	L1I_TLB_REFILL	Level 1 instruction TLB refill
0x03	Microarchitectural	L1D_CACHE_REFILL	Level 1 data cache refill
0x04	Microarchitectural	L1D_CACHE	Level 1 data cache access
0x05	Microarchitectural	L1D_TLB_REFILL	Level 1 data TLB refill
0x06	Architectural	LD_RETIRED	Instruction architecturally executed, condition code check pass, load
0x07	Architectural	ST_RETIRED	Instruction architecturally executed, condition code check pass, store
0x08	Architectural	INST_RETIRED	Instruction architecturally executed
0x09	Architectural	EXC_TAKEN	Exception taken
0x0A	Architectural	EXC_RETURN	Instruction architecturally executed, condition code check pass, exception return
0x0B	Architectural	CID_WRITE_RETIRED	Instruction architecturally executed, condition code check pass, write to CONTEXTIDR
0x0C	Architectural	PC_WRITE_RETIRED	Instruction architecturally executed, condition code check pass, software change of the PC
0x0D	Architectural	BR_IMMED_RETIRED	Instruction architecturally executed, immediate branch
0x0E	Architectural	BR_RETURN_RETIRED	Instruction architecturally executed, condition code check pass, procedure return
0x0F	Architectural	UNALIGNED_LDST_RETIRED	Instruction architecturally executed, condition code check pass, unaligned load or store
0x10	Microarchitectural	BR_MIS_PRED	Mispredicted or not predicted branch speculatively executed



Table C12-6 PMU event numbers (continued)

Event number	Event type	Event mnemonic	Description
0x11	Microarchitectural	CPU_CYCLES	Cycle
0x12	Microarchitectural	BR_PRED	Predictable branch speculatively executed
0x13	Microarchitectural	MEM_ACCESS	Data memory access
0x14	Microarchitectural	L1I_CACHE	Level 1 instruction cache access
0x15	Microarchitectural	L1D_CACHE_WB	Level 1 data cache write-back
0x16	Microarchitectural	L2D_CACHE	Level 2 data cache access
0x17	Microarchitectural	L2D_CACHE_REFILL	Level 2 data cache refill
0x18	Microarchitectural	L2D_CACHE_WB	Level 2 data cache write-back
0x19	Microarchitectural	BUS_ACCESS	Bus access
0x1A	Microarchitectural	MEMORY_ERROR	Local memory error
0x1B	Microarchitectural	INST_SPEC	Instruction speculatively executed
0x1C	Architectural	TTBR_WRITE_RETIRED	Instruction architecturally executed, condition code check pass, write to TTBR
0x1D	Microarchitectural	BUS_CYCLES	Bus cycle

### C12.8.3 Common architectural event numbers

This section describes the defined common architectural event numbers.

For the common features, normally the counters must increment only once for each event. The event descriptions include any exceptions to this rule.

In these definitions, the term *architecturally executed* means that the instruction flow is such that the counted instruction would have been executed in a simple sequential execution model.

The common architectural event numbers are:

#### 0x00, Instruction architecturally executed, condition code check pass, software increment

The counter increments on writes to the [PMSWINC](#) register.

If the processor performs two architecturally executed writes to the [PMSWINC](#) without an intervening context synchronization operation, then the event is counted twice.

#### 0x06, Instruction architecturally executed, condition code check pass, load

The counter increments for every executed memory-reading instruction, including SWP. See [Reads on page A3-146](#) for the definition of a memory-reading instruction. That section lists the return of status information by a STREX, STREXB, STREXD, or STREXH as having the semantics of a load. However, despite that return of status information, these instructions are not memory-reading instructions, and event 0x06 does not count the execution of these instructions.

Whether the preload instructions PLD, PLDW, and PLI, count as memory-reading instructions is IMPLEMENTATION DEFINED. ARM recommends that if the instruction is not implemented as a NOP then it is counted as a memory-reading instruction.

**0x07, Instruction architecturally executed, condition code check pass, store**

The counter increments for every executed memory-writing instruction, including SWP. See [Writes on page A3-146](#) for the definition of a memory-writing instruction.

The counter does not increment for a Store-Exclusive instruction that fails.

**0x08, Instruction architecturally executed**

The counter increments for every architecturally executed instruction.

**0x09, Exception taken**

The counter increments for each exception taken. See [Exception-related events on page C12-2309](#).

———— **Note** —————

The counter counts only the processor exceptions described in [Exception handling on page B1-1164](#). It does not count untrapped floating-point exceptions or ThumbEE null checks and index checks.

**0x0A, Instruction architecturally executed, condition code check pass, exception return**

The counter increments for each executed exception return instruction. [Exception return on page B1-1193](#) defines the counted instructions. See [Exception-related events on page C12-2309](#).

**0x0B, Instruction architecturally executed, condition code check pass, write to CONTEXTIDR**

The counter increments for every write to the [CONTEXTIDR](#). See [Exception-related events on page C12-2309](#).

———— **Note** —————

In an implementation that includes the Large Physical Address Extension, to count the number of ASID updates:

- If the [TTBCR.EAE](#) bit is 0, use this event.
- Otherwise, use event 0x1C, *Instruction architecturally executed, condition code check pass, write to TTBR*.

If the processor performs multiple architecturally-executed writes to the [CONTEXTIDR](#) without intervening context synchronization operations, the number of events counted is an UNPREDICTABLE value between a minimum of 1 and a maximum of the total number of executed writes to the [CONTEXTIDR](#).

**0x0C, Instruction architecturally executed, condition code check pass, software change of the PC**

The counter increments for every software change of the PC. This includes all:

- branch instructions
- memory-reading instructions that explicitly write to the PC
- data processing instructions that explicitly write to the PC
- exception return instructions
- exception-generating instructions, SVC, HVC and SMC.

It is IMPLEMENTATION DEFINED whether the counter increments for either or both of:

- BKPT instructions
- Undefined Instruction exceptions.

It is IMPLEMENTATION DEFINED whether an ISB is counted as a software change of the PC.

The counter does not increment for exceptions other than those explicitly identified in these lists.

**0x0D, Instruction architecturally executed, immediate branch**

The counter counts all immediate branch instructions that are architecturally executed.

The counter increments each time the processor executes one of the following instructions:

- B{L} <label>
- BLX <label>
- CB{N}Z <Rn>, <label>
- In ThumbEE state only, HB{L} #HandlerId
- In ThumbEE state only, HB{L}P #<imm>, #HandlerId.

If an ISB is counted as a software change of the PC instruction then it is IMPLEMENTATION DEFINED whether an ISB is counted as an immediate branch instruction.

**0x0E, Instruction architecturally executed, condition code check pass, procedure return**

The counter counts the following procedure return instructions:

- BX R14
- MOV PC, LR
- POP {..., PC}
- LDR PC, [SP], #offset
- In ThumbEE state only, LDMIA R9!, {..., PC}
- In ThumbEE state only, LDR PC, [R9], #offset.

————— **Note** —————

The counter counts only the listed instructions as procedure returns. For example, it does not count the following as procedure return instructions:

- BX R0, because Rm != R14
- MOV PC, R0, because Rm != R14
- LDM SP, {..., PC}, because writeback is not specified
- LDR PC, [SP, #offset], because this specifies the wrong addressing mode.

**0x0F, Instruction architecturally executed, condition code check pass, unaligned load or store**

The counter counts each memory-reading instruction or memory-writing instruction that accesses an unaligned address. It is IMPLEMENTATION DEFINED whether this event also counts each Alignment fault Data Abort exception.

See [Unaligned data access on page A3-108](#) for more information.

**0x1C, Instruction architecturally executed, condition code check pass, write to TTBR**

The counter counts writes to the translation table base registers, [TTBR0](#) and [TTBR1](#). See [Exception-related events on page C12-2309](#).

————— **Note** —————

In an implementation that includes the Large Physical Address Extension, to count the number of ASID updates:

- If the [TTBCR.EAE](#) bit is 1, use this event.
- Otherwise, use event 0x0B, *Instruction architecturally executed, condition code check pass, write to [CONTEXTIDR](#)*.

If the processor performs multiple architecturally-executed writes to [TTBR0](#), or [TTBR1](#), without intervening context synchronization operations, the number of events counted is an UNPREDICTABLE value between a minimum of 1 and a maximum of the total number of executed writes to the [TTBRn](#) registers.

———— **Note** ————

If the implementation includes:

- the Security Extensions, then writes to the Banked copies of **TTBR0** and **TTBR1** are counted
- the Virtualization Extensions, then writes to the **HTTBR** and **VTTBR** are not counted.

ARM recommends that this event is implemented if the implementation includes the Large Physical Address Extension.

#### C12.8.4 Common microarchitectural event numbers

This section describes the defined common microarchitectural event numbers.

The common microarchitectural events are features that are likely to be implemented across a wide range of implementations. Unlike the common architectural events, there can be some IMPLEMENTATION DEFINED variation between definitions on different implementations.

Unless otherwise stated, the common microarchitectural features relate only to events resulting from the operation of the processor counting the events. Events resulting from the operation of other processors that might share a resource must not be counted. Where a resource can be subject to events that do not result from the operation of any of the ARM processors that share it, ARM recommends that the resource implements its own event counters. An example of a resource that might require its own event counters is a shared Level 2 cache that is subject to accesses from a system coherency port on that cache.

The event definitions relating to Level 2 caches generally assume the Level 2 cache is shared. The event definitions relating to Level 1 caches generally assume the Level 1 cache is not shared.

The common microarchitectural event numbers are:

##### **0x01, Level 1 instruction cache refill**

The counter counts instruction memory accesses that cause a refill of at least the Level 1 instruction or unified cache. This includes each instruction memory access that causes a refill from outside the cache. It excludes accesses that do not cause a new cache refill but are satisfied from refilling data of a previous miss.

CP15 cache maintenance operations do not count as events.

##### **0x02, Level 1 instruction TLB refill**

The counter counts instruction memory accesses that cause a TLB refill of at least the Level 1 instruction TLB. This includes each instruction memory access that causes an access to a level of memory system due to a translation table walk or an access to another level of TLB caching. It is IMPLEMENTATION DEFINED whether the count increments when:

- a refill results in a Translation fault
- a refill is not allocated in the TLB.

The counter does not count:

- a TLB miss that does not cause a refill but does generate a translation table walk
- CP15 TLB maintenance operations.

#### 0x03, Level 1 data cache refill

The counter counts each memory-read operation or memory-write operation that causes a refill of at least the Level 1 data or unified cache from outside the Level 1 cache. Each access that causes a new linefill is counted, including those from instructions that generate multiple accesses, such as load or store multiples, and PUSH and POP instructions. In particular, the counter counts accesses to the Level 1 cache that cause a refill that is satisfied by another Level 1 data or unified cache, or a Level 2 cache, or memory.

The counter does not count:

- accesses that do not cause a new Level 1 cache refill but are satisfied from refilling data of a previous miss
- accesses that generate a memory access but not a new linefill, such as write-throughs
- CP15 cache maintenance operations.

#### 0x04, Level 1 data cache access

The counter counts each memory-read operation or memory-write operation that causes a cache access to at least the Level 1 data or unified cache. Each access to a cache line is counted including the multiple accesses of instructions, such as LDM or STM. Each access to other Level 1 data or unified memory structures, for example refill buffers, write buffers, and write-back buffers, is also counted.

CP15 cache maintenance operations do not count as events.

#### 0x05, Level 1 data TLB refill

The counter counts each memory-read operation or memory-write operation that causes a TLB refill of at least the Level 1 data or unified TLB. It counts each read or write that causes a refill, in the form of a translation table walk or an access to another level of TLB caching. It is IMPLEMENTATION DEFINED whether the count increments when:

- a refill results in a Translation fault
- a refill is not allocated in the TLB.

The counter does not count:

- a TLB miss that does not cause a refill but does generate a translation table walk
- CP15 TLB maintenance operations.

#### 0x10, Mispredicted or not predicted branch speculatively executed

The counter counts each correction to the predicted program flow that occurs because of a misprediction from, or no prediction from, the branch prediction resources and that relates to instructions that the branch prediction resources are capable of predicting.

0x11, Cycle The counter increments on every cycle.

#### ————— Note —————

Unlike [PMCCNTR](#), this count is not affected by [PMCR.DP](#), [PMCR.D](#), or [PMCR.C](#):

- The counter is not incremented if non invasive debug is not permitted, so is not affected by [PMCR.DP](#).
- The counter increments on every cycle, regardless of the setting of [PMCR.D](#).
- The counter is reset when event counters are reset by [PMCR.P](#), never by [PMCR.C](#).

#### 0x12, Predictable branch speculatively executed

The counter counts every branch or other change in the program flow that the branch prediction resources are capable of predicting.

#### 0x13, Data memory access

The counter counts memory-read or memory-write operations that the processor made. The counter increments whether the access results in an access to a Level 1 data or unified cache, a Level 2 data or unified cache, or neither of these.

The counter does not increment as a result of:

- instruction memory access, see *Definition of terms* on page C12-2313
- translation table walks
- CP15 cache maintenance operations
- write-back from any cache
- refilling of any cache.

#### 0x14, Level 1 instruction cache access

The counter counts instruction memory accesses that access at least the Level 1 instruction or unified cache. Each access to other Level 1 instruction memory structures, such as refill buffers, is also counted.

#### 0x15, Level 1 data cache write-back

The counter counts every write-back of data from the Level 1 data or unified cache. The counter counts each write-back that causes data to be written from the Level 1 cache to outside of the Level 1 cache. For example, the counter counts the following cases:

- A write-back that causes data to be written to a Level 2 cache or memory.
- A write-back of a recently fetched cache line that has not been allocated to the Level 1 cache.
- Transfer of data from the Level 1 cache to outside of this cache made as a result of a coherency request. The conditions to which of these are counted for transfers to other Level 1 caches within the same multiprocessor cluster are IMPLEMENTATION DEFINED.

Each write-back is counted once, even if multiple accesses are required to complete the write-back.

Whether this also includes write-backs made as a result of CP15 cache maintenance operations is IMPLEMENTATION DEFINED.

The counter does not count:

- the invalidation of a cache line without any write-back to a Level 2 cache or memory
- writes from the processor that write through the Level 1 cache to outside of the Level 1 cache.

#### 0x16, Level 2 data cache access

The counter counts memory-read or memory-write operations, that the processor made, that access at least the Level 2 data or unified cache. Each access to a cache line is counted including refills of and write-backs from the Level 1 data, instruction, or unified caches. Each access to other Level 2 data or unified memory structures, such as refill buffers, write buffers, and write-back buffers, is also counted.

The counter does not count:

- operations made by other processors that share this cache
- CP15 cache maintenance operations.

#### 0x17, Level 2 data cache refill

The counter counts memory-read or memory-write operations, that the processor made, that access at least the Level 2 data or unified cache and cause a refill of a Level 1 data, instruction, or unified cache or of the Level 2 data or unified cache. Each read from or write to the cache that causes a refill from outside the Level 1 and Level 2 caches is counted.

For example, the counter counts:

- accesses to the Level 2 cache that cause a refill that is satisfied by another Level 2 cache, a Level 3 cache, or memory
- refills of and write-backs from any Level 1 data, instruction or unified cache that cause a refill from outside the Level 1 and Level 2 caches
- accesses to the Level 2 cache that cause a refill of a Level 1 cache from outside of the Level 1 and Level 2 caches, even if there is no refill of the Level 2 cache.

The counter does not count:

- accesses that do not cause a new cache refill but are satisfied from refilling data of a previous miss
- accesses to the Level 2 cache that generate a memory access but not a new linefill, such as write-through writes that hit in the Level 2 cache
- accesses to the Level 2 cache that are part of a Level 1 cache refill or write-back that hit in the Level 2 cache so do not cause a refill from outside of the Level 1 and Level 2 caches
- operations made by other processors that share this cache, as events on this processor
- CP15 cache maintenance operations.

#### 0x18, Level 2 data cache write-back

The counter counts every write-back of data from the Level 2 data or unified cache that occurs as a result of an operation by this processor. It counts each write-back that causes data to be written from the Level 2 cache to outside the Level 1 and Level 2 caches. For example, the counter counts:

- a write-back that causes data to be written to a Level 3 cache or memory
- a write-back of a recently fetched cache line that has not been allocated to the Level 2 cache.

Each write-back is counted once, even if it requires multiple accesses to complete the write-back.

It is IMPLEMENTATION DEFINED whether the counter counts:

- A transfer of data from the Level 2 cache to outside the Level 1 and Level 2 cache made as a result of a coherency request, but:
  - if the Level 2 cache is shared then the transfer is not counted because it is not caused by an operation by this processor
  - if the Level 2 cache is not shared then the conditions that determine which of these transfers are counted, for transfers to other Level 2 caches within the same multiprocessor cluster, are IMPLEMENTATION DEFINED.
- Write-backs made as a result of CP15 cache maintenance operations.

The counter does not count:

- the invalidation of a cache line without any write-back to a Level 3 cache or memory
- writes from the processor or Level 1 data or unified cache that write through the Level 2 cache to outside the Level 1 and Level 2 caches
- transfers of data from the Level 2 cache to a Level 1 cache, to satisfy a Level 1 cache refill.

#### 0x19, Bus access

The counter counts memory-read or memory-write operations that access outside of the boundary of the processor and its closely-coupled caches. Where this boundary lies with respect to any implemented caches is IMPLEMENTATION DEFINED. It must count accesses beyond the cache furthest from the processor for which accesses can be counted.

This means that:

- if Level 2 cache access events are implemented and no IMPLEMENTATION DEFINED events can count accesses for any caches outside a Level 2 cache, this counter increments for an access beyond the Level 2 cache
- if Level 2 cache access events are not implemented and Level 1 cache access events are implemented, this counter increments for an access beyond the Level 1 cache
- if neither Level 1 or Level 2 cache access events are implemented, this counter increments for all data accesses that the processor made.

The definition of a bus access is IMPLEMENTATION DEFINED but physically is a single beat rather than a burst. That is, for each bus cycle for which the bus is active.

Bus accesses include refills of and write-backs from Level 1 and Level 2 data, instruction, and unified caches. Whether bus accesses include operations that do use the bus but not explicitly transfer data, such as barrier operations, is IMPLEMENTATION DEFINED.

Where an implementation has multiple external buses, this event counts the sum of accesses across all buses.

If a bus supports multiple accesses per cycle, for example through multiple channels, the counter increments once for each channel that is active on a cycle, and so it might increment by more than one in any given cycle.

#### 0x1A, Local memory error

The counter counts every occurrence of a memory error signaled by a memory closely coupled to this processor. The definition of local memories is IMPLEMENTATION DEFINED but includes caches, tightly-coupled memories, and TLB arrays.

Memory error refers to a physical error detected by the hardware, such as a parity error. It includes errors that are correctable and those that are not. It does not include errors as defined in the architecture, such as MMU and MPU faults.

#### 0x1B, Instruction speculatively executed

The counter counts instructions that are speculatively executed by the processor. This includes instructions that are subsequently not architecturally executed. As a result, this event counts a larger number of instructions than the number of instructions architecturally executed. The definition of speculatively executed is IMPLEMENTATION DEFINED.

#### 0x1D, Bus cycle

The counter increments on every cycle of the external memory interface of the processor.

———— **Note** —————

If the processor clocks the external memory interface at the same rate as the processor, the counter counts every cycle.

—————



### C12.8.5 Required events

A processor that implements PMU version 2 must implement the following common events:

- 0x00, Instruction architecturally executed, condition code check pass, software increment
- 0x03, Level 1 data cache refill
- 0x04, Level 1 data cache access
- 0x10, Mispredicted or not predicted branch speculatively executed
- 0x11, Cycle
- 0x12, Predictable branch speculatively executed
- at least one of:
  - 0x08, Instruction architecturally executed
  - 0x1B, Instruction speculatively executed.

———— **Note** —————

ARM recommends that events 0x08 and 0x1B are implemented.

The following exceptions apply:

- a processor without a Level 1 data or unified cache does not have to implement events 0x03 and 0x04
- a processor with no program flow prediction resources does not have to implement events 0x10 and 0x12.

### C12.8.6 IMPLEMENTATION DEFINED event numbers

For IMPLEMENTATION DEFINED event numbers, each counter is defined, independently, to either:

- increment only once for each event
- count the duration for which an event occurs.

ARM recommends that implementers establish a standardized numbering scheme for their IMPLEMENTATION DEFINED events, with common definitions, and common count numbers, applied to all the processors they implement. In general, the recommended approach is for standardization across implementations with common features. However, ARM recognizes that attempting to standardize the encoding of microarchitectural features across too wide a range of implementations is not productive.

ARM strongly recommends that at least the following classes of event are identified in the IMPLEMENTATION DEFINED events:

- Cumulative duration of stalls resulting from the holes in the instruction availability, separating out counts for key buffering points that might exist.
- Cumulative duration data-dependent stalls, separating out counts for key dependency classes that might exist.
- Cumulative duration of stalls due to unavailability of execution resources, including, for example, write buffers, separating out counts for key resources that might exist.
- Missed superscalar issue opportunities, if relevant, separating out counts for key classes of issue that might exist.
- Miss rates for different levels of caches and TLBs.
- Any external events passed to the processor through an IMPLEMENTATION DEFINED mechanism.
- Cumulative durations for which the CPSR.I and CPSR.F interrupt mask bits are set to 1.
- Any other microarchitectural features that the implementer considers are valuable to count.

The IMPLEMENTATION DEFINED event numbers are 0x40 to 0xFF. [Appendix C Recommendations for Performance Monitors Event Numbers for IMPLEMENTATION DEFINED Events](#) lists the ARM recommended standardized numbering scheme for these events.

## C12.9 Performance Monitors registers

This section describes the Performance Monitors Extension registers.

### C12.9.1 CP15 c9 performance monitors registers

The Performance Monitors Extension registers are part of the CP15 register map. Figure C12-1 shows the CP15 c9 encodings for these registers, and the reserved encodings for:

- possible extensions to the ARM Performance Monitors Extension
- IMPLEMENTATION DEFINED performance monitors.

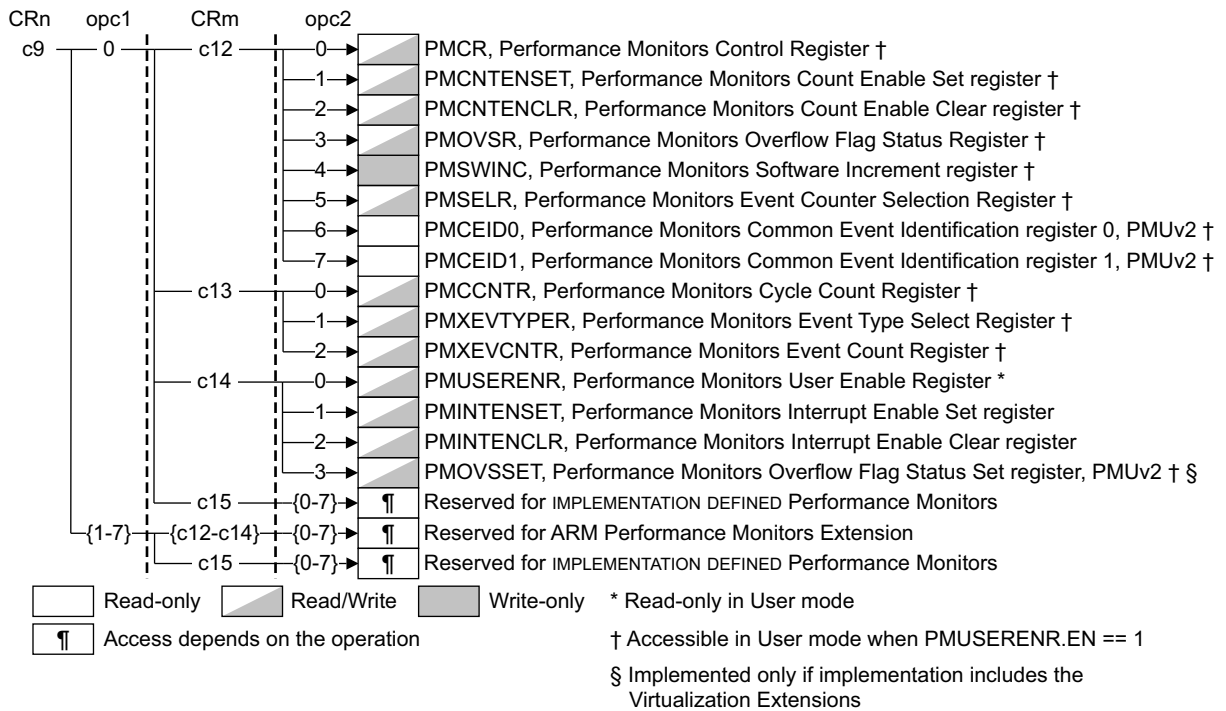

**Figure C12-1 CP15 c9 Performance Monitors registers**

See [Access permissions on page C12-2328](#) for information about User mode access to the Performance Monitors.

[Table C12-7 on page C12-2327](#) lists the Performance Monitors Extension registers and shows where each register is described in full.

An implementation can include either or both:

- access to the Performance Monitors registers through an external debug interface
- a memory-mapped interface to the Performance Monitors registers,

Compared to the CP15 view of the Performance Monitors registers, when using one of these interfaces there are some differences in both the registers that are visible and the behavior of register accesses. For more information, see [Appendix B Recommended Memory-mapped and External Debug Interfaces for the Performance Monitors](#).

**Table C12-7 Performance Monitors register summary**

Name, VMSA <sup>a</sup>	Name, PMSA <sup>a</sup>	opc1	CRm <sup>b</sup>	opc2	Type	Description
PMCR	PMCR	0	c12	0	RW	Performance Monitors Control Register
PMCNTENSET	PMCNTENSET			1	RW	Performance Monitors Count Enable Set register
PMCNTENCLR	PMCNTENCLR			2	RW	Performance Monitors Count Enable Clear register
PMOVSr	PMOVSr			3	RW	Performance Monitors Overflow Flag Status Register
PMSWINC	PMSWINC			4	WO	Performance Monitors Software Increment register
PMSELR	PMSELR			5	RW	Performance Monitors Event Counter Selection Register
PMCEID0	PMCEID0			6	RO	Performance Monitors Common Event Identification register 0
PMCEID1	PMCEID1			7	RO	Performance Monitors Common Event Identification register 1
PMCCNTR	PMCCNTR		c13	0	RW	Performance Monitors Cycle Count Register
PMXEVTYPER	PMXEVTYPER			1	RW	Performance Monitors Event Type Select Register
PMXEVCNTR	PMXEVCNTR			2	RW	Performance Monitors Event Count Register
PMUSERENR	PMUSERENR		c14	0	RW <sup>c</sup>	Performance Monitors User Enable Register
PMINTENSET	PMINTENSET			1	RW	Performance Monitors Interrupt Enable Set register
PMINTENCLR	PMINTENCLR			2	RW	Performance Monitors Interrupt Enable Clear register
PMOVSSET <sup>d</sup>	_ <sup>d</sup>			3	RW	Performance Monitors Overflow Flag Status Set register

- a. VMSA and PMSA definitions of the register fields are identical. These columns link to the descriptions in [Chapter B4](#) and [Chapter B6](#).
- b. CP15 c9 encodings with CRm == {c12-c14} not listed in the table are reserved. For details of the behavior of accesses to these encodings see [Accesses to unallocated CP14 and CP15 encodings on page B3-1447](#).
- c. RO in User mode.
- d. Implemented only as part of the Virtualization Extensions, otherwise encoding is reserved.

### Power domains and Performance Monitors registers reset

For ARMv7 implementations, ARM recommends that performance monitors are implemented as part of the core power domain, not as part of a separate debug power domain. There is no interface to access the Performance Monitors registers when the core power domain is powered down.

A non-debug logic reset sets the Performance Monitors registers to their reset values. A debug logic reset does not change the values of the Performance Monitors registers.

For more information about the reset scheme recommended for a v7 Debug implementation see [Reset and debug on page C7-2160](#).

## Access permissions

Normally the Performance Monitors registers are accessible from all modes executing at PL1 or higher. However, the access permissions for PMU registers can be modified by:

- setting the `PMUSERENR.EN` bit to 1, to permit access from software executing in User mode, for example for instrumentation and profiling purposes
- setting `HDCR.TPM` to 1, to disable access to all registers from Non-secure modes executing at PL1 or lower
- setting `HDCR.TPMCR` to 1, to disable access to `PMCR` from Non-secure modes executing at PL1 or lower.

The access permissions for the Performance Monitors registers divide the registers into four groups. Therefore, the following sections describe the access permissions for the Performance Monitors registers:

- [Access from Secure PL1 modes and Hyp mode](#)
- [Group 1 on page C12-2329](#)
- [Group 2 on page C12-2329](#)
- [Group 3 on page C12-2330](#)
- [Group 4 on page C12-2330](#)
- [Reserved registers on page C12-2331](#).

These sections use the following terms to describe the access permissions:

<b>Proceed</b>	The behavior on reads or writes further depends on what counter access is granted for each counter in the current mode and state.
<b>UNDEFINED</b>	Generates an Undefined Instruction exception that is taken locally.
<b>Hyp Trap</b>	Generates a Hyp Trap exception. This is reported in the <a href="#">HSR</a> as a Trapped MCR or MRC access to CP15, using EC value <code>0x03</code> .
<b>UNPREDICTABLE</b>	The behavior is UNPREDICTABLE.

In the access permissions tables:

<b>x</b>	Indicates that the control does not affect the permissions.
<b>-</b>	Indicates that the control is not applicable. In particular, in an implementation that does not include the Virtualization Extensions, the <a href="#">HDCR</a> controls are not applicable.

### Access from Secure PL1 modes and Hyp mode

The Performance Monitors registers are always accessible in Secure PL1 modes and, in an implementation that includes the Virtualization Extensions, from Hyp mode. This means:

#### In an implementation that does not include the Virtualization Extensions

Any access from a Secure PL1 mode **proceeds**, regardless of the value of `PMUSERENR.EN`.

#### In an implementation that includes the Virtualization Extensions

Any access from a Secure PL1 mode, or from Hyp mode, **proceeds**, regardless of the values of `PMUSERENR.EN` and `HDCR.{TPM, TPMCR}`.

### Group 1

Table C12-8 describes the access permissions for the following registers and accesses:

- [PMUSERENR](#), MCR only.

———— **Note** —————

See [Group 2](#) for the behavior of write accesses to the [PMUSERENR](#).

- [PMINTENSET](#), MRC and MCR
- [PMINTENCLR](#), MRC and MCR.

These register accesses are never permitted in PL0 modes. Accesses from Non-secure PL1 modes are trapped to the hypervisor when [HDCR.TPM](#) is set to 1.

**Table C12-8 Access permissions for Performance Monitors registers, group 1**

TPM	HDCR.		Secure User mode	Non-secure modes	
	TPMCR	PMUSERENR.EN		PL1	User
ARMv7 implementation with Virtualization Extensions					
0	x	x	UNDEFINED	Proceed	UNDEFINED
1	x	x	UNDEFINED	Hyp Trap	UNDEFINED
ARMv7 implementation without Virtualization Extensions					
-		x	UNDEFINED	Proceed	UNDEFINED

### Group 2

Table C12-9 describes the access permissions for the following register and access:

- [PMUSERENR](#), MRC only.

———— **Note** —————

See [Group 1](#) for the behavior of read accesses to the [PMUSERENR](#).

This register is normally readable in PL0 modes. Read accesses from Non-secure modes are trapped to the hypervisor when [HDCR.TPM](#) is set to 1.

**Table C12-9 Read access permissions for Performance Monitors registers, group 2**

TPM	HDCR.		Secure User mode	Non-secure modes	
	TPMCR	PMUSERENR.EN		PL1	User
ARMv7 implementation with Virtualization Extensions					
0	x	x	Proceed	Proceed	Proceed
1	x	x	Proceed	Hyp Trap	Hyp Trap
ARMv7 implementation without Virtualization Extensions					
-		x	Proceed	Proceed	Proceed

**Group 3**

Table C12-10 describes the access permissions for the following register and accesses:

- [PMCR](#), MRC and MCR.

This register is normally RW in PL0 modes only when PL0 mode access is enabled, otherwise reads of and writes to [PMCR](#) are locally UNDEFINED. Accesses to [PMCR](#) from Non-secure modes that are not locally UNDEFINED are trapped to the hypervisor when [HDCR.TPM](#) or [HDCR.TPMCR](#) is set to 1.

**Table C12-10 Access permissions for Performance Monitors registers, group 3**

<b>HDCR.</b>		<b>PMUSERENR.EN</b>	<b>Secure User mode</b>	<b>Non-secure modes</b>	
<b>TPM</b>	<b>TPMCR</b>			<b>PL1</b>	<b>User</b>
ARMv7 implementation with Virtualization Extensions					
0	0	0	UNDEFINED	Proceed	UNDEFINED
0	0	1	Proceed	Proceed	Proceed
x	1	0	UNDEFINED	Hyp Trap	UNDEFINED
1	x				
x	1	1	Proceed	Hyp Trap	Hyp Trap
1	x				
ARMv7 implementation without Virtualization Extensions					
	-	0	UNDEFINED	Proceed	UNDEFINED
	-	1	Proceed	Proceed	Proceed

**Group 4**

Table C12-11 on page C12-2331 describes the access permissions for the following registers in group 4:

- [PMCNTENSET](#), MRC and MCR
- [PMCNTENCLR](#), MRC and MCR
- [PMOVSr](#), MRC and MCR
- [PMSWINC](#), MCR only
- [PMSELR](#), MRC and MCR
- [PMCEID<sub>n</sub>](#), MRC only, PMUv2 only
- [PMCCNTR](#), MRC and MCR
- [PMXEVTYPER](#), MRC and MCR
- [PMXEVCNTR](#), MRC and MCR
- [PMOVSSET](#), MRC and MCR, for ARMv7 implementations that include the Virtualization Extensions.

**Note**

The following are reserved registers, see [Reserved registers on page C12-2331](#):

- in PMUv1, the [PMCEID0](#) and [PMCEID1](#) registers
- in an implementation that does not include the Virtualization Extensions, the [PMOVSSET](#) register.

These registers are normally accessible in PL0 modes when PL0 mode access is enabled, otherwise accesses are locally UNDEFINED. Accesses to these registers from Non-secure modes that are not locally UNDEFINED are trapped to the hypervisor when [HDCR.TPM](#) is set to 1.

**Table C12-11 Access permissions for Performance Monitors registers, group 4**

TPM	HDCR.		Secure User mode	Non-secure modes	
	TPMCR	PMUSERENR.EN		PL1	PL0
ARMv7 implementation with Virtualization Extensions					
0	x	0	UNDEFINED	Proceed	UNDEFINED
0	x	1	Proceed	Proceed	Proceed
1	x	0	UNDEFINED	Hyp Trap	UNDEFINED
1	x	1	Proceed	Hyp Trap	Hyp Trap
ARMv7 implementation without Virtualization Extensions					
-	-	0	UNDEFINED	Proceed	UNDEFINED
-	-	1	Proceed	Proceed	Proceed

### Reserved registers

The behavior of accesses to reserved registers in the Performance Monitors register space, including the behavior of read accesses to WO registers and write accesses to RO registers, is described in:

- [General behavior of system control registers on page B3-1446](#), for a VMSA implementation
- [General behavior of system control registers on page B5-1774](#), for a PMSA implementation.

This applies to the following accesses in both Secure and Non-secure state:

- all accesses to reserved register encodings
- MRC accesses to [PMSWINC](#)
- in PMUv2, MCR accesses to the [PMCEID<sub>n</sub>](#) registers.





# Part D

## **Appendixes**



# Appendix A

## Recommended External Debug Interface

This appendix describes the recommended external debug interface. It contains the following sections:

- *About the recommended external debug interface on page AppxA-2336*
- *Authentication signals on page AppxA-2338*
- *Run-control and cross-triggering signals on page AppxA-2340*
- *Recommended debug slave port on page AppxA-2344*
- *Other debug signals on page AppxA-2346.*

———— **Note** —————

This recommended external debug interface specification is not part of the ARM architecture specification. Implementers and users of the ARMv7 architecture must not consider this appendix as a requirement of the architecture. It is included as an appendix to this manual only:

- as reference material for users of ARM products that implement this interface
- as an example of how an external debug interface might be implemented.

The inclusion of this appendix is no indication of whether any ARM products might, or might not, implement this external debug interface. For details of the implemented external debug interface you must always see the appropriate product documentation.

---

## A.1 About the recommended external debug interface

See the Note on the first page of this appendix for information about the architectural status of this recommended debug interface.

The recommended debug interface includes a recommended debug slave port that provides both the memory-mapped interface and the external debug interface. [Table A-1](#) shows the signals in the recommended interface.

**Table A-1 Recommended debug interface signals**

Name	Direction	Versions <sup>a</sup>	Description	Section
DBGEN	In	All	Debug Enable	<a href="#">Authentication signals on page AppxA-2338</a>
NIDEN	In	All	Non-Invasive Debug Enable	
SPIDEN	In	v6.1, v7, v7.1	Secure PL1 Invasive Debug Enable	
SPNIDEN	In	v6.1, v7, v7.1	Secure PL1 Non-Invasive Debug Enable	
DBGRESTART	In	v7, v7.1	External restart request	<a href="#">Run-control and cross-triggering signals on page AppxA-2340</a>
DBGRESTARTED	Out	v7, v7.1	Handshake for <b>DBGRESTART</b>	
DBGTRIGGER	Out	v7, v7.1	Debug Acknowledge	
EDBGRQ	In	All	External debug request	
DBGACK	Out	All	Debug Acknowledge	<a href="#">Other debug signals on page AppxA-2346</a>
DBGCPUDONE	Out	v7, v7.1	Debug Acknowledge	
COMMRX	Out	All	<a href="#">DBGDTRRX</a> full	
COMMTX	Out	All	<a href="#">DBGDTRTX</a> empty	
DBGOSLOCKINIT	In	v7 only	Initialize OS Lock on reset	
DBGNOPWRDWN	Out	All	No powerdown request	
DBGPWRUPREQ	Out	v7.1 only	Powerup request	
DBGRSTREQ	Out	v7, v7.1	Warm reset request	
DBGPWRDUP	In	v7, v7.1	Processor powered up	
DBGBUSCANCELREQ	Out	v7, v7.1	Request to cancel bus requests	
DBGROMADDR[N:12] <sup>b</sup>	In	v7, v7.1	ROM Table physical address	
DBGROMADDRV	In	v7, v7.1	ROM Table physical address valid	
DBGSELFADDR[N:12] <sup>b</sup>	In	v7, v7.1	Debug self-address offset	
DBGSELFADDRV	In	v7, v7.1	Debug self-address offset valid	
DBGSWENABLE	In	v7, v7.1	Debug software access enable	
PRESETDBGn	In	v7, v7.1	Debug logic reset	

**Table A-1 Recommended debug interface signals (continued)**

Name	Direction	Versions <sup>a</sup>	Description	Section
PSELDBG	In	v7, v7.1	Selects the external debug interface	<i>Recommended debug slave port on page AppxA-2344</i>
PRDATADBG[31:0]	Out	v7, v7.1	Read data	
PWDATADBG[31:0]	In	v7, v7.1	Write data	
PENABLEDBG	In	v7, v7.1	Indicates a second or subsequent cycle of a transfer	
PREADYDBG	Out	v7, v7.1	Extends a transfer, by inserting wait states	
PWRITEDBG	In	v7, v7.1	LOW for a read, HIGH for a write	
PCLKDBG	In	v7, v7.1	Clock	
PCLKENDBG	In	v7, v7.1	Clock enable for PCLKDBG	
PADDRDBG[31, 11:2]	In	v7, v7.1	Slave port, address	
PSLVERRDBG	Out	v7, v7.1	Slave port, slave-generated error response	

- a. Indicates the debug versions in which the signal can be implemented. The signal descriptions indicate whether the signal is required.
- b. In an implementation that includes the Large Physical Address Extensions, N is 39, otherwise it is 31.

Figure A-1 shows the recommended debug interface.

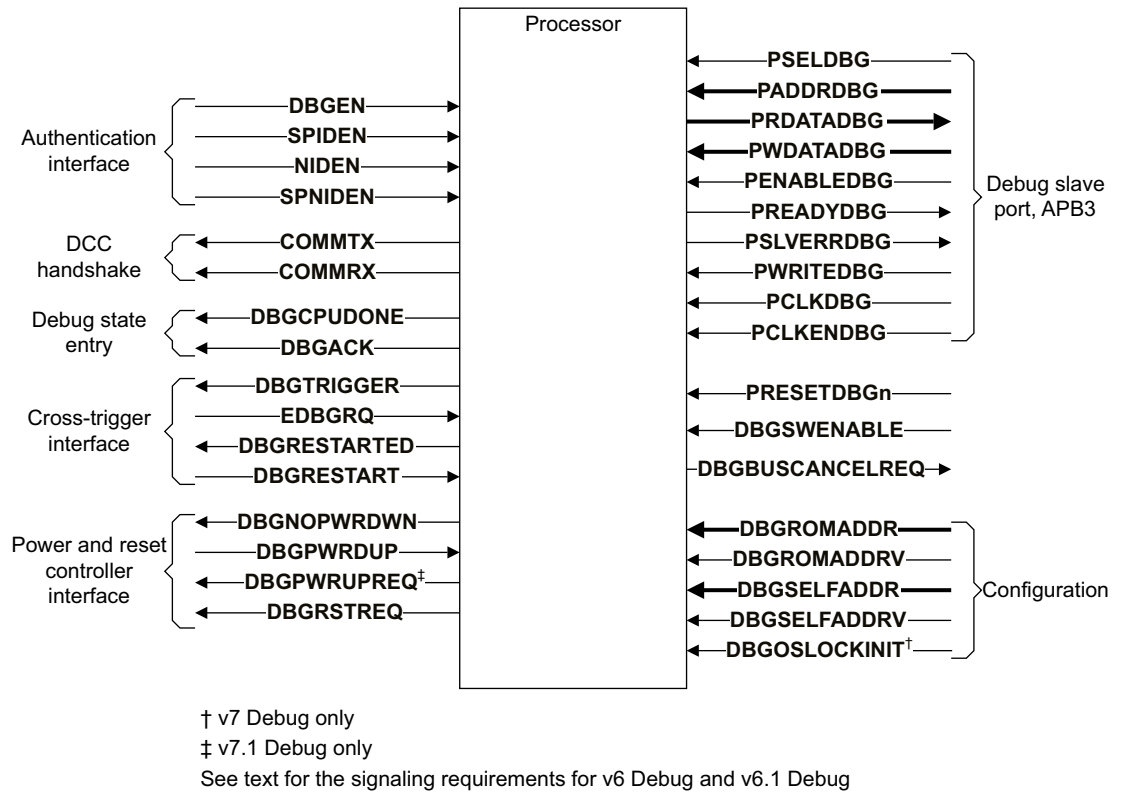

**Figure A-1 Recommended external debug interface, including APB3 slave port**

In Figure A-1, signals with a lower-case n suffix are active LOW and all other signals are active HIGH.

## A.2 Authentication signals

**DBGEN**, **NIDEN**, **SPIDEN** and **SPNIDEN** are the authentication signals.

**NIDEN** and **SPNIDEN** can be omitted if no non-invasive debug features are implemented.

**SPIDEN** and **SPNIDEN** can be omitted if the implementation does not include the Security Extensions.

When **DBGEN** is LOW, indicating that debug is disabled:

- Halting debug events are ignored
- Except for ignoring Halting debug events, the processor behaves as if **DBGDSCR**[15:14] == 0b00, meaning that Monitor debug-mode and Halting debug-mode are both disabled.

For details of how these signals control enabling of invasive and non-invasive debug see [Chapter C2 Invasive Debug Authentication](#) and [Chapter C9 Non-invasive Debug Authentication](#).

---

### Note

The v7 Debug and v7.1 Debug architecture authentication signal interface described here is compatible with the CoreSight architecture requirements for the authentication interface of a debug component. However the CoreSight architecture places additional requirements on other components in the system. For more information, see the *CoreSight Architecture Specification*.

---

**SPIDEN** also controls permissions in Debug state. For details see [About invasive debug authentication on page C2-2028](#).

See also [DBGAUTHSTATUS, Authentication Status register on page C11-2209](#).

### A.2.1 Changing the authentication signals

In v6.1 Debug, v7 Debug, and v7.1 Debug the **NIDEN**, **DBGEN**, **SPIDEN**, and **SPNIDEN** authentication signals can be controlled dynamically, meaning that they might change while the processor is running, or while the processor is in Debug state.

---

### Note

In v6 Debug **DBGEN** is a static signal and can be changed only while the processor is in reset.

---

Normally, these signals are driven by the system, meaning that they are driven by a peripheral connected to the ARM processor. If the software running on the ARM processor has to change any of these signals it must follow this procedure:

1. Execute an implementation-specific sequence of instructions to change the signal value. For example, this might be an instruction to write a value to a control register in a system peripheral.
2. If step 1 involves any memory operation, perform a Data Synchronization Barrier (DSB).
3. Poll the debug registers to check the signal values seen by the processor. This is required because the processor might not see the signal change until several cycles after the DSB completes.
4. Perform a context synchronization operation.

The software cannot perform debug or analysis operations that rely on the new value until this procedure has been completed. The same rules apply for instructions executed through the **DBGITR** while in Debug state. The processor view of the authentication signals can be polled through **DBGDSCR**[17:16] and the **DBGAUTHSTATUS** register.

---

**Note**

- See *Context synchronization operation* for the definition of this term.
  - Exceptionally, the processor might be in Debug state even though the mode, security state and authentication signal settings are such that, in Non-debug state, debug events would be ignored. *Being in Debug state when invasive halting debug is disabled or not permitted on page C5-2099* describes how this can occur.
-

## A.3 Run-control and cross-triggering signals

ARM recommends implementation of the run-control and cross-triggering signals **EDBGRQ**, **DBGTRIGGER**, **DBGRESTART**, and **DBGRESTARTED**. These signals are particularly useful in a multiprocessor system, because using them:

- A debugger can signal a group of processors to enter Debug state.
- A debugger can signal a group of processors to exit Debug state.
- A system component can signal a group of processors to enter Debug state when any one of them enters Debug state because of a debug event on that processor. This is called *cross-triggering*.

If you implement the recommended signaling in your system hardware, this signaling means all of the processors in the group enter or exit Debug state nearly simultaneously.

These signals can also be used in a uniprocessor implementation. For example, debug events not defined by the Debug architecture might be generated externally to the processor. When one of these events occurs the external system can use these signals to cause the processor to enter Debug state. A trace macrocell might use these signals in this way.

Contact ARM for details of a recommended *Embedded Cross Trigger* (ECT) peripheral that you can use in a multiprocessor system to implement this signaling.

The following subsections describe each of the recommended signals:

- [EDBGRQ](#)
- [DBGTRIGGER](#)
- [DBGRESTART and DBGRESTARTED on page AppxA-2341](#)
- [DBGACK and DBGCPUDONE on page AppxA-2342](#).

### A.3.1 EDBGRQ

**EDBGRQ** is the recommended implementation of the External debug request mechanism, see [Halting debug events on page C3-2073](#).

**EDBGRQ** is active-HIGH.

Once **EDBGRQ** is asserted it must be held HIGH until it is acknowledged:

- An implementation can use either **DBGACK** or **DBGTRIGGER** to acknowledge **EDBGRQ**, see:
  - [DBGACK and DBGCPUDONE on page AppxA-2342](#)
  - [DBGTRIGGER](#).
- Alternatively, debugger software might use an IMPLEMENTATION DEFINED method to acknowledge **EDBGRQ**. For example, once the processor has entered Debug state the debugger might reprogram the peripheral that is driving **EDBGRQ**.

### A.3.2 DBGTRIGGER

The processor asserts **DBGTRIGGER** to indicate that it is committed to entering Debug state. Therefore, the system can use **DBGTRIGGER** to acknowledge **EDBGRQ**. See [Chapter C5 Debug State](#) for the definition of Debug state.

**DBGTRIGGER** is active-HIGH.

The processor must assert **DBGTRIGGER** as early as possible, so that the system can use its rising edge to signal to other devices that the processor is entering Debug state. **DBGTRIGGER** can be used for cross-triggering. For example, in a multiprocessor system, when one processor halts, the **DBGTRIGGER** signal from that processor can generate an External debug request for the other processors.

See [DBGACK and DBGCPUDONE on page AppxA-2342](#) for details of the recommended External debug request handshaking between **EDBGRQ** and **DBGTRIGGER**.



In addition, the processor asserts **DBGTRIGGER** whenever the **DBGDSCR.DBGack** bit is set to 1, see [DBGDSCR, Debug Status and Control Register on page C11-2241](#).

If the **DBGDSCR.DBGack** bit is 0, the processor deasserts **DBGTRIGGER** on exit from Debug state.

———— **Note** —————

Setting **DBGDSCR.DBGack** to 1 takes no account of the **DBGGEN** and **SPIDEN** signals. Setting **DBGDSCR.DBGack** to 1 asserts **DBGTRIGGER** regardless of the security settings.

A v7 Debug or v7.1 Debug implementation of these recommendations might not implement **DBGTRIGGER** if it would have identical behavior to **DBGACK**.

Before v7 Debug, **DBGTRIGGER** is not part of the recommended external debug interface.

### A.3.3 DBGRESTART and DBGRESTARTED

**DBGRESTART** is the recommended implementation of the External Restart request, see [Exiting Debug state on page C5-2110](#). **DBGRESTARTED** is a handshake signal for **DBGRESTART**.

**DBGRESTART** and **DBGRESTARTED** are active-HIGH.

Once **DBGRESTART** is asserted, it must be held HIGH until **DBGRESTARTED** is deasserted. The processor ignores **DBGRESTART** if it is not in Debug state.

To avoid possible race conditions, restart must be a multi-phase process. [Example A-1](#) show how this might be achieved.

———— **Note** —————

[Example A-1](#) only represents how a restart handshake might be achieved. It does not show the restart process of a particular implementation of the ARM architecture. Contact ARM if you need more information about a particular restart handshake.

#### Example A-1 Possible multi-phase restart handshake

The diagram shows a four-phase handshake between **DBGRESTART** and **DBGRESTARTED**. It is diagrammatic only, and does not imply any timings.

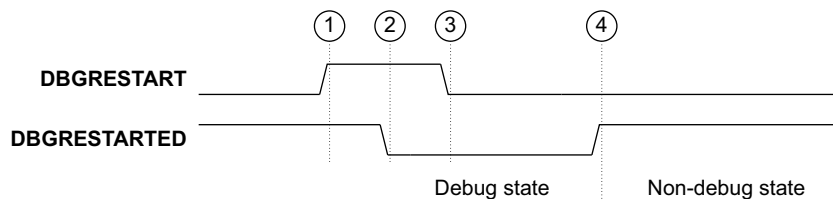

The numbers in the diagram have the following meanings:

1. If **DBGRESTARTED** is asserted HIGH the peripheral asserts **DBGRESTART** HIGH and waits for **DBGRESTARTED** to go LOW
2. The processor drives **DBGRESTARTED** LOW to deassert the signal and waits for **DBGRESTART** to go LOW
3. The peripheral drives **DBGRESTART** LOW to deassert the signal. This event indicates to the processor that it can start the transition from Debug state to Non-debug state.
4. The processor exits Debug state and asserts **DBGRESTARTED** HIGH.

In the process of exiting Debug state the processor normally deasserts the **DBGACK**, **DBGTRIGGER**, and **DBGCPUDONE** signals. It is IMPLEMENTATION DEFINED when this change occurs relative to the changes in **DBGRESTART** and **DBGRESTARTED**.

### A.3.4 DBGACK and DBGCPUDONE

**DBGACK** and **DBGCPUDONE** are active-HIGH.

The processor asserts **DBGACK** to indicate that it is in Debug state. Therefore, the system can use **DBGACK** as a handshake for **EDBGRQ**, instead of using **DBGTRIGGER**.

In v6 Debug and v6.1 Debug, the system can use **DBGACK** for cross-triggering.

The processor asserts **DBGCPUDONE** only after it has completed all Non-debug state memory accesses. Therefore the system can use **DBGCPUDONE** as an indicator that all memory accesses issued by the processor result from operations performed by a debugger.

Figure A-2 shows the signaling sequence for entry to Debug state. It is diagrammatic only, and does not imply any timings.

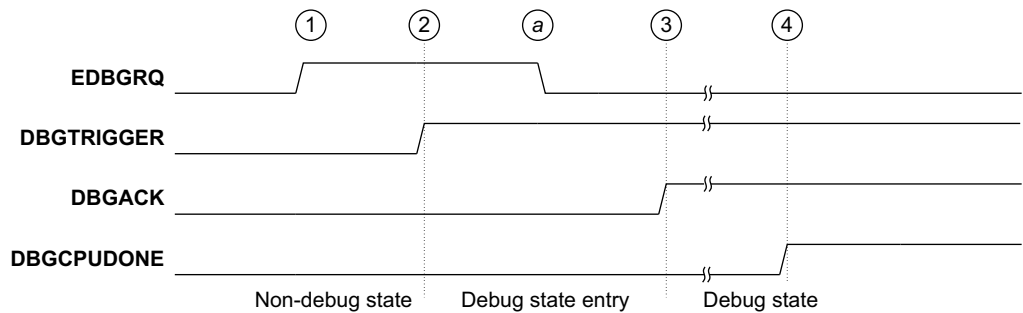

See the text for more information about the ordering of transition a.

**Figure A-2 Signaling for Debug state entry on an External debug request**

In Figure A-2 these events must occur in order:

1. The peripheral asserts **EDBGRQ** and waits for it to be acknowledged.
2. The processor takes the debug event and starts the Debug state entry sequence. The processor asserts **DBGTRIGGER**.
3. The processor completes the Debug state entry sequence and asserts **DBGACK**.
4. The processor completes all Non-debug state memory accesses and asserts **DBGCPUDONE**. It might do this only after intervention by an external debugger, see *Asynchronous aborts and Debug state entry on page C5-2094*.

Event a, the peripheral deasserting **EDBGRQ**, can occur at any time after the assertion of **EDBGRQ** is acknowledged, and generation of this event might require intervention by the external debugger. In the example shown in Figure A-2, the system is using **DBGTRIGGER** to acknowledge **EDBGRQ**, and therefore event a is not ordered relative to events 3 and 4.

In addition, the processor asserts **DBGCPUDONE** and **DBGACK** when the **DBGDSCR.DBGack** bit is set to 1.

If the **DBGDSCR.DBGack** bit is 0, the processor deasserts **DBGCPUDONE** and **DBGACK** on exit from Debug state.

———— **Note** —————

Setting **DBGDSCR.DBGack** to 1 takes no account of the **DBGGEN** and **SPIDEN** signals. Setting **DBGDSCR.DBGack** to 1 asserts **DBGCPUDONE** and **DBGACK** regardless of the security settings.

A v7 Debug or v7.1 Debug implementation of these recommendations might not implement **DBGCPUDONE** if it would have identical behavior to **DBGACK**.

Before v7 Debug, **DBGCPUDONE** was not part of the recommended external debug interface.

## A.4 Recommended debug slave port

This slave port is not required in v6 Debug and v6.1 Debug.

The memory-mapped interface is optional on v7 Debug and v7.1 Debug. This section describes the recommended AMBA® *Advanced Peripheral Bus* (APB3) slave port. It provides both the memory-mapped and external debug interfaces.

A valid external debug interface for v7 Debug or v7.1 Debug is any access mechanism that enables the external debugger to complete reads or writes to the memory-mapped registers described in *The memory-mapped and recommended external debug interfaces* on page C6-2126.

In v7 Debug or v7.1 Debug, a memory-mapped interface can be implemented to provide access to the debug registers using load and store operations. Such an interface is sufficient for the requirements of the external debug interface, and therefore it is possible to implement both the memory-mapped and external debug interfaces using a single memory slave port on the processor.

This section describes the v7 Debug and v7.1 Debug recommendations for an APB3 memory slave port implemented as part of the external debug interface. In addition, ARM recommends a Debug Access Port capable of mastering an APB3 bus and compatible with the *ARM Debug Interface v5* (ADIv5). [Figure A-1 on page AppxA-2337](#) shows the recommendations.

ARM recommends that the debug registers are accessible through an APB3 external debug interface. This APB3 interface:

- is 32 bits wide
- supports only 32-bit reads and writes
- has accesses that can be stalled
- has slave-generated aborts
- has 10 address bits ([11:2]) mapping 4KB of memory.

The recommended Debug Access Port treats this APB3 interface as Strongly-ordered memory.

See [Table A-1 on page AppxA-2336](#) for a description of the signals **PSELDBG**, **PRDATADBГ[31:0]**, **PWDATADBГ[31:0]**, **PENABLEDBG**, **PREADYDBG**, **PWRITEDBG**, **PCLKDBG**, and **PCLKENDBG**.

The following subsections describe the other debug slave port signals:

- [PADDRDBG](#)
- [PSLVERRDBG on page AppxA-2345](#).

### A.4.1 PADDRDBG

**PADDRDBG** selects the register to read or write.

The recommended debug slave port implements both the external debug interface and the memory-mapped interface. In this implementation, the interface must be able to distinguish an external debug interface access from a memory-mapped interface access. The recommended slave port uses APB3, and aliases the complete register set twice:

- the first view, the memory-mapped interface view, starts at 0x0
- the second view, the external debug interface view, starts at 0x80000000.

This means that the additional signal bit **PADDRDBG[31]** informs the debug slave port of the source of an access:

**PADDRDBG[31] == 0** Access from system

**PADDRDBG[31] == 1** Access from external debugger.

#### ———— Note —————

The only bits of **PADDRDBG** that are specified are **PADDRDBG[31, 11:2]**. Bits[1:0] are not required because all registers are word-sized, and bit[31] is used as described to indicate the source of the access. Because some HDL languages do not permit partial buses to be specified in this way an actual implementation might use a different name for **PADDRDBG[31]**, such as **PADDRDBG31**.

## A.4.2 PSLVERRDBG

**PSLVERRDBG** signals an aborted access.

**PSLVERRDBG** has the same timing as the ready response, **PREADYDBG**. Under the v7 Debug and v7.1 Debug model, accesses are only aborted, by asserting **PSLVERRDBG HIGH**, in a situation related to powerdown. These include the OS lock mechanism, and in v7.1 Debug, the OS Double Lock. For more information see [Access permissions on page C6-2117](#).

## A.5 Other debug signals

This section describes:

- the DCC handshake signals, see [COMMRX and COMMTX](#)
- **DBGNOPWRDWN**, **DBGPWRDUP**, **DBGPWRUPREQ**, and **DBGRSTREQ**, see [The power and reset controller interface signals](#)
- the configuration signals **DBGOSLOCKINIT**, **DBGROMADDR**, **DBGROMADDRV**, **DBGSELFADDR**, and **DBGSELFADDRV**, see [The configuration signals on page AppxA-2347](#)
- the debug software enable signal, see [DBGSWENABLE on page AppxA-2349](#)
- the debug reset signal, see [PRESETDBGn on page AppxA-2349](#)
- the request cancellation of bus requests signal, see [DBGBUSCANCELREQ on page AppxA-2349](#).

### A.5.1 COMMRX and COMMTX

**COMMRX** and **COMMTX** reflect the state of **DBGDSCR**[30:29] through the external debug interface:

- **COMMTX** is the inverse of **DBGDSCR**[29], TXfull. The processor is ready to transmit.
- **COMMRX** is equivalent to **DBGDSCR**[30], RXfull.

See [DBGDSCR, Debug Status and Control Register on page C11-2241](#) for descriptions of the TXfull and RXfull bits.

These signals are active HIGH indicators of when the *Debug Communications Channel* (DCC) requires processing by the target system. They permit interrupt-driven communications over the DCC. By connecting these signals to an interrupt controller, software using the DCC can be interrupted whenever there is new data on the channel or when the channel is clear for transmission.

#### ———— Note —————

There can be race conditions between reading the DCC bits through a read of **DBGDSCR**ext and a read of the **DBGDTRX**int Register or a write to the **DBGDTRRX**int Register through the Baseline CP14 interface. However the timing of these signals with respect to the DCC registers must be such that target software executing off an interrupt triggered by either of these signals must be able to write to **DBGDTRX**int and read **DBGDTRRX**int without race conditions.

### A.5.2 The power and reset controller interface signals

The following subsections describe the power controller interface signals:

- [DBGNOPWRDWN](#)
- [DBGPWRDUP on page AppxA-2347](#)
- [DBGPWRUPREQ on page AppxA-2347](#)
- [DBGRSTREQ on page AppxA-2347](#).

#### **DBGNOPWRDWN**

**DBGNOPWRDWN** is equivalent to the value of **DBGPRCR**.CORENPDRQ. See the bit description for the implementation requirements for this bit in different Debug architecture versions. When the CORENPDRQ bit is implemented so that it can be set to 1 to request that, on a powerdown request, the system emulates powerdown, then ARM strongly recommends that the **DBGNOPWRDWN** signal is implemented in the external debug interface.

The processor power controller must work in emulate mode when this signal is HIGH.

## DBGPWRDUP

**DBGPWRDUP** is not required in:

- v6 Debug and v6.1 Debug
- a SinglePower system, that is, it is not required in a design that has only one power domain.

The **DBGPWRDUP** input signal is HIGH when the processor is powered up, and LOW otherwise. The **DBGPWRDUP** signal determines the value of **DBGPRSR.PU**.

See also *Permissions in relation to powerdown* on page C6-2119.

## DBGPWRUPREQ

**DBGPWRUPREQ** is not supported in v6 Debug, v6.1 Debug, and v7 Debug.

In v7.1 Debug, **DBGPWRUPREQ** is an optional signal that is equivalent to the value of **DBGPRCR.COREPURQ**. When this signal is HIGH, it signals a request to the power controller to powerup the core power domain.

## DBGRSTREQ

**DBGRSTREQ** is not supported in v6 Debug and v6.1 Debug.

In v7 Debug and v7.1 Debug, **DBGRSTREQ** is an optional signal that is equivalent to the value of **DBGPRCR.CWRR**. When this signal is HIGH, it signals a request to the reset controller to perform a warm reset of the processor.

### A.5.3 The configuration signals

The following subsections describe the configuration signals:

- *DBGOSLOCKINIT*
- *DBGROMADDR and DBGROMADDRV* on page AppxA-2348
- *DBGSELFADDR and DBGSELFADDRV* on page AppxA-2348.

#### DBGOSLOCKINIT

**DBGOSLOCKINIT** is not required in:

- v6 Debug and v6.1 Debug
- v7.1 Debug.

In v7 Debug, **DBGOSLOCKINIT** is a configuration signal that determines the state of the OS Lock immediately after a debug logic reset. On a debug logic reset:

- if **DBGOSLOCKINIT** is HIGH then the OS Lock is set from the reset
- if **DBGOSLOCKINIT** is LOW then the OS Lock is clear from the reset.

Normally, **DBGOSLOCKINIT** is tied off LOW.

For a description of debug logic reset see *Reset and debug* on page C7-2160. For details of the OS Lock see *OS Save and Restore registers* on page C11-2201.

See also *Permissions in relation to locks* on page C6-2118.

## DBGROMADDR and DBGROMADDRV

**DBGROMADDR** and **DBGROMADDRV** are not required in v6 Debug and v6.1 Debug. They are required in v7 Debug and v7.1 Debug if the memory-mapped interface is implemented.

**DBGROMADDR** specifies the most significant bits of the ROM Table table physical address:

- in an implementation that includes the Large Physical Address Extension, it specifies address bits[39:12]
- otherwise, it specifies address bits[31:12].

This is a configuration input, that provides the **DBGDRAR.ROMADDR** field value. It must be either:

- be a tie-off
- change only while the processor is in reset.

In a system with multiple ROM Tables, this address must be tied off to the top-level ROM Table address.

In a system with no ROM Table this address must be tied off with the physical address where the debug registers are memory-mapped. Debug software can use the debug component identification registers at the end of the 4KB block addressed by **DBGROMADDR** to distinguish a ROM table from a processor.

### ———— Note ————

If the system implements more than one debug component, for example a processor and a trace macrocell, a ROM Table must be provided.

**DBGROMADDRV** is the valid signal for **DBGROMADDR**. If the address cannot be determined, **DBGROMADDR** must be tied off to zero and **DBGROMADDRV** tied LOW.

The format of ROM Tables is defined in the *ARM Debug Interface v5 Architecture Specification*.

ARM recommends that the ROM table, addressed by **DBGROMADDR**, and the Self Address specified by **DBGSELFADDR** and described in *DBGSELFADDR and DBGSELFADDRV*, are:

- in a VMSA implementation, implemented in the bottom 4GB of physical memory, so they can be accessed when the MMUs are disabled
- implemented in the same 2GB half of the 4GB memory region.

## DBGSELFADDR and DBGSELFADDRV

**DBGSELFADDR** and **DBGSELFADDRV** are not required in v6 Debug and v6.1 Debug.

In v7 Debug and v7.1 Debug, **DBGSELFADDR** and **DBGSELFADDRV** are required if the memory-mapped interface is implemented. If **DBGROMADDR** and **DBGROMADDRV** are not implemented, **DBGSELFADDR** and **DBGSELFADDRV** must not be implemented.

**DBGSELFADDR** specifies the most significant bits of the two's complement signed offset from the ROM Table physical address to the physical address where the debug registers are Memory-mapped:

- in an implementation that includes the Large Physical Address Extension, it specifies address bits[39:12]
- otherwise, it specifies address bits[31:12].

This is a configuration input, that provides the **DBGDSAR.SELFOFFSET** field value. It must either:

- be a tie-off
- change only while the processor is in reset.

If there is no ROM Table, **DBGROMADDR** must be configured as described in the section *DBGROMADDR and DBGROMADDRV*, and **DBGSELFADDR** must be tied off to zero with **DBGSELFADDRV** tied HIGH.

**DBGSELFADDRV** is the valid signal for **DBGSELFADDR**. If the offset cannot be determined, **DBGSELFADDR** must be tied off to zero and **DBGSELFADDRV** tied LOW.



#### A.5.4 DBGSWENABLE

**DBGSWENABLE** is not required in v6 Debug and v6.1 Debug.

In v7 Debug and v7.1 Debug, **DBGSWENABLE** is driven by the Debug Access Port. For details see the *ARM Debug Interface v5 Architecture Specification*.

**DBGSWENABLE** is an active-HIGH signal that must be asserted to enable system access to the debug register file. That is, if deasserted it prevents access through the memory-mapped interface and, for most registers, through the CP14 interface. This gives the debugger full control over the debug registers in the processor.

When this signal is deasserted by the debugger by a means that is IMPLEMENTATION DEFINED, memory-mapped interface accesses return an error response and most CP14 operations become UNDEFINED. However, the architecture permits implementations in which software can continue to use Save and Restore debug registers over a powerdown. For more information, see:

- [Summary of the v7 Debug register interfaces on page C6-2128](#)
- [Summary of the v7.1 Debug register interfaces on page C6-2137](#)
- [The OS Save and Restore mechanism on page C7-2152](#).

———— **Note** —————

In v7 Debug, if **DBGOSLSR**, **DBGOSLAR**, and **DBGOSSRR** are not visible in the CP14 interface, then save and restore when **DBGSWENABLE** is LOW is not possible.

In the ARM Debug Interface v5, **DBGSWENABLE** is asserted by setting the DbgSwEnable control bit in the access port *Control Status Word Register* (CSW) to 1. For the memory-mapped interface, when the DbgSwEnable control bit is set to 0 the generation of slave-generated errors is a function of the ADIV5 Debug Access Port, and therefore the processor ignores the **DBGSWENABLE** signal for the memory-mapped interface. For details see the *ARM Debug Interface v5 Architecture Specification*.

The **DBGSWENABLE** signal has no effect on accesses through the external debug interface.

Normally, the **DBGSWENABLE** signal must be asserted at debug logic reset and deasserted under debugger control.

#### A.5.5 PRESETDBGn

**PRESETDBGn** is not required in v6 Debug and v6.1 Debug. The debug logic is only reset on system powerup reset.

The reset signal resets all debug registers. See also [Reset and debug on page C7-2160](#).

———— **Note** —————

Do not use the **PRESETDBGn** signal to reset the debug registers if the debug system is connected to a debug monitor that uses the CP14 debug interface.

#### A.5.6 DBGBUSCANCELREQ

**DBGBUSCANCELREQ** is not supported in v6 Debug and v6.1 Debug.

In v7 Debug and v7.1 Debug, **DBGBUSCANCELREQ** is an optional signal that is equivalent to the value of **DBGDRCR.CBRRQ**. When this signal is HIGH, it signals a request to cancel any outstanding bus requests.



## Appendix B

# Recommended Memory-mapped and External Debug Interfaces for the Performance Monitors

This appendix describes the recommended memory-mapped and external debug interfaces to the Performance Monitors. It contains the following sections:

- *About the memory-mapped views of the Performance Monitors registers on page AppxB-2352*
- *PMU register descriptions for memory-mapped register views on page AppxB-2361.*

## B.1 About the memory-mapped views of the Performance Monitors registers

An implementation can provide:

- A memory-mapped interface to the Performance Monitors registers. Software running on any processor in a system can use this interface to access counters in the Performance Monitors.
- Access to the Performance Monitors registers through an external debug interface. A debugger can use this interface to access counters in the Performance Monitors.

ARM recommends that any external debug interface is implemented as defined in the *ARM Debug Interface v5 Architecture Specification*.

An external debug interface provides a memory-mapped view of the Performance Monitors registers.

The following sections describe the memory-mapped views of the Performance Monitors registers. That is, they describe accessing the registers through either a memory-mapped interface or an external debug interface.

- [Differences in the memory-mapped views of the Performance Monitors registers](#)
- [Behavior of simultaneous accesses through CP15 and memory-mapped views on page AppxB-2353](#)
- [Performance Monitors memory-mapped register views on page AppxB-2353](#)
- [Access permissions for memory-mapped views of the Performance Monitors on page AppxB-2356](#).

In this appendix, unless the context explicitly indicates otherwise, any reference to a *memory-mapped view* applies equally to a register view using:

- an external debug interface
- a memory-mapped interface.

### B.1.1 Differences in the memory-mapped views of the Performance Monitors registers

A memory-mapped view of the Performance Monitors registers accesses the same registers as the CP15 interface described in [Performance Monitors registers on page C12-2326](#), except that:

1. The **PMSELR** is accessible only in the CP15 interface.
2. The **PMCFGR**, **PMLAR**, **PMLSR**, **PMAUTHSTATUS**, **PMDEVTYPE**, **PMPID0-PMPID4**, and **PMCID0-PMCID3** registers are accessible only in memory-mapped views. [PMU register descriptions for memory-mapped register views on page AppxB-2361](#) describes these registers.
3. The CP15 interface provides access to a single **PMXVCNTR** and a single **PMXEVTYPEPER**. **PMSELR.SEL** selects which {**PMXVCNTR**<sub>x</sub>, **PMXEVTYPEPER**<sub>x</sub>} register pair is accessible. In a memory-mapped view, each of the **PMXVCNTR**<sub>x</sub> and **PMXEVTYPEPER**<sub>x</sub> registers is visible at a different offset in the interface.
4. In the CP15 interface, the **PMXEVTYPEPER** that corresponds to the **PMCCNTR** is accessible only by setting **PMSELR.SEL** to 31. In a memory-mapped view, this register is always visible, as **PMXEVTYPEPER**<sub>31</sub> at offset 0x47C.
5. For Performance Monitors registers that are accessible in both the CP15 interface and a memory-mapped view, the register descriptions in [Chapter B4 System Control Registers in a VMSA implementation](#) and [Chapter B6 System Control Registers in a PMSA implementation](#) apply, except that:
  - Any reference to controls in **PMSELR** does not apply to the memory-mapped views. See items 1, 3, and 4 in this list.
  - Any reference to the modes in which the register can be accessed does not apply to accesses using a memory-mapped view. This includes:
    - the information in [Access permissions on page C12-2328](#) and [Counter access on page C12-2312](#)
    - the **PMUSERENR.EN** control on accesses from User mode
    - in an implementation that includes the Virtualization Extensions, the **HDCCR.HPMN** control. See, instead, [Access permissions for memory-mapped views of the Performance Monitors on page AppxB-2356](#).

- The information in the *Accessing the register* subsection of the register description does not apply to accesses using a memory-mapped view. For example, the subsection *Accessing the PMCCNTR* on page B4-1669 does not apply to PMCCNTR accesses using a memory-mapped view.
- Accesses to PMCCNTR, PMXEVCNTR<sub>x</sub>, or PMXEVTYPEx read or update the appropriate register, and have no dependence on the value of PMSELR.SEL.

———— **Note** —————

In this section, links to Performance Registers that can be accessed in the CP15 interface, for example PMCCNTR, link to their description in Chapter B4 *System Control Registers in a VMSA implementation*.

### B.1.2 Behavior of simultaneous accesses through CP15 and memory-mapped views

If a Performance Monitors register is visible in both the CP15 interface and a memory-mapped view, and is accessed simultaneously through those two mechanisms, behavior is UNPREDICTABLE. In this context, *simultaneously* means that the register is accessed by one mechanism before all side-effects of an access through the other mechanism are visible.

### B.1.3 Performance Monitors memory-mapped register views

Table B-1 shows the memory-mapped view of the Performance Monitors registers.

———— **Note** —————

- Implementers must ensure that the 4KB region containing the PMU registers immediately follows, in physical memory, the 4KB region containing the debug registers.
- In an implementation that includes the Virtualization Extensions, counters that are reserved because HDCR.HPMN has been changed from its reset value remain visible in any memory-mapped view.
- The registers that relate to an implemented event counter, PMN<sub>x</sub>, are PMXEVCNTR<sub>x</sub> and PMXEVTYPEx.

**Table B-1 Performance Monitors memory-mapped register views**

Offset	Type	Name, VMSA	Name, PMSA	Description
0x0nn	RW	PMXEVCNTR <sub>x</sub> <sup>a</sup>	PMXEVCNTR <sub>x</sub> <sup>a</sup>	Performance Monitors Event Count Register. <i>nn</i> is 4 times the event counter number, <i>x</i> .  ———— <b>Note</b> ————— For memory-mapped or debug interface accesses, the value of the CP15 register PMSELR has no effect on the selection of a Performance Monitors Event Count Register.
0x0nn-0x078	-	-	-	Reserved. <i>nn</i> is 4 times the number of implemented event counters, that is, <i>nn</i> = 4×PMCR.N.
0x07C	RW	PMCCNTR <sup>a</sup>	PMCCNTR <sup>a</sup>	Performance Monitors Cycle Count Register.
0x080-0x3FC	-	-	-	Reserved.

**Table B-1 Performance Monitors memory-mapped register views (continued)**

Offset	Type	Name, VMSA	Name, PMSA	Description
0x4nn	RW	PMXEVTYPERS <sub>x</sub> <sup>a</sup>	PMXEVTYPERS <sub>x</sub> <sup>a</sup>	Performance Monitors Event Type Select Register. nn is 4 times the event counter number, x.  ———— <b>Note</b> ———— For memory-mapped or debug interface accesses, the value of the CP15 register PMSELR has no effect on the selection of an Event Type Select Register.
0x4nn-0x478	-	-	-	Reserved. nn is 4 times the number of implemented event counters, that is, nn = 4×PMCR.N.
0x47C	RW	PMXEVTYPERS <sub>31</sub> <sup>a</sup>	PMXEVTYPERS <sub>31</sub> <sup>a</sup>	Performance Monitors Event Type Select Register for the cycle counter, PMCCNTR (VMSA) or PMCCNTR (PMSA).  ———— <b>Note</b> ———— For memory-mapped or debug interface accesses, the value of the CP15 register PMSELR has no effect on the selection of an Event Type Select Register.
0x480-0x9FC	-	-	-	Reserved.
0xA00-0xBFC	-	-	-	IMPLEMENTATION DEFINED.
0xC00	RW	PMCNTENSET <sup>a</sup>	PMCNTENSET <sup>a</sup>	Performance Monitors Count Enable Set register.
0xC04-0xC1C	-	-	-	Reserved.
0xC20	RW	PMCNTENCLR <sup>a</sup>	PMCNTENCLR <sup>a</sup>	Performance Monitors Count Enable Clear register.
0xC24-0xC3C	-	-	-	Reserved.
0xC40	RW	PMINTENSET <sup>a</sup>	PMINTENSET <sup>a</sup>	Performance Monitors Interrupt Enable Set register.
0xC44-0xC5C	-	-	-	Reserved.
0xC60	RW	PMINTENCLR <sup>a</sup>	PMINTENCLR <sup>a</sup>	Performance Monitors Interrupt Enable Clear register.
0xC64-0xC7C	-	-	-	Reserved.
0xC80	RW	PMOVSRS <sup>a</sup>	PMOVSRS <sup>a</sup>	Performance Monitors Overflow Flag Status Register.
0xC84-0xC9C	-	-	-	Reserved.
0xCA0	WO	PMSWINCS <sup>a</sup>	PMSWINCS <sup>a</sup>	Performance Monitors Software Increment register.
0xCA4-0xCBC	-	-	-	Reserved.
0xCC0	RW	PMOVSSET <sup>a</sup>	-	Performance Monitors Overflow Flag Status Set register. Reserved in a PMSA implementation, and in a VMSA implementation that does not include the Virtualization Extensions.
0xCC4-0xD7C	-	-	-	Reserved.
0xD80-0xDFC	-	-	-	IMPLEMENTATION DEFINED.
0xE00	RO		PMCFGR <sup>b</sup>	Performance Monitors Configuration Register.

**Table B-1 Performance Monitors memory-mapped register views (continued)**

Offset	Type	Name, VMSA	Name, PMSA	Description
0xE04	RW	PMCR <sup>a</sup>	PMCR <sup>a</sup>	Performance Monitors Control Register.
0xE08	RW	PMUSERENR <sup>a</sup>	PMUSERENR <sup>a</sup>	Performance Monitors User Enable Register.
0xE0C-0xE1C	-	-	-	Reserved.
0xE20	RO	PMCEID0 <sup>a</sup>	PMCEID0 <sup>a</sup>	Performance Monitors Common Event Identification register 0.
0xE24	RO	PMCEID1 <sup>a</sup>	PMCEID1 <sup>a</sup>	Performance Monitors Common Event Identification register 1.
0xE28-0xE7C	-	-	-	Reserved.
0xE80-0xEFC	-	-	-	Reserved for IMPLEMENTATION DEFINED integration registers, UNK/SBZP.
0xF00	-	-	-	Reserved for Integration Mode Control register, RAZ/WI.
0xF04-0xF9C	-	-	-	Reserved.
0xFA0	-		PMCLAIMSET <sup>b</sup>	Reserved for Claim Set register, RAZ/WI.
0xFA4	-		PMCLAIMCLR <sup>b</sup>	Reserved for Claim Tag Clear register, RAZ/WI.
0xFA8-0xFAC	-		-	Reserved.
0xFB0	WO		PMLAR <sup>b</sup>	Performance Monitors Lock Access Register.
0xFB4	RO		PMLSR <sup>b</sup>	Performance Monitors Lock Status Register.
0xFB8	RO		PMAUTHSTATUS <sup>b</sup>	Performance Monitors Authentication Status register.
0xFBC-0xFC4	-		-	Reserved.
0xFC8	-		PMDEVID <sup>b</sup>	Reserved for DEVID register, UNK/SBZP.
0xFCC	RO		PMDEVTYPE <sup>b</sup>	Performance Monitors Device Type register.
0xFD0	RO		PMPID4 <sup>b</sup>	Performance Monitors Peripheral Identification register 4.
0xFD4-0xFDC	-		PMPID5-PMPID7 <sup>b</sup>	Reserved for Performance Monitors Peripheral Identification registers 5-7, UNK/SBZP.
0xFE0	RO		PMPID0 <sup>b</sup>	Performance Monitors Peripheral Identification register 0.
0xFE4	RO		PMPID1 <sup>b</sup>	Performance Monitors Peripheral Identification register 1.
0xFE8	RO		PMPID2 <sup>b</sup>	Performance Monitors Peripheral Identification register 2.
0xFEC	RO		PMPID3 <sup>b</sup>	Performance Monitors Peripheral Identification register 3.
0xFF0	RO		PMCID0 <sup>b</sup>	Performance Monitors Component Identification register 0.
0xFF4	RO		PMCID1 <sup>b</sup>	Performance Monitors Component Identification register 1.

**Table B-1 Performance Monitors memory-mapped register views (continued)**

Offset	Type	Name, VMSA	Name, PMSA	Description
0xFF8	RO		PMCID2 <sup>b</sup>	Performance Monitors Component Identification register 2.
0xFFC	RO		PMCID3 <sup>b</sup>	Performance Monitors Component Identification register 3.

- a. These registers are also defined in the CP15 interface to the Performance Monitors, and are described in [Chapter B4 System Control Registers in a VMSA implementation](#) and [Chapter B6 System Control Registers in a PMSA implementation](#), as appropriate. The entries in the *Name*, *VMSA* and *Name*, *PMSA* columns link to the descriptions in those chapters.
- b. These registers are defined only in the memory-mapped views of the Performance Monitors. Each register description includes any additional constraints on the implementation of the register.

### B.1.4 Access permissions for memory-mapped views of the Performance Monitors

The access permissions for accesses to the Performance Monitors registers using the recommended memory-mapped interface, or using the external debug interface, are a simplified version of the permissions for accesses to the debug registers described in [Chapter C6 Debug Register Interfaces](#). The following subsections describe these access permissions:

- [Accesses to memory-mapped views of the Performance Monitors, v7 Debug](#)
- [Accesses to memory-mapped views of the Performance Monitors, v7.1 Debug on page AppxB-2358](#).

#### Accesses to memory-mapped views of the Performance Monitors, v7 Debug

These access permissions are a simplified version of the permissions for accesses to the debug registers described in [v7 Debug register access in the memory-mapped and external debug interfaces on page C6-2132](#). [Table B-2 on page AppxB-2357](#) shows the access permissions for the Performance Monitors registers in a v7 Debug implementation. This table uses the following abbreviations:

<b>CPD</b>	When core power domain is powered down, accesses to some registers produce an error. Applies to both interfaces.
<b>SPD</b>	When <code>DBGPRSR.SPD</code> , the Sticky powerdown status bit, is set to 1, accesses to some registers produce an error. Applies to both interfaces.
<b>OSL</b>	When the OS Lock is set, in the <code>DBGOSLAR</code> , accesses to some registers produce an error. Applies to both interfaces.
<b>SLK</b>	When the Performance Monitors Software Lock is set, in the <code>PMLAR</code> , if all other controls permit accesses to the registers, accesses through the memory-mapped interface are read-only and have no side-effects. An access that is UNPREDICTABLE is guaranteed not to perform a register write.

———— **Note** —————

SLK applies only to the memory-mapped interface.

<b>Err</b>	Indicates that the access gives an error response.
-	Indicates that the control has no effect on the behavior of the access: <ul style="list-style-type: none"> <li>• If no other control affects the behavior, the Default access behavior applies.</li> <li>• However, another control might determine the behavior.</li> </ul>
<b>WI</b>	Indicates that the write access is ignored.



**Table B-2 v7 Debug memory-mapped and external debug interfaces Performance Monitors access behavior**

Offset	Register name	Default access	CPD	SPD or OSL	SLK <sup>a</sup>
0x0nn	PMXEVCNTR <sub>x</sub>	RW	Err	Err	RO
0x07C	PMCCNTR	RW	Err	Err	RO
0x4nn	PMXEVTYPER <sub>x</sub>	RW	Err	Err	RO
0x47C	PMXEVTYPER31	RW	Err	Err	RO
0xA00-0xBFC	IMPLEMENTATION DEFINED		Access is IMPLEMENTATION DEFINED		
0xC00	PMCNTENSET	RW	Err	Err	RO
0xC20	PMCNTENCLR	RW	Err	Err	RO
0xC40	PMINTENSET	RW	Err	Err	RO
0xC60	PMINTENCLR	RW	Err	Err	RO
0xC80	PMOVSr	RW	Err	Err	RO
0xCA0	PMSWINC	WO	Err	Err	WI
0xCC0	Reserved in v7 Debug	UNK/SBZP	See <a href="#">Accesses to reserved and unallocated registers, v7 Debug on page C6-2135</a>		
0xD80-0xDFC	IMPLEMENTATION DEFINED		Access is IMPLEMENTATION DEFINED		
0xE00	PMCFGR	RO	Err	Err	-
0xE04	PMCR	RW	Err	Err	RO
0xE08	PMUSERENR	RW	Err	Err	RO
0xE20	PMCEID0	RO	Err	Err	-
0xE24	PMCEID1	RO	Err	Err	-
All other registers in the range 0x000-0xE7C, reserved		See <a href="#">Accesses to reserved and unallocated registers, v7 Debug on page C6-2135</a>			
0xE80-0xEFC	Integration registers		Access is IMPLEMENTATION DEFINED		
0xF00	Integration Mode Control register		Access is IMPLEMENTATION DEFINED		
0xFB0	PMLAR <sup>b</sup>	WO <sup>b</sup>	- <sup>b</sup>	-	WO <sup>b</sup>
0xFB4	PMLSR <sup>b</sup>	RO <sup>b</sup>	- <sup>b</sup>	-	-
0xFB8	PMAUTHSTATUS	RO	-	-	-
0xFCC	PMDEVTYPE	RO	-	-	-
0xFD0	PMPID4	RO	-	-	-
0xFD4-0xFDC	Reserved for PMPID5-PMPID7	UNK/SBZP	-	-	-
0xFE0	PMPID0				
0xFE4	PMPID1				
0xFE8	PMPID2				

**Table B-2 v7 Debug memory-mapped and external debug interfaces Performance Monitors access behavior**

Offset	Register name	Default access	CPD	SPD or OSL	SLK <sup>a</sup>
0xFEC	PMPID3	RO	-	-	-
0xFF0	PMCID0	RO	-	-	-
0xFF4	PMCID1	RO	-	-	-
0xFF8	PMCID2	RO	-	-	-
0xFFC	PMCID3	RO	-	-	-
All other registers in the range 0xF00-0xFFC, reserved		UNK/SBZP	-	-	-

- a. *SLK* has no effect on accesses through the external debug interface. For the memory-mapped interface, when the Software Lock is set, accesses to registers other than the **PMLAR** is restricted so that at least writes are ignored and reads have no side-effects. This applies even when the access is UNPREDICTABLE or IMPLEMENTATION DEFINED. The **PMLAR** is always WO in the memory-mapped interface, regardless of the state of the Software Lock.
- b. Memory-mapped interface only. When using the external debug interface, accesses to the **PMLAR** are UNPREDICTABLE, and reads of the **PMLSR** return an UNKNOWN value.

### Accesses to memory-mapped views of the Performance Monitors, v7.1 Debug

These access permissions are a simplified version of the permissions for accesses to the debug registers described in [v7.1 Debug register access in the memory-mapped and external debug interfaces on page C6-2141](#). [Table B-3 on page AppxB-2359](#) shows the access permissions for the Performance Monitors registers in a v7.1 Debug implementation. This table uses the following abbreviations:

<b>CPD</b>	When core power domain is powered down, accesses to some registers produce an error. Applies to both interfaces.
<b>OSL, ED</b>	When the OS Lock is set, in the <b>DBGOSLAR</b> , accesses to some registers produce an error. This column shows the effect of this control on accesses using the external debug interface.
<b>OSL, MM</b>	When the OS Lock is set, in the <b>DBGOSLAR</b> , accesses to some registers produce an error. This column shows the effect of this control on accesses using the memory-mapped interface.
<b>SLK</b>	When the Performance Monitors Software Lock is set, in the <b>PMLAR</b> , if all other controls permit accesses to the registers, accesses through the memory-mapped interface are read-only and have no side-effects. An access that is UNPREDICTABLE is guaranteed not to perform a register write.
<b>Note</b>	
SLK applies only to the memory-mapped interface.	
<b>Err</b>	Indicates that the access gives an error response.
-	Indicates that the control has no effect on the behavior of the access: <ul style="list-style-type: none"> <li>• If no other control affects the behavior, the Default access behavior applies.</li> <li>• However, another control might determine the behavior.</li> </ul>
<b>WI</b>	Indicates that the write access is ignored.

**Table B-3 v7.1 Debug memory-mapped and external debug interfaces Performance Monitors access behavior**

Offset	Register name	Default access	CPD	OSL, ED	OSL, MM	SLK <sup>a</sup>
0x0nn	PMXEVCNTR <sub>x</sub>	RW	Err	Err	-	RO
0x07C	PMCCNTR	RW	Err	Err	-	RO
0x4nn	PMXEVTYPERS <sub>x</sub>	RW	Err	Err	-	RO
0x47C	PMXEVTYPERS31	RW	Err	Err	-	RO
0xA00-0xBFC	IMPLEMENTATION DEFINED	Access is IMPLEMENTATION DEFINED				
0xC00	PMCNTENSET	RW	Err	Err	-	RO
0xC20	PMCNTENCLR	RW	Err	Err	-	RO
0xC40	PMINTENSET	RW	Err	Err	-	RO
0xC60	PMINTENCLR	RW	Err	Err	-	RO
0xC80	PMOVSRS	RW	Err	Err	-	RO
0xCA0	PMSWINC	WO	Err	Err	-	WI
0xCC0	PMOVSSET <sup>b</sup>	RW	Err	Err	-	RO
0xD80-0xDFC	IMPLEMENTATION DEFINED	Access is IMPLEMENTATION DEFINED				
0xE00	PMCFGR	RO	Err	Err	-	-
0xE04	PMCR	RW	Err	Err	-	RO
0xE08	PMUSERENR	RW	Err	Err	-	RO
0xE20-0xE24	PMCEID	RO	Err	Err	-	-
All other registers in the range 0x000-0xE7C, reserved		See <i>Accesses to reserved and unallocated registers, v7 Debug</i> on page C6-2135				
0xE80-0xEFC	Integration registers	Access is IMPLEMENTATION DEFINED				
0xF00	Integration Mode Control register	Access is IMPLEMENTATION DEFINED				
0xFB0	PMLAR <sup>c</sup>	WO <sup>c</sup>	- <sup>c</sup>	UNPREDICTABLE	-	- <sup>c</sup>
0xFB4	PMLSR <sup>c</sup>	RO <sup>c</sup>	- <sup>c</sup>	UNKNOWN	-	-
0xFB8	PMAUTHSTATUS	RO	-	-	-	-
0xFCC	PMDEVTYPE	RO	-	-	-	-
0xFD0	PMPID4	RO	-	-	-	-
0xFD4-0xFDC	Reserved for PMPID5-PMPID7	UNK/SBZP	-	-	-	-
0xFE0	PMPID0	RO	-	-	-	-
0xFE4	PMPID1	RO	-	-	-	-
0xFE8	PMPID2	RO	-	-	-	-
0xFEC	PMPID3	RO	-	-	-	-
0xFF0	PMCID0	RO	-	-	-	-

**Table B-3 v7.1 Debug memory-mapped and external debug interfaces Performance Monitors access behavior**

Offset	Register name	Default access	CPD	OSL, ED	OSL, MM	SLK <sup>a</sup>
0xFF4	PMCID1	RO	-	-	-	-
0xFF8	PMCID2	RO	-	-	-	-
0xFFC	PMCID3	RO	-	-	-	-
All other registers in the range 0xF00-0xFFC, reserved		UNK/SBZP	-	-	-	-

- a. *SLK* has no effect on accesses through the external debug interface. For the memory-mapped interface, when the Software Lock is set, accesses to registers other than the [PMLAR](#) is restricted so that at least writes are ignored and reads have no side-effects. This applies even when the access is UNPREDICTABLE or IMPLEMENTATION DEFINED. The [PMLAR](#) is always WO in the memory-mapped interface, regardless of the state of the Software Lock.
- b. Only if the implementation includes the Virtualization Extensions. Otherwise, this offset is reserved, see [Access to reserved and unallocated registers, v7.1 Debug](#) on page C6-2144.
- c. Memory-mapped interface only. When using the external debug interface, accesses to the [PMLAR](#) are UNPREDICTABLE, and reads of the [PMLSR](#) return an UNKNOWN value.

## B.2 PMU register descriptions for memory-mapped register views

This section describes the Performance Monitors registers that are not defined in [Chapter B4 System Control Registers in a VMSA implementation](#) and [Chapter B6 System Control Registers in a PMSA implementation](#) but are implemented in one or both of:

- an external debug interface to the Performance Monitors
- a memory-mapped interface to the Performance Monitors.

[Table B-1 on page AppxB-2353](#) lists all registers that are visible in these memory-mapped views of the Performance Monitors registers.

### B.2.1 PMAUTHSTATUS, Performance Monitors Authentication Status register

The PMAUTHSTATUS characteristics are:

<b>Purpose</b>	Indicates the implemented debug features and provides the current values of the configuration inputs that determine the debug permissions.  This register is a Performance Monitors register that is visible only in the memory-mapped views of the Performance Monitors registers.
<b>Usage constraints</b>	There are no usage constraints.
<b>Configurations</b>	Implemented only if an implementation of the Performance Monitors Extension provides a memory-mapped view of the Performance Monitors registers.  If implemented in a processor that includes the Security Extensions, this is a Common register.
<b>Attributes</b>	A 32-bit RO register, at offset 0xFB8.  <a href="#">Table B-1 on page AppxB-2353</a> shows the register map for the memory-mapped views of the Performance Monitors registers.

In an implementation that includes the Security Extensions, the PMAUTHSTATUS bit assignments are:

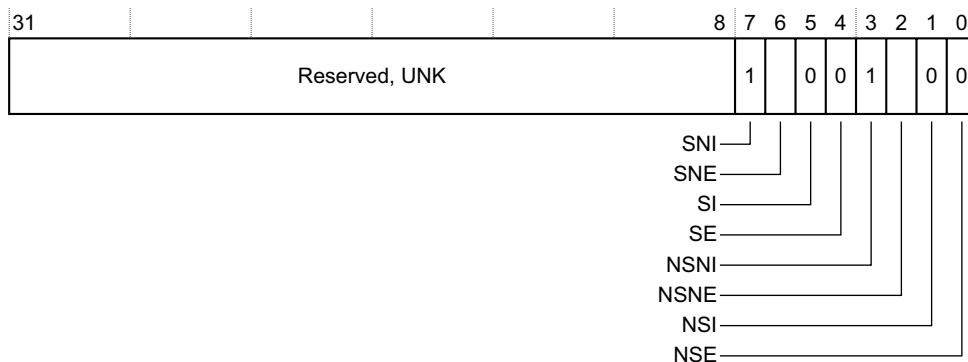

<b>Bits[31:8]</b>	Reserved, UNK.
<b>SNI, bit[7]</b>	Secure non-invasive debug features implemented. This bit is RAO, Secure non-invasive debug features are implemented.
<b>SNE, bit[6]</b>	Secure non-invasive debug enabled. This bit indicates whether non-invasive debug is permitted in Secure PL1 modes. For the recommended external debug interface, this bit is the logical result of <b>(DBGEN OR NIDEN) AND (SPIDEN OR SPNIDEN)</b> .
<b>SI, bit[5]</b>	Secure invasive debug features implemented. This bit is RAZ, Secure invasive debug features are not implemented.
<b>SE, bit[4]</b>	Secure invasive debug enabled. This bit is RAZ.



## B.2.2 PMCFGR, Performance Monitors Configuration Register

The PMCFGR characteristics are:

<b>Purpose</b>	Contains PMU-specific configuration data. This register is a Performance Monitors register that is visible only in the memory-mapped views of the Performance Monitors registers.
<b>Usage constraints</b>	There are no usage constraints.
<b>Configurations</b>	Implemented only if an implementation of the Performance Monitors Extension provides a memory-mapped view of the Performance Monitors registers.
<b>Attributes</b>	A 32-bit RO register, at offset 0xE00. <a href="#">Table B-1 on page AppxB-2353</a> shows the register map for the memory-mapped views of the Performance Monitors registers.

The PMCFGR bit assignments are:

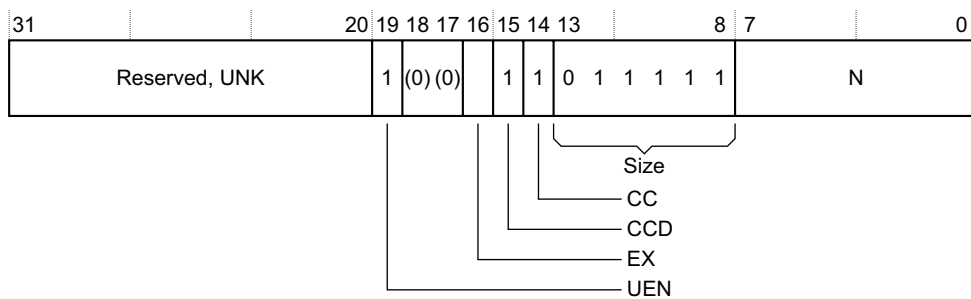

<b>Bits[31:20]</b>	Reserved, UNK.
<b>UEN, bit[19]</b>	User-mode Enable Register implemented. This bit is RAO. Its meaning is: <b>1</b> User-mode Enable Register implemented.
<b>Bit[18:17]</b>	Reserved, UNK.
<b>EX, bit[16]</b>	Export supported. This bit is RO and the value is IMPLEMENTATION DEFINED: <b>0</b> Export is not supported. <a href="#">PMCR.X</a> is RAZ/WI. <b>1</b> Export is supported. <a href="#">PMCR.X</a> is writable.
<b>CCD, bit[15]</b>	Cycle counter clock divider implemented. This bit is RAO. Its meaning is: <b>1</b> Cycle count divider implemented. This means <a href="#">PMCR.D</a> is writable.
<b>CC, bit[14]</b>	Cycle counter implemented. This bit is RAO. Its meaning is: <b>1</b> Cycle counter implemented. This means <a href="#">PMCR.C</a> , the cycle counter reset bit, is writable.
<b>SIZE, bits[13:8]</b>	Counter size. This field is RO and reads as 0b011111. Its meaning is: 0b011111 32-bit counters.
<b>N, bits[7:0]</b>	Number of event counters. This field is RO with a value that indicates the number of implemented event counters, from 0b00000000 if the implementation has no event counters, to 0b00011111 if it has 31 event counters.

**Note**

The cycle counter is not included in the value indicated by the N field.

In an implementation that includes the Virtualization Extensions, the value of [HDCR.HPMN](#) has no effect on the value returned by this field.

### B.2.3 PMCID0, Performance Monitors Component ID register 0

The PMCID0 characteristics are:

<b>Purpose</b>	Provides bits[7:0] of the 32-bit conceptual Component ID. This register is a Performance Monitors register that is visible only in the memory-mapped views of the Performance Monitors registers.
<b>Usage constraints</b>	There are no usage constraints.
<b>Configurations</b>	Implemented only if an implementation of the Performance Monitors Extension provides a memory-mapped view of the Performance Monitors registers. If implemented in a processor that includes the Security Extensions, this is a Common register.
<b>Attributes</b>	A 32-bit RO register, at offset 0xFF0. <a href="#">Table B-1 on page AppxB-2353</a> shows the register map for the memory-mapped views of the Performance Monitors registers.

The PMCID0 bit assignments are:

<b>Bits[31:8]</b>	Reserved, UNK.
<b>Preamble byte 0, bits[7:0]</b>	This field has the value 0x0D.

### B.2.4 PMCID1, Performance Monitors Component ID register 1

The PMCID1 characteristics are:

<b>Purpose</b>	Provides bits[15:8] of the 32-bit conceptual Component ID. This register is a Performance Monitors register that is visible only in the memory-mapped views of the Performance Monitors registers.
<b>Usage constraints</b>	There are no usage constraints.
<b>Configurations</b>	Implemented only if an implementation of the Performance Monitors Extension provides a memory-mapped view of the Performance Monitors registers. If implemented in a processor that includes the Security Extensions, this is a Common register.
<b>Attributes</b>	A 32-bit RO register, at offset 0xFF4. <a href="#">Table B-1 on page AppxB-2353</a> shows the register map for the memory-mapped views of the Performance Monitors registers.

The PMCID1 bit assignments are:

<b>Bits[31:8]</b>	Reserved, UNK.
<b>Component class, bits[7:4]</b>	This field has the value 0x9, indicating an ARM Debug component.
<b>Preamble, bits[3:0]</b>	This field has the value 0x0.



## B.2.5 PMCID2, Performance Monitors Component ID register 2

The PMCID2 characteristics are:

<b>Purpose</b>	Provides bits[23:16] of the 32-bit conceptual Component ID. This register is a Performance Monitors register that is visible only in the memory-mapped views of the Performance Monitors registers.
<b>Usage constraints</b>	There are no usage constraints.
<b>Configurations</b>	Implemented only if an implementation of the Performance Monitors Extension provides a memory-mapped view of the Performance Monitors registers. If implemented in a processor that includes the Security Extensions, this is a Common register.
<b>Attributes</b>	A 32-bit RO register, at offset 0xFF8. <a href="#">Table B-1 on page AppxB-2353</a> shows the register map for the memory-mapped views of the Performance Monitors registers.

The PMCID2 bit assignments are:

<b>Bits[31:8]</b>	Reserved, UNK.
<b>Preamble byte 2, bits[7:0]</b>	This field has the value 0x05.

## B.2.6 PMCID3, Performance Monitors Component ID register 3

The PMCID3 characteristics are:

<b>Purpose</b>	Provides bits[31:24] of the 32-bit conceptual Component ID. This register is a Performance Monitors register that is visible only in the memory-mapped views of the Performance Monitors registers.
<b>Usage constraints</b>	There are no usage constraints.
<b>Configurations</b>	Implemented only if an implementation of the Performance Monitors Extension provides a memory-mapped view of the Performance Monitors registers. If implemented in a processor that includes the Security Extensions, this is a Common register.
<b>Attributes</b>	A 32-bit RO register, at offset 0xFFC. <a href="#">Table B-1 on page AppxB-2353</a> shows the register map for the memory-mapped views of the Performance Monitors registers.

The PMCID3 bit assignments are:

<b>Bits[31:8]</b>	Reserved, UNK.
<b>Preamble byte 3, bits[7:0]</b>	This field has the value 0xB1.

## B.2.7 PMDEVTYPE, Performance Monitors Device Type register

The PMDEVTYPE characteristics are:

- Purpose** Provides the CoreSight device type information for the Performance Monitors. Every CoreSight component must implement a Device Type register, to indicate the type of debug component.  
 This register is a Performance Monitors register that is visible only in the memory-mapped views of the Performance Monitors registers.
- Usage constraints** There are no usage constraints.
- Configurations** Implemented only if an implementation of the Performance Monitors Extension provides a memory-mapped view of the Performance Monitors registers.  
 If implemented in a processor that includes the Security Extensions, this is a Common register.
- Attributes** A 32-bit RO register, at offset 0xFC8.  
[Table B-1 on page AppxB-2353](#) shows the register map for the memory-mapped views of the Performance Monitors registers.

The PMDEVTYPE bit assignments are:

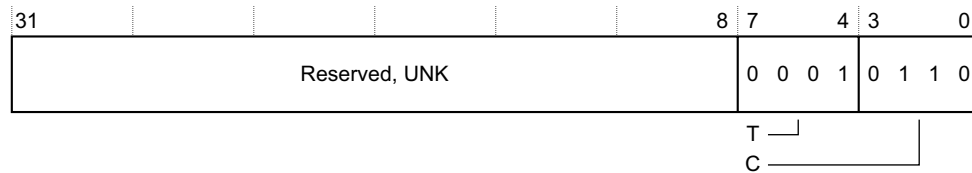

- Bits[31:8]** Reserved, UNK.
- T, bits[7:4]** Sub type. This field reads as 0x1, indicating a processor.
- C, bits[3:0]** Main class. This field reads as 0x6, indicating Performance Monitors.

For more information about the CoreSight registers, see the *CoreSight Architecture Specification*.

## B.2.8 PMLAR, Performance Monitors Lock Access Register

The PMLAR characteristics are:

<b>Purpose</b>	Provides a Software Lock on writes to the Performance Monitors registers through the memory-mapped interface. Use of this lock mechanism reduces the risk of accidental damage to the contents of the Performance Monitors registers. It does not prevent all accidental or malicious damage.  This register is a Performance Monitors register that is visible only in the memory-mapped interface, see Usage constraints.
<b>Usage constraints</b>	Used in conjunction with <a href="#">PMLSR</a> . The PMLAR is UNPREDICTABLE in the external debug interface.
<b>Configurations</b>	Implemented only if an implementation of the Performance Monitors Extension includes the memory-mapped register interface.  If implemented in a processor that includes the Security Extensions, this is a Common register.
<b>Attributes</b>	A 32-bit WO register, at offset 0xFB0.  <a href="#">Table B-1 on page AppxB-2353</a> shows the register map for the memory-mapped interface to the Performance Monitors registers.

The PMLAR bit assignments are:

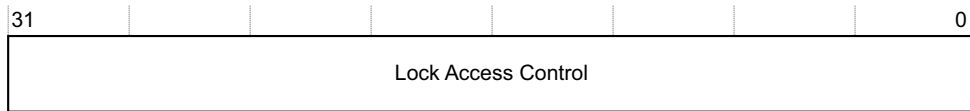

### Lock Access Control, bits[31:0]

Writing the key value 0xC5ACCE55 to this field clears the lock, enabling write accesses to the Performance Monitors registers through the memory-mapped interface.

Writing any other value to this register sets the lock, disabling write accesses to the Performance Monitors registers through the memory-mapped interface.

A debugger reads [PMLSR](#) to check the status of the Software Lock.

———— **Note** —————

- The Software Lock of the Performance Monitors registers is independent of the Software Lock of the debug registers.
- The PMLAR is not required to be maintained over a powerdown.

## B.2.9 PMLSR, Performance Monitors Lock Status Register

The PMLSR characteristics are:

<b>Purpose</b>	Shows the status of the Software Lock on the Performance Monitors registers. This register is a Performance Monitors register that is visible only in the memory-mapped interface, see Usage constraints.
<b>Usage constraints</b>	Used in conjunction with <a href="#">PMLAR</a> . The PMLSR is UNKNOWN in the external debug interface.
<b>Configurations</b>	Implemented only if an implementation of the Performance Monitors Extension includes the memory-mapped register interface.  If implemented in a processor that includes the Security Extensions, this is a Common register.
<b>Attributes</b>	A 32-bit RO register, at offset 0xFB4.  <a href="#">Table B-1 on page AppxB-2353</a> shows the register map for the memory-mapped interface to the Performance Monitors registers.

The PMLSR bit assignments are:

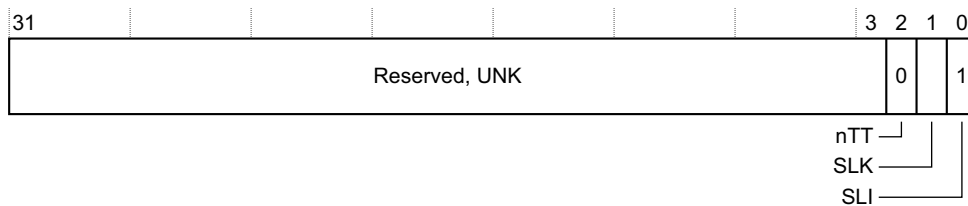

<b>Bits[31:3]</b>	Reserved, UNK.
<b>nTT, bit[2]</b>	Not 32-bit. This bit is always RAZ. It indicates that software must perform a 32-bit access to write the key to the <a href="#">PMLAR</a> .
<b>SLK, bit[1]</b>	Software Lock status. This bit indicates the status of the Performance Monitors registers lock. The possible values are: <b>0</b> Lock clear. <b>1</b> Lock set.  A debugger sets or clears the Performance Monitors registers lock by writing to the <a href="#">PMLAR</a> . The debug logic reset value of this bit is 1.
<b>SLI, bit[0]</b>	Software Lock implemented. This bit is RAO.

———— **Note** —————

- The Software Lock of the Performance Monitors registers is independent of the Software Lock of the debug registers.
- The PMLSR is not required to be maintained over a powerdown.

## B.2.10 PMPID0, Performance Monitors Peripheral ID register 0

The PMPID0 characteristics are:

<b>Purpose</b>	Provides bits[7:0] of the 64-bit conceptual Peripheral ID. This register is a Performance Monitors register that is visible only in the memory-mapped views of the Performance Monitors registers.
<b>Usage constraints</b>	There are no usage constraints.
<b>Configurations</b>	Implemented only if an implementation of the Performance Monitors Extension provides a memory-mapped view of the Performance Monitors registers. If implemented in a processor that includes the Security Extensions, this is a Common register.
<b>Attributes</b>	A 32-bit RO register, at offset 0xFE0. <a href="#">Table B-1 on page AppxB-2353</a> shows the register map for the memory-mapped views of the Performance Monitors registers.

The PMPID0 bit assignments are:

**Bits[31:8]** Reserved, UNK.

**Part number[7:0], bits[7:0]**

Bits[7:0] of the IMPLEMENTATION DEFINED part number.

———— **Note** —————

This is the part number for the Performance Monitors block. It is not the same part number as the processor debug block.

## B.2.11 PMPID1, Performance Monitors Peripheral ID register 1

The PMPID1 characteristics are:

<b>Purpose</b>	Provides bits[15:8] of the 64-bit conceptual Peripheral ID. This register is a Performance Monitors register that is visible only in the memory-mapped views of the Performance Monitors registers.
<b>Usage constraints</b>	There are no usage constraints.
<b>Configurations</b>	Implemented only if an implementation of the Performance Monitors Extension provides a memory-mapped view of the Performance Monitors registers. If implemented in a processor that includes the Security Extensions, this is a Common register.
<b>Attributes</b>	A 32-bit RO register, at offset 0xFE4. <a href="#">Table B-1 on page AppxB-2353</a> shows the register map for the memory-mapped views of the Performance Monitors registers.

The PMPID1 bit assignments are:

<b>Bits[31:8]</b>	Reserved, UNK.
<b>JEP identification code[3:0], bits[7:4]</b>	Bits[3:0] of the IMPLEMENTATION DEFINED JEP identification code. For an implementation designed by ARM the JEP106 identification code is 0x3B and therefore this field is 0xB.
<b>Part number[11:8], bits[3:0]</b>	Bits[11:8] of the IMPLEMENTATION DEFINED part number. For more information see the Part number field in <a href="#">PMPID0</a> .

## B.2.12 PMPID2, Performance Monitors Peripheral ID register 2

The PMPID2 characteristics are:

<b>Purpose</b>	Provides bits[23:16] of the 64-bit conceptual Peripheral ID. This register is a Performance Monitors register that is visible only in the memory-mapped views of the Performance Monitors registers.
<b>Usage constraints</b>	There are no usage constraints.
<b>Configurations</b>	Implemented only if an implementation of the Performance Monitors Extension provides a memory-mapped view of the Performance Monitors registers. If implemented in a processor that includes the Security Extensions, this is a Common register.
<b>Attributes</b>	A 32-bit RO register, at offset 0xFE8. <a href="#">Table B-1 on page AppxB-2353</a> shows the register map for the memory-mapped views of the Performance Monitors registers.

The PMPID2 bit assignments are:

<b>Bits[31:8]</b>	Reserved, UNK.
<b>Revision, bits[7:4]</b>	The IMPLEMENTATION DEFINED revision number for the implementation.
<b>Uses JEP code, bit[3]</b>	For an ARMv7 implementation this bit must be one, indicating that the Peripheral ID uses a JEP106 identification code.
<b>JEP identification code[6:4], bits[2:0]</b>	Bits[6:4] of the IMPLEMENTATION DEFINED JEP identification code. For an implementation designed by ARM the JEP106 identification code is 0x3B and therefore this field is 0b011.

### B.2.13 PMPID3, Performance Monitors Peripheral ID register 3

The PMPID3 characteristics are:

<b>Purpose</b>	Provides bits[31:24] of the 64-bit conceptual Peripheral ID. This register is a Performance Monitors register that is visible only in the memory-mapped views of the Performance Monitors registers.
<b>Usage constraints</b>	There are no usage constraints.
<b>Configurations</b>	Implemented only if an implementation of the Performance Monitors Extension provides a memory-mapped view of the Performance Monitors registers. If implemented in a processor that includes the Security Extensions, this is a Common register.
<b>Attributes</b>	A 32-bit RO register, at offset 0xFEC. <a href="#">Table B-1 on page AppxB-2353</a> shows the register map for the memory-mapped views of the Performance Monitors registers.

The PMPID3 bit assignments are:

<b>Bits[31:8]</b>	Reserved, UNK.
<b>RevAnd, bits[7:4]</b>	The IMPLEMENTATION DEFINED manufacturing revision number for the implementation.
<b>Customer modified, bits[3:0]</b>	An IMPLEMENTATION DEFINED value that indicates an endorsed modification to the implementation. If the system designer cannot modify the RTL supplied by the processor designer then this field is RAZ.



## B.2.14 PMPID4, Performance Monitors Peripheral ID register 4

The PMPID4 characteristics are:

<b>Purpose</b>	Provides bits[39:32] of the 64-bit conceptual Peripheral ID. This register is a Performance Monitors register that is visible only in the memory-mapped views of the Performance Monitors registers.
<b>Usage constraints</b>	There are no usage constraints.
<b>Configurations</b>	Implemented only if an implementation of the Performance Monitors Extension provides a memory-mapped view of the Performance Monitors registers. If implemented in a processor that includes the Security Extensions, this is a Common register.
<b>Attributes</b>	A 32-bit RO register, at offset 0xFD0. <a href="#">Table B-1 on page AppxB-2353</a> shows the register map for the memory-mapped views of the Performance Monitors registers.

The PMPID4 bit assignments are:

<b>Bits[31:8]</b>	Reserved, UNK.
<b>4KB count, bits[7:4]</b>	This field is RAZ for all ARMv7 implementations.
<b>JEP106 continuation code, bits[3:0]</b>	The IMPLEMENTATION DEFINED JEP106 continuation code. For an implementation designed by ARM this field is 0x4.



## Appendix C

# Recommendations for Performance Monitors Event Numbers for IMPLEMENTATION DEFINED Events

This appendix describes the ARM recommendations for the use of the IMPLEMENTATION DEFINED event numbers. It contains the following section:

- [ARM recommendations for IMPLEMENTATION DEFINED event numbers on page AppxC-2376.](#)

## C.1 ARM recommendations for IMPLEMENTATION DEFINED event numbers

These are the ARM recommendations for the use of the IMPLEMENTATION DEFINED event numbers. ARM does not define these events as rigorously as those in the architectural and microarchitectural event lists, and an implementation might:

- Modify the definition of an event to better correspond to the implementation.
- Not use some, or many, of these event numbers.

———— **Note** —————

In these definitions, in an implementation that includes the Security Extensions or the Virtualization Extensions, an exception that is *taken locally* means an exception that is taken to the default mode at the default offset, and is not routed to another mode. See [Processor mode for taking exceptions on page B1-1172](#) for more information.

[Table C-1](#) lists the PMU IMPLEMENTATION DEFINED event numbers in event number order. As the table shows:

- Event numbers 0x90-0xBF are reserved for future expansion of the recommended event numbers.
- Event numbers 0xC0-0xFF are available for IMPLEMENTATION DEFINED events.

**Table C-1 PMU IMPLEMENTATION DEFINED event numbers**

Event number	Event mnemonic	Description
0x40	L1D_CACHE_LD	Level 1 data cache access, read
0x41	L1D_CACHE_ST	Level 1 data cache access, write
0x42	L1D_CACHE_REFILL_LD	Level 1 data cache refill, read
0x43	L1D_CACHE_REFILL_ST	Level 1 data cache refill, write
0x44	L1D_CACHE_REFILL_INNER	Level 1 data cache refill, inner
0x45	L1D_CACHE_REFILL_OUTER	Level 1 data cache refill, outer
0x46	L1D_CACHE_WB_VICTIM	Level 1 data cache write-back, victim
0x47	L1D_CACHE_WB_CLEAN	Level 1 data cache write-back, cleaning and coherency
0x48	L1D_CACHE_INVALID	Level 1 data cache invalidate
0x49-0x4B	-	Reserved
0x4C	L1D_TLB_REFILL_LD	Level 1 data TLB refill, read
0x4D	L1D_TLB_REFILL_ST	Level 1 data TLB refill, write
0x4E-0x4F	-	Reserved
0x50	L2D_CACHE_LD	Level 2 data cache access, read
0x51	L2D_CACHE_ST	Level 2 data cache access, write
0x52	L2D_CACHE_REFILL_LD	Level 2 data cache refill, read
0x53	L2D_CACHE_REFILL_ST	Level 2 data cache refill, write
0x54-0x55	-	Reserved
0x56	L2D_CACHE_WB_VICTIM	Level 2 data cache write-back, victim
0x57	L2D_CACHE_WB_CLEAN	Level 2 data cache write-back, cleaning and coherency
0x58	L2D_CACHE_INVALID	Level 2 data cache invalidate

**Table C-1 PMU IMPLEMENTATION DEFINED event numbers (continued)**

Event number	Event mnemonic	Description
0x59-0x5F	-	Reserved
0x60	BUS_ACCESS_LD	Bus access, read
0x61	BUS_ACCESS_ST	Bus access, write
0x62	BUS_ACCESS_SHARED	Bus access, Normal, Cacheable, Shareable
0x63	BUS_ACCESS_NOT_SHARED	Bus access, not Normal, Cacheable, Shareable
0x64	BUS_ACCESS_NORMAL	Bus access, normal
0x65	BUS_ACCESS_PERIPH	Bus access, peripheral
0x66	MEM_ACCESS_LD	Data memory access, read
0x67	MEM_ACCESS_ST	Data memory access, write
0x68	UNALIGNED_LD_SPEC	Unaligned access, read
0x69	UNALIGNED_ST_SPEC	Unaligned access, write
0x6A	UNALIGNED_LDST_SPEC	Unaligned access
0x6B	-	Reserved
0x6C	LDREX_SPEC	Exclusive instruction speculatively executed, LDREX
0x6D	STREX_PASS_SPEC	Exclusive instruction speculatively executed, STREX pass
0x6E	STREX_FAIL_SPEC	Exclusive instruction speculatively executed, STREX fail
0x6F	STREX_SPEC	Exclusive instruction speculatively executed, STREX
0x70	LD_SPEC	Instruction speculatively executed, load
0x71	ST_SPEC	Instruction speculatively executed, store
0x72	LDST_SPEC	Instruction speculatively executed, load or store
0x73	DP_SPEC	Instruction speculatively executed, integer data processing
0x74	ASE_SPEC	Instruction speculatively executed, Advanced SIMD data processing
0x75	VFP_SPEC	Instruction speculatively executed, Floating-point data processing
0x76	PC_WRITE_SPEC	Instruction speculatively executed, software change of the PC
0x77	-	Reserved
0x78	BR_IMMED_SPEC	Branch speculatively executed, immediate branch
0x79	BR_RETURN_SPEC	Branch speculatively executed, procedure return
0x7A	BR_INDIRECT_SPEC	Branch speculatively executed, indirect branch
0x7B	-	Reserved
0x7C	ISB_SPEC	Barrier speculatively executed, ISB
0x7D	DSB_SPEC	Barrier speculatively executed, DSB
0x7E	DMB_SPEC	Barrier speculatively executed, DMB

**Table C-1 PMU IMPLEMENTATION DEFINED event numbers (continued)**

Event number	Event mnemonic	Description
0x7F-0x80	-	Reserved
0x81	EXC_UNDEF	Exception taken, Undefined Instruction
0x82	EXC_SVC	Exception taken, Supervisor Call
0x83	EXC_PABORT	Exception taken, Prefetch Abort
0x84	EXC_DABORT	Exception taken, Data Abort
0x85	-	Reserved
0x86	EXC_IRQ	Exception taken, IRQ
0x87	EXC_FIQ	Exception taken, FIQ
0x88	EXC_SMC	Exception taken, Secure Monitor Call
0x89	-	Reserved
0x8A	EXC_HVC	Exception taken, Hypervisor Call
0x8B	EXC_TRAP_PABORT	Exception taken, Prefetch Abort not taken locally
0x8C	EXC_TRAP_DABORT	Exception taken, Data Abort not taken locally
0x8D	EXC_TRAP_OTHER	Exception taken, other hypervisor traps
0x8E	EXC_TRAP_IRQ	Exception taken, IRQ not taken locally
0x8F	EXC_TRAP_FIQ	Exception taken, FIQ not taken locally
0x90-0xBF	-	Reserved for future extension of these recommendations
0xC0-0xFF	-	Available for IMPLEMENTATION DEFINED events

**0x40, Level 1 data cache access, read**

This event is similar to the *Level 1 data cache access* event, event 0x04, but the counter counts only memory-read operations that access at least the Level 1 data or unified cache.

**0x41, Level 1 data cache access, write**

This event is similar to the *Level 1 data cache access* event, event 0x04, but the counter counts only memory-write operations that access at least the Level 1 data or unified cache.

**0x42, Level 1 data cache refill, read**

This event is similar to the *Level 1 data cache refill* event, event 0x03, but the counter counts only memory-read operations that cause a refill of at least the Level 1 data or unified cache.

**0x43, Level 1 data cache refill, write**

This event is similar to the *Level 1 data cache refill* event, event 0x03, but the counter counts only memory-write operations that cause a refill of at least the Level 1 data or unified cache.

**0x44, Level 1 data cache refill, inner**

This event is similar to the *Level 1 data cache refill* event, event 0x03, but the counter counts only memory-read and memory-write operations that generate refills satisfied by transfer from another cache inside of the immediate cluster.

———— **Note** —————

The boundary between *inner* and *outer* is IMPLEMENTATION DEFINED, and it is not necessarily linked to other similar boundaries, such as the boundary between Inner Cacheable and Outer Cacheable or the boundary between Inner Shareable and Outer Shareable.

---

**0x45, Level 1 data cache refill, outer**

This event is similar to the *Level 1 data cache refill* event, event 0x03, but the counter counts only memory-read and memory-write operations that generate refills satisfied from outside of the immediate cluster.

**0x46, Level 1 data cache write-back, victim**

This event is similar to the *Level 1 data cache write-back* event, event 0x15, but the counter counts only write-backs that are a result of the line being allocated for an access made by the processor. CP15 cache maintenance operations do not count as events.

**0x47, Level 1 data cache write-back, cleaning and coherency**

This event is similar to the *Level 1 data cache write-back* event, event 0x15, but the counter counts only write-backs that are a result of a coherency operation made by another processor, or from a CP15 cache maintenance operation. Whether write-backs made as a result of CP15 cache maintenance operations are counted is IMPLEMENTATION DEFINED.

———— **Note** —————

The transfer of a dirty cache line from the Level 1 data cache of this processor to the Level 1 data cache of another processor due to a hardware coherency operation is not counted unless the dirty cache line is also written back to a Level 2 cache or memory.

---

**0x48, Level 1 data cache invalidate**

The counter counts each invalidation of a cache line in the Level 1 data or unified cache.

The counter does not count events:

- if a cache refill invalidates a line
- for locally executed CP15 cache set/way maintenance operations.

**0x4C, Level 1 data TLB refill, read**

This event is similar to the *Level 1 data TLB refill* event, event 0x05, but the counter counts only memory-read operations that cause a data TLB refill of at least the Level 1 data or unified TLB.

**0x4D, Level 1 data TLB refill, write**

This event is similar to the *Level 1 data TLB refill* event, event 0x05, but the counter counts only memory-write operations that cause a data TLB refill of at least the Level 1 data or unified TLB.

**0x50, Level 2 data cache access, read**

This event is similar to the *Level 2 data cache access* event, event 0x16, but the counter counts only memory-read operations that access at least the Level 2 data or unified cache.

**0x51, Level 2 data cache access, write**

This event is similar to the *Level 2 data cache access* event, event 0x16, but the counter counts only memory-write operations that access at least the Level 2 data or unified cache.

**0x52, Level 2 data cache refill, read**

This event is similar to the *Level 2 data cache refill* event, event 0x17, but the counter counts only memory-read operations that cause a refill of at least the Level 2 data or unified cache.

**0x53, Level 2 data cache refill, write**

This event is similar to the *Level 2 data cache refill* event, event 0x17, but the counter counts only memory-write operations that cause a refill of at least the Level 2 data or unified cache.

**0x56, Level 2 data cache write-back, victim**

This event is similar to the *Level 2 data cache write-back* event, event 0x18, but the counter counts only write-backs that are a result of the line being allocated for an access made by the processor.

CP15 cache maintenance operations do not count as events.

**0x57, Level 2 data cache write-back, cleaning and coherency**

This event is similar to the *Level 2 data cache write-back* event, event 0x18, but the counter counts only write-backs that are a result of a coherency operation made by another processor, or from a CP15 cache maintenance operation. Whether write-backs made as a result of CP15 cache maintenance operations are counted is IMPLEMENTATION DEFINED.

———— **Note** —————

The transfer of a dirty cache line from the Level 2 data cache of this processor to the Level 2 data cache of another processor due to a hardware coherency operation is not counted unless the dirty cache line is also written back to a Level 3 cache or memory.

**0x58, Level 2 data cache invalidate**

The counter counts each invalidation of a cache line in the Level 2 data or unified cache.

The counter does not count events:

- if a cache refill invalidates a line
- for locally executed CP15 set/way cache maintenance operations.

———— **Note** —————

Software that uses this event must know whether the Level 2 data cache is shared with other processors. This event does not follow the general rule of Level 2 data cache events of only counting events that directly affect this processor.

**0x60, Bus access, read**

This event is similar to the *Bus access* event, event 0x19, but the counter counts only memory-read operations that access outside the boundary of the processor and its closely-coupled caches.

**0x61, Bus access, write**

This event is similar to the *Bus access* event, event 0x19, but the counter counts only memory-write operations that access outside the boundary of the processor and its closely-coupled caches.

**0x62, Bus access, Normal, Cacheable, Shareable**

This event is similar to the *Bus access* event, event 0x19, but the counter counts only memory-read and memory-write operations that make Normal, Cacheable, Shareable accesses outside the boundary of the processor and its closely-coupled caches.

———— **Note** —————

It is IMPLEMENTATION DEFINED how the processor translates the attributes from the translation table entry for a region to the attributes on the bus.

In particular, a region of memory designated as Normal, Cacheable, Inner Shareable, Not Outer Shareable by a translation table entry, might be marked as either Shareable or Not Shareable at the boundary of the processor and its closely-coupled caches. This depends on where the IMPLEMENTATION DEFINED boundary lies, between Inner and Outer Shareable.

If the Inner Shareable extends beyond the processor boundary, and the bus indicates the distinction between Inner and Outer Shareable, then either is counted as Shareable for the purposes of defining this event.



**0x63, Bus access, not Normal, Cacheable, Shareable**

This event is similar to the *Bus access* event, event 0x19, but the counter counts only memory-read and memory-write operations that make accesses outside the boundary of the processor and its closely-coupled caches that are not Normal, Cacheable, Shareable. For example, the counter counts accesses marked as:

- Normal, Cacheable, Not Shareable
- Normal, Not Cacheable
- Device
- Strongly-ordered.

———— **Note** —————

See the Note to event 0x62, *Bus access, Normal, Cacheable, Shareable*, about how the processor translates the attributes from the translation table entries for a region to the attributes on the bus.

**0x64, Bus access, normal**

This event is similar to the *Bus access* event, event 0x19, but the counter counts only memory-read and memory-write operations that make Normal accesses outside the boundary of the processor and its closely-coupled caches. For example, the counter counts Normal, Cacheable and Normal, Not Cacheable accesses but does not count Device and Strongly-ordered accesses.

**0x65, Bus access, peripheral**

This event is similar to the *Bus access* event, event 0x19, but the counter counts only memory-read and memory-write operations that make Device or Strongly-ordered accesses outside the boundary of the processor and its closely-coupled caches.

**0x66, Data memory access, read**

This event is similar to the *Data memory access* event, event 0x13, but the counter counts only memory-read operations made by the processor.

**0x67, Data memory access, write**

This event is similar to the *Data memory access* event, event 0x13, but the counter counts only memory-write operations made by the processor.

**0x68, Unaligned access, read**

This event is similar to the *Data memory access* event, event 0x13, but the counter counts only unaligned memory-read operations that the processor made. It also counts unaligned accesses if they are subsequently changed into multiple aligned accesses.

**0x69, Unaligned access, write**

This event is similar to the *Data memory access* event, event 0x13, but the counter counts only unaligned memory-read operations that the processor made. It also counts unaligned accesses that are subsequently changed into multiple aligned accesses.

**0x6A, Unaligned access**

This event is similar to the *Data memory access* event, event 0x13, but the counter counts only unaligned memory-read operations and unaligned memory-write operations that the processor made. It also counts unaligned accesses that are subsequently changed into multiple aligned accesses.

**0x6C, Exclusive instruction speculatively executed, LDREX**

The counter counts Load-Exclusive instructions speculatively executed.

The definition of speculatively executed is IMPLEMENTATION DEFINED.

**0x6D, Exclusive instruction speculatively executed, STREX pass**

The counter counts Store-Exclusive instructions speculatively executed that completed a write.

The definition of speculatively executed is IMPLEMENTATION DEFINED but must be the same as for the *Exclusive instruction speculatively executed*, LDREX event, event 0x6C.

**0x6E, Exclusive instruction speculatively executed, STREX fail**

The counter counts Store-Exclusive instructions speculatively executed that fail to complete a write. It is within the IMPLEMENTATION DEFINED definition of speculatively executed whether this includes conditional instructions that fail the condition code check.

The definition of speculatively executed is IMPLEMENTATION DEFINED but must be the same as for the *Exclusive instruction speculatively executed*, LDREX event, event 0x6C.

**0x6F, Exclusive instruction speculatively executed, STREX**

The counter counts Store-Exclusive instructions speculatively executed.

The definition of speculatively executed is IMPLEMENTATION DEFINED but it must be the same as for the *Exclusive instruction speculatively executed*, LDREX event.

ARM recommends that this event is implemented if it is not possible to implement the *Exclusive instruction speculatively executed*, STREX *pass* and *Exclusive instruction speculatively executed*, STREX *fail* events with the same degree of speculation as the *Exclusive instruction speculatively executed*, LDREX event, event 0x6C.

**0x70, Instruction speculatively executed, load**

This event is similar to the *Instruction speculatively executed* event, event 0x1B, but the counter counts only memory-reading instructions, as defined by the *Instruction architecturally executed*, *condition code check pass*, *load* event, event 0x06.

The definition of speculatively executed is IMPLEMENTATION DEFINED but must be the same as for the *Instruction speculatively executed* event, event 0x1B.

**0x71, Instruction speculatively executed, store**

This event is similar to the *Instruction speculatively executed* event, event 0x1B, but the counter counts only memory-writing instructions, as defined by the *Instruction architecturally executed*, *condition code check pass*, *store* event, event 0x07.

The definition of speculatively executed is IMPLEMENTATION DEFINED but must be the same as for the *Instruction speculatively executed* event, event 0x1B.

**0x72, Instruction speculatively executed, load or store**

This event is similar to the *Instruction speculatively executed* event, event 0x1B, but the counter counts only memory-reading instructions and memory-writing instructions, as defined by the *Instruction architecturally executed*, *condition code check pass*, *load* and *Instruction architecturally executed*, *condition code check pass*, *store* events, events 0x06 and 0x07. It is IMPLEMENTATION DEFINED whether the speculative execution of an SWP or SWPB instruction is counted only once.

The definition of speculatively executed is IMPLEMENTATION DEFINED but must be the same as for the *Instruction speculatively executed* event, event 0x1B.

#### 0x73, Instruction speculatively executed, integer data processing

This event is similar to the *Instruction speculatively executed* event, event 0x1B, but counts only integer data processing instructions. It includes:

- all the operations that operate on the ARM core registers, except for those which explicitly write to the PC or access memory
- all the instructions that *Data-processing instructions on page A4-165* lists, including MOV and MVN.

This event also includes the following miscellaneous instructions that are not traditionally classified as integer data processing operations but are included for completeness:

- *Status register access instructions on page A4-174*
- *Banked register access instructions on page A4-174*
- *Miscellaneous instructions on page A4-178*, other than ISB, preloads, and swap
- *Coprocessor instructions on page A4-180*, other than load and store coprocessor instructions
- *Advanced SIMD and Floating-point register transfer instructions on page A4-183*.

If the preload instructions PLD, PLDW, and PLI, do not count as memory-reading instructions then they must count as integer data processing instructions.

If ISBs do not count as software change of the PC then they must count as integer data processing instructions.

The definition of speculatively executed is IMPLEMENTATION DEFINED, but must be the same as for the *Instruction speculatively executed* event, event 0x1B.

#### 0x74, Instruction speculatively executed, Advanced SIMD data processing

This event is similar to the *Instruction speculatively executed* event, event 0x1B, but the counter counts only Advanced SIMD data processing instructions, see *Advanced SIMD data-processing instructions on page A4-184*. This includes all operations that operate on the extended registers, except those that are Floating-point data processing instructions, memory-reading instructions, or memory-writing instructions.

The definition of speculatively executed is IMPLEMENTATION DEFINED, but must be the same as for the *Instruction speculatively executed* event, event 0x1B.

#### 0x75, Instruction speculatively executed, Floating-point data processing

This event is similar to the *Instruction speculatively executed* event, event 0x1B, but the counter counts only Floating-point data processing instructions, see *Floating-point data-processing instructions on page A4-191*. This includes all operations in the instruction set provided by the Floating-point Extension, including operations in VFP vector mode. It does not include Floating-point loads and stores.

The definition of speculatively executed is IMPLEMENTATION DEFINED, but must be the same as for the *Instruction speculatively executed* event, event 0x1B.

#### 0x76, Instruction speculatively executed, software change of the PC

This event is similar to the *Instruction speculatively executed* event, event 0x1B, but the counter counts only software changes of the PC, as defined by the *Instruction architecturally executed, condition code check pass, software change of the PC* event, event 0x0C.

The definition of speculatively executed is IMPLEMENTATION DEFINED but must be the same as for the *Instruction speculatively executed* event, event 0x1B.

#### 0x78, Branch speculatively executed, immediate branch

The counter counts immediate branch instructions speculatively executed, as defined by the *Instruction architecturally executed, immediate branch* event, event 0x0D.

The definition of speculatively executed is IMPLEMENTATION DEFINED.

**0x79, Branch speculatively executed, procedure return**

The counter counts procedure return instructions speculatively executed, as defined by the *Instruction architecturally executed, condition code check pass, procedure return* event, event 0x0E.  
The definition of speculatively executed is IMPLEMENTATION DEFINED.

**0x7A, Branch speculatively executed, indirect branch**

The counter counts indirect branch instructions speculatively executed. This includes software changes of the PC other than exception-generating instructions and immediate branch instructions.  
The definition of speculatively executed is IMPLEMENTATION DEFINED.

**0x7C, Barrier speculatively executed, ISB**

The counter counts Instruction Synchronization Barrier instructions speculatively executed, including [CP15ISB](#) operations.  
The definition of speculatively executed is IMPLEMENTATION DEFINED.

**0x7D, Barrier speculatively executed, DSB**

The counter counts Data Synchronization Barrier instructions speculatively executed, including [CP15DSB](#) operations.  
The definition of speculatively executed is IMPLEMENTATION DEFINED.

**0x7E, Barrier speculatively executed, DMB**

The counter counts Data Memory Barrier instructions speculatively executed, including [CP15DMB](#) operations.  
The definition of speculatively executed is IMPLEMENTATION DEFINED.

**0x81, Exception taken, Undefined Instruction**

This event is similar to the *Exception taken* event, event 0x09, but the counter counts only Undefined Instruction exceptions. If an implementation includes the Virtualization Extensions, this event counts only exceptions taken locally.

**0x82, Exception taken, Supervisor Call**

This event is similar to the *Exception taken* event, event 0x09, but the counter counts only Supervisor Call exceptions. If an implementation includes the Virtualization Extensions, this event counts only exceptions taken locally.

**0x83, Exception taken, Prefetch Abort**

This event is similar to the *Exception taken* event, event 0x09, but the counter counts only Prefetch Abort exceptions. If an implementation includes the Security Extensions or the Virtualization Extensions, this event counts only exceptions taken locally.

**0x84, Exception taken, Data Abort**

This event is similar to the *Exception taken* event, event 0x09, but the counter counts only Data Abort exceptions. If an implementation includes the Security Extensions or the Virtualization Extensions, the counter counts only exceptions taken locally.

**0x86, Exception taken, IRQ**

This event is similar to the *Exception taken* event, event 0x09, but the counter counts only IRQ exceptions. If an implementation includes the Security Extensions or the Virtualization Extensions, the counter counts only exceptions taken locally, including Virtual IRQ exceptions.

**0x87, Exception taken, FIQ**

This event is similar to the *Exception taken* event, event 0x09, but the counter counts only FIQ exceptions. If an implementation includes the Security Extensions or the Virtualization Extensions, the counter counts only exceptions taken locally, including Virtual FIQ exceptions.

**0x88, Exception taken, Secure Monitor Call**

This event is similar to the *Exception taken* event, event 0x09, but the counter counts only Secure Monitor Call exceptions. The counter does not increment on SMC instructions trapped as a Hyp Trap exception.

**0x8A, Exception taken, Hypervisor Call**

This event is similar to the *Exception taken* event, event 0x09, but the counter counts only Hypervisor Call exceptions. The counter counts for both Hypervisor Call exceptions taken locally in the hypervisor and those taken as an exception from Non-secure PL1.

**0x8B, Exception taken, Prefetch Abort not taken locally**

This event is similar to the *Exception taken* event, event 0x09, but the counter counts only Prefetch Abort exceptions not taken locally.

**0x8C, Exception taken, Data Abort not taken locally**

This event is similar to the *Exception taken* event, event 0x09, but the counter counts only Data Abort exceptions not taken locally.

**0x8D, Exception taken, other hypervisor traps**

This event is similar to the *Exception taken* event, event 0x09, but the counter counts only hypervisor entries, other than those counted as:

- *Exception taken, Hypervisor Call* event, event 0x8A.
- *Exception taken, Prefetch Abort not taken locally* event, event 0x8B.
- *Exception taken, Data Abort not taken locally* event, event 0x8C.
- *Exception taken, IRQ not taken locally* event, event 0x8E.
- *Exception taken, FIQ not taken locally* event, event 0x8F.

**0x8E, Exception taken, IRQ not taken locally**

This event is similar to the *Exception taken* event, event 0x09, but the counter counts only IRQ exceptions not taken locally.

**0x8F, Exception taken, FIQ not taken locally**

This event is similar to the *Exception taken* event, event 0x09, but the counter counts only FIQ exceptions not taken locally.

### C.1.1 Effect of selecting an unused or reserved event number

An implementation that follows these recommendations must not use an event number defined in [Table C-1 on page AppxC-2376](#) for any event other than the event defined in the table.

If an implementation that follows these recommendations does not support the counting of an event listed in [Table C-1 on page AppxC-2376](#), then the corresponding event number is reserved. If the configuration of the event to be counted specifies a reserved event number then the counter never increments. This applies to:

- Any event number that [Table C-1 on page AppxC-2376](#) shows as reserved, including one that is reserved for future extension of these recommendations.
- An event number that does not correspond to an event that the implementation can count. This means either:
  - The number corresponds to an event that the implementation does not support.
  - The number is available for IMPLEMENTATION DEFINED events, but the implementation does not define any event for that number.



## Appendix D

# Example OS Save and Restore Sequences for External Debug Over Powerdown

This appendix gives possible OS Save and Restore sequences for a v7 Debug implementation. It includes the following section:

- [Example OS Save and Restore sequences for v7 Debug on page AppxD-2388](#)
- [Example OS Save and Restore sequences for v7.1 Debug on page AppxD-2392.](#)

## D.1 Example OS Save and Restore sequences for v7 Debug

v7 Debug OS Save and Restore on page C7-2154 described the OS Save and Restore sequence for v7 Debug. The following subsections give examples of using these OS Save and Restore sequences:

- v7 Debug OS Save and Restore sequences using memory-mapped interface, v7 Debug
- v7 Debug OS Save and Restore sequences using the CP14 interface, v7 Debug on page AppxD-2390.

### D.1.1 v7 Debug OS Save and Restore sequences using memory-mapped interface, v7 Debug

On a v7 Debug implementation that includes the OS Save and Restore mechanism and a memory-mapped interface:

- Example D-1 shows the correct sequence for saving the debug logic state, using the memory-mapped interface, before powering down
- Example D-2 on page AppxD-2389 shows the correct sequence for restoring the debug logic state, using the memory-mapped interface, when the system is powered up again.

When the debug logic state is restored, if the `DBGECR.OUCE` bit is set to 1 a debug event is triggered when the `DBGOSLAR` is cleared. This event might be used by an external debugger to restart a debugging session.

#### Example D-1 OS debug register save sequence, memory-mapped interface, v7 Debug

---

; On entry, R0 points to a block of non-volatile storage to save the debug registers in.

```
SaveDebugRegisters
    PUSH    {R4, LR}
    MOV     R4, R0                                ; Save pointer

    ; (1) Set the OS Lock by writing the key value, 0xC5ACCE55, to the DBGOSLAR. This
    ;      also initializes the DBGOSSRR. The architecture requires that DBGOSLAR and
    ;      the other debug registers have at least the Device memory attribute.
    BL     GetDebugRegisterBase                    ; Returns base in R0
    LDR    R1, =0xC5ACCE55
    STR    R1, [R0, #0x300]                        ; Write DBGOSLAR

    ; (2) If using the CP14 interface, execute an ISB instruction. Not applicable.

    ; (3) Perform an initial read of DBGOSSRR. This returns the number of reads of the
    ;      DBGOSSRR that are required to save the entire debug logic state. Record this
    ;      number in the non-volatile storage.
    LDR    R1, [R0, #0x308]                        ; DBGOSSRR returns size
    STR    R1, [R4], #4                            ; Push on to the save stack

    ; (4) Perform additional reads of DBGOSSRR, as indicated in step 3, and record each
    ;      value, in order, in the non-volatile storage.
    CMP    R1, #0                                  ; Check for zero
SaveDebugRegisters_Loop
    ITT    NE
    LDRNE R2, [R0, #0x308]                        ; Load a word of data
    STRNE R2, [R4], #4                            ; Push on to the save stack
    SUBSNE R1, R1, #1
    BNE    SaveDebugRegisters_Loop

    ; (5) Return the pointer to first word not written to. Leave OS Lock set, to prevent
    ;      any further changes to the debug registers.
    MOV    R0, R4
    POP    {R4, PC}
```

---



### Example D-2 OS debug register restore sequence, memory-mapped interface, v7 Debug

; On entry, R0 points to a block of non-volatile storage containing the saved debug registers.

RestoreDebugRegisters

```

PUSH    {R4, LR}
MOV     R4, R0                               ; Save pointer

; (1) Set the OS Lock by writing the key value, 0xC5ACCE55, to the DBGOSLAR. This
;     also initializes the DBGOSSRR.
; The architecture requires that DBGOSLAR and the other debug registers have at
; the Device memory attribute.
BL      GetDebugRegisterBase                 ; Returns base in R0
LDR     R1, =0xC5ACCE55
STR     R1, [R0, #0x300]                     ; Write R1 to DBGOSLAR

; (2) If using the CP14 interface, execute an ISB instruction. Not applicable.

; (3) Read DBGPRSR to clear the Sticky Powerdown status bit.
LDR     R1, [R0, #0x314]

; (4) If using the CP14 interface, execute an ISB instruction. Not applicable.

; (5) Perform an initial read of DBGOSSRR and discard the value returned.
LDR     R1, [R0, #0x308]

; (6) From the non-volatile storage, retrieve the number that was recorded in
;     step 3 of the OS Save sequence. This value indicates the number of writes
;     of DBGOSSRR that are required to restore the entire debug logic state.
LDR     R1, [R4], #4

; (7) Perform a word read from the non-volatile storage and then write the value
;     to DBGOSSRR, and repeat until all the values are read, that step 4 of the
;     OS Save sequence stored.
CMP     R1, #0                               ; Check for zero
RestoreDebugRegisters_Loop
ITTT    NE
LDRNE   R2, [R4], #4                          ; Load a word from the save stack
STRNE   R2, [R0, #0x308]                       ; Store a word of data
SUBSNE  R1, R1, #1
BNE     RestoreDebugRegisters_Loop

; (8) If using the CP14 interface, execute an ISB instruction. Not applicable.

; (9) Clear the OS Lock by writing any non-key value to the DBGOSLAR. Use the
;     zero value in R1.
STR     R1, [R0, #0x300]

; (10) If using the memory-mapped interface, execute a DSB instruction.
DSB

; (11) Execute a context synchronization operation before using the debug
;     registers.
ISB

; (12) Return the pointer to first word not read.
MOV     R0, R4
POP     {R4, PC}

```

## D.1.2 v7 Debug OS Save and Restore sequences using the CP14 interface, v7 Debug

On a v7 Debug implementation that includes the OS Save and Restore mechanism and the CP14 interface:

- [Example D-3](#) shows the correct sequence for saving the debug logic state, using the CP14 interface, before powering down
- [Example D-4](#) shows the correct sequence, using the CP14 interface, for restoring the debug logic state when the system is powered up again.

When the debug logic state is restored, if the [DBGECR.OUCE](#) bit is set to 1 a debug event is triggered when the OS Lock is cleared. This event might be used by an external debugger to restart a debugging session.

### Example D-3 OS debug register save sequence, CP14 interface, v7 Debug

---

```
; On entry, R0 points to a block of non-volatile storage to save the debug registers in.

SaveDebugRegisters
; (1) Set the OS Lock by writing the key value, 0xC5ACCE55, to the DBGOSLAR. This
;     also initializes the DBGOSSRR.
LDR    R1, =0xC5ACCE55
MCR    p14, 0, R1, c1, c0, 4      ; Write R1 to DBGOSLAR

; (2) If using the CP14 interface, execute an ISB instruction.
ISB

; (3) Perform an initial read of DBGOSSRR. This returns the number of reads of the
;     DBGOSSRR that are required to save the entire debug logic state. Record this
;     number in the non-volatile storage.
MRC    p14, 0, R1, c1, c2, 4      ; DBGOSSRR returns size
STR    R1, [R0], #4              ; Push on to the save stack

; (4) Perform additional reads of DBGOSSRR, as indicated in step 3, and record each
;     value, in order, in the non-volatile storage.
CMP    R1, #0                    ; Check for zero
SaveDebugRegisters_Loop
ITTT   NE
MRCNE  p14, 0, R2, c1, c2, 4      ; Load a word of data
STRNE  R2, [R0], #4              ; Push on to the save stack
SUBSNE R1, R1, #1
BNE    SaveDebugRegisters_Loop

; (5) Return the pointer to first word not written to. Leave OS Lock set, to prevent
;     any further changes to the debug registers.
BX     LR
```

---

### Example D-4 OS debug register restore sequence, CP14 interface, v7 Debug

---

; On entry, R0 points to a block of non-volatile storage containing the saved debug registers.

```
RestoreDebugRegisters

; (1) Set the OS Lock by writing the key value, 0xC5ACCE55, to the DBGOSLAR. This
;     also initializes the DBGOSSRR.
LDR    R1, =0xC5ACCE55
MCR    p14, 0, R1, c1, c0, 4      ; Write R1 to DBGOSLAR

; (2) If using the CP14 interface, execute an ISB instruction.
ISB
```

```
; (3) Read DBGPRSR to clear the Sticky Powerdown status bit.
MRC    p14, 0, R1, c1, c5, 4

; (4) If using the CP14 interface, execute an ISB instruction.
ISB

; (5) Perform an initial read of DBGOSRR and discard the value returned.
MRC    p14, 0, R1, c1, c2, 4

; (6) From the non-volatile storage, retrieve the number that was recorded in
;      step 3 of the OS Save sequence. This value indicates the number of writes
;      of DBGOSRR that are required to restore the entire debug logic state.
LDR    R1, [R0], #4

; (7) Perform a word read from the non-volatile storage and then write the value
;      to DBGOSRR, and repeat until all the values are read, that step 4 of the
;      OS Save sequence stored.
CMP    R1, #0                ; Check for zero
RestoreDebugRegisters_Loop
ITTT   NE
LDRNE  R2, [R0], #4          ; Load a word from the save stack
MCRNE  p14, 0, R2, c1, c2, 4 ; Write R2 to DBGOSRR to store a data word
SUBSNE R1, R1, #1
BNE    RestoreDebugRegisters_Loop

; (8) If using the CP14 interface, execute an ISB instruction.
ISB

; (9) Clear the OS Lock by writing any non-key value to the DBGOSLAR. Use the
;      zero value in R1.
MCR    p14, 0, R1, c1, c0, 4

; (10) If using the memory-mapped interface, execute a DSB instruction. Not
;       applicable.

; (11) Execute a context synchronization operation before using the debug
;       registers.
ISB

; (7) Return the pointer to first word not read. This pointer is already in R0,
;      so all that is needed is to return from this function.
BX    LR
```

---

## D.2 Example OS Save and Restore sequences for v7.1 Debug

On a v7.1 Debug implementation:

- [Example D-5](#) shows the correct sequence for saving the debug logic state, using the CP14 interface, before powering down
- [Example D-6 on page AppxD-2393](#) shows the correct sequence, using the CP14 interface, for restoring the debug logic state when the system is powered up again.

### ———— Note ————

Because all v7.1 Debug implementations support OS Save and Restore using the CP14 interface, this section does not include any OS Save and Restore examples using a memory-mapped interface.

### Example D-5 OS debug register save sequence, CP14 interface, v7.1 Debug

;; On entry, R0 points to a block of non-volatile storage to save the debug registers in.

```
SaveDebugRegisters
    ; (1) Set OS Lock by writing the key value, 0xC5ACCE55, to DBGOSLAR.
    LDR    R2, =0xC5ACCE55
    MCR    p14, 0, R2, c1, c0, 4          ; Write DBGOSLAR

    ; (2) Execute an ISB instruction.
    ISB

    ; (3) Walk through the registers, listed in "The debug logic state to preserve over a
    ;     powerdown" and save the values to the non-volatile storage.
    ; (a) Miscellaneous
    MRC    p14, 0, R1, c0, c0, 2          ; Read DBGDTRRText
    MRC    p14, 0, R2, c0, c3, 2          ; Read DBGDTRTText
    MRC    p14, 0, R3, c0, c2, 2          ; Read DBGDSCRText
    STM    R0!, {R1-R3}                  ; Save { DTRRText, DTRTText, DSCR }
    MRC    p14, 0, R1, c0, c6, 0          ; Read DBGWFAR
    MRC    p14, 0, R2, c0, c7, 0          ; Read DBGVCR
    MRC    p14, 0, R3, c7, c9, 6          ; Read CLAIM through DBGCLAIMCLR
    STM    R0!, {R1-R3}                  ; Save { WFAR,VCR,CLAIM }

    ;;      Macro for saving a breakpoint or watchpoint "register pair".
    MACRO
    SaveRP $num, $opc2vr, $opc2cr
    CMP    R1, #$num
    MRCLE  p14, 0, R2, c0, $num, $opc2vr  ; Read DBGxVRn
    MRCLE  p14, 0, R3, c0, $num, $opc2cr  ; Read DBGxCRn
    STMLE  R0!, {R2-R3}                  ; Save { xVRn,xCRn }
    MEND

    ;;      Macro for saving a Breakpoint Extended Value Register
    MACRO
    SaveXR $num
    CMP    R1, #$num
    BGT    SaveDebugRegisters_SkipBXVRs
    CMP    R2, #$num
    MRCGE  p14, 0, R3, c1, $num, 1        ; Read DBGXBVRn
    STRGE  R3, [R0], #4                  ; Save { DBGXBVRn }
    MEND

    ; (b) Breakpoints
    MRC    p14, 0, R1, c7, c2, 7          ; Read DBGDEVID
    UBFX   R1, R1, #16, #4               ; Extract VirtExtns field
    CMP    R1, #0
    BEQ    SaveDebugRegisters_SkipBXVRs
```

```

MRC    p14, 0, R1, c0, c0, 0      ; Read DBGDIDR
UBFX   R2, R1, #20, #4            ; Extract CTX_CMPs field
UBFX   R1, R1, #24, #4            ; Extract BRPs field
SUB    R2, R1, R2                 ; R2 = index of first

SaveXR 0
SaveXR 1
SaveXR 2
;; ... and so on up to ...
SaveXR 15

```

```

SaveDebugRegisters_SkipBXVRs
SaveRP 0, 4, 5
SaveRP 1, 4, 5
SaveRP 2, 4, 5
;; ... and so on up to ...
SaveRP 15, 4, 5

```

```

SaveDebugRegisters_Watchpoints
; (c) Watchpoints
MRC    p14, 0, R1, c0, c0, 0      ; Read DBGDIDR
UBFX   R1, R1, #28, #4            ; Extract WRPs field

SaveRP 0, 6, 7
SaveRP 1, 6, 7
SaveRP 2, 6, 7
;; ... and so on up to ...
SaveRP 15, 6, 7

```

; (4) Return the pointer to first word not written to. Leave the OS Lock set, to prevent any changes to the debug registers.

; Before removing power from the core power domain, software must:  
; (i) Set the OS Double Lock, by writing 1 to DBGOSDLR.DLK.  
; (ii) Execute a context synchronization operation  
BX LR

---

### Example D-6 OS debug register restore sequence, CP14 interface, v7.1 Debug

---

;; On entry, R0 points to a block of non-volatile storage containing the saved debug registers.

RestoreDebugRegisters

; (1) Set OS Lock by writing the key value, 0xC5ACCE55, to the DBGOSLAR. The lock is set by the core powerup reset, but this ensures it is set.

```

LDR    R1, =0xC5ACCE55
MCR    p14, 0, R1, c1, c0, 4; Write DBGOSLAR

```

; (2) Execute an ISB instruction.  
ISB

; (3) Walk through the registers listed in "The debug logic state to preserve over a powerdown" and restore the values from the non-volatile storage.

```

; (a) Miscellaneous
LDM    R0!, {R1-R3}              ; Read { DTRRXext,DTRTXext DSCR }
MCR    p14, 0, R1, c0, c0, 2      ; Restore DBGDTRRXext
MCR    p14, 0, R2, c0, c3, 2      ; Restore DBGDTRTXext
MCR    p14, 0, R3, c0, c2, 2      ; Restore DBGDSCRext
LDM    R0!, {R1-R3}              ; Read { WFAR,VCR,CLAIM }
MCR    p14, 0, R1, c0, c6, 0      ; Restore DBGWFAR
MCR    p14, 0, R2, c0, c7, 0      ; Restore DBGVCR
MCR    p14, 0, R3, c7, c8, 6      ; Restore CLAIM tags through DBGCLAIMSET

```

```

;; Macro for restoring a breakpoint or watchpoint "register pair"
MACRO

```

```

RestRP $num, $opc2vr, $opc2cr
CMP    R1, # $num
LDMLE  R0!, {R2-R3}                ; Read { xVRn,xCRn }
MCRLE  p14, 0, R2, c0, $num, $opc2vr ; Restore DBGxVRn
MCRLE  p14, 0, R3, c0, $num, $opc2cr ; Restore DBGxCRn
MEND

;;      Macro for restoring a Breakpoint Extended Value Register
MACRO
RestXR $num
CMP    R1, # $num
BGT    RestoreDebugRegisters_SkipBXVRs
CMP    R2, # $num
LDRGE  R3, [R0], #4                ; Read { DBGxVRn }
MCRGE  p14, 0, R3, c1, $num, 1     ; Restore DBGxVRn
MEND

; (b) Breakpoints
MRC    p14, 0, R1, c7, c2, 7       ; Read DBGDEVID
UBFX   R1, R1, #16, #4              ; Extract VirtExtns field
CMP    R1, #0
BEQ    RestoreDebugRegisters_SkipBXVRs

MRC    p14, 0, R1, c0, c0, 0       ; Read DBGDIDR
UBFX   R2, R1, #20, #4              ; Extract CTX_CMPs field
UBFX   R1, R1, #24, #4              ; Extract BRPs field
SUB    R2, R1, R2                  ; R2 = index of first

RestXR 0
RestXR 1
RestXR 2
;; ... and so on up to ...
RestXR 15

RestoreDebugRegisters_SkipBXVRs
RestRP 0, 4, 5
RestRP 1, 4, 5
RestRP 2, 4, 5
;; ... and so on up to ...
RestRP 15, 4, 5

RestoreDebugRegisters_Watchpoints
; (c) Watchpoints
MRC    p14, 0, R1, c0, c0, 0       ; Read DBGDIDR
UBFX   R1, R1, #28, #4              ; Extract WRPs field

RestRP 0, 6, 7
RestRP 1, 6, 7
RestRP 2, 6, 7
;; ... and so on up to ...
RestRP 15, 6, 7

; (4) Execute an ISB instruction.
ISB

; (5) Clear the OS Lock by writing any non-key value to the DBGOSLAR.
MCR    p14, 0, R1, c1, c0, 4; Write DBGOSLAR

; (6) Execute a final Context synchronization operation.
ISB

; (7) Return the pointer to first word not read. This pointer is already in R0, so
;     all that is needed is to return from this function.
BX    LR

```

# Appendix E

## System Level Implementation of the Generic Timer

This appendix defines the system level implementation of the OPTIONAL Generic Timer. It contains the following sections:

- *About the Generic Timer specification* on page AppxE-2396
- *Memory-mapped counter module* on page AppxE-2397
- *Counter module control and status register summary* on page AppxE-2400
- *About the memory-mapped view of the counter and timer* on page AppxE-2402
- *The CNTBaseN and CNTPL0BaseN frames* on page AppxE-2403
- *The CNTCTLBase frame* on page AppxE-2405
- *System level Generic Timer register descriptions, in register order* on page AppxE-2406
- *Providing a complete set of counter and timer features* on page AppxE-2423
- *Gray-count scheme for timer distribution scheme* on page AppxE-2425.

Chapter B8 *The Generic Timer* gives a general description of the Generic Timer, and describes the system control register interface to the Generic Timer.

## E.1 About the Generic Timer specification

[Chapter B8 \*The Generic Timer\*](#) describes the ARM Generic Timer, and its implementation as an OPTIONAL extension to an ARMv7-A or ARMv7-R processor implementation. [Chapter B8](#) included the definition of the low-latency CP15 register interface to the Generic Timer Extension. However, the ARM Generic Timer architecture requires the implementation of some parts of the timer at the system level. This system level implementation includes a memory-mapped interface to the timer that:

- Provides some top-level management of the Generic Timer, that is not available from the CP15 interface from any processor in the system.
- Provides memory-mapped access to Generic Timer features, for system components that cannot implement a CP15 interface to the time. The latency of this memory-mapped access can be significantly higher than the latency of CP15 accesses.

The Generic Timer architecture defines both a counter and a timer. The counter and timer work in combination, but each has a distinct purpose:

- the counter counts the passing of time
- the timer schedules the triggering of events.

See [About the Generic Timer on page B8-1958](#) for more information about the timer and the counter. [Generic Timer example on page B8-1958](#) shows a system-wide implementation of the Generic Timer.

Most of this appendix describes the system level implementation of the Generic Timer. [Gray-count scheme for timer distribution scheme on page AppxE-2425](#) describes a possible scheme for distributing the counter value across this system.

### E.1.1 The memory-mapped view of the Generic Timer

The memory-mapped view of the Generic Timer provides:

- Access to the system level features of the Generic Timer:
  - [Memory-mapped counter module on page AppxE-2397](#) describes these features
  - [Counter module control and status register summary on page AppxE-2400](#) describes the memory-mapped interface to those features.
- Memory-mapped access to the Generic Timer features defined in [Chapter B8 \*The Generic Timer\*](#). This provides memory-mapped access to different views of the system control registers described in that chapter. [About the memory-mapped view of the counter and timer on page AppxE-2402](#) describes this access.



## E.2 Memory-mapped counter module

The memory-mapped counter module provide top-level control of the system counter. It provides:

- An RW control register **CNTCR**, that provides:
  - An enable bit for the system counter.
  - An enable bit for Halt-on-Debug. When this is enabled, if the debug halt signal into the system counter is asserted, it halts the system counter. Otherwise, the system counter ignores the state of this halt signal. For more information about Halt-on-Debug, contact ARM.
  - A field that can be written to request a change to the update frequency of the system counter, with a corresponding change to the increment made at each update. For more information see [Control of counter operating frequency and increment on page AppxE-2398](#).

Writes to this register are rare. In a system that uses security, this register is writable only by Secure writes.

- A RO status register, **CNTSR**, that provides:
  - A bit that indicates whether the system counter is halted because of an asserted Halt-on-Debug signal.
  - A field that indicates the current update frequency of the system counter. This field can be polled to determine when a requested change to the update frequency has been made.
- Two contiguous RW registers that hold the current system counter value, **CNTCV**. If the system supports 64-bit atomic accesses, these two registers must be accessible by such accesses.

The system counter must be disabled before writing to these registers, otherwise the effect of the write is UNPREDICTABLE.

Writes to these registers are rare. In a system that uses security, these registers are writable only by Secure writes.

- A table of one or more 32-bit entries, where:
  - The first entry defines the *base frequency* of the system counter. This is the maximum frequency at which the counter updates.
  - Each subsequent entry defines an alternative frequency of the system counter, and must be an exact divisor of the base frequency.

A 32-bit zero entry immediately follows the last table entry.

This table can be WO or RW. For more information, see [The frequency modes table on page AppxE-2398](#).

- Two contiguous RO registers that hold the current system counter value, **CNTCV**. If the system supports 64-bit atomic accesses, these two registers must be accessible by such accesses.

These registers are located in two memory *frames*, identified by different base addresses:

- the locations of the RO copies of **CNTCV** are defined relative to the CNTReadBase base address
- the locations of all the other registers are defined relative to the CNTControlBase base address.

———— **Note** —————

The final twelve words of the first or only 4KB block of a register memory frame is an ID block.

[Counter module control and status register summary on page AppxE-2400](#) describes CNTReadBase and CNTControlBase memory maps, and the registers in each frame.

## E.2.1 Control of counter operating frequency and increment

The system counter has a fixed *base frequency*, and must maintain the required counter accuracy, meaning ARM recommends that it does not gain or lose more than ten seconds in a 24-hour period, see [System counter on page B8-1959](#). However, the counter can increment at a lower frequency than the base frequency, using a correspondingly larger increment. For example, it can increment by four at a quarter of the base frequency. Any lower-frequency operation, and any switching between operating frequencies, must not reduce the accuracy of the counter.

Control of the system counter frequency and increment is provided only through the memory-mapped counter module. The following sections describe this control:

- [The frequency modes table](#)
- [Changing the system counter frequency and increment on page AppxE-2399](#).

### The frequency modes table

The frequency modes table starts at offset 0x20 from CNTControlBase.

Table entries are 32-bits, and each entry specifies a system counter update frequency, in Hz.

The first entry in the table specifies the base frequency of the system counter.

To ensure overall counter accuracy is maintained, any subsequent entries in the table must be exact divisors of the base frequency. That is, ARM strongly recommends that all frequency values in the table are integer power-of-two divisors of the base frequency.

When the system timer is operating at a lower frequency than the base frequency, the increment applied at each counter update is given by:

$$\text{increment} = (\text{base\_frequency}) / (\text{selected\_frequency})$$

A 32-bit word of zero value marks the end of the table. That is, the word of memory immediately after the last entry in the table must be zero.

The only required entry in the table is the entry for the base frequency.

Typically, the frequency modes table will be in read-only memory. However, a system implementation might use read/write memory for the table, and initialize the table entries as part of its start-up sequence. Therefore, the CNTControlBase memory map shows the table region as RO or RW.

ARM strongly recommends that the frequency modes table is not updated once the system is running.

The architecture can support up to 24 entries in the frequency modes table, and the maximum number of entries is IMPLEMENTATION DEFINED, up to this limit.

#### ———— **Note** —————

ARM believes that implementations will require significantly fewer entries than the architectural limit.

---

## Changing the system counter frequency and increment

The `CNTCR.FREQ` field defines which frequency modes table entry specifies the system counter update frequency. A single bit in the `FREQ` is set to 1, and that bit specifies the entry.

Changing the value of `CNTCR.FREQ` requests a change to the system counter update frequency. To ensure the frequency change does not affect the overall accuracy of the counter, it is made as follows:

- When changing from a higher frequency to a lower frequency, the counter:
  1. continues running at the higher frequency until the count reaches an integer multiple of the required lower frequency
  2. switches to operating at the lower frequency.
- When changing from a lower frequency to a higher frequency, the counter:
  1. waits until the end of the current lower-frequency cycle
  2. makes the counter increment required for operation at that lower frequency
  3. switches to operating at the higher frequency.

When the frequency has changed, `CNTSR` is updated to indicate the new frequency. Therefore, a system component that is waiting for a frequency change can poll `CNTSR` to detect the change.

### E.3 Counter module control and status register summary

The Counter module control and status registers are memory-mapped registers in the following register memory frames:

- a control frame, with base address CNTControlBase
- a status frame, with base address CNTReadBase.

Each of these register memory frames is at least 4KB in size, or is at least the size of the memory protection granule if this granule size is larger than 4KB. Similarly, each base address must be aligned to 4KB, or to the memory protection granule if that is larger than 4KB.

———— **Note** —————

The memory protection granule is either 4KB or 64KB.

In each register memory frame, the memory at offset 0xFD0-0xFFF is reserved for twelve 32-bit IMPLEMENTATION DEFINED ID registers, see the [CounterIDn](#) register descriptions for more information.

The counter is assumed to be little-endian.

In an implementation that supports Secure and Non-secure memory spaces, CNTControlBase is implemented only in the Secure memory space.

[Table E-1](#) shows the CNTControlBase control registers, in order of their offsets from CNTControlBase.

[System level Generic Timer register descriptions, in register order on page AppxE-2406](#) describes each of these registers.

**Table E-1 CNTControlBase memory map**

Offset	Name	Type	Description
0x000	<a href="#">CNTCR</a>	RW	Counter Control Register.
0x004	<a href="#">CNTSR</a>	RO	Counter Status Register.
0x008	<a href="#">CNTCV[31:0]</a>	RW	Counter Count Value register.
0x00C	<a href="#">CNTCV[63:32]</a>	RW	
0x010-0x01C	-	UNK/SBZP	Reserved.
0x020	CNTFID0	RO or RW	Frequency modes table, and end marker.
0x020+4n	CNTFIDn	RO or RW	CNTFID0 is the base frequency, and each CNTFIDn is an alternative frequency. For more information see <a href="#">The frequency modes table on page AppxE-2398</a> .
0x024+4n	-	RO or RW	
(0x024+4n)-0x0BC	-	UNK/SBZP	Reserved.
0x0C0-0x0FC	-	IMPLEMENTATION DEFINED	Reserved for IMPLEMENTATION DEFINED registers.
0x100-0xFCC	-	UNK/SBZP	Reserved.
0xFD0-0xFFC	<a href="#">CounterIDn</a>	RO	Counter ID registers 0-11.

Table E-2 shows the CNTReadBase control registers, in order of their offsets from CNTReadBase.

System level Generic Timer register descriptions, in register order on page AppxE-2406 describes each of these registers.

**Table E-2 CNTReadBase memory map**

Offset	Name	Type	Description
0x000	CNTCV[31:0]	RO	Counter Count Value register
0x004	CNTCV[63:32]	RO	
0x008-0xFCC	-	UNK/SBZP	Reserved
0xFD0-0xFFC	CounterIDn	RO	Counter ID registers 0-11

## E.4 About the memory-mapped view of the counter and timer

To provide the Generic Timer functionality to any programmable system components that cannot implement a coprocessor interface to the Generic Timer, the Generic Timer specification defines a memory-mapped component that can be placed close to such a component. ARM recommends that the system implementation includes an instance of this memory-mapped structure for each system component requiring memory-mapped access to the Generic Timer.

The memory map consists of up to 8 timer *frames*. Each timer frame:

- Provides its own set of timers and associated timer output signals.

———— **Note** —————

A timer output signal can be used as a level-sensitive interrupt signal.

- Is in its own memory protection region that is:
  - in its own memory protection region, with a system-defined size of 4KB or 64KB
  - at a start address that is aligned to 4KB.

———— **Note** —————

The 4KB alignment requirement applies regardless of the memory protection region size.

The base address of a frame is  $CNTBaseN$ , where  $N$  numbers from 0 up to a maximum permitted value of 7.

The system provides a second view of each implemented  $CNTBaseN$  frame. The base address of the second view of the  $CNTBaseN$  frame is  $CNTPL0BaseN$ , and in this view:

- all registers visible in  $CNTBaseN$  are visible, except for [CNTVOFF](#) and [CNTPL0ACR](#)
- the offsets of all visible registers are the same as their offsets in the  $CNTBaseN$  frame.

In addition, the system provides a control frame at base address  $CNTCTLBase$ .

The memory protection region and alignment requirements for the  $CNTPL0BaseN$  and  $CNTCTLBase$  frames are the same as the requirements for the  $CNTBaseN$  frames.

The system defines the position of each frame in the memory map. This means the values of each of the  $CNTBaseN$ ,  $CNTPL0BaseN$ , and  $CNTCTLBase$  base addresses is IMPLEMENTATION DEFINED.

The memory-mapped timers are assumed to be little-endian.

The following sections describe the implementation of a memory-mapped view of the counter and timer:

- [The  \$CNTBaseN\$  and  \$CNTPL0BaseN\$  frames on page AppxE-2403](#)
- [The  \$CNTCTLBase\$  frame on page AppxE-2405](#)
- [Providing a complete set of counter and timer features on page AppxE-2423.](#)

## E.5 The CNTBaseN and CNTPL0BaseN frames

Table E-3 shows the CNTBaseN registers, in order of their offsets from CNTBaseN. Whether a frame includes a virtual timer is IMPLEMENTATION DEFINED. If it does not then memory at offsets 0x030-0x03C is RAZ/WI. Except for CNTPL0ACR and the CounterIDn registers, these registers are also implemented in the system control register interface to the Generic Timer.

*System level Generic Timer register descriptions, in register order on page AppxE-2406 describes each of these registers.*

**Table E-3 CNTBaseN memory map**

Offset	Register, VMSA	Type	Description
0x000	CNTPCT[31:0] <sup>a</sup>	RO	Physical Count register
0x004	CNTPCT[63:32] <sup>a</sup>	RO	
0x008	CNTVCT[31:0] <sup>a</sup>	RO	Virtual Count register
0x00C	CNTVCT[63:32] <sup>a</sup>	RO	
0x010	CNTRFQ <sup>a</sup>	RO <sup>b</sup>	Counter Frequency register
0x014	CNTPL0ACR	RW <sup>c</sup>	Counter PL0 Access Control Register, optional in the CNTBaseN memory map
0x018	CNTVOFF[31:0] <sup>a</sup>	RO <sup>d</sup>	Virtual Offset register, Virtualization Extensions
0x01C	CNTVOFF[63:32] <sup>a</sup>	RO <sup>d</sup>	
0x020	CNTP_CVAL[31:0] <sup>a</sup>	RW	PL1 Physical Timer CompareValue register
0x024	CNTP_CVAL[63:32] <sup>a</sup>	RW	
0x028	CNTP_TVAL <sup>a</sup>	RW	PL1 Physical TimerValue register
0x02C	CNTP_CTL <sup>a</sup>	RW	PL1 Physical Timer Control register
0x030	CNTV_CVAL[31:0] <sup>a</sup>	RW <sup>c</sup>	Virtual Timer CompareValue register, optional in the CNTBaseN memory map
0x034	CNTV_CVAL[63:32] <sup>a</sup>	RW <sup>c</sup>	
0x038	CNTV_TVAL <sup>a</sup>	RW <sup>c</sup>	Virtual TimerValue register, optional in the CNTBaseN memory map
0x03C	CNTV_CTL <sup>a</sup>	RW <sup>c</sup>	Virtual Timer Control register, optional in the CNTBaseN memory map
0x040-0xFCF	-	UNK/SBZP	Reserved
0xFD0-0xFFC	CounterIDn	RO	Counter ID registers 0-11

- a. These registers are also defined in the CP15 interface to the Generic Timer, and therefore are also described in [Chapter B4 System Control Registers in a VMSA implementation](#) and, for registers other than the CNTVOFF register, in [Chapter B6 System Control Registers in a PMSA implementation](#). The bit assignments of the registers are identical in the CP15 interface and in the memory-mapped system level interface.
- b. But must be writable for initial configuration.
- c. Address is reserved, RAZ/WI if register not implemented
- d. The CNTCTLBase frame includes a RW view of this register.

For any value of N, the layout of the registers in the frame at CNTPL0BaseN is identical to that at CNTBaseN, except that:

- CNTVOFF is not visible, and the memory at 0x018-0x01C is RAZ/WI.
- CNTPL0ACR is never visible, and the memory at 0x014 is always RAZ/WI.
- If implemented in the frame at CNTBaseN, CNTPL0ACR controls whether CNTPCT, CNTVCT, CNTFRQ, the PL1 Physical Timer, and the Virtual Timer registers are visible in the frame at CNTPL0BaseN. If CNTPL0ACR is not implemented then these registers are not visible in the frame at CNTPL0BaseN, and their addresses are RAZ/WI.
- If CNTFRQ is visible it is always RO. That is, it is not RW for initial configuration.

If an implementation supports 64-bit atomic accesses, then CNTPCT, CNTVCT, CNTVOFF, CNTP\_CVAL, and CNTV\_CVAL must be accessible as atomic 64-bit values.



## E.6 The CNTCTLBase frame

The CNTCTLBase frame contains an identification register for the features of the memory-mapped counter and timer implementation, access controls for each CNTBase $N$  frame, and a virtual offset register for frames that implement a virtual timer. Table E-4 shows the CNTCTLBase registers, in order of their offsets from CNTCTLBase. The CNTFRQ and CNTVOFF registers are also implemented in the Secure system control register interface to the Generic Timer.

*System level Generic Timer register descriptions, in register order on page AppxE-2406 describes each of these registers.*

**Table E-4 CNTCTLBase memory map**

Offset	Register	Type	Security	Description
0x000	CNTFRQ <sup>a</sup>	RW	Secure	Counter Frequency register
0x004	CNTNSAR	RW	Secure	Counter Non-Secure Access Register
0x008	CNTTIDR	RO	Both	Counter Timer ID Register
0x00C- 0x03F	-	UNK/SBZP	-	Reserved
0x040+4 $N$ <sup>b</sup>	CNTACR $N$	RW	Configurable <sup>c</sup>	Counter Access Control Register $N$
0x060- 0x07F	-	UNK/SBZP	-	Reserved
0x080+8 $N$ <sup>b</sup>	CNTVOFF $N$ [31:0] <sup>a</sup>	RW <sup>d</sup>	Configurable <sup>c</sup>	Virtual Offset register, optional in the CNTCTLBase memory map
0x084+8 $N$ <sup>b</sup>	CNTVOFF $N$ [63:32] <sup>a</sup>	RW <sup>d</sup>		
0x0C0- 0xFCF	-	UNK/SBZP	-	Reserved
0xFD0- 0xFFC	CounterID $n$	RO	Both	Counter ID registers 0-11

- These registers are also defined in the Secure CP15 interface to the Generic Timer, and therefore are also described in [Chapter B4 System Control Registers in a VMSA implementation](#). The bit assignments of the registers are identical in the CP15 interface and in the memory-mapped system level interface.
- Implemented for each value of  $N$  from 0 to 7.
- The CNTNSAR determines the Non-secure accessibility of the CNTACRs and the CNTVOFFs in the CNTCTLBase frame. For more information, see the register descriptions.
- Address is reserved, RAZ/WI if register not implemented

## E.7 System level Generic Timer register descriptions, in register order

This section describes all of the registers that are implemented in a system level implementation of the Generic Timer.

### E.7.1 CNTACR $n$ , Counter Access Control Register

The CNTACR $n$  characteristics are:

<b>Purpose</b>	Provides top-level access controls for the elements of a timer frame. CNTACR $n$ provides the controls for frame CNTBase $N$ . In addition to the CNTACR $n$ control: <ul style="list-style-type: none"> <li>• CNTNSAR controls whether CNTACR<math>n</math> is accessible from Non-secure state</li> <li>• if frame CNTPL0Base<math>N</math> is implemented, the CNTPL0ACR in frame CNTBase<math>N</math> provides additional controls of accesses to frame CNTPL0Base<math>N</math>.</li> </ul> This register is a Generic Timer register, implemented only in the memory-mapped interface.
<b>Usage constraints</b>	Accessible by Secure accesses. CNTNSAR.NS $n$ determines whether CNTACR $n$ is accessible by Non-secure accesses.
<b>Configurations</b>	Implemented, in the CNTCTLBase frame, only if CNTTIDR.FI $n$ is RAO. An implementation of the counters might not provide configurable access to some or all of the features. In this case, the associated field in the CNTACR $n$ register is: <ul style="list-style-type: none"> <li>• RAZ/WI if access is always denied</li> <li>• RAO/WI if access is always permitted.</li> </ul>
<b>Attributes</b>	32-bit RW registers, that start at offset 0x040. The reset values of the registers are UNKNOWN. Table E-4 on page AppxE-2405 shows the register map of the CNTCTLBase registers.

The CNTACR $n$  bit assignments are:

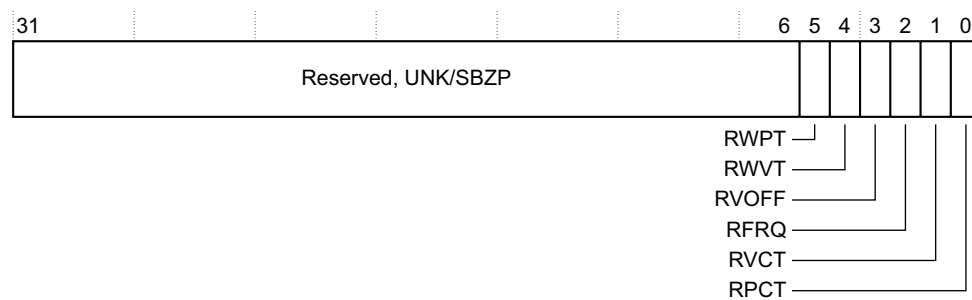

<b>Bits[31:6]</b>	Reserved, UNK/SBZP.
<b>RWPT, bit[5]</b>	Read/write access to the PL1 Physical Timer registers CNTP_CVAL, CNTP_TVAL, and CNTP_CTL, in frame $N$ . The possible values of this bit are: <ul style="list-style-type: none"> <li><b>0</b> No access to the PL1 Physical Timer registers in frame <math>N</math>. The registers are RAZ/WI.</li> <li><b>1</b> Read/write access to the PL1 Physical Timer registers in frame <math>N</math>.</li> </ul>
<b>RWVT, bit[4]</b>	Read/write access to the Virtual Timer registers CNTV_CVAL, CNTV_TVAL, and CNTV_CTL, in frame $N$ . The possible values of this bit are: <ul style="list-style-type: none"> <li><b>0</b> No access to the Virtual Timer registers in frame <math>N</math>. The registers are RAZ/WI.</li> <li><b>1</b> Read/write access to the Virtual Timer registers in frame <math>N</math>.</li> </ul>

**RVOFF, bit[3]**

Read-only access to **CNTVOFF**, in frame *N*. The possible values of this bit are:

**0** No access **CNTVOFF** frame *N*. The register address is RAZ.

**1** Read-only access to **CNTVOFF** in frame *N*.

**RFRQ, bit[2]** Read-only access to **CNTFRQ**, in frame *N*. The possible values of this bit are:

**0** No access **CNTFRQ** in frame *N*. The register address is RAZ.

**1** Read-only access to **CNTFRQ** in frame *N*.

**RVCT, bit[1]** Read-only access to **CNTVCT**, in frame *N*. The possible values of this bit are:

**0** No access **CNTVCT** in frame *N*. The register address is RAZ.

**1** Read-only access to **CNTVCT** in frame *N*.

**RPCT, bit[1]** Read-only access to **CNTPCT**, in frame *N*. The possible values of this bit are:

**0** No access **CNTPCT** in frame *N*. The register address is RAZ.

**1** Read-only access to **CNTPCT** in frame *N*.

## E.7.2 CNTCR, Counter Control Register

The CNTCR characteristics are:

<b>Purpose</b>	Enables the counter, controls the counter frequency setting, and controls counter behavior during debug. This register is a Generic Timer register in the system level Counter module.
<b>Usage constraints</b>	In a system that uses security, this register is writable only by Secure writes.
<b>Configurations</b>	Always implemented, in the CNTControlBase register map.
<b>Attributes</b>	A 32-bit RW register, at offset 0x000. <a href="#">Table E-1 on page AppxE-2400</a> shows the register map of the CNTControlBase registers. See the field descriptions for the reset values.

The CNTCR bit assignments are:

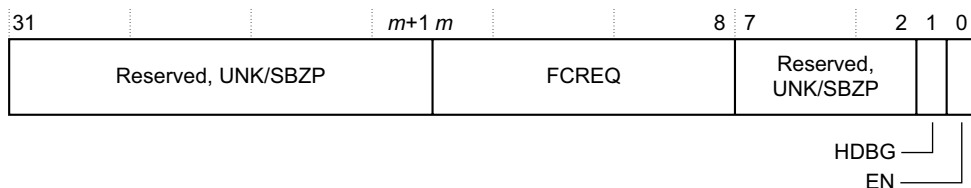

**Bits[31:m+1]** Reserved, UNK/SBZP.

**FCREQ, bits[m:8]** Requested frequency modes table entry.

Only one bit of this field is set to one. If the bit number of that bit is  $n+8$ , then:

- $n$  is the entry number in the frequency modes table
- the entry for  $n=0$  corresponds to the base frequency entry.

**Note**

This description refers to the bit number in the register, not in the FCREQ field. For example, the entry with  $n=0$ , the base frequency entry, is CNTCR[8].

This field resets to zero.

Changing the value of this field requests a change to the update frequency of the system counter. Selecting an unimplemented entry in the frequency modes table, or selecting the zero entry, has no effect on the counter.

For more information, see [Control of counter operating frequency and increment on page AppxE-2398](#).

**Bits[7:2]** Reserved, UNK/SBZP.

**HDBG, bit[1]** Halt-on-debug. Controls whether a Halt-on-debug signal halts the system counter:

- 0** System counter ignores Halt-on-debug.
- 1** Asserted Halt-on-debug signal halts system counter update.

The reset value of this field is UNKNOWN.

**EN, bit[0]** Enables the counter:

- 0** System counter disabled.
- 1** System counter enabled.

This bit resets to 0.

After an change to the FCREQ field, when the system counter switches to the new update frequency, CNTSR.FCACK is updated to indicate the table value for that frequency. That is, CNTSR.FCACK is updated to match the new value written to FCREQ.

### E.7.3 CNTCV, Counter Count Value register

The CNTCV characteristics are:

<b>Purpose</b>	Indicates the current count value. This register is a Generic Timer register in the system level Counter module.
<b>Usage constraints</b>	In a system that uses security, for the writable copy of the register: <ul style="list-style-type: none"> <li>• the register is writable only by Secure writes</li> <li>• the effect of writing the register when the counter is enabled is UNPREDICTABLE.</li> </ul> In an implementation that supports 64-bit atomic memory accesses, this register must be accessible using a 64-bit atomic access.
<b>Configurations</b>	This register is available in two register memory frames: <ul style="list-style-type: none"> <li>• a read/write copy in the CNTControlBase memory map</li> <li>• a read-only copy in the CNTReadBase memory map.</li> </ul>
<b>Attributes</b>	A 64-bit register, at offset: <ul style="list-style-type: none"> <li>• 0x008 in the CNTControlBase memory map. This means the most significant word of the register is at offset 0x00C in this memory map.</li> <li>• 0x000 in the CNTReadBase memory map. This means the most significant word of the register is at offset 0x004 in this memory map.</li> </ul> <p><a href="#">Table E-1 on page AppxE-2400</a> shows the register map of the CNTControlBase registers. CNTCV is RW in this memory frame.</p> <p><a href="#">Table E-2 on page AppxE-2401</a> shows the register map of the CNTReadBase registers. CNTCV is RO in this memory frame.</p>

In an ARMv7 implementation, the CNTCV bit assignments are:

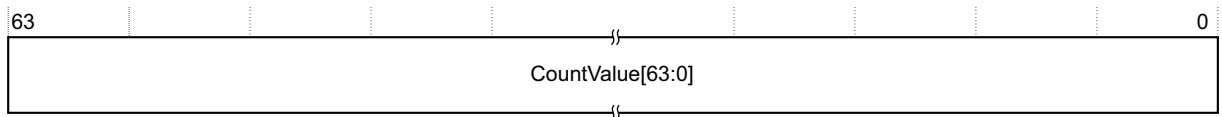

**CountValue, bits[63:0]**

Indicates the counter value.

## E.7.4 CNTFRQ, Counter Frequency register, system level

The CNTFRQ register characteristics are:

<b>Purpose</b>	The CNTFRQ register indicates the clock frequency of the system counter. This register is a Generic Timer register.
<b>Usage constraints</b>	See the <i>Attributes</i> description.
<b>Configurations</b>	See the <i>Attributes</i> description. The VMSA, PMSA, and system level definitions of the register fields are identical.
<b>Attributes</b>	A 32-bit register with an UNKNOWN reset value, implemented: <ul style="list-style-type: none"><li>In the CNTBaseN frame at offset 0x010. CNTFRQ is RO in the CNTBaseN frame, but must be writable for initial configuration. <a href="#">Table E-3 on page AppxE-2403</a> shows the register map of the CNTBaseN registers.</li><li>In the CNTCTLBase frame at offset 0x000. CNTFRQ is RW in the CNTCTLBase frame, and in a system that uses security, is accessible only by Secure accesses. <a href="#">Table E-4 on page AppxE-2405</a> shows the register map of the CNTCTLBase registers.</li></ul>

The CNTFRQ bit assignments are:

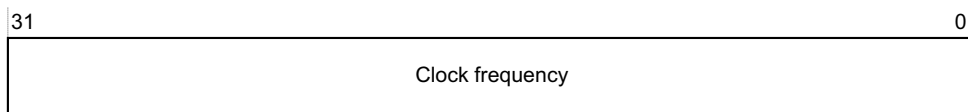

### Clock frequency, bits[31:0]

Indicates the system counter clock frequency, in Hz.

#### ———— **Note** ————

Programming CNTFRQ does not affect the system clock frequency. However, on system initialization, CNTFRQ must be correctly programmed with the system clock frequency, to make this value available to software. For more information see [Initializing and reading the system counter frequency on page B8-1959](#).

## E.7.5 CNTNSAR, Counter Non-Secure Access Register

The CNTNSAR characteristics are:

**Purpose** Provides the highest-level control of whether frames CNTBase $N$  and CNTPL0Base $N$  are accessible by Non-secure accesses.

———— **Note** ————

If frame  $N$  is not accessible to Non-secure accesses, then in the CNTCTLBase frame CNTACR $N$  and CNTVOFF $N$  are not accessible to Non-secure accesses.

This register is a Generic Timer register, visible only in the memory-mapped interface.

**Usage constraints** Accessible only by Secure accesses.

**Configurations** Always implemented, in the CNTCTLBase frame, in any memory-mapped view of the timers and counters.

**Attributes** A 32-bit RW register, at offset 0x004. The reset value of the register is UNKNOWN. [Table E-4 on page AppxE-2405](#) shows the register map of the CNTCTLBase registers.

The CNTNSAR bit assignments are:

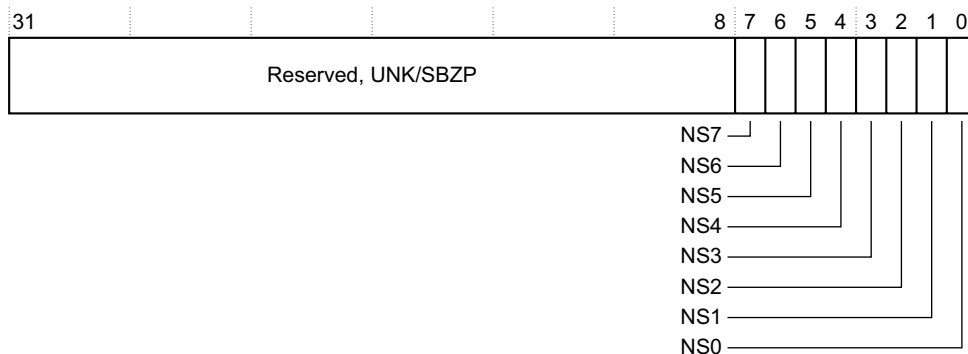

**Bits[31:8]** Reserved, UNK/SBZP.

**NS $N$ , bit[ $N$ ], for values of  $N$  from 0 to 7**

Non-secure access to frame  $n$ . The possible values of this bit are:

- 0** Secure access only:
  - frames CNTBase $N$  and CNTPL0Base $N$  behave as RAZ/WI to Non-secure accesses
  - in the CNTCTLBase frame, CNTACR $N$  and CNTVOFF $N$  behave as RAZ/WI to Non-secure accesses.
- 1** Secure and Non-secure accesses permitted, to:
  - frames CNTBase $N$  and CNTPL0Base $N$
  - in the CNTCTLBase frame, CNTACR $N$  and CNTVOFF $N$ .

If frame CNTBase $n$ :

- is not implemented, NS $n$  is RAZ/WI
- is not Configurable access, and is accessible only by Secure accesses, NS $n$  is RAZ/WI
- is not Configurable access, and is accessible only by Non-secure accesses, NS $n$  is RAO/WI.

### E.7.6 CNTP\_CTL, PL1 Physical Timer Control register, system level

The CNTP\_CTL characteristics are:

- Purpose** The control register for the physical timer.  
This register is a Generic Timer register.
- Usage constraints** [CNTACR.RWPT](#) enables access to this register.
- Configurations** Always implemented, in the CNTBaseN register map.  
The VMSA, PMSA, and system level definitions of the register fields are identical.
- Attributes** A 32-bit RW register at offset 0x02C, with an UNKNOWN reset value.  
[Table E-3 on page AppxE-2403](#) shows the register map of the CNTBaseN registers.

In an ARMv7 implementation, the CNTP\_CTL bit assignments are:

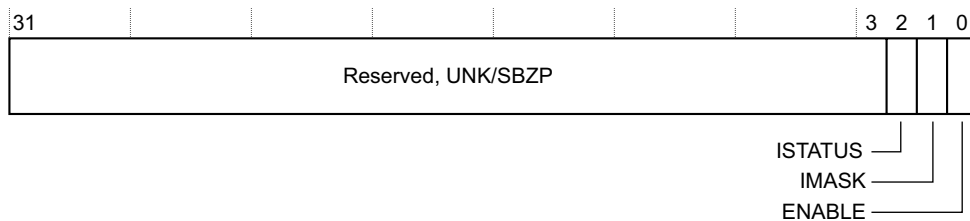

- Bits[31:3]** Reserved, UNK/SBZP.
- ISTATUS, bit[2]** The status of the timer. This bit indicates whether the timer condition is asserted:
  - 0** Timer condition is not asserted.
  - 1** Timer condition is asserted.

When the ENABLE bit is set to 1, ISTATUS indicates whether the timer value meets the condition for the timer output to be asserted, see [Operation of the CompareValue views of the timers on page B8-1964](#) and [Operation of the TimerValue views of the timers on page B8-1965](#). ISTATUS takes no account of the value of the IMASK bit. If ISTATUS is set to 1 and IMASK is set to 0 then the timer output signal is asserted.

This bit is read-only.
- IMASK, bit[1]** Timer output signal mask bit. Permitted values are:
  - 0** Timer output signal is not masked.
  - 1** Timer output signal is masked.

For more information, see the description of the ISTATUS bit and [Operation of the timer output signal on page B8-1966](#).
- ENABLE, bit[0]** Enables the timer. Permitted values are:
  - 0** Timer disabled.
  - 1** Timer enabled.

Setting this bit to 0 disables the timer output signal, but the timer value accessible from [CNTP\\_TVAL](#) continues to count down.

**———— Note ————**

Disabling the output signal might be a power-saving option.



### E.7.7 CNTP\_CVAL, PL1 Physical Timer CompareValue register, system level

The CNTP\_CVAL characteristics are:

<b>Purpose</b>	Holds the 64-bit compare value for the PL1 physical timer. This register is a Generic Timer register.
<b>Usage constraints</b>	<a href="#">CNTACR.RWPT</a> enables access to this register. If the implementation supports 64-bit atomic accesses, then the CNTP_CVAL register must be accessible as an atomic 64-bit value.
<b>Configurations</b>	Always implemented, in the CNTBaseN register map. The VMSA, PMSA, and system level definitions of the register fields are identical.
<b>Attributes</b>	A 64-bit RW register at offset 0x020, with an UNKNOWN reset value. <a href="#">Table E-3 on page AppxE-2403</a> shows the register map of the CNTBaseN registers.

In an ARMv7 implementation, the CNTP\_CVAL bit assignments are:

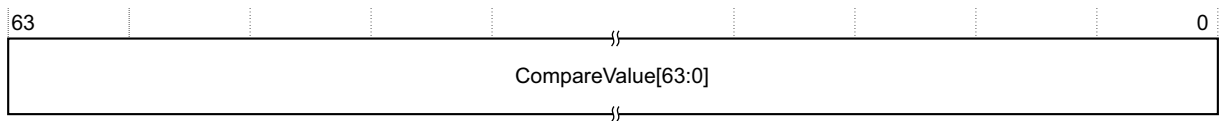

#### CompareValue, bits[63:0]

Indicates the compare value for the PL1 physical timer.

For more information about the timer see [Timers on page B8-1963](#).

### E.7.8 CNTP\_TVAL, PL1 Physical TimerValue register, system level

The CNTP\_TVAL characteristics are:

- Purpose** Holds the timer value for the PL1 physical timer. This provides a 32-bit downcounter, see [Operation of the TimerValue views of the timers on page B8-1965](#).  
This register is a Generic Timer register.
- Usage constraints** CNTACR.RWPT enables access to this register.
- Configurations** Always implemented, in the CNTBaseN register map.  
The VMSA, PMSA, and system level definitions of the register fields are identical.
- Attributes** A 32-bit RW register at offset 0x028, with an UNKNOWN reset value.  
[Table E-3 on page AppxE-2403](#) shows the register map of the CNTBaseN registers.

In an ARMv7 implementation, the CNTP\_TVAL bit assignments are:

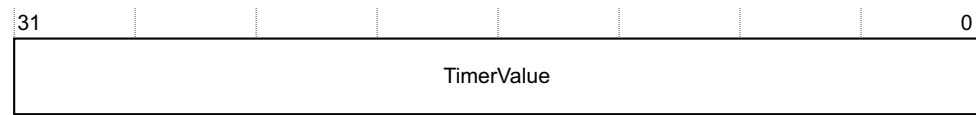

**TimerValue, bits[31:0]**

Indicates the timer value.

### E.7.9 CNTPCT, Physical Count register, system level

The CNTPCT register characteristics are:

- Purpose** The CNTPCT register holds the 64-bit physical count value.  
This register is a Generic Timer register.
- Usage constraints** CNTACR.RPCT enables access to this register  
If the implementation supports 64-bit atomic accesses, then the CNTPCT register must be accessible as an atomic 64-bit value.
- Configurations** Always implemented, in the CNTBaseN register map.  
The VMSA, PMSA, and system level definitions of the register fields are identical.
- Attributes** A 64-bit RO register at offset 0x000, with an UNKNOWN reset value.  
[Table E-3 on page AppxE-2403](#) shows the register map of the CNTBaseN registers.

The CNTPCT bit assignments are:

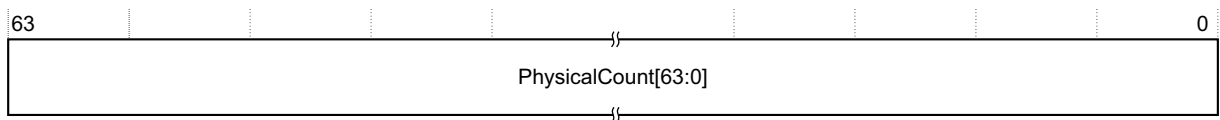

**PhysicalCount, bits[63:0]**

Indicates the physical count.

## E.7.10 CNTPL0ACR, Counter PL0 Access Control Register

The CNTPL0ACR characteristics are:

<b>Purpose</b>	An implementation of CNTPL0ACR in the frame at CNTBaseN controls whether the <a href="#">CNTPCT</a> , <a href="#">CNTVCT</a> , <a href="#">CNTFRQ</a> , PL1 Physical Timer, and Virtual Timer registers are visible in the frame at CNTPL0BaseN.  This register is a Generic Timer register, defined only in the memory-mapped interface.
<b>Usage constraints</b>	No usage constraints.
<b>Configurations</b>	In each implemented CNTBaseN frame, CNTPL0ACR is optional and if not implemented: <ul style="list-style-type: none"> <li>• its location is RAZ/WI</li> <li>• the controlled registers are not visible in the corresponding CNTPL0BaseN frame.</li> </ul>
<b>Attributes</b>	A 32-bit RW register, at offset 0x014. The reset value of the register is UNKNOWN. <a href="#">Table E-3 on page AppxE-2403</a> shows the register map of the CNTBaseN registers.

The CNTPL0ACR bit assignments are:

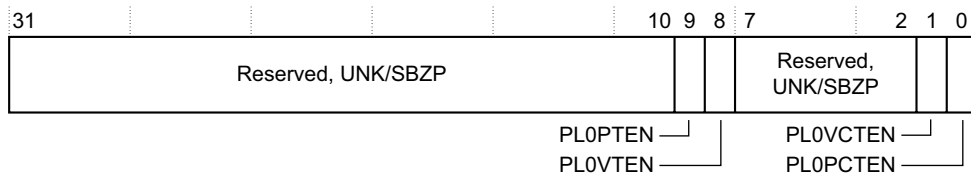

<b>Bits[31:10]</b>	Reserved, UNK/SBZP.
<b>PL0PTEN, bit[9]</b>	Second view read/write access control for the PL1 Physical Timer registers. This bit controls whether the <a href="#">CNTP_CVAL</a> , <a href="#">CNTP_TVAL</a> , and <a href="#">CNTP_CTL</a> registers in the current CNTBaseN frame are also accessible in the corresponding CNTPL0BaseN frame. The possible values of this bit are: <ul style="list-style-type: none"> <li><b>0</b> No access. Registers are RAZ/WI in the second view.</li> <li><b>1</b> Access permitted. If the registers are accessible in the current frame then they are accessible in the second view.</li> </ul>
<b>PL0VTEN, bit[8]</b>	Second view read/write access control for the Virtual Timer registers. This bit controls whether the <a href="#">CNTV_CVAL</a> , <a href="#">CNTV_TVAL</a> , and <a href="#">CNTV_CTL</a> registers in the current CNTBaseN frame are also accessible in the corresponding CNTPL0BaseN frame. The possible values of this bit are: <ul style="list-style-type: none"> <li><b>0</b> No access. Registers are RAZ/WI in the second view.</li> <li><b>1</b> Access permitted. If the registers are accessible in the current frame then they are accessible in the second view.</li> </ul> <p style="text-align: center;"><b>————— Note —————</b></p> <p>The definition of this bit means that, if the Virtual Timer registers are not implemented in the current CNTBaseN frame, then the Virtual Timer register addresses are RAZ/WI in the corresponding CNTPL0BaseN frame, regardless of the value of this bit.</p>
<b>Bits[7:2]</b>	Reserved, UNK/SBZP.
<b>PL0VCTEN, bit[1]</b>	Second view read access control for <a href="#">CNTVCT</a> and <a href="#">CNTFRQ</a> . The possible values of this bit are: <ul style="list-style-type: none"> <li><b>0</b> <a href="#">CNTVCT</a> is not visible in the second view. If PL0PCTEN is set to 0, <a href="#">CNTFRQ</a> is not visible in the second view.</li> <li><b>1</b> Access permitted. If <a href="#">CNTVCT</a> and <a href="#">CNTFRQ</a> are visible in the current frame then they are visible in the second view.</li> </ul>

- PL0PCTEN, bit[0]** Second view read access control for **CNTPCT** and **CNTRFQ**. The possible values of this bit are:
- 0** **CNTPCT** is not visible in the second view.  
If **PL0VCTEN** is set to 0, **CNTRFQ** is not visible in the second view.
  - 1** Access permitted. If **CNTPCT** and **CNTRFQ** are visible in the current frame then they are visible in the second view.

## E.7.11 CNTSR, Counter Status Register

The CNTSR characteristics are:

- Purpose** Provides counter frequency status information.  
 This register is a Generic Timer register in the system level Counter module.
- Usage constraints** There are no usage constraints.
- Configurations** Always implemented, in the CNTControlBase register map.
- Attributes** A 32-bit RO register, at offset 0x004.  
[Table E-1 on page AppxE-2400](#) shows the register map of the CNTControlBase registers.  
 See the field descriptions for the reset values.

In an ARMv7 implementation, the CNTSR bit assignments are:

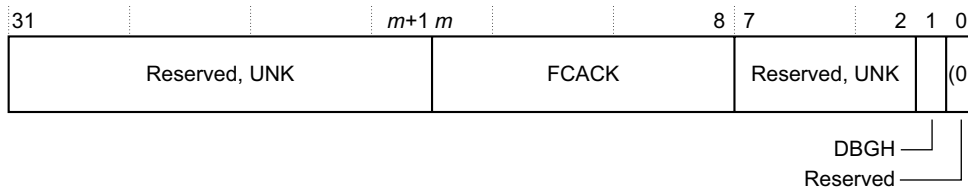

**Bits[31:m+1]** Reserved, UNK. See the FCAACK description for more information about the value of  $m$ .

**FCAACK, bits[m:8]** Frequency change acknowledge. Indicates the current frequency modes table entry.  
 Only one bit of this field is set to one. If the bit number of that bit is CNTSR[ $n+8$ ], then  $n$  is the entry number in the frequency modes table corresponding to the current frequency.

———— **Note** —————

This description refers to the bit number in the register, not in the FCAACK field. For example, the entry with  $n=0$ , the base frequency entry, is CNTSR[8], which is bit[0] of the FCAACK field.

This field provides a bit for each entry in the frequency modes table. Therefore,  $m$  is:

$$7 + (\text{number of entries in the frequency modes table}).$$

The frequency modes table must contain an entry for the base frequency. This means the minimum value of  $m$  is 8, corresponding to a 1-bit FCAACK field.

This field resets to zero.

For more information about the use of this field, see [Control of counter operating frequency and increment on page AppxE-2398](#).

**Bits[7:2]** Reserved, UNK.

**DBGH, bit[1]** Indicates whether the counter is halted because the Halt-on-Debug signal is asserted:

**0** Counter is not halted.

**1** Counter is halted.

The reset value of this bit is UNKNOWN.

**Bit[0]** Reserved, UNK.

### E.7.12 CNTTIDR, Counter Timer ID Register

The CNTTIDR characteristics are:

<b>Purpose</b>	Indicates the implemented timers in the memory map, and their features. For each value of $N$ from 0 to 7 it indicates whether: <ul style="list-style-type: none"> <li>• frame <math>CNTBaseN</math> is a view of an implemented timer</li> <li>• frame <math>CNTBaseN</math> has a second view, <math>CNTPL0BaseN</math></li> <li>• frame <math>CNTBaseN</math> has a virtual timer capability.</li> </ul> This register is a Generic Timer register, visible only in the memory-mapped interface.
<b>Usage constraints</b>	No usage constraints.
<b>Configurations</b>	Always implemented, in the $CNTCTLBase$ frame, in any memory-mapped view of the timers and counters
<b>Attributes</b>	A 32-bit RO register, at offset $0x008$ . The reset value of the register is IMPLEMENTATION DEFINED.

Table E-4 on page AppxE-2405 shows the register map of the  $CNTCTLBase$  registers.

The CNTTIDR bit assignments are:

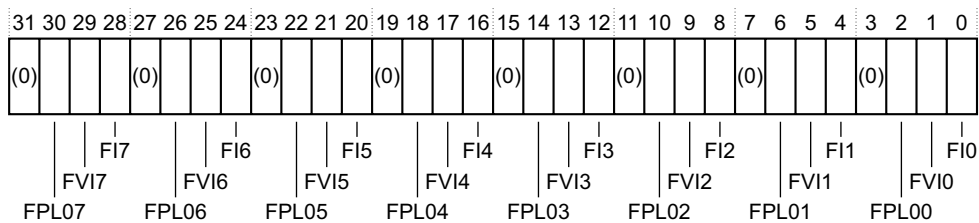

### E.7.13 CNTV\_CTL, Virtual Timer Control register, system level

The CNTV\_CTL characteristics are:

<b>Purpose</b>	The control register for the virtual timer. This register is a Generic Timer register.
<b>Usage constraints</b>	An optional register in a system level implementation of the Generic Timer. <a href="#">CNTTIDR.FVIN</a> indicates whether CNTV_CTL is implemented for frame <i>N</i> . When implemented, <a href="#">CNTACR.RWVT</a> enables access to the register. If CNTV_CTL is not implemented, the register location is RAZ/WI.
<b>Configurations</b>	An optional register in the CNTBase <i>N</i> register map. The VMSA, PMSA, and system level definitions of the register fields are identical.
<b>Attributes</b>	A 32-bit RW register at offset 0x03C, with an UNKNOWN reset value. <a href="#">Table E-3 on page AppxE-2403</a> shows the register map of the CNTBase <i>N</i> registers.

The bit assignments of CNTV\_CTL are identical to those of [CNTP\\_CTL](#).

### E.7.14 CNTV\_CVAL, Virtual Timer CompareValue register, system level

The CNTV\_CVAL characteristics are:

<b>Purpose</b>	Holds the compare value for the virtual timer. This register is a Generic Timer register.
<b>Usage constraints</b>	An optional register in a system level implementation of the Generic Timer. <a href="#">CNTTIDR.FVIN</a> indicates whether CNTV_CVAL is implemented for frame <i>N</i> . When implemented, <a href="#">CNTACR.RWVT</a> enables access to the register. If the implementation supports 64-bit atomic accesses, then the CNTV_CVAL register must be accessible as an atomic 64-bit value. If CNTV_CVAL is not implemented, the register location is RAZ/WI.
<b>Configurations</b>	An optional register in the CNTBase <i>N</i> register map. The VMSA, PMSA, and system level definitions of the register fields are identical.
<b>Attributes</b>	A 64-bit RW register at offset 0x030, with an UNKNOWN reset value. <a href="#">Table E-3 on page AppxE-2403</a> shows the register map of the CNTBase <i>N</i> registers.

The bit assignments of CNTV\_CVAL are identical to those of [CNTP\\_CVAL](#).

### E.7.15 CNTV\_TVAL, Virtual TimerValue register, system level

The CNTV\_TVAL characteristics are:

<b>Purpose</b>	Holds the timer value for the virtual timer. This register is a Generic Timer register.
<b>Usage constraints</b>	An optional register in a system level implementation of the Generic Timer. <a href="#">CNTTIDR.FVIN</a> indicates whether CNTV_TVAL is implemented for frame <i>N</i> . When implemented, <a href="#">CNTACR.RWVT</a> enables access to the register. If CNTV_TVAL is not implemented, the register location is RAZ/WI.
<b>Configurations</b>	An optional register in the CNTBase <i>N</i> register map. The VMSA, PMSA, and system level definitions of the register fields are identical.
<b>Attributes</b>	A 32-bit RW register at offset 0x38, with an UNKNOWN reset value. <a href="#">Table E-3 on page AppxE-2403</a> shows the register map of the CNTBase <i>N</i> registers.

The bit assignments of CNTV\_TVAL are identical to those of [CNTP\\_TVAL](#).

### E.7.16 CNTVCT, Virtual Count register, system level

The CNTVCT characteristics are:

<b>Purpose</b>	Holds the 64-bit virtual count.  <div style="text-align: center;"> <p>———— <b>Note</b> ————</p> <p>The virtual count is obtained by subtracting the virtual offset from the physical count:</p> <ul style="list-style-type: none"> <li>• for a CNTBase<i>N</i> frame that has virtual capacity, <a href="#">CNTVOFF</a> holds the virtual offset</li> <li>• otherwise, the virtual offset is zero.</li> </ul> </div> <p>—————</p> <p>This register is a Generic Timer register.</p>
<b>Usage constraints</b>	<a href="#">CNTACR.RVCT</a> enables access to the CNTVCT register. If the implementation supports 64-bit atomic accesses, then the CNTVCT register must be accessible as an atomic 64-bit value.
<b>Configurations</b>	Always implemented, in the CNTBase <i>N</i> register map. The VMSA, PMSA, and system level definitions of the register fields are identical.
<b>Attributes</b>	A 64-bit RO register at offset 0x008, with an UNKNOWN reset value. <a href="#">Table E-3 on page AppxE-2403</a> shows the register map of the CNTBase <i>N</i> registers.

In an ARMv7 implementation, the CNTVCT bit assignments are:

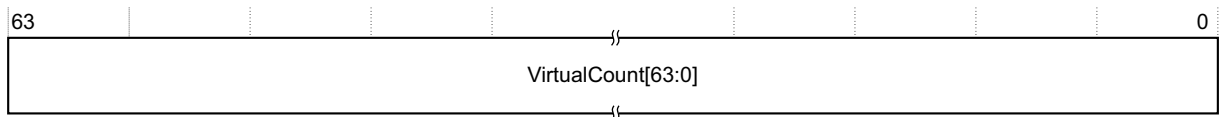

**VirtualCount, bits[63:0]**

Indicates the virtual count.



### E.7.17 CNTVOFF $n$ , Virtual Offset register, system level

The CNTVOFF characteristics are:

- Purpose** Holds the 64-bit virtual offset.  
 This register is a Generic Timer register.
- Usage constraints** If the implementation supports 64-bit atomic accesses, then each CNTVOFF $n$  register must be accessible as an atomic 64-bit value.  
 Accessible by Secure accesses. CNTNSAR.NS $n$  determines whether CNTVOFF $n$  is accessible by Non-secure accesses.  
 See also the *Configurations* and *Attributes* descriptions.

**Configurations** Always implemented as a RO register in the CNTBase $N$  register map. CNTACR.RVOFF enables access to the register.

———— **Note** —————

In a CNTBase $N$  frame that does not have virtual capacity, CNTVOFF is RAZ.

If CNTBase $N$  frame has virtual capacity, indicated by CNTTIDR.FVIN having the value 1, then CNTVOFF $n$  is implemented as a RW register in the CNTCTLBase register map. The CNTCTLBase register map has a RW instance of CNTVOFF for each CNTBase $N$  frame that has virtual capacity.

In the CNTCTLBase register map, unimplemented instances of CNTVOFF are RAZ/WI. The VMSA and system level definitions of the register fields are identical.

- Attributes** A 64-bit register with an UNKNOWN reset value, implemented:
- In the CNTBase $N$  frame at offset 0x018, as a RO register.  
[Table E-3 on page AppxE-2403](#) shows the register map of the CNTBase $N$  registers.
  - In the CNTCTLBase frame as a RW instance for each CNTBase $N$  frame that has virtual capacity. If CNTBase $N$  frame  $N$  has virtual capacity then a RW instance of CNTVOFF is implemented at offset 0x080+8 $N$ .  
[Table E-4 on page AppxE-2405](#) shows the register map of the CNTCTLBase registers.

For a CNTBase $N$  frame that has virtual capacity, the CNTVOFF bit assignments are:

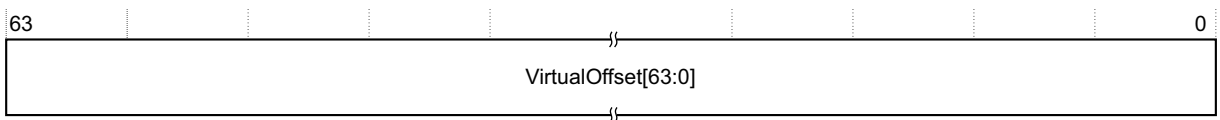

**VirtualOffset, bits[63:0]**

Indicates the virtual offset.

## E.7.18 CounterIDn, Counter ID registers 0-11

The Counter ID register characteristics are:

**Purpose** IMPLEMENTATION DEFINED identification registers, for each register memory frame.  
These registers are Generic Timer registers defined only in memory-mapped interfaces.

**Usage constraints** No usage constraints.

**Configurations** Always implemented, in the CNTControlBase, CNTReadBase, CNTBaseN, and CNTCTLBase memory maps.

———— **Note** —————

These registers are implemented independently in each of the frames accessed through the different memory maps.

**Attributes** 32-bit RO registers, at offsets 0xFD0-0xFFC.

[Table E-1 on page AppxE-2400](#) shows the register map of the CNTControlBase registers.

[Table E-2 on page AppxE-2401](#) shows the register map of the CNTReadBase registers.

[Table E-3 on page AppxE-2403](#) shows the register map of the CNTBaseN registers.

[Table E-4 on page AppxE-2405](#) shows the register map of the CNTCTLBase registers.

The Counter ID registers are IMPLEMENTATION DEFINED registers. If the implementation of the Counter ID registers requires an architecture version, the value for this version of the ARM Generic Timer is version 0.

———— **Note** —————

The Counter ID registers can be implemented as a set of CoreSight ID registers, comprising Peripheral ID Registers and Component ID Registers, as defined by the *CoreSight™ Architecture Specification*. The ARM Debug architecture includes an implementation of the CoreSight ID registers, see:

- [About the Debug Peripheral Identification Registers on page C11-2206](#)
- [About the Debug Component Identification Registers on page C11-2208](#).

Any implementation of the CoreSight ID Registers has a similar organization. However, the Debug architecture implementation uses a Component class value of 0x9. An implementation of these registers for the Generic Timer must use a Component class value of 0xF.

## E.8 Providing a complete set of counter and timer features

Using the general model for implementing a memory-mapped interface to the Generic Timer described in this section, the feature set of a CP15 counter and timer, in a system that supports the Security Extensions and the Virtualization Extensions, can be implemented using the following set of timer frames:

- a CNTCTLBase control frame
- the following CNTBase $N$  timer frames:
  - Frame 0** Accessible from Non-secure state, with second view and virtual capability. This provide the Non-secure PL1&0 timers.
  - Frame 1** Accessible from Non-secure state, with no second view and no virtual capability. This provide the Non-secure PL2 timers.
  - Frame 2** Accessible only Secure state, with a second view but no virtual capability. This provide the Secure PL1&0 timers.

In this implementation, the full set of implemented frames, and their configuration in the memory map, is as follows:

### CNTCTLBase

The control frame. This frame is located in both Secure and Non-secure physical memory, and:

- in the Secure PL1&0 translation regime, this frame is accessible only at PL1
- in the Non-secure PL2 translation regime, this frame is accessible
- in the Non-secure PL1&0 translation regime, this frame is not accessible.

**CNTBase0** The first view of the Non-secure PL1&0 timers. This frame is located only in Non-secure physical memory, and:

- in the Secure PL1&0 translation regime, this frame is accessible only at PL1
- in the Non-secure PL2 translation regime, this frame is accessible
- in the Non-secure PL1&0 translation regime, this frame is accessible only at PL1.

### CNTPL0Base0

The second view of CNTBase0, meaning it is the PL0 view of the Non-secure PL1&0 timers. This frame is located only in Non-secure physical memory, and:

- in the Secure PL1&0 translation regime, this frame can be accessible at PL1, or at PL1 and PL0, but this is not required
- in the Non-secure PL2 translation regime, this frame is accessible
- in the Non-secure PL1&0 translation regime, this frame is accessible at PL1 and PL0.

**CNTBase1** The first and only view of the Non-secure PL2 timers. This frame is located only in Non-secure physical memory, and:

- in the Secure PL1&0 translation regime, this frame is accessible only at PL1
- in the Non-secure PL2 translation regime, this frame is accessible
- in the Non-secure PL1&0 translation regime, this frame is not accessible.

**CNTBase2** The first view of the Secure PL1&0 timers. This frame is located only in Secure physical memory, and:

- in the Secure PL1&0 translation regime, this frame is accessible only at PL1
- because the frame is in Secure memory, it is not accessible in any Non-secure translation regime.

### CNTPL0Base2

The second view of CNTBase2, meaning it is the PL0 view of the Secure PL1&0 timers. This frame is located only in Secure physical memory, and:

- in the Secure PL1&0 translation regime, this frame is accessible at PL1 and PL0
- because the frame is in Secure memory, it is not accessible in any Non-secure translation regime.

———— **Note** —————

[About the VMSA on page B3-1308](#) describes the translation regimes.

---

## E.9 Gray-count scheme for timer distribution scheme

The distribution of the Counter value using a Gray-code provides a relatively simple mechanism to avoid any danger of the count being sampled with an intermediate value even if the clocking is asynchronous. It has a further advantage that the distribution is relatively low power, since only one bit changes on the main distribution wires for each clock tick.

A suitable Gray-coding scheme can be achieved with the following logic:

$$\text{Gray}[N] = \text{Count}[N]$$

$$\text{Gray}[i] = (\text{XOR}(\text{Gray}[N:i+1])) \text{ XOR } \text{Count}[i] \text{ for } N-1 \geq i \geq 0$$

$$\text{Count}[i] = \text{XOR}(\text{Gray}[N:i]) \text{ for } N \geq i \geq 0$$

This is for an N+1 bit counter, where Count is a conventional binary count value, and Gray is the corresponding Gray count value.

### ———— **Note** —————

This scheme has the advantage of being relatively simple to switch, in either direction, between operating with low-frequency and low precision, and operating with high-frequency and high-precision. To achieve this, the ratio of the frequencies must be  $2^n$ , where n is an integer. A switch-over can occur only on the  $2^{(n+1)}$  boundary to avoid losing the Gray-coding property on a switch-over.

---



# Appendix F

## Common VFP Subarchitecture Specification

This appendix describes version 3 of the Common VFP subarchitecture, and the differences in the earlier versions of the Common VFP subarchitecture. It contains the following sections:

- [Scope of this appendix on page AppxF-2429](#)
- [Introduction to the Common VFP subarchitecture on page AppxF-2430](#)
- [Exception processing on page AppxF-2432](#)
- [Support code requirements on page AppxF-2436](#)
- [Context switching on page AppxF-2438](#)
- [Subarchitecture additions to the Floating-point Extension system registers on page AppxF-2439](#)
- [Earlier versions of the Common VFP subarchitecture on page AppxF-2446](#).

---

### Note

- This VFP subarchitecture specification is not part of the ARM architecture specification. Implementers and users of the ARMv7 architecture must not consider this appendix as a requirement of the architecture. It is included as an appendix to this manual only:
    - as reference material for users of ARM floating-point products that implement this subarchitecture
    - as an example of how a floating-point subarchitecture might be implemented.
- The inclusion of this appendix is no indication of whether any ARMv7 floating-point (VFP) implementation by ARM might, or might not, implement this Common VFP subarchitecture. For details of the implemented VFP subarchitecture you must always see the appropriate product documentation.
- The ARM Floating-point Extension was previously called the *VFP Extension*. This common floating-point subarchitecture specification retains the VFP naming.
-

———— **Note** —————

Both [Chapter B4 System Control Registers in a VMSA implementation](#) and [Chapter B6 System Control Registers in a PMSA implementation](#) include the descriptions of the Floating-point system registers. These registers are included in any implementation, VMSA or PMSA, that includes the Floating-point (VFP) Extension. The register bit assignments are identical in VMSA and PMSA implementations, but the register references in this chapter link to the register descriptions in [Chapter B4](#).

---



## F.1 Scope of this appendix

This specification describes the Common VFP subarchitecture. This is not part of the ARMv7 architecture specification, see the *Note* on the cover page of this appendix.

The Common VFP subarchitecture is an interface provided by the Floating-point (VFP) Extension to support code in an operating system.

This appendix is for engineers implementing and validating the Floating-point Extension, and for engineers implementing support code in an operating system.

The main sections of this appendix describe version 3 of the Common VFP subarchitecture. Version 3 is an extension to the previously-published version 2 of the subarchitecture. Version 3 of the Common VFP subarchitecture includes more support for synchronous exception reporting.

For more information about version 2 of the subarchitecture, see [Differences between version 2 and version 3 of the Common VFP subarchitecture on page AppxF-2446](#).

Support code for version 1 of the subarchitecture differs from subarchitecture version 2 only when trapped exception handling of the Inexact exception is enabled. For more information, see [Differences between version 1 and version 2 of the Common VFP subarchitecture on page AppxF-2446](#).

## F.2 Introduction to the Common VFP subarchitecture

The VFP subarchitecture describes the interface to application software provided by an implementation of the ARM Floating-point Extension. A complete implementation of the Floating-point Extension architecture might include both a hardware coprocessor and a software component, called the *support code*. Support code must signal trapped floating-point exceptions to application software, and provide other implementation-dependent functions. The Common VFP subarchitecture describes an interface between the Floating-point Extension and support code.

### F.2.1 Floating-point support code and bounced instructions

Support code is entered through the ARM Undefined Instruction exception vector, when the floating-point hardware does not respond to a floating-point instruction. This software entry is called a *bounce*.

The bounce mechanism supports trapped floating-point exceptions. Trapped floating-point exceptions, called *traps*, are floating-point exceptions that an implementation must pass back for application software to resolve. See [Trapped floating-point exception handling on page AppxF-2435](#).

Support code might perform other tasks, in addition to trap handler calls. These tasks are determined by the implementation. Typically, additional support code functions might handle rare conditions that are either difficult to implement in hardware, or gate-intensive in hardware. This approach permits software behavior to be consistent across implementations with varying degrees of hardware support.

### F.2.2 Exception processing terminology

A condition that causes a floating-point instruction to call support code is called an *exceptional condition*.

The floating-point instruction that contains the floating-point operation requiring support code is called the exception-generating instruction.

The floating-point instruction that causes a bounce to occur is called the trigger instruction.

An implementation can use both synchronous and asynchronous exception signaling:

- if an exception is signaled synchronously, the exception-generating instruction is also the trigger instruction.
- if an exception is signaled asynchronously, the trigger instruction is a floating-point instruction that occurs after the exception-generating instruction.

An implementation can issue and complete additional floating-point instructions before bouncing the trigger instruction.

An implementation can issue a maximum of one additional floating-point instruction that it cannot complete. This instruction is called the bypassed instruction. This instruction is retired in the ARM processor and cannot be reissued. Therefore, it must be executed by the floating-point support code.

### F.2.3 Hardware and software implementation

The Common VFP subarchitecture requires the floating-point hardware implementation to perform completely all load, store and register transfer instructions. These instructions cannot generate floating-point exceptions.

The division of labor between the hardware and software components of a floating-point implementation for CDP operations is IMPLEMENTATION DEFINED.

Typically, the hardware handles all common cases, to optimize performance. When the hardware encounters a case that it cannot handle on its own it calls the software component, the support code for the hardware, to deal with it.

For more information, see [Advanced SIMD and Floating-point Extensions on page A2-54](#).

## F.2.4 Common VFP subarchitecture system registers

The Common VFP subarchitecture adds two instruction registers, [FPINST](#) and [FPINST2](#):

- for asynchronous exceptions, the [FPINST](#) register contains the exception-generating instruction
- the [FPINST2](#) register contains the bypassed instruction, if there is one.

Both instruction registers are optional:

- The [FPINST](#) register is required only if at least one supported configuration can bounce instructions asynchronously.
- The [FPINST2](#) register is required only if the processor can commit to issuing a floating-point instruction before an exceptional case is detected in an earlier floating-point instruction.

The Common VFP subarchitecture adds new fields to the [FPEXC](#) Register:

- the [FPEXC.VECITR](#) field contains an encoding that gives the remaining vector length of the exception-generating instruction
- the [FPEXC.FP2V](#) bit indicates whether the [FPINST2](#) register contains an instruction that the support code must execute
- the [FPEXC.DEX](#) bit is set when a synchronous bounce is caused by a floating-point exception, indicating that the support code must execute the bounced instruction
- the [FPEXC.VV](#) bit is set when a synchronous bounce is caused by a floating-point exception, and the [FPEXC.VECITR](#) field is valid
- an IMPLEMENTATION DEFINED field, for the implementation to give more information about the exceptional condition that caused the bounce.

See [FPEXC, Floating-Point Exception Control register, VMSA on page B4-1567](#) for a description of the minimum implementation of the [FPEXC](#) required by the Floating-point Extension architecture. and [Additions to the Floating-Point Exception Register, FPEXC on page AppxF-2439](#) for more information about the Common VFP subarchitecture additions to the register.

———— **Note** —————

In version 2 of the Common VFP subarchitecture the [FPEXC.EX](#) bit is set to 1 only when an asynchronous bounce occurs.

Software can detect the presence of the instruction registers by testing the [FPEXC.EX](#) and [FPEXC.FP2V](#) bits, as described in [Detecting which VFP Common subarchitecture registers are implemented on page AppxF-2445](#).

## F.3 Exception processing

The following sections describe exception processing in the Common VFP subarchitecture:

- [Asynchronous exceptions](#)
- [Synchronous exceptions](#) on page AppxF-2434
- [Floating-point Access Permission faults](#) on page AppxF-2435
- [Unallocated floating-point instruction encodings](#) on page AppxF-2435
- [Trapped floating-point exception handling](#) on page AppxF-2435.

### F.3.1 Asynchronous exceptions

In the Common VFP subarchitecture, an exceptional condition can be detected after executing the exceptional instruction. This means an implementation can detect an exceptional condition after an instruction has passed the point for exception handling in the ARM processor pipeline.

Handling this condition is called asynchronous exception handling, because the exceptional condition can be detected some time after it is generated. In this case the exception handling:

- is signaled synchronously with respect to the trigger instruction
- is not signaled synchronously with respect to the instruction that generated the exceptional condition.

When it detects an exceptional condition, the Floating-point Extension enters the asynchronous exceptional state, setting the `FPEXC.EX` bit to 1. At the application level, subsequent floating-point instructions are rejected. This causes an Undefined Instruction exception, and information about the exceptional instruction is copied to:

- the `FPINST` and `FPINST2` registers
- the `FPEXC.VECITR` field.

For details of the `FPEXC` see:

- [FPEXC, Floating-Point Exception Control register, VMSA](#) on page B4-1567 for the VFPv3 architectural requirements for the register
- [Additions to the Floating-Point Exception Register, FPEXC](#) on page AppxF-2439 for the Common VFP subarchitecture extensions to the register.

In some implementations it is possible for two floating-point instructions to issue before an exceptional condition is detected in the first instruction. In this case the second instruction is copied to `FPINST2`, see [The Floating-Point Instruction Registers, FPINST and FPINST2](#) on page AppxF-2443. This instruction must be executed by the support code. If there is a dependency between the instructions copied into `FPINST` and `FPINST2` then the instruction in `FPINST` must be executed before the instruction in `FPINST2`.

The trigger instruction might not be the floating-point instruction immediately following the exceptional instruction, and depending on the instruction sequence, the bounce can occur many instructions later. An implementation can continue to execute some floating-point instructions before detecting the exceptional condition, provided:

- these instructions are not themselves exceptional
- these instructions are independent of the exceptional instruction
- the operands for the exceptional instruction are still available after the execution of the instructions.

#### Determination of the trigger instruction

`VMSR` and `VMRS` instructions that access the `FPEXC`, `FPSID`, `FPINST` or `FPINST2` registers do not trigger exception processing.

These system registers are not used in normal floating-point application software, but are designed for use by support code and the operating system. Accesses to these registers do not bounce when the processor is in an asynchronous exceptional state, indicated by `FPEXC.EX == 1`. This means the support code can read information out of these registers, before clearing the exceptional condition by setting `FPEXC.EX` to 0.

All other floating-point instructions, including VMRS and VMSR instructions that access the FPSCR, trigger exception processing if there is an outstanding exceptional condition. For more information, see [Floating-point support code on page B1-1236](#).

### Exception processing for scalar instructions

When an exceptional condition is detected in a scalar CDP instruction:

- the exception-generating instruction is copied to the FPINST Register, see [The Floating-Point Instruction Registers, FPINST and FPINST2 on page AppxF-2443](#)
- the FPEXC.VECITR field is set to 0b111 to indicate that no short vector iterations are required
- the FPEXC.EX bit is set to 1
- all the operand registers to the instruction are restored to their original values, so that the instruction can be re-executed in support code
- If the execution of the instruction would set the cumulative exception bits for any exception, hardware might or might not set these bits.

———— **Note** —————

Because the cumulative exception bits are cumulative, it is always acceptable for the support code to set the exception bits to 1 as a result of emulating the instruction, even if the hardware has set them.

If there is a bypassed instruction then this is copied to the FPINST2 Register, and the FPEXC.FP2V bit is set to 1. The next floating-point instruction issued becomes the trigger instruction and causes entry to the operating system.

### Exception processing for short vector instructions

With a short vector instruction, any iteration might be exceptional. When an exceptional condition is detected for a vector iteration, previous iterations can complete. For the exceptional iteration:

- The exception-generating instruction is copied to the FPINST register, see [The Floating-Point Instruction Registers, FPINST and FPINST2 on page AppxF-2443](#). The source and destination registers are modified to point to the exceptional iteration.
- The FPEXC.VECITR field is written with the number of iterations remaining after the exceptional iteration.
- The FPEXC.EX bit is set to 1.
- The input operand registers to that iteration, and subsequent iterations, are restored to their original values.
- If the execution of the exception iteration, or subsequent iterations, would set the cumulative exception bits for any exception, hardware might or might not set these bits.

———— **Note** —————

Because the cumulative exception bits are cumulative, it is always acceptable for the support code to set the exception bits to 1 as a result of emulating the iterations of the instruction, even if the hardware has set them.

If there is a bypassed instruction then this is copied to the FPINST2 Register, and the FPEXC.FP2V bit is set to 1. The next floating-point instruction issued becomes the trigger instruction and causes entry to the operating system.

### F.3.2 Synchronous exceptions

In the Common VFP subarchitecture, an implementation can signal a floating-point exception synchronously.

When an exceptional condition is detected in a CDP instruction, and the implementation chooses to signal the condition synchronously:

- if the exceptional condition is a trapped floating-point exception the `FPEXC.DEX` bit is set to 1
- if the reason for the exceptional condition is IMPLEMENTATION DEFINED then the value of the `FPEXC.DEX` bit is IMPLEMENTATION DEFINED
- the instruction is bounced, causing an Undefined Instruction exception
- `FPEXC.EX` is not set to 1.

The `FPINST` and `FPINST2` registers are not used in this case.

For scalar CDP instructions:

- All the operand registers to the instruction are restored to their original values, so that the instruction can be re-executed in support code.
- It is IMPLEMENTATION DEFINED whether the `FPEXC.VV` bit is set to 1. If it is, the `FPEXC.VECITR` field will contain `0b111`.
- If the execution of the instruction would set the cumulative exception bits for any exception, hardware might or might not set these bits.

———— **Note** —————

Because the cumulative exception bits are cumulative, it is always acceptable for the support code to set the exception bits to 1 as a result of emulating the instruction, even if the hardware has set them.

For short vector instructions, any iteration might be exceptional. When an exceptional condition is detected for a vector iteration, previous iterations can complete. For the exceptional iteration:

- The `FPEXC.VECITR` field is written with a value that encodes the number of iterations remaining after the exceptional iteration. For details of the encoding see *Subarchitecture additions to the Floating-point Extension system registers* on page AppxF-2439.
- The `FPEXC.VV` bit is set to 1.
- The input operand registers to that iteration, and subsequent iterations, are restored to their original values.
- If the execution of the exception iteration, or subsequent iterations, would set the cumulative exception bits for any exception, hardware might or might not set these bits.

———— **Note** —————

Because the cumulative exception bits are cumulative, it is always acceptable for the support code to set the exception bits to 1 as a result of emulating the iterations of the instruction, even if the hardware has set them.

———— **Note** —————

- In version 1 of the Common VFP subarchitecture, all exceptions are signaled synchronously when the `FPSCR.IXE` bit is set to 1. The `FPEXC.DEX` bit is RAZ/WI. For more information, see *Subarchitecture v1 exception handling when FPSCR.IXE is set to 1* on page AppxF-2446.
- In version 2 of the Common VFP subarchitecture, exceptional conditions that cause synchronous exceptions are signaled by setting `FPEXC.DEX` to 1. For more information, see *Differences between version 2 and version 3 of the Common VFP subarchitecture* on page AppxF-2446.

### F.3.3 Floating-point Access Permission faults

When the floating-point register bank is disabled by disabling coprocessors 10 and 11 in a coprocessor access control register, any attempt to use a floating-point instruction will bounce. When the floating-point register bank is disabled by clearing the `FPEXC.EN` bit to 0, any attempt to access a floating-point register, except the `FPEXC` or `FPINST` register, will bounce.

In a system where the Floating-point Extension can be disabled, handler software must check that the Floating-point Extension is enabled before processing a floating-point exception.

### F.3.4 Unallocated floating-point instruction encodings

*Unallocated floating-point instruction encodings* are those coprocessor 10 and 11 instruction encodings that are not allocated for floating-point instructions by ARM.

An unallocated floating-point instruction encoding bounces synchronously to the floating-point Undefined Instruction exception handler. In this case the floating-point state is not modified, the `FPEXC.EX` bit is set to 0, and the `FPEXC.DEX` bit is set to 0. Unallocated instruction exception handling is synchronous.

The floating-point exception handler can check the `FPEXC.EX` bit, to find out if the floating-point implementation is using asynchronous exception handling to handle a previous exceptional condition.

If `FPEXC.EX=1`, the support code is called to process a previous exceptional instruction. On return from the support code the trigger instruction is reissued, and if the trigger instruction is an unallocated instruction the Undefined Instruction exception handler is re-entered, with `FPEXC.EX=0`.

If `FPEXC.EN == 1`, `FPEXC.EX == 0` and `FPEXC.DEX == 0`, the exception handler might have been called as a result of an unallocated instruction encoding or as a result of an allocated instruction encoding which has not been implemented:

- If the instruction is not a CDP instruction, the instruction is an unallocated instruction encoding and execution can jump to the unallocated instructions handler provided by the system.
- If the instruction is a CDP instruction, the support code must identify whether the instruction is one that it can handle. If it is not, then execution can jump to the unallocated instructions handler provided by the system.

### F.3.5 Trapped floating-point exception handling

Trapped floating-point exceptions are never handled by hardware. When a trapped exception is detected by hardware the exception-generating instruction must be re-executed by the support code. The support code must re-detect and signal the exception.

## F.4 Support code requirements

When an instruction is bounced, control passes to the Undefined Instruction exception handler provided by the operating system.

The operating system is expected to:

1. Perform a standard exception entry sequence, preserving process state and re-enabling interrupts.
2. Decode the bounced instruction sufficiently to determine whether it is a coprocessor instruction, and if so, for which coprocessor.
3. Check whether the bounced instruction is conditional, and if it is conditional, check whether it passed its condition code check. This ensures correct execution on implementations that perform the bounce even for an instructions that would fail its condition code check.
4. Check whether the coprocessor is enabled in the access control register, and take appropriate action if not. For example, in the lazy context switch case described in *Context switching with the Advanced SIMD and Floating-point Extensions* on page B1-1236, the operating system context switches the floating-point state.
5. Call an appropriate second-level handler for the coprocessor, passing in:
  - the instruction that bounced
  - the state of the associated process.
6. The second-level handler must indicate whether the bounced instruction is to be retried or skipped. It can also signal an additional exception that must be passed on to the application.
7. Restore the original process, transferring control to an exception handler in the application context if necessary.

If the bounced instruction is a floating-point instruction, control is passed to a second-level handler for floating-point instructions. For the Common VFP subarchitecture this:

1. Uses the **FPEXC.EX** and **FPEXC.DEX** bits to determine the bounced instruction and associated handling. The three possible cases are:
  - FPEXC.EX == 0, FPEXC.DEX == 0**

The bounce was synchronous. The exception-generating instruction is the instruction that bounced:

    - If the exception-generating instruction is not a CDP instruction, or the version of the subarchitecture is before version 3, the bounce was caused by an unallocated instruction encoding or a floating-point access permission fault. Branch to operating system specific software that takes appropriate action.
    - If the exception-generating instruction is a CDP instruction, check whether the bounce was caused by a floating-point access permission fault:
      - If it is a floating-point access permission fault, branch to operating system specific software that takes appropriate action.
      - If it is a not a floating-point access permission fault, determine the iteration count from **FPSCR.Len**, and set the return address to the instruction following the bounced instruction. Then continue processing from step 2.

### **FPEXC.EX == 0, FPEXC.DEX == 1**

The bounced instruction was executed as a valid floating-point operation, and it bounced because of an exceptional condition.

The exception-generating instruction is the instruction that bounced.

The iteration count is determined from either **FPSCR.Len** or **FPEXC.VECITR**, depending on the value of **FPEXC.VV**:

- if **FPEXC.VV** is set to 0, the iteration count is determined from **FPSCR.Len**
- if **FPEXC.VV** is set to 1, the iteration count is determined from **FPEXC.VECITR**.



Clear the `FPEXC.DEX` bit to 0, and set the return address to the instruction following the bounced instruction.

Continue processing from step 2.

#### `FPEXC.EX == 1`

The floating-point bounce resulted from an asynchronous exception.

Collect information about the exceptional instruction, and any other instructions that are to be executed by support code. Clear the exceptional condition. For each instruction the data collected include the instruction encoding and the number of vector iterations.

This involves:

- Read the `FPINST` Register to find the exception-generating instruction.  
Read the `FPEXC.VECITR` field to find the remaining iteration count for this instruction.
- Check `FPEXC.FP2V`. If it is set to 1 there is a bypassed instruction:
  - Read the `FPINST2` Register to find the bypassed instruction
  - Clear the `FPEXC.EX` and `FPEXC.FP2V` bits to 0.
  - Read the `FPSCR.Len` field to find the iteration count for the bypassed instruction.  
The `FPSCR` can be read-only when `FPEXC.EX == 0`.

Otherwise there is no bypassed instruction:

- Clear `FPEXC.EX` to 0.

`FPEXC.EX == 0` indicates there is no subarchitecture state to context switch.

Set the return address to re-execute the trigger instruction.

#### ————— **Note** —————

In version 1 of the Common VFP subarchitecture, the meaning of the `FPEXC.EX` bit changes when the `FPSCR.IXE` bit is set to 1. The `FPSCR.IXE` bit can be checked only after the `FPEXC.EX` bit is cleared to 0. If `FPSCR.IXE` is 0, go to step 2 below. If `FPSCR.IXE` is set to 1:

- the information collected from the floating-point registers and the calculated return address are ignored
- the exception-generating instruction is the instruction that bounced, and the iteration count is the `FPSCR.Len` value, as for the `FPEXC.DEX == 1` case.
- set the return address to the instruction following the bounced instruction.

2. Packages up the information about the floating-point instruction and iteration count into pairs in a form suitable to pass to the Computation Engine, described in step 3.

At this point the packaged information can be sent as a signal to another exception handler in the application, where the support code continues. Continuing in the application context makes it possible for the support code to call trap handlers directly, in the application.

3. Executes in software the instruction iterations described in step 2. All configuration information except vector length is read from the `FPSCR`.

In previous support code implementations by ARM, this execution is performed by the floating-point *Computation Engine* function.

If trapped floating-point exceptions are enabled, the Computation Engine calls trap handlers as required.

If the exceptional condition is an unallocated instruction, the Computation Engine will call a suitable error routine.

4. Returns to the appropriate return address.

## F.5 Context switching

Context switch software must check the `FPEXC.EX` bit when saving or restoring floating-point state.

If the `FPEXC.EX` bit is set to 1 then additional subarchitecture information must be saved. Any attempt to access other registers while the `FPEXC.EX` bit is set to 1 might bounce.

For the Common VFP subarchitecture, if the `FPEXC.EX` bit is set to 1:

- the `FPINST` register contains a bounced instruction and must be saved
- if the `FPEXC.FP2V` bit is set, the `FPINST2` register must be saved.

The `FPEXC` register must always be saved.

When the subarchitecture specific information has been saved, context switch software must clear the `FPEXC.EX` bit to 0 before saving other registers.

When restoring state, check the saved values of the `FPEXC.EX` bit and `FPEXC.FP2V` bit to determine whether the extra registers must be restored.

———— **Note** —————

Context switch software can be written to always save and restore the subarchitecture registers. In this case appropriate context switch software must be chosen based on the registers implemented, using the detection mechanism described in [Detecting which VFP Common subarchitecture registers are implemented on page AppxF-2445](#).

The process described in this section applies, also, to executing floating-point instructions in Debug state. This means that a debugger must:

- save the floating-point state before executing any floating-point instructions
- restore this saved floating-point state before exiting Debug state.

## F.6 Subarchitecture additions to the Floating-point Extension system registers

The Common VFP subarchitecture requires additions to the Floating-point Extension system register implementation:

- extra fields are defined in the FPEXC, see *Additions to the Floating-Point Exception Register, FPEXC*
- additional Floating-point Extension system registers might be defined, see *The Floating-Point Instruction Registers, FPINST and FPINST2* on page AppxF-2443.

———— **Note** —————

The architecturally-defined Floating-point Extension system registers are described in both *Chapter B4 System Control Registers in a VMSA implementation* and *Chapter B6 System Control Registers in a PMSA implementation*. As indicated at the start of this appendix, most links from this chapter are to the register descriptions in the VMSA chapter.

Also, the Subarchitecture field of the FPSID must identify the Common VFP subarchitecture version.

For more information about the Floating-point Extension register implementation for the Common VFP subarchitecture see:

- *Detecting which VFP Common subarchitecture registers are implemented* on page AppxF-2445
- *Accessing the VFP Common subarchitecture registers* on page AppxF-2444.

### F.6.1 Additions to the Floating-Point Exception Register, FPEXC

See *FPEXC, Floating-Point Exception Control register, VMSA* on page B4-1567 or *FPEXC, Floating-Point Exception Control register, PMSA* on page B6-1843 for the architectural definition of the FPEXC, including its purpose and accessibility.

———— **Note** —————

The VMSA and PMSA descriptions of the register are identical.

The FPEXC bit assignments when version 3 of the Common VFP subarchitecture is implemented are:

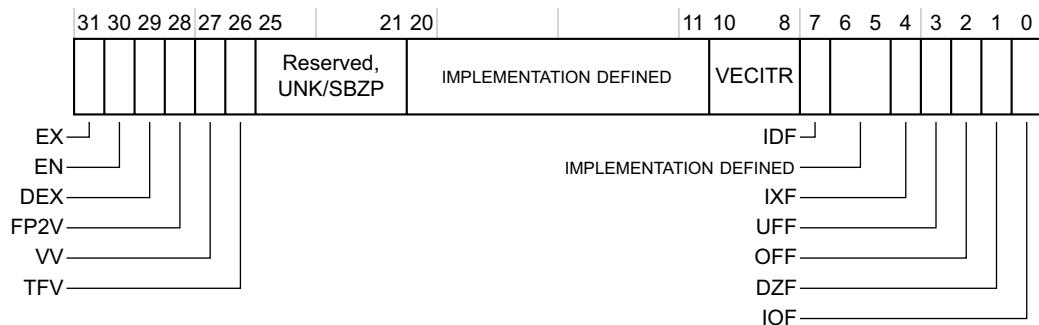

**EX, bit[31]** See the *FPEXC* architectural description for the definition of this bit.  
 On an implementation that does not require asynchronous exception handling this bit is RAZ/WI. In this case the FPINST and FPINST2 registers are not implemented.  
 For details of how, in Common VFP subarchitecture v1, the meaning of the EX bit changes when the FPSCR.IEX bit is set to 1, see *Subarchitecture v1 exception handling when FPSCR.IXE is set to 1* on page AppxF-2446.

**EN, bit[30]** See the *FPEXC* architectural description for the definition of this bit.

- DEX, bit[29]** Defined synchronous instruction exceptional bit. This field is valid only if `FPEXC.EX == 0`.  
When a floating-point synchronous exception has occurred:
- if the exception was caused by an allocated floating-point instruction that is not implemented in hardware then it is IMPLEMENTATION DEFINED whether DEX is set to 0 or 1
  - otherwise, the meaning of this bit is:
    - 0** A synchronous exception occurred when processing an unallocated instruction in CP10 or CP 11.
    - 1** A synchronous exception occurred on an allocated floating-point instruction that encountered an exceptional condition.
- The exception-handling routine must clear DEX to 0.  
On an implementation that does not require synchronous exception handling this bit is RAZ/WI.
- FP2V, bit[28]** FPINST2 instruction valid bit. This field is valid only if `FPEXC.EX == 1`.  
When an asynchronous floating-point exception has occurred, the meaning of this bit is:
- 0** The FPINST2 Register does not contain a valid instruction.
  - 1** The FPINST2 Register contains a valid instruction.
- FP2V must be cleared to 0 by the exception-handling routine.  
If the FPINST2 Register is not implemented this bit is RAZ/WI.
- VV, bit[27]** VECITR valid bit. This field is valid only if `FPEXC.DEX == 1`.  
When a synchronous floating-point exception has occurred, the meaning of this bit is:
- 0** FPEXC.VECITR field is not valid, and the number of remaining vector steps can be determined from `FPSCR.Len`.
  - 1** FPEXC.VECITR field is valid, and the number of remaining vector steps can be determined from FPEXC.VECITR.
- VV must be cleared to 0 by the exception-handling routine.  
If the VV field is not implemented this bit is RAZ/WI.
- TFV, bit[26]** Trapped Fault Valid bit. Indicates whether FPEXC bits[7, 4:0] indicate trapped exceptions, or have an IMPLEMENTATION DEFINED meaning:
- 0** FPEXC bits[7, 4:0] have an IMPLEMENTATION DEFINED meaning
  - 1** FPEXC bits[7, 4:0] indicate the presence of trapped exceptions that have occurred at the time of the exception. All trapped exceptions that occurred at the time of the exception have their bits set.
- This bit has a fixed value and ignores writes.
- Bits[25:21]** Reserved, UNK/SBZP.
- Bits[20:11, 6:5]**  
IMPLEMENTATION DEFINED.  
These bits are IMPLEMENTATION DEFINED. They can contain IMPLEMENTATION DEFINED information about the cause of an exception. They might be used by the implementation to indicate why an instruction was bounced to support code.  
These bits must be cleared to zero by the exception-handling routine.

### VECITR, bits[10:8]

Vector iteration count for the floating-point instruction with the exceptional condition. This field is valid only if either:

- FPEXC.EX == 1
- FPEXC.DEX == 1 and FPEXC.VV == 1.

This field contains the number of short vector iterations remaining after the iteration in which a potential exception was detected. Possible values are:

0b000	1 iteration
0b001	2 iterations
0b010	3 iterations
0b011	4 iterations
0b100	5 iterations
0b101	6 iterations
0b110	7 iterations
0b111	0 iterations.

The count held in this field does not include the iteration in which the exception occurred. This field reads as 0b111 if:

- the final iteration of an instruction is bounced to the support code
- the instruction is a scalar operation.

The exception-handling routine must clear VECITR to 0b000.

### IDF, bit[7]

Input Denormal trapped exception bit, or IMPLEMENTATION DEFINED. The meaning of this bit depends on the value of FPEXC.TFV:

#### FPEXC.TFV == 0

This bit is IMPLEMENTATION DEFINED. It can contain IMPLEMENTATION DEFINED information about the cause of an exception. It might be used by the implementation to indicate why an instruction was bounced to support code.

#### FPEXC.TFV == 1

This bit is the Input Denormal trapped exception bit. It indicates whether an Input Denormal exception occurred while FPSCR.IDE was 1.

In this case, the meaning of this bit is:

- 0 Input denormal exception has not occurred.
- 1 Input denormal exception has occurred.

Input Denormal exceptions can occur only when FPSCR.FZ is 1.

In both cases this bit must be cleared to 0 by the exception-handling routine.

### IXF, bit[4]

Inexact trapped exception bit, or IMPLEMENTATION DEFINED. The meaning of this bit depends on the value of FPEXC.TFV:

#### FPEXC.TFV == 0

This bit is IMPLEMENTATION DEFINED. It can contain IMPLEMENTATION DEFINED information about the cause of an exception. It might be used by the implementation to indicate why an instruction was bounced to support code.

#### FPEXC.TFV == 1

This bit is the Inexact trapped exception bit. It indicates whether an Inexact exception occurred while FPSCR.IXE was 1.

In this case, the meaning of this bit is:

- 0 Inexact exception has not occurred.
- 1 Inexact exception has occurred.

In both cases this bit must be cleared to 0 by the exception-handling routine.

**UFF, bit[3]** Underflow trapped exception bit, or IMPLEMENTATION DEFINED. The meaning of this bit depends on the value of FPEXC.TFV:

**FPEXC.TFV == 0**

This bit is IMPLEMENTATION DEFINED. It can contain IMPLEMENTATION DEFINED information about the cause of an exception. It might be used by the implementation to indicate why an instruction was bounced to support code.

**FPEXC.TFV == 1**

This bit is the Underflow trapped exception bit. It indicates whether an Underflow exception occurred while FPSCR.UFE was 1.

In this case, the meaning of this bit is:

- 0** Underflow exception has not occurred.
- 1** Underflow exception has occurred.

**Note**

An Underflow trapped exception can occur only when FPSCR.FZ is 0, because when FPSCR.FZ is 1, FPSCR.UFE is ignored and treated as 0.

In both cases this bit must be cleared to 0 by the exception-handling routine.

**OFF, bit[2]** Overflow trapped exception bit, or IMPLEMENTATION DEFINED. The meaning of this bit depends on the value of FPEXC.TFV:

**FPEXC.TFV == 0**

This bit is IMPLEMENTATION DEFINED. It can contain IMPLEMENTATION DEFINED information about the cause of an exception. It might be used by the implementation to indicate why an instruction was bounced to support code.

**FPEXC.TFV == 1**

This bit is the Overflow trapped exception bit. It indicates whether an Overflow exception occurred while FPSCR.OFE was 1.

In this case, the meaning of this bit is:

- 0** Overflow exception has not occurred.
- 1** Overflow exception has occurred.

In both cases this bit must be cleared to 0 by the exception-handling routine.

**DZE, bit[1]** Divide-by-zero trapped exception bit, or IMPLEMENTATION DEFINED. The meaning of this bit depends on the value of FPEXC.TFV:

**FPEXC.TFV == 0**

This bit is IMPLEMENTATION DEFINED. It can contain IMPLEMENTATION DEFINED information about the cause of an exception. It might be used by the implementation to indicate why an instruction was bounced to support code.

**FPEXC.TFV == 1**

This bit is the Divide-by-zero trapped exception bit. It indicates whether a Divide-by-zero exception occurred while FPSCR.DZE was 1.

In this case, the meaning of this bit is:

- 0** Divide-by-zero exception has not occurred.
- 1** Divide-by-zero exception has occurred.

In both cases this bit must be cleared to 0 by the exception-handling routine.

**IOE, bit[0]** Invalid Operation trapped exception bit, or IMPLEMENTATION DEFINED. The meaning of this bit depends on the value of FPEXC.TFV:

**FPEXC.TFV == 0**

This bit is IMPLEMENTATION DEFINED. It can contain IMPLEMENTATION DEFINED information about the cause of an exception. It might be used by the implementation to indicate why an instruction was bounced to support code.

**FPEXC.TFV == 1**

This bit is the Invalid Operation trapped exception bit. It indicates whether an Invalid Operation exception occurred while FPSCR.IOE was 1.

In this case, the meaning of this bit is:

- 0** Invalid Operation exception has not occurred.
- 1** Invalid Operation exception has occurred.

In both cases this bit must be cleared to 0 by the exception-handling routine.

## F.6.2 The Floating-Point Instruction Registers, FPINST and FPINST2

The Floating-Point Instruction Registers hold floating-point instructions relating to floating-point exception handling in a system that implements the Common VFP subarchitecture:

- FPINST contains the exception-generating instruction
- FPINST2 contains the bypassed instruction.

FPINST and FPINST2 are:

- In the CP10 and CP11 register space.
- Present only when the Common VFP subarchitecture is implemented. A Common VFP subarchitecture implementation can support:
  - both FPINST and FPINST2
  - FPINST but not FPINST2
  - neither of the Floating-Point Instruction Registers.
- 32-bit read/write registers.
- Accessible only by software executing at privilege level PL1 or higher, and only if both:
  - access to coprocessors CP10 and CP11 is enabled in the CPACR, see [CPACR, Coprocessor Access Control Register, VMSA on page B4-1551](#) for a VMSA implementation, or [CPACR, Coprocessor Access Control Register, PMSA on page B6-1829](#) for a PMSA implementation
  - the Floating-point Extension is enabled by setting the FPEXC.EN bit to 1.
- If the implementation includes the Security Extensions, Configurable access registers. FPINST and FPINST2 are only accessible in the Non-secure state if the CP10 and CP11 bits in the NSACR are set to 1.
- If the implementation includes the Virtualization Extensions, accessible from Hyp mode only if the CP10 and CP11 bits in the HCPTR to 1 are set to 1.

The format of a Thumb instruction in FPINST or FPINST2 is:

15	14	13	12	11	10	9	8	7	6	5	4	3	2	1	0	15	14	13	12	11	10	9	8	7	6	5	4	3	2	1	0
1	1	1	0	1	1	1	0		D				Vn			Vd		cp_num	N	Q	M	0			Vm						

The format of an ARM instruction in FPINST or FPINST2 is:

31	30	29	28	27	26	25	24	23	22	21	20	19	18	17	16	15	14	13	12	11	10	9	8	7	6	5	4	3	2	1	0
1	1	1	0	1	1	1	0		D			Vn			Vd		cp_num	N	Q	M	0			Vm							

The format is the same as the format of the issued instruction, with a number of modifications. For more information, see [Floating-point data-processing instructions on page A7-272](#). The modifications from the issued instruction are:

- In the Thumb encoding, bits[15:8] of the first halfword and bit[4] of the second halfword are reserved. In the ARM encoding, bits[31:24, 4] are reserved:
  - software must ignore these bits when reading this register, and must not modify these bits when writing to this register
  - hardware must set these bits to the values shown in the encoding diagrams, that map to the encoding of an ARM CDP instruction with the AL (always) condition.
- If the instruction is a short vector instruction:
  - for the FPINST Register, the source and destination registers that reference vectors are updated to point to the source and destination registers of the exceptional iteration. The `FPEXC.VECITR` field contains the number of iterations remaining. For more information, see [Exception processing for short vector instructions on page AppxF-2433](#).
  - for the FPINST Register, the full vector must be processed by support code, using the current vector length from the `FPSCR`. Source and destination registers that reference vectors are unchanged from the issued instruction.

Both MRS register read and MSR register write instructions are provided for the FPINST and FPINST2 registers, see [Accessing the VFP Common subarchitecture registers](#).

When an exceptional instruction is bounced to support code and placed in the FPINST Register, the `FPEXC.EX` bit is set to 1. This indicates that valid information is available in the FPINST Register. In addition, when a second issued instruction is copied to the FPINST2 Register, the `FPEXC.FP2V` bit is set to 1. This indicates that valid information is available in the FPINST2 Register.

When the `FPEXC.EX` bit is 0, indicating the floating-point implementation is not in an asynchronous exceptional state, reads of the FPINST and FPINST2 Registers are UNPREDICTABLE and the values returned might change.

When the `FPEXC.FP2V` bit is 0, indicating that no second instruction was issued, reads of the FPINST2 Register are UNPREDICTABLE and the value returned might change.

Any value read from a Floating-Point Instruction Register can be written back to the same register. This means context switch and debugger software can save and restore Floating-Point Instruction Register values. Writing a value that has not been read from the same register writes an UNKNOWN value to the Floating-Point Instruction Register. For example, attempting to write an instruction with coprocessor number 0 writes an UNKNOWN value to the Floating-Point Instruction Register.

### F.6.3 Accessing the VFP Common subarchitecture registers

Use the VMRS and VMSR instructions to access the registers for the VFP Common subarchitecture implementation, see:

- [VMRS on page B9-2012](#)
- [VMSR on page B9-2014](#).

The additional registers in the VFP Common subarchitecture are accessed using:

- `reg == 0b1001` for FPINST
- `reg == 0b1010` for FPINST2

If FPINST or FPINST2 is not defined, the corresponding VMRS and VMSR instructions are UNPREDICTABLE.

The VMRS and VMSR instructions with `reg == 0b1011` and `reg == 0b11xx` are UNPREDICTABLE.



#### F.6.4 Detecting which VFP Common subarchitecture registers are implemented

An implementation can choose not to implement FPINST and FPINST2, if these registers are not required.

System software can detect which registers are present as follows:

```
Set FPEXC.EX=1 and FPEXC.FP2V=1
Read back the FPEXC register
if FPEXC.EX == 0 then
    Neither FPINST nor FPINST2 are implemented
else
    if FPEXC.FP2V == 0 then
        FPINST is implemented, FPINST2 is not implemented.
    else
        Both FPINST and FPINST2 are implemented.
Clean up
```

## F.7 Earlier versions of the Common VFP subarchitecture

The following subsections describe the differences in earlier versions of the Common VFP subarchitecture:

### F.7.1 Differences between version 2 and version 3 of the Common VFP subarchitecture

Version 2 of the Common VFP subarchitecture can be identified by checking **FPSID** bits[22:16]. This field is 0b0000010 for version 2.

Version 2 of the Common VFP subarchitecture has three differences from version 3 of the subarchitecture. Before version 3 of the Common VFP subarchitecture:

- The **FPEXC.EX** == 0, **FPEXC.DEX** == 0 encoding is used only for unallocated instructions or permission faults. As a result, the determination that an instruction should be passed to the Computation Engine is simpler than it is for version 3 of the Common VFP subarchitecture.
- Bounces are not handled synchronously on short vector instructions unless all iterations of the vector are to be handled in software. This means that the **FPEXC.VV** bit is always 0 before version 3.
- The **FPEXC.TFV** bit is set to 0, so the additional information bits[7, 4:0] of **FPEXC** is IMPLEMENTATION DEFINED.

### F.7.2 Differences between version 1 and version 2 of the Common VFP subarchitecture

Version 1 of the Common VFP subarchitecture version can be identified by checking **FPSID** bits[22:16]. This field is 0b0000001 for version 1.

Version 1 of the Common VFP subarchitecture differs from version 2 of the subarchitecture in the following ways:

- the **FPEXC.DEX** bit is RAZ/WI.
- the subarchitecture has special behavior when the **FPSCR.IXE** bit is set to 1, as described in the following subsection.

#### Subarchitecture v1 exception handling when **FPSCR.IXE** is set to 1

In version 1 of the Common VFP subarchitecture, the mechanism for bouncing instructions changes when the **FPSCR.IXE** bit, the Inexact exception enable bit, is set to 1.

When **FPSCR.IXE** is set to 1, the **FPEXC.EX** bit signals a synchronous exception, in the same way as the **FPEXC.DEX** bit. In this case:

- the exceptional instruction is the instruction that caused the Undefined Instruction exception
- the **FPINST** Register and the **FPEXC.VECITR** field are not valid.

When **FPSCR.IXE** is 0 the **FPEXC.EX** bit signals an asynchronous exception, as for later versions of the subarchitecture.

# Appendix G

## Barrier Litmus Tests

This appendix gives examples of the use of the barrier instructions provided by the ARMv7 architecture. It contains the following sections:

- [Introduction on page AppxG-2448](#)
- [Simple ordering and barrier cases on page AppxG-2451](#)
- [Exclusive accesses and barriers on page AppxG-2458](#)
- [Using a mailbox to send an interrupt on page AppxG-2460](#)
- [Cache and TLB maintenance operations and barriers on page AppxG-2461.](#)

———— **Note** —————

This information is not part of the ARM architecture specification. It is included here as supplementary information, for the convenience of developers and users who might require this information.

## G.1 Introduction

The exact rules for the insertion of barriers into code sequences is a very complicated subject, and this appendix describes many of the corner cases and behaviors that are possible in an implementation of the ARMv7 architecture that includes the ARMv7 Multiprocessing Extensions.

This appendix is to help programmers, hardware design engineers, and validation engineers understand the need for the different kinds of barriers.

### G.1.1 Overview of memory consistency

Early generations of microprocessors were relatively simple processing engines that executed each instruction in program order. In such processors, the effective behavior was that each instruction was executed in its entirety before a subsequent instruction started to be executed. This behavior is sometimes referred to as the *Sequential Execution Model* (SEM).

In later processor generations, the needs to increase processor performance, both in terms of the frequency of operation and the number of instructions executed each cycle, mean that such a simple form of execution is abandoned. Many techniques, such as pipelining, write buffering, caching, speculation, and out-of-order execution, are introduced to provide improved performance.

For general purpose processors, such as ARM, these microarchitectural innovations are largely hidden from the programmer by a number of microarchitectural techniques. These techniques ensure that, within an individual processor, the behavior of the processor largely remains the same as the SEM. There are some exceptions to this where explicit synchronization is required. In the ARM architecture, these are limited to cases such as:

- synchronization of changes to the instruction stream
- synchronization of changes to system control registers.

In both these cases, the ISB instruction provides the necessary synchronization.

While the effect of ordering is largely hidden from the programmer within a single processor, the microarchitectural innovations have a profound impact on the ordering of memory accesses. Write buffering, speculation, and cache coherency protocols, in particular, can all mean that the order in which memory accesses occur, as seen by an external observer, differs significantly from the order of accesses that would appear in the SEM. This is usually invisible in a uniprocessor environment, but the effect becomes much more significant when multiple processors are trying to communicate in memory. In reality, these effects are often only significant at particular synchronization boundaries between the different threads of execution.

The problems that arise from memory ordering considerations are sometimes described as the problem of *memory consistency*. Processor architectures have adopted one or more *memory consistency models*, or *memory models*, that describe the permitted limits of the memory re-ordering that can be performed by an implementation of the architecture. The comparison and categorization of these has generated significant research and comment in academic circles, and ARM recommends the *Memory Consistency Models for Shared Memory-Multiprocessors* paper as an excellent detailed treatment of this subject.

This appendix does not reproduce such a work, but instead concentrates on some cases that demonstrate the features of the weakly-ordered memory model of the ARM architecture from ARMv6. In particular, the examples show how the use of the DMB and DSB memory barrier instructions can provide the necessary safeguards to limit memory ordering effects at the required synchronization points.

### G.1.2 Barrier operation definitions

The following reference, or provide, definitions of terms used in this appendix:

**DMB** See [Data Memory Barrier \(DMB\)](#) on page A3-151.

**DSB** See [Data Synchronization Barrier \(DSB\)](#) on page A3-152.

**ISB** See [Instruction Synchronization Barrier \(ISB\)](#) on page A3-152.

#### **Observer, Completion**

See [Observability and completion](#) on page A3-146.

### Program order

The order of instructions as they appear in an assembly language program. This appendix does not attempt to describe or define the legal transformations from a program written in a higher level programming language, such as C or C++, into the machine language that can then be disassembled to give an equivalent assembly language program. Such transformations are a function of the semantics of the higher level language and the capabilities and options on the compiler.

### G.1.3 Conventions

Many of the examples are written in a stylized extension to ARM assembler, to avoid confusing the examples with unnecessary code sequences. In particular, the construct `WAIT([Rx]==1)` describes the following sequence:

```
loop
  LDR R12, [Rx]
  CMP R12, #1
  BNE loop
```

R12 is chosen as an arbitrary temporary register that is not in use. It is named to permit the generation of a false dependency to ensure ordering.

For each example, a code sequence is preceded by an identifier of the observer running it:

- P0, P1...Px refer to caching coherent processors that implement the ARMv7 architecture with Multiprocessing Extensions, and are in the same shareability domain.
- E0, E1...Ex refer to non-caching observers, that do not participate in the coherency protocol, but execute ARM instructions and have a weakly-ordered memory model. This does not preclude these observers being different objects, such as DMA engines or other system masters.

These observers are unsynchronized other than as required by the documented code sequence.

#### ———— Note —————

Throughout this appendix, *ARM instruction* and *instruction* refer to instructions from the ARM or Thumb instruction set, as implemented on ARMv7 processors.

Results are expressed in terms of <agent>:<register>, such as P0:R5. The results can be described as:

**Permissible** This does not imply that the results expressed are required or are the only possible results. In most cases they are results that would not be possible under a sequentially consistent running of the code sequences on the agents involved. In general terms, this means that these results might be unexpected to anyone unfamiliar with memory consistency issues.

**Not permissible** Results that the architecture expressly forbids.

**Required** Results that the architecture expressly requires.

The examples omit the required shareability domain arguments of DMB and DSB instructions. The arguments are assumed to be selected appropriately for the shareability domains of the observers.

Where the barrier function in the litmus test can be achieved by a DMB ST, that is a barrier to stores only, this is shown by the use of DMB [ST]. This indicates that the ST qualifier can be omitted without affecting the result of the test. In some implementations DMB ST is faster than DMB.

Except where otherwise stated, other conventions are:

- All memory initializes to 0.
- R0 contains the value 1.
- R1 - R4 contain arbitrary independent addresses that initialize to the same value on all processors. The addresses held in these registers are Shareable and:
  - the addresses held in R1 and R2 are in Write-Back Cacheable Normal memory
  - the address held in R3 is in Write-Through Cacheable Normal Memory
  - the address held in R4 is in Non-cacheable Normal memory.
- R5 - R8 contain:
  - when used with an STR instruction, 0x55, 0x66, 0x77, and 0x88 respectively
  - when used with an LDR instruction, the value 0.
- R11 contains a new instruction or new translation table entry, as appropriate, and R10 contains the virtual address and the ASID, for use in this change of translation table entry.
- Memory locations are Normal memory locations unless otherwise stated.

The examples use mnemonics for the cache maintenance and TLB maintenance operations. The following tables describe the mnemonics:

- [Cache and branch predictor maintenance operations, VMSA on page B3-1496](#)
- [TLB maintenance operations, VMSA only on page B3-1497.](#)

### Notes on timing effects

Implementations that include the Multiprocessing Extensions are required to ensure that all writes complete in a finite time. This means that any observer that is waiting for the observation of a store, for example as a result of a `WAIT([Rx]==1)` loop, is guaranteed to make forward progress without software intervention.

On implementations that do not include the Multiprocessing Extensions, a store can take an unbounded time to complete. Therefore, a `WAIT([Rx]==1)` loop can take an unbounded time to see the increment `[Rx]`. On such an implementation, a DSB instruction can be used to guarantee the completion of a store. In general, the examples in this appendix associated with ordering assume that stores eventually become observable. Therefore, the examples omit a final DSB instruction to ensure the completion of stores.

## G.2 Simple ordering and barrier cases

ARM implements a weakly consistent memory model for Normal memory. In general terms, this means that the order of memory accesses observed by other observers might not be the order that appears in the program, for either loads or stores.

This section includes examples of this.

### G.2.1 Simple weakly consistent ordering example

P1:

```
STR R5, [R1]
LDR R6, [R2]
```

P2:

```
STR R6, [R2]
LDR R5, [R1]
```

In the absence of barriers, the result of P1: R6=0, P2: R5=0 is permissible.

### G.2.2 Message passing

The following sections describe:

- [Weakly-ordered message passing problem](#)
- [Message passing with multiple observers on page AppxG-2453](#).

#### Weakly-ordered message passing problem

P1:

```
STR R5, [R1]           ; set new data
STR R0, [R2]           ; send flag indicating data ready
```

P2:

```
WAIT([R2]==1)         ; wait on flag
LDR R5, [R1]           ; read new data
```

In the absence of barriers, an end result of P2: R5=0 is permissible.

#### Resolving by the addition of barriers

The addition of barriers, to ensure the observed order of the reads and the writes, ensures that data is transferred so that the result P2:R5==0x55 is guaranteed, as follows:

P1:

```
STR R5, [R1]           ; set new data
DMB [ST]               ; ensure all observers observe data before the flag
STR R0, [R2]           ; send flag indicating data ready
```

P2:

```
WAIT([R2]==1)         ; wait on flag
DMB                   ; ensure that the load of data is after the flag has been observed
LDR R5, [R1]
```

### Resolving by the use of barriers and address dependency

There is a rule within the ARM architecture that:

- Where the value returned by a read is used for computation of the virtual address of a subsequent read or write, then these two memory accesses are observed in program order.

Where the value returned by a read is used for computation of the virtual address of a subsequent read or write, this is called an *address dependency*. An address dependency exists even if the value returned by the first read has no effect on the virtual address. This might occur if the value returned is masked off before it is used, or if it confirms a predicted address value that it might have changed.

This restriction applies only when the data value returned by a read is used as a data value to calculate the address of a subsequent read or write. It does not apply if the data value returned by a read determines the condition flags values, and the values of the flags are used for condition code evaluation to determine the address of a subsequent read, either through conditional execution or the evaluation of a branch. This is called a *control dependency*.

Where both a control and address dependency exist, the ordering behavior is consistent with the address dependency.

Table G-1 shows examples of address dependencies, control dependencies, and an address and control dependency.

**Table G-1 Dependency examples**

Address dependency		Control dependency		Address and control dependency <sup>a</sup>
(a)	(b)	(c)	(d)	(e)
LDR r1, [r0]	LDR r1, [r0]	LDR r1, [r0]	LDR r1, [r0]	LDR r1, [r0]
LDR r2, [r1]	AND r1, r1, #0	CMP r1, #55	CMP r1, #55	CMP r1, #0
	LDR r2, [r3, r1]	LDRNE r2, [r3]	MOVNE r4, #22	LDRNE r2, [r1]
			LDR r2, [r3, r4]	

a. The address dependency takes priority.

This means that the data transfer example of *Weakly-ordered message passing problem on page AppxG-2451* can also be satisfied as shown in the following example:

P1:

```
STR R5, [R1]           ; set new data
DMB [ST]               ; ensure all observers observe data before the flag
STR R0, [R2]           ; send flag indicating data ready
```

P2:

```
WAIT([R2]==1)
AND R12, R12, #0       ; R12 is destination of LDR in WAIT macro
LDR R5, [R1, R12]     ; Load is dependent and so is ordered after the flag has been seen
```

The load of R5 by P2 is ordered with respect to the load from [R2] because there is an address dependency using R12. P1 uses a DMB to ensure that P2 does not observe the write of [R2] before the write of [R1].



### Message passing with multiple observers

Where the ordering of Normal memory accesses is not resolved by the use of barriers or dependencies, then different observers might observe the accesses in a different order, as shown in the following example:

P1:

```
STR R5, [R1]           ; set new data
STR R0, [R2]           ; send flag indicating data ready
```

P2:

```
WAIT([R2]==1)
AND R12, R12, #0       ; R12 is destination of LDR in WAIT macro
LDR R5, [R1, R12]     ; Load is dependent and so is ordered after the flag has been seen
```

P3:

```
WAIT([R2]==1)
AND R12, R12, #0       ; R12 is destination of LDR in WAIT macro
LDR R5, [R1, R12]     ; Load is dependent and so is ordered after the flag has been seen
```

In this case, it is permissible for P2:R5 and P3:R5 to contain different values, because there is no order guaranteed between the two stores performed by P1.

### Resolving by the addition of barriers

The addition of a barrier by P1, as shown in the following example, ensures the observed order of the writes, transferring data so that P2:R5 and P3:R5 both contain the value 0x55:

P1:

```
STR R5, [R1]           ; set new data
DMB [ST]              ; ensure all observers observe data before the flag
STR R0, [R2]           ; send flag indicating data ready
```

P2:

```
WAIT([R2]==1)
AND R12, R12, #0       ; R12 is destination of LDR in WAIT macro
LDR R5, [R1, R12]     ; Load is dependent and so is ordered after the flag has been seen
```

P3:

```
WAIT([R2]==1)
AND R12, R12, #0       ; R12 is destination of LDR in WAIT macro
LDR R5, [R1, R12]     ; Load is dependent and so is ordered after the flag has been seen
```

## G.2.3 Address dependency with object construction

When accessing an object-oriented data structure, the address dependency rule means that barriers are not required, even when initializing the object:

P1:

```
STR R5, [R1, #offset] ; set new data in a field
DMB [ST]              ; ensure all observers observe data before base address is updated
STR R1, [R2]           ; update base address
```

P2:

```
LDR R1, [R2]           ; read for base address
CMP R1, #0             ; check if it is valid
BEQ null_trap
LDR R5, [R1, #offset] ; use base address to read field
```

If the null\_trap is not taken, it is required that P2:R5==0x55. This avoids P2 observing a partially constructed object from P1. Significantly, P2 does not require a barrier to ensure this behavior.

P1 requires a barrier to ensure the observed order of the writes by P1. In general, the impact of requiring a barrier during the construction phase is much less than the impact of requiring a barrier for every read access.

#### G.2.4 Causal consistency issues with multiple observers

The fact that different observers can observe memory accesses in different orders extends, in the absence of barriers, to behaviors that do not fit naturally expected causal properties, as the following example shows:

P1:

```
STR R0, [R2]          ; set new data
```

P2:

```
WAIT([R2]==1)        ; wait to see new data from P1
STR R0, [R3]          ; send flag, must be after the new data has been by P2 as stores
                     ; must not be speculative
```

P3:

```
WAIT([R3]==1)        ; wait for P2's flag
AND R12, R12, #0     ; dependency to ensure order
LDR R0, [R2, R12]    ; read P1's data
```

In this example, P3:R0==0 is permissible. P3 is not guaranteed to see the stores from P1 and P2 in any particular order. This applies despite the fact that the store from P2 can only happen after P2 has observed the store from P1.

This example shows that the ARM memory ordering model for Normal memory does not conform to *causal consistency*. This means that the apparently transitive causal relationship between two variables is not guaranteed to be transitive.

The following example shows the insertion of a barrier by P2 to create causal consistency:

P1:

```
STR R0, [R2]          ; set new data
```

P2:

```
WAIT([R2]==1)        ; wait to see new data from P1
DMB                   ; ensure P1's data is observed by all observers before any following store
STR R0, [R3]          ; send flag
```

P3:

```
WAIT([R3]==1)        ; wait for P2's flag
AND R12, R12, #0     ; dependency to ensure order
LDR R0, [R2, R12]    ; read P1's data
```

This creates causal consistency because a DMB is required to order all accesses that the executing processor observed before the DMB, not only those it issued, before any of the accesses that follow the DMB.

#### G.2.5 Multiple observers of writes to multiple locations

The ARM weakly consistent memory model means that different observers can observe writes to different locations in different orders, as the following example shows:

P1:

```
STR R0, [R1]          ; set new data
```

P2:

```
STR R0, [R2]          ; set new data
```

P3:

```
LDR R10, [R2]      ; read P2's data before P1's
LDR R9, [R1]       ;
BIC R9, R10, R9    ; R9 <- R10 && ~R9
                   ; R9 contains 1 iff read from [R2] is observed to be 1 and
                   ; read from [R1] is observed to be 0.
```

P4:

```
LDR R9, [R1]
LDR R10, [R2]
BIC R9, R9, R10    ; R9 <- R9 && ~R10
                   ; R9 contains 1 iff read from [R2] is observed to be 0 and
                   ; read from [R1] is observed to be 1.
```

In this example, the result P3:R9==1 and P4:R9==1 is permissible. This means that P3 and P4 observed the stores from P1 and P2 in different orders.

The following example shows the use of DMB instructions to ensure sequential consistency:

P1:

```
STR R0, [R1]      ; set new data
```

P2:

```
STR R0, [R2]      ; set new data
```

P3:

```
LDR R10, [R2]     ; read P2's data before P1's
DMB
LDR R9, [R1]
BIC R9, R10, R9   ; R9 <- R10 && ~R9
                   ; R9 contains 1 iff read from [R2] is observed to be 1 and
                   ; read from [R1] is observed to be 0.
```

P4:

```
LDR R9, [R1]     ; read P1's data before P2's
DMB
LDR R10, [R2]
BIC R9, R9, R10  ; R9 <- R9 && ~R10
                   ; R9 contains 1 iff read from [R2] is observed to be 0 and
                   ; read from [R1] is observed to be 1.
```

In this example:

- the DMB executed by P3 ensures that, if the P3 load from [R2] observes the P2 store to [R2], then all observers observe the P2 store to [R2] before they observe the P3 load from [R1]
- the DMB executed by P4 ensures that, if the P4 load from [R1] observes the P1 store to [R1], then all observers observe the P1 store to [R1] before they observe the P4 load from [R2].

If the P3 load from [R1] returns 0, then it has not observed the P1 store to [R1]. Also, if the P3 load of [R2] returns 1, then all observers must have observed the P2 store to [R2] before they observed the P1 store to [R1]. This means that P4 cannot observe the P1 store to [R1] without also observing the P2 store to [R2].

Alternatively, if the P4 load from [R2] returns 0, then it has not observed the P2 store to [R2]. If, also, the P4 load of [R1] returns 1, then all observers must have observed the P1 store to [R1] before they observed the P2 store to [R2]. This means that P3 cannot observe the P2 store to [R2] without also observing the P1 store to [R1].

This shows that, of the four possible results for {P3:R9, P4:R9}, the insertion of these barriers makes the result {1, 1} impossible.

## G.2.6 Posting a store before polling for acknowledgement

In the case where an observer stores to a location, and then polls for an acknowledge from a different observer, the weak ordering of the memory model can lead to a deadlock, as the following example shows:

P1:

```
STR R0, [R2]
WAIT ([R3]==1)
```

P2:

```
WAIT ([R2]==1)
STR R0, [R3]
```

This can deadlock because P2 might not observe the store by P1 for an indefinite period of time.

The addition of a DMB instruction prevents this deadlock:

P1:

```
STR R0, [R2]
DMB
WAIT ([R3]==1)
```

P2:

```
WAIT ([R2]==1)
STR R0, [R3]
```

The DMB executed by P1 ensures that P2 observes the store by P1 before it observes the load by P1. This ensures a timely completion.

The following example is a variant of the previous example, where the two observers poll the same memory location:

P1:

```
STR R0, [R2]
WAIT ([R2]==2)
```

P2:

```
WAIT ([R2]==1)
LDR R0, [R2]
ADD R0, R0, #1
STR R0, [R2]
```

In this example, the same deadlock can occur, because the architecture permits P1 to read the result of its own store to [R2] early, and continue doing so for an indefinite amount of time. The addition of a DMB instruction prevents this deadlock:

P1:

```
STR R0, [R2]
DMB
WAIT ([R2]==2)
```

P2:

```
WAIT ([R2]==1)
LDR R0, [R2]
ADD R0, R0, #1
STR R0, [R2]
```

## G.2.7 WFE and WFI and barriers

The Wait For Event and Wait For Interrupt instructions permit the processor to suspend execution and enter a low-power state. A DSB barrier instruction is required if it is necessary to ensure that memory accesses made before the WFI or WFE are visible to other observers, unless some other mechanism has ensured this visibility. Examples of other mechanism that would guarantee the required visibility are the DMB described in [Posting a store before polling for acknowledgement on page AppxG-2456](#), or a dependency on a load.

The following example requires the DSB to ensure that the store is visible:

P1:

```

    STR R0, [R2]
    DSB
Loop
    WFI
    B Loop

```

However, if the example in [Posting a store before polling for acknowledgement on page AppxG-2456](#) is extended to include a WFE, there is no risk of a deadlock. The extended example is:

P1:

```

    STR R0, [R2]
    DMB
Loop
    LDR R12, [R3]
    CMP R12, #1
    WFENE
    BNE Loop

```

P2:

```

    WAIT ([R2]==1)
    STR R0, [R3]
    DSB
    SEV

```

In this example:

- the DMB by P1 ensures that P2 observes the store by P1 before it observes the load by P1
- the dependency of the WFE on the result of the load by P1 means that this load must complete before P1 executes the WFE.

For more information about SEV, see [Use of Wait For Event \(WFE\) and Send Event \(SEV\) with Locks on page AppxG-2458](#).

## G.3 Exclusive accesses and barriers

The Load-Exclusive and Store-Exclusive instructions, described in [Synchronization and semaphores on page A3-114](#), are predictable only with Normal memory. These instructions do not have any implicit barrier functionality. Therefore, any use of these instructions to implement locks of any type requires the addition of explicit barriers.

### G.3.1 Acquiring a lock

A common use of Load-Exclusive and Store-Exclusive instructions is to claim a lock to permit entry into a critical region. This is typically performed by testing a lock variable that indicates 0 for a free lock and some other value, commonly 1 or an identifier of the process holding the lock, for a taken lock.

The lack of implicit barriers in the Load-Exclusive and Store-Exclusive instructions means that the mechanism requires a DMB instruction between acquiring a lock and making the first access to the critical region, to ensure that all observers observe the successful claim of the lock before they observe any subsequent loads or stores to the region. This example shows Px acquiring a lock:

Px:

```
Loop
LDREX R5, [R1]      ; read lock
CMP R5, #0          ; check if 0
STREXEQ R5, R0, [R1] ; attempt to store new value
CMPEQ R5, #0        ; test if store succeeded
BNE Loop            ; retry if not
DMB                  ; ensures that all subsequent accesses are observed after the
                    ; gaining of the lock is observed
                    ; loads and stores in the critical region can now be performed
```

### G.3.2 Releasing a lock

The converse operation of releasing a lock does not require the use of Load-Exclusive and Store-Exclusive instructions, because only a single observer is able to write to the lock. However, often it is necessary for any observer to observe any memory updates, or any values that are loaded into memory, before they observe the release of the lock. Therefore, a DMB usually precedes the lock release, as the following example shows.

Px:

```
                    ; loads and stores in the critical region
MOV R0, #0
DMB                  ; ensure all previous accesses are observed before the lock is cleared
STR R0, [R1]         ; clear the lock
```

### G.3.3 Use of Wait For Event (WFE) and Send Event (SEV) with Locks

The ARMv7 architecture includes Wait For Event and Send Event instructions, that can be executed to reduce the required number of iterations of a lock-acquire loop, or *spinlock*, to reduce power. The basic mechanism involves an observer that is in a spinlock executing a WFE instruction that suspends execution on that observer until an asynchronous exception or an explicit event, sent by some other observer using the SEV instruction, is seen by the suspended observer. An observer that holds the lock executes an SEV instruction to send an event after it has released the lock.

The Event signal is a non-memory communication, and therefore the memory update that releases the lock must be observable by all observers before the SEV instruction is executed and the event is sent. This requires the use of DSB instruction, rather than DMB.

Therefore, the following is an example of lock acquire code using WFE:

Px:

```
Loop
  LDREX R5, [R1]      ; read lock
  CMP R5, #0          ; check if 0
  WFENE               ; sleep if the lock is held
  STREXEQ R5, R0, [R1] ; attempt to store new value
  CMPEQ R5, #0        ; test if store succeeded
  BNE Loop            ; retry if not
  DMB                 ; ensures that all subsequent accesses are observed after the
                    ; gaining of the lock is observed
                    ; loads and stores in the critical region can now be performed
```

And the following is an example of lock release code using SEV:

Px:

```
                    ; loads and stores in the critical region
  MOV R0, #0
  DMB                 ; ensure all previous accesses are observed before the lock is cleared
  STR R0, [R1]        ; clear the lock
  DSB                 ; ensure completion of the store that cleared the lock before
                    ; sending the event
  SEV
```

## G.4 Using a mailbox to send an interrupt

In some message passing systems, it is common for one observer to update memory and then notify a second observer of the update by sending an interrupt, using a mailbox.

Although a memory access might be made to initiate the sending of the mailbox interrupt, a DSB instruction is required to ensure the completion of previous memory accesses.

Therefore, the following sequence is required to ensure that P2 observes the updated value.

P1:

```
STR R5, [R1]          ; message stored to shared memory location
DSB [ST]
STR R1, [R4]          ; R4 contains the address of a mailbox
```

P2:

```
; interrupt service routine
LDR R5, [R1]
```

Even if R4 is a pointer to Strongly-Ordered memory, the update to R1 might not be visible unless P1 executes a DSB instruction.

———— **Note** ————

The DSB executed by P1 ensures global observation of the store to [R1]. The interrupt timing ensures that the code executed by P2 is executed after the global observation of the update to [R1], and therefore must see this update. In some implementations, this might be implemented by requiring that interrupts flush non-coherent buffers that hold speculatively loaded data.

---



## G.5 Cache and TLB maintenance operations and barriers

The following sections describe the use of barriers with cache and TLB maintenance operations:

- [Data cache maintenance operations](#)
- [Instruction cache maintenance operations on page AppxG-2463](#)
- [TLB maintenance operations and barriers on page AppxG-2465.](#)

### G.5.1 Data cache maintenance operations

The following sections describe the use of barriers with data cache maintenance operations:

- [Message passing to non-caching observers](#)
- [Multiprocessing message passing to non-caching observers](#)
- [Invalidating DMA buffers, nonfunctional example on page AppxG-2462](#)
- [Invalidating DMA buffers, functional example with single processor on page AppxG-2462](#)
- [Invalidating DMA buffers, functional example with multiple coherent processors on page AppxG-2463.](#)

#### Message passing to non-caching observers

The ARMv7 architecture requires the use of DMB instructions to ensure the ordering of data cache maintenance operations and their effects. This means the following message passing approaches can be used when communicating between caching observers and non-caching observers:

P1:

```
STR R5, [R1]           ; update data (assumed to be in P1's cache)
DCCMVAC R1             ; clean cache to point of coherency
DMB                   ; ensure effects of the clean will be observed before the flag is set
STR R0, [R4]          ; send flag to external agent (Non-cacheable location)
```

E1:

```
WAIT ([R4] == 1)      ; wait for the flag
DMB                   ; ensure that flag has been seen before reading data
LDR R5, [R1]          ; read the data
```

In this example, it is required that E1:R5==0x55.

#### Multiprocessing message passing to non-caching observers

The broadcast nature of the cache maintenance operations in an implementation that includes the Multiprocessing Extensions, combined with properties of barriers, means that the message passing principle for non-caching observers is:

P1:

```
STR R5, [R1]           ; update data (assumed to be in P1's cache)
DMB [ST]              ; ensure new data is observed before the flag to P2 is set
STR R0, [R2]          ; send flag to P2
```

P2:

```
WAIT ([R2] == 1)      ; wait for flag from P1
DMB                   ; ensure cache clean is observed after P1's flag is observed
DCCMVAC R1            ; clean cache to point of coherency - this cleans the cache of P1
DMB                   ; ensure effects of the clean are observed before the flag to E1 is set
STR R0, [R4]          ; send flag to E1
```

E1:

```
WAIT ([R4] == 1)      ; wait for flag from P2
DMB                   ; ensure that flag has been observed before reading the data
LDR R5, [R1]          ; read the data
```

In this example, it is required that  $E1:R5 == 0x55$ . The clean operation executed by P2 affects the data location in the P1 cache. The cast-out from the P1 cache is guaranteed to be observed before P2 updates [R4].

### Invalidating DMA buffers, nonfunctional example

The basic scheme for communicating with an external observer that is a process that passes data in to a Cacheable memory region must take account of the architectural requirement that regions marked as Cacheable can be allocated into a cache at any time, for example as a result of speculation. The following example shows this possibility:

P1:

```
DCIMVAC R1          ; ensure cache clean with respect to memory. A clean operation could be
                    ; used but the DMA overwrites this region so an invalidate operation
                    ; is sufficient and usually more efficient
DMB                 ; ensures cache invalidation is observed before the next store is observed
STR R0, [R3]        ; send flag to external agent
WAIT ([R4]==1)      ; wait for a different flag from an external agent
DMB                 ; observe flag from external agent before reading new data. However [R1]
                    ; could have been brought into cache earlier
LDR R5, [R1]
```

E1:

```
WAIT ([R3] == 1)    ; wait for flag
STR R5, [R1]        ; store new data
DMB
STR R0, [R4]        ; send a flag
```

If a speculative access occurs, there is no guarantee that the cache line containing [R1] is not brought back into the cache after the cache invalidation, but before [R1] is written by E1. Therefore, the result  $P1:R5=0$  is permissible.

### Invalidating DMA buffers, functional example with single processor

P1:

```
DCIMVAC R1          ; ensure cache clean with respect to memory. A clean operation could be
                    ; used but the DMA overwrites this region so an invalidate operation
                    ; is sufficient and usually more efficient
DMB                 ; ensures cache invalidation is observed before the next store is observed
STR R0, [R3]        ; send flag to external agent
WAIT ([R4]==1)      ; wait for a different flag from an external agent
DMB                 ; ensure that cache invalidate is observed after the flag
                    ; from external agent is observed
DCIMVAC R1          ; ensure cache discards stale copies before use
LDR R5, [R1]
```

E1:

```
WAIT ([R3] == 1)    ; wait for flag
STR R5, [R1]        ; store new data
DMB [ST]
STR R0, [R4]        ; send a flag
```

In this example, the result  $P1:R5 == 0x55$  is required. Including a cache invalidation after the store by E1 to [R1] is observed ensures that the line is fetched from external memory after it has been updated.

## Invalidate DMA buffers, functional example with multiple coherent processors

The broadcasting of cache maintenance operations, and the use of DMB instructions to ensure their observability, means that the previous example extends naturally to a multiprocessor system. Typically this requires a transfer of ownership of the region that the external observer is updating.

P0:

```
(Use data from [R1], potentially using [R1] as scratch space)
DMB
STR R0, [R2]          ; signal release of [R1]
WAIT ([R2] == 0)      ; wait for new value from DMA
DMB
LDR R5, [R1]
```

P1:

```
WAIT ([R2] == 1)      ; wait for release of [R1] by P0
DCIMVAC R1            ; ensure caches are clean with respect to memory, invalidate is sufficient
DMB
STR R0, [R3]          ; request new data for [R1]
WAIT ([R4] == 1)      ; wait for new data
DMB
DCIMVAC R1            ; ensure caches discard stale copies before use
DMB
MOV R0, #0
STR R0, [R2]          ; signal availability of new [R1]
```

E1:

```
WAIT ([R3] == 1)      ; wait for new data request
STR R5, [R1]          ; send new [R1]
DMB [ST]
STR R0, [R4]          ; indicate new data available to P1
```

In this example, the result  $P0:R5 == 0x55$  is required. The DMB issued by P1 after the first data cache invalidation ensures that effect of the cache invalidation on P0 is seen by E1 before the store by E1 to [R1]. The DMB issued by P1 after the second data cache invalidation ensures that its effects are seen before the store of 0 to the semaphore location in [R2].

## G.5.2 Instruction cache maintenance operations

The following sections describe the use of barriers with instruction cache maintenance operations:

- [Ensuring the visibility of updates to instructions for a uniprocessor](#)
- [Ensuring the visibility of updates to instructions for a multiprocessor on page AppxG-2464.](#)

### Ensuring the visibility of updates to instructions for a uniprocessor

On a single processor, the agent that causes instruction fetches, or instruction cache linefills, is a separate memory system observer from the agent that causes data accesses. Therefore, any operations to invalidate the instruction cache can rely only on seeing updates to memory that are complete. This must be ensured by the use of a DSB instruction.

Also, instruction cache maintenance operations are only guaranteed to complete after the execution of a DSB, and an ISB is required to discard any instructions that might have been prefetched before the instruction cache invalidation completed. Therefore, on a uniprocessor, to ensure the visibility of an update to code and to branch to it, the following sequence is required:

P1:

```
STR R11, [R1]          ; R11 contains a new instruction to store in program memory
DCCMVAU R1            ; clean to PoU makes visible to instruction cache
DSB
ICIMVAU R1           ; ensure instruction cache and branch predictor discards stale data
BPIMVA R1
DSB                  ; ensure completion of the invalidation
ISB                  ; ensure instruction fetch path observes new instruction cache state
BX R1
```

### Ensuring the visibility of updates to instructions for a multiprocessor

The Multiprocessing Extensions require a processor that performs an instruction cache maintenance operation to execute a DSB instruction to ensure completion of the maintenance operation. This ensures that the cache maintenance operation is complete on all processors in the Inner Shareable shareability domain.

An ISB is not broadcast, and so does not affect other processors. This means that any other processor must perform its own ISB synchronization after it knows that the update is visible, if it is necessary to ensure its synchronization with the update. The following example shows how this might be done:

P1:

```
STR R11, [R1]          ; R11 contains a new instruction to store in program memory
DCCMVAU R1            ; clean to PoU makes visible to instruction cache
DSB                  ; ensure completion of the clean on all processors
ICIMVAU R1           ; ensure instruction cache/branch predictor discards stale data
BPIMVA R1
DSB                  ; ensure completion of the ICache and branch predictor
                    ; invalidation on all processors
STR R0, [R2]          ; set flag to signal completion
ISB                  ; synchronize context on this processor
BX R1                 ; branch to new code
```

P2-Px:

```
WAIT ([R2] == 1)      ; wait for flag signaling completion
ISB                  ; synchronize context on this processor
BX R1                 ; branch to new code
```

### Nonfunctional approach

The following sequence does not have the same effect, because a DSB is not required to complete the instruction cache maintenance operations that other processors issue:

P1:

```
STR R11, [R1]          ; R11 contains a new instruction to store in program memory
DCCMVAU R1            ; clean to PoU makes visible to instruction cache
DSB                  ; ensure completion of the clean on all processors
ICIMVAU R1           ; ensure instruction cache/branch predictor discards stale data
BPIMVA R1
DMB                  ; ensure ordering of the store after the invalidation
                    ; DOES NOT guarantee completion of instruction cache/branch
                    ; predictor on other processors
STR R0, [R2]          ; set flag to signal completion
DSB                  ; ensure completion of the invalidation on all processors
ISB                  ; synchronize context on this processor
BX R1                 ; branch to new code
```

P2-Px:

```
WAIT ([R2] == 1)      ; wait for flag signaling completion
DSB                  ; this DSB does not guarantee completion of P1's ICIMVAU/BPIMVA
ISB
BX R1
```

In this example, P2...Px might not see the updated region of code at R1.

### G.5.3 TLB maintenance operations and barriers

The following sections describe the use of barriers with TLB maintenance operations:

- *Ensuring the visibility of updates to translation tables for a uniprocessor*
- *Ensuring the visibility of updates to translation tables for a multiprocessor*
- *Paging memory in and out on page AppxG-2466.*

#### Ensuring the visibility of updates to translation tables for a uniprocessor

On a single processor, the agent that causes translation table walks is a separate memory system observer from the agent that causes data accesses. Therefore, any operations to invalidate the TLB can only rely on seeing updates to memory that are complete. This must be ensured by the use of a DSB instruction.

The Multiprocessing Extensions require that translation table walks look in the data or unified caches at L1, so such systems do not require data cache cleaning.

After the translation tables update, any old copies of entries that might be held in the TLBs must be invalidated. This operation is only guaranteed to affect all instructions, including instruction fetches and data accesses, after the execution of a DSB and an ISB. Therefore, the code for updating a translation table entry is:

P1:

```

STR R11, [R1]           ; update the translation table entry
DSB                     ; ensure visibility of the update to translation table walks
TLBIMVA R10
BPIALL
DSB                     ; ensure completion of the BP and TLB invalidation
ISB                     ; synchronize context on this processor
;
; new translation table entry can be relied upon at this point and all accesses
; generated by this observer using the old mapping have been completed
  
```

Importantly, by the end of this sequence, all accesses that used the old translation table mappings have been observed by all observers.

An example of this is where a translation table entry is marked as invalid. Such a system must provide a mechanism to ensure that any access to a region of memory being marked as invalid has completed before any action is taken as a result of the region being marked as invalid.

#### Ensuring the visibility of updates to translation tables for a multiprocessor

The same code sequence can be used in a multiprocessing system. The Multiprocessing Extensions require a processor that performs a TLB maintenance operation to execute a DSB instruction to ensure completion of the maintenance operation. This ensures that the TLB maintenance operation is complete on all processors in the Inner Shareable shareability domain.

The completion of a DSB that completes a TLB maintenance operation ensures that all accesses that used the old mapping have completed.

P1:

```

STR R11, [R1]           ; update the translation table entry
DSB                     ; ensure visibility of the update to translation table walks
TLBIMVAIS R10
BPIALLIS
DSB                     ; ensure completion of the BP and TLB invalidation
ISB                     ; Note ISB is not broadcast and must be executed locally on other processors
;
; new translation table entry can be relied upon at this point and all accesses generated by any
; observers affected by the broadcast TLBIMVAIS operation using the old mapping have completed
  
```

The completion of the TLB maintenance operation is guaranteed only by the execution of a DSB by the observer that performed the TLB maintenance operation. The execution of a DSB by a different observer does not have this effect, even if the DSB is known to be executed after the TLB maintenance operation is observed by that different observer.

## Paging memory in and out

In a multiprocessor system there is a requirement to ensure the visibility of translation table updates when paging regions of memory into RAM from a backing store. This might, or might not, also involve paging existing locations in memory from RAM to a backing store. In such situations, the operating system selects one or more pages of memory that might be in use but are suitable to discard, with or without copying to a backing store, depending on whether or not the region of memory is writable. Disabling the translation table mappings for a page, and ensuring the visibility of that update to the translation tables, prevents agents accessing the page.

For this reason, it is important that the DSB that is performed after the TLB invalidation ensures that no other updates to memory using those mappings are possible.

An example sequence for the paging out of an updated region of memory, and the subsequent paging in of memory, is as follows:

P1:

```
STR R11, [R1]          ; update the translation table for the region being paged out
DSB                    ; ensure visibility of the update to translation table walks
TLBIMVAIS R10         ; invalidate the old entry
DSB                    ; ensure completion of the invalidation on all processors
ISB                    ; ensure visibility of the invalidation
BL SaveMemoryPageToBackingStore
BL LoadMemoryFromBackingStore
DSB                    ; ensure completion of the memory transfer (this could be part of
                       ; LoadMemoryFromBackingStore
ICIALLUIS             ; also invalidates the branch predictor
STR R9, [R1]          ; create a new translation table entry with a new mapping
DSB                    ; ensure completion of instruction cache and branch predictor invalidation
                       ; and ensure visibility of the new translation table mapping
ISB                    ; ensure synchronization of this instruction stream
```

This example assumes the memory copies are performed by an observer that is coherent with the caches of processor P1. This observer might be P1 itself, using a specific paging mapping. For clarity, the example omits the functional descriptions of `SaveMemoryPageToBackingStore` and `LoadMemoryFromBackingStore`. `LoadMemoryFromBackingStore` is required to ensure that the memory updates that it makes are visible to instruction fetches.

In this example, the use of `ICIALLUIS` to invalidate the entire instruction cache is a simplification, that might not be optimal for performance. An alternative approach involves invalidating all of the lines in the caches using `ICIMVAU` operations. This invalidation must be done when the mapping used for the `ICIMVAU` operations is valid but not executable.

# Appendix H

## Legacy Instruction Mnemonics

This appendix describes the legacy mnemonics in the ARM instruction sets, and their *Unified Assembler Language* (UAL) equivalents. It contains the following sections:

- *Thumb instruction mnemonics* on page AppxH-2468
- *Other UAL mnemonic changes* on page AppxH-2469
- *Pre-UAL pseudo-instruction NOP* on page AppxH-2472.

## H.1 Thumb instruction mnemonics

Table H-1 lists the UAL equivalents of the mnemonics used in pre-UAL Thumb assembly language. Except where noted, the Thumb mnemonics conflict with UAL and cannot be supported by assemblers as synonyms. Software written in Thumb assembly language cannot be correctly assembled by a UAL assembler unless these changes are made.

All other Thumb instructions are the same in UAL as in Thumb assembler language, or can be supported as synonyms.

**Table H-1 Thumb instruction mnemonics**

Former Thumb assembler mnemonic	UAL equivalent
ADC	ADCS
ADD	ADDS <sup>a</sup>
AND	ANDS
ASR	ASRS
BIC	BICS
EOR	EORS
LSL	LSLS
MOV <Rd>, #<imm>	MOVVS <Rd>, #<imm>
MOV <Rd>, <Rn>	ADDS <Rd>, <Rn>, #0 <sup>b</sup>
MUL	MULS
MVN	MVNS
ORR	ORRS
ROR	RORS
SBC	SBCS
SUB	SUBS <sup>c</sup>

- a. If either or both of the operands is R8-R15, ADD not ADDS.
- b. If either or both of the operands is R8-R15, MOV <Rd>, <Rn> not ADDS <Rd>, <Rn>, #0.
- c. If the operand register is SP, SUB not SUBS.



## H.2 Other UAL mnemonic changes

Table H-2 lists the instruction mnemonics, other than the Thumb mnemonics listed in *Thumb instruction mnemonics on page AppxH-2468*, that are changed by the introduction of UAL.

———— **Note** ————

Most of these changes are in the mnemonics for VFP instructions. UAL does not define new mnemonics for the FLDMX and FSTMX instructions. For more information see *FLDMX, FSTMX on page A8-388*.

**Table H-2 Instruction mnemonics changed by the introduction of UAL**

Pre-UAL mnemonic	UAL equivalent	See
FABSD, FABSS	VABS	<i>VABS on page A8-824</i>
FADD, FADDS	VADD	<i>VADD (floating-point) on page A8-830</i>
FCMP, FCMP, FCMP, FCMPZ	VCMP{E}	<i>VCMP, VCMPE on page A8-864</i>
FCONSTD, FCONSTS	VMOV	<i>VMOV (immediate) on page A8-936</i>
FCPYD, FCPYS	VMOV	<i>VMOV (register) on page A8-938</i>
FCVTD, FCVTS	VCVT	<i>VCVT (between double-precision and single-precision) on page A8-876</i>
FDIVD, FDIVS	VDIV	<i>VDIV on page A8-882</i>
FLDD	VLDR	<i>VLDR on page A8-924</i>
FLDMD, FLDMS	VLDM, VPOP	<i>VLDM on page A8-922, VPOP on page A8-990</i>
FLDS	VLDR	<i>VLDR on page A8-924</i>
FMACD, FMACS	VMLA	<i>VMLA, VMLS (floating-point) on page A8-932</i>
FMDHR, FMDLR	VMOV	<i>VMOV (ARM core register to scalar) on page A8-940</i>
FMDRR	VMOV	<i>VMOV (between two ARM core registers and a doubleword extension register) on page A8-948</i>
FMRDH, FMRDL	VMOV	<i>VMOV (scalar to ARM core register) on page A8-942</i>
FMRRD	VMOV	<i>VMOV (between two ARM core registers and a doubleword extension register) on page A8-948</i>
FMRRS	VMOV	<i>VMOV (between two ARM core registers and two single-precision registers) on page A8-946</i>
FMRS	VMOV	<i>VMOV (between ARM core register and single-precision register) on page A8-944</i>
FMRX	VMRS	<i>VMRS on page B9-2012</i>
FMSCD, FMSCS	VNMLS	<i>VNMLA, VNMLS, VNMUL on page A8-970</i>
FMSR	VMOV	<i>VMOV (between ARM core register and single-precision register) on page A8-944</i>
FMSRR	VMOV	<i>VMOV (between two ARM core registers and two single-precision registers) on page A8-946</i>
FMSTAT	VMRS	<i>VMRS on page A8-954</i>
FMULD, FMULS	VMUL	<i>VMUL (floating-point) on page A8-960</i>

**Table H-2 Instruction mnemonics changed by the introduction of UAL (continued)**

<b>Pre-UAL mnemonic</b>	<b>UAL equivalent</b>	<b>See</b>
FMXR	VMSR	<i>VMSR</i> on page B9-2014
FNEGD, FNEGS	VNEG	<i>VNEG</i> on page A8-968
FNMACD, FNMACS	VMLS	<i>VMLA, VMLS (floating-point)</i> on page A8-932
FNMSCD, FNMSCS	VNMLA	<i>VNMLA, VNMLS, VNMUL</i> on page A8-970
FNMULD, FNMULS	VNMUL	<i>VNMLA, VNMLS, VNMUL</i> on page A8-970
FSHTOD, FSHTOS	VCVT	<i>VCVT (between floating-point and fixed-point, Floating-point)</i> on page A8-874
FSITOD, FSITOS	VCVT	<i>VCVT, VCVTR (between floating-point and integer, Floating-point)</i> on page A8-870
FSLTOD, FSLTOS	VCVT	<i>VCVT (between floating-point and fixed-point, Floating-point)</i> on page A8-874
FSQRTD, FSQRTS	VSQRT	<i>VSQRT</i> on page A8-1058
FSTD	VSTR	<i>VSTR</i> on page A8-1082
FSTMD, FSTMS	VSTM, VPUSH	<i>VSTM</i> on page A8-1080, <i>VPUSH</i> on page A8-992
FSTS	VSTR	<i>VSTR</i> on page A8-1082
FSUBD, FSUBS	VSUB	<i>VSUB (floating-point)</i> on page A8-1086
FTOSHD, FTOSHS	VCVT	<i>VCVT (between floating-point and fixed-point, Floating-point)</i> on page A8-874
FTOSI{Z}D, FTOSI{Z}S	VCVT{R}	<i>VCVT, VCVTR (between floating-point and integer, Floating-point)</i> on page A8-870
FTOSL, FTOUH	VCVT	<i>VCVT (between floating-point and fixed-point, Floating-point)</i> on page A8-874
FTOUI{Z}D, FTOUI{Z}S	VCVT{R}	<i>VCVT, VCVTR (between floating-point and integer, Floating-point)</i> on page A8-870
FTOULD, FTOULS, FUHTOD, FUHTOS	VCVT	<i>VCVT (between floating-point and fixed-point, Floating-point)</i> on page A8-874
FUITOD, FUITOS	VCVT	<i>VCVT, VCVTR (between floating-point and integer, Floating-point)</i> on page A8-870
FULTOD, FULTOS	VCVT	<i>VCVT (between floating-point and fixed-point, Floating-point)</i> on page A8-874
LSLS <Rd>, <Rn>, #0	MOVS <Rd>, <Rm>	<i>MOV (register, Thumb)</i> on page A8-486, <i>MOV (register, ARM)</i> on page A8-488
NEG <Rd>, <Rm>	RSB <Rd>, <Rn>, #0	<i>RSB (immediate)</i> on page A8-574
QADDSUBX	QASX	<i>QASX</i> on page A8-546
QSUBADDX	QSAX	<i>QSAX</i> on page A8-552
SADDSUBX	SASX	<i>SASX</i> on page A8-590
SHADDSUBX	SHASX	<i>SHASX</i> on page A8-612
SHSUBADDX	SHSAX	<i>SHSAX</i> on page A8-614
SMI	SMC	<i>SMC (previously SMI)</i> on page B9-2000
SSUBADDX	SSAX	<i>SSAX</i> on page A8-656

**Table H-2 Instruction mnemonics changed by the introduction of UAL (continued)**

<b>Pre-UAL mnemonic</b>	<b>UAL equivalent</b>	<b>See</b>
SWI	SVC	<i>SVC (previously SWI) on page A8-720</i>
UADDSUBX	UASX	<i>UASX on page A8-754</i>
UEXT16	UXTH	<i>UXTH on page A8-816</i>
UEXT8	UXTB	<i>UXTB on page A8-812</i>
UHADDSUBX	UHASX	<i>UHASX on page A8-766</i>
UHSUBADDX	UHSAX	<i>UHSAX on page A8-768</i>
UQADDSUBX	UQASX	<i>UQASX on page A8-784</i>
UQSUBADDX	UQSAX	<i>UQSAX on page A8-786</i>
USUBADDX	USAX	<i>USAX on page A8-800</i>

### H.3 Pre-UAL pseudo-instruction NOP

In pre-UAL assembler, NOP is a pseudo-instruction, equivalent to:

- MOV R0, R0 in the ARM instruction set
- MOV R8, R8 in the Thumb instruction set.

Assembling the NOP mnemonic as UAL will not change the functionality of the assembled software, but will change:

- the instruction encoding selected
- the architecture variants on which the resulting binary will execute successfully, because the NOP instruction was introduced in ARMv6K and ARMv6T2.

To avoid these changes, replace NOP in the assembler source code with the appropriate one of MOV R0, R0 and MOV R8, R8, before assembling as UAL.

# Appendix I

## Deprecated and Obsolete Features

This appendix contains the following sections:

- *Deprecated features* on page AppxI-2474
- *Obsolete features* on page AppxI-2483
- *Use of the SP as a general-purpose register* on page AppxI-2484
- *Explicit use of the PC in ARM instructions* on page AppxI-2485
- *Deprecated Thumb instructions* on page AppxI-2486.

## I.1 Deprecated features

The features described in this section are present in ARMv7 for backwards compatibility. You must avoid using them in new applications where possible. They might not be present in future versions of the ARM architecture.

See also *Explicit use of the PC in ARM instructions* on page AppxI-2485.

———— **Note** —————

*Use of the SP as a general-purpose register* on page AppxI-2484 describes cases that were deprecated in earlier issues of this manual but are no longer deprecated.

The following subsections give more information about the deprecated features:

- *Use of SWP and SWPB semaphore instructions* on page AppxI-2475
- *Use of VFP vector mode* on page AppxI-2475
- *Use of VFP FLDMX and FSTMX instructions* on page AppxI-2475
- *Use of the Fast Context Switch Extension* on page AppxI-2475
- *Direct manipulation of the Endianness bit* on page AppxI-2475
- *Ordering of instructions that change the CPSR interrupt masks* on page AppxI-2475
- *Shareability of Device memory regions* on page AppxI-2475
- *Unaligned exception returns* on page AppxI-2476
- *Deprecations relating to using the AP[2:0] scheme for defining MMU access permissions* on page AppxI-2476
- *Use of the Domain field in the DFSR* on page AppxI-2476
- *Use of the CP15 memory barrier operations* on page AppxI-2476
- *Deprecations that affect use of the SCTLR* on page AppxI-2477
- *Interrupts or asynchronous aborts in a sequence of memory transactions* on page AppxI-2477
- *Use of Instruction TLB and Data TLB operations* on page AppxI-2477
- *Use of old mnemonics for operations to invalidate entries in a unified TLB* on page AppxI-2478
- *Use of ATSI2NSO\*\* and ATSIH\* operations from Secure modes at PL1* on page AppxI-2478
- *Use of old mnemonics for address translation operations* on page AppxI-2479
- *Use of the NSACR.RFR bit* on page AppxI-2479
- *Conditional execution of Advanced SIMD instructions* on page AppxI-2479
- *Use of ThumbEE instructions* on page AppxI-2479
- *Deprecations that apply to Debug operation* on page AppxI-2480.

### I.1.1 Use of SWP and SWPB semaphore instructions

The ARM instruction set includes two semaphore instructions, Swap (SWP) and Swap Byte (SWPB), that are provided for process synchronization. Both instructions generate a load access and a store access to the same memory location, such that no other access to that location is permitted between the load access and the store access. This enables a memory semaphore to be loaded and altered without interruption. These semaphore instructions do not provide a compare and conditional write facility. If this is required, it must be done explicitly.

From ARMv6, ARM deprecates any use of the SWP and SWPB instructions, and strongly recommends that all software uses the Load-Exclusive and Store-Exclusive synchronization primitives. For more information see [Synchronization and semaphores on page A3-114](#) and the descriptions of the CLREX, LDREX, LDREXB, LDREXD, LDREXH, STREX, STREXB, STREXD and STREXH instructions.

From the introduction of the Virtualization Extensions, implementation of SWP and SWPB is optional. If an implementation does not support the SWP and SWPB instructions, the ID\_ISAR0.Swap\_insts and ID\_ISAR4.SWP\_frac fields are zero, see [About the Instruction Set Attribute registers on page B7-1950](#).

———— **Note** —————

Although an implementation of the ARMv7-R profile cannot include the Virtualization Extensions, the SWP and SWPB instructions become optional in both the ARMv7-A profile and the ARMv7-R profile.

### I.1.2 Use of VFP vector mode

From ARMv7, ARM deprecates any use of VFP vector mode. For more information see [Appendix K VFP Vector Operation Support](#).

### I.1.3 Use of VFP FLDMX and FSTMX instructions

From ARMv6, ARM deprecates any use of VLDM.64 and VSTM.64 instruction encodings with an odd immediate offset. This deprecation includes any use of their pre-UAL mnemonics FLDMX and FSTMX, except for disassembly purposes. For details see [FLDMX, FSTMX on page A8-388](#).

### I.1.4 Use of the Fast Context Switch Extension

From ARMv6, ARM deprecates any use of the *Fast Context Switch Extension* (FCSE), and the Multiprocessing Extensions make the FCSE obsolete. For more information see [Fast Context Switch Extension on page AppxI-2483](#).

### I.1.5 Direct manipulation of the Endianness bit

ARM deprecates the use of the MSR instruction to write the Endianness bit in User mode, and strongly recommends that software executing in User mode uses the SETEND instruction.

### I.1.6 Ordering of instructions that change the CPSR interrupt masks

ARMv6 deprecated any dependence on an ordering of instructions that change the CPSR interrupt masks that is required in ARMv5, and ARMv7 makes this ordering requirement obsolete. For more information see [Ordering of instructions that change the CPSR interrupt masks on page AppxI-2483](#).

### I.1.7 Shareability of Device memory regions

ARM deprecates the marking of Device memory with a shareability attribute other than Outer Shareable or Shareable. This means that ARM strongly recommends that Device memory is never marked as Non-shareable or as Inner Shareable. See [Shareable attribute for Device memory regions on page A3-136](#).

### I.1.8 Unaligned exception returns

ARM deprecates any dependence on the requirements that the hardware ignores bits of the address transferred to the PC on an exception return. See [Alignment of exception returns on page B1-1195](#).

### I.1.9 Deprecations relating to using the AP[2:0] scheme for defining MMU access permissions

For more information about the deprecations described in this section see [Access permissions on page B3-1356](#).

From the introduction of the Large Physical Address Extension, ARM deprecates any use of the AP[2:0] scheme for defining MMU access permissions. This deprecation applies to software for all ARMv7-A implementations, regardless of whether they include the Large Physical Address Extension.

#### Use of AP[2] = 1, AP[1:0] = 0b10

For any ARMv7 implementation, in any application that uses AP[2:0] scheme to define the MMU access permissions, ARM deprecates using the encoding with AP[2] = 1, AP[1:0] = 0b10. This encoding means read-only for accesses at all privilege levels. Instead, applications should use the encoding AP[2] = 1, AP[1:0] = 0b11.

### I.1.10 Use of the Domain field in the DFSR

ARM deprecates any use of the Domain field in the DFSR. For more information see [The Domain field in the DFSR on page B3-1415](#).

———— **Note** —————

The new translation table format introduced by the Large Physical Address Extension does not support Domains.

### I.1.11 Use of the CP15 memory barrier operations

ARM deprecates any use of the CP15 c7 memory barrier operations. The ARM and Thumb instruction sets include instructions that perform these operations. [Table I-1](#) shows the deprecated CP15 encodings and the replacement ARMv7 instructions.

**Table I-1 Deprecated CP15 c7 memory barrier operations**

Deprecated CP15 encoding				Operation	Instruction description
CRn	opc1	CRm	opc2		
c7	0	c5	4	Instruction Synchronization Barrier	See <a href="#">ISB on page A8-389</a>
c7	0	c10	4	Data Synchronization Barrier	See <a href="#">DSB on page A8-380</a>
c7	0	c10	5	Data Memory Barrier	See <a href="#">DMB on page A8-378</a>



## Deprecated barrier terminology

In versions of the ARM architecture before ARMv7, some barrier operations were provided as CP15 operations. Some documentation uses different names for these barriers. [Table I-2](#) shows terms that were used in earlier editions of the *ARM Architecture Reference Manual*, and the supplements to it, that are no longer used. The replacement terms are not in general exact synonyms, but might reflect altered behavior more accurately.

**Table I-2 Deprecated terminology**

Current terminology	Deprecated old terminology
Data Synchronization Barrier (DSB)	Drain Write Buffer, Data Write Barrier (DWB)
Instruction Synchronization Barrier (ISB)	Prefetch Flush (PFF)

### I.1.12 Deprecations that affect use of the SCTLR

The following subsections describe deprecations that affect software use of the System Control Register, SCTLR.

#### Use of Hivecs exception base address in PMSA implementations

ARM deprecates any use of the high vector exception base address (Hivecs) of `0xFFFF0000` in PMSA implementations. ARM strongly recommends that Hivecs is used only in VMSEA implementations. This means that, for a PMSA implementation, ARM strongly recommends that, in a PMSA implementation, software never sets `SCTLR.V` to 1. For more information, see [Exception vectors and the exception base address on page B1-1164](#).

#### Hardware management of the Access flag

From the introduction of the Virtualization Extensions, ARM deprecates implementation or use of hardware management of the Access flag. On an implementation that support hardware management of the Access flag, ARM deprecates setting `SCTLR.HA` to 1 to enable this feature. For more information see [Hardware management of the Access flag on page B3-1363](#).

#### Use of the SCTLR.VE bit

From the introduction of the Virtualization Extensions, ARM deprecates any use of the `SCTLR.VE` bit. For more information see [Vectored interrupt support on page B1-1167](#). This deprecation applies to all ARMv7 implementations, including PMSAv7 implementations, regardless of whether they implement any of the optional architectural extensions described in this manual.

### I.1.13 Interrupts or asynchronous aborts in a sequence of memory transactions

ARM deprecates any reliance by software on the behavior that an interrupt or asynchronous abort cannot occur in a sequence of single-copy atomic memory transactions generated by a single load/store instruction to Normal memory. For more information, see [Low interrupt latency configuration on page B1-1197](#).

### I.1.14 Use of Instruction TLB and Data TLB operations

Previous versions of the ARM architecture defined TLB operations that were specific to Instruction TLBs, or to Data TLBs. ARMv7 supports these instructions only for backwards compatibility, and ARM deprecates their use. The deprecated operations are:

- the instruction TLB operations [ITLBIALL](#), [ITLBIMVA](#), and [ITLBIASID](#)
- the data TLB operations [DTLBIALL](#), [DTLBIMVA](#), and [DTLBIASID](#).

For more information see:

- [General TLB maintenance requirements on page B3-1381](#)
- [TLB maintenance operations, not in Hyp mode on page B4-1743](#).

### I.1.15 Use of old mnemonics for operations to invalidate entries in a unified TLB

The ARMv7-A architecture, without the multiprocessing extensions, defines three CP15 c8 operations to invalidate entries in a unified TLB. The mnemonics for these defined in issue A of this manual have changed, each dropping the initial U. The original mnemonics remain synonyms for the operations, but ARM deprecates using the old mnemonics. [Table I-3](#) shows the changed mnemonics and the encodings of the operations.

**Table I-3 Changed mnemonics for CP15 c8 unified TLB operations**

Encoding				Operation	Mnemonic	
CRn	opc1	CRm	opc2		New	Deprecated
c8	0	c7	0	Invalidate entire unified TLB	<a href="#">TLBIALL</a>	UTLBIALL
			1	Invalidate unified TLB by MVA and ASID	<a href="#">TLBIMVA</a>	UTLBIMVA
			2	Invalidate unified TLB by ASID match	<a href="#">TLBIASID</a>	UTLBIASID

For more information about these operations see [TLB maintenance operations, not in Hyp mode](#) on page B4-1743.

### I.1.16 Use of ATS12NSO\*\* and ATS1H\* operations from Secure modes at PL1

From the introduction of the Large Physical Address Extension, ARM deprecates using the ATS12NSO\*\* and ATS1H\* translation table operations from Secure modes other than Monitor mode, that is, from Secure modes in which software executes at PL1. This deprecation applies to the following operations:

- [ATS12NSOPR](#), [ATS12NSOPW](#), [ATS12NSOUR](#), and [ATS12NSOUW](#)
- [ATS1HR](#) and [ATS1HW](#).

These are the Non-secure address translation stages 1 and 2 operations, and the Hyp mode address translation stage 1 operations.

———— **Note** —————

- [Use of old mnemonics for address translation operations](#) on page AppxI-2479 summarizes a change to the mnemonics for the ATS12NSO\*\* operations, also introduced with the Large Physical Address Extension.
- The ATS1H\* operations are part of the Virtualization Extensions.
- This deprecation applies to any use of these operations, not only to the use of their mnemonics.

For more information see [Naming of the address translation operations, and operation summary](#) on page B3-1438.

### I.1.17 Use of old mnemonics for address translation operations

The introduction of the Large Physical Address Extension renames the mnemonics for the CP15 c7 address translation operations. To maximize future compatibility, ARM deprecates using the old mnemonics in software written for any processor that supports the new mnemonics. [Table I-4](#) shows the changed mnemonics and the encodings of the operations.

**Table I-4 Changed mnemonics for CP15 c7 address translation operations**

Encoding				Operation	Mnemonic	
CRn	opc1	CRm	opc2		New	Deprecated
c7	0	c8	0	PL1stage 1 read translation, current state	<a href="#">ATS1CPR</a>	V2PCWPR
			1	PL1 stage 1 write translation, current state	<a href="#">ATS1CPW</a>	V2PCWPW
			2	Unprivileged stage 1 read translation, current state	<a href="#">ATS1CUR</a>	V2PCWUR
			3	Unprivileged stage 1 write translation, current state	<a href="#">ATS1CUW</a>	V2PCWUW
c7	0	c8	4	Non-secure PL1 stage 1 and 2 read translation	<a href="#">ATS12NSOPR</a>	V2POWPR
			5	Non-secure PL1 stage 1 and 2 write translation	<a href="#">ATS12NSOPW</a>	V2POWPW
			6	Non-secure unprivileged stage 1 and 2 read translation	<a href="#">ATS12NSOUR</a>	V2POWUR
			7	Non-secure unprivileged stage 1 and 2 write translation	<a href="#">ATS12NSOUW</a>	V2POWUW

———— **Note** —————

The Virtualization Extensions introduce additional address translation operations. The only mnemonics for these operations use the new naming scheme.

For more information see [Naming of the address translation operations, and operation summary on page B3-1438](#).

### I.1.18 Use of the NSACR.RFR bit

From the introduction of the Virtualization Extensions, ARM deprecates any use of the [NSACR.RFR](#) bit. This deprecation applies to any ARMv7 implementation that includes the Security Extensions, regardless of whether the implementation also includes the Virtualization Extensions.

### I.1.19 Conditional execution of Advanced SIMD instructions

ARM deprecates any conditional execution of any instruction encoding provided by the Advanced SIMD extension that is not also provided by the Floating-point (VFP) Extension. For more information, see [Conditional execution on page A8-288](#).

### I.1.20 Use of ThumbEE instructions

From the publication of issue C.a of this manual, ARM deprecates any use of ThumbEE instructions.

This deprecation applies to all implementations of ARMv7.

## I.1.21 Deprecations that apply to Debug operation

The following subsections describe deprecations that apply to Debug operation. That is, they apply to features described in part C of this manual:

- [Debug Status and Control Register deprecations](#)
- [Watchpoint Fault Address Register deprecations](#)
- [Escalation of privilege level on CP14 and CP15 accesses in Debug state](#)
- [Use of Secure User halting debug](#)
- [Reading the Debug Program Counter Sampling Register as register 33 on page AppxI-2481](#)
- [Escalation of privilege level by Debug state writes to the CPSR on page AppxI-2481](#)
- [Use of the CP14 interface to access certain registers and register bits on page AppxI-2481](#)
- [Use of CP14 accesses to the DCC when the OS Lock is not set on page AppxI-2481](#)
- [Use of a single breakpoint to set breakpoints on more than one instruction on page AppxI-2481](#)
- [Use of breakpoint address masks on page AppxI-2481](#)
- [Use of a byte address select in DBGWCR that is not continuous on page AppxI-2481](#)
- [Use of a byte address select in DBGWCR that is not continuous on page AppxI-2481](#)

### Debug Status and Control Register deprecations

ARM deprecates a number of possibly uses of fields in the `DBGDSCR`. Some of the deprecations apply only to particular views of the register, or to particular methods of access to the register.

———— **Note** ————

These deprecations apply to all ARMv7 implementations. Some of the deprecated uses are not supported by v7.1 Debug.

For more information, see the register description and [Internal and external views of the DBGDSCR and the DCC registers on page C8-2165](#).

### Watchpoint Fault Address Register deprecations

ARM deprecates any use of the CP15 alias of the *Watchpoint Fault Address Register* (`DBGWFAR`), and strongly recommends that software uses the CP14 `DBGWFAR` instead. For more information see [The CP14 debug register interface on page C6-2121](#).

ARM also deprecates using `DBGWFAR` to determine the address of the instruction that triggered a synchronous Watchpoint debug event. For more information see:

- for a VMSA implementation, [Data Abort on a Watchpoint debug event on page B3-1412](#) and [Register updates on exception reporting at PL2 on page B3-1422](#)
- for a PMSA implementation, [Data Abort exception on a Watchpoint debug event on page B5-1768](#)
- [Effect of entering Debug state on CP15 registers and the DBGWFAR on page C5-2094](#).

### Escalation of privilege level on CP14 and CP15 accesses in Debug state

Except for `DBGDTRRXint` and `DBGDTRTXint`, ARM deprecates accessing any CP14 or CP15 register from User mode in Debug state if that register cannot be accessed from User mode in Non-debug state. For more information, see [Behavior of coprocessor and Advanced SIMD instructions in Debug state on page C5-2102](#).

### Use of Secure User halting debug

From v7 Debug, ARM deprecates the use of Secure User halting debug, and v7.1 Debug makes Secure User halting debug obsolete. See [Secure User halting debug on page AppxI-2483](#).

### Reading the Debug Program Counter Sampling Register as register 33

ARM deprecates reading the `DBGPCSR` as debug register 33 when it is also implemented as debug register 40. For more information see [Sample-based profiling on page C10-2188](#).

### Escalation of privilege level by Debug state writes to the CPSR

When the processor is in User mode in Debug state, ARM deprecates updating any `CPSR` bit or field other than `CPSR.M` if software running in User mode in Non-debug state cannot update that field. For more information see [Altering CPSR privileged bits in Debug state on page C5-2098](#).

### Use of the CP14 interface to access certain registers and register bits

In v7 Debug, ARM deprecates using the CP14 interface to:

- access the `DBGDRCR`
- access the `DBGECR`
- write to the following bits of the `DBGPRCR`:
  - `DBGPRCR.HCWR`, Hold core warm reset
  - `DBGPRCR.CWRR`, Core warm reset request.

### Use of CP14 accesses to the DCC when the OS Lock is not set

When `DBGOSLSR.OSLK` is set to 0, meaning the OS Lock is not set, ARM deprecates using the CP14 interface to:

- read `DBGDSCRext`
- write to `DBGDSCRext`, if the processor is in Debug state
- access `DBGDTRRXext` or `DBGDTRTXext`.

For more information see [Accesses to the registers in v7.1 Debug on page C8-2171](#).

This deprecation is made with the introduction of v7.1 Debug, but applies to all ARMv7 implementations.

### Use of a single breakpoint to set breakpoints on more than one instruction

When setting breakpoints on Thumb or ThumbEE instructions, or on Java bytecodes, it is possible use `DBGBCR.BAS` to define a single breakpoint that covers more than one instruction. ARM deprecates doing so.

For more information see [Byte address selection behavior on instruction address match or mismatch on page C3-2047](#).

### Use of breakpoint address masks

`DBGBCR.MASK` is a breakpoint address mask field. ARM deprecates setting `DBGBCR.MASK` to a nonzero value.

For more information, see [Breakpoint address range masking behavior on page C3-2049](#).

### Use of a byte address select in DBGWCR that is not continuous

`DBGWCR.BAS` is a byte address select mask field. ARM deprecates setting discontinuous bits in this field. This means that, for example:

- in an implementation with a 4-bit BAS field:
  - field values of `0b0001`, `0b0011`, `0b0110`, `0b1110`, and similar, are permitted
  - field values of `0b0101`, `0b1001`, `0b1011`, `0b1101`, and similar, are deprecated
- in an implementation with a 8-bit BAS field:
  - field values of `0b00000001`, `0b00011000`, `0b00111000`, and similar, are permitted
  - field values of `0b00001010`, `0b00100011`, `0b01011010`, `0b11010110`, and similar, are deprecated.

ARM also deprecates setting the BAS field to zero.

For more information see the [DBGWCR](#) description and [Byte address selection behavior on data address match on page C3-2060](#).

### **Use of Vector catch debug events with Monitor debug-mode**

[DBGVCR](#) controls generation of Vector catch debug events. ARM deprecates use of [DBGVCR](#) by self-hosted debug software using Monitor debug-mode.

## I.2 Obsolete features

The features described in the following sections are obsolete.

### I.2.1 Rotated aligned accesses

Unaligned accesses, where permitted, were treated as rotated aligned accesses before ARMv6. This behavior was configurable, but deprecated, in ARMv6. It is obsolete in ARMv7. For more information, see [Alignment on page AppxL-2504](#).

### I.2.2 Ordering of instructions that change the CPSR interrupt masks

Any ARMv5 instruction that implicitly or explicitly changes the interrupt masks in the **CPSR** and appears in program order after a Strongly-ordered access must wait for the Strongly-ordered memory access to complete, see [Ordering of instructions that change the CPSR interrupt masks on page AppxL-2506](#) for more information.

ARMv6 deprecated any reliance on this behavior, and this behavior is obsolete in ARMv7. Software must not rely on this behavior. ARM strongly recommends that software uses an explicit memory barrier instead.

### I.2.3 ARM LDM and POP instructions that both writeback and load their base registers

LDM instructions and multi-register POP instructions that specify base register writeback and load their base register are permitted but deprecated before ARMv7, as described in [Different definition of some LDM and POP instructions on page AppxL-2512](#). Use of such instructions is obsolete in ARMv7.

### I.2.4 Fast Context Switch Extension

ARMv6 and ARMv7 deprecate use of the *Fast Context Switch Extension* (FCSE). The FCSE is optional in ARMv7, and it is obsolete from the ARMv7 Multiprocessing Extensions.

For details of the FCSE see [Appendix J Fast Context Switch Extension \(FCSE\)](#).

### I.2.5 Support for BE-32 endianness model

BE-32 is a legacy byte-invariant big endian memory model supported in ARMv4 and ARMv5, see [Endian support on page AppxO-2591](#) in [Appendix O ARMv4 and ARMv5 Differences](#). In ARMv6, it is IMPLEMENTATION DEFINED whether an implementation supports BE-32. ARMv7 does not support BE-32. See [Instruction endianness on page A3-111](#) for more information.

### I.2.6 Secure User halting debug

From v7 Debug, ARM deprecates the use of Secure User halting debug, and v7.1 Debug makes Secure User halting debug obsolete. For more information, see [About invasive debug authentication on page C2-2028](#).

## I.3 Use of the SP as a general-purpose register

In the Thumb instruction set, software can use the SP (R13) only in a restricted set of instructions. This set covers the legitimate uses of the SP as a stack pointer. An attempt to encode any other instruction with SP in place of a legitimate register results in either UNPREDICTABLE behavior, or a different instruction. In addition, ARM deprecates the use of SP (R13) in some 16-bit Thumb instructions, as described in [Deprecated Thumb instructions on page AppxI-2486](#).

Most ARM instructions, unlike Thumb instructions, provide exactly the same access to the SP as to R0-R12. This means that it is possible to use the SP as a general-purpose register. Earlier issues of this manual deprecated the use of SP in an ARM instruction, in any way that is deprecated, not permitted, or not possible in the corresponding Thumb instruction. However, user feedback indicates a number of cases where these instructions are useful. Therefore, ARM no longer deprecates these instruction uses.



## I.4 Explicit use of the PC in ARM instructions

The explicit use of the PC in an ARM instruction is not usually useful, and except for specific instances that are useful, ARM deprecates any such use. Table I-5 shows where ARM instructions can explicitly use the PC. ARM deprecates all other explicit use of the PC.

———— **Note** —————

Implicit use of the PC, for example in branch instructions or load (literal) instructions, is never deprecated.

**Table I-5 Non-deprecated uses of the PC in ARM instructions**

Instruction	Non-deprecated use of PC
All load and preload instructions	As destination register or base register. <sup>a</sup>
<i>ADD (immediate, ARM)</i> on page A8-308	As destination register.
<i>ADD (register, ARM)</i> on page A8-312	As destination register, source register, or both.
<i>ADD (SP plus immediate)</i> on page A8-316	As destination register.
<i>ADR</i> on page A8-322	As destination register. <sup>b</sup>
<i>MOV (register, ARM)</i> on page A8-488	As destination register or source register, but not both. <sup>c</sup>
<i>SUB (immediate, ARM)</i> on page A8-710	As destination register.
<i>SUB (register)</i> on page A8-712	As destination register.
<i>SUB (SP minus immediate)</i> on page A8-716	As destination register.
<i>SUB (SP minus register)</i> on page A8-718	As destination register.
<i>SUBS PC, LR and related instructions (ARM)</i> on page B9-2010. This includes all MOV <sub>S</sub> and SUB <sub>S</sub> instructions with the PC as a destination register.	As destination register. <sup>d</sup>

- a. Only if the instruction description permits the register to be the PC.
- b. Some forms of the ADR instruction can be expressed as forms of ADD or SUB, with the PC as the destination register. Those forms of ADD and SUB are permitted, and not deprecated.
- c. ARM deprecates transfer of the PC to or update of the PC from the SP.
- d. This is the only row of this table that describes MOV<sub>S</sub> and SUB<sub>S</sub> instructions with the PC as the destination register.

## 1.5 **Deprecated Thumb instructions**

Most deprecated instructions are in the ARM instruction set. Deprecated Thumb instructions are:

- use of PC as <Rd> or <Rm> in a 16-bit ADD (SP plus register) instruction
- use of SP as <Rm> in:
  - a 16-bit ADD (SP plus register) instruction
  - a 16-bit CMP (register) instruction
  - a 16-bit BLX (register) or BX instruction
- use of MOV (register) instructions in which both <Rd> and <Rm> are the SP or PC
- use of Rn as the lowest-numbered register in the register list of a 16-bit STM instruction with base register writeback
- use of UDF in an IT block.

# Appendix J

## Fast Context Switch Extension (FCSE)

This appendix describes the *Fast Context Switch Extension* (FCSE). It contains the following sections:

- [About the FCSE on page AppxJ-2488](#)
- [Modified virtual addresses on page AppxJ-2489](#)
- [Debug and trace on page AppxJ-2491](#).

---

### Note

---

- From ARMv6, ARM deprecates any use of the FCSE mechanism. The FCSE is optional in ARMv7, and the ARMv7 Multiprocessing Extensions obsolete the FCSE.
  - Use of both the FCSE and the ASID based memory attribute results in UNPREDICTABLE behavior. Either the FCSE must be cleared, or all memory declared as global.
-

## J.1 About the FCSE

The *Fast Context Switch Extension* (FCSE) modifies the behavior of an ARM memory system. This modification permits multiple programs running on the ARM processor to use identical address ranges, while ensuring that the addresses they present to the rest of the memory system differ.

Normally, in a VMSA implementation, a swap between two software processes whose address ranges overlap requires changes to be made to the virtual-to-physical address mapping defined by the MMU translation tables, see [Short-descriptor translation table format on page B3-1324](#). Before ARMv6, this also typically caused cache and TLB contents to become invalid, because they related to the old virtual-to-physical address mapping, and therefore required caches and TLBs to be flushed. As a result, each process swap had a considerable overhead, both directly because of the cost of changing the translation tables and indirectly because of the cost of subsequently reloading caches and TLBs.

By presenting different addresses to the rest of the memory system for different software processes even when they are using identical addresses, the FCSE avoided this overhead. It also permitted software processes to use identical address ranges even if the rest of the memory system did not support virtual-to-physical address mapping.

ARMv6 removed the maintenance and subsequent reload overhead of such process swaps, effectively removing the benefit of the FCSE. Therefore, from ARMv6, ARM deprecated any use of the FCSE mechanism. The FCSE is optional in ARMv7, and the ARMv7 Multiprocessing Extensions obsolete the FCSE.

In a VMSA implementation, the FCSE translation is the first stage of the memory access sequence. That is, the processor performs the FCSE translation before it starts the address translation summarized in [About address translation on page B3-1311](#). The FCSE translates a *Virtual Address* (VA) supplied by the processor to a *Modified Virtual Address* (MVA).

### J.1.1 FCSE requirements when the MMU is disabled

The FCSE PID is SBZ when the MMU is disabled. This is the reset value for the FCSE PID. Behavior is UNPREDICTABLE if the FCSE PID is not zero when the MMU is disabled.

Software must clear the FCSE PID to zero before disabling the MMU.

### J.1.2 Memory system restrictions when the FCSE is implemented

When `FCSEIDR[31:25]` is not `0b0000000`, the use of non-global memory regions is UNPREDICTABLE.

### J.1.3 Use of CP15 c7 address translation operations when the FCSE is implemented

If an implementation includes the FCSE, the VA required as the input address for the CP15 c7 address translation operations is the VA before any modification by the FCSE, not the MVA. For more information about these operations see:

- [Virtual Address to Physical Address translation operations on page B3-1438](#)
- [Performing address translation operations on page B4-1747](#).

## J.2 Modified virtual addresses

The 4GB virtual address space is divided into 128 process blocks, each of size 32MB. Each process block can contain a program that has been compiled to use the address range 0x00000000 to 0x01FFFFFF. For each of  $i=0$  to 127, process block  $i$  runs from address  $(i \times 0x02000000)$  to address  $(i \times 0x02000000 + 0x01FFFFFF)$ .

The FCSE processes each virtual address for a memory access generated by the ARM processor to produce a *modified virtual address*, that is sent to the rest of the memory system to be used in place of the normal virtual address. For an MMU-based memory system, the process is illustrated in Figure J-1:

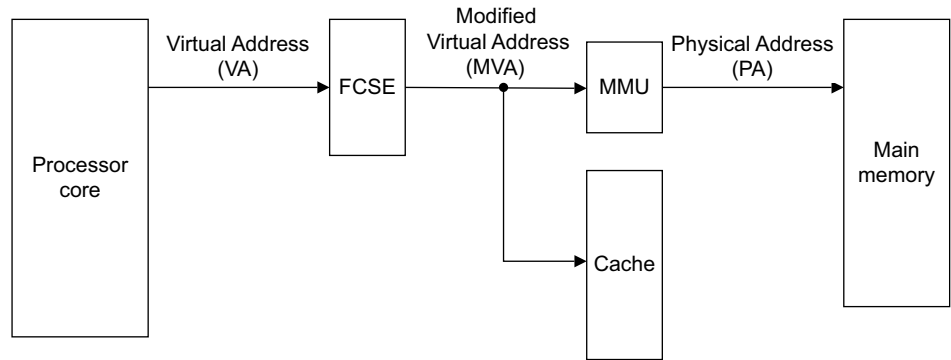

Figure J-1 Address flow in MMU memory system with FCSE

When the ARM processor generates a memory access, the translation of the Virtual Address (VA) into the Modified Virtual Address (MVA) is described by the `FCSETranslate()` function in [FCSE translation on page B3-1503](#).

When the top seven bits of the address are zero, the translation replaces these bits by the value of `FCSEIDR.PID`, and otherwise the translation leaves the address unchanged. When `FCSEIDR.PID` has its reset value of `0b0000000`, the FCSE always leaves the address unchanged, meaning that the FCSE is effectively disabled.

The value of `FCSEIDR.PID` is also called the *FCSE process ID* of the current process.

The effect of setting the `FCSEIDR` to a nonzero value at a time when any translation table entries have enabled the alternative Context ID, ASID-based support (`nG bit == 1`) is UNPREDICTABLE. For more information about ASIDs see [About the VMSA on page B3-1308](#).

———— **Note** ————

Virtual addresses are sometimes passed to the memory system as data. For these operations, no address modification occurs, and  $MVA = VA$ .

Each process is compiled to use the address range 0x00000000 to 0x01FFFFFF. When referring to its own instructions and data, therefore, the program generates VAs whose top seven bits are all zero. The resulting MVAs have their top seven bits replaced by `FCSEIDR.PID`, and so lie in the process block of the current process.

The program can also generate VAs whose top seven bits are not all zero. When this happens, the MVA is equal to the VA. This enables the program to address the process block of another process, provided the other process does not have process ID 0. Provided access permissions are set correctly, this can be used for inter-process communication.

———— **Note** ————

ARM recommends that only process IDs 1 and above are used for general-purpose processes, because the process with process ID 0 cannot be communicated with in this fashion.

Use of the FCSE therefore reduces the cost of a process swap to:

- The cost of a write of the [FCSEIDR.PID](#).
- The cost of changing access permissions if they need changing for the new process. In an MMU-based system, this might involve changing the translation table entries individually, or pointing to a new translation table by changing one or more of [TTBR0](#), [TTBR1](#), and [TTBCR](#). Any change to the translation tables is likely to involve invalidation of the TLB entries affected. However, this is usually significantly cheaper than the cache flush that would be required without the FCSE. Also, in some cases, changes to the translation table, and the associated explicit TLB management, can be avoided by the use of domains. This reduces the cost to that of a write to the Domain Access Control Register, see [Domains, Short-descriptor format only on page B3-1362](#).

As stated at the start of this appendix, ARMv6 deprecates use of the FCSE, and the FCSE is:

- obsoleted from the introduction of the ARMv7 Multiprocessing Extensions
- optional in earlier ARMv7 implementations.

## J.3 Debug and trace

It is IMPLEMENTATION DEFINED whether a VA or MVA is used by breakpoint and watchpoint mechanisms. However, ARM strongly recommends that any implementation that includes the FCSE uses MVAs, to avoid trigger aliasing.

The implementation can support watchpoint generation on cache maintenance operations by MVA, as described in [Generation of Watchpoint debug events on page C3-2057](#), only if it uses MVAs for watchpoint generation.

### J.3.1 Addresses used for the generation of debug events

On a processor that implements the *Fast Context Switch Extension* (FCSE):

- It is IMPLEMENTATION DEFINED whether the address used in generating Breakpoint debug events is the *Modified Virtual Address* (MVA) or *Virtual Address* (VA) of the instruction.
- It is IMPLEMENTATION DEFINED whether the address used in generating Watchpoint debug events is the MVA or VA of the data access.
- The address used in generating Vector catch debug events is always the VA of the instruction.
- The *Watchpoint Fault Address Register*, [DBGWFAR](#), returns a VA plus an offset that depends on the processor instruction set state.
- The *Program Counter Sampling Register*, [DBGPCSR](#), if implemented, returns a VA plus an offset that depends on the processor instruction set state.





# Appendix K

## VFP Vector Operation Support

This appendix provides reference information about VFP vector operation.

This appendix contains the following sections:

- [About VFP vector mode on page AppxK-2494](#)
- [Vector length and stride control on page AppxK-2495](#)
- [VFP register banks on page AppxK-2496](#)
- [VFP instruction type selection on page AppxK-2497](#).

---

### Note

---

- ARM deprecates any use of VFP vector mode. This information is provided for backwards compatibility only.
  - Both [Chapter B4 System Control Registers in a VMSA implementation](#) and [Chapter B6 System Control Registers in a PMSA implementation](#) describe the VFP control registers, that are included in both VMSA and PMSA implementations, with identical bit assignments. However, most register references in this appendix link to the register descriptions in [Chapter B4](#).
-

## K.1 About VFP vector mode

The single-precision registers can hold short vectors of up to 8 single-precision values. Arithmetic operations on all the elements of such a vector can be specified by just one single-precision arithmetic instruction.

Similarly, the double-precision registers can hold short vectors of up to 4 double-precision values, and double-precision arithmetic instructions can specify operations on these vectors.

A vector consists of 2-8 registers from a single *bank*. [VFP register banks on page AppxK-2496](#) describes the division of the VFP register set into banks.

The `FPSCR.Len` field controls the number of elements in a vector. The register number in the instruction specifies the register that contains the first element of the vector. The `FPSCR.Stride` field controls the increment between the register numbers of the elements of the vector. If the total increment causes the register number to overflow the top of a register bank, the register number wraps around to the bottom of the bank, as shown in [VFP register banks on page AppxK-2496](#).

For details of the `FPSCR.{Len, Stride}` fields see [Vector length and stride control on page AppxK-2495](#).

A VFP instruction can operate on:

- operand vectors with `Len` elements, producing a result vector with `Len` elements
- an operand vector with `Len` elements and a scalar operand, producing a result vector with `Len` elements
- scalar operands, producing a scalar result.

These three operation types are identical if `Len == 1`.

To control which type of operation an instruction performs, you choose the registers for the instruction from different register banks. [VFP instruction type selection on page AppxK-2497](#) describes how to select the instruction type.

### K.1.1 Affected instructions

The following VFP instructions are affected by VFP vector mode:

VABS	VADD	VDIV	VMLA	VMLS
VMOV (immediate)	VMOV (register)	VMUL	VNEG	VNMLA
VNMLS	VNMUL	VSQRT	VSUB	

All other VFP instructions behave as described in their instruction descriptions regardless of the values of `FPSCR.{Len, Stride}`.

## K.2 Vector length and stride control

The `FPSCR.Len` field, bits[18:16], controls the vector length for VFP instructions that operate on short vectors, that is, how many registers are in a vector operand. Similarly, the `FPSCR.Stride` field, bits[21:20], controls the vector stride, that is, how far apart the registers in a vector lie in the register bank.

[Table K-1](#) shows the permitted combinations of {Len, Stride}. All other combinations of {Len, Stride} produce UNPREDICTABLE results.

The combination `Len == 0b000`, `Stride == 0b00` is called *scalar mode*. When it is in effect, all arithmetic instructions specify scalar operations. Otherwise, most arithmetic instructions specify a scalar operation if their destination is in the range:

- S0-S7 for a single-precision operation
- D0-D3 or D16-D19 for a double-precision operation.

For the full rules used for determining which operands are vectors, and full details of how vector operands are specified, see [VFP instruction type selection on page AppxK-2497](#).

The rules for vector operands do not permit the same register to appear twice or more in a vector. The permitted {Len, Stride} combinations shown in [Table K-1](#) never cause this to happen for single-precision instructions, so single-precision scalar and vector instructions can be used with all of these {Len, Stride} combinations.

For double-precision vector instructions, some of the permitted {Len, Stride} combinations would cause the same register to appear twice in a vector. If a double-precision vector instruction is executed when such a {Len, Stride} combination in applies, the instruction is UNPREDICTABLE. The last column of [Table K-1](#) indicates which {Len, Stride} combinations this applies to. Double-precision scalar instructions work normally with all of the permitted {Len, Stride} combinations.

**Table K-1 Vector length and stride combinations**

Len	Stride	Vector length	Vector stride	Double-precision vector instructions
0b000	0b00	1	-	All instructions are scalar
0b001	0b00	2	1	Work as described in this appendix
0b001	0b11	2	2	Work as described in this appendix
0b010	0b00	3	1	Work as described in this appendix
0b010	0b11	3	2	UNPREDICTABLE
0b011	0b00	4	1	Work as described in this appendix
0b011	0b11	4	2	UNPREDICTABLE
0b100	0b00	5	1	UNPREDICTABLE
0b101	0b00	6	1	UNPREDICTABLE
0b110	0b00	7	1	UNPREDICTABLE
0b111	0b00	8	1	UNPREDICTABLE

### K.3 VFP register banks

The Advanced SIMD and VFP registers are divided into banks as follows:

- The single-precision registers are divided into four banks of eight. This is shown in Figure K-1. The first bank is a *scalar* bank, and the other three are *vector* banks.
- In a processor with 32 double-precision registers, the double-precision registers are divided into eight banks of four. This is shown in Figure K-2. The first and fifth banks are scalar banks, and the other six are vector banks.
- In a processor with 16 double-precision registers, the double-precision registers are divided into four banks of four. This is shown in Figure K-3. The first bank is a scalar bank, and the other three are vector banks.

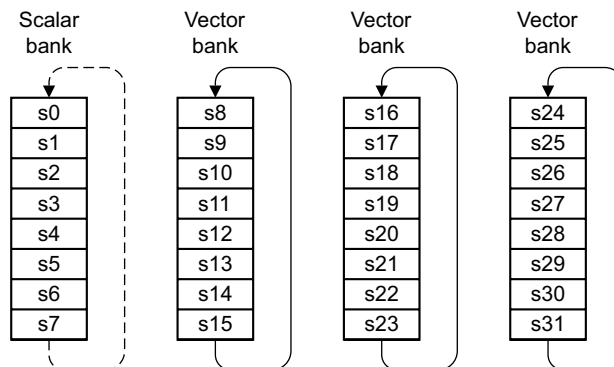

Figure K-1 Register banks, single-precision

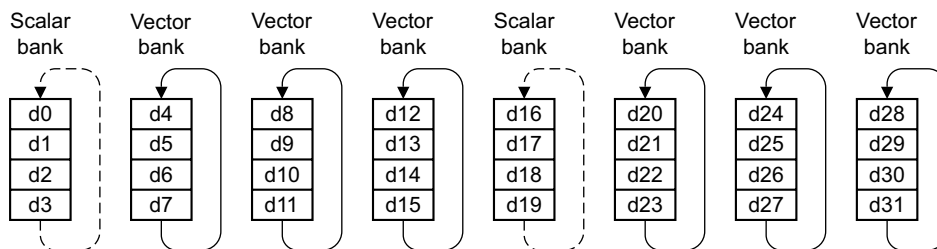

Figure K-2 Register banks, 32 double-precision registers, VFP

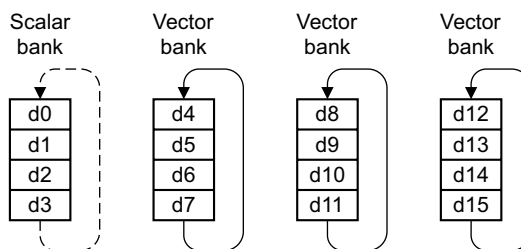

Figure K-3 Register banks, 16 double-precision registers, VFP

## K.4 VFP instruction type selection

Table K-2 shows how the selection of registers in an instruction controls the operation of the instruction.

**Table K-2 Determination of VFP operation by selected register banks**

Destination register bank	1st operand bank	2nd operand bank	Destination type	1st operand type	2nd operand type
Scalar	Any	Any	Scalar	Scalar	Scalar
Vector	Any	Scalar	Vector	Vector	Scalar
Vector	Any	Vector	Vector	Vector	Vector
Scalar	Any	None	Scalar	Scalar	-
Vector	Scalar	None	Vector	Scalar	-
Vector	Vector	None	Vector	Vector	-

- If the instruction has two operands:
  - If the destination register is in a scalar register bank, the operands and result are all scalars.
  - If the destination register is in a vector register bank and the second operand is in a scalar bank, the second operand is a scalar, but both the destination and the first operand are vectors. Each element of the result is produced by an operation on the corresponding element of the first operand and the same scalar.
  - If the destination register and the second operand are both in vector register banks, the operands and result are all vectors. Each element of the result is produced by an operation on corresponding elements of both operands.
- If the instruction has one operand:
  - If the destination register is in a scalar register bank, the operand and result are both scalars.
  - If the destination register is in a vector register bank and the operand is in a scalar bank, the result is a vector and the operand is a scalar. The result is duplicated to each element of the destination vector.
  - If the destination register and the operand are both in vector register banks, the operand and result are both vectors. Each element of the result is produced by an operation on the corresponding element of the operand.

Some VFP instructions have three operands, but in these cases one of the operand vectors is also the result vector. They operate in the same way as two operand instructions.



# Appendix L

## ARMv6 Differences

This appendix describes how ARMv6 differs from ARMv7. It relates only to the architectural descriptions in parts A and B of this manual. See [Appendix M v6 Debug and v6.1 Debug Differences](#) for information about how ARMv6 debug differs from the description in part C of this manual.

This appendix contains the following sections:

- [Introduction to ARMv6](#) on page AppxL-2500
- [Application level register support](#) on page AppxL-2501
- [Application level memory support](#) on page AppxL-2504
- [Instruction set support](#) on page AppxL-2508
- [System level register support](#) on page AppxL-2513
- [System level memory model](#) on page AppxL-2516
- [System Control coprocessor; CP15, support](#) on page AppxL-2523.

---

### Note

---

In this appendix, unless otherwise stated, the description ARMvN refers to all architecture variants of ARM architecture vN described in this manual. In particular, ARMv6 refers to all variants of ARM architecture v6, meaning it refers to ARMv6, ARMv6K, and ARMv6T2, including ARMv6K with the Security Extensions. The description *ARMv6 base architecture* refers only to the ARMv6 variant.

---

## L.1 Introduction to ARMv6

This appendix describes how, for non-debug operation, an implementation of the ARMv6 architecture differs from the description of ARMv7 given in parts A and B of this manual.

———— **Note** ————

[Appendix M v6 Debug and v6.1 Debug Differences](#) and [Appendix N Secure User Halting Debug](#) describe how ARMv6 debug differs from ARMv7 debug.

ARMv7 incorporates and extends features that were introduced as architecture extensions during the life of ARMv6, including:

- the extension of the Thumb instruction set using Thumb-2 technology, introduced in ARMv6T2
- the optional Security Extensions, first supported by ARMv6K.

In addition, key changes introduced in ARMv7 are:

- Hierarchical cache support.
- The alternative memory system architectures are formalized into different architecture profiles:
  - the ARMv7-A profile provides a *Virtual Memory System Architecture* (VMSA)
  - the ARMv7-R profile provides a *Protected Memory System Architecture* (PMSA).
- The optional Advanced SIMD Extension.
- The *Thumb Execution Environment* (ThumbEE), that supports the ThumbEE instruction set. From the publication of issue C.a of this manual, ARM deprecates any use of ThumbEE instructions.

This appendix summarizes the features supported in ARMv6, highlighting:

- the similarities and differences relative to ARMv7
- legacy support for ARMv4 and ARMv5.



## L.2 Application level register support

The ARMv6 core registers are the same as the ARMv7 core registers. For more information, see [ARM core registers on page A2-45](#). The following sections give more information about ARMv6 application level register support:

- [APSR support](#)
- [Instruction set state](#).

### L.2.1 APSR support

*Application Program Status Register* (APSR) support in ARMv6 is identical to ARMv7. Program status is reported in the 32-bit APSR. The APSR bit assignments are:

31	30	29	28	27	26	24	23	20	19	16	15					0
N	Z	C	V	Q	RAZ/ SBZP	Reserved, UNK/SBZP		GE[3:0]		Reserved, UNK/SBZP						

See [The Application Program Status Register \(APSR\) on page A2-49](#) for the APSR bit definitions.

Earlier versions of this manual do not use the term APSR. They refer to the APSR as the **CPSR** with restrictions on reserved fields determined by whether the access to the register is unprivileged, or at a higher privilege level.

### L.2.2 Instruction set state

Instruction set state support in ARMv6 is in general the same as the support available in ARMv7. The only differences are that:

- ThumbEE state is not supported in ARMv6. It is introduced in ARMv7.
- In ARMv6 and ARMv6K, but not in ARMv6T2, when the processor is in executing at PL1, software must not attempt to change the instruction set state by writing nonzero values to **CPSR**.{J. T} with an MSR instruction. For more information, see [Format of the CPSR and SPSRs on page AppxL-2514](#).

All ARMv6 implementations support the ARM instruction set. The ARMv6 base architecture and ARMv6K also support a subset of the Thumb instruction set that can be executed entirely as 16-bit instructions. The only 32-bit instructions in this subset are restricted-range versions of the BL and BLX (immediate) instructions. See [BL and BLX \(immediate\) instructions, before ARMv6T2 on page AppxL-2502](#) for a description of how these instructions can be executed as 16-bit instructions.

The supported ARM and Thumb instructions in the ARMv6 base architecture and ARMv6K are summarized in [Instruction set support on page AppxL-2508](#), and the instruction descriptions in [Chapter A8 Instruction Details](#) give details of the architecture variants that support each instruction encoding.

Jazelle state is supported as in ARMv7. For more information, see:

- [Jazelle direct bytecode execution support on page A2-97](#), for application level information
- [Jazelle direct bytecode execution on page B1-1240](#), for system level information.

ARMv6T2 supports the full Thumb instruction set, apart from a few instructions that are introduced in ARMv7.

### Interworking

In ARMv6, the instructions that provide interworking branches between ARM and Thumb states are:

- BL and BLX
- LDR, LDM, and POP instructions that load the PC.

In ARMv7, the following ARM instructions also perform interworking branches if their destination register is the PC and the S option is not specified:

- ADC, ADD, AND, ASR, BIC, EOR, LSL, LSR, MOV, MVN, ORR, ROR, RRX, RSB, RSC, SBC, and SUB.

The instructions do not perform interworking branches in ARMv6, and the corresponding Thumb instructions do not perform interworking branches in either ARMv6 or ARMv7. This functionality is described by the `ALUWritePC()` pseudocode function. See [Pseudocode details of operations on ARM core registers on page A2-47](#).

## BL and BLX (immediate) instructions, before ARMv6T2

In implementations that support the Thumb instruction set but do not include Thumb-2 technology, meaning ARMv4T, ARMv5T, ARMv5TE, ARMv5TEJ, ARMv6, and ARMv6K implementations, the BL and BLX (immediate) instructions are the only 32-bit Thumb instructions, and the maximum range of the branches that they specify is restricted to approximately  $\pm 4\text{MB}$ . This means that:

- each of the two halfwords of these instructions has top five bits 0b11101, 0b11110, or 0b11111
- it is possible to execute the two halfwords as separate 16-bit instructions.

The following descriptions use the format described in *Instruction encodings on page A8-282*, except that they:

- name the encodings H1, H2 and H3
- have pseudocode that defines the entire operation of the instruction, instead of separate encoding-specific pseudocode and Operation pseudocode.

When the two halfwords of a BL or BLX (immediate) instruction are executed separately, their behavior is as follows:

**Encoding H1**      ARMv4T, ARMv5T\*, ARMv6, ARMv6K      Used for BL and BLX  
No disassembly syntax      First of two 16-bit instructions

15	14	13	12	11	10	9	8	7	6	5	4	3	2	1	0
1	1	1	1	0	imm11										

LR = PC + SignExtend(imm11:Zeros(12), 32);

**Encoding H2**      ARMv4T, ARMv5T\*, ARMv6, ARMv6K      Used for BL  
No disassembly syntax      Second of two 16-bit instructions

15	14	13	12	11	10	9	8	7	6	5	4	3	2	1	0
1	1	1	1	1	imm11										

next\_instr\_addr = PC - 2;  
BranchWritePC(LR + ZeroExtend(imm11:'0', 32));  
LR = next\_instr\_addr<31:1> : '1';

**Encoding H3**      ARMv5T\*, ARMv6, ARMv6K      Used for BLX  
No disassembly syntax      Second of two 16-bit instructions

15	14	13	12	11	10	9	8	7	6	5	4	3	2	1	0
1	1	1	0	1	imm10										op

```
if op == '0' then
    next_instr_addr = PC - 2;
    SelectInstrSet(InstrSet_ARM);
    BranchWritePC(Align(LR,4) + ZeroExtend(imm10:'00', 32));
    LR = next_instr_addr;
else
    UNDEFINED;
```

An encoding H1 instruction must be followed by an encoding H2 or encoding H3 instruction. Similarly, an encoding H2 or encoding H3 instruction must be preceded by an encoding H1 instruction. Otherwise, the behavior is UNPREDICTABLE.

### ————— Note —————

When assembling Thumb instructions for an implementation that supports the Thumb instruction set but does not include Thumb-2 technology:

- BL <label> assembles as H1 followed by H2
- BLX <label> assembles as H1 followed by H3.

It is IMPLEMENTATION DEFINED whether processor exceptions can occur between the two instructions of a BL or BLX pair. If they can, the ARM exception return instructions must be able to return correctly to the second instruction of the pair. The exception handler does not have to take special precautions. See [Exception return on page B1-1193](#) for the definition of exception return instructions.

———— **Note** —————

There are no Thumb exception return instructions in the architecture versions that support separate execution of the two halfwords of BL and BLX (immediate) instructions. Also, the ARM RFE instruction is only defined from ARMv6 onwards.

---

## L.3 Application level memory support

Memory support covers address alignment, endianness support, semaphore support, memory order model, and caches. The following sections give an application level description of ARMv6 memory support:

- [Alignment](#)
- [Endian support on page AppxL-2505](#)
- [Semaphore support on page AppxL-2506](#)
- [Memory model and memory ordering on page AppxL-2506.](#)

### L.3.1 Alignment

ARMv6 supports:

- a legacy alignment configuration compatible with ARMv5
- the ARMv7 alignment configuration that supports unaligned loads and stores of 16-bit halfwords and 32-bit words, and is described in [Alignment support on page A3-108](#).

The alignment configuration is controlled by `SCTLR.U`. [Table L-1](#) shows the permitted values of `SCTLR.U` for the different architecture versions.

**Table L-1 SCTLR.U bit values for different architecture versions**

Architecture version	SCTLR.U value
Before ARMv6	0
ARMv6	0 or 1
ARMv7	1

From the introduction of ARMv6T2, ARM deprecated use of `SCTLR.U == 0`.

The meaning of the different possible values of `SCTLR.U` is:

#### **SCTLR.U == 0**

ARMv5 compatible alignment support, see [Alignment on page AppxO-2590](#), except for the LDRD and STRD instructions. LDRD and STRD must be doubleword-aligned, otherwise:

- if `SCTLR.A == 0`, the instruction is UNPREDICTABLE
- if `SCTLR.A == 1`, the instruction causes an Alignment fault.

#### **Note**

The behavior of LDRD and STRD with `SCTLR.A == 0` is compatible with ARMv5. When `SCTLR.A == 1`, whether the alignment check is for word or doubleword alignment is:

- IMPLEMENTATION DEFINED in ARMv5
- required to be for doubleword alignment in ARMv6.

## SCTLR.U == 1

Unaligned access support for loads and stores of single 16-bit halfwords and 32-bit words, using the LDR, LDRH, LDRHT, LDRSH, LDRSHT, LDRT, STRH, STRHT, STR, and STRT instructions. Some of these instructions were introduced in ARMv6T2.

The following requirements also apply:

- LDREX and STREX exclusive access instructions must be word-aligned, otherwise the instruction generates an abort.
- In ARMv6K, an abort is generated if:
  - an LDREXH or STREXH exclusive access instruction is not halfword-aligned
  - an LDREXD or STREXD exclusive access instruction is not doubleword-aligned.
- SWP must be word-aligned, otherwise the instruction generates an abort. From ARMv6, ARM deprecates any use of the SWP instruction.
- All multi-word load/store instructions must be word-aligned, otherwise the instruction generates an abort.
- Unaligned access support only applies to Normal memory. Unaligned accesses to Strongly-ordered or Device memory are UNPREDICTABLE.

In both configurations, setting the **SCTLR.A** bit forces an abort on an unaligned access.

### ———— Note ————

In ARMv7, **SCTLR.U** is always set to 1. ARMv7 alignment support is the same as ARMv6K in this configuration. From ARMv7, use of a value of 0 for **SCTLR.U** is obsolete.

In common with ARMv7, all instruction fetches must be aligned.

## L.3.2 Endian support

ARMv6 supports the same *Big-endian* (BE) and *Little-endian* (LE) support model as ARMv7, see [Endian support on page A3-110](#). It is IMPLEMENTATION DEFINED if the legacy big-endian model (BE-32) defined for ARMv4 and ARMv5 is also supported. For more information about BE-32 see [Endian support on page AppxO-2591](#).

For configuration and control information, see [Endian configuration and control on page AppxL-2516](#).

### BE-32 DBGWCR Byte address select values

Using the BE-32 endianness model changes the meaning of the Byte address select values in **DBGWCR**[8:5]. When using BE-32 endianness, use [Table L-2](#) to interpret these values. Do not use [Table C3-4](#) on [page C3-2060](#).

**Table L-2 Byte address select values, word-aligned address, ARMv6 BE-32 endianness**

DBGWCR[8:5] value	Description
0000	Watchpoint never hits
xxx1	Watchpoint hits if byte at address <b>DBGWVR</b> <31:2>: '11' is accessed
xx1x	Watchpoint hits if byte at address <b>DBGWVR</b> <31:2>: '10' is accessed
x1xx	Watchpoint hits if byte at address <b>DBGWVR</b> <31:2>: '01' is accessed
1xxx	Watchpoint hits if byte at address <b>DBGWVR</b> <31:2>: '00' is accessed

### L.3.3 Semaphore support

ARM deprecates the use of the ARM semaphore instructions SWP and SWPB, in favour of the exclusive access mechanism described in [Synchronization and semaphores on page A3-114](#), and:

- ARMv6 provided a pair of synchronization primitives, LDREX and STREX in the ARM instruction set
- ARMv6T2 adds the LDREX and STREX instructions to the Thumb instruction set
- ARMv6K adds the following instructions to the ARM instruction set only:
  - Clear-Exclusive, CLREX
  - byte Load-Exclusive and Store-Exclusive, LDREXB and STREXB
  - halfword Load-Exclusive and Store-Exclusive, LDREXH and STREXH
  - doubleword Load-Exclusive and Store-Exclusive, LDREXD and STREXD.

All Load-Exclusive and Store-Exclusive access instructions must be naturally aligned. An unaligned Exclusive access instruction generates an unaligned access Data Abort exception.

### L.3.4 Memory model and memory ordering

The memory model was formalized in ARMv6. This included:

- defining Normal, Device, and Strongly-ordered memory types
- adding a Shareable memory attribute
- extending the memory attributes to support two cache policies, associated with Inner and Outer levels of cache and including a write allocation hint capability
- adding *Data Memory Barrier* (DMB) and *Data Synchronization Barrier* (DSB) operations, to support the formalized memory ordering requirements
- adding an *Instruction Synchronization Barrier* (ISB) operation, to guarantee that instructions complete before any instructions that come after them in program order are executed.

ARMv6 provided barrier operations as CP15 c7 operations. These migrated to the ARM and Thumb instruction sets as follows:

- ARMv6 required DMB, DSB, and ISB operations in CP15, see [CP15 c7, Miscellaneous functions on page AppxO-2629](#). The functionality of these operations is the same as that described for ARMv7 in [Memory barriers on page A3-150](#).
- ARMv7 adds DMB, DSB, and ISB instructions to the ARM and Thumb instruction sets.

ARM deprecates use of the CP15 barrier operations.

#### Ordering of instructions that change the CPSR interrupt masks

In ARMv6, any instruction that implicitly or explicitly changes the interrupt masks in the CPSR and appears in program order after a Strongly-ordered access must wait for the Strongly-ordered memory access to complete. These instructions are:

- An MSR with the control field mask bit set.
- The flag-setting variants of arithmetic and logical instructions with the PC as the destination register. These instructions copy the SPSR to CPSR.

ARM deprecates any reliance on this behavior, and this behavior is obsolete from ARMv7. Instead, when synchronization is required, include an explicit memory barrier between the memory access and the following instruction, see [Data Synchronization Barrier \(DSB\) on page A3-152](#).

#### Caches

For details of cache support in ARMv6, see [Cache support on page AppxL-2517](#).

## Tightly Coupled Memory support

*Tightly Coupled Memory* (TCM) provides low latency memory that the processor can use without the unpredictability of caches. TCM can hold critical routines, scratchpad data, or data types with locality properties that are not suitable for caching. An implementation can use TCM at the application or at the system level. For more information about ARMv6 TCM support see [TCM support on page AppxL-2518](#).

## DMA support

*Direct Memory Access* (DMA) enables a peripheral to read and write data directly from and to main memory. In ARMv6, the coherency of DMA and processor memory accesses is IMPLEMENTATION DEFINED. DMA support for TCM is IMPLEMENTATION DEFINED.

## L.4 Instruction set support

ARMv6 supports the following instruction sets:

- the ARM instruction set
- the Thumb instruction set.

---

### Note

- ARMv6 also supports the Jazelle instruction set state, see [Instruction set state on page AppxL-2501](#) and the referenced information in parts A and B of this manual.
- ARMv6 does not support ThumbEE state, and setting `CPSR.{J, T}` to `{1, 1}` has the effect described in [Unimplemented instruction sets on page B1-1155](#). `CPSR.{J, T}` might be set to `{1, 1}` by an exception return that uses a modified SPSR value.

---

ARMv6 floating-point support, called VFPv2, is the same as that supported in ARMv5. The instructions use coprocessors 10 and 11 and are documented with all other instructions in [Alphabetical list of instructions on page A8-300](#). The following VFP instructions are not supported in ARMv6. These instructions are introduced in ARMv7, as part of VFPv3:

- VMOV (immediate)
- VCVT (between floating-point and fixed-point).

---

### Note

- Floating point (VFP) instruction mnemonics previously started with an F. However the *Unified Assembler Language (UAL)* introduced in ARMv6T2 changes this to a V prefix, and in many cases the rest of the mnemonic is changed to be more compatible with other instructions. This aligns the scalar floating-point instructions in the Floating-point extension with the ARMv7 Advanced SIMD instructions in the Advanced SIMD Extension. The floating-point and Advanced SIMD instructions share some load, store, and move instructions that access a common register file.
- The VFPv2 instructions are summarized in *F\**, [former Floating-point instruction mnemonics on page A8-388](#). This includes the two deprecated instructions in VFPv2 that do not have UAL mnemonics, the FLDMM and FSTMX instructions.

---

ARMv6 introduces new instructions in addition to supporting all the ARM and Thumb instructions available in ARMv5TEJ. For more information, see [Instruction set support on page AppxO-2595](#), [ARM instruction set support on page AppxL-2509](#), and [Thumb instruction set support on page AppxL-2511](#).

The ARM and Thumb instruction sets grew significantly in ARMv6 and ARMv6T2, compared with ARMv5TEJ. The changes include the addition of:

- the parallel addition and subtraction SIMD instructions
- many 32-bit Thumb instructions in ARMv6T2.

ARMv6K adds instructions associated with the optional support for energy-saving Wait For Interrupt and Wait For Event mechanisms, and additional Load-Exclusive and Store-Exclusive instructions. It also permits the use of the optional Security Extensions and the SMC instruction.

ARMv7 extends the instruction sets as defined for ARMv6 and the ARMv6 architecture variants and extensions as follows:

- the introduction of barrier instructions to the ARM and Thumb instruction sets
- the ThumbEE Extension in ARMv7
- the new instructions added in VFPv3 and VFPv4
- the Advanced SIMD Extension in ARMv7.



**Note**

This appendix describes the instructions included as a mnemonic in ARMv6. For any mnemonic, to determine which associated instruction encodings appear in a particular architecture variant, see the subsections of [Alphabetical list of instructions on page A8-300](#) that describe the mnemonic. Each encoding diagram shows the architecture variants or extensions that include the encoding.

The following sections give more information about ARMv6 instruction set support:

- [ARM instruction set support](#)
- [Thumb instruction set support on page AppxL-2511](#)
- [System level instruction support on page AppxL-2512.](#)

### L.4.1 ARM instruction set support

ARMv6 includes all the ARM instructions present in ARMv5TEJ, see [ARM instruction set support on page AppxO-2596](#). [Table L-3](#) shows the ARM instruction changes in the ARMv6 base architecture.

**Table L-3 ARM instruction changes in ARMv6**

Instruction	ARMv6 change
CPS	Introduced
LDREX	Introduced
MCCR2	Introduced
MRRC2	Introduced
PKH	Introduced
QADD16	Introduced
QADD8	Introduced
QASX	Introduced
QSUB16	Introduced
QSUB8	Introduced
QSAX	Introduced
REV, REV16, REVSH	Introduced
RFE	Introduced
SADD8, SADD16, SASX	Introduced
SEL	Introduced
SETEND	Introduced
SHADD8, SHADD16	Introduced
SHSUB8, SHSUB16	Introduced
SMLAD	Introduced
SMLALD	Introduced
SMLSD	Introduced
SMLSLD	Introduced

**Table L-3 ARM instruction changes in ARMv6 (continued)**

<b>Instruction</b>	<b>ARMv6 change</b>
SMMLA	Introduced
SMMLS	Introduced
SMMUL	Introduced
SMUAD	Introduced
SMUSD	Introduced
SRS	Introduced
SSAT, SSAT16	Introduced
SSUB8, SSUB16, SSAX	Introduced
STREX	Introduced
SWP	Deprecated
SWPB	Deprecated
SXTAB, SXTAB16, SXTAH	Introduced
SXTB, SXTB16, SXTH	Introduced
UADD8, UADD16, UASX	Introduced
UHADD8, UHADD16, UHASX	Introduced
UHSUB8, UHSUB16, UHSAX	Introduced
UMAAL	Introduced
UQADD8, UQADD16, UQASX	Introduced
UQSUB8, UQSUB16, UQSAX	Introduced
USAD8, USADA8	Introduced
USAT, USAT16	Introduced
USUB8, USUB16, USAX	Introduced
UXTAB, UXTAB16, UXTAH	Introduced
UXTB, UXTB16, UXTH	Introduced

The SMC instruction is added as part of the Security Extensions.

The CLREX, LDREXB, LDREXD, LDREXH, NOP, SEV, STREXB, STREXD, STREXH, WFE, WFI, and YIELD instructions are added as part of ARMv6K.

### **ARM instructions introduced in ARMv6T2**

ARMv6T2 adds the following ARM instructions:

BFC, BFI, LDRHT, LDRSBT, LDRSHT, MLS, MOVT, RBIT, SBFX, STRHT, and UBFX.

## Instructions that are only in the ARM instruction set in ARMv6T2

The following ARM instructions have no Thumb equivalents in ARMv6T2:

- register-shifted forms of the ADC, ADD, AND, BIC, CMN, CMP, EOR, MVN, ORR, RSB, SBC, SUB, TEQ, and TST instructions
- all forms of the RSC instruction
- LDMDA, LDMIB, STMDA, and STMIB
- SWP and SWPB.

## ARM instructions introduced in ARMv7

The DMB, DSB, ISB, PLI, SDIV, and UDIV instructions are added in ARMv7 and are not present in any form in ARMv6. [ARMv7 implementation requirements and options for the divide instructions on page A4-172](#) describes the implementation options for the SDIV and UDIV instructions, in the ARM and Thumb instruction sets.

The DBG hint instruction is added in ARMv7. It is UNDEFINED in the ARMv6 base architecture, and executes as a NOP instruction in ARMv6K and ARMv6T2.

### L.4.2 Thumb instruction set support

ARMv6 includes all the Thumb instructions present in ARMv5TE, see [Thumb instruction set support on page AppxO-2598](#). The 16-bit Thumb instructions added in the ARMv6 base architecture are:

- CPS
- CPY
- REV, REV16, REVSH
- SETEND
- SXTB, SXTH
- UXTB, UXTH.

## Thumb instruction set and ARMv6T2

From the ARMv6T2 version of the Thumb instruction set:

- The Thumb instruction set provides 16-bit and 32-bit instructions that are executed in Thumb state.
- Most forms of ARM instructions have an equivalent Thumb encoding. [Instructions that are only in the ARM instruction set in ARMv6T2](#) lists the exceptions to this in ARMv6T2.

The CBZ, CBNZ, and IT instructions are only in the Thumb instruction set and are introduced in ARMv6T2.

Before ARMv6T2, a BL or BLX (immediate) Thumb instruction can be executed as a pair of 16-bit instructions, rather than as a single 32-bit instruction. For more information, see [BL and BLX \(immediate\) instructions, before ARMv6T2 on page AppxL-2502](#). From ARMv6T2 these instructions are always executed as a single 32-bit instruction.

From ARMv6T2, the branch range of the BL and BLX (immediate) instructions is increased from approximately  $\pm 4\text{MB}$  to approximately  $\pm 16\text{MB}$ .

## Thumb instructions introduced in ARMv7

The CLREX, LDREXB, LDREXD, LDREXH, STREXB, STREXD, and STREXH instructions are added to the Thumb instruction set in ARMv7. They are Thumb equivalents to the ARM instructions added in ARMv6K. These instructions are UNDEFINED in ARMv6T2.

The SEV, WFE, WFI, and YIELD hint instructions are added to the Thumb instruction set in ARMv7. They execute as NOP instructions in ARMv6T2. The 16-bit encodings of the SEV, WFE, WFI, and YIELD instructions are UNDEFINED in the ARMv6 base architecture and in ARMv6K.

The DMB, DSB, ISB, PLI, SDIV, and UDIV instructions are added in ARMv7 and are not present in any form in ARMv6. [ARMv7 implementation requirements and options for the divide instructions on page A4-172](#) describes the implementation options for the SDIV and UDIV instructions, in the ARM and Thumb instruction sets.

The DBG hint instruction is added in ARMv7. It is UNDEFINED in the ARMv6 base architecture and in ARMv6K, and executes as a NOP instruction in ARMv6T2.

### L.4.3 System level instruction support

The system instructions supported in ARMv6 are the same as those listed for ARMv7 in [Alphabetical list of instructions on page B9-1976](#), except that:

- The ERET instruction is added in ARMv7VE.  
The Thumb encoding of ERET is:
  - UNDEFINED in the ARMv6 base architecture and in ARMv6K
  - an encoding of SUBS PC, LR, #0 in ARMv6T2 and ARMv7.The ARM encoding of ERET is UNDEFINED in versions of the architecture before ARMv7VE.
- The HVC, MRS (Banked register), and MSR (Banked register) instructions are added in ARMv7VE. Their encodings are UNDEFINED in versions of the architecture before ARMv7VE.

In addition:

- the SMC instruction only applies to the Security Extensions
- the VMRS and VMSR instructions only apply to the Floating Point extension.

### L.4.4 Different definition of some LDM and POP instructions

This difference applies to:

- LDM instructions that have the base register in the register list and specify base register writeback
- POP instructions that load at least two registers, including the base register SP.

In ARMv6, ARM instructions of these types made the value of the base register UNKNOWN, and Thumb instructions of these types were UNPREDICTABLE. ARM deprecates any use of ARM instructions of these types.

In ARMv7, all instructions of these types are UNPREDICTABLE.

## L.5 System level register support

The general registers and processor modes are the same as ARMv7, except that the Security Extensions and Monitor mode are permitted only in ARMv6K. For more information, see [Figure B1-2 on page B1-1144](#). The following sections give information about ARMv6 system level register support:

- [Program Status Registers \(PSRs\)](#)
- [The exception model on page AppxL-2514](#)
- [Jazelle direct bytecode execution support on page AppxL-2515](#)
- [Handling a Prefetch Abort exception taken from Jazelle state on page AppxL-2515](#).

### L.5.1 Program Status Registers (PSRs)

The Application level programmers' model provides the Application Program Status Register, see [APSR support on page AppxL-2501](#). This is an application level alias for the *Current Program Status Register (CPSR)*. The system level view of the CPSR extends the register, adding state that:

- is used by exceptions
- controls the processor mode.

Each of the PL1 modes to which an exception can be taken has its own saved copy of the CPSR, the *Saved Program Status Register (SPSR)*, as shown in [Figure B1-2 on page B1-1144](#). For example, the SPSR for Monitor mode is called SPSR\_mon.

#### The Current Program Status Register (CPSR)

The CPSR holds the following processor status and control information:

- The APSR, see [APSR support on page AppxL-2501](#).
- The current instruction set state. See [Instruction set state register, ISETSTATE on page A2-50](#), except that ThumbEE state is not supported in ARMv6.
- The current endianness, see [Endianness mapping register, ENDIANSTATE on page A2-53](#).
- The current processor mode.
- Interrupt and asynchronous abort disable bits.
- In ARMv6T2, the execution state bits for the Thumb If-Then instruction, see [IT block state register, ITSTATE on page A2-51](#).

The non-APSR bits of the CPSR have defined reset values. These are shown in the TakeReset() pseudocode function described in [Reset on page B1-1204](#), except that before ARMv6T2:

- CPSR.IT[7:0] are not defined and so do not have reset values
- the reset value of CPSR.T is 0.

The rules described in [The Current Program Status Register \(CPSR\) on page B1-1147](#) about when mode changes take effect apply with the modification that the ISB can only be the ISB operation described in [CP15 c7, Miscellaneous functions on page AppxL-2536](#).

#### The Saved Program Status Registers (SPSRs)

The SPSRs are defined as they are in ARMv7, see [The Saved Program Status Registers \(SPSRs\) on page B1-1148](#), except that the IT[7:0] bits are not implemented before ARMv6T2.

## Format of the CPSR and SPSRs

The CPSR and SPSR bit assignments are the same as the ARMv7 assignments:

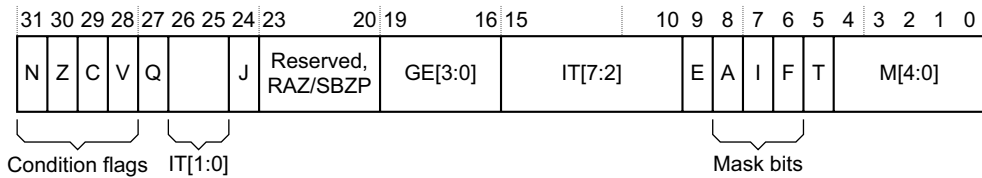

In ARMv6T2, the definitions and general rules for PSR bits and support of *Non-maskable FIQs* (NMFI) are the same as ARMv7. For more information, see [Format of the CPSR and SPSRs on page B1-1148](#) and [Non-maskable FIQs on page B1-1151](#).

ARMv6 and ARMv6K have the following differences:

- Bits[26:25] are RAZ/WI.
- Bits[15:10] are reserved.
- The J and T bits of the CPSR must not be changed when the CPSR is written by an MSR instruction, or else the behavior is UNPREDICTABLE. MSR instructions exist only in ARM state in these architecture variants, so this is equivalent to saying the MSR instructions executing at PL1 or higher must treat these bits as SBZP. MSR instructions in User mode still ignore writes to these bits.

### L.5.2 The exception model

The exception vector offsets and priorities as stated in [Exception vectors and the exception base address on page B1-1164](#) and [Exception priority order on page B1-1168](#) are the same for ARMv6 and ARMv7.

See [Exception return on page B1-1193](#) for the definition of exception return instructions.

### The ARM abort model

ARMv6 and ARMv7 use a *Base Restored Abort Model* (BRAM), as defined in [The ARM abort model on page AppxO-2602](#).

### Exception entry

Entry to exceptions in ARMv6 is generally as described in the sections:

- [Reset on page B1-1204](#)
- [Undefined Instruction exception on page B1-1205](#)
- [Supervisor Call \(SVC\) exception on page B1-1209](#)
- [Secure Monitor Call \(SMC\) exception on page B1-1210](#)
- [Prefetch Abort exception on page B1-1212](#)
- [Data Abort exception on page B1-1214](#)
- [IRQ exception on page B1-1218](#)
- [FIQ exception on page B1-1221](#).

These ARMv7 descriptions are modified as follows:

- pseudocode statements that set registers, bits and fields that do not exist in the ARMv6 architecture variant are ignored
- CPSR.T is set to SCTLR.TE in ARMv6T2, as described by the pseudocode, but to 0 in ARMv6 and ARMv6K.

## Fault reporting

In previous ARM documentation, in descriptions of exceptions associated with memory system faults, the terms precise and imprecise are used instead of synchronous and asynchronous. For details of the terminology used for describing exceptions in ARMv7, see [Terminology for describing exceptions on page B1-1137](#).

ARMv6 only supports synchronous reporting of external aborts on instruction fetches and translation table walks. In ARMv7, these faults can be reported as synchronous or asynchronous aborts. Asynchronous aborts are always reported as Data Abort exceptions.

From ARMv6, ARM deprecates the following fault status encodings:

- `0b00011` was assigned as an alignment error encoding and is re-assigned as an Access flag section fault in ARMv6K and ARMv7
- `0b01010` was assigned as an external abort encoding and is a reserved value in ARMv7.

ARMv6 and ARMv7 provide alternative alignment and synchronous external abort error encodings that are common to both versions of the architecture.

### L.5.3 Jazelle direct bytecode execution support

In ARMv6, the `JOSCR.CV` bit is not changed on exception entry in any implementation of Jazelle.

### L.5.4 Handling a Prefetch Abort exception taken from Jazelle state

As described in [Prefetch Abort exceptions on page B1-1241](#), on a Prefetch Abort exception, `LR_abt` points to the start of the instruction that caused the abort. For a Prefetch Abort exception on a multi-byte bytecode instruction that crosses a page boundary, the Prefetch Abort exception handler must determine the faulting page. In an ARMv6 implementation, it is IMPLEMENTATION DEFINED whether an implementation includes the `IFAR`, and therefore the abort handler might not be able to use the `IFAR` for this purpose. When the `IFAR` is not implemented, a Prefetch Abort exception handler can use the following technique:

```
IF the page pointed to by (LR_abt - 4) is not mapped
    THEN map the page
    ELSE map the page following the page including (LR_abt - 4)
ENDIF
retry the instruction
```

#### ————— Note —————

An OS designer must write the Prefetch Abort exception handler so it can handle a Prefetch Abort exception generated in either of the two pages spanned by a multi-byte bytecode instruction that crosses a page boundary. To ensure ARMv6 subarchitecture independence, such an abort handler might use the technique described in this section.

## L.6 System level memory model

The pseudocode listed in [Aligned memory accesses on page B2-1294](#) and [Unaligned memory accesses on page B2-1295](#) covers the alignment behavior of all architecture variants from ARMv4. ARMv6 supports two alignment models, and the `SCTLR.U` bit controls the alignment configuration. For more information, see [Alignment on page AppxL-2504](#).

———— **Note** —————

- ARMv4 and ARMv5 only support the `SCTLR.U = 0` alignment model.
- ARMv7 only supports the `SCTLR.U = 1` alignment model.

The following sections describe the system level memory model:

- [Endian configuration and control](#)
- [Cache support on page AppxL-2517](#)
- [TCM support on page AppxL-2518](#)
- [VMSA support on page AppxL-2519](#)
- [PMSA on page AppxL-2522](#).

### L.6.1 Endian configuration and control

Endian control and configuration is supported by two bits in the CP15 `SCTLR`, and a PSR bit:

**SCTLR.B** BE-32 configuration bit. This bit must be RAZ/WI when BE-32 is not supported. BE-32 is the legacy big-endian model. See [Endian support on page AppxL-2505](#).

**SCTLR.EE** This bit updates `CPSR.E` on exception entry and provide endianness information for translation table walks.

**CPSR.E** The bit is updated on exception entry to the value of the `SCTLR.EE` bit. Otherwise it is controlled by the `SETEND` instruction. From ARMv6, ARM deprecates writing the bit using an `MSR` instruction.

———— **Note** —————

BE and BE-32 are mutually exclusive. When `SCTLR.B` is set, `SCTLR.EE` and `CPSR.E` must be clear, otherwise the endianness behavior is UNPREDICTABLE.

Endian behavior can be configured on reset using the `CFGEND[1:0]` pins. [Table L-4](#) defines the `CFGEND[1:0]` encoding and associated configurations.

**Table L-4 Configuration options on reset**

CFGEND[1:0]	CP15 System Control Register, SCTLR				PSR
	EE bit	U bit	A bit	B bit	E bit
00	0	0	0	0	0
01 <sup>a</sup>	0	0	0	1	0
10	0	1	0	0	0
11	1	1	0	0	1

a. This configuration is reserved in implementations that do not support BE-32. In this case, the B bit is RAZ.

———— **Note** —————

When an implementation does not include the `CFGEND[1:0]` signal, a value of `0b00` is assumed.



ARMv6 does not support the static instruction endianness configuration feature described in *Instruction endianness static configuration, ARMv7-R only* on page A3-112.

## L.6.2 Cache support

ARMv7 can detect and manage a multi-level cache topology. ARMv6 only detects and manages level 1 caches, and the cache type is stored in the Cache Type Register. See *CP15 c0, Cache Type Register, CTR, ARMv4 and ARMv5* on page AppxO-2615.

In ARMv6, the L1 cache must appear to software to behave as follows:

- the entries in the cache do not need to be cleaned, invalidated, or cleaned and invalidated by software for different virtual to physical mappings
- for memory regions that are described in the translation tables as being Cacheable, aliases to the same physical address can exist, subject to the restrictions for 4KB small pages described in *Virtual to physical translation mapping restrictions* on page AppxL-2521.

---

**Note**

---

These requirements are different from the required ARMv7 cache behavior described in *Caches in a VMSA implementation* on page B3-1392.

---

ARMv6 defines a standard set of cache operations for level 1 instruction, data, and unified caches. The cache operations required are:

- for an instruction cache:
  - invalidate all entries
  - invalidate entries by *Modified Virtual Address* (MVA)
  - invalidate entries by set/way
- for a data cache:
  - invalidate all entries, clean all entries
  - invalidate entries by MVA, clean entries by MVA
  - invalidate entries by set/way, clean entries by set/way
- for a unified cache:
  - invalidate all entries
  - invalidate entries by MVA, clean entries by MVA
  - invalidate entries by set/way, clean entries by set/way

---

**Note**

---

In ARMv7:

- cache operations are defined as affecting the caches when the caches are disabled.
- address based cache maintenance operations are defined as affecting all memory types.

Before ARMv7 these features of the cache operations are IMPLEMENTATION DEFINED.

---

ARMv6 defines a number of optional cache range operations. The defined range operations are:

- for an instruction cache:
  - invalidate range by VA
- for a data cache:
  - invalidate range by VA
  - clean range by VA
  - clean and invalidate range by VA
- operations related to speculative fetches:
  - prefetch instruction range by VA
  - prefetch data range by VA
  - stop prefetch range.

For more information, see [Block transfer operations on page AppxL-2534](#).

CP15 also supports configuration and control of cache lockdown. For details of the CP15 cache operation and lockdown support in ARMv6, see:

- [CP15 c7, Cache and branch predictor operations on page AppxL-2531](#)
- [CP15 c9, Cache lockdown support on page AppxL-2537](#).

### Cache behavior at reset

In ARMv6, all cache lines in a cache, and all cached entries associated with branch prediction support, are invalidated by a reset. This is different to the ARMv7 behavior described in [Behavior of the caches at reset on page B2-1269](#).

## L.6.3 TCM support

[Tightly Coupled Memory support on page AppxL-2507](#) introduced TCMs and their use at the Application level. In addition, TCMs can hold critical system level routines such as interrupt handlers, and critical data structures such as interrupt stacks. Using TCMs can avoid indeterminate cache accesses.

ARMv6 supports up to four banks of data TCM and up to four banks of instruction TCM. You must program each bank to be in a different location in the physical memory map.

ARMv6 expects TCM to be used as part of the physical memory map of the system, and not to be backed by a level of external memory with the same physical addresses. For this reason, TCM behaves differently from a cache for regions of memory that are marked as being Write-Through Cacheable. In such regions, a write to a memory locations in the TCM never causes an external write.

A particular memory location must be contained either in the TCM or in the cache, and cannot be in both. In particular, no coherency mechanisms are supported between the TCM and the cache. This means that it is important when allocating the TCM base addresses to ensure that the same address ranges are not contained in the cache.

### TCM support and VMSA

TCMs are supported in ARMv6 with VMSA support. However, there are some usage restrictions.

#### **Restriction on translation table mappings**

In a VMSA implementation, the TCM must appear to be implemented as Physically-Indexed, Physically-Addressed memory. This means it must behave as follows:

- Entries in the TCM do not have to be cleaned or invalidated by software for different virtual to physical address mappings.
- Aliases to the same physical address can exist in memory regions that are held in the TCM. This means the translation table mapping restrictions for TCM are less restrictive than for cache memory. See [Virtual to physical translation mapping restrictions on page AppxL-2521](#) for cache memory restrictions.

#### **Restriction on translation table attributes**

In a VMSA implementation, the translation table entries that describe areas of memory that are handled by the TCM can be Cacheable or Non-cacheable, but must not be marked as Shareable. If they are marked as either Device or Strongly-ordered, or have the Shareable attribute set, the locations that are contained in the TCM are treated as being Non-shareable, Non-cacheable.

## TCM CP15 configuration and control

In ARMv7, a TCM Type Register is required. However, its format can be compatible with ARMv6 or IMPLEMENTATION DEFINED. For more information, see [TCMTR, TCM Type Register, VMSA](#) on page B4-1713.

In ARMv6, CP15 c0 and c9 registers configure and control the TCMs in a system. For more information, see:

- [CP15 c0, TCM Type Register, TCMTR, ARMv6](#) on page AppxL-2527
- [CP15 c9, TCM support](#) on page AppxL-2538.

---

### Note

In addition to the basic TCM support model in ARMv6, a set of range operations that can operate on caches and TCMs are documented. Range operations are considered optional in ARMv6. See [Block transfer operations](#) on page AppxL-2534.

The *ARM Architecture Reference Manual* (DDI 0100) described an ARMv6 feature called SmartCache, and a level 1 DMA model associated with TCM support. Both of these features are considered as IMPLEMENTATION DEFINED, and are not described in this manual.

In some implementations of ARMv4 and ARMv5, bits in the CP15 System Control Register, [SCTLR\[19:16\]](#) or a subset, are used for TCM control. From ARMv6 these bits have fixed values, and no [SCTLR](#) bits are used for TCM control.

---

## L.6.4 VMSA support

A key component of the VMSA is the use of translation tables. ARMv6 supports two formats of virtual memory translation table:

- a legacy format for ARMv4 and ARMv5 compatibility
- a revised format, called the VMSAv6 format, that is also used in ARMv7.

Both table formats support use of the *Fast Context Switch Extension* (FCSE), but ARM deprecates use of the FCSE, and the FCSE is optional in ARMv7. For the differences in VMSAv6 format support between ARMv6 and ARMv6K, see [VMSAv6 translation table format](#) on page AppxL-2520.

---

### Note

- ARMv7 does not support the legacy format.
  - ARMv7 VMSA support, when using the Short-descriptor translation table format, is the same as that supported by the revised format in ARMv6K, except for the removal of the address mapping restrictions described in [Virtual to physical translation mapping restrictions](#) on page AppxL-2521.
  - For more information about the FCSE see [Appendix J Fast Context Switch Extension \(FCSE\)](#).
- 

## Execute-never, XN

The ARMv7 requirement that instruction fetches are not made from read-sensitive devices also applies to earlier versions of the architecture:

- ARMv7 requires you to mark all read-sensitive devices with the XN (*Execute-never*) attribute to ensure that this requirement is met, see [Execute-never restrictions on instruction fetching](#) on page B3-1359
- before ARMv7, how this requirement is met is IMPLEMENTATION DEFINED.

## Legacy translation table format

ARMv6 legacy support only includes the coarse translation table type as described in [Second level Coarse page table descriptor format on page AppxO-2607](#). ARMv6 does not support the fine second level Page table format. Therefore the legacy translation table format includes subpage access permissions but does not support 1KB Tiny pages. [Table L-5](#) shows the legacy first level translation table entry formats.

**Table L-5 Legacy first level descriptor format**

	31	20	19	14	12	11	10	9	8	5	4	3	2	1	0	
Fault	IGN														0	0
Coarse page table	Coarse page table base address										I M P	Domain	SBZ		0	1
Section	Section base address					SBZ		TEX	AP	I M P	Domain	S B Z	C	B	1	0
	Reserved														1	1

———— **Note** ————

ARMv5TE includes optional support for Supersections, Shareable memory, and the TEX field. See [Virtual memory support on page AppxO-2604](#).

ARM deprecates use of the [SCTLR.S](#) and [SCTLR.R](#) bits described in [Table O-7 on page AppxO-2605](#). They are implemented for use only with the legacy format translation tables, and VMSAv6 and VMSAv7 do not support their use.

## VMSAv6 translation table format

The VMSAv6 translation table format is fully compatible with the virtual memory support in ARMv7-A. It includes the following features:

- the ability to mark a virtual address as either global or context-specific
- the ability to encode the Normal, Device, or Strongly-ordered memory type into the translation tables
- the Shareable attribute
- the XN (Execute-never) access permission attribute
- a third AP bit
- a TEX field used with the C and B bits to define the cache attributes for each page of memory
- support for an *Address Space Identifier* (ASID) or a global identifier
- 16MB Supersections, and the ability to map a Supersection to a 16MB range.

Related to this new translation table format, VMSAv6 provides:

- support for two translation table base registers and an associated control register
- independent fault status and fault address registers for reporting Prefetch Abort exceptions and Data Abort exceptions
- a Context ID Register, [CONTEXTIDR](#).

ARMv6K added the following features to VMSAv6:

- An additional access permission encoding, AP[2:0] == 0b111, and an associated simplified access permissions model. See [Access permissions on page B3-1356](#), and [AP\[2:1\] access permissions model on page B3-1357](#).
- The Access flag feature. See [The Access flag on page B3-1362](#).
- TEX remap. See [Short-descriptor format memory region attributes, with TEX remap on page B3-1368](#).

### Virtual to physical translation mapping restrictions

An ARMv6 implementation can restrict the mapping of pages that remap virtual address bits[13:12]. This restriction, called page coloring, supports the handling of aliases by an implementation that uses VIPT caches. On an implementation that imposes this restriction, the most significant bit of the cache size fields for the instruction and data caches in the CTR is Read-As-One.

To avoid alias problems, this restriction enables these bits of the virtual address to be used as an index into the cache without requiring hardware support. The restriction supports virtual indexing on caches where a cache way has a maximum size of 16KB. There is no restriction on the number of ways supported. Cache ways of 4KB or less do not suffer from this restriction, because any address, virtual or physical, can only be assigned to a single cache set. Where NSETS is the number of sets, and LINELEN is the cache line length, the ARMv6 cache policy associated with virtual indexing is:

$\text{Log}_2(\text{NSETS} \times \text{LINELEN}) = < 12$  ; no VI restriction  
 $12 < \text{Log}_2(\text{NSETS} \times \text{LINELEN}) = < 14$  ; VI restrictions apply  
 $\text{Log}_2(\text{NSETS} \times \text{LINELEN}) > 14$  ; PI only, VI not supported

If a page is marked as Non-shareable, then if the most significant bits of the cache size fields are RAO, the implementation requires the remapping restriction and the following restrictions apply:

- If multiple virtual addresses are mapped onto the same physical addresses, then for all mappings bits[13:12] of the virtual address must be equal, and must also be equal to bits[13:12] of the physical address. The same physical address can be mapped by TLB entries of different page sizes. These can be 4KB, 64KB, or sections.
- If all mappings to a physical address are of a page size equal to 4KB, the restriction that bits[13:12] of the virtual address must equal bits[13:12] of the physical address is not required. Bits[13:12] of all virtual address aliases must still be equal.

There is no restriction on the more significant bits in the virtual address.

If a page is marked as Shareable and Cacheable, memory coherency must be maintained across the shareability domain. In ARMv7, software manages instruction coherency, and data caches must be transparent. See [Shareable, Inner Shareable, and Outer Shareable Normal memory on page A3-132](#) for more information.

#### ————— Note —————

In some implementations, marking areas of memory as Shareable can have substantial performance effects, because those areas might not be held in caches.

### ARMv6 and the Security Extensions

The Security Extensions provide virtual memory support for two physical address spaces as described in [Secure and Non-secure address spaces on page B3-1323](#) and are supported from ARMv6K. Support is the same as in ARMv7 with the following exceptions:

- ARMv6 only supports CP15 operations for virtual to physical address translation as part of the Security Extensions. All ARMv7 VMSA implementations support these operations. For details see [Virtual Address to Physical Address translation operations on page B3-1438](#).
- Additional bits are allocated in the NSACR. See [CP15 c1, VMSA Security Extensions support on page AppxL-2529](#).
- When implemented, the Cache Dirty Status Register is a Banked register. See [CP15 c7, Cache Dirty Status Register; CDSR on page AppxL-2532](#).
- A Cache Behavior Override Register is defined. See [CP15 c9, Cache Behavior Override Register, CBOR on page AppxL-2541](#).
- TCM access support registers are defined. See [CP15 c9, TCM Non-Secure Access Control Registers, DTCM-NSACR and ITCM-NSACR on page AppxL-2543](#).

CP15 support for the Security Extensions in ARMv7 is defined in [Classification of system control registers on page B3-1451](#).

### **CP15SDISABLE input**

The effect of this input is described for ARMv7 in [The CP15SDISABLE input on page B3-1458](#). In ARMv6K, TCM support is affected as follows:

- the DTCM\_NSAC and ITM\_NSAC registers are added to the controlled register list
- any TCM region registers restricted to Secure access only by the NSACR settings are added to the controlled register list.

## **L.6.5 PMSA**

PMSA in ARMv5 is IMPLEMENTATION DEFINED. The method described in [Protected memory support on page AppxO-2609](#) is only supported in ARMv4 and ARMv5. PMSA is formalized in ARMv6 under a different CP15 support model.

The PMSA support in ARMv6 (PMSAv6) differs from PMSAv7 in the following ways:

- PMSAv6 does not support subregions as defined in [Subregions on page B5-1755](#).
- The default memory map shown in [Table B5-1 on page B5-1757](#) and [Table B5-2 on page B5-1757](#) does not support the XN bit for restricting instruction fetches. The affected addresses are treated as Normal, Non-cacheable in PMSAv6.
- The default memory map applies only when the MPU is disabled. The SCTLR.BR bit is not supported in PMSAv6.
- TCM memory behaves as normal when the TCM region is enabled and the MPU is disabled.

In all other respects, PMSAv6 is as described for ARMv7 in [Chapter B5 Protected Memory System Architecture \(PMSA\)](#).

### **Execute-never, XN**

The ARMv7 requirement that instruction fetches are not made from read-sensitive devices also applies to earlier versions of the architecture:

- ARMv7 requires software to mark all read-sensitive devices with the XN attribute to ensure that this requirement is met, see [Execute-never restrictions on instruction fetching on page B3-1359](#)
- before ARMv7, how this requirement is met is IMPLEMENTATION DEFINED.

## L.7 System Control coprocessor, CP15, support

Much of the CP15 support is common to VMSAv6 and PMSAv6. However:

- some registers are unique to each memory system architecture
- some registers have different functionality in the two memory system architectures, for example the [SCTLR](#).

The following sections summarize the ARMv6 implementations of the CP15 registers:

- [Organization of CP15 registers for an ARMv6 VMSA implementation on page AppxL-2524](#)
- [Organization of CP15 registers for an ARMv6 PMSA implementation on page AppxL-2525](#).

The rest of this section describes the ARMv6 CP15 support in order of the CRn value. The description of each register:

- indicates whether the register is unique to VMSA or PMSA
- indicates any differences between the two implementations if the register is included in both VMSA and PMSA implementations.

### ———— **Note** —————

This approach is different from that taken in Part B of this manual, where:

- [Functional grouping of VMSAv7 system control registers on page B3-1491](#) is a complete description of CP15 support in a VMSAv7 implementation
- [Functional grouping of PMSAv7 system control registers on page B5-1797](#) is a complete description of CP15 support in a PMSAv7 implementation.

The convention used for fixed fields in the CP15 register definitions is defined in [Meaning of fixed bit values in register diagrams on page B3-1466](#).

In ARMv6 the execution of an MCR or MRC instruction with an unallocated CP15 register encoding is UNPREDICTABLE.

ARMv6 provides some MCRR instructions to support block transfers, see [Block transfer operations on page AppxL-2534](#).

### L.7.1 Organization of CP15 registers for an ARMv6 VMSA implementation

Figure L-1 shows the CP15 registers in a VMSAv6 implementation:

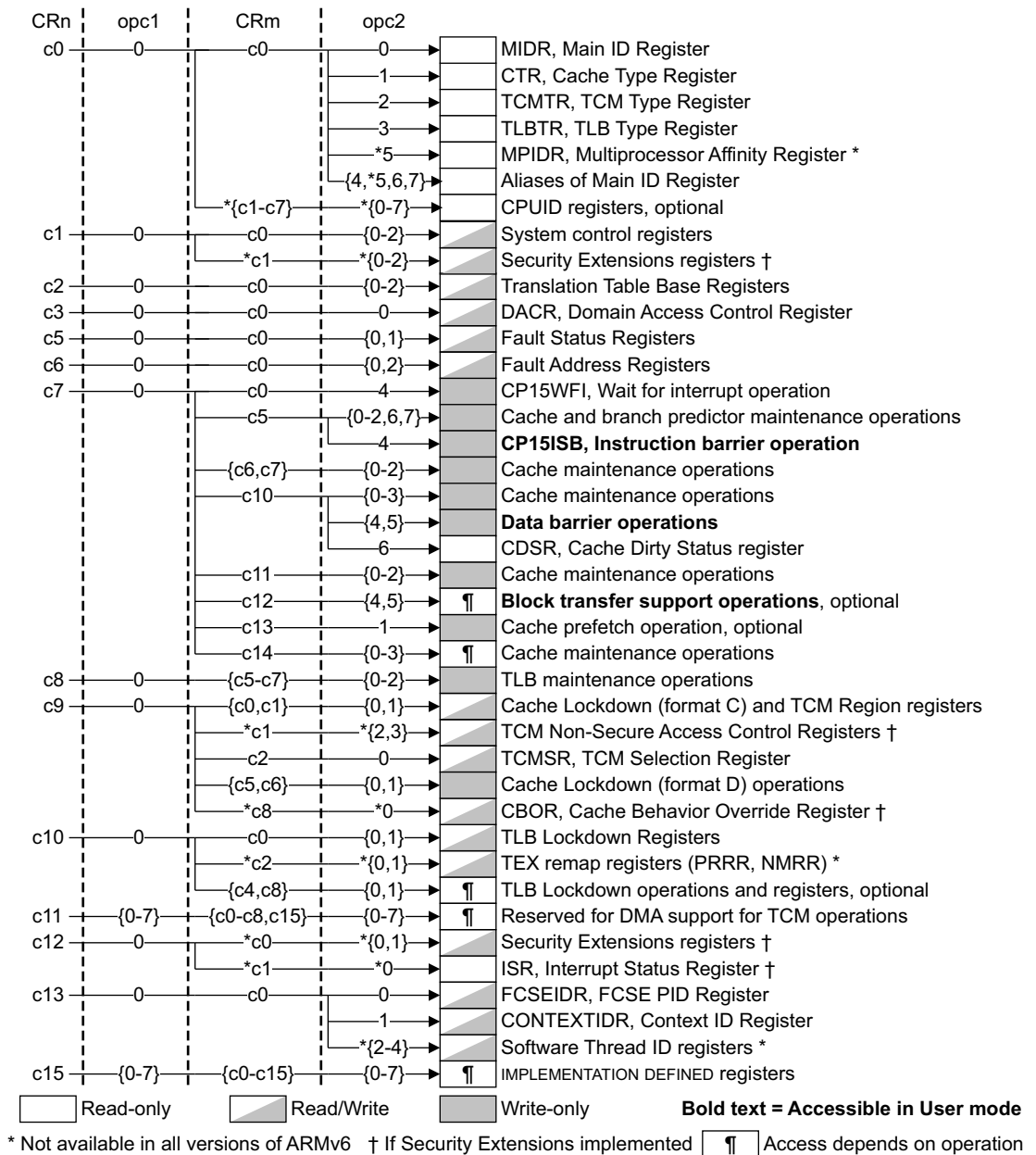

Figure L-1 CP15 registers in a VMSAv6 implementation



## L.7.2 Organization of CP15 registers for an ARMv6 PMSA implementation

Figure L-2 shows the CP15 registers in an PMSAv6 implementation:

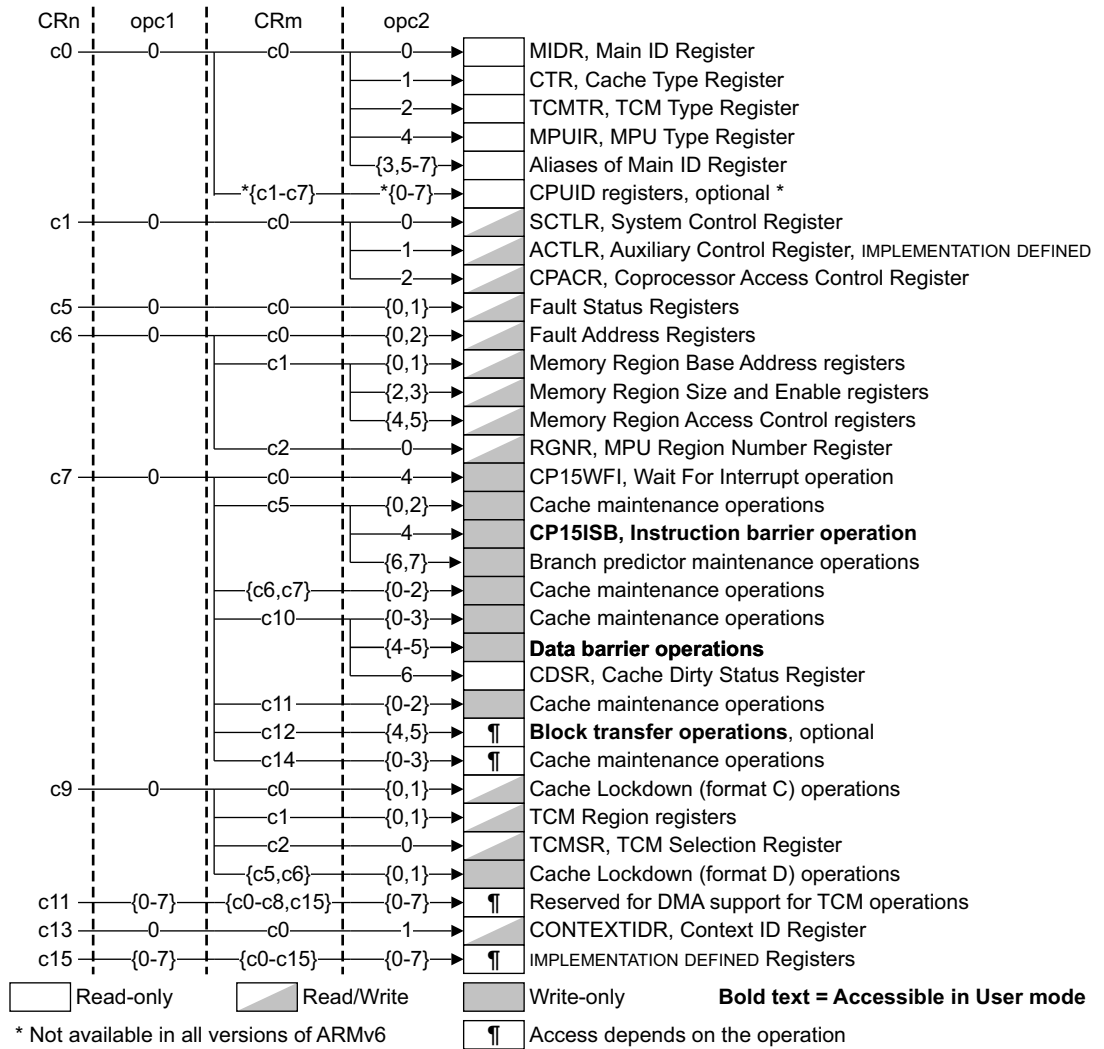

Figure L-2 CP15 registers in an PMSAv6 implementation

### L.7.3 CP15 c0, ID support

ARMv6 implementations include a Main ID Register, see:

- [MIDR, Main ID Register, VMSA on page B4-1648](#), for a VMSA implementation
- [MIDR, Main ID Register, PMSA on page B6-1892](#), for a PMSA implementation.

In this register, the architecture variant field either takes the assigned ARMv6 value or indicates support for an identification scheme based on a set of CPUID registers. The CPUID identification scheme is required in ARMv7 and recommended for ARMv6, and is described in [Chapter B7 The CPUID Identification Scheme](#).

Three other ID registers provide information about cache, TCM, and TLB provisions. From ARMv6K, there is also a Multiprocessor Affinity Register.

All of the CP15 c0 ID registers are read-only registers. They are accessed using MRC instructions, as shown in [Table L-6](#).

**Table L-6 ID register support**

Register	CRn	opc1	CRm	opc2
<a href="#">MIDR</a> , Main ID Register	c0	0	c0	0
<a href="#">CTR</a> , Cache Type ID Register	c0	0	c0	1
<a href="#">TCMTR</a> , TCM Type Register	c0	0	c0	2
<a href="#">TLBTR</a> , TLB Type Register <sup>a</sup>	c0	0	c0	3
<a href="#">MPUIR</a> , MPU Type Register <sup>c</sup>	c0	0	c0	4
<a href="#">MPIDR</a> , Multiprocessor Affinity Register <sup>b</sup>	c0	0	c0	5
Aliases of <a href="#">MIDR</a>	c0	0	c0	3 <sup>c</sup> , 4 <sup>a</sup> , 5 <sup>d</sup> , 6, 7
CPUID registers, if implemented	c0	0	c1	0-7
	c0	0	c2	0-5

a. VMSA processors only.

b. ARMv6K processors with VMSA only.

c. PMSA processors only.

d. All ARMv6 processors except ARMv6K VMSA implementations.

The Cache Type Register is as defined for ARMv4 and ARMv5, see [CP15 c0, Cache Type Register, CTR, ARMv4 and ARMv5 on page AppxO-2615](#). In ARMv6, the CType values of 0b0110 and 0b0111 are reserved and must not be used.

#### ———— Note ————

The ARMv6 format of the Cache Type Register is significantly different from the ARMv7 implementation described in [CTR, Cache Type Register, VMSA on page B4-1556](#). However, the general properties described by the register, and the access rights for the register, are unchanged.

The TCM Type Register is defined in [CP15 c0, TCM Type Register, TCMTR, ARMv6 on page AppxL-2527](#).

The TLB Type ID Register and the Multiprocessor Affinity Register are as defined for ARMv7, see:

- [CP15 c0, TLB Type ID Register, TLBTR, ARMv6 on page AppxL-2527](#)
- [MPIDR, Multiprocessor Affinity Register, VMSA on page B4-1650](#), for a VMSA implementation
- [MPIDR, Multiprocessor Affinity Register, PMSA on page B6-1894](#), for a PMSA implementation.

The MPU Type Register is as defined for ARMv7, see [MPUIR, MPU Type Register, PMSA on page B6-1897](#). In an ARMv6 PMSA implementation, if the MPU is not implemented use of the default memory map is optional.

## CP15 c0, TCM Type Register, TCMTR, ARMv6

The TCMTR must be implemented in ARMv6 and ARMv7. In ARMv7, the register can have a different format from that given here, see:

- *TCMTR, TCM Type Register, VMSA on page B4-1713*, for a VMSA implementation
- *TCMTR, TCM Type Register, PMSA on page B6-1936*, for a PMSA implementation.

In ARMv7, TCM support is IMPLEMENTATION DEFINED. For ARMv6, see *CP15 c9, TCM support on page AppxL-2538* and *CP15 c9, TCM Non-Secure Access Control Registers, DTCM-NSACR and ITCM-NSACR on page AppxL-2543* where the Security Extensions are supported.

In ARMv6, the TCMTR bit assignments are:

31	29 28	19 18	16 15	3 2	0
0 0 0	Reserved, UNK	DTCM	Reserved, UNK	ITCM	

**Bits[31:29]** Set to 0b000 before ARMv7.

**Bits[28:19, 15:3]** Reserved, UNK.

**DTCM, Bits[18:16]** Indicate the number of Data TCMs implemented. This value lies in the range 0 to 4, 0b000 to 0b100. All other values are reserved.

**ITCM, Bits[2:0]** Indicate the number of Instruction or Unified TCMs implemented. This value lies in the range 0 to 4, 0b000 to 0b100. All other values are reserved.  
Instruction TCMs are accessible to both instruction and data sides.

## CP15 c0, TLB Type ID Register, TLBTR, ARMv6

In an ARMv6 VMSA implementation the TLB Type Register, TLBTR, is a read-only register that defines whether the implementation provides separate instruction and data TLBs, or a unified TLB. It also defines the number of lockable TLB entries. The ARMv7-A description of the register describes the general features of the register and how to access it. See *TLBTR, TLB Type Register, VMSA on page B4-1718*. However, the register format is different in ARMv6. The ARMv6 TLBTR bit assignments are:

31	24 23	16 15	8 7	1 0
Reserved, UNK	I_nlock	D_nlock	Reserved, UNK	nU

**Bits[31:24, 7:1]** Reserved, UNK.

**I\_nlock, bits[23:16]** Number of lockable entries in the instruction TLB. The value of this field gives the number of lockable entries, between 0b00000000 for no lockable entries, and 0b11111111 for 255 lockable entries.  
When nU == 0 this field is reserved.

**D\_nlock, bits[15:8]** Number of lockable entries in the data TLB. The value of this field gives the number of lockable entries, between 0b00000000 for no lockable entries, and 0b11111111 for 255 lockable entries.

**nU, bit[0]** Not Unified TLB. Indicates whether the implementation has a unified TLB:  
**nU == 0** Unified TLB.  
**nU == 1** Separate instruction and data TLBs.



The differences from ARMv7 are:

- ARMv6 does not support the [SCTLR.IE](#) and [SCTLR.BR](#), bits 31 and 17.
- ARMv7 does not support:
  - The L2, L4, R, S, B, and W bits. These bits provide legacy support with ARMv4 and ARMv5. See [CP15 c1, System Control Register; SCTLR, ARMv4 and ARMv5](#) on page AppxO-2619 for their definition.  
The B bit must also meet the requirements defined in [Endian support](#) on page AppxL-2505.
  - The U bit. This bit is always 1 in ARMv7. It selects the ARMv4 and ARMv5 or the ARMv6 and ARMv7 alignment model. For details see [Alignment](#) on page AppxL-2504.
  - The XP bit. This bit is always 1 in ARMv7. The bit selects the virtual memory support model of ARMv6 and ARMv7 when [SCTLR.XP](#) = 1, and the legacy support for ARMv4 and ARMv5 when [SCTLRR.XP](#) = 0. For ARMv6 and ARMv7 support, see [VMSAv6 translation table format](#) on page AppxL-2520 and Chapter B3 [Virtual Memory System Architecture \(VMSA\)](#), and for ARMv4 and ARMv5 support, see [Legacy translation table format](#) on page AppxL-2520 and [Virtual memory support](#) on page AppxO-2604.
- The TE bit is defined for ARMv6T2 only. In ARMv6T2 it is the same as in ARMv7.

For the definition of bits supported in ARMv6 and ARMv7, see:

- [SCTLR, System Control Register; VMSA](#) on page B4-1705 for a VMSA implementation
- [SCTLR, System Control Register; PMSA](#) on page B6-1930 for a PMSA implementation.

### L.7.5 CP15 c1, VMSA Security Extensions support

An ARMv6 implementation that includes the Security Extensions provides:

- the Banking of bits in [SCTLR](#), see [CP15 c1, System Control Register; SCTLR](#) on page AppxL-2528
- features that are include in an ARMv7 implementation of the Security Extensions, see:
  - [SCR, Secure Configuration Register; Security Extensions](#) on page B4-1702
  - [SDER, Secure Debug Enable Register; Security Extensions](#) on page B4-1712
  - [NSACR, Non-Secure Access Control Register; Security Extensions](#) on page B4-1661

In addition, ARMv6 defines the following additional bits in the [NSACR](#):

- Bit[18], DMA** DMA control register access for support in CP15 c11 in the Non-secure address space. For more information, see [CP15 c11, DMA support](#) on page AppxL-2544.
- Bit[17], TL** TLB Lockdown Register access for support in CP15 c10 in the Non-secure address space. For information on TLB lockdown support in ARMv6 see [CP15 c10, VMSA TLB lockdown support](#) on page AppxL-2544.
- Bit[16], CL** Cache Lockdown Register access for support in CP15 c9 in the Non-secure address space. For information on cache lockdown support in ARMv6 see [CP15 c9, Cache lockdown support](#) on page AppxL-2537.

In all cases:

- a value of 0 in the bit position specifies that the associated registers cannot be accessed in the Non-secure address space
- a value of 1 in the bit position specifies that the associated registers can be accessed in the Secure and Non-secure address spaces.

Support of these additional bits and more details on how DMA support for TCMs, TLB lockdown, and cache lockdown are inhibited in the Non-secure address space is IMPLEMENTATION DEFINED.

## L.7.6 CP15 c2 and c3, VMSA memory protection and control registers

ARMv6 and ARMv7 provide the same CP15 support:

- two Translation Table Base Registers, [TTBR0](#) and [TTBR1](#)
- a Translation Table Base Control Register, [TTBCR](#)
- a Domain Access Control Register, [DACR](#).

The translation table registers are defined in *VMSA CP15 c2 and c3 register summary, Memory protection and control registers* on page B3-1473.

———— **Note** ————

In an implementation that includes the Security Extensions, these registers are Banked registers.

---

## L.7.7 CP15 c5 and c6, VMSA memory system support

The support in ARMv6 is the same as ARMv7 with the following exceptions:

- Bit 12 of the [DFSR](#) and [IFSR](#) is not defined in ARMv6.
- The *Auxiliary Data Fault Status Register* and the *Auxiliary Instruction Fault Status Register* (the [AxFSRs](#)) are not defined in ARMv6.
- The Access flag faults shown in [Table B3-23 on page B3-1415](#) are only supported in ARMv6K.

———— **Note** ————

- Before ARMv7, the [DFAR](#) was called the *Fault Address Register* (FAR).
  - In an implementation that includes the Security Extensions, these registers are Banked registers.
  - In ARMv6 variants other than ARMv6T2, the [IFAR](#) is optional.
- 

## L.7.8 CP15 c5 and c6, PMSA memory system support

The support in ARMv6 is the same as ARMv7 with the following exceptions:

- The [SCTLR.BR](#) bit, bit[17], is not supported in ARMv6.
- Bit 12 of the [DFSR](#) and [IFSR](#) is not defined in ARMv6.
- The *Auxiliary Data Fault Status Register* and the *Auxiliary Instruction Fault Status Register* (the [AxFSRs](#)) are not defined in ARMv6.
- Subregions are not supported. This means that [DRSR\[15:8\]](#) and [IRSR\[15:8\]](#) are not defined in ARMv6.

———— **Note** ————

- Before ARMv7, the [DFAR](#) was called the *Fault Address Register* (FAR).
  - In ARMv6 variants other than ARMv6T2, the [IFAR](#) is optional.
-

## L.7.9 CP15 c6, Watchpoint Fault Address Register, DBGWFAR

From v6.1 of the Debug architecture, this register is also implemented as DBGWFAR in CP14, and ARM deprecates the use of CP15 DBGWFAR. See *DBGWFAR, Watchpoint Fault Address Register* on page C11-2296 for a description of the register.

In an ARMv6 implementation that includes the Security Extensions, CP15 DBGWFAR is a Restricted access register, and can be accessed only from Secure PL1 modes. For more information, see *Restricted access system control registers* on page B3-1453.

For more information about this register see:

- for a VMSA implementation, *Data Abort on a Watchpoint debug event* on page B3-1412 and *Register updates on exception reporting at PL2* on page B3-1422
- for a PMSA implementation, *Data Abort exception on a Watchpoint debug event* on page B5-1768
- *Effect of entering Debug state on CP15 registers and the DBGWFAR* on page C5-2094.

**Table L-7 Debug fault address support**

Register	CRn	opc1	CRm	opc2
Watchpoint Fault Address Register, DBGWFAR	c6	0	c0	1

## L.7.10 CP15 c7, Cache and branch predictor operations

Table L-8 shows the cache operations defined for ARMv6. They are performed as MCR instructions and only operate on a level 1 cache associated with a specific processor. The equivalent operations in ARMv7 operate on multiple levels of cache. See *VMSA CP15 c7 register summary, Cache maintenance, address translation, and other functions* on page B3-1475. For a list of required operations in ARMv6, see *Cache support* on page AppxL-2517. Support of additional operations is IMPLEMENTATION DEFINED.

**Table L-8 Cache operation support**

Operation	CRn	opc1	CRm	opc2
Invalidate instruction cache <sup>a</sup>	c7	0	c5	0
Invalidate instruction cache line by MVA <sup>a</sup>	c7	0	c5	1
Invalidate instruction cache line by set/way	c7	0	c5	2
Invalidate all branch predictors <sup>a</sup>	c7	0	c5	6
Invalidate branch predictor entry by MVA <sup>a</sup>	c7	0	c5	7
Invalidate data cache	c7	0	c6	0
Invalidate data cache line by MVA <sup>a</sup>	c7	0	c6	1
Invalidate data cache line by set/way <sup>a</sup>	c7	0	c6	2
Invalidate unified cache, or instruction cache and data cache	c7	0	c7	0
Invalidate unified cache line by MVA	c7	0	c7	1
Invalidate unified cache line by set/way	c7	0	c7	2
Clean data cache	c7	0	c10	0
Clean data cache line by MVA <sup>a</sup>	c7	0	c10	1
Clean data cache line by set/way <sup>a</sup>	c7	0	c10	2

**Table L-8 Cache operation support (continued)**

Operation	CRn	opc1	CRm	opc2
Test and Clean data cache <sup>b</sup>	c7	0	c10	3
Cache Dirty Status Register <sup>c</sup>	c7	0	c10	6
Clean entire unified cache	c7	0	c11	0
Clean unified cache line by MVA <sup>a</sup>	c7	0	c11	1
Clean unified cache line by set/way	c7	0	c11	2
Prefetch instruction cache line by MVA <sup>d</sup>	c7	0	c13	1
Clean and Invalidate data cache	c7	0	c14	0
Clean and Invalidate data cache line by MVA <sup>a</sup>	c7	0	c14	1
Clean and Invalidate data cache line by set/way <sup>a</sup>	c7	0	c14	2
Test and Clean and Invalidate data cache <sup>b</sup>	c7	0	c14	3
Clean and Invalidate unified cache line by MVA	c7	0	c15	1
Clean and Invalidate unified cache line by set/way	c7	0	c15	2

- a. Of the ARMv6 operations shown in this table, these are the only operations available in ARMv7, see [Cache maintenance operations, functional group, VMSA on page B3-1496](#). In ARMv7
  - the operations are multi-level operations
  - the ARMv6 data cache operations are redefined as data or unified cache operations.
- b. For more information about these cache operations see [Test and clean operations on page AppxO-2629](#).
- c. Used with the Clean or Clean and Invalidate entire data cache and entire unified cache operations.
- d. VMSA implementations only, used with TLB lockdown. See [The TLB lock by entry model on page AppxO-2636](#).

### CP15 c7, Cache Dirty Status Register, CDSR

The Cache Dirty Status Register, CDSR, indicates whether the data or unified cache has been written to since the last successful cache clean. For more information, see [Cleaning and invalidating operations for the entire data cache on page AppxL-2533](#).

The Cache Dirty Status Register is:

- a 32-bit read-only register
- accessible only at PL1 or higher
- in an implementation that includes the Security Extensions, a Banked register.

The Cache Dirty Status Register bit assignments are:

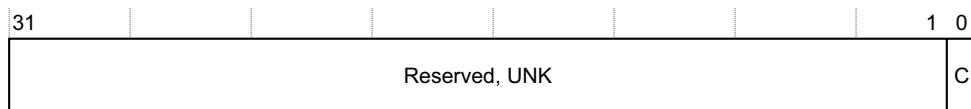

**Bits[31:1]** Reserved, UNK.

**C, bit[0]** Cache Dirty Status. The meaning of this bit is:

- 0** Cache clean. No write has hit the cache since the last cache clean or reset successfully cleaned the cache.
- 1** The cache might contain dirty data.



### Accessing the Cache Dirty Status Register

To access the Cache Dirty Status Register, read the CP15 registers with <opc1> set to 0, <CRn> set to c7, <CRm> set to c10, and <opc2> set to 6. For example:

```
MRC p15, 0, <Rt>, c7, c10, 6 ; Read Cache Dirty Status Register into Rt
```

### Cleaning and invalidating operations for the entire data cache

The CP15 c7 encodings include operations for cleaning the entire data cache, and for performing a clean and invalidate of the entire data cache. If these operations are interrupted, the LR value that is captured on the interrupt is (address of instruction that launched the cache operation + 4). This permits the standard return mechanism for interrupts to restart the operation.

If a particular operation requires that the cache is clean, or clean and invalid, then it is essential that the sequence of instructions for cleaning or cleaning and invalidating the cache can cope with the arrival of an interrupt at any time when interrupts are not disabled. This is because interrupts might write to a previously cleaned cache block. For this reason, the Cache Dirty Status Register indicates whether the cache has been written to since the last successful cache clean.

You can interrogate the Cache Dirty Status Register to determine whether the cache is clean, and if you do this while interrupts are disabled, a subsequent operation can rely on having a clean cache. The following sequence illustrates this approach.

```
; The following code assumes interrupts are enabled at this point.
Loop1
    MOV    R1, #0
    MCR    p15, 0, R1, c7, c10, 0          ; Clean data cache. For Clean and Invalidate,
                                           ; use MCR p15, 0, R1, c7, c14, 0 instead
    MRS    R2, CPSR                       ; Save PSR context
    CPSID  iaf                             ; Disable interrupts
    MRC    p15, 0, R1, c7, c10, 6         ; Read Cache Dirty Status Register
    TST    R1, #1                          ; Check if it is clean
    BEQ    UseClean
    MSR    CPSR_xc, R2                     ; Re-enable interrupts
    B      Loop1                           ; Clean the cache again
UseClean
    Do_Clean_Operations                    ; Perform whatever operation relies on
                                           ; the cache being clean or clean and invalid.
                                           ; To reduce impact on interrupt latency,
                                           ; this sequence should be short.
    MCR    p15, 0, R1, c7, c6, 0          ; Optional. Can use this Invalidate all command
                                           ; to invalidate a Clean loop.
    MSR    CPSR_xc, R2                     ; Re-enable interrupts
```

#### **Note**

The long cache clean operation is performed with interrupts enabled throughout this routine.

## Block transfer operations

ARMv7 does not support CP15 register block transfer operations, and they are optional in ARMv6. [Table L-9](#) summarizes block transfer operations. Permitted combinations of the block transfer operations are:

- all four operations
- clean, clean and invalidate, and invalidate operations
- none of the operations.

If an operation is not implemented, then it must cause an Undefined Instruction exception.

**Table L-9 Block transfer operations**

Operation	Blocking <sup>a</sup> or non-blocking	Instruction or data	Required privilege	Exception behavior
Prefetch range	Non-blocking	Instruction or data	Unprivileged or PL1	None
Clean range	Blocking	Data only	Unprivileged or PL1	Data Abort
Clean and Invalidate range	Blocking	Data only	PL1	Data Abort
Invalidate range	Blocking	Instruction or data	PL1	Data Abort

a. See [Blocking and non-blocking behavior](#)

An MCRR instruction starts each of the range operations. The data of the two registers specifies the Block start address and the Block end address. All block operations are performed on the cache lines that include the range of addresses between the Block start address and Block end address inclusive. If the Block start address is greater than the Block end address the effect is UNPREDICTABLE.

ARMv6 supports only one block transfer at a time. Attempting to start a second block transfer while a block transfer is in progress causes the first block transfer to be abandoned and starts the second block transfer. The Block Transfer Status Register indicates whether a block transfer is in progress. The register can be polled before starting a block transfer, to ensure any previous block transfer operation has completed.

All block transfers are interruptible. When blocking transfers are interrupted, the LR value that is captured is (address of instruction that launched the block operation + 4). This enables the standard return mechanism for interrupts to restart the operation.

For performance reasons, ARM recommends that implementations permit the following instructions to be executed while a non-blocking fetch address range instruction is being executed. In such an implementation, the LR value captured on an interrupt is determined by the instruction set state presented to the interrupt in the following instruction stream. However, implementations that treat a fetch address range instruction as a blocking operation must capture the LR value as described in the previous paragraph.

If the FCSE PID is changed while a fetch address range operation is running, it is UNPREDICTABLE at which point this change is seen by the fetch address range. For information about changing the FCSE PID see [FCSEIDR](#), [FCSE Process ID Register](#), [VMSA](#) on page B4-1565.

### Blocking and non-blocking behavior

The cache block transfer operations for cleaning, invalidating, or clean and invalidating a range of addresses from the cache are blocking operations. Following instructions must not be executed until the block transfer operation has completed. The fetch address range operation is non-blocking and can permit following instructions to be executed before the operation is complete. If an exception occurs a non-blocking operation does not signal an exception to the processor. This enables implementations to retire following instructions while the non-blocking operation is executing, without the requirement to retain precise processor state.

The blocking operations generate a Data Abort exception on a Translation fault if a valid translation table entry cannot be fetched. The [DFAR](#) indicates the address that caused the fault, and the [DFSR](#) indicates the reason for the fault.

Any fault on a fetch address range operation results in the operation failing without signaling an error.

**Register encodings**

Table L-10 shows the block operations supported using CP15. The operations are performed using an MCRR instruction. See *MCRR*, *MCRR2* on page A8-478.

The instruction format for block operations is:

MCRR p15, <Opc>, <Rt>, <Rn>, <CRm>

**Table L-10 Enhanced cache control operations using MCRR**

CRm	Opc	Function	Rn Data, VA <sup>a</sup>	Rt Data, VA <sup>a</sup>
c5	0	Invalidate instruction cache range <sup>b</sup>	Start address	End address
c6	0	Invalidate data cache range <sup>b</sup>	Start address	End address
c12	0	Clean data cache range <sup>c</sup>	Start address	End address
c12	1	Prefetch instruction range <sup>c</sup>	Start address	End address
c12	2	Prefetch data range <sup>c</sup>	Start address	End address
c14	0	Clean and invalidate data cache range <sup>b</sup>	Start address	End address

- a. The true virtual address, before any modification by the FCSE. See [Appendix J Fast Context Switch Extension \(FCSE\)](#). This address is translated by the FCSE logic.
- b. Accessible only from PL1. Results in an Undefined Instruction exception if the operation is attempted in User mode.
- c. Accessible in both unprivileged and PL1 modes.

**Note**

The ARMv6 MCRR encodings that support block operations are UNDEFINED in ARMv7.

The range operations operate on cache lines. The first cache line operated on is the line that contains the start address. The operation is then applied to every cache line up to and including the line that contains the end address.

The format of the start address and end address data values passed by the MCRR instructions is:

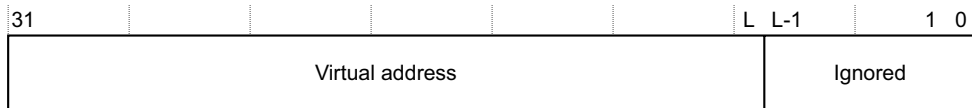

**Start address**      **Virtual Address bits[31:L]**  
The first virtual address of the block transfer.

**End address**      **Virtual Address bits[31:L]**  
The virtual address at which the block transfer stops. This address is at the start of the line containing the last address to be handled by the block transfer.

L is  $\text{Log}_2(\text{LINELEN})$ , where LINELEN is the cache line length parameter. Because the least significant address bits are ignored, the transfer automatically adjusts to a line length multiple spanning the programmed addresses.

**Note**

The block operations use virtual addresses, not modified virtual addresses. All other address-based cache operations use MVAs.

### CP15 c7 operations for block transfer management

Two CP15 c7 operations support block transfer management. These operations must be implemented when the block transfer operations are implemented:

**StopPrefetchRange** MCR p15, 0, <Rt>, c7, c12, 5 ; Write-only, <Rt> Should-Be-Zero

**PrefetchStatus** MRC p15, 0, <Rt>, c7, c12, 4 ; Read-only, read Block Transfer Status Register

Both operations are accessible in unprivileged and PL1 modes. Because all block operations are mutually exclusive, that is, only one operation can be active at any time, the PrefetchStatus operation returns the status of the last issued prefetch request, instruction, or data. This status is held in the Block Transfer Status Register.

### CP15 c7, Block Transfer Status Register

The Block Transfer Status Register indicates whether a block transfer is in progress.

The Block Transfer Status Register bit assignments are:

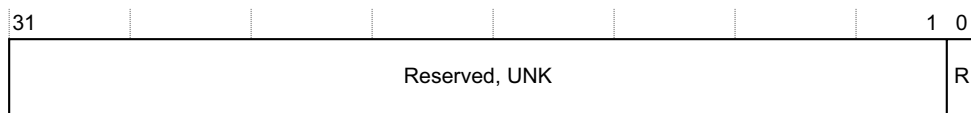

**Bits[31:1]** Reserved, UNK.

**R, bit[0]** Block fetch is Running:  
**0** No block fetch in operation  
**1** Block fetch in operation.

### L.7.11 CP15 c7, Miscellaneous functions

The Wait For Interrupt operation is used in some implementations as part of a power management support scheme. From ARMv6, ARM deprecates any use of this operation, and the operation is not supported in ARMv7, where it behaves as a NOP instruction.

Barrier operations are used for system correctness to ensure visibility of memory accesses to other agents in a system. Barrier functionality was formally defined as part of the memory architecture enhancements introduced in ARMv6. The definitions are the same as for ARMv7. For details see [Memory barriers](#) on page A3-150.

Table L-11 summarizes the MCR instruction encoding details.

Table L-11 memory barrier register support

Operation	CRn	opc1	CRm	opc2
<i>Wait For Interrupt</i> , CP15WFI	c7	0	c0	4
<i>Instruction Synchronization Barrier</i> , CP15ISB <sup>a</sup>	c7	0	c5	4
<i>Data Synchronization Barrier</i> , CP15DSB <sup>b</sup>	c7	0	c10	4
<i>Data Memory Barrier</i> , CP15DMB	c7	0	c10	5

a. This operation was previously called *Prefetch Flush* (PF or PFF).

b. This operation was previously called *Data Write Barrier* or *Drain Write Buffer* (DWB).

### L.7.12 CP15 c7, VMSA virtual to physical address translation support

In an ARMv6K implementation that includes the Security Extensions, virtual to physical address translation support is provided as described in [Virtual Address to Physical Address translation operations](#) on page B3-1438.

### L.7.13 CP15 c8, VMSA TLB support

CP15 TLB operation provision in ARMv6 is the same as for ARMv7-A. For details see [TLB maintenance requirements on page B3-1381](#) and [TLB maintenance operations, not in Hyp mode on page B4-1743](#).

### L.7.14 CP15 c9, Cache lockdown support

One problem with caches is that although they normally improve average access time to data and instructions, they usually increase the worst-case access time. This occurs for a number of reasons, including:

- There is a delay before the system determines that a cache miss has occurred and starts the main memory access.
- If a write-back cache is being used, there might be an extra delay because of the requirement to store the contents of the cache line that is being reallocated.
- A whole cache line is loaded from main memory, not only the data requested by the ARM processor.

In real-time applications, this increase in the worst-case access time can be significant.

Cache lockdown is an optional feature designed to alleviate this. It enables critical software and data, for example high priority interrupt routines and the data they access, to be loaded into the cache in such a way that the cache lines containing them are not subsequently reallocated. This ensures that all subsequent accesses to the software and data concerned are cache hits and therefore complete as quickly as possible.

From ARMv7, cache lockdown is IMPLEMENTATION DEFINED with no recommended formats or mechanisms on how it is achieved other than reserved CP15 register space. See [Cache lockdown on page B2-1270](#) and [Cache and TCM lockdown registers, VMSA on page B4-1750](#).

ARMv4 and ARMv5 specify four formats for the cache lockdown mechanism, called Format A, Format B, Format C, and Format D. The Cache Type Register contains information on the lockdown mechanism adopted. See [CP15 c0, Cache Type Register, CTR, ARMv4 and ARMv5 on page AppxO-2615](#). Formats A, B, and C all operate on cache ways. Format D is a cache entry locking mechanism.

ARMv6 cache lockdown support must comply with Format C or Format D. For more information, see [CP15 c9, cache lockdown support on page AppxO-2630](#).

#### ———— **Note** —————

A Format D implementation must use the CP15 lockdown operations with the CRm == {c5, c6} encodings, and not the alternative encodings with CRm == {c1, c2}.

### Interaction with CP15 c7 operations

Cache lockdown only prevents the normal replacement strategy used on cache misses from choosing to reallocate cache lines in the locked-down region. CP15 c7 operations that invalidate, clean, or clean and invalidate cache contents affect locked-down cache lines as normal. If invalidate operations are used, you must ensure that they do not use virtual addresses or cache set/way combinations that affect the locked-down cache lines. Otherwise, if it is difficult to avoid affecting the locked-down cache lines, repeat the cache lockdown procedure afterwards.

### L.7.15 CP15 c9, TCM support

In ARMv7, CP15 c9 encodings with CRm == {c0-c2, c5-c8} are reserved for IMPLEMENTATION DEFINED branch predictor, cache, and TCM operations. In ARMv6, the TCM Type Register can determine the TCM support the processor provides. See *CP15 c0, TCM Type Register, TCMTR, ARMv6* on page AppxL-2527. Table L-12 summarizes the additional register support for TCMs in ARMv6.

**Table L-12 TCM register support**

Instruction	TCM Register
MRC MCR p15, 0, <Rt>, c9, c1, 0	Data TCM Region Register, DTCMRR
MRC MCR p15, 0, <Rt>, c9, c1, 1	Instruction or unified TCM Region Register, ITCMRR
MRC MCR p15, 0, <Rt>, c9, c2, 0	TCM Selection Register, TCMSR

Each implemented TCM has its own Region register that is Banked onto either the Data TCM Region Register or the Instruction or unified TCM Region Register. The TCM Selection Register supplies the index for region register access.

Changing the TCM Region Register while a fetch address range or DMA operation is running has UNPREDICTABLE effects.

#### CP15 c9, TCM Selection Register, TCMSR

The TCM Selection Register selects the current TCM Region Registers. Where separate data and instruction TCMs are implemented, the value in the TCM Selection Register defined the current region for accesses to both the Data TCM Region Register and the Instruction TCM Region Register, see Table L-12.

The TCM Selection Register is:

- a 32-bit read/write register
- accessible only from PL1
- in an implementation that includes the Security Extensions, a Banked register.

The TCMSR bit assignments are:

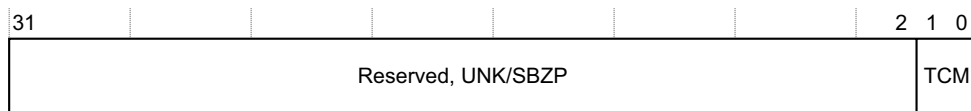

**Bits[31:2]** Reserved, UNK/SBZP.

#### TCM, bits[1:0]

TCM number, the index used for accessing a region register. TCM region registers can be accessed to read or change the details of the selected TCM.

This value resets to 0.

If this field is written with a value greater than or equal to the maximum number of implemented TCMs then the write is ignored.

## CP15 c9, TCM Region Registers. DTCMRR and ITCMRR

The TCM Region Registers provide control and configuration information for each TCM region.

Each TCM Region Register is:

- A 32-bit read/write register with some bits that are read-only.
- Accessible only from PL1.
- In an implementation that includes the Security Extensions, a Configurable access register with Non-secure access controlled by the DTCM-NSACR. See [CP15 c9, TCM Non-Secure Access Control Registers, DTCM-NSACR and ITCM-NSACR on page AppxL-2543](#).
- Accessed by reading or writing the CP15 registers with <opc1> set to 0, <CRn> set to c9, <CRm> set to c1, and <opc2> set to:
  - 0 for the current Data TCM Region Register
  - 1 for the current Instruction or unified Region Register.

For example:

```
MRC p15, 0, <Rt>, c9, c1, 0 ; Read current Data TCM Region Register
MCR p15, 0, <Rt>, c9, c1, 0 ; Write current Data TCM Region Register
MRC p15, 0, <Rt>, c9, c1, 1 ; Read current Instruction or unified TCM Region Register
MCR p15, 0, <Rt>, c9, c1, 1 ; Write current Instruction or unified TCM Region Register
```

The xTCMRR bit assignments are:

31		12 11	7 6	2 1 0
BaseAddress		Reserved, UNK/SBZP	Size	(0) En

### BaseAddress, bits[31:12]

The base address of the TCM, given as the physical address of the TCM in the memory map. BaseAddress is assumed to be aligned to the size of the TCM. Any address bits in the range  $[(\log_2(\text{RAMSize})-1):12]$  are ignored.

BaseAddress is 0 at reset.

**Bits[11:7]** Reserved, UNK/SBZP.

### Size, bits[6:2]

Indicates the size of the TCM. See [Table L-13 on page AppxL-2540](#) for encoding of this field.

This field is read-only and ignores writes.

**En, bit[0]** TCM enable bit:

**En == 0** Disabled. This is the reset value.

**En == 1** Enabled.

### ———— Note ————

Bit[1] was defined as a *SmartCache* enable bit in the previous version of the ARM architecture. SmartCache is now considered to be IMPLEMENTATION DEFINED and not documented in this manual.

Table L-13 shows the encoding of the Size field in the TCM Region Registers:

**Table L-13 TCM size field encoding**

Size field	Memory size
0b00000	0KByte
0b00001, 0b00010	Reserved
0b00011	4KByte
0b00100	8KByte
0b00101	16KByte
0b00110	32KByte
0b00111	64KByte
0b01000	128KByte
0b01001	256KByte
0b01010	512KByte
0b01011	1MByte
0b01100	2MByte
0b01101	4MByte
0b01110	8MByte
0b01111	16MByte
0b10000	32MByte
0b10001	64MByte
0b10010	128MByte
0b10011	256MByte
0b10100	512MByte
0b10101	1GByte
0b10110	2GByte
0b10111	4GByte
0b11xxx	Reserved

An attempt to access a TCM region that is not implemented is UNPREDICTABLE. This can occur if the number of data and instruction TCMs supported is not the same.

The base address of each TCM must be different, and chosen so that no location in memory is contained in more than one TCM. If a location in memory is contained in more than one TCM, it is UNPREDICTABLE which memory location the instruction or data is returned from. Implementations must ensure that this situation cannot result in physical damage to the TCM.





**S\_DL, bit[3]** Secure data cache linefill. Setting this bit to 1 disables data cache linefill for Secure regions. The possible values of this bit are:

- 0** Data cache linefill enabled. This corresponds to normal cache operation.
- 1** Data cache linefill disabled for regions marked as Secure.

**NS\_WT, bit[2]**

Non-secure Write-Through. Controls whether Write-Through is forced for regions marked as Non-secure and Write-Back. The possible values of this bit are:

- 0** Do not force Write-Through. This corresponds to normal cache operation.
- 1** Force Write-Through for regions marked as Non-secure and Write-Back.

**NS\_IL, bit[1]** Non-secure instruction cache linefill. Setting this bit to 1 disables instruction cache linefill for Non-secure regions. The possible values of this bit are:

- 0** Instruction cache linefill enabled. This corresponds to normal cache operation.
- 1** Instruction cache linefill disabled for regions marked as Non-secure.

**NS\_DL, bit[0]**

Non-secure data cache linefill. Setting this bit to 1 disables data cache linefill for Non-secure regions. The possible values of this bit are:

- 0** Data cache linefill enabled. This corresponds to normal cache operation.
- 1** Data cache linefill disabled for regions marked as Non-secure.

It might be necessary to ensure that cache contents are not changed, for example when debugging or when processing an interruptible cache operation. The CBOR provides this option.

For example, Clean All, and Clean and Invalidate All operations in Non-secure state might not prevent FIQs to the Secure side if the FW bit in the SCR is set to 0. In this case, operations in the Secure state can read or write Non-secure locations in the cache. Such operations might cause the cache to contain valid or dirty Non-secure entries after the Non-secure Clean All and Clean and Invalidate All operation has completed. To prevent this problem, the Secure state must be:

- prevented from allocating Non-secure entries into the cache by disabling Non-secure linefill
- made to treat all writes to Non-secure regions that hit in the cache as being write-through by forcing Non-secure Write-Through.

The CBOR provides separate controls for Secure and Non-secure memory regions, and can prevent cache linefill, or force Write-Through operation, while leaving the caches enabled. The controls for Secure memory regions can be accessed only when the processor is in the Secure state.

### **Accessing the CBOR**

To access the CBOR, read or write the CP15 registers with <opc1> set to 0, <CRn> set to c9, <CRm> set to c8, and <opc2> set to 0. For example:

```
MRC p15, 0, <Rt>, c9, c8, 0 ; Read CP15 Cache Behavior Override Register
MCR p15, 0, <Rt>, c9, c8, 0 ; Write CP15 Cache Behavior Override Register
```

## CP15 c9, TCM Non-Secure Access Control Registers, DTCM-NSACR and ITCM-NSACR

The *Data TCM Non-Secure Access Control Register* (DTCM-NSACR) defines the accessibility of the Data TCM Region Register when the processor is in Non-secure state.

The *Instruction TCM Non-Secure Access Control Register* (ITCM-NSACR) defines the accessibility of the current Instruction or Unified TCM Region Register when the processor is in Non-secure state.

For information on TCM support, see [TCM support on page AppxL-2518](#).

The TCM-NSACRs are:

- 32-bit read/write registers
- accessible only from PL1
- implemented only in a VMSAv6 implementation that includes the Security Extensions
- Restricted access registers, see [Restricted access system control registers on page B3-1453](#).

The format of an *x*TCM-NSACR is:

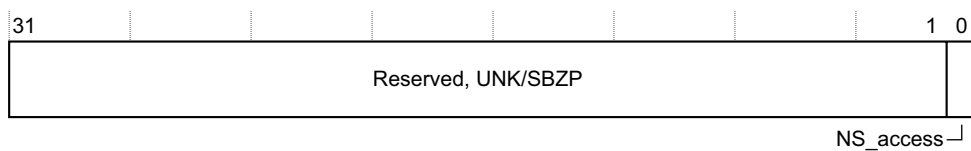

**Bits[31:1]** Reserved, UNK/SBZP.

**NS\_access, bit[0]**

Non-secure access. Defines the accessibility of the corresponding current TCM Region Register from the Non-secure state. The possible values of this bit are:

- 0** The corresponding TCM Region Register is accessible only in Secure PL1 modes. The information stored in the corresponding TCM is Secure, and the TCM is visible only if the processor is in the Secure state and the translation table is marked as Secure.
- 1** The corresponding TCM Region Register is accessible from PL1 in both Secure and Non-secure state. The information stored in the corresponding TCM is Non-secure. The TCM is visible in the Non-secure state. It is visible in the Secure state only if the translation table is marked correctly as Non-secure.

The value of the TCM-NSACR.NS\_access bit and the processor security state determine whether the TCM is visible. The value of the NS bit for the translation table entry determines what data is visible in the TCM. [Table L-14](#) shows when the TCM is visible, and what data is visible.

**Table L-14 Visibility of TCM and TCM data**

Processor security state	TCM-NSACR NS_access bit	Translation table NS value	TCM visibility	Data visible
Secure	0	0	Visible	Secure
Secure	0	1	Not visible	-
Secure	1	0	Not visible	-
Secure	1	1	Visible	Non-secure
Non-secure	0	x	Not visible	-
Non-secure	1	x	Visible	Non-secure

Table L-15 shows when the TCM Region Register can be accessed, permitting control of the TCM.

**Table L-15 Accessibility of TCM Region Register**

Processor security state	TCM-NSACR NS_access bit	TCM Region Register access
Secure	x	From PL1 only
Non-secure	0	No access
Non-secure	1	From PL1 only

### Accessing the TCM-NSACRs

To access the TCM-NSACRs, read or write the CP15 registers with <opc1> set to 0, <CRn> set to c9, <CRm> set to c1, and <opc2> set to:

- 2 to access the DTCM-NSACR
- 3 to access the ITCM-NSACR.

For example

```
MRC p15, 0, <Rt>, c9, c1, 2 ; Read CP15 Data TCM Non-Secure Access Control Register
MCR p15, 0, <Rt>, c9, c1, 2 ; Write CP15 Data TCM Non-Secure Access Control Register
MRC p15, 0, <Rt>, c9, c1, 3 ; Read CP15 Instruction TCM Non-Secure Access Control Register
MCR p15, 0, <Rt>, c9, c1, 3 ; Write CP15 Instruction TCM Non-Secure Access Control Register
```

### L.7.17 CP15 c10, VMSA memory remapping support

ARMv7-A memory remapping is supported from ARMv6K with the addition of the [SCTLR.TRE](#) enable bit and the [PRRR](#) and [NMRR](#).

### L.7.18 CP15 c10, VMSA TLB lockdown support

TLB lockdown is an optional feature that enables the results of specified translation table walks to be loaded into the TLB, in such a way that they are not overwritten by the results of subsequent translation table walks.

Translation table walks can take a long time, especially as they involve potentially slow main memory accesses. In real-time interrupt handlers, translation table walks caused by the TLB not containing translations for the handler or the data it accesses can increase interrupt latency significantly.

Two basic lockdown models are supported:

- a TLB lock by entry model
- a translate and lock model introduced as an alternative model in ARMv5TE.

From ARMv7-A, TLB lockdown is IMPLEMENTATION DEFINED with no recommended formats or mechanisms on how it is achieved other than reserved CP15 register space. See [TLB lockdown](#) on page B3-1379 and [VMSA CP15 c10 register summary, memory remapping and TLB control registers](#) on page B3-1478.

For ARMv6, TLB lockdown must comply with one of the lockdown models described in [CP15 c10, TLB lockdown support](#), [VMSA](#) on page AppxO-2636.

### L.7.19 CP15 c11, DMA support

ARM considers the ARMv6 DMA support for TCMs described in *The ARM Architecture Reference Manual* (DDI 0100) as an IMPLEMENTATION DEFINED feature, and therefore it is not included in this manual. This means that, architecturally, ARMv6 is the same as ARMv7. See [VMSA CP15 c11 register summary, reserved for TCM DMA registers](#) on page B3-1478.

## L.7.20 CP15 c12, VMSA support for the Security Extensions

CP15 c12 support for the Security Extensions in ARMv6 is the same as in ARMv7:

- the Vector Base Address Register, VBAR
- the Monitor Base Address Register, [MVBAR](#)
- the Interrupt Status Register, ISR.

For details see [VMSA CP15 c12 register summary](#), [Security Extensions registers](#) on page B3-1479.

## L.7.21 CP15 c13, Context ID support

Both PMSAv6 and VMSAv6 require the [CONTEXTIDR](#) described in:

- [CONTEXTIDR, Context ID Register, VMSA](#) on page B4-1548, for a VMSA implementation
- [CONTEXTIDR, Context ID Register, PMSA](#) on page B6-1827, for a PMSA implementation.

In addition:

- A VMSAv6 implementation requires the [FCSEIDR](#). In ARMv6 the FCSE must be implemented. For more information, see [Appendix J Fast Context Switch Extension \(FCSE\)](#).
- An ARMv6K implementation requires the Software Thread ID registers described in [VMSA CP15 c13 register summary](#), [Process, context and thread ID registers](#) on page B3-1479.

### ————— **Note** —————

In ARMv6, after any change to the [CONTEXTIDR](#) or [FCSEIDR](#), software must use the CP15 branch predictor maintenance operations to flush the virtual addresses affected by the change. If the branch predictor is not invalidated in this way, attempting to execute an old branch might cause UNPREDICTABLE behavior. ARMv7 does not require branch predictors to be invalidated after a change to the [CONTEXTIDR](#) or [FCSEIDR](#).

## L.7.22 CP15 c15, IMPLEMENTATION DEFINED

As in ARMv7, CP15 c15 is reserved for IMPLEMENTATION DEFINED use. Typically, it is used for processor-specific runtime and test features.



# Appendix M

## v6 Debug and v6.1 Debug Differences

This chapter describes how the ARM debug architectures for ARMv6 differ from the v7 Debug implementation described in part C of this manual. It contains the following sections:

- *About v6 Debug and v6.1 Debug* on page AppxM-2548
- *Invasive debug authentication, v6 Debug and v6.1 Debug* on page AppxM-2549
- *Debug events, v6 Debug and v6.1 Debug* on page AppxM-2550
- *Debug exceptions, v6 Debug and v6.1 Debug* on page AppxM-2554
- *Debug state, v6 Debug and v6.1 Debug* on page AppxM-2555
- *Debug register interfaces, v6 Debug and v6.1 Debug* on page AppxM-2559
- *Reset and powerdown support* on page AppxM-2562
- *The Debug Communications Channel and Instruction Transfer Register* on page AppxM-2563
- *Non-invasive debug authentication, v6 Debug and v6.1 Debug* on page AppxM-2564
- *Sample-based profiling, v6 Debug and v6.1 Debug* on page AppxM-2566
- *The debug registers, v6 Debug and v6.1 Debug* on page AppxM-2567
- *Performance monitors, v6 Debug and v6.1 Debug* on page AppxM-2578.

## M.1 About v6 Debug and v6.1 Debug

This appendix describes how the ARMv6 debug architectures differ from the base v7 Debug architecture described in part C of this manual.

ARMv6 is the first version of the ARM architecture to include debug. v6 Debug corresponds to the base ARMv6 architecture. The introduction of the ARM architecture Security Extensions extended the Debug architecture, defining the v6.1 Debug Architecture. This means that:

- ARMv6 processors without the Security Extensions implement v6 Debug
- ARMv6 processors with the Security Extensions implement v6.1 Debug.

### ———— Note —————

v6.1 Debug and v6 Debug are two different versions of the Debug architecture for the ARMv6 architecture. They might be described as:

- ARMv6, v6.1 Debug
- ARMv6, v6 Debug.

Throughout this appendix the descriptions v6.1 Debug and v6 Debug are used, for brevity.

*Major differences between the ARMv6 and ARMv7 Debug architectures* summarizes the main differences in the v7 Debug. Each section of this appendix then describes the differences in the corresponding chapter of part C of this manual.

*Chapter C1 Introduction to the ARM Debug Architecture* generally applies also to v6 Debug and v6.1 Debug, except that:

- ARMv7 is the first architecture version to define the Performance Monitors Extension. Performance monitors were implemented in several processors before ARMv7, but these are not software compatible with the ARMv7 Performance Monitors Extension.
- v6.1 Debug always supports Secure User halting debug. This means the alternatives for when a debug event is permitted are:
  - in all processor modes, in both Secure and Non-secure security state
  - only in Non-secure state
  - in Non-secure state and in Secure User mode.
- The register interface requirements and recommendations for v6 Debug and v6.1 Debug are different. These debug architecture versions:
  - require that software running on the processor can access the debug registers using CP14 instructions
  - do not recommend the use of ADIV5 as an external debug interface
  - do not support external debug over powerdown of the processor using their recommended interfaces.

### M.1.1 Major differences between the ARMv6 and ARMv7 Debug architectures

Compared to v6.1 Debug, v7 Debug introduces additional extensions to support developments in the debug environment.

The main change in the Debug architecture is the specification of new forms of external debug interface. ARMv6 Debug does not require a particular debug interface, but can be implemented with access from a JTAG interface as defined in *IEEE Standard Test Access Port and Boundary Scan Architecture (JTAG)*. However, systems such as the ARM CoreSight™ architecture require changes in the debug interface. For more information about the CoreSight architecture see the *CoreSight Architecture Specification*. ARMv7 Debug addresses some of the aims of the CoreSight architecture, such as a more system-centric view of debug, and improved debug of powered-down systems.

v7 Debug also introduces an architecture extension to provide performance monitors.



## M.2 Invasive debug authentication, v6 Debug and v6.1 Debug

A v6.1 Debug implementation must support Secure User halting debug. See [Invasive debug authentication in an implementation that supports SUHD on page AppxN-2581](#) for how this affects invasive debug authentication.

v7 Debug introduces the OS Lock mechanism, and v7.1 Debug introduces the OS Double Lock mechanism. Therefore the effects of setting the OS Lock or OS Double Lock described in [About invasive debug authentication on page C2-2028](#) never apply to any v6 Debug or v6.1 Debug implementation.

v6.1 Debug supports dynamic control of debug permission, referred to in a Note in [About invasive debug authentication on page C2-2028](#). However, in v6 Debug, invasive debug authentication can be changed only while the processor is in reset.

### M.3 Debug events, v6 Debug and v6.1 Debug

v6 Debug and v6.1 Debug do not support the OS Save and Restore mechanism, and therefore they do not support the OS Unlock catch Halting debug event. Also, the following additional information applies to [Table C3-1](#) on [page C3-2036](#):

- When DBGDSCR[15:14] is 0b10, Monitor Debug-mode selected and enabled, the processor ignores some Software debug events.
- In v6 Debug only, when DBGDSCR[15:14] is 0b10, Monitor Debug-mode selected and enabled, or 0b00, no Debug-mode selected, it is IMPLEMENTATION DEFINED whether the processor enters Debug state on a Halting debug event, or ignores the event.

Figure M-1 summarizes the processor behavior on debug events for these Debug architecture versions.

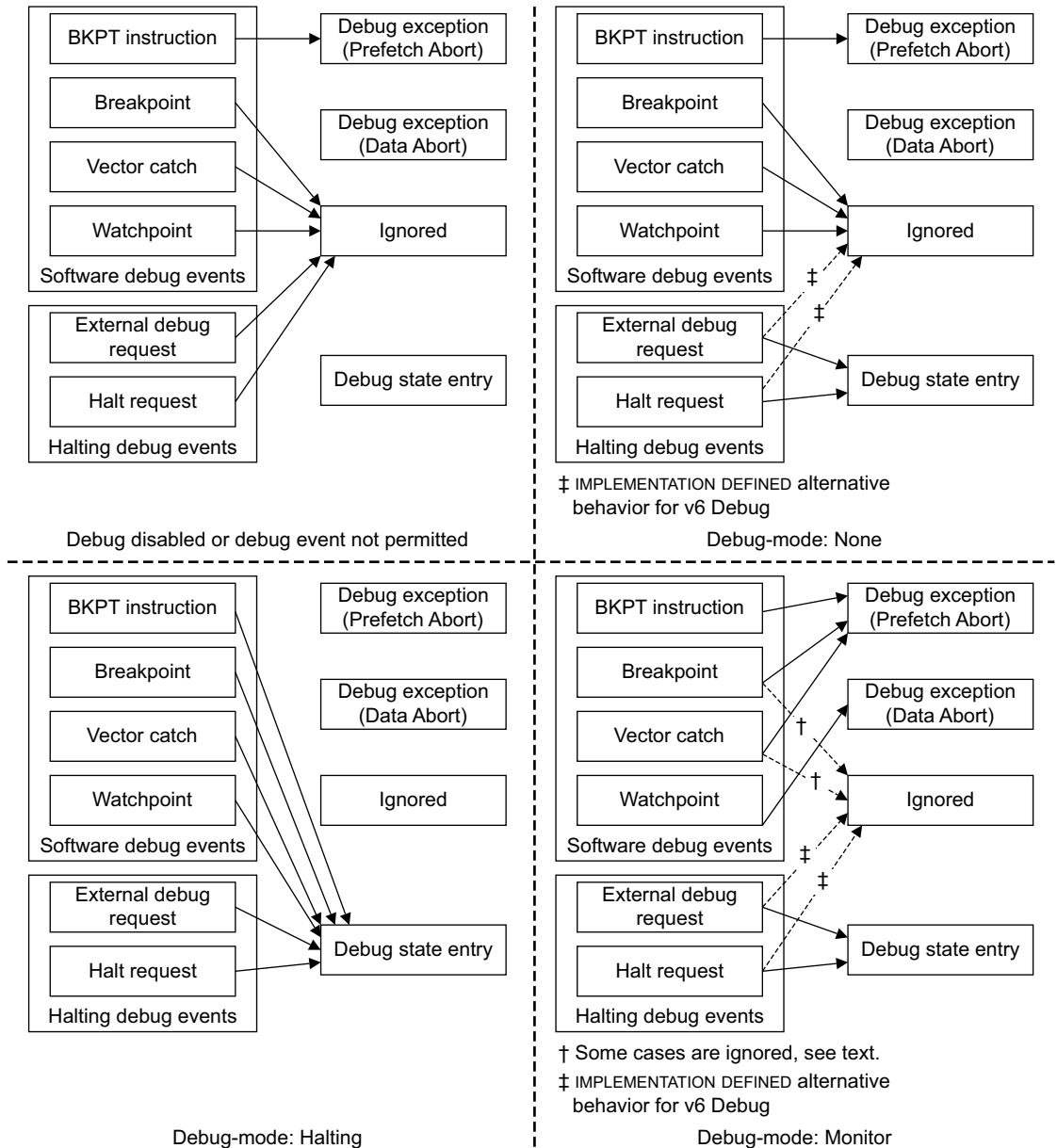

Figure M-1 Processor behavior on debug events, for v6 Debug and v6.1 Debug

### M.3.1 Software debug events

This section describes the v6 Debug and v6.1 Debug differences from the information in given in [About debug events on page C3-2036](#). [The debug registers, v6 Debug and v6.1 Debug on page AppxM-2567](#) includes other relevant information.

———— **Note** —————

- Security state control is relevant only to processors that implement the Security Extensions and therefore is not supported in v6 Debug.
- ARMv7 introduces ThumbEE state and the ThumbEE instruction set. Therefore, any references to ThumbEE are not relevant to v6 Debug and v6.1 Debug.

#### Breakpoint debug events

In the section [Breakpoint debug events on page C3-2039](#), the differences for v6 Debug and v6.1 Debug are:

- v7.1 Debug introduces VMID matching and the [DBGXVR](#).
- v7 Debug introduces address range masking:
  - in v6 Debug and v6.1 Debug, instruction address comparisons always use byte address selection
  - information given about byte address selection also applies to v6 Debug and v6.1 Debug
  - the section [Breakpoint address range masking behavior on page C3-2049](#) applies only from v7 Debug.
- v6.1 Debug introduces instruction address mismatch comparisons. v6 Debug does not support these comparisons.
- The effects of instruction length on address comparisons are different in v6 Debug and v6.1 Debug:
  - [Effect of instruction length in v6 Debug and v6.1 Debug](#) describes these effects
  - [Instruction address comparison programming examples for ARMv6 on page AppxM-2552](#) gives additional programming examples.

In v6 Debug and v6.1 Debug, the processor ignores the following Breakpoint debug events if Monitor debug-mode is configured, because they could lead to an unrecoverable state:

- Unlinked Context ID Breakpoint debug events, if the processor is running in a PL1 mode
- Linked or Unlinked instruction address mismatch Breakpoint debug events, if the processor is running in a PL1 mode.

#### **Effect of instruction length in v6 Debug and v6.1 Debug**

In v6 Debug and v6.1 Debug:

- If the conditions in the [DBGBCR](#) are met, and the instruction is committed for execution, the breakpoint generates a Breakpoint debug event if the required [DBGBVR](#) comparison, taking account of the byte address selection, hits for the first unit of the instruction.
- It is IMPLEMENTATION DEFINED whether an instruction address comparison hit on the second halfword of a Thumb instruction, following a breakpoint miss on the first halfword of the instruction, can cause a Breakpoint debug event.
- For Java bytecodes, a breakpoint comparison hit on an operand does not generate a Breakpoint debug event. A Breakpoint debug is generated only if the breakpoint hits on the opcode.

### **Instruction address comparison programming examples for ARMv6**

The examples in [Instruction address comparison programming examples on page C3-2050](#) largely apply also to v6 Debug and v6.1 debug, but this subsection gives additional information about programming breakpoints for instruction address comparison in these Debug architecture versions.

Before ARMv6T2, on a processor that implements the Thumb instruction set and can take an exception between the two halfwords of a Thumb BL or BLX (immediate) instruction, a debugger must treat the two halfwords as separate instructions, and set breakpoints on both halfwords. This might require two breakpoints.

#### ———— **Note** ————

To ensure compatibility across ARMv6 implementations, a debugger can always treat BL or BLX (immediate) as two instructions when debugging software on an ARMv6 processor before ARMv6T2.

In considering the programming examples in [Instruction address comparison programming examples on page C3-2050](#):

- The example for setting a breakpoint on a 32-bit Thumb instruction applies to setting breakpoints on an ARMv7 or ARMv6T2 processor.
  - To breakpoint on a 16-bit or a 32-bit Thumb or ThumbEE instruction starting at address 0x8000, the debugger must set **DBGBVR**<sub>n</sub> to 0x8000 and **DBGBCR**<sub>n</sub>.BAS to 0b0011. These are the settings for breakpointing on any Thumb instruction, including BL and BLX (immediate).
- In addition, on an ARMv6 or ARMv6K processor:
  - To breakpoint on a Thumb BL or BLX instruction at address 0x8000, a debugger must set **DBGBVR**<sub>n</sub> to 0x8000, and **DBGBCR**<sub>n</sub>.BAS to 0b1111.
  - To breakpoint on a Thumb BL or BLX instruction at address 0x8002, a debugger must set **DBGBVR**<sub>n</sub> to 0x8000, **DBGBVR**<sub>m</sub> to 0x8004, **DBGBCR**<sub>n</sub>.BAS to 0b1100, and **DBGBCR**<sub>m</sub>.BAS to 0b0011.

#### ———— **Note** ————

When programming **DBGBVR** for instruction address match or mismatch, the debugger must program **DBGBVR**[1:0] to 0b00, otherwise Breakpoint debug event generation is UNPREDICTABLE.

### **Watchpoint debug events**

In the section [Watchpoint debug events on page C3-2057](#), the differences for v6 Debug and v6.1 Debug are:

- v7 Debug introduces support for an 8-bit byte select field:
  - In the description in [Byte address selection behavior on data address match on page C3-2060](#), the reference to an 8-bit byte select field cannot apply to v6 Debug and v6.1 Debug implementations.
  - In v6 Debug and v6.1 Debug implementations, **DBGWCR**[12:9] is UNK/SBZP, and [Table C3-5 on page C3-2061](#) cannot apply.
- In ARMv6, when using the optional legacy BE-32 endianness model, the values of **DBGWCR**.BAS[3:0] shown in [Table C3-4 on page C3-2060](#) have different meanings. For more information see [BE-32 DBGWCR Byte address select values on page AppxL-2505](#).
- ARMv6 permits only synchronous watchpoints. The subsection [Asynchronous Watchpoint debug events on page C3-2063](#) is not relevant to v6 Debug and v6.1 Debug implementations.

## Vector catch debug events

In the section [Vector catch debug events on page C3-2065](#), the differences for v6 Debug and v6.1 Debug are:

- If Monitor debug-mode is selected and enabled, and the vector is either the Prefetch Abort vector or the Data Abort vector, the debug event is ignored in v6 Debug and v6.1 Debug. This differs from the v7 Debug information given in the section [Generation of Vector catch debug events on page C3-2066](#).
- In v6.1 Debug, Reset Vector catches are generated only in Secure state, see [Reset Vector catch using address matching on page C3-2071](#).

———— **Note** —————

The Security Extensions cannot be implemented with v6 Debug.

- An ARMv6 processor that implements the Security Extensions might not implement **DBGVCR** bits[31, 30, 28:25, 15:14, 12:10]. For such a processor:
  - in Non-secure state, **DBGVCR**[7:6, 4:1] apply to offsets from **VBAR<sub>NS</sub>**
  - in Secure state, **DBGVCR**[7:6, 4:1] apply to offsets from **VBAR<sub>S</sub>** and **DBGVCR**[7:6, 4:2] also apply to offsets from **MVBAR**.

In v6 Debug and v6.1 Debug, the processor ignores Vector catch debug events on the Prefetch Abort and Data Abort vectors if Monitor debug-mode is configured, because they could lead to an unrecoverable state.

### M.3.2 Halting debug events

In the section [Halting debug events on page C3-2073](#), the differences for v6 Debug and v6.1 Debug are:

- v7 Debug introduces the **DBGDRCR**, and therefore v6 Debug and v6.1 Debug cannot write to this register to cause a Halt request debug event. However, if the implementation includes the recommended ARM Debug Interface v4, a debugger can issue a Halt request command through the JTAG interface, by placing the HALT instruction in the IR and taking the *Debug Test Access Port State Machine* (Debug TAP State Machine) through the Run-Test/Idle state.
- v6 Debug and v6.1 Debug do not support OS Unlock catch Halting debug event. This is because they do not support the OS Save and Restore mechanism.
- In v6 Debug, when Halting debug-mode is not configured and enabled it is IMPLEMENTATION DEFINED whether Halting debug events cause entry to Debug state, or are ignored.

## M.4 Debug exceptions, v6 Debug and v6.1 Debug

On a VMSAv6 processor in Monitor debug-mode, an exception is generated as a result of a Watchpoint debug event, the **DFSR** Domain field, **DFSR[7:4]**, is updated, and a read of this field returns valid data.

## M.5 Debug state, v6 Debug and v6.1 Debug

In v6 Debug, when debug is enabled and Halting debug-mode is not selected it is IMPLEMENTATION DEFINED whether a Halting debug event causes entry to Debug state. For more information, see [Debug events, v6 Debug and v6.1 Debug](#) on page AppxM-2550.

### M.5.1 Entering Debug state

In the section [Entering Debug state](#) on page C5-2093, the differences for v6 Debug and v6.1 Debug are:

- In ARMv6, all CP15 registers except for the DBGWFER are unchanged on entry to Debug state. The unchanged registers include the IFSR, DFSR, DFAR, and IFAR. The section [Effect of entering Debug state on CP15 registers and the DBGWFER](#) on page C5-2094 does not apply to v6 Debug and v6.1 Debug.
- The behavior of asynchronous aborts is different, see [Asynchronous aborts and Debug state](#) on page AppxM-2558.

### M.5.2 Executing instructions in Debug state

The following subsections describe how instruction execution in v6 Debug and v6.1 Debug differs from the description given in [Executing instructions in Debug state](#) on page C5-2096.

#### Behavior of instructions that access the CPSR in Debug state

[Behavior of MRS and MSR instructions that access the CPSR in Debug state](#) on page C5-2097:

- applies for instructions that modify the CPSR in Debug state in v6.1 Debug.
- does not apply for v6 Debug.

Table M-1 shows the Debug-state behavior of instructions that modify the CPSR in v6 Debug.

**Table M-1 Debug-state behavior of Instructions that modify the CPSR, v6 Debug**

Instruction	Behavior
BX	UNPREDICTABLE if CPSR.J is 1. Can be used to set or clear the CPSR.T bit.
BXJ	UNPREDICTABLE if either CPSR.J or CPSR.T is 1. Can be used to set CPSR.J to 1.
SETEND	UNPREDICTABLE.
CPS	UNPREDICTABLE.
<op>S PC, <Rn>, <operand> <sup>a</sup> <op1>S PC, <operand> <sup>b</sup>	Can set the restart address, and set the CPSR by copying it from the SPSR of the current mode.
MSR CPSR_<fields> <sup>c</sup>	Use for setting the CPSR bits other than the execution state bits.
LDM (exception return), RFE	UNPREDICTABLE.

a. <op> is one of ADC, ADD, AND, ASR, BIC, EOR, LSL, LSR, ORR, ROR, RSB, RSC, SBC, or SUB. See [SUBS PC, LR and related instructions \(ARM\)](#) on page B9-2010 for more information about the instructions and the required <operand>.

b. <op1> is one of MOV, MVN, or RRX. See [SUBS PC, LR and related instructions \(ARM\)](#) on page B9-2010 for more information about the instructions and the required <operand>.

c. For all permitted values of <fields>.

———— **Note** ————

In v6 Debug the **CPSR** and PC can be written in a single instruction, for example, `MOVSp, 1r`. In this case, the behavior is as if the **CPSR** is written first, followed by the PC. That is, if the processor is later forced to restart the restart address is predictable. This is not possible in v6.1 Debug or v7 Debug, because in these versions of the Debug architecture such instructions are themselves UNPREDICTABLE in Debug state.

**Data-processing instructions that access the PC in Debug state**

The general description of these instructions in *Behavior of Data-processing instructions that access the PC in Debug state* on page C5-2100 also applies to v6 Debug and v6.1 Debug, except that

- In v6 Debug, when the S bit of the instruction is set to 1, the instruction is not UNPREDICTABLE, and also updates the **CPSR**.
- In v6 Debug, and in v6.1 Debug when the S bit of the instruction is set to 0, [Table C5-2 on page C5-2101](#) does not apply, and the instruction sets the restart address and behaves as shown in [Table M-2](#):

**Table M-2 Debug state rules for data-processing instructions that write to the PC, ARMv6**

<b>CPSR.{J, T}</b> <sup>a</sup>	<b>Instruction set state</b>	<b>result&lt;1:0&gt;</b>	<b>Operation<sup>b</sup></b>
00	ARM	xx	BranchTo(result<31:2>:'00')
01	Thumb	xx	BranchTo(result<31:1>:'0')
10	Jazelle	xx	BranchTo(result<31:0>)

- a. In ARMv6, a **CPSR**.{J, T} value of 0b11 is reserved.  
b. Pseudocode description of behavior.

**Behavior of coprocessor instructions in Debug state**

In general, the information in *Behavior of coprocessor and Advanced SIMD instructions in Debug state* on page C5-2102 also applies to v6 Debug and v6.1 Debug, except that:

- In v6 Debug, for coprocessor instructions for CP0 to CP13, it is IMPLEMENTATION DEFINED whether the privileges and access controls for the instructions are those for the current mode, or those for a PL1 mode.
- A v6.1 Debug implementation that includes the Security Extensions must include support for SUHD, and therefore the additional information in *Coprocessor instructions for CP14 and CP15 when SUHD is supported* on page AppxN-2583 applies.

———— **Note** ————

ARMv7 introduces the Advanced SIMD instructions, and therefore references to these instructions are not relevant to v6 Debug and v6.1 Debug.



### M.5.3 Exceptions in Debug state

This subsection describes how exception handling in v6 Debug and v6.1 Debug differs from the description in [Exceptions in Debug state on page C5-2105](#):

- v6.1 Debug differs only slightly, regarding when asynchronous aborts are recognized.
- v6 Debug differs more significantly.

In v6.1 Debug, the only difference from v7 Debug is:

#### Asynchronous abort

When an asynchronous abort is signaled in Debug state, if DBGDSCR.ADAdiscard is 0, DBGDSCR.ADABORT\_1 is set to 1.

All other aspects of the behavior of asynchronous aborts is the same as in v7 Debug.

In v6 Debug, the following exceptions behave differently to the descriptions in [Exceptions in Debug state on page C5-2105](#):

#### Undefined Instruction

In Debug state, Undefined Instruction exceptions are generated for the same reasons as in Non-debug state.

See [Undefined Instruction and Data Abort exceptions in Debug state in v6 Debug](#).

#### Synchronous Data Abort

In Debug state, a synchronous abort on a data access generates a Data Abort exception.

See [Undefined Instruction and Data Abort exceptions in Debug state in v6 Debug](#).

#### Asynchronous abort

When an asynchronous abort is signaled in Debug state, then:

- if the CPSR.A bit is 0, a Data Abort exception is generated, see [Undefined Instruction and Data Abort exceptions in Debug state in v6 Debug](#)
- if the CPSR.A bit is 1, the abort is generated when the CPSR.A bit is cleared to 0.

### Undefined Instruction and Data Abort exceptions in Debug state in v6 Debug

In v6 Debug, if an Undefined Instruction exception is generated when the processor is in Jazelle state and Debug state, the result is UNPREDICTABLE.

Otherwise, in v6 Debug, Undefined Instruction and Data Abort exceptions generated in Debug state are taken by the processor as follows:

- The PC, CPSR, and SPSR\_<mode> are set in the same way as in a normal Non-debug state exception entry. In addition:
  - If the exception is an asynchronous abort that occurred during an exception entry, the PC holds the address of the exception vector. LR\_abt is set to (preferred return address + 8), as it is for exception entry in Non-debug state.
  - In all other cases, LR\_<mode> is set to an UNKNOWN value.
- The processor remains in Debug state.

In addition, for a Data Abort exception:

- The DFSR and DFAR are set in the same way as in a normal Non-debug state exception entry. The DBGWFAR is set to an UNKNOWN value. The IFSR is not modified.
- The DBGDSCR.MOE bits are set to 0b0110, D-side abort occurred.
- If the exception is a synchronous Data Abort exception, DBGDSCR.SDABORT\_1 is set to 1.
- If the exception is due to an asynchronous abort, DBGDSCR.ADABORT\_1 is set to 1.

For more information about asynchronous aborts in ARMv6 see [Asynchronous aborts and Debug state](#).

Debuggers must take care when processing a debug event that occurred when the processor was executing an exception handler. The debugger must save the values of SPSR\_und and LR\_und before performing any operation that might result in an Undefined Instruction exception being generated in Debug state. The debugger must also save the values of SPSR\_abt and LR\_abt, and of the DFSR, DFAR and DBGWFER before performing an operation that might generate a Data Abort exception when in Debug state. If this is not done, register values might be overwritten, resulting in UNPREDICTABLE software behavior.

#### M.5.4 Memory system behavior in Debug state

v6.1 Debug recommends implementing the DBGDSCCR and DBGDSMCR, that can disable cache evictions and linefills, and TLB evictions and replacements, as described in [Memory system behavior in Debug state on page C5-2109](#). v6 Debug does not define mechanisms for disabling these operations.

———— **Note** —————

- When DBGDSCCR and DBGDSMCR are implemented, there can be IMPLEMENTATION DEFINED limits on their behavior.
- A processor can execute all valid CP15 instructions in any state and mode if it implements v6 Debug.

#### M.5.5 Exiting Debug state

The general description of exiting Debug state in [Exiting Debug state on page C5-2110](#) also applies to v6 Debug and v6.1 Debug. However these versions of the Debug architecture do not include the DBGDRCR and therefore:

- they cannot use the DBGDRCR to issue a restart request commands
- they do not have the requirement to set bits of the DBGDSCR correctly before exiting Debug state.

In v6 Debug and v6.1 Debug, if the implementation includes the recommended ARM Debug Interface v4, a debugger issues the restart request command through the JTAG interface, by placing the RESTART instruction in the IR and taking the Debug TAP State Machine through the Run-Test/Idle state. Connecting multiple JTAG interfaces in series enables multiple processors to be restarted synchronously.

#### M.5.6 Asynchronous aborts and Debug state

On entering Debug state, the behavior of asynchronous aborts differs from the description in [Asynchronous aborts and Debug state entry on page C5-2094](#), and depends on the Debug architecture version:

- v6 Debug**      DBGDSCR.ADAdiscard bit is not defined. A debugger must always perform a *Data Synchronization Barrier* (DSB) following entry to Debug state.
- If the CPSR.A bit is 0 and an asynchronous abort is signaled, the processor takes a Data Abort exception as described in [Undefined Instruction and Data Abort exceptions in Debug state in v6 Debug on page AppxM-2557](#). A subsequent read of the processor state by the debugger returns the updated values of CPSR, LR\_abt and SPSR\_abt, and the preferred return address is the Data Abort vector address.
- The value of DBGDSCR.ADABORT\_1 is UNKNOWN when in Non-debug state.
- v6.1 Debug**    A debugger must always perform a DSB following entry to Debug state. This DSB causes DBGDSCR.ADAdiscard to be set to 1.
- DBGDSCR.ADABORT\_1 is set to 1 on any asynchronous abort detected while the processor is in Debug state, regardless of the setting of DBGDSCR.ADAdiscard.

## M.6 Debug register interfaces, v6 Debug and v6.1 Debug

The general description of the debug register interfaces in [About the debug register interfaces on page C6-2114](#) also applies to v6 Debug and v6.1 Debug. However:

- The v6 Debug and v6.1 Debug architectures:
  - define only a CP14 interface to the debug registers
  - require an IMPLEMENTATION DEFINED external interface to the debug registers.
- The *ARM Debug Interface v5 Architecture Specification*, referred to in [External debug interface to the debug registers on page C6-2114](#) describes only the recommended external debug interface for an ARMv7 Debug implementation. Contact ARM for the external debug interface recommendations for an ARMv6 implementation.

The following sections show how the v6 Debug and v6.1 Debug register interfaces differ from the descriptions for v7 Debug given in [Chapter C6 Debug Register Interfaces](#).

### M.6.1 v6 Debug and v6.1 Debug register visibility

[Table M-3](#) shows the visibility of debug registers in the CP14 interface in v6 Debug and v6.1 Debug, and summarizes the registers that are implemented by a v6 Debug or v6.1 Debug implementation. If a register is not defined in a particular Debug architecture version, the corresponding register number is reserved in that architecture version.

**Table M-3 v6 Debug and v6.1 Debug CP14 register visibility**

Register number	Name	Description	Access	v6 Debug	v6.1 Debug
0	<a href="#">DBGDIDR</a>	Debug ID <sup>a</sup>	RO	Yes	Yes
1	<a href="#">DBGDSCRint</a>	Debug Status and Control, ARMv6	RW	Yes	Yes
2-4	-	Reserved	-	-	-
5	<a href="#">DBGDTRRXint</a>	Host to Target Data Transfer <sup>a</sup>	RO	Yes	Yes
	<a href="#">DBGDTRTXint</a>	Target to Host Data Transfer <sup>a</sup>	WO	Yes	Yes
6	<a href="#">DBGWFAR</a>	Watchpoint Fault Address <sup>a</sup>	RW	-	Yes
7	<a href="#">DBGVCR</a>	Vector Catch <sup>a</sup>	RW	Yes	Yes
8-9	-	Reserved	-	-	-
10	<a href="#">DBGDSCCR</a>	Debug State Cache Control <sup>a</sup>	RW	-	Optional
11	<a href="#">DBGDSMCR</a>	Debug State MMU Control <sup>a</sup>	RW	-	Optional
12-63	-	Reserved	-	-	-
64-79	<a href="#">DBGBVR</a>	Breakpoint Value <sup>a</sup>	RW	Yes	Yes
80-95	<a href="#">DBGBCR</a>	Breakpoint Control <sup>a</sup>	RW	Yes	Yes
96-111	<a href="#">DBGWVR</a>	Watchpoint Value <sup>a</sup>	RW	Yes	Yes
112-127	<a href="#">DBGWCR</a>	Watchpoint Control <sup>a</sup>	RW	Yes	Yes

a. These registers are essentially the same as in a v7 Debug implementation, as described in [Chapter C11 The Debug Registers](#). For more information, see [Register descriptions for v6 Debug and v6.1 Debug on page AppxM-2567](#).

———— **Note** ————

In v6 Debug and v6.1 Debug, [DBGDSCRint](#) is a RW register.

### ARMv6 debug features not defined by the Debug architecture

The v7 Debug architecture defines some debug features that are, or might be, implemented elsewhere in v6 Debug and v6.1 Debug. The following sections summarize those features, and reference the v7 Debug descriptions of those features:

- [Features that must be provided by the external debug interface](#)
- [Features that might be provided by the external debug interface.](#)

ARMv6 implementations of these features can differ from the v7 Debug descriptions.

See also [DBGWFAR](#), [Watchpoint Fault Address Register](#) on page [AppxM-2575](#).

### Features that must be provided by the external debug interface

[Table M-4](#) shows the features that an ARMv6 external debug interface must include, and where the equivalent v7 Debug features are described:

**Table M-4 Required features of an ARMv6 external debug interface**

Feature	v7 Debug description of equivalent feature
<a href="#">DBGDTRRX<sub>ext</sub></a>	<a href="#">DBGDTRRX</a> , <a href="#">Host to Target Data Transfer register</a> on page <a href="#">C11-2259</a>
<a href="#">DBGDSCR<sub>ext</sub></a>	<a href="#">DBGDSCR</a> , <a href="#">Debug Status and Control Register</a> on page <a href="#">C11-2241</a>
<a href="#">DBGDTRTX<sub>ext</sub></a>	<a href="#">DBGDTRTX</a> , <a href="#">Target to Host Data Transfer register</a> on page <a href="#">C11-2260</a>
<a href="#">DBGITR</a>	<a href="#">DBGITR</a> , <a href="#">Instruction Transfer Register</a> on page <a href="#">C11-2263</a>

### Features that might be provided by the external debug interface

[Table M-5](#) shows possible additional features of an ARMv6 external debug interface, and where the equivalent v7 Debug features are described:

**Table M-5 Possible additional features of an ARMv6 external debug interface**

Feature	v7 Debug description of equivalent feature
<a href="#">DBGPCSR</a>	<a href="#">DBGPCSR</a> , <a href="#">Program Counter Sampling Register</a> on page <a href="#">C11-2271</a>
<a href="#">DBGCIDSR</a>	<a href="#">DBGCIDSR</a> , <a href="#">Context ID Sampling Register</a> on page <a href="#">C11-2221</a>

## M.6.2 v6 Debug and v6.1 Debug register accesses in the CP14 interface

This section summarizes the behavior of register accesses in the CP14 interface in v6 Debug and v6.1 Debug. For more information about the CP14 debug register interface see [The CP14 debug register interface](#) on page [C6-2121](#).

In v6 Debug and v6.1 Debug, the behavior of accesses to registers visible in the CP14 interface is affected by:

- privilege level
- whether the processor is in Debug state
- [DBGDSCR.UDCCdis](#), User mode access to DCC disable bit
- [DBGDSCR.MDBGen](#), Monitor debug-mode enable bit
- [DBGDSCR.HDBGen](#), Halting debug-mode enable bit.

[Table M-6](#) shows the default access to the registers visible in the CP14 interface. This is the access when either:

- the processor is in Debug state

- the processor is in Non-debug state, and the privilege level is PL1.

The following column headings in [Table M-6](#) show the settings that change behavior of accesses to the CP14 interface from the default access:

- PL0** When the processor is in Non-debug state and the privilege level is PL0, access to certain registers becomes UNDEFINED.
- UDCC** When the processor is in Non-debug state, the privilege level is PL0, and the User mode access to DCC disable bit, [DBGDSCR.UDCCdis](#), is set to 1, access to certain registers becomes UNDEFINED.
- MDBGGen** When the processor is in Non-debug state, and the Monitor debug-mode enable bit, [DBGDSCR.MDBGGen](#), is set to 0, access to some registers becomes UNDEFINED.
- HDBGGen** When the processor is in Non-debug state, and the Halting debug-mode enable bit, [DBGDSCR.HDBGGen](#), is set to 1, access to some registers becomes UNDEFINED.

In the table:

- UND indicates that the access is UNDEFINED. This takes precedence over the effect of any other control.
- indicates that the control has no effect on the behavior of the access.

**Table M-6 v6 Debug and v6.1 Debug CP14 interface access behavior**

Register number	Name	Description	Default access	PL0	UDCC	MDBGGen	HDBGGen
0	<a href="#">DBGDIDR</a>	Debug ID	RO	-	UND	-	-
1	<a href="#">DBGDSCR</a> int	Debug Status and Control	RW	RO	UND	-	-
5	<a href="#">DBGDTRRX</a> int	Host to Target Data Transfer	RO	-	UND	-	-
	<a href="#">DBGDTRTX</a> int	Target to Host Data Transfer	WO	-	UND	-	-
6	<a href="#">DBGWFAR</a>	Watchpoint Fault Address	RW	UND	UND	UND	UND
7	<a href="#">DBGVCR</a>	Vector Catch	RW	UND	UND	UND	UND
10	<a href="#">DBGDSCCR</a>	Debug State Cache Control	RW	UND	UND	UND	UND
11	<a href="#">DBGDSMCR</a>	Debug State MMU Control	RW	UND	UND	UND	UND
64-79	<a href="#">DBGBVR</a>	Breakpoint Value	RW	UND	UND	UND	UND
80-95	<a href="#">DBGBCR</a>	Breakpoint Control	RW	UND	UND	UND	UND
96-111	<a href="#">DBGWVR</a>	Watchpoint Value	RW	UND	UND	UND	UND
112-127	<a href="#">DBGWCR</a>	Watchpoint Control	RW	UND	UND	UND	UND

### Accesses to reserved registers

Any instruction that accesses a register that is only available from v7 Debug is UNDEFINED in earlier versions of the Debug architecture. For example, the read from [DBGDRAR](#) performed by MRC p14, 0, <Rt>, c1, c0, 0, shown in [Table C6-1 on page C6-2122](#), is UNDEFINED in v6 Debug and v6.1 Debug. In v6 Debug and v6.1 Debug, no debug registers map to CP14 instructions with <CRn> set to a value other than 0b0000. All instruction encodings with <CRn> != 0b0000 and <opc1> == 0 are UNDEFINED in User mode and UNPREDICTABLE from PL1. All reserved encodings with <CRn> == 0b0000 are UNDEFINED in all modes.

## M.7 Reset and powerdown support

———— **Note** —————

From issue C.a, this information is moved from [Chapter C6 Debug Register Interfaces](#) into a new chapter, [Chapter C7 Debug Reset and Powerdown Support](#).

Much of this chapter describes features introduced in v7 Debug and therefore does not apply to a v6 Debug or v6.1 Debug implementation. In particular:

- v6 Debug and v6.1 Debug support only a single power domain, and therefore the section [Power domains and debug on page C7-2149](#) does not apply to these debug architectures
- v7 Debug introduced the OS Save and Restore mechanism, and therefore the section [The OS Save and Restore mechanism on page C7-2152](#) does not apply to v6 Debug and v6.1 Debug.
- The reset scheme described in [The OS Save and Restore mechanism on page C7-2152](#) was introduced in v7 Debug, but might be applicable to a v6 Debug or v6.1 Debug implementation. However, since these Debug architectures do not support multiple power domains they can use a less flexible reset scheme, comprising only system powerup reset and warm reset signals. In such a scheme the debug logic is reset only on asserting the system powerup reset, and has no independent reset signal.

## M.8 The Debug Communications Channel and Instruction Transfer Register

———— **Note** —————

This chapter is added in issue C.a, and brings together information that was split between a number of sections of the manual:

- This section does not describe v6 Debug and v6.1 Debug differences in [About the DCC and DBGITR on page C8-2164](#), that introduces the v7 Debug implementation.
- This section describes the v6 Debug and v6.1 Debug differences in the remainder of [Chapter C8 The Debug Communications Channel and Instruction Transfer Register](#), that give the full description of these debug features.
- Previous descriptions of the DCC use the term DTR (*Data Transfer Register*) to describe the DCC data registers. In those descriptions, the DBGDTRTX Register is named wDTR, and the DBGDTRRX Register is named rDTR.

---

The behavior of the DCC and [DBGITR](#) is a combination of:

- The behavior of [DBGDSCRint](#), [DBGDTRRXint](#) and [DBGDTRTXint](#) that is visible in the programmers' model. This is unchanged by ARMv7.
- The view of [DBGDSCRext](#), [DBGDTRRXext](#), [DBGDTRTXext](#), [DBGITR](#) and the [DBGDSCR.ExtDCCmode](#) controls from an external debugger. These are first defined by ARMv7. In v6 Debug and v6.1 Debug, these operations are part of the IMPLEMENTATION DEFINED external debug interface.

## M.9 Non-invasive debug authentication, v6 Debug and v6.1 Debug

The general description of non-invasive debug authentication in [Chapter C9 Non-invasive Debug Authentication](#) also applies to v6 Debug and v6.1 Debug, except that:

- The Security Extensions cannot be implemented with v6 Debug.
- In v6 Debug, non-invasive debug authentication can be changed only while the processor is in reset.
- **NIDEN** is an optional signal in v6 Debug and v6.1 Debug. **NIDEN** might be implemented on some non-invasive debug components and not on others. For example, the performance monitoring unit for a processor might implement **NIDEN** when the trace macrocell for the same processor does not.

The section [Non-invasive debug authentication on page C9-2183](#) does not apply to v6 Debug and v6.1 Debug. Instead, see [ARMv6 non-invasive debug authentication](#).

### M.9.1 ARMv6 non-invasive debug authentication

An ARMv6 processor might implement the v7 Debug non-invasive debug authentication signaling described in [Non-invasive debug authentication on page C9-2183](#).

In general, non-invasive debug authentication in ARMv6 Debug is IMPLEMENTATION DEFINED. For details of the implemented authentication scheme you must see the appropriate product documentation. In particular:

- it is IMPLEMENTATION DEFINED whether the **NIDEN** signal is implemented
- the exact roles of the following signals are IMPLEMENTATION DEFINED:
  - **DBGEN**, **SPIDEN**, and **SPNIDEN**
  - **NIDEN**, if it is implemented.

However, an ARMv6 non-invasive debug authentication scheme must obey the following rules:

- If **NIDEN** is implemented then tying **NIDEN** and **DBGEN** both LOW guarantees that non-invasive debug is disabled.
- if **NIDEN** is not implemented then the mechanism for disabling non-invasive debug is IMPLEMENTATION DEFINED. An implementation might not support any mechanism for disabling non-invasive debug.
- in an implementation that includes the Security Extensions, tying **SPIDEN** and **SPNIDEN** both LOW guarantees that non-invasive debug is not permitted in Secure PL1 modes.

In addition, if **SPIDEN** and **SPNIDEN** are both LOW then setting **SDER.SUNIDEN** to 0 guarantees that non-invasive debug is not permitted in Secure User mode.

If non-invasive debug is enabled then if **SDER.SUNIDEN** is 1, non-invasive debug is permitted in Secure User mode.

- If **NIDEN** is implemented then tying **NIDEN** and **SPNIDEN** both HIGH is guaranteed to enable and permit non-invasive debug in all modes in both security states.

If **NIDEN** is not implemented then tying **SPNIDEN** HIGH is guaranteed to enable and permit non-invasive debug in all modes in both security states.

[Table M-7](#) shows the architectural requirements for non-invasive debug behavior in an ARMv6 Debug implementation that does not include the Security Extensions.

**Table M-7 ARMv6 non-invasive debug authentication requirements, Security Extensions not implemented**

<b>NIDEN</b>	<b>DBGEN</b>	<b>Non-invasive debug behavior</b>
Implemented and LOW	LOW	Disabled.
Implemented and HIGH	x	Enabled.



Table M-8 shows the architectural requirements for non-invasive debug behavior in an ARMv6 Debug implementation that includes the Security Extensions.

**Table M-8 ARMv6 non-invasive debug authentication requirements, Security Extensions implemented**

NIDEN	Signals			SDER. SUNIDEN	Non-invasive debug behavior
	DBGEN	SPIDEN	SPNIDEN		
Implemented and LOW	LOW	x	x	x	Disabled.
x	x	LOW	LOW	0	Not permitted in any mode in Secure state.
x	x	LOW	LOW	1	Not permitted in Secure PL1 modes. Permitted in Secure User mode if enabled.
Implemented and HIGH	x	x	x	x	Permitted in all modes in Non-secure state. Might also be permitted in Secure state.
Implemented and HIGH	x	x	HIGH	x	Permitted in all modes and security states.
Not implemented	x	x	HIGH	x	Permitted in all modes and security states.

An ARMv6 Debug implementation that includes the Security Extensions might have other signal combinations that permit non-invasive debug in Secure PL1 modes. Debug users must take care to avoid unknowingly permitting non-invasive debug.

There is no mechanism that a debugger can use to determine the implemented mechanism for controlling non-invasive debug on an ARMv6 processor. You must see the product documentation for this information.

## M.10 Sample-based profiling, v6 Debug and v6.1 Debug

In ARMv6, the *Program Counter Sampling Register* (DBGPCSR) is an optional part of the recommended external debug interface. It is not defined by the architecture. In general, [Chapter C10 Sample-based Profiling](#) does not apply to v6 Debug and v6.1 Debug implementations.

## M.11 The debug registers, v6 Debug and v6.1 Debug

v7 Debug introduced many changes to the debug registers. This section of this appendix describes how the v6 Debug and v6.1 Debug debug register implementations differ from the descriptions in [Chapter C11 The Debug Registers](#).

In general, the description of the v7 Debug registers in [About the debug registers on page C11-2192](#), and its subsections, applies to v6 Debug and v6.1 Debug, except that:

- Register locations in an ARMv6 external debug interface might differ from the offset values given in [Chapter C11 The Debug Registers](#).
- The *ARM Debug Interface v5 Architecture Specification* description of the recommended external debug interface applies only from v7 Debug. Contact ARM for details of the ARMv6 recommended external debug interface.
- The Security Extensions cannot be implemented with v6 Debug.

[Debug register summary, v6 Debug and v6.1 Debug](#) summarizes the debug register differences in a v6 Debug or v6.1 Debug implementation.

### M.11.1 Debug register summary, v6 Debug and v6.1 Debug

The general information about debug registers in [Debug register summary on page C11-2193](#) also applies to v6 Debug and v6.1 Debug. However, the register summary tables in that section do not apply. Instead, [Table M-3 on page AppxM-2559](#) lists the debug registers for v6 Debug and v6.1 Debug.

If a register is not defined in a particular Debug architecture version, the corresponding register number is reserved in that architecture version.

———— **Note** —————

v6 Debug and v6.1 Debug have no support for CP14 debug register numbers higher than 127. Therefore they cannot support IMPLEMENTATION DEFINED extensions to the set of CP14 debug registers.

### Register descriptions for v6 Debug and v6.1 Debug

Each register in a v6 Debug or v6.1 Debug implementation is in one of the following groups:

- The v6 Debug or v6.1 Debug implementation is identical to the v7 Debug implementation. [Register descriptions, in register order on page C11-2209](#) describes the register.
- The v6 Debug or v6.1 Debug implementation is similar to the v7 Debug implementation. [Register descriptions, in register order on page C11-2209](#) describes the register, and a section in this appendix describes the v6 Debug or v6.1 Debug differences.
- The register is ARMv6 only. A section in this appendix describes the register.

[Table M-9 on page AppxM-2568](#) shows how the v6 Debug and v6.1 Debug registers are described.

**Table M-9 v6 Debug and v6.1 Debug register descriptions**

Register		Description	Appendix M description
Number	Name <sup>a</sup>		
0	<a href="#">DBGDIDR</a>	Debug ID	Differences, see <a href="#">DBGDIDR, Debug ID Register</a> on page AppxM-2569
1	<a href="#">DBGDSCRint</a>	Debug Status and Control	Full, see <a href="#">DBGDSCR, Debug Status and Control Register, ARMv6</a> on page AppxM-2570
5	<a href="#">DBGDTRRXint</a>	Host to Target Data Transfer	Differences, see <a href="#">DBGDTRRX, Host to Target Data Transfer Register</a> on page AppxM-2574
	<a href="#">DBGDTRTXint</a>	Target to Host Data Transfer	Differences, see <a href="#">DBGDTRTX, Target to Host Data Transfer Register</a> on page AppxM-2574
6	<a href="#">DBGWFAR</a>	Watchpoint Fault Address	Differences, see <a href="#">DBGWFAR, Watchpoint Fault Address Register</a> on page AppxM-2575
7	<a href="#">DBGVCR</a>	Vector Catch	Differences, see <a href="#">DBGVCR, Vector Catch Register</a> on page AppxM-2575
10	<a href="#">DBGDSCCR</a>	Debug State Cache Control	Differences, see <a href="#">DBGDSCCR, Debug State Cache Control Register</a> on page AppxM-2575
11	<a href="#">DBGDSMCR</a>	Debug State MMU Control	Differences, see <a href="#">DBGDSMCR, Debug State MMU Control Register</a> on page AppxM-2577
64-79	<a href="#">DBGBVR</a>	Breakpoint Value	None
80-95	<a href="#">DBGBCR</a>	Breakpoint Control	Differences, see <a href="#">DBGBCR, Breakpoint Control Registers</a> on page AppxM-2577
96-111	<a href="#">DBGWVR</a>	Watchpoint Value	None
112-127	<a href="#">DBGWCR</a>	Watchpoint Control	Differences, see <a href="#">DBGWCR, Watchpoint Control Registers</a> on page AppxM-2577

a. For [DBGDSCRint](#), the name links to the register description in this appendix. For all other registers, the name links to the register description in [Chapter C11 The Debug Registers](#).

## M.11.2 DBGDIDR, Debug ID Register

A v6 Debug or v6.1 Debug implementation of the **DBGDIDR** is similar to the ARMv7 implementation, except that:

- The following fields have fixed values that are consistent with the field definitions in the v7 Debug description:
  - DEVID\_imp, bit[15]**  
RAZ in v6 Debug and v6.1 Debug. **DBGDEVID** is not implemented.
  - nSUHD\_imp, bit[14]**  
RAZ in v6 Debug and v6.1 Debug:
    - The Security Extensions cannot be implemented with v6 Debug and therefore this bit and the **SE\_imp** bit are both zero
    - a v6.1 Debug implementation on a processor that implements the Security Extensions must support Secure User halting debug and therefore must have the **SE\_imp** bit set to 1 and the **nSUHD\_imp** bit set to 0,
  - PCSR\_imp, bit[13]**  
RAZ in v6 Debug and v6.1 Debug. In ARMv6, the Program Counter Sampling Register is an IMPLEMENTATION DEFINED feature of the external debug interface and is not indicated in the **DBGDIDR**.
  - SE\_imp, bit[12]**  
RAZ in v6 Debug. The Security Extensions cannot be implemented with v6 Debug.
- In the Version field, bits[19:16], values 0b0011 and higher are reserved and this field reads as:
  - 0b0001 in a v6 Debug implementation
  - 0b0010 in a v6.1 Debug implementation.

All other fields are implemented as described for v7 Debug.

### M.11.3 DBGDSCR, Debug Status and Control Register, ARMv6

———— **Note** ————

For the ARMv7 description of the register, see [DBGDSCR, Debug Status and Control Register on page C11-2241](#).

The DBGDSCR characteristics are:

- Purpose** The main control register for the debug implementation.
- Usage constraints** The debug implementation provides internal and external views of the DBGDSCR:
- the CP14 interface gives access to the internal view of the register
  - the register must be visible in the IMPLEMENTATION DEFINED external debug interface.

———— **Note** ————

v7 Debug refers to these views as DBGDSCRint and DBGDSCRext. These terms were not used in v6 Debug and v6.1 Debug.

[Table M-10 on page AppxM-2573](#) shows the access attributes for each field of the register in these different views.

- Configurations** This register has the following differences in different versions of the Debug architecture:
- v6.1 Debug defines additional bits in the register, see [Table M-10 on page AppxM-2573](#)
  - v6 Debug defines additional permitted values for the MOE field, see [Table M-11 on page AppxM-2574](#).

In a VMSA implementation that includes the Security Extensions, this is a Common register.

For the v7 Debug definition of this register see [DBGDSCR, Debug Status and Control Register on page C11-2241](#).

- Attributes** See the registers summary in [Table M-3 on page AppxM-2559](#), the register bit descriptions, and [Table M-10 on page AppxM-2573](#).

In v6.1 Debug, the DBGDSCR bit assignments are:

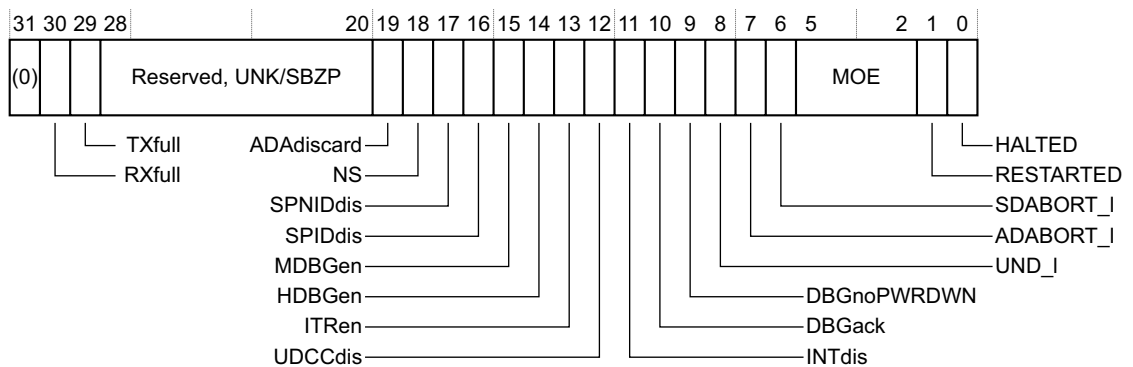

In v6 Debug, the DBGDSCR bit assignments are:

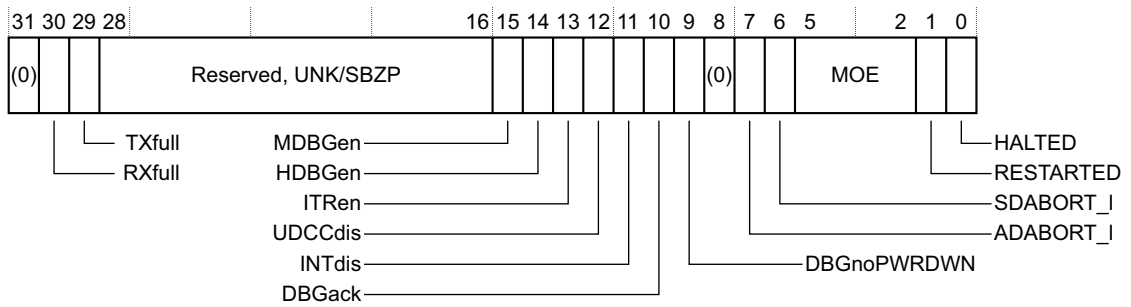

**Bit[31]** Reserved, UNK/SBZP.

**RXfull, bit[30]** As for v7 Debug.

**TXfull, bit[29]** As for v7 Debug.

**Bits[28:20]** Reserved, UNK/SBZP.

**ADAdiscard, bit[19], v6.1 Debug**

As for v7 Debug, but see the information about asynchronous aborts in *Exceptions in Debug state* on page AppxM-2557.

**NS, bit[18], v6.1 Debug**

As for v7 Debug.

**SPNIDdis, bit[17], v6.1 Debug**

As for v7 Debug.

**SPIDdis, bit[16], v6.1 Debug**

As for v7 Debug.

**Bits[19:16], v6 Debug**

Reserved, UNK/SBZP.

**MDBGGen, bit[15]** As for v7 Debug.

**HDBGGen, bit[14]** As for v7 Debug. v6 Debug and v6.1 Debug do not support the OS Save and Restore mechanism and therefore the Note about the saved value of this bit is not relevant to v6 Debug and v6.1 Debug implementations.

**ITRen, bit[13]** As for v7 Debug. However, in an ARMv6 implementation, if the external debug interface does not have a mechanism for forcing the processor to execute instructions in Debug state via the external debug interface, this bit is RAZ/WI.

**UDCCdis, bit[12]** As for v7 Debug.

**INTdis, bit[11]** As for v7 Debug.

**DBGack, bit[10]** As for v7 Debug.

**DBGnoPWRDWN, bit[9]**

**Note**

- The v6 and v6.1 Debug architectures do not define this bit, but many v6 Debug and v6.1 Debug implementations define DBGDSCR[9] as the DBGnoPWRDWN bit. If this bit is not implemented, DBGDSCR[9] is RAZ/WI.
- From issue C.a of this manual, this bit is renamed as CORENPDRQ. This renaming has no effect on the function of the bit.

No powerdown bit. This bit requests emulation of powerdown. The possible values of this bit are:

- 0** On a powerdown request, the system powers-down.
- 1** On a powerdown request, the system emulates powerdown.

Emulation of powerdown is an IMPLEMENTATION DEFINED feature. If it is implemented, setting this bit to 1 requests the power controller to work in an emulation mode when it receives a powerdown request. In this emulation mode the processor is not actually powered down. For more information, see [DBGNOPWRDWN on page AppxA-2346](#).

#### UND\_1, bit[8], v6.1 Debug

As for v7 Debug.

**Bit[8], v6 Debug** Reserved, UNK/SBZP.

**ADABORT\_1, bit[7]** Sticky Asynchronous Abort bit. This bit is set to 1 by any asynchronous abort that occurs when the processor is in Debug state. The possible values of this bit are:

- 0** No asynchronous abort has occurred since the last time this bit was cleared to 0
- 1** An asynchronous abort has occurred since the last time this bit was cleared to 0.

This bit is cleared to 0 when the external debugger reads the DBGDSCR.

Some aspects of the behavior of this bit depend on the version of the Debug architecture:

##### v6.1 Debug

If the processor is in Non-debug state this bit is not set to 1 on an asynchronous abort.

**v6 Debug** The value of this bit is UNKNOWN when either the processor is in Non-debug state, or the ITRen bit, bit[13], is not set to 1.

For more information, see [Asynchronous aborts and Debug state on page AppxM-2558](#) and [Exceptions in Debug state on page AppxM-2557](#).

**SDABORT\_1, bit[6]** Sticky Synchronous Data Abort bit. This bit is set to 1 by any Data Abort exception that is generated synchronously when the processor is in Debug state. The possible values of this bit are:

- 0** No synchronous Data Abort exception has been generated since the last time this bit was cleared to 0
- 1** A synchronous Data Abort exception has been generated since the last time this bit was cleared to 0.

If the external debug interface includes an ITR, its behavior might depend on the value of the SDABORT\_1 bit. See [Features that might be provided by the external debug interface on page AppxM-2560](#) for more information about the ITR.

This bit is cleared to 0 when the external debugger reads the DBGDSCR.

Some aspects of the behavior of this bit depend on the version of the Debug architecture:

##### v6.1 Debug

If the processor is in Non-debug state this bit is not set to 1 on a synchronous Data Abort exception.

**v6 Debug** If the processor is in Non-debug state, the value of this bit is UNKNOWN.

For more information, see [Exceptions in Debug state on page AppxM-2557](#).

**MOE, bits[5:2]** Method of Debug Entry field. The meaning of this field is generally the same as in v7 Debug, but v6 Debug permits two additional field values. For more information see [Method of Debug entry on page AppxM-2574](#).

**RESTARTED, bit[1]** As for v7 Debug.

**HALTED, bit[0]** As for v7 Debug.



Table M-10 shows the access to each field of the DBGDSCR, and the reset value of each field. It also shows the Debug architecture versions in which each field is defined.

**Table M-10 DBGDSCR bit access and reset values**

Bits	Field name	Version	Access		Debug reset value <sup>a</sup>
			CP14 view	External view	
[31]	-	-	UNK/SBZP		-
[30]	RXfull	Both	Read-only		0
[29]	TXfull	Both	Read-only		0
[28:20]	-	-	UNK/SBZP		-
[19]	ADAdiscard	v6.1 Debug	Read-only or Read/write <sup>b</sup>		0
[18]	NS	v6.1 Debug	Read-only		d
[17]	SPNIDdis	v6.1 Debug	Read-only		d
[16]	SPIDdis	v6.1 Debug	Read-only		d
[15]	MDBGGen	Both	Read/Write	Read-only	0
[14]	HDBGGen	Both	Read-only	Read/Write	0
[13]	ITRen	Both	Read-only	Read/Write	0
[12]	UDCCdis	Both	Read/Write	Read-only	0
[11]	INTdis	Both	Read-only	Read/Write	0
[10]	DBGack	Both	Read-only	Read/Write	0
[9]	DBGnoPWRDWN	Both	Read-only	Read/Write	0
[8]	UND_1	v6.1 Debug	Read-only <sup>c</sup>		0
[7]	ADABORT_1	Both	Read-only <sup>c</sup>		0
[6]	SDABORT_1	Both	Read-only <sup>c</sup>		0
[5:2]	MOE	Both	Read/Write	Read-only	0
[1]	RESTARTED	Both	Read-only		d
[0]	HALTED	Both	Read-only		d

a. The value after a debug logic reset.

b. The ADAdiscard bit can be read/write. This is IMPLEMENTATION DEFINED, see [Asynchronous aborts and Debug state entry on page C5-2094](#).

c. For details of how these bits are cleared to 0 see the descriptions of the bits.

d. These are read-only status bits that reflect the current state of the processor.

## Method of Debug entry

The Method of Debug Entry is indicated by the DBGDSCR.MOE field. Table M-11 shows the meanings of the possible values of the DBGDSCR.MOE field.

Table M-11 Meaning of Method of Debug Entry values

MOE bits	Version	Debug entry caused by:
0000	Both	Halt request debug event
0001	Both	Breakpoint debug event
0010	Both	Asynchronous watchpoint debug event
0011	Both	BKPT instruction debug event
0100	Both	External debug request debug event
0101	Both	Vector catch debug event
0110	v6 only	Data-side abort, reserved in v6.1 Debug
0111	v6 only	Instruction-side abort, reserved in v6.1 Debug
1000-1111	Both	Reserved

A Prefetch Abort or Data Abort exception handler can determine whether a debug event occurred by checking the value of the relevant Fault Status Register, [IFSR](#) or [DFSR](#). It then uses the DBGDSCR.MOE bits to determine the specific debug event.

In v6 Debug, the DBGDSCR can be checked first to determine whether an abort has occurred, and hence whether the exception handler jumps to the debug monitor or not. In v6.1 Debug the *D-side abort occurred* and *I-side abort occurred* encodings are reserved. Therefore, an exception handler must always check the [IFSR](#) or [DFSR](#) first.

When debug is disabled, and when debug events are not permitted, the BKPT instruction generates a debug exception rather than being ignored. The exception reporting registers are set as if a BKPT instruction debug exception occurred. For more information, see [Debug exception on BKPT instruction, Breakpoint, or Vector catch debug events on page C4-2088](#). For security reasons, monitor software might need to check that debug was enabled and that the debug event was permitted before communicating with an external debugger.

### M.11.4 DBGDTRRX, Host to Target Data Transfer Register

ARMv6 does not define [DBGDTRRX<sub>ext</sub>](#) or [DBGDTRTX<sub>ext</sub>](#), but the corresponding functionality must be implemented as part of the external debug interface.

———— **Note** —————

[DBGDTRRX](#) was named rDTR.

In the section [Behavior of accesses to DBGDTRRX on page C8-2172](#):

- Information about access to [DBGDTRRX<sub>int</sub>](#) also applies to access to rDTR in v6 Debug and v6.1 Debug.
- Information about access to [DBGDTRRX<sub>ext</sub>](#) does not apply to v6 Debug and v6.1 Debug. In these versions of the Debug architecture, the external debug interface defines the behavior of accesses to the equivalent functionality.

### M.11.5 DBGDTRTX, Target to Host Data Transfer Register

ARMv6 does not define [DBGDTRRX<sub>ext</sub>](#) or [DBGDTRTX<sub>ext</sub>](#), but the corresponding functionality must be implemented as part of the external debug interface.

———— **Note** —————

[DBGDTRTX](#) was named wDTR.

---

In the section *Behavior of accesses to [DBGDTRTX](#)* on page C8-2173:

- Information about access to [DBGDTRTX](#)int also applies to access to wDTR in v6 Debug and v6.1 Debug.
- Information about access to [DBGDTRTX](#)ext does not apply to v6 Debug and v6.1 Debug. In these versions of the Debug architecture, the external debug interface defines the behavior of accesses to the equivalent functionality.

### M.11.6 **DBGWFAR, Watchpoint Fault Address Register**

In v6.1 Debug, the [DBGWFAR](#) is implemented as described for v7 Debug. In v6 Debug this register is not implemented as a debug register.

———— **Note** —————

- In ARMv6 this register is also accessible as processor CP15 register, see *CP15 c6, Watchpoint Fault Address Register, [DBGWFAR](#)* on page AppxL-2531. The register implementation is always as described for v7 Debug.
  - In v6.1 Debug, ARM deprecates using the CP15 access to the [DBGWFAR](#).
- 

### M.11.7 **DBGVCR, Vector Catch Register**

In v6 Debug and v6.1 Debug, the [DBGVCR](#) is implemented as described for v7 Debug, except that, in v6.1 Debug, if the implementation includes the Security Extensions, it is optional whether [DBGVCR](#)[31, 30, 28:25, 15, 14, 12:10] are implemented. If these bits are not implemented, they are RAZ/WI.

———— **Note** —————

- In an implementation that includes the Security Extensions, ARM recommends that [DBGVCR](#)[31, 30, 28:25, 15, 14, 12:10] are implemented.
  - The Security Extensions cannot be implemented with v6 Debug.
- 

In v6 Debug and v6.1 Debug, all defined bits reset to 0.

In a v6.1 Debug implementation that includes the Security Extensions, the debug logic generates Reset Vector catch debug events only when the processor is in Secure state. It is UNPREDICTABLE whether this depends on the security state when the processor fetches the instruction, or on the security state when it commits the instruction for execution.

### M.11.8 **DBGDSCCR, Debug State Cache Control Register**

It is IMPLEMENTATION DEFINED whether a v6.1 Debug implementation includes the [DBGDSCCR](#), or the [DBGDSMCR](#), but ARM recommends implementing them, to help debuggers maintain memory coherency without costly explicit coherency operations.

Because the [DBGDSCCR](#) is IMPLEMENTATION DEFINED in v6.1 Debug, its implementation might differ from the description in *Chapter C11 The Debug Registers*. Therefore, the restrictions given in *Permitted IMPLEMENTATION DEFINED limits* on page C11-2240 are not architectural requirements for v6.1 Debug.

The [DBGDSCCR](#) is not defined in v6 Debug, but a processor that includes v6 Debug might implement equivalent functionality using an IMPLEMENTATION DEFINED register.

**Note**

- The IMPLEMENTATION DEFINED Cache Behavior Override Register, **CBOR**, can be implemented as a CP15 register on an ARMv6 processor. An implementation that includes the Security Extensions must implement the **CBOR**.
- If implemented as a CP15 register, the Debug State Cache Control Register is implemented in the IMPLEMENTATION DEFINED register space.

In a v6.1 Debug implementation of the **DBGDSCCR**, all defined bits of the register reset to 0.

**DBGDSCCR interaction with the CBOR, Cache Behavior Override Register**

A processor might implement an IMPLEMENTATION DEFINED **CBOR** in CP15.

Table M-12 shows, for a processor that implements both the **DBGDSCCR** and the **CBOR**, the relative precedence of the **CBOR** and the **DBGDSCCR** according to the state of the processor.

**Note**

Table M-12 assumes that the processor supports the features controlled by the **DBGDSCCR**. {nWT, nDL, nIL} bits. If the processor does not support a feature:

- the corresponding control bit is RO
- it is IMPLEMENTATION DEFINED whether the bit is RAZ or RAO
- the processor behaves as if the bit was set to 1.

**Table M-12 Interaction of the CP15 **CBOR** and the **DBGDSCCR****

<b>DBGDSCCR</b>			<b>CBOR</b>			<b>Debug state</b>	<b>Behavior</b>
<b>nWT</b>	<b>nDL</b>	<b>nIL</b>	<b>WT</b>	<b>DL</b>	<b>IL</b>		
1	-	-	0	-	-	x	Write-back regions <sup>a</sup> are write-back
x	-	-	0	-	-	No	Write-back regions <sup>a</sup> are write-back
x	-	-	1	-	-	x	Write-back regions <sup>a</sup> are write-through
0	-	-	x	-	-	Yes	Write-back regions <sup>a</sup> are write-through
-	1	-	-	0	-	x	Data or unified cache linefills are enabled
-	x	-	-	0	-	No	Data or unified cache linefills are enabled
-	x	-	-	1	-	x	Data or unified cache linefills are disabled
-	0	-	-	x	-	Yes	Data or unified cache linefills are disabled
-	-	1	-	-	0	x	Instruction cache linefills are enabled
-	-	x	-	-	0	No	Instruction cache linefills are enabled
-	-	x	-	-	1	x	Instruction cache linefills are disabled
-	-	0	-	-	x	Yes	Instruction cache linefills are disabled

a. Memory regions that the region attributes indicate are Write-Back Cacheable.

A processor that implements Security Extensions might implement a common **CBOR**, with **CBOR**.{WT, IL, DL} bit settings that apply to both Secure and Non-secure operation. However, it might bank **CBOR**, providing independent definition of {WT, IL, DL} for the Secure and Non-secure states. In this case, duplicate [Table M-12 on page AppxM-2576](#):

- once for Non-secure operation, using the Non-secure **CBOR**.{WT, IL, DL} settings
- once for Secure operation, using the Secure **CBOR**.{WT, IL, DL} settings.

### M.11.9 **DBGDSMCR, Debug State MMU Control Register**

It is IMPLEMENTATION DEFINED whether a v6.1 Debug implementation includes the **DBGDSCCR**, or the **DBGDSMCR**, but ARM recommends implementing them, to help debuggers maintain memory coherency without costly explicit coherency operations.

Because the **DBGDSMCR** is IMPLEMENTATION DEFINED in v6.1 Debug, their implementation might differ from the descriptions in [Chapter C11 The Debug Registers](#). Therefore, the restrictions given in [Permitted IMPLEMENTATION DEFINED limits on page C11-2240](#) are not architectural requirements for v6.1 Debug.

The **DBGDSMCR** is not defined in v6 Debug, but a processor that includes v6 Debug might implement equivalent functionality using an IMPLEMENTATION DEFINED register.

———— **Note** —————

If implemented as a CP15 register, the Debug State MMU Control Register is implemented in the IMPLEMENTATION DEFINED register space.

In a v6.1 Debug implementation of the **DBGDSMCR**, all defined bits of the register reset to 0.

### M.11.10 **DBGBCR, Breakpoint Control Registers**

In v6 Debug and v6.1 Debug, the **DBGBCR** is implemented as described for v7 Debug, except that:

**Bits[28:24]** Reserved, UNK/SBZP, in v6 Debug and v6.1 Debug.

**Bit[22]** Reserved, UNK/SBZP, in v6 Debug. v6 Debug does not support linked or unlinked instruction address mismatch comparisons.

**Privileged mode control, bits[2:1]**

The value of 0b00 is reserved in v6 Debug and v6.1 Debug, and must not be used.

In v6 Debug and v6.1 Debug, **DBGBCR**[0] is set to 0 on a debug logic reset, disabling the breakpoint.

### M.11.11 **DBGWCR, Watchpoint Control Registers**

In v6 Debug and v6.1 Debug, the **DBGWCR** is implemented as described for v7 Debug, except that:

**Bits[28:24]** Reserved, UNK/SBZP, in v6 Debug and v6.1 Debug.

**Bit[12:9]** Reserved, UNK/SBZP, in v6 Debug and v6.1 These Debug architecture versions only support a 4-bit Byte address select field.

In v6 Debug and v6.1 Debug, **DBGWCR**[0] is set to 0 on a debug logic reset, disabling the watchpoint.

## M.12 Performance monitors, v6 Debug and v6.1 Debug

v7 Debug introduces the Performance Monitors Extension as an optional architecture extension. Before v7 Debug, the debug architecture did not define the performance monitors and therefore, in general, [Chapter C12 The Performance Monitors Extension](#) does not apply to v6 Debug and v6.1 Debug implementations.

# Appendix N

## Secure User Halting Debug

This chapter describes the *Secure User halting debug* (SUHD) feature of debug implementations on processors that include the Security Extensions. It contains the following sections:

- [About Secure User halting debug on page AppxN-2580](#)
- [Invasive debug authentication in an implementation that supports SUHD on page AppxN-2581](#)
- [Effects of SUHD on Debug state on page AppxN-2582.](#)

———— **Note** —————

On a processor that implements the Security Extensions, SUHD is:

- required in v6.1 Debug
- optional and deprecated in v7 Debug with a processor that implements the ARMv7 architecture without the Multiprocessing Extensions
- obsolete in v7 Debug from the introduction of the ARMv7 Multiprocessing extensions.

## N.1 About Secure User halting debug

For debug events that cause entry to Debug state, *Secure User halting debug* (SUHD) refers to permitting these events in Secure User mode when invasive debug is not permitted in Secure PL1 modes. The debug events that cause entry to Debug state are:

- Halting debug events
- if Halting debug-mode is selected, Software debug events.

In an implementation that includes the Security Extensions, the Debug architecture requirements for SUHD are:

- v6.1 Debug requires support for SUHD
- in v7 Debug it is IMPLEMENTATION DEFINED whether SUHD is supported, and ARM deprecates the implementation or use of SUHD
- v7.1 Debug obsoletes SUHD, meaning it never supports it.

On an implementation that includes the Security Extensions but does not support Secure User halting debug the [DBGDIDR.nSUHD\\_imp](#) bit is RAO.

———— **Note** —————

An ARMv6 implementation that includes the Security Extensions must implement v6.1 Debug. Therefore, SUHD cannot be implemented with v6 Debug.

---



## N.2 Invasive debug authentication in an implementation that supports SUHD

If a implementation supports Secure User halting debug, it can be configured so that both invasive halting debug and invasive nonhalting debug are permitted in Secure User mode when invasive debug is not permitted in Secure PL1 modes. Therefore, the alternatives for when a debug event is permitted are:

- in all processor modes, in both Secure and Non-secure security states
- only in Non-secure state
- in Non-secure state and also in Secure User mode.

———— **Note** ————

In an implementation that includes the Security Extensions and supports SUHD, the Debug architecture distinguishes between permitting invasive halting debug and permitting invasive nonhalting debug. However, in Non-secure state and in Secure PL1 modes whether a debug event is permitted does not depend on whether the event would cause entry to Debug state. Therefore, the distinction between permitting invasive halting debug and invasive nonhalting debug applies only in Secure User mode.

Configuration of permissions for non-invasive debug is independent of that for invasive debug, but provides the same alternatives.

### N.2.1 Effect of SUHD support on invasive debug authentication

*Invasive debug with the Security Extensions on page C2-2031* describes invasive debug authentication for a processor that implements the Security Extensions but does not support Secure User halting debug. However, for an implementation that includes support for Secure User halting debug, in Secure User mode, whether halting debug is permitted depends on the value of the `SDER.SUIDEN` bit.

[Table N-1](#) shows the complete set of invasive debug authentication controls on an implementation that supports Secure User halting debug:

**Table N-1 Invasive debug authentication on an implementation that supports Secure User halting debug**

DBGEN <sup>a</sup>	SPIDEN <sup>a</sup>	SDER.SUIDEN	Mode	Security state	SUHD supported	Invasive debug	
LOW	x	x	Any	Either	x	Disabled	
HIGH	LOW	0	Any	Non-secure	x	Enabled and permitted	
				Secure	x	Enabled but not permitted	
		1	Any	Non-secure	x	Enabled and permitted	
				User	Secure	No	Enabled but not permitted
						Yes	Enabled and permitted
		PL1	Secure	x	Enabled but not permitted		
HIGH	HIGH	x	Any	Either	x	Enabled and permitted	

a. Authentication signals, see *Authentication signals on page AppxA-2338*.

## N.3 Effects of SUHD on Debug state

The following sections describes the effects of implementing SUHD on the description of Debug state given in [Chapter C5 Debug State](#):

- [Executing instructions in Debug state in an implementation that supports SUHD](#)
- [Memory system behavior in Debug state when SUHD is supported](#) on page AppxN-2583
- [Effect of SUHD on exception handling in Debug state](#) on page AppxN-2585.

### N.3.1 Executing instructions in Debug state in an implementation that supports SUHD

In User mode and Debug state, instructions have additional privileges to access or modify some registers and fields that cannot be accessed in User mode in Non-debug state. However, on processors that implement the Security Extensions and support Secure User halting debug, these additional privileges are restricted when all the following conditions are true:

- the processor is in Debug state
- the processor is in Secure User mode
- invasive debug is not permitted in Secure PL1 modes, see [Chapter C2 Invasive Debug Authentication](#).

#### Altering CPSR privileged bits in Debug state

In addition to the information given in [Altering CPSR privileged bits in Debug state](#) on page C5-2098, a processor that implements the Security Extensions and supports SUHD prevents updates to the privileged bits of the CPSR when the processor is in Secure User mode and invasive debug is not permitted in Secure PL1 modes. For such an implementation, [Table N-2](#) defines the behavior on writes to the CPSR in Debug state.

**Table N-2 Permitted updates to the CPSR in Debug state in an implementation that supports SUHD**

Mode	Secure state	Invasive debug permitted in Secure PL1 modes	Update privileged CPSR bits <sup>a</sup>	Modify CPSR.M to Monitor mode
User	Yes	No	Update ignored	UNPREDICTABLE
PL1	Yes	No	Permitted	UNPREDICTABLE
Any	No	No	Permitted	UNPREDICTABLE
	X	Yes	Permitted	Permitted

- a. This column does not apply to changing CPSR.M to 0b10110, Monitor mode, but does apply to changing CPSR.M to any other permitted value.

The restrictions on CPSR updates on an implementation that includes the Security Extensions, as described in [Altering CPSR privileged bits in Debug state](#) on page C5-2098, also apply to the information given in [Table N-2](#). In addition, where [Table N-2](#) shows that the effect of attempting to modify the CPSR.M field to Monitor mode is UNPREDICTABLE, the definition of UNPREDICTABLE implies that, if the processor was in User mode before the attempt to modify the M field, it must not enter a PL1 mode.

———— **Note** —————

When the processor is in User mode in Debug state, ARM deprecates updating any CPSR privileged bit other than the M field.

## Coprocessor instructions for CP14 and CP15 when SUHD is supported

In these descriptions, a *permitted* access is one that is not UNDEFINED, and an access that is *not permitted* is UNDEFINED.

In addition to the information given in *Instructions for CP14 and CP15 on page C5-2102*, when a processor supports SUHD:

- Instructions that access CP14 or CP15 registers that are permitted in User mode when in Non-debug state, are always permitted in Debug state.
- Instructions that access CP14 debug registers that are permitted from PL1 when in Non-debug state are permitted in Debug state, regardless of the debug authentication and the processor mode and security state.
- If the processor is in Secure User mode and the debugger cannot write to the *CPSR.M* bits to change to a PL1 mode, then any instruction that accesses a CP14 non-debug register or a CP15 register is not permitted in Debug state if it is not permitted in Secure User mode in Non-debug state.

In addition, if a debug implementation supports SUHD, ARM recommends that certain CP15 instructions that a debugger requires to maintain memory coherency are permitted in Debug state regardless of debug permissions and the processor mode, see *Access to specific cache management functions in Debug state*

## Coprocessor instructions for CP0 to CP13, and Advanced SIMD instructions in Debug state when SUHD is supported

Support for SUHD does not affect the information given in *Instructions for CP0 to CP13, and Advanced SIMD instructions on page C5-2102*.

### N.3.2 Memory system behavior in Debug state when SUHD is supported

If an implementation supports SUHD, then in addition to the requirements given in *Memory system behavior in Debug state on page C5-2109*, a debugger must be able to:

- maintain coherency between instruction and data memory
- maintain coherency in a multiprocessor system
- reset the memory system of the processor to a known safe and coherent state
- reset any caches of meta-information, such as branch predictors, to a safe and coherent state.

If the processor is in a state and mode where it can execute CP15 instructions at PL1, the debugger can use any CP15 operations. These include the cache maintenance operations, and any implemented TLB maintenance operations.

#### ————— **Note** —————

- A processor can execute all CP15 instructions in any state and mode unless it implements the Security Extensions and supports SUHD.
- ARM deprecates executing PL1 CP15 instructions from User mode.

## Access to specific cache management functions in Debug state

If an implementation includes the Security Extensions and supports Secure User halting debug, it must implement mechanisms that enable memory system requirements to be met when debugging in Secure User mode when invasive debug is not permitted in Secure PL1 modes. This is a situation where executing the CP15 cache and TLB control operations would otherwise be prohibited.

To meet these requirements, ARM recommends that, on a processor that implements the Security Extensions and supports Secure User halting debug, when the processor is in Debug state:

- the rules for accessing CP15 registers do not apply for a certain set of register access operations
- the set of operations depends on the Debug architecture version, as shown in *Table N-3 on page AppxN-2584*.

**Table N-3 CP15 operations permitted from User mode in Debug state**

Versions	Operation	Description
v7 Debug	MCR p15, 0, <Rt>, c7, c5, 0	Invalidate all instruction caches to PoU, invalidate branch predictors <sup>a</sup>
	MCR p15, 0, <Rt>, c7, c5, 1	Invalidate instruction caches by MVA to PoU <sup>a</sup>
	MCR p15, 0, <Rt>, c7, c5, 7	Invalidate MVA from branch predictor
	MCR p15, 0, <Rt>, c7, c10, 1	Clean data or unified cache line by MVA to point of coherency <sup>b</sup>
	MCR p15, 0, <Rt>, c7, c10, 2	Clean data or unified cache line by set/way <sup>b</sup>
	MCR p15, 0, <Rt>, c7, c11, 1	Clean data or unified cache line by MVA to point of unification <sup>b</sup>
	MCR p15, 0, <Rt>, c7, c1, 0	Invalidate entire instruction cache Inner Shareable <sup>c</sup>
	MCR p15, 0, <Rt>, c7, c1, 6	Invalidate all branch predictors Inner Shareable <sup>c</sup>
v6.1 Debug	MCR p15, 0, <Rt>, <Rn>, c5	Invalidate instruction cache by VA range
v6.1 Debug, v7 Debug	MCR p15, 0, <Rt>, c7, c5, 6	Invalidate all branch predictors

- See also [v7 Debug restrictions on instruction cache invalidation in Secure User debug on page AppxN-2585](#).
- A debugger does not have to perform cache cleaning operations if `DBGDSCCR.nWT` is implemented and is set to 0. This is because when `nWT` is set to 0, writes do not leave dirty data in the cache that is not coherent with outer levels of memory. However, the instruction cache is not updated, so the debugger must perform instruction cache invalidate operations when appropriate.
- These instructions are part of the Multiprocessing Extensions. See [Multiprocessor considerations for cache and similar maintenance operations on page B2-1273](#).

These instructions must be executable in Debug state regardless of any processor setting. However, use of an operation can generate a Data Abort exception if instruction cache lockdown is in use, see [v7 Debug restrictions on instruction cache invalidation in Secure User debug on page AppxN-2585](#).

For more information about debug access to coprocessor instructions, see [Behavior of coprocessor and Advanced SIMD instructions in Debug state on page C5-2102](#).

For more information about the ARMv7 cache maintenance operations, see:

- [Cache and branch predictor maintenance operations, VMSA on page B4-1740](#) for a VMSA implementation
- [Cache and branch predictor maintenance operations, PMSA on page B6-1941](#) for a PMSA implementation.

If the processor is in a state and mode where it can execute CP15 instructions at PL1, the debugger can use any CP15 operations. These include, but are not limited to, those operations listed in [Table N-3](#).

**Note**

A processor can execute all CP15 instructions in any state and mode if:

- it implements v6.1 Debug or v7 Debug and it does not implement the Security Extensions.
- it implements v7 Debug and the Security Extensions but does not support Secure User halting debug.

However, v7 Debug deprecates executing from User mode CP15 instructions that, in Non-debug state, can only be executed at PL1 or higher.

An implementation that supports SUHD must provide access to the cache clean operations shown in [Table N-3](#), even if the `DBGDSCCR` does not support the force Write-Through feature, as described in [Permitted IMPLEMENTATION DEFINED limits on page C11-2240](#).

### v7 Debug restrictions on instruction cache invalidation in Secure User debug

An ARMv7 implementation that includes the Security Extensions and supports Secure User halting debug must support Secure User debug access to at least one of these instruction cache invalidation operations:

- Invalidate entire instruction cache, and invalidate branch predictors, MCR p15, 0, <Rt>, c7, c5, 0
- Invalidate instruction cache by MVA, MCR p15, 0, <Rt>, c7, c5, 1.

An implementation might support both of these operations.

If the DSCCCR.nWT bit is not implemented, the implementation must also support Secure User debug access to at least the operation to Clean data or unified cache line by MVA to point of coherency.

A debugger requires access to an instruction cache invalidation operations so that it can maintain coherency between instruction memory and data memory, and between processors in a multiprocessor system.

In Secure User mode in Debug state, when invasive debug is not permitted in Secure PL1 modes in Non-debug state:

- If the *Invalidate all instruction caches* operation is supported it must:
  - invalidate all unlocked lines in the cache
  - leave any locked lines in the cache unchanged.If there are locked lines in the cache the instruction can generate a Data Abort exception, but only after it has invalidated all unlocked lines. However, there is no requirement for the operation to abort if there are locked lines.
- If the *Invalidate instruction caches by MVA* operation is supported, this operation must not invalidate a locked line. When an instruction attempts to invalidate a locked line it is IMPLEMENTATION DEFINED whether the processor consistently:
  - ignores the instruction
  - generates a Data Abort exception.

These requirements mean that these instructions might operate differently in Debug state to how they operate in Non-debug state.

———— **Note** —————

In ARMv7, it is IMPLEMENTATION DEFINED whether instruction cache locking is supported.

### N.3.3 Effect of SUHD on exception handling in Debug state

The only effect SUHD has on the description given in [Exceptions in Debug state on page C5-2105](#) is in the reporting of synchronous Data Abort exceptions. In an implementation that includes support for SUHD, on a synchronous Data Abort exception:

- if invasive debug is permitted in Secure PL1 modes, or the processor is not in Secure User mode, the [DFSR](#) and [DFAR](#) are updated
- otherwise, it is IMPLEMENTATION DEFINED whether the [DFSR](#) and [DFAR](#) are updated.



# Appendix O

## ARMv4 and ARMv5 Differences

This appendix describes how the ARMv4 and ARMv5 architectures differ from the ARMv6 and ARMv7 architectures. It contains the following sections:

- *Introduction to ARMv4 and ARMv5* on page AppxO-2588
- *Application level register support* on page AppxO-2589
- *Application level memory support* on page AppxO-2590
- *Instruction set support* on page AppxO-2595
- *System level register support* on page AppxO-2601
- *System level memory model* on page AppxO-2604
- *System Control coprocessor; CP15 support* on page AppxO-2612.

———— **Note** —————

In this appendix, unless otherwise stated, the description ARMvN refers to all architecture variants of ARM architecture vN. For example, ARMv4 refers to all variants of ARM architecture v4, including ARMv4 and ARMv4T.

---

## O.1 Introduction to ARMv4 and ARMv5

ARMv4 and ARMv5 defined the instruction set support and the programmers' model that applies to the ARM core registers and the associated exception model. These architecture versions are fully described in the *ARM Architecture Reference Manual (DDI 0100)*.

### ———— Note ————

This appendix is a summary of the ARMv4 and ARMv5 architecture variants. ARM expects that this appendix and the rest of this manual satisfy the majority of requirements for architecture information on ARMv4 and ARMv5. However the *ARM Architecture Reference Manual (DDI 0100)* might be required for more information specific to ARMv4 or ARMv5.

Memory support is IMPLEMENTATION DEFINED in ARMv4 and ARMv5. In practice, use of CP15 to support the *Virtual Memory System Architecture (VMSA)* or *Protected Memory System Architecture (PMSA)* is standard in ARMv4 and ARMv5 implementations, but this is not an architectural requirement. For this reason, the data sheet or Technical Reference Manual for a particular ARM processor is the definitive source for its memory and system control facilities. This appendix does not specify absolute requirements on the functionality of CP15 or other memory system components. Instead, it contains guidelines designed to maximize compatibility with current and future ARM software.

This appendix concentrates on the features supported in ARMv4 and ARMv5, highlighting:

- features common across all architecture variants
- features supported for legacy reasons in ARMv6, but not in ARMv7
- features unique to the ARMv4 and ARMv5 variants.

### O.1.1 Debug

Debug is not architecturally-defined in ARMv4 or ARMv5. ARM implementations have traditionally supported halting debug through a JTAG port. While the support of debug features is similar across ARM implementations, the timing and control sequencing required for access varies. Debug support in ARMv4 and ARMv5 is microarchitecture dependent and so in architectural terms is IMPLEMENTATION DEFINED.

### O.1.2 ARMv6 and ARMv7

The ARM architecture was extended considerably in ARMv6. This means that a large proportion of this manual does not apply to earlier architecture variants and can be ignored with respect to ARMv4 and ARMv5.

The key changes in ARMv6 are:

- the addition of:
  - the ARM parallel addition and subtraction instructions, described in *Parallel addition and subtraction instructions on page A4-171*, that improve execution of multimedia and other DSP applications
  - instructions for improved context switching.
- the introduction of:
  - a formal memory model, including level 1 cache support and revisions to alignment and endianness support
  - a requirement to provide either a VMSA or a PMSA for memory management
  - a formal debug model
  - a requirement to support the CP15 System Control coprocessor
  - a new translation table format and additional VMSA features
  - the optional Security Extensions
  - 32-bit Thumb instructions, in ARMv6T2.

For information about the changes between ARMv6 and ARMv7 see [Appendix L ARMv6 Differences](#).



## O.2 Application level register support

The ARMv4 and ARMv5 core registers are the same as ARMv7. For more information, see [ARM core registers on page A2-45](#). The following sections give more information about ARMv4 and ARMv5 application level register support:

- [APSR support](#)
- [Instruction set state](#).

### O.2.1 APSR support

Program status is reported in the 32-bit *Application Program Status Register (APSR)*. The APSR bit assignments are:

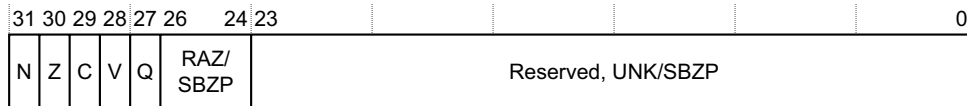

For details of the bit definitions, see [The Application Program Status Register \(APSR\) on page A2-49](#). In the APSR descriptions:

- the GE[3:0] field is only defined from ARMv6, and is reserved in ARMv4 and ARMv5
- the Q bit is only defined from ARMv5TE, and is RAZ/WI in ARMv4, ARMv4T and ARMv5T.

Earlier versions of this manual do not use the term APSR. They refer to the APSR as the *CPSR* with the restriction on reserved fields governed by whether the register access was unprivileged, or at a higher privilege level.

### O.2.2 Instruction set state

The instruction set states available in ARMv4 and ARMv5 are a subset of the states supported in ARMv7. All implementations support the ARM instruction set that executes in ARM state. All ARM instructions are 32-bit instructions. T variants of the architecture also support a 16-bit instruction set that executes in Thumb state. The supported ARM and Thumb instructions are summarized in [Instruction set support on page AppxO-2595](#).

Instruction set state support in ARMv4 and ARMv5 differs from the support available in ARMv7 as follows:

- ThumbEE state is not supported
- Jazelle state is supported only in ARMv5TEJ
- With software executing at PL1, you must take care not to attempt to change the instruction set state by writing nonzero values to *CPSR.J* and *CPSR.T* with an MSR instruction. For more information, see [Format of the CPSR and SPSRs on page AppxL-2514](#).

All ARMv4 and ARMv5 implementations support the ARM instruction set. ARMv4T, ARMv5T, ARMv5TE, and ARMv5TEJ also support a subset of the Thumb instruction set that can be executed entirely as 16-bit instructions. The only 32-bit instructions in this subset are restricted-range versions of the BL and BLX (immediate) instructions. See [BL and BLX \(immediate\) instructions, before ARMv6T2 on page AppxL-2502](#) for a description of how these instructions can be executed as 16-bit instructions.

[Instruction set support on page AppxO-2595](#) summarizes the ARM and Thumb instructions supported in ARMv4 and ARMv5, and the instruction descriptions in [Chapter A8 Instruction Details](#) give details of the architecture variants that support each instruction encoding.

### Interworking

In ARMv4T, the only instruction that supports interworking branches between ARM and Thumb states is BX.

In ARMv5T, the BLX instruction was added to provide interworking procedure calls. The LDR, LDM and POP instructions were modified to perform interworking branches if they load a value into the PC. This is described by the LoadWritePC() pseudocode function. See [Pseudocode details of operations on ARM core registers on page A2-47](#).

## O.3 Application level memory support

Memory support covers address alignment, endianness support, semaphore support, memory type, memory order model, caches, and write buffers.

### O.3.1 Alignment

ARMv4 and ARMv5 behave differently from ARMv7 for unaligned memory accesses. The behavior is the same as ARMv6 legacy mode except for forcing alignment checks with `SCTLR.A == 1`.

For ARM instructions when `SCTLR.A == 0`:

- Non halfword-aligned LDRH, LDRSH, and STRH are UNPREDICTABLE.
- Non word-aligned LDR, LDRT, and the load access of a SWP rotate right the word-aligned data transferred by a non word-aligned address one, two, or three bytes depending on the value of address[1:0].
- Non word-aligned STR, STRT, and the store access of a SWP ignore address[1:0].
- From ARMv5TE, it is IMPLEMENTATION DEFINED whether LDRD and STRD must be doubleword-aligned or word-aligned. LDRD and STRD instructions that do not meet the alignment requirement are UNPREDICTABLE.
- Non word-aligned LDM, LDC, LDC2, and POP ignore address[1:0].
- Non word-aligned STM, STC, STC2, and PUSH ignore address[1:0].

For Thumb instructions when `SCTLR.A == 0`:

- Non halfword-aligned LDRH, LDRSH, and STRH are UNPREDICTABLE.
- Non word-aligned LDR, and STR are UNPREDICTABLE.
- Non word-aligned LDMIA, and POP ignore address[1:0].
- Non word-aligned STMIA, and PUSH ignore address[1:0].

For ARM and Thumb instructions, alignment checking is defined for implementations supporting CP15, specifically the `SCTLR.A` bit. When this bit is set, a Data Abort exception indicating an Alignment fault is generated for unaligned accesses. When `SCTLR.A = 1`, whether the alignment check for an LDRD or STRD instruction is for doubleword-alignment or word-alignment depends on the implementation choice of which alignments are supported for these instructions when `SCTLR.A = 0`.

———— **Note** —————

The option of word alignment for LDRD and STRD instructions is not permitted in the ARMv6 legacy configuration where `SCTLR.U == 0` and `SCTLR.A == 1`. For more information, see legacy alignment support in [Alignment on page AppxL-2504](#).

### O.3.2 Endian support

ARMv4 and ARMv5 support big-endian and little-endian operation. Little-endian support is consistent with ARMv7. Big-endian control, configuration, and the connectivity of data bytes between the ARM register file and memory is different. However, the difference is only visible when communicating between big-endian and little-endian agents using memory. The agents can be different processors or programs running with different endianness settings on the same processor.

For ARMv4 and ARMv5, the distinction between big-endian memory and little-endian memory is managed by changing the addresses of the bytes in a word. For ARMv7, the distinction between big-endian memory and little-endian memory is managed by keeping the byte addresses the same, and reordering the bytes in the halfword or word. The endianness formats are:

- LE** Little-endian format used by ARMv4, ARMv5, ARMv6, and ARMv7.
- BE** Big-endian format used by ARMv6 and ARMv7. For ARMv6 this is the big-endian format controlled by the SETEND instruction.
- BE-32** Big-endian format used by ARMv4, ARMv5, and ARMv6. In ARMv6 this is the legacy format, for which the endianness is controlled by the SCTLR.B bit.

Table O-1 shows how the addresses of bytes are changed in the BE-32 endianness format. In this table, A is a doubleword-aligned address and S, T, U, V, W, X, Y, Z are the bytes at addresses A to A+7 in the ARMv7 memory map.

**Table O-1 Addresses of bytes in endianness formats**

Byte	Address in format BE or LE	Address in format BE-32
S	A	A+3
T	A+1	A+2
U	A+2	A+1
V	A+3	A
W	A+4	A+7
X	A+5	A+6
Y	A+6	A+5
Z	A+7	A+4

Aligned memory accesses are performed using these byte addresses as shown in Figure A3-1 on page A3-111 for the little-endian and big-endian endianness formats. Table O-2 shows which bytes are accessed by each type of aligned memory access and the significance order in which they are accessed.

**Table O-2 Bytes accessed by aligned accesses in endianness formats**

Memory access:		Bytes accessed in endianness format:		
Size	Address	LE	BE	BE-32
Doubleword	A	ZYXWVUTS	STUVWXYZ	VUTSZYXW
Word	A	VUTS	STUV	VUTS
Word	A+4	ZYXW	WXYZ	ZYXW
Halfword	A	TS	ST	VU
Halfword	A+2	VU	UV	TS

**Table O-2 Bytes accessed by aligned accesses in endianness formats (continued)**

Memory access:		Bytes accessed in endianness format:		
Size	Address	LE	BE	BE-32
Halfword	A+4	XW	WX	ZY
Halfword	A+6	ZY	YZ	XW
Byte	A	S	S	V
Byte	A+1	T	T	U
Byte	A+2	U	U	T
Byte	A+3	V	V	S
Byte	A+4	W	W	Z
Byte	A+5	X	X	Y
Byte	A+6	Y	Y	X
Byte	A+7	Z	Z	W

———— **Note** —————

If the ARMv4 and ARMv5 endianness model was extended to unaligned word and halfword accesses, for example loading a word from byte addresses 0x1001, 0x1002, 0x1003, and 0x1004, it would not return the same bytes of data to a big-endian and little-endian agent. However, ARMv4 and ARMv5 do not support unaligned memory access and therefore this cannot occur. In ARMv4 and ARMv5 where use of an unaligned address is permitted, the actual memory access is naturally aligned. See [Alignment on page AppxO-2590](#).

In ARMv7, all big-endian accesses return the same bytes of data from memory as the corresponding little-endian accesses. It is only the byte order in the returned value that is different.

For an ARMv4 or ARMv5 implementation, whether the endianness of the memory access is fixed, defined by an input pin on reset, or controlled by the [SCTLR.B](#) bit is IMPLEMENTATION DEFINED.

**Examples**

The distinction between BE and BE-32 is not visible if all agents use the same endianness format, because a given memory address always accesses the same location in memory. However, if there are two agents with different endianness the effect is as shown in [Example O-1](#) and [Example O-2 on page AppxO-2593](#).

**Example O-1 Distinction between BE and BE-32 word stores observed by an LE agent**

In this example:

- Agent1 is big-endian, R1=0x1000, R2=0x11223344
- Agent2 is little-endian, R1=0x1000.

Agent1:

```
STR R2, [R1]
```

Agent2:

```
LDR R2, [R1]           // If Agent1 uses BE-32 endianness format: R2 = 0x11223344
                       // If Agent1 uses BE endianness format: R2 = 0x44332211
```

**Example O-2 Distinction between BE and BE-32 byte stores observed by an LE agent**

In this example:

- Agent1 is big-endian, R1=0x1000, R2=0x44, R3=0x11
- Agent2 is little-endian, R1=0x1000.

Agent1:

```
STRB R2, [R1]
STRB R3, [R1, #3]
```

Agent2:

```
LDRB R2, [R1] // If Agent1 uses BE-32 endianness format: R2 = 0x11
               // If Agent1 uses BE endianness format: R2 = 0x44
```

**O.3.3 Semaphore support**

The only semaphore support in ARMv4 and ARMv5 is provided by the SWP and SWPB ARM instructions. From ARMv6, ARM deprecates any use of these instructions, in favour of the exclusive access mechanism provided by LDREX, STREX, and related instructions.

**O.3.4 Memory model and memory ordering**

There is no formal definition of the memory model in ARMv4 and ARMv5. ARM implementations generally adopted a Strongly-ordered approach. However the memory order model is IMPLEMENTATION DEFINED.

**Memory type support**

In ARMv4 and ARMv5 where CP15 is implemented, memory can be tagged using two control bits:

- the B (Bufferable) bit, to indicate whether write buffering between the processor and memory is permitted
- the C (Cacheable) bit.

Table O-3 shows the ARMv4 and ARMv5 definitions of the C bit and B bit that are interpreted as the formal memory types defined in ARMv6 and ARMv7.

**Table O-3 Interpretation of Cacheable and Bufferable bits**

C	B	Memory type
0	0	Strongly-ordered
0	1	Device
1	0	Normal, Write-Through Cacheable
1	1	Normal, Write-Back Cacheable

From ARMv6, the memory attributes are significantly different from those in previous versions of the architecture. Table O-4 shows the interpretation of the earlier memory types in the light of this definition.

**Table O-4 Backwards compatibility**

<b>ARMv6 and ARMv7 attribute</b>	<b>Previous architectures</b>
Strongly-ordered	Non-cacheable, Non-bufferable (NCNB)
Device <sup>a</sup>	Non-cacheable, Bufferable (NCB)
Non-shareable Normal, Write-Through Cacheable	Write-Through Cacheable, Bufferable
Non-shareable Normal, Write-Back Cacheable	Write-Back Cacheable, Bufferable

- a. Shareable Device in ARMv6, and in ARMv7 implementations that permit Device regions that have shareability attributes other than Outer Shareable.

## O.4 Instruction set support

Two instruction sets are supported in ARMv4 and ARMv5:

- the ARM instruction set is supported by all variants of ARMv4 and ARMv5
- the Thumb instruction set is supported by ARMv4T, ARMv5T, ARMv5TE, and ARMv5TEJ.

Floating-point support, identified as VFPv2, was added as an option in ARMv5TE. The VFP instructions are a subset of the coprocessor support in the ARM instruction set, and use coprocessor numbers 10 and 11. The following instructions are not supported in VFPv2, and are specific to the ARMv7 VFP support in VFPv3:

- VMOV (immediate)
- VCVT (between floating-point and fixed-point).

---

### Note

- VFP instruction mnemonics previously started with an F. However the *Unified Assembler Language* (UAL) introduced in ARMv6T2 changes this to a V prefix, and in many cases the rest of the mnemonic is changed to be more compatible with other instructions. This aligns the scalar floating-point instructions in the Floating-point (VFP) Extension with the ARMv7 Advanced SIMD instructions in the Advanced SIMD Extension. The floating-point and Advanced SIMD instructions share some load, store, and move instructions that access a common register file.
  - The VFPv2 instructions are summarized in *F\*, former Floating-point instruction mnemonics on page A8-388*. This includes the two deprecated instructions in VFPv2 that do not have UAL mnemonics, the FLDMM and FSTMM instructions.
- 

The instruction sets have grown significantly in ARMv6 and ARMv7. The changes include:

- the addition of the parallel addition and subtraction SIMD instructions
- improved context switching in ARMv6
- the addition of many 32-bit Thumb instructions in ARMv6T2 and ARMv7
- the ThumbEE Extension in ARMv7
- addition of the SMC instruction with the Security Extensions
- the Advanced SIMD Extension in ARMv7.

The ARM and Thumb instruction encodings including the VFP instructions are defined in *Alphabetical list of instructions on page A8-300*.

---

### Note

This appendix describes the instructions included as a mnemonic in ARMv4 and ARMv5. For any mnemonic, to determine which associated instruction encodings appear in a particular architecture variant, see the subsections of *Alphabetical list of instructions on page A8-300* that describe the mnemonic. Each encoding diagram shows the architecture variants or extensions that include the encoding.

---

The following sections give more information about ARMv4 and ARMv5 instruction set support:

- *ARM instruction set support on page AppxO-2596*
- *Thumb instruction set support on page AppxO-2598*
- *System level instruction set support on page AppxO-2600*.

### O.4.1 ARM instruction set support

Table O-5 shows the ARM instructions supported in ARMv4 and ARMv5, excluding VFP instructions.

**Table O-5 ARM instructions, ARMv4 and ARMv5**

<b>Instruction</b>	<b>v4, v4T, v5T</b>	<b>v5TE, v5TEJ</b>
ADC	Yes	Yes
ADD	Yes	Yes
AND	Yes	Yes
B	Yes	Yes
BIC	Yes	Yes
BKPT	v5T only	Yes
BL	Yes	Yes
BLX	v5T only	Yes
BX	v4T and v5T only	Yes
BXJ	No	v5TEJ only
CDP	Yes	Yes
CDP2	v5T only	Yes
CLZ	v5T only	Yes
CMN	Yes	Yes
CMP	Yes	Yes
EOR	Yes	Yes
LDC	Yes	Yes
LDC2	v5T only	Yes
LDM	Yes <sup>a</sup>	Yes <sup>a</sup>
LDR	Yes	Yes
LDRB	Yes	Yes
LDRD	No	Yes
LDRBT	Yes	Yes
LDRH	Yes	Yes
LDRSB	Yes	Yes
LDRSH	Yes	Yes
LDRT	Yes	Yes
MCR	Yes	Yes
MCR2	v5T only	Yes
MCRR	No	Yes



**Table O-5 ARM instructions, ARMv4 and ARMv5 (continued)**

<b>Instruction</b>	<b>v4, v4T, v5T</b>	<b>v5TE, v5TEJ</b>
MLA <sup>b</sup>	Yes	Yes
MOV	Yes	Yes
MRC	Yes	Yes
MRC2	v5T only	Yes
MRRC	No	Yes
MRS	Yes	Yes
MSR	Yes	Yes
MUL <sup>b</sup>	Yes	Yes
MVN	Yes	Yes
ORR	Yes	Yes
PLD	No	Yes
QADD	No	Yes
QDADD	No	Yes
QDSUB	No	Yes
QSUB	No	Yes
RSB	Yes	Yes
RSC	Yes	Yes
SBC	Yes	Yes
SMLAL <sup>c</sup>	Yes	Yes
SMLABB, SMLABT, SMLATB, SMLATT	No	Yes
SMLALBB, SMLALBT, SMLALTB, SMLALTT	No	Yes
SMLAWB, SMLAWT	No	Yes
SMULBB, SMULBT, SMULTB, SMULTT	No	Yes
SMULL <sup>c</sup>	Yes	Yes
SMULWB, SMULWT	No	Yes
STC	Yes	Yes
STC2	v5T only	Yes
STM	Yes	Yes
STR	Yes	Yes
STRB	Yes	Yes
STRBT	Yes	Yes
STRD	No	Yes

**Table O-5 ARM instructions, ARMv4 and ARMv5 (continued)**

Instruction	v4, v4T, v5T	v5TE, v5TEJ
STRH	Yes	Yes
STRT	Yes	Yes
SUB	Yes	Yes
SVC (previously SWI)	Yes	Yes
SWP	Yes	Yes
SWPB	Yes	Yes
TEQ	Yes	Yes
TST	Yes	Yes
UMLAL <sup>c</sup>	Yes	Yes
UMULL <sup>c</sup>	Yes	Yes

- a. See *Restriction on LDM (User registers) before ARMv6*
- b. The value of APSR.C generated by flag-setting versions of these instructions is UNKNOWN in ARMv4 and is unchanged from ARMv5.
- c. The values of APSR.C and APSR.V generated by flag-setting versions of these instructions are UNKNOWN in ARMv4 and are unchanged from ARMv5.

### Restriction on LDM (User registers) before ARMv6

Before ARMv6, the Load Multiple (User registers) form of LDM, described in *LDM (User registers)* on page B9-1986, must not be followed by an instruction that accesses Banked registers. Software can ensure this condition is met by inserting a NOP instruction after the LDM (User registers) instruction.

## O.4.2 Thumb instruction set support

Table O-6 shows the 16-bit Thumb instructions supported in ARMv4 and ARMv5. ARMv4 before ARMv4T does not support any Thumb instructions.

**Table O-6 ARMv4 and ARMv5 support for Thumb instructions**

Instruction	v4T	v5T, v5TE, v5TEJ
ADC	Yes	Yes
ADD	Yes	Yes
AND	Yes	Yes
ASR	Yes	Yes
B	Yes	Yes
BIC	Yes	Yes
BKPT	No	Yes
BL	Yes	Yes
BLX	No	Yes
BX	Yes	Yes

**Table O-6 ARMv4 and ARMv5 support for Thumb instructions (continued)**

<b>Instruction</b>	<b>v4T</b>	<b>v5T, v5TE, v5TEJ</b>
CMN	Yes	Yes
CMP	Yes	Yes
EOR	Yes	Yes
LDMIA	Yes	Yes
LDR	Yes	Yes
LDRB	Yes	Yes
LDRH	Yes	Yes
LDRSB	Yes	Yes
LDRSH	Yes	Yes
LSL	Yes	Yes
LSR	Yes	Yes
MOV	Yes	Yes
MUL	Yes	Yes
MVN	Yes	Yes
NEG	Yes	Yes
ORR	Yes	Yes
POP	Yes	Yes
PUSH	Yes	Yes
ROR	Yes	Yes
SBC	Yes	Yes
STMIA	Yes	Yes
STR	Yes	Yes
STRB	Yes	Yes
STRH	Yes	Yes
SUB	Yes	Yes
SVC (previously SWI)	Yes	Yes
TST	Yes	Yes

### O.4.3 System level instruction set support

The register and immediate forms of the MRS and MSR instructions are executed to manage the CPSR and SPSR as applicable. Other system level instructions are:

- LDM (exception return) and LDM (user registers)
- LDRBT and LDRT
- STM (user registers)
- STRBT and STRT
- SUBS PC, LR and related instructions
- VMRS and VMSR where VFP is supported.

All system level support is from ARM state.

## O.5 System level register support

The general registers and programming modes are the same as ARMv7, except that the Security Extensions and Monitor mode are not supported. For more information, see [Figure B1-2 on page B1-1144](#). The following sections give information about ARMv4 and ARMv5 system level register support:

- [Program Status Registers \(PSRs\)](#)
- [The exception model on page AppxO-2602](#)
- [Jazelle direct bytecode execution support on page AppxO-2603](#).

### O.5.1 Program Status Registers (PSRs)

The Application level programmers' model provides the *Application Program Status Register* (APSR). See [The Application Program Status Register \(APSR\) on page A2-49](#). This is an application level alias for the CPSR. The system level view of the CPSR extends the register, adding state that:

- is used by exceptions
- controls the processor mode.

Each of the PL1 modes to which an exception can be taken has its own saved copy of the CPSR, the *Saved Program Status Register* (SPSR), as shown in [Figure B1-2 on page B1-1144](#). For example, the SPSR for Abort mode is called SPSR\_abt.

———— **Note** —————

ARMv4 and ARMv5 do not support Monitor mode and the Security Extensions.

#### The Current Program Status Register (CPSR)

The CPSR holds the following processor status and control information:

- The APSR, see [APSR support on page AppxO-2589](#)
- The current instruction set state. See [Instruction set state register; ISETSTATE on page A2-50](#), except that:
  - ThumbEE state is not supported
  - Jazelle state is supported only in ARMv5TEJ.
- The current processor mode
- Interrupt disable bits.

The non-APSR bits of the CPSR have defined reset values. These are shown in the TakeReset() pseudocode function described in [Reset on page B1-1204](#), except that:

- the CPSR.IT[7:0], CPSR.E and CPSR.A bits are not defined and so do not have reset values
- before ARMv5TEJ, the CPSR.J bit is not defined and so does not have a reset value
- the reset value of CPSR.T is 0.

The rules described in [The Current Program Status Register \(CPSR\) on page B1-1147](#) about when mode changes take effect apply with the modification that the ISB can only be the ISB operation described in [CP15 c7, Miscellaneous functions on page AppxO-2629](#).

#### The Saved Program Status Registers (SPSRs)

The SPSRs are defined as they are in ARMv7, see [The Saved Program Status Registers \(SPSRs\) on page B1-1148](#), except that:

- the GE[3:0], IT[7:0], E and A bits are not implemented
- before ARMv5TEJ, the J bit is not implemented.

### Format of the CPSR and SPSRs

The CPSR and SPSR bit assignments are:

31	30	29	28	27	26	25	24	23										8	7	6	5	4						0
N	Z	C	V	Q	RAZ/WI	J	Reserved, UNK/SBZP											I	F	T	M[4:0]							

The definitions and general rules for the defined PSR bits are the same as ARMv7, see *Format of the CPSR and SPSRs on page B1-1148*, except that:

- Before ARMv5TEJ, the J bit is RAZ/WI.
- The T bit of the CPSR, and in ARMv5TEJ the J bit of the CPSR, must not be changed when the CPSR is written by an MSR instruction, or else the behavior is UNPREDICTABLE. MSR instructions exist only in ARM state in these architecture variants, so this is equivalent to saying the MSR instructions executed at PL1 must treat these bits as SBZP. MSR instructions in User mode still ignore writes to these bits.
- The IT[7:0], GE[3:0], E, and A field definitions for ARMv7 do not apply to ARMv4 and ARMv5.
- Monitor mode is not supported. The associated M[4:0] encoding is a reserved value in ARMv4 and ARMv5.

### O.5.2 The exception model

The exception vector offsets and priorities are consistent across all variants of the ARM architecture that use the exception model as stated in *Exception handling on page B1-1164*. The Security Extensions and low interrupt latency configuration do not apply to ARMv4 and ARMv5.

In ARMv4 and ARMv5, it is IMPLEMENTATION DEFINED whether high vectors are supported. If they are supported, a hardware configuration input selects whether the low vectors or the high vectors are used from reset. If high vectors are not supported then SCTL.R.V, bit[13], is reserved, RAZ.

ARMv4 and ARMv5 do not support asynchronous external aborts.

#### The ARM abort model

ARMv6 and ARMv7 use a *Base Restored Abort Model* (BRAM). However, in ARMv5 and ARMv4 it is IMPLEMENTATION DEFINED whether this model, or a *Base Updated Abort Model* (BUAM) is used. These two abort models are defined as:

##### Base Restored Abort Model

The base register of any valid load/store instruction that causes a memory system abort is always restored to the value it had immediately before that instruction.

##### Base Updated Abort Model

After an abort, the base register of any valid load/store instruction that causes a memory system abort is modified by the base register writeback, if any, of that instruction.

The implemented abort model applies uniformly across all instructions.

## Exception entry

Entry to exceptions in ARMv4 and ARMv5 is generally as described in the sections:

- [Reset](#) on page B1-1204
- [Undefined Instruction exception](#) on page B1-1205
- [Supervisor Call \(SVC\) exception](#) on page B1-1209
- [Secure Monitor Call \(SMC\) exception](#) on page B1-1210
- [Prefetch Abort exception](#) on page B1-1212
- [Data Abort exception](#) on page B1-1214
- [IRQ exception](#) on page B1-1218
- [FIQ exception](#) on page B1-1221.

These ARMv7 descriptions are modified as follows:

- in pseudocode statements that set registers, bits and fields that do not exist in the ARMv4 or ARMv5 architecture variant are ignored
- `CPSR.T` is set to 0, not to `SCTLR.TE`.

### O.5.3 Jazelle direct bytecode execution support

In ARMv5TEJ, the `JOSCR.CV` bit is not changed on exception entry in any implementation of Jazelle.

## O.6 System level memory model

The pseudocode listed in [Aligned memory accesses on page B2-1294](#) and [Unaligned memory accesses on page B2-1295](#) covers the alignment behavior of all architecture variants from ARMv4. For ARMv4 and ARMv5, SCTL.R.U is zero, see [Alignment on page AppxL-2504](#).

The following sections describe the system level memory model:

- [Cache support](#)
- [Tightly Coupled Memory support](#)
- [Virtual memory support](#)
- [Protected memory support on page AppxO-2609](#).

### O.6.1 Cache support

CP15 operations are defined that provide cache operations for managing level 1 instruction, data, or unified caches. Caches can be direct mapped or N-way associative. ARMv4 and ARMv5 define a Cache Type ID Register, to enable software to determine the level 1 cache topology.

ARMv4 and ARMv5 support virtual (virtually indexed, virtually tagged) or physical caches. In a virtual memory system that supports virtual cache or caches, there is no coherence support for virtual aliases that map to the same physical address. When a virtual to physical address mapping changes, caches must be cleaned and invalidated accordingly.

Cache management and flushing of any write buffer in the processor is IMPLEMENTATION DEFINED and managed by CP15. CP15 also supports configuration and control of cache lockdown. For more information on cache management support see [System Control coprocessor, CP15 support on page AppxO-2612](#), and [CP15 c7, Cache and branch predictor operations on page AppxO-2628](#) and [CP15 c9, cache lockdown support on page AppxO-2630](#).

### O.6.2 Tightly Coupled Memory support

*Tightly Coupled Memory* (TCM) support in ARMv4 and ARMv5 is IMPLEMENTATION DEFINED.

### O.6.3 Virtual memory support

The ARMv4 and ARMv5 translation tables support a similar two level translation table format to the ARMv7 tables. However, there are significant differences in the translation table format because of the following:

- ARMv6 introduced additional bits for encoding memory types, attributes, and extended cache attributes.
- The new translation table format in ARMv6 does not support subpage access permissions.
- ARMv4 does not support 16MB Supersections.
- Only ARMv4 and ARMv5 support tiny (1KB) pages. The fine second level page format is not supported from ARMv6.

For general information about address translation in a VMSA, see [About the VMSA on page B3-1308](#)

The *Fast Context Switch Extension* (FCSE) is an implementation option in ARMv4 and ARMv5 VMSA implementations. For more information, see [Appendix J Fast Context Switch Extension \(FCSE\)](#).

———— **Note** —————

ARMv7 only supports the new translation table format. ARMv6 supports both old and new formats and uses SCTL.R[23] to select which format to use. For more information, see [CP15 c1, System Control Register, SCTL.R on page AppxL-2528](#).



The *Virtual Memory System Architecture* (VMSA) in ARMv4 and ARMv5 supports the following:

- 16MB Supersections, optional support from ARMv5TE
- 1MB Sections
- 64KB Large pages
- 4KB Small pages
- 1KB Tiny pages.

Section virtual to physical address translation is supported by a single level translation table walk. Page address translation requires a two level translation table walk. Each level involves an aligned word read from a translation table in memory with the first level translation table base address held in a CP15 register, **TTBR0**. Translation table entries might be cached in a *Translation Lookaside Buffer* (TLB) in the *Memory Management Unit* (MMU) of a given implementation. CP15 operations are executed to manage the TLB. For more information, see [CP15 c8](#), [VMSA TLB support on page AppxO-2630](#).

———— **Note** —————

ARMv4 and ARMv5 support a single translation table base address register. **TTBR1** and **TTBCR** were introduced in ARMv6.

Second level translation table accesses are derived from the additional information provided by the first level translation table entry. Two sizes of second level translation table are supported:

- a Coarse page table, where each entry translates a 4KB address space
- a Fine page table, where each entry translates a 1KB address space.

Translation tables are always naturally aligned in memory to the address space they occupy. This means that the least significant n bits of the translation table base address are zero, where  $n = \log_2(\text{SIZE})$ , and SIZE is the size of the table in bytes.

### Translation attributes

ARMv4 and ARMv5 support the following translation table attributes:

- domain access as described in [Domains, Short-descriptor format only on page B3-1362](#)
- cacheability with the C and B bits, see [Interpretation of Cacheable and Bufferable bits on page AppxO-2593](#)
- access permissions using the AP[1:0], **SCTLR.S** and **SCTLR.R** bits as defined in [Table O-7](#)
- from ARMv5TE, the option of marking sections as Shareable and support for extended cache attributes using the TEX field with the C and B bits. See [Table O-8 on page AppxO-2606](#) and [Table O-9 on page AppxO-2607](#).

**Table O-7 VMSA access permissions in ARMv4 and ARMv5**

<b>SCTLR</b>		<b>AP[1:0]</b>	<b>PL1 permissions</b>	<b>User permissions</b>	<b>Description</b>
<b>S</b>	<b>R</b>				
0	0	00	No access	No access	All accesses generate Permission faults
x	x	01	Read/write	No access	PL1 access only
x	x	10	Read/write	Read-only	Writes in User mode generate Permission faults
x	x	11	Read/write	Read/write	Full access
0	1	00	Read-only	Read-only	Read-only in all modes
1	0	00	Read-only	No access	PL1 read-only, reads in User mode generate Permission faults
1	1	00	-	-	Reserved

**Note**

Changes to the SCTL.R. {S, R} bits do not affect the access permissions of entries already in the TLB. The TLB must be flushed for the updated S and R bit values to take effect.

**First level descriptor formats**

Table O-8 shows the translation table first level descriptor formats:

- Supersection support, the TEX field, and the S bit are only permitted from ARMv5TE. Where these features are not supported, the corresponding bits must be zero.
- Supersections can support address translation from a 32-bit virtual address to a physical address of up to 40 bits.

**Table O-8 ARMv4 and ARMv5 first level descriptor format**

	31	24 23	20 19	15 14	12 11 10	9 8	5 4 3 2	1 0								
Fault	Ignore									0	0					
Coarse page table	Coarse page table base address							P	Domain	SBZ		0	1			
Section	Section base address			S B Z	0	S B Z	S <sup>a</sup> B Z	TEX <sup>b</sup>	AP	P	Domain	S B Z	C	B	1	0
Supersection	Supersection base address	PA[35:32] optional	S B Z	1	S B Z	S B Z	TEX	AP	P	PA[39:36] optional	S B Z	C	B	1	0	
Fine page table	Fine page table base address							SBZ	P	Domain	SBZ		1	1		

- a. S=1 indicates Shareable memory. For more information, see [Summary of ARMv7 memory attributes on page A3-126](#).  
 b. From ARMv5TE, the TEX bits can be used with the C and B bits as described in [Short-descriptor format memory region attributes, without TEX remap on page B3-1367](#).

Bits[1:0] of the descriptor identify the descriptor type:

- 0b00 Invalid or fault entry.
- 0b01 Coarse page table descriptor. Bits[31:10] of the descriptor give the physical address of a second level translation table.
- 0b10 Section or Supersection descriptor for the associated Modified Virtual Address (MVA). Bits[31:20] of the descriptor give the Section address, bits[31:24] provide the Supersection address. Bit[18] indicates which to use when both are supported.
- 0b11 Fine page table descriptor. Bits[31:12] of the descriptor give the physical address of a second level translation table.



### Translation table walks

An MVA and TTBR0 are used when accessing translation table information, as follows:

- For a Section translation. See Figure B3-9 on page B3-1335 with  $N == 0$ .
- For a Large page translation using a Coarse page table access. See Figure B3-10 on page B3-1336 with  $N == 0$ .
- For a Small page translation using a Coarse page table access. See Figure B3-11 on page B3-1337 with  $N == 0$ .
- For a Tiny page translation using a Fine page table access. See Figure O-1.

———— **Note** ————

A Large page table or Small page table translation is performed on a Fine page table access by reducing the second level translation table base address to bits[31:12] and extending the second level table index to MVA[19:10].

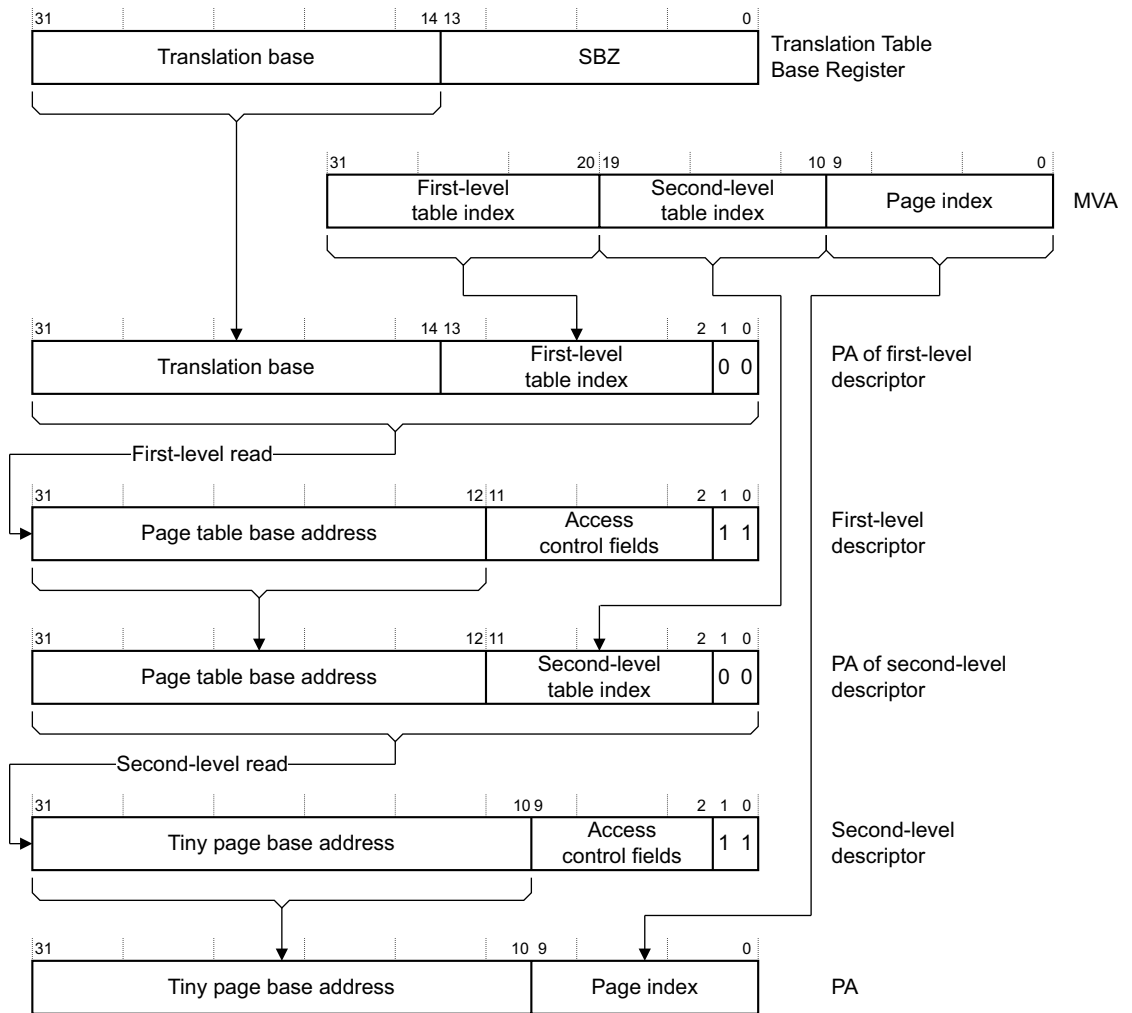

Figure O-1 Tiny page address translation, VMSAv5 and VMSAv4 only

## O.6.4 Protected memory support

The MPU based *Protected Memory System Architecture* (PMSA) is a much simpler memory protection scheme than the MMU-based VMSA model described in *Virtual memory support* on page AppxO-2604. The simplification applies to both the hardware and the software. PMSA in ARMv4 and ARMv5 differs from that supported in ARMv6 and ARMv7 in the following ways:

- the programming model is unique to ARMv4 and ARMv5
- the supported number of memory regions is fixed
- background memory support requires use of a region resource
- there is no architecturally-defined recovery mechanism from memory aborts
- there is no default memory map definition.

### Control and configuration

Software can use CP15 registers to fully define *protection regions*, eliminating the VMSA requirements for hardware to do translation table walks, and for software to set up and maintain the translation tables. This makes memory checking fully deterministic. However, the level of control is now region based rather than page based. This means the control is not as fine-grained.

The following features apply:

- The memory is divided into regions. CP15 registers can define the region size, base address, and memory attributes. For example, cacheability, bufferability, and access permissions of a region.
- Memory region control (read and write access) is permitted only from PL1 modes.
- If an address is defined in multiple regions, a fixed priority scheme (highest region number) defines the properties of the address being accessed.
- An access to an address that is not defined in any region causes a memory abort.
- All addresses are physical addresses. Address translation is not supported.
- PMSA supports unified (von Neumann) and separate (Harvard) instruction and data address spaces.

Eight regions can be configured, with C, B, and AP[1:0] attribute bits associated with each region. The supported region sizes are 2<sup>N</sup>KB, where 2 ≤ N ≤ 32. It is IMPLEMENTATION DEFINED if the regions are configurable or fixed in an implementation:

- as eight unified regions supporting data accesses and instruction fetches
- as eight data regions and eight instruction regions each with independent memory region attributes.

CP15 provides the following support:

- a global MPU enable bit, [SCTLR.M](#)
- cacheability register support, a C bit for each region
- bufferability register support, a B bit for each region
- access permission register support that provides AP7[1:0] to AP0[1:0] 2-bit permission fields, an AP field for each region
- optional extended access permission register support for 4-bit AP fields
- region registers providing a base address, size field, and an enable bit for each region.

For details of the PMSA support in CP15 see [CP15 c2, c3, c5, and c6, PMSA support](#) on page AppxO-2622.

The C and B bits are configured according to the type of memory that is to be accessed. For more information, see [Memory type support on page AppxO-2593](#). [Table O-11](#) defines the standard AP bit behavior.

**Table O-11 PMSA access permissions in ARMv4 and ARMv5**

AP[1:0]	PL1 permissions	User permissions	Description
00	No access	No access	All accesses generate Permission faults
01	Read/write	No access	PL1 access only
10	Read/write	Read-only	Writes in User mode generate Permission faults
11	Read/write	Read/write	Full access

Some implementations also include support for read-only access permission. [Table O-12](#) defines the extended AP bit behavior.

**Table O-12 PMSA extended access permissions in ARMv4 and ARMv5**

AP[3:0]	PL1 permissions	User permissions	Description
0000	No access	No access	All accesses generate a Permission fault
0001	Read/write	No access	PL1 access only
0010	Read/write	Read-only	Writes in User mode generate a Permission fault
0011	Read/write	Read/write	Full access
0100	UNPREDICTABLE	UNPREDICTABLE	-
0101	Read-only	No access	PL1 read-only access
0110	Read-only	Read-only	Read-only access
0111	UNPREDICTABLE	UNPREDICTABLE	-
1xxx	UNPREDICTABLE	UNPREDICTABLE	-

### Memory access sequence

When the ARM processor generates a memory access, the MPU compares the memory address with the programmed memory regions as follows:

- If a matching memory region is not found, a memory abort is signaled to the processor.
- If a matching memory region is found, the region information is used as follows:
  - The access permission bits determine whether the access is permitted. If the access is not permitted, the MPU signals a memory abort. Otherwise, the access can proceed.
  - The memory region attributes determine the access attributes, for example cacheable or non-cacheable, as described in [Memory type support on page AppxO-2593](#).

———— **Note** —————

When a Permission fault occurs, there is no fault status information provision for PMSA in ARMv4 or ARMv5. The CP15 registers FSR and FAR are only available in implementations with VMSA support.

### **Overlapping regions**

The Protection Unit can be programmed with two or more overlapping regions. When overlapping regions are programmed, a fixed priority scheme is applied to determine the region whose attributes are applied to the memory access.

Attributes for region 7 take highest priority and those for region 0 take lowest priority. For example:

- Data region 2 is programmed to be 4KB in size, starting from address 0x3000 with AP == 0b010 (PL1 modes full access, User mode read-only).
- Data region 1 is programmed to be 16KB in size, starting from address 0x0 with AP == 0b001 (PL1 modes access only).

When the processor performs a data load from address 0x3010 while in User mode, the address falls into both region 1 and region 2. Because there is a clash, the attributes associated with region 2 are applied. In this case, the load would not abort.

### **Background region**

Overlapping regions increase the flexibility of how regions can be mapped onto physical memory devices in the system. The overlapping properties can also specify a background region. For example, assume a number of physical memory areas sparsely distributed across the 4GB address space. If only these regions are configured, any access outside the defined sparse address space aborts. You can override this behavior by programming region 0 to be a 4GB background region. In this case, if the address does not fall into any of the other regions, the access is controlled by the attributes specified for region 0.

## O.7 System Control coprocessor, CP15 support

Before ARMv6, it is IMPLEMENTATION DEFINED whether a System Control coprocessor, CP15, is implemented. However, support of ID registers, control registers, cache support, and memory management with virtual or protected memory support resulted in the widespread adoption of a standard for control and configuration of these features. That standard is described here. With the exception of a small number of operations and supporting registers, for example the memory barrier operations described in [CP15 c7, Miscellaneous functions on page AppxO-2629](#), all CP15 accesses require PL1 access.

The following sections summarize the CP15 registers known to have been supported in ARMv4 or ARMv5 implementations:

- [Organization of CP15 registers in an ARMv4 or ARMv5 VMSA implementation on page AppxO-2613](#)
- [Organization of CP15 registers in an ARMv4 or ARMv5 PMSA implementation on page AppxO-2614](#).

For details of the registers provided by a particular implementation see the appropriate Technical Reference Manual, or other product documentation.

The rest of this section describes the ARMv4 and ARMv5 CP15 support in order of the CRn value.

———— **Note** —————

Definitions of CP15 registers in this appendix apply to both VMSA and PMSA implementations unless otherwise indicated.

—————



### O.7.1 Organization of CP15 registers in an ARMv4 or ARMv5 VMSA implementation

Figure O-2 shows the CP15 registers in a VMSAv4 or VMSAv5 implementation:

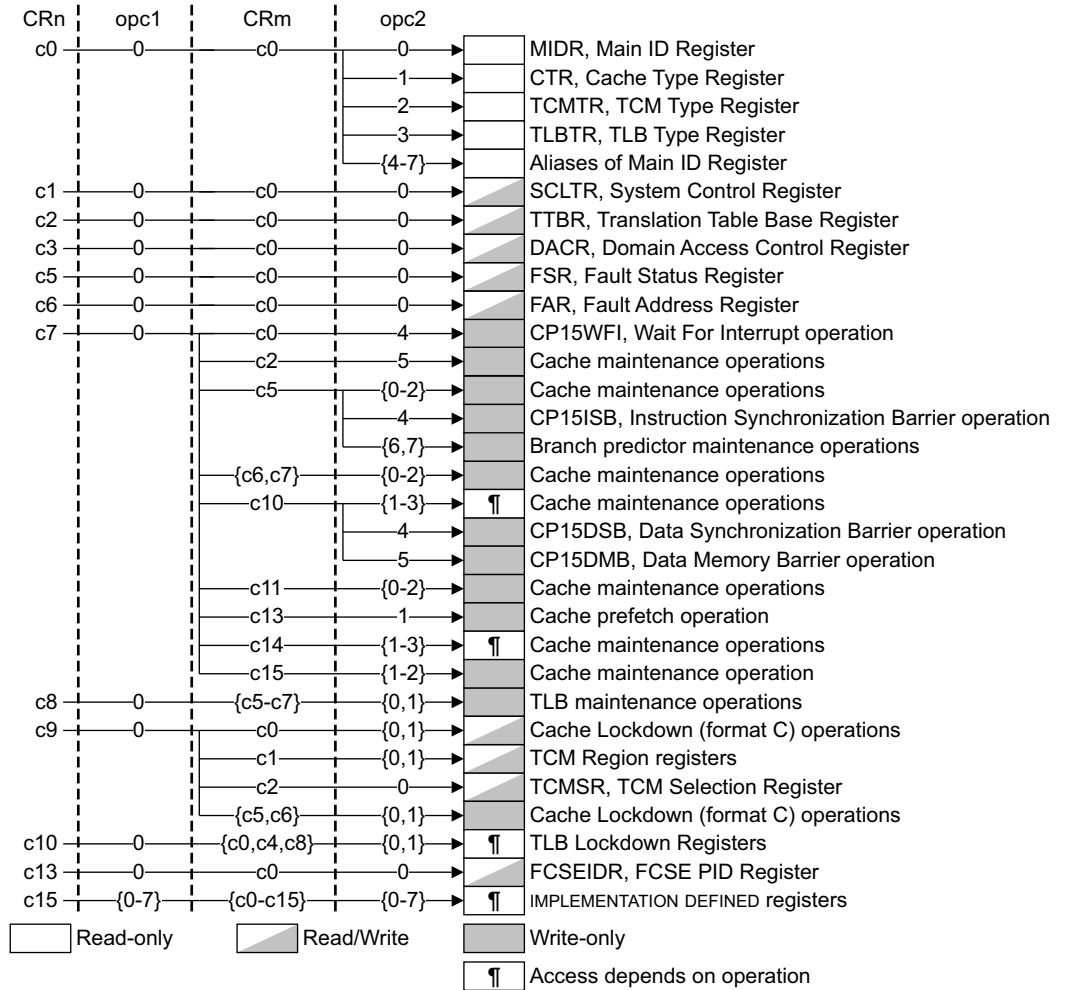

Figure O-2 CP15 registers in a VMSAv4 or VMSAv5 implementation

### O.7.2 Organization of CP15 registers in an ARMv4 or ARMv5 PMSA implementation

Figure O-3 shows the CP15 registers in a PMSAv4 or PMSAv5 implementation:

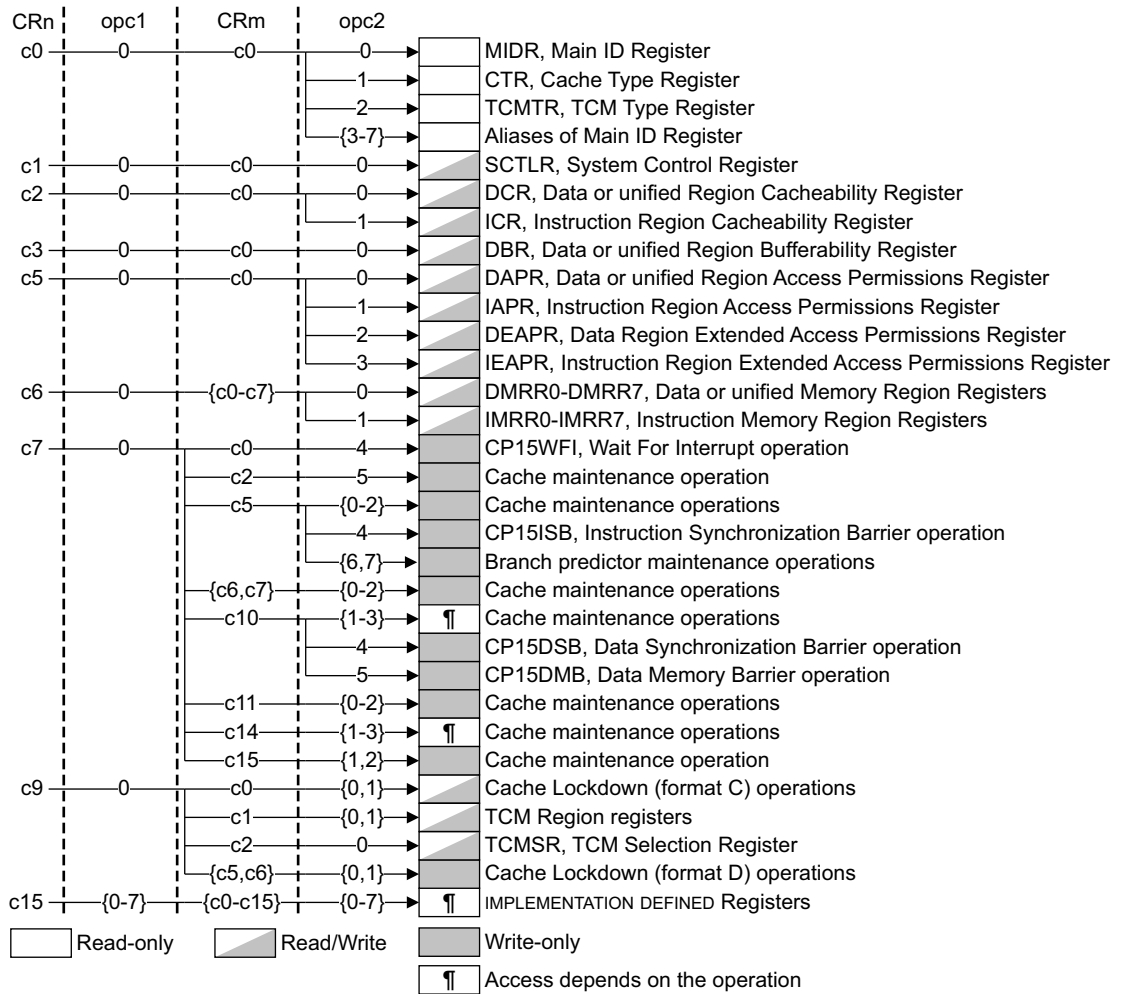

Figure O-3 CP15 registers in a PMSAv4 or PMSAv5 implementation

### O.7.3 CP15 c0, ID support

ARMv4 and ARMv5 implementations support the following ID registers:

- *Main ID Register*, see [CP15 c0, Main ID Register, MIDR, ARMv4 and ARMv5 differences](#).
- *Cache Type Register*, see [CP15 c0, Cache Type Register, CTR, ARMv4 and ARMv5](#).
- Optionally, the *TCM Type Register*, see [CP15 c0, TCM Type Register, TCMTR on page AppxO-2618](#).

Table O-13 shows how these read-only registers are accessed using the MRC instruction.

Table O-13 ID register support

Register	Description	CRn	opc1	CRm	opc2
<a href="#">MIDR</a>	Main ID Register	c0	0	c0	0
<a href="#">CTR</a>	Cache Type ID Register	c0	0	c0	1
<a href="#">TCMTR</a>	TCM Type Register	c0	0	c0	2
-	Aliases of <a href="#">MIDR</a>	c0	0	c0	3, 4, 5, 6, 7

#### CP15 c0, Main ID Register, MIDR, ARMv4 and ARMv5 differences

This register is as described for ARMv7 if either:

- the implementer code in MIDR bits[31:24] is not 0x41
- the top four bits of the primary part number in MIDR bits[15:4] are neither 0x0 nor 0x7.

If the implementer code is 0x41 and the top four bits of the primary part number are 0x0, the processor is an obsolete ARMv2 or ARMv3 processor.

If the implementer code is 0x41 and the top four bits of the primary part number are 0x7, then:

- If bit[23] is 0, the processor is an obsolete ARMv3 processor.
- If bit[23] is 1, the processor is an ARMv4T processor and bits[22:16] are an IMPLEMENTATION DEFINED variant number. Bits[31:24, 15:0] are as described for ARMv7.

For the ARMv7 descriptions of the MIDR see:

- [MIDR, Main ID Register, VMSA on page B4-1648](#) for a VMSA implementation
- [MIDR, Main ID Register, PMSA on page B6-1892](#) for a PMSA implementation.

#### CP15 c0, Cache Type Register, CTR, ARMv4 and ARMv5

The format of the Cache Type Register is significantly different from the ARMv7 definition. However, the general properties described by the register, and the access rights for the register, are unchanged. For the ARMv7 definition see:

- [CTR, Cache Type Register, VMSA on page B4-1556](#) for a VMSA implementation
- [CTR, Cache Type Register, PMSA on page B4-1556](#) for a PMSA implementation

This section describes the implementation of the CP15 c0 Cache Type Register and is applicable to a VMSA or PMSA implementation.

The Cache Type Register supplies the following details about the level 1 cache implementation:

- whether there is a unified cache or separate instruction and data caches
- the cache size, line length, and associativity
- whether it is a write-through cache or a write-back cache
- the cache cleaning and lockdown capabilities.

The Cache Type Register bit assignments are:

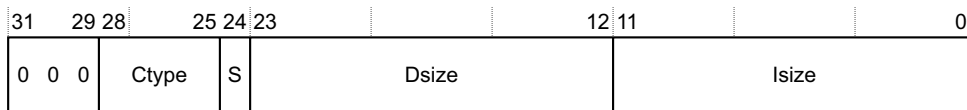

**Bits[31:29]** Set to 0b000 before ARMv7.

**Ctype, bits[28:25]**

Cache type field. Specifies details of the cache not indicated by the S bit and the Dsize and Isize fields. [Table O-14](#) shows the encoding of this field. All values not specified in the table are reserved.

**S, bit[24]** Separate caches bit. The meaning of this bit is:

- 0** Unified cache
- 1** Separate instruction and data caches.

If S == 0, the Isize and Dsize fields both describe the unified cache, and must be identical.

**Dsize, bits[23:12]**

Specifies the size, line length and associativity of the data cache, or of the unified cache if S == 0. For details of the encoding see [Cache size fields on page AppxO-2617](#).

**Isize, bits[11:0]**

Specifies the size, line length and associativity of the instruction cache, or of the unified cache if S == 0. For details of the encoding see [Cache size fields on page AppxO-2617](#).

[Table O-14](#) shows the Ctype values that can be used in the CTR:

**Table O-14 Cache type values**

Ctype <sup>a</sup>	Cache method	Cache lockdown <sup>b</sup>
0b0000	Write-through	Not supported
0b0010	Write-back	Not supported
0b0101	Write-back	Format D
0b0110 <sup>c</sup>	Write-back	Format A
0b0111 <sup>c</sup>	Write-back	Format B
0b1110	Write-back	Format C

- a. Ctype values not shown are reserved and must not be used.
- b. For details see [CP15 c9, cache lockdown support on page AppxO-2630](#).
- c. In ARMv6 this Ctype value is reserved and must not be used.

For details of the CP15 c7 operations used for cleaning write-back caches see [CP15 c7, Cache and branch predictor operations on page AppxO-2628](#).

### Cache size fields

The Dsize and Isize fields in the CTR have the same format:

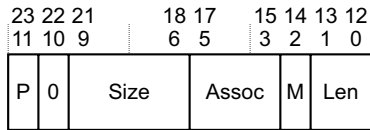

- P** For a VMSA implementation, indicates whether the allocation of bits[13:12] of the virtual address is restricted, imposing the *page coloring* restriction. The meaning of this field is:
- 0** No restriction, or PMSA implementation
  - 1** Page coloring restriction applies, see [Virtual to physical translation mapping restrictions on page AppxL-2521](#).
- Size** Indicates the size of the cache, but is qualified by the M bit, see [Table O-15](#).
- Assoc** Indicates the associativity of the cache, but is qualified by the M bit, see [Cache associativity on page AppxO-2618](#).
- M** Qualifies the values in the Size and Assoc subfields.
- Len** Specifies the line length of the cache. The possible values of this field are:
- 0b00** Line length is 2 words (8 bytes)
  - 0b01** Line length is 4 words (16 bytes)
  - 0b10** Line length is 8 words (32 bytes)
  - 0b11** Line length is 16 words (64 bytes).

[Table O-15](#) shows how the size of the cache is determined by the Size field and M bit.

**Table O-15 Cache sizes**

Size field	Size if M == 0	Size if M == 1
0b0000	0.5KB	0.75KB
0b0001	1KB	1.5KB
0b0010	2KB	3KB
0b0011	4KB	6KB
0b0100	8KB	12KB
0b0101	16KB	24KB
0b0110	32KB	48KB
0b0111	64KB	96KB
0b1000	128KB	192KB

### Cache associativity

Table O-16 show how the associativity of the cache is determined by the Assoc field and the M bit.

**Table O-16 Cache associativity**

Assoc field	Associativity if:	
	M == 0	M == 1
0b000	1 way (direct mapped)	Cache absent
0b001	2 way	3 way
0b010	4 way	6 way
0b011	8 way	12 way
0b100	16 way	24 way
0b101	32 way	48 way
0b110	64 way	96 way
0b111	128 way	192 way

The Cache absent encoding overrides all other data in the cache size field.

Excluding the cache absent case (Assoc == 0b000, M == 1) you can use the following formulae to determine the values LINELEN, ASSOCIATIVITY, and NSETS (number of sets) from the Size, Assoc and Len fields of the CTR. These formulae give the associativity values shown in Table O-16:

```

LINELEN      = 1 << (Len+3)          /* In bytes */
MULTIPLIER   = 2 + M
NSETS        = 1 << (Size + 6 - Assoc - Len)
ASSOCIATIVITY = MULTIPLIER << (Assoc - 1)
    
```

Multiplying these together gives the overall cache size as:

```

CACHE_SIZE   = MULTIPLIER << (Size+8) /* In bytes */
    
```

———— **Note** —————

Cache length fields with (Size + 6 - Assoc - Len) < 0 are invalid, because they correspond to impossible combinations of line length, associativity, and overall cache size. So the formula for NSETS never involves a negative shift value.

### CP15 c0, TCM Type Register, TCMTR

In an ARMv4 or ARMv5 implementation that supports CP15 and TCM, the TCMTR is an optional register. For details of the TCMTR implementation see *CP15 c0, TCM Type Register, TCMTR, ARMv6 on page AppxL-2527*.

## O.7.4 CP15 c1, System control register support

ARMv4 and ARMv5 implementations support the following system control registers:

- a System Control Register, see *CP15 c1, System Control Register, SCTLR, ARMv4 and ARMv5*
- an IMPLEMENTATION DEFINED Auxiliary Control Register, *ACTLR*.

Table O-17 shows how the registers are accessed using the MCR and MRC instructions.

**Table O-17 System control register support**

Register	Description	CRn	opc1	CRm	opc2
<a href="#">SCTLR</a>	System Control Register	c1	0	c0	0
<a href="#">ACTLR</a>	Auxiliary Control Register	c1	0	c0	1

[SCTLR](#) is the primary system configuration register in CP15.

### CP15 c1, System Control Register, SCTLR, ARMv4 and ARMv5

This section describes the implementation of the System Control Register, SCTL, for ARMv4 and ARMv5. The SCTL bit assignments are:

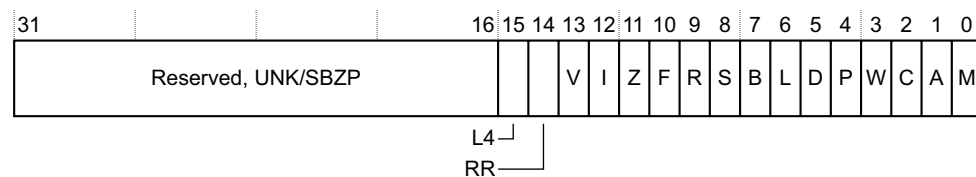

**Bits[31:16]** Reserved, UNK/SBZP.

These reserved bits in the [SCTLR](#) are allocated in some circumstances:

- bits[19:16] can be associated with TCM support
- bit[26], described as the L2 bit, can indicate level 2 cache support, see [Level 2 cache support on page AppxO-2629](#).

These usage models are not compatible with ARMv7.

**L4, Bit[15]** This bit inhibits ARMv5T Thumb interworking behavior when set. It stops bit[0] updating the [CPSR.T](#) bit. From ARMv6, ARM deprecates any use of the feature. ARMv7 does not support this feature.

**RR, bit[14]** Round Robin bit. This bit selects an alternative replacement strategy with a more easily predictable worst-case performance if the cache implementation supports this functionality:

- 0** Normal replacement strategy, for example random replacement
- 1** Predictable strategy, for example round robin replacement.

The replacement strategy associated with each value of the RR bit is IMPLEMENTATION DEFINED.

**V, bit[13]** Vectors bit. This bit selects the base address of the exception vectors:

- 0** Low exception vectors, base address `0x00000000`
- 1** High exception vectors (Hivecs), base address `0xFFFF0000`.

This base address is never remapped.

Support of the V bit is IMPLEMENTATION DEFINED. An implementation can include a configuration input signal that determines the reset value of the V bit. If there is no configuration input signal to determine the reset value of this bit, it resets to 0.

- I, bit[12]** Instruction cache enable bit. This is a global enable bit for instruction caches:
- 0** Instruction caches disabled
  - 1** Instruction caches enabled.
- If the system does not implement any instruction caches that can be accessed by the processor at any level of the memory hierarchy, this bit is RAZ/WI.
- If the system implements any instruction caches that can be accessed by the processor then it must be possible to disable them by setting this bit to 0.
- Z, bit[11]** Branch prediction enable bit. This bit enables branch prediction, also called program flow prediction:
- 0** program flow prediction disabled
  - 1** program flow prediction enabled.
- If program flow prediction cannot be disabled, this bit is RAO/WI. Program flow prediction includes all possible forms of speculative change of instruction stream prediction. Examples include static prediction, dynamic prediction, and return stacks.
- If the implementation does not support program flow prediction this bit is RAZ/WI.
- F, bit[10]** The meaning of this bit is IMPLEMENTATION DEFINED.
- R, bit[9]** ROM protection bit, supported for backwards compatibility. The effect of this bit is described in [Table O-7 on page AppxO-2605](#). From ARMv6 ARM deprecates any use of this feature, and ARMv7 does not support this feature.
- S, bit[8]** System protection bit, supported for backwards compatibility. The effect of this bit is described in [Table O-7 on page AppxO-2605](#). From ARMv6, ARM deprecates any use of this feature. and ARMv7 does not support this feature.
- B, bit[7]** This bit configures the ARM processor to the endianness of the memory system:
- 0** Little-endian memory system (LE)
  - 1** Big-endian memory system (BE-32).
- ARM processors that support both little-endian and big-endian memory systems use this bit to configure the ARM processor to rename the four byte addresses in a 32-bit word.
- Endian support changed in ARMv6. From ARMv6, ARM deprecates any use of this feature, and ARMv7 does not support this feature.
- An implementation can include a configuration input signal that determines the reset value of the B bit. If there is no configuration input signal to determine the reset value of this bit then it resets to 0.
- Bits[6:4]** RAO/SBOP.
- W, bit[3]** This is the enable bit for the write buffer:
- 0** Write buffer disabled
  - 1** Write buffer enabled.
- If the write buffer is not implemented, this bit is RAZ/WI. If the write buffer cannot be disabled, this bit is RAO and ignores writes. From ARMv6, ARM deprecates any use of this feature. ARMv7 does not support this feature.
- C, bit[2]** Cache enable bit. This is a global enable bit for data and unified caches:
- 0** Data and unified caches disabled
  - 1** Data and unified caches enabled.
- If the system does not implement any data or unified caches that can be accessed by the processor at any level of the memory hierarchy, this bit is RAZ/WI.
- If the system implements any data or unified caches that can be accessed by the processor then it must be possible to disable them by setting this bit to 0.



- A, bit[1]** Alignment bit. This is the enable bit for Alignment fault checking:  
**0** Alignment fault checking disabled  
**1** Alignment fault checking enabled.  
For more information, see *Alignment* on page AppxO-2590.
- M, bit[0]** Memory control bit. This is a global enable bit to enable an MMU where VMSA is supported, or an MPU where PMSA is supported:  
**0** memory management (MMU or MPU) disabled  
**1** memory management (MMU or MPU) enabled.

### O.7.5 CP15 c2 and c3, VMSA memory protection and control registers

ARMv4 and ARMv5 support a single Translation Table Base Register, TTBR, that is compatible with the ARMv7 **TTBR0**, and the *Domain Access Control Register*, **DACR**.

The TTBR is as defined for the 32-bit **TTBR0** for an implementation that does not include the Multiprocessing Extensions, except that:

- The base address field is a fixed-length field, bits[31:14] (N=0)
- Bit[5] is reserved.

### O.7.6 CP15 c5 and c6, VMSA memory system support

ARMv4 and ARMv5 support a *Fault Status Register* (FSR) and a *Fault Address Register* (FAR). These registers are accessed using MCR and MRC instructions. [Table O-18](#) summarizes them.

**Table O-18 VMSA fault support**

Register	Description	CRn	opc1	CRm	opc2
<b>FSR</b>	Fault Status Register	c5	0	c0	0
<b>FAR</b>	Fault Address Register	c6	0	c0	0

The **FSR** is updated on Prefetch Abort exceptions and Data Abort exceptions.

The **FAR** is equivalent to the ARMv7 **DFAR**, and is only updated with the MVA on Data Abort exceptions.

### CP15 c5, Fault Status Register, FSR, ARMv4 and ARMv5

In ARMv5 and ARMv4 implementations the FSR bit assignments are:

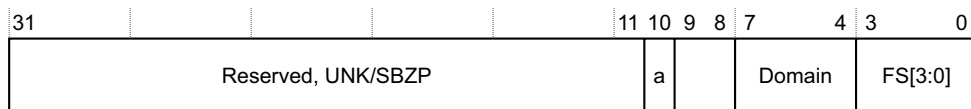

a. It is IMPLEMENTATION DEFINED whether bit[10] is reserved or is an additional fault status bit, FS[4].

#### Bits[31:11, 9:8]

Reserved, UNK/SBZP.

#### Bit[10]

FS[4] where defined, otherwise reserved, UNK/SBZP.

#### Domain, bits[7:4]

The domain of the fault address.

#### FS, bits[3:0]

Fault status bits. Indicate the cause of the fault.

Table O-19 lists the base level of fault status encodings returned in the FSR

**Table O-19 VMSAv5 and VMSAv4 FSR encodings**

FSR[10]	FSR[3:0]	Source of fault		Domain
0	00x1	Alignment fault		Invalid
0	0101	Translation fault	Section	Invalid
	0111		Page	Valid
0	1001	Domain fault	Section	Valid
	1011		Page	Valid
0	1100	Translation table walk External Abort	First level	Invalid
	1110		Second level	Valid
0	1101	Permission fault	Section	Valid
	1111		Page	Valid
0	0xx0	IMPLEMENTATION DEFINED <sup>a</sup>		-
	10x0			
1	xxxx	IMPLEMENTATION DEFINED <sup>a</sup>		-

a. ARM recommends that any additional codes are compatible with those defined for ARMv6 and ARMv7 as described in Table B3-23 on page B3-1415.

### O.7.7 CP15 c2, c3, c5, and c6, PMSA support

While the general principles for memory protection in ARMv4 and ARMv5 are the same, CP15 support for protected memory is different from the programming model of ARMv6 and ARMv7. Memory regions have configurable base address and size attributes. Other registers define cacheability, bufferability, and access permissions across the regions. For more information, see [Memory model and memory ordering on page AppxO-2593](#).

ARMv4 and ARMv5 support a fixed number of memory regions, either:

- eight unified memory regions
- eight data and eight instruction regions.

Table O-20 shows the PMSA register support.

**Table O-20 PMSA register support**

Register	Description	CRn	opc1	CRm	opc2
DCR, see <a href="#">xCR</a>	Data or unified Cacheability Register	c2	0	c0	0
ICR, see <a href="#">xCR</a>	Instruction Cacheability Register	c2	0	c0	1
<a href="#">DBR</a>	Data or unified Bufferability Register	c3	0	c0	0
DAPR, see <a href="#">xAPR</a>	Data or unified Access Permission Register	c5	0	c0	0
IAPR, see <a href="#">xAPR</a>	Instruction Access Permission Register	c5	0	c0	1
DEAPR, see <a href="#">xEAPR</a>	Data or unified Extended Access Permission Register	c5	0	c0	2
IEAPR, see <a href="#">xEAPR</a>	Instruction Extended Access Permission Register	c5	0	c0	3



### CP15 c3, Memory Region Bufferability Register, DBR, ARMv4 and ARMv5

The Memory Region Bufferability Register, DBR, holds Bufferability bit, B, for each of the eight data or unified memory protection regions.

Only data accesses are bufferable and therefore there is only a single Memory Region Bufferability Register, regardless of whether the implementation has a single set of protection regions, or separate protection region definitions for instruction and data accesses.

The DBR bit assignments are:

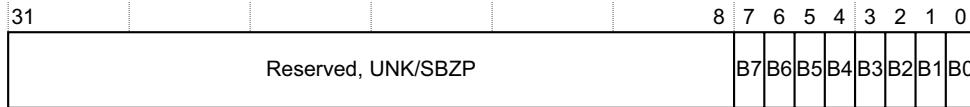

**Bits[31:8]** Reserved, UNK/SBZP.

**Bn, bit[n], for n = 0 to 7**

Bufferability bit, B, for memory protection region n.

#### Accessing the Memory Region Bufferability Register

To access the Memory Region Bufferability Register, read or write the CP15 registers with <opc1> set to 0, <CRn> set to c3, <CRm> set to c0, and <opc2> set to 0. For example:

MRC p15, 0, <Rt>, c3, c0, 0 ; Read CP15 Data or unified Region Bufferability Register  
 MCR p15, 0, <Rt>, c3, c0, 0 ; Write CP15 Data or unified Region Bufferability Register

### CP15 c5, Memory Region Access Permissions Registers, DAPR and IAPR, ARMv4 and ARMv5

The two Memory Region Access Permissions Registers are:

- The Data or unified Access Permissions Register, DAPR.
- The Instruction Access Permissions Register, IAPR. The IAPR is implemented only when the implementation includes separate data and instruction memory protection region definitions.

A Memory Region Access Permissions Register hold the access permission bits AP[1:0] for each of the eight memory protection regions.

The format of an xAPR is:

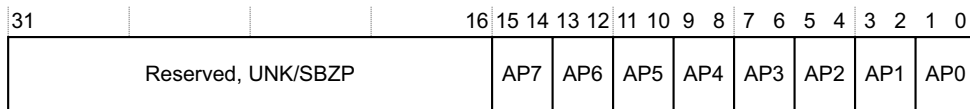

**Bits[31:16]** Reserved, UNK/SBZP.

**APn, bits[2n+1:2n], for n = 0 to 7**

Access permission bits AP[1:0] for memory protection region n.

For details of the significance and encoding of these bits see [Table O-11 on page AppxO-2610](#).

If the implementation does not permit the requested type of access, it signals an abort to the processor.

### Accessing the Memory Region Access Permissions Registers

To access the Memory Region Access Permissions Registers, read or write the CP15 registers with <opc1> set to 0, <CRn> set to c5, <CRm> set to c0, and <opc2> set as follows:

- 0 if there is only a single set of protection regions
- when there are separate memory protection regions for data and instructions:
  - 0 to access the Data Region Access Permissions Register
  - 1 to access the Instruction Region Access Permissions Register.

For example:

```
MRC p15, 0, <Rt>, c5, c0, 0 ; Read CP15 Data or unified Region Access Permissions Register
MCR p15, 0, <Rt>, c5, c0, 0 ; Write CP15 Data or unified Region Access Permissions Register
MRC p15, 0, <Rt>, c5, c0, 1 ; Read CP15 Instruction Region Access Permissions Register
MCR p15, 0, <Rt>, c5, c0, 1 ; Write CP15 Instruction Region Access Permissions Register
```

### CP15 c5, Memory Region Extended Access Permissions Registers, DEAPR and IEAPR, ARMv4 and ARMv5

The two Memory Region Extended Access Permissions Registers are:

- The Data or unified Extended Access Permissions Register, DEAPR.
- The Instruction Extended Access Permissions Register, IEAPR. The IEAPR is implemented only when the implementation includes separate data and instruction memory protection region definitions.

Whether an implementation includes Extended Access Permissions Registers is IMPLEMENTATION DEFINED.

An xEAPR hold the access permission bits AP[3:0] for each of the eight memory protection regions.

The format of an xEAPR is:

31	28	27	24	23	20	19	16	15	12	11	8	7	4	3	0								
AP7			AP6			AP5			AP4			AP3			AP2			AP1			AP0		

#### APn, bits[4n+3:4n], for n = 0 to 7

Access permission bits AP[3:0] for memory protection region n.

For details of the significance of these bits see [Table O-12 on page AppxO-2610](#).

If the implementation does not permit the requested type of access, it signals an abort to the processor.

### Accessing the Memory Region Extended Access Permissions Registers

To access the Memory Region Extended Access Permissions Registers, read or write the CP15 registers with <opc1> set to 0, <CRn> set to c5, <CRm> set to c0, and <opc2> set as follows:

- 2 if there is only a single set of protection regions
- when there are separate memory protection regions for data and instructions:
  - 2 to access the Data Region Extended Access Permissions Register
  - 3 to access the Instruction Region Extended Access Permissions Register.

For example:

```
MRC p15, 0, <Rt>, c5, c0, 2 ; Read CP15 Data or unified Region Extended Access Permissions Register
MCR p15, 0, <Rt>, c5, c0, 2 ; Write CP15 Data or unified Region Extended Access Permissions Register
MRC p15, 0, <Rt>, c5, c0, 3 ; Read CP15 Instruction Region Extended Access Permissions Register
MCR p15, 0, <Rt>, c5, c0, 3 ; Write CP15 Instruction Region Extended Access Permissions Register
```



**Table O-21 MPU Region size encoding (continued)**

Encoding	Region size	Base address constraints
0b10111	16MB	Register bits[23:12] must be zero
0b11000	32MB	Register bits[24:12] must be zero
0b11001	64MB	Register bits[25:12] must be zero
0b11010	128MB	Register bits[26:12] must be zero
0b11011	256MB	Register bits[27:12] must be zero
0b11100	512MB	Register bits[28:12] must be zero
0b11101	1G	Register bits[29:12] must be zero
0b11110	2GB	Register bits[30:12] must be zero
0b11111	4GB	Register bits[31:12] must be zero

Encodings not shown in the table are reserved. The effect of using a reserved value in this field is UNPREDICTABLE.

**En, bit[0]** Enable bit for the region:  
**0** Region is disabled  
**1** Region is enabled.

This field resets to zero. Therefore all MPU regions are disabled on reset.

The base address constraints given in [Table O-21 on page AppxO-2626](#) ensure that the specified region is correctly aligned in memory, so that its alignment is a multiple of the region size. If a base address is entered that does not follow these alignment constraints, behavior is UNPREDICTABLE.

### Accessing the Region Access Permissions registers

To access the Region Access Permissions registers, read or write the CP15 registers with <opc1> set to 0, <CRn> set to c5, and:

- <CRm> set to indicate the region number, from <CRm> == c0 for memory region 0, to <CRm> == c7 for memory region 7
- <opc2> set to:
  - 0 if there is only a single set of protection region definitions
  - 0 to access the Data Region Access Permissions Register when the data and instruction memory regions are defined separately
  - 1 to access the Instruction Region Access Permissions Register when the data and instruction memory regions are defined separately.

For example:

```
MRC p15, 0, <Rt>, c6, c0, 0 ; Read CP15 Data or unified Region Register, Region 0
MCR p15, 0, <Rt>, c6, c0, 0 ; Write CP15 Data or unified Region Register, Region 0
MRC p15, 0, <Rt>, c6, c1, 0 ; Read CP15 Data or unified Region Register, Region 1
MCR p15, 0, <Rt>, c6, c1, 0 ; Write CP15 Data or unified Region Register, Region 1
MRC p15, 0, <Rt>, c6, c2, 1 ; Read CP15 Instruction Memory Region Register, Region 2
MCR p15, 0, <Rt>, c6, c2, 1 ; Write CP15 Instruction Memory Region Register, Region 2
```

## O.7.8 CP15 c7, Cache and branch predictor operations

Table O-22 shows the cache operation provision in ARMv4 and ARMv5. All cache operations are performed as MCR instructions and only operate on a level 1 cache associated with a specific processor. The equivalent operations in ARMv7 operate on multiple levels of cache. See *Cache and branch predictor maintenance operations, VMSA* on page B4-1740.

**Table O-22 Cache operation support**

Operation	CRn	opc1	CRm	opc2
Invalidate instruction cache <sup>a</sup>	c7	0	c5	0
Invalidate instruction cache line by MVA <sup>a</sup>	c7	0	c5	1
Invalidate instruction cache line by set/way	c7	0	c5	2
Invalidate all branch predictors <sup>a</sup>	c7	0	c5	6
Invalidate branch predictor entry by MVA <sup>a</sup>	c7	0	c5	7
Invalidate data cache	c7	0	c6	0
Invalidate data cache line by MVA <sup>a</sup>	c7	0	c6	1
Invalidate data cache line by set/way <sup>a</sup>	c7	0	c6	2
Invalidate unified cache, or instruction cache and data cache	c7	0	c7	0
Invalidate unified cache line by MVA	c7	0	c7	1
Invalidate unified cache line by set/way	c7	0	c7	2
Clean data cache line by MVA <sup>a</sup>	c7	0	c10	1
Clean data cache line by set/way <sup>a</sup>	c7	0	c10	2
Clean entire unified cache	c7	0	c11	0
Clean unified cache line by MVA <sup>a</sup>	c7	0	c11	1
Clean unified cache line by set/way	c7	0	c11	2
Prefetch instruction cache line by MVA <sup>b</sup>	c7	0	c13	1
Clean and Invalidate data cache line by MVA <sup>a</sup>	c7	0	c14	1
Clean and Invalidate data cache line by set/way <sup>a</sup>	c7	0	c14	2
Clean and Invalidate unified cache line by MVA	c7	0	c15	1
Clean and Invalidate unified cache line by set/way	c7	0	c15	2
Test and Clean data cache	c7	0	c10	3
Test and Clean and Invalidate data cache	c7	0	c14	3

- a. These are the only cache operations available in ARMv7. The corresponding ARMv7 operations are multi-level operations, and the data cache operations are defined as data or unified cache operations.
- b. Used with TLB lockdown. See *TLB lockdown procedure, using the by entry model* on page AppxO-2637.



## Test and clean operations

This scheme provides an efficient way to clean, or clean and invalidate, a complete data cache by executing an MRC instruction with the condition flags as the destination. A global cache dirty status bit is written to the Z flag. How many lines are tested in each iteration of the instruction is IMPLEMENTATION DEFINED.

To clean an entire data cache with this method the following software loop can be used:

```
tc_loop MRC p15, 0, APSR_nzcv, c7, c10, 3 ; test and clean
        BNE tc_loop
```

To clean and invalidate an entire data cache with this method, the following software loop can be used:

```
tci_loop MRC p15, 0, APSR_nzcv, c7, c14, 3 ; test, clean and invalidate
        BNE tci_loop
```

## Level 2 cache support

The recommended method for adding closely coupled level 2 cache support from ARMv5TE is to define equivalent operations to the level 1 support with <opc1> == 1 in the appropriate MCR instructions. The operations in [Table O-22 on page AppxO-2628](#) that are supported are IMPLEMENTATION DEFINED.

### O.7.9 CP15 c7, Miscellaneous functions

The Wait For Interrupt operation is used in some implementations as part of a power management support scheme. From ARMv6, ARM deprecates any use of this operation. ARMv7 does not support this operation, and it behaves as a NOP instruction.

Barrier operations are used for system correctness to ensure visibility of memory accesses to other agents in a system. For ARMv4 and ARMv5 the requirement for and use of barrier operations is IMPLEMENTATION DEFINED. Barrier functionality is formally defined as part of the memory architecture enhancements introduced in ARMv6.

[Table O-23](#) summarizes the MCR instruction encoding details.

**Table O-23 Memory barrier register support**

Operation	Description	CRn	opc1	CRm	opc2
CP15WFI	Wait For Interrupt	c7	0	c0	4
<a href="#">CP15ISB</a>	Instruction Synchronization Barrier <sup>a</sup>	c7	0	c5	4
<a href="#">CP15DSB</a>	Data Synchronization Barrier <sup>b</sup>	c7	0	c10	4
<a href="#">CP15DMB</a>	Data Memory Barrier	c7	0	c10	5

a. This operation was previously called *Prefetch Flush* (PF or PFF).

b. This operation was previously called *Data Write Barrier* or *Drain Write Buffer* (DWB).

### O.7.10 CP15 c8, VMSA TLB support

Table O-24 illustrates TLB operation provision in ARMv4 and ARMv5. All TLB operations are performed as MCR instructions and are a subset of the operations available in ARMv7. See *TLB maintenance operations, not in Hyp mode* on page B4-1743.

**Table O-24 TLB operation support**

Operation	CRn	opc1	CRm	opc2
Invalidate Instruction TLB	c8	0	c5	0
Invalidate Instruction TLB entry by MVA	c8	0	c5	1
Invalidate Data TLB	c8	0	c6	0
Invalidate Data TLB entry by MVA	c8	0	c6	1
Invalidate Unified TLB	c8	0	c7	0
Invalidate Unified TLB entry by MVA	c8	0	c7	1

### O.7.11 CP15 c9, cache lockdown support

One problem with caches is that although they normally improve average access time to data and instructions, they usually increase the worst-case access time. This is because:

- There is a delay before the system determines that a cache miss has occurred and starts the main memory access.
- If a write-back cache is being used, there might be more delay because of the requirement to store the contents of the cache line that is being reallocated.
- A whole cache line is loaded from main memory, not only the data requested by the ARM processor.

In real-time applications, this increase in the worst-case access time can be significant.

Cache lockdown is an optional feature designed to alleviate this. It enables critical software and data, for example high priority interrupt routines and the data they access, to be loaded into the cache in such a way that the cache lines containing them are not subsequently reallocated. This ensures that all subsequent accesses to this software and data are cache hits and therefore complete as quickly as possible.

The ARM architecture specifies four formats for the cache lockdown mechanism. These are called Format A, Format B, Format C, and Format D. The Cache Type Register contains information on the lockdown mechanism adopted. See *CP15 c0, Cache Type Register, CTR, ARMv4 and ARMv5* on page AppxO-2615.

Formats A, B, and C all operate on cache ways. Format D is a cache entry locking mechanism. Table O-25 summarizes the CP15 provisions for format A, B, C, and D lockdown mechanisms.

From ARMv7, cache lockdown is IMPLEMENTATION DEFINED with no recommended formats or mechanisms on how it is achieved other than reserved CP15 register space. See *Cache lockdown* on page B2-1270 and *Cache and TCM lockdown registers, VMSA* on page B4-1750.

**Table O-25 cache lockdown register support**

Register	Description, or operation	Lockdown formats	CRn	opc1	CRm	opc2
DCLR	Data or unified Cache Lockdown Register	A, B, and C	c9	0	c0	0
ICLR	Instruction Cache Lockdown Register	A, B, and C	c9	0	c0	1
-	Fetch and lock instruction cache line	D	c9	0	c5	0
-	Unlock instruction cache	D	c9	0	c5	1

**Table O-25 cache lockdown register support (continued)**

Register	Description, or operation	Lockdown formats	CRn	opc1	CRm	opc2
DCLR2	Format D Data or unified Cache Lockdown Register	D	c9	0	c6	0
-	Unlock data cache	D	c9	0	c6	1

### General conditions applying to Format A, B, and C lockdown

The instructions that access the CP15 c9 lockdown registers are as follows:

```
MCR p15, 0, <Rt>, c9, c0, 0 ; write Data or unified Cache Lockdown Register
MRC p15, 0, <Rt>, c9, c0, 0 ; read Data or unified Cache Lockdown Register
MCR p15, 0, <Rt>, c9, c0, 1 ; write Instruction Cache Lockdown Register
MRC p15, 0, <Rt>, c9, c0, 1 ; read Instruction Cache Lockdown Register
```

Formats A, B, and C all use cache ways for lockdown granularity. Granularity is defined by the *lockdown block*, and a cache locking scheme can use any number of lockdown blocks from 1 to (ASSOCIATIVITY-1).

If N lockdown blocks are locked down, they have indices 0 to N-1, and lockdown blocks N to (ASSOCIATIVITY-1) are available for normal cache operation.

A cache way based lockdown implementation must not lock down the entire cache. At least one cache way must be left for normal cache operation, otherwise behavior is UNPREDICTABLE.

The lockdown blocks are indexed from 0 to (ASSOCIATIVITY-1). The cache lines in a lockdown block are chosen to have the same WAY number as the lockdown block index value. So lockdown block n consists of the cache line with index n from each cache set, and n takes the values from n == 0 to n == (ASSOCIATIVITY-1).

Where NSETS is the number of sets, and LINELEN is the cache line length, each lockdown block can hold NSETS memory cache lines, provided each of the memory cache lines is associated with a different cache set. ARM recommends that systems are designed so that each lockdown block contains a set of NSETS consecutive memory cache lines. This is NSETS × LINELEN consecutive memory locations, starting at a cache line boundary. Such sets are easily identified and are guaranteed to consist of one cache line associated with each cache set.

### Formats A and B lockdown

Formats A and B use a WAY field that is chosen to be wide enough to hold the way number of any lockdown block. Its width, W, is given by  $W = \log_2(\text{ASSOCIATIVITY})$ , rounded up to the nearest integer if necessary.

The format of a Format A lockdown register is:

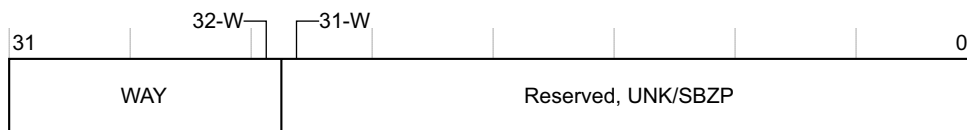

Reading a Format A register returns the value last written to it.

Writing a Format A register has the following effects:

- The next cache miss in each cache set replaces the cache line with the specified WAY in that cache set.
- The replacement strategy for the cache is constrained so that it can only select cache lines with the specified WAY and higher until the register is written again.

The format of a Format B lockdown register is:

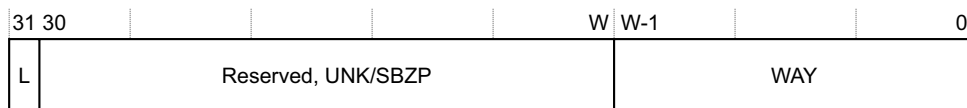

Reading a Format B register returns the value last written to it.

Writing a Format B register has the following effects:

- If  $L == 1$ , all cache misses replace the cache line with the specified WAY in the relevant cache set until the register is written again.
- If  $L == 0$ :
  - If the previous value of  $L$  was 0, and the previous value of WAY is smaller than the new value, the behavior is UNPREDICTABLE.
  - If the previous value of  $L$  was not 0, the replacement strategy for the cache is constrained so that it can only select cache lines with the specified WAY and higher until the register is written again.

### Format A and B cache lockdown procedure

The procedure for locking down  $N$  lockdown blocks is as follows:

1. Ensure that no processor exceptions can occur during the execution of this procedure, for example by disabling interrupts. If for some reason this is not possible, all software and data used by any exception handlers that can get called must be treated as software and data used by this procedure for the purpose of steps 2 and 3.
2. If an instruction cache or a unified cache is being locked down, ensure that all the software executed by this procedure is in an Non-cacheable area of memory.
3. If a data cache or a unified cache is being locked down, ensure that all data used by the following software is in an Non-cacheable area of memory, apart from the data that is to be locked down.
4. Ensure that the data or instructions that are to be locked down are in a Cacheable area of memory.
5. Ensure that the data or instructions that are to be locked down are not already in the cache, using cache clean, invalidate, or clean and invalidate instructions as appropriate.
6. For each value of  $i$  from 0 to  $N-1$ :
  - a. Write to the CP15 c9 register with:
    - $WAY == i$ , for Formats A and B
    - $L == 1$ , for Format B only.
  - b. For each of the cache lines to be locked down in lockdown block  $i$ :

If a data cache or a unified cache is being locked down, use an LDR instruction to load a word from the memory cache line. This ensures that the memory cache line is loaded into the cache.

If an instruction cache is being locked down, use the CP15 c7 prefetch instruction cache line operation to fetch the memory cache line into the cache.
7. Write to the CP15 c9 register with:
  - $WAY == N$ , for Formats A and B
  - $L == 0$ , for Format B only.

#### ————— **Note** —————

If the FCSE described in [Appendix J Fast Context Switch Extension \(FCSE\)](#) is being used, care must be taken in step 6b because:

- If a data cache or a unified cache is being locked down, the address used for the LDR instruction is subject to modification by the FCSE.
- If an instruction cache is being locked down, the address used for the CP15 c7 operation is treated as data and so is not subject to modification by the FCSE.

To minimize the possible confusion caused by this, ARM recommends that the lockdown procedure:

- starts by disabling the FCSE (by setting the PID to zero)
- where appropriate, generates modified virtual addresses itself by ORing the appropriate PID value into the top seven bits of the virtual addresses it uses.

## Format A and B cache unlock procedure

To unlock the locked down portion of the cache, write to the CP15 c9 register with:

- WAY == 0, for Formats A and B
- L == 0, for Format B only.

## Format C lockdown

Cache lockdown Format C is a different form of cache way based locking. It enables the allocation to each cache way to be disabled or enabled. This provides some additional control over the cache pollution caused by particular applications, in addition to a traditional lockdown function for locking critical regions into the cache.

A locking bit for each cache way determines whether the normal cache allocation mechanisms can access that cache way.

For caches of higher associativity, only cache ways 0 to 31 can be locked.

A maximum of N-1 ways of an N-way cache can be locked. This ensures that a normal cache line replacement can be performed. Handling a cache miss is UNPREDICTABLE if there are no cache ways that have L==0.

The 32 bits of the lockdown register determine the L bit for the associated cache way. The value of <opc2> determines whether the instruction lockdown register or data lockdown register is accessed.

The cache lockdown register is normally modified in a read, modify, write sequence. For example, the following sequence sets the L bit to 1 for way 0 of the instruction cache:

```
; In the following code, <Rn> can be any register whose value does not need to be kept.
MRC    p15, 0, <Rn>, c9, c0, 1    ; Read Instruction Cache Lockdown Register
ORR    <Rn>, <Rn>, #0x01
MCR    p15, 0, <Rn>, c9, c0, 1    ; Write Instruction Cache Lockdown Register
                                           ; The write sets way 0 L bit for the instruction cache
```

The Format C lockdown register bit assignments are:

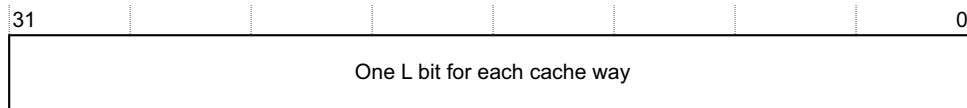

**Bits[31:0]** The L bits for each cache way. If a cache way is not implemented, the L bit for that way is RAO/WI. Each bit relates to its corresponding cache way, that is bit N refers to way N.

- 0** Allocation to the cache way is determined by the standard replacement algorithm (reset state)
- 1** No Allocation is performed to this cache way.

The Format C lockdown register must only be changed when it is certain that all outstanding accesses that can cause a cache linefill have completed. For this reason, a Data Synchronization Barrier instruction must be executed before the lockdown register is changed.

## Format C cache lock procedure

The procedure for locking down into a cache way i with N cache ways using Format C involves making it impossible to allocate to any cache way other than the target cache way i. The architecture defines the following method for locking data into the caches:

1. Ensure that no processor exceptions can occur during the execution of this procedure, for example by disabling interrupts. If for some reason this is not possible, all software and data used by any exception handlers that can get called must be treated as software and data used by this procedure for the purpose of steps 2 and 3.
2. If an instruction cache or a unified cache is being locked down, ensure that all the software executed by this procedure is in an Non-cacheable area of memory, including the Tightly Coupled Memory, or in an already locked cache way.

3. If a data cache or a unified cache is being locked down, ensure that all data used by the following software (apart from the data that is to be locked down) is in a Non-cacheable area of memory, including the Tightly Coupled Memory, or is in an already locked cache way.
4. Ensure that the data or instructions that are to be locked down are in a Cacheable area of memory.
5. Ensure that the data or instructions that are to be locked down are not already in the cache, using cache clean, invalidate, or clean and invalidate instructions as appropriate.
6. Write to the CP15 c9 register with CRm == 0, setting L=0 for bit i and L=1 for all other bits. This enables allocation to the target cache way i.
7. For each of the cache lines to be locked down in cache way i:
  - If a data cache or a unified cache is being locked down, use an LDR instruction to load a word from the memory cache line. This ensures that the memory cache line is loaded into the cache.
  - If an instruction cache is being locked down, use the CP15 c7 prefetch instruction cache line operation to fetch the memory cache line into the cache.
8. Write to the CP15 c9 register with CRm == 0, setting L = 1 for bit i and restoring all the other bits to the values they had before this routine was started.

### Format C cache unlock procedure

To unlock the locked down portion of the cache, write to the CP15 c9 register, setting L == 0 for each bit.

### Format D lockdown

This format locks individual L1 cache line entries rather than using a cache way scheme. The methods differ for the instruction and data caches.

The instructions that access the CP15 c9 Format D Cache Lockdown Registers and operations are as follows:

```
MCR p15, 0, <Rt>, c9, c5, 0 ; fetch and lock instruction cache line,
                             ; Rt = MVA
MCR p15, 0, <Rt>, c9, c5, 1 ; unlock instruction cache,
                             ; Rt ignored
MCR p15, 0, <Rt>, c9, c6, 0 ; write Format D Data Cache Lockdown Register,
                             ; Rt = set or clear lockdown mode
MRC p15, 0, <Rt>, c9, c6, 0 ; read Format D Data Cache Lockdown Register,
                             ; Rt = lockdown mode status
MCR p15, 0, <Rt>, c9, c6, 1 ; unlock data cache,
                             ; Rt ignored
```

#### ————— Note —————

Some format D implementations use CRm == {c1, c2} instead of CRm == {c5, c6}. You must check the Technical Reference Manual to find the encoding uses. The architecture did not require the implementation of CP15, and the Architecture Reference Manual only gave a recommended implementation. The actual CP15 implementation is IMPLEMENTATION DEFINED in ARMv4 and ARMv5.

The following rules determine how many entries in a cache set can be locked:

- At least one entry per cache set must be left for normal cache operation, otherwise behavior is UNPREDICTABLE.
- How many ways in each cache set can be locked is IMPLEMENTATION DEFINED. MAX\_CACHESET\_ENTRIES\_LOCKED < NWAYS.
- Whether attempts to lock additional entries in Format D are allocated as an unlocked entry or ignored is IMPLEMENTATION DEFINED.

For the instruction cache, a fetch and lock operation fetches and locks individual cache lines. Each cache line is specified by its MVA. To lock instructions into the instruction cache, the following rules apply:

- The routine that locks lines into the instruction cache must be executed from Non-cacheable memory.
- The memory that holds the instructions being locked into the instruction cache must be Cacheable.
- The instruction cache must be enabled and invalidated before locking down cache lines.

If these rules are not applied, results are UNPREDICTABLE. Entries must be unlocked using the global instruction cache unlock command.

Cache lines must be locked into the data cache by first setting a global lock control bit. Data cache linefills occurring while the global lock control bit is set are locked into the data cache. To lock data into the data cache, the following rules apply:

- The data being locked must not exist in the cache. Cache clean and invalidate operations might be necessary to meet this condition.
- The data to be locked must be Cacheable.
- The data cache must be enabled.

#### CP15 c9, Format D Data or unified Cache Lockdown Register, DCLR2, ARMv4 and ARMv5

The DCLR2, the Format D Data or unified Cache Lockdown Register, bit assignments are:

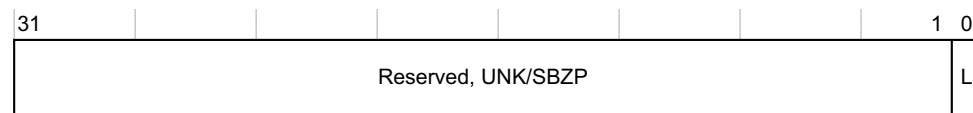

- L, bit[0]** Lock bit
- 0** no locking occurs
  - 1** all data fills are locked while this bit is set.

#### Interaction with CP15 c7 operations

Cache lockdown only prevents the normal replacement strategy used on cache misses choosing to reallocate cache lines in the locked down region. CP15 c7 operations that invalidate, clean, or clean and invalidate cache contents affect locked down cache lines as normal. If invalidate operations are used, you must ensure that they do not use virtual addresses or cache set/way combinations that affect the locked down cache lines. Otherwise, if it is difficult to avoid affecting the locked down cache lines, repeat the cache lockdown procedure afterwards.

### O.7.12 CP15 c9, TCM support

TCM register support is optional when CP15 and TCM are supported in ARMv4 and ARMv5. For details see [CP15 c9, TCM support on page AppxL-2538](#).

### O.7.13 CP15 c10, TLB lockdown support, VMSA

TLB lockdown is an optional feature that enables the results of specified translation table walks to load into the TLB in a way that prevents them being overwritten by the results of subsequent translation table walks.

Translation table walks can take a long time because they involve potentially slow main memory accesses. In real-time interrupt handlers, translation table walks caused by the TLB that do not contain translations for the handler or the data it accesses can increase interrupt latency significantly.

Two basic lockdown models are supported:

- a TLB lock by entry model
- a translate and lock model introduced as an alternative model in ARMv5TE.

In an ARMv6 implementation that includes the Security Extensions, c10 TLB Lockdown registers are Configurable access registers, with access controlled by the NSACR. For more information, see:

- [Configurable access system control registers on page B3-1453](#) for general information
- [NSACR, Non-Secure Access Control Register, Security Extensions on page B4-1661](#) and [CP15 c1, VMSA Security Extensions support on page AppxL-2529](#) for details of the NSACR.

From ARMv7, TLB lockdown is IMPLEMENTATION DEFINED with no recommended formats or mechanisms on how it is achieved other than reserved CP15 register space. See [TLB lockdown on page B3-1379](#) and [VMSA CP15 c10 register summary, memory remapping and TLB control registers on page B3-1478](#).

Table O-26 shows the TLB operations that support the different mechanisms.

**Table O-26 TLB lockdown register support**

Register	Description, or operation	Type	Mechanism	CRn	opc1	CRm	opc2
DTLBLR	Data or unified TLB Lockdown Register	RW	By entry	c10	0	c0	0
ITLBLR	Instruction TLB Lockdown Register	RW	By entry	c10	0	c0	1
-	Lock instruction TLB	WO	Translate and lock	c10	0	c4	0
-	Unlock instruction TLB	WO	Translate and lock	c10	0	c4	1
-	Lock data TLB	WO	Translate and lock	c10	0	c8	0
-	Unlock data TLB	WO	Translate and lock	c10	0	c8	1

#### The TLB lock by entry model

When a new entry is written to the TLB as the result of a translation table walk following a TLB miss, the Victim field of the appropriate TLB Lockdown Register is incremented. When the value of the Victim field reaches the maximum number of TLB entries, the incremented Victim field wraps to the value of the Base field.

The architecture permits a modified form of this where the Base field is fixed as zero. It is particularly appropriate where an implementation provides dedicated lockable entries (unified or Harvard) as a separate resource from the general TLB provision. To determine which form of the locking model is provided, write the Base field with all bits nonzero, read it back and check whether it is a nonzero value.

#### TLB Lockdown Register format, for the lockdown by entry mechanism

The bit assignments of the CP15 register used for the lockdown by entry mechanism are:

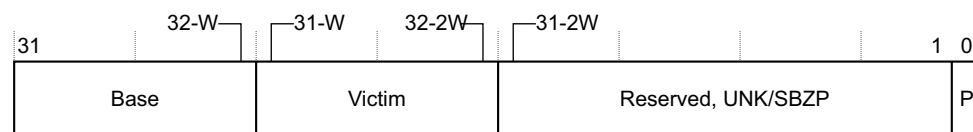

Where  $W = \log_2(n)$ , rounded up to an integer if necessary, where  $n$  is the number of TLB entries.



If the implementation has separate instruction and data TLBs, there are two variants of this register, selected by the <opc2> field of the MCR or MRC instruction that accesses the CP15 c10 register:

<opc2> == 0               Selects the data TLB lockdown register.

<opc2> == 1               Selects the instruction TLB lockdown register.

If the implementation has a unified TLB, only one variant of this register exists, and <opc2> must be zero.

CRm must be c0 for MCR and MRC instructions that access the CP15 c10 register.

Writing the appropriate TLB lockdown by entry register has the following effects:

- The victim field specifies which TLB entry is replaced by the translation table walk result generated by the next TLB miss.
- The Base field constrains the TLB replacement strategy to only use the TLB entries numbered from (Base) to ((number of TLB entries)-1), provided the victim field is already in that range.
- Any translation table walk results written to TLB entries when P == 1 are protected from being invalidated by the CP15 c8 invalidate entire TLB operations. Ones written when P == 0 are invalidated normally by these operations.

———— **Note** —————

If the number of TLB entries is not a power of two, writing a value to either the Base or Victim fields that is greater than or equal to the number of TLB entries has UNPREDICTABLE results.

Reading the appropriate TLB lockdown by entry register returns the last values written to the Base field and the P bit, and the number of the next TLB entry to be replaced in the victim field.

***TLB lockdown procedure, using the by entry model***

The normal procedure for locking down N TLB entries where the Base field can be modified is as follows:

1. Ensure that no processor exceptions can occur during the execution of this procedure, for example by disabling interrupts.
2. If an instruction TLB or unified TLB is being locked down, write the appropriate version of register c10 with Base == N, Victim == N, and P == 0. If appropriate, turn off facilities like branch prediction that make instruction fetching harder to understand.
3. Invalidate the entire TLB to be locked down.
4. If an instruction TLB is being locked down, ensure that all TLB entries are loaded that relate to any instruction that could be speculatively fetched by the rest of the lockdown procedure. Provided care is taken about where the lockdown procedure starts, one TLB entry can usually cover all of these. This means that the first instruction fetch after the TLB is invalidated can do this job.

If a data TLB is being locked down, ensure that all TLB entries are loaded that relate to any data accessed by the rest of the lockdown procedure, including any inline literals used by its software. Usually the best way to do this is to avoid using inline literals in the lockdown procedure, and to put all other data used by it in an area covered by a single TLB entry, and then to load one data item.

If a unified TLB is being locked down, do both of the above.

5. For each of value of  $i$  from 0 to  $N-1$ :
  - a. Write to the CP15 c10 register with  $\text{Base} == i$ ,  $\text{Victim} == i$ , and  $\text{P} == 1$ .
  - b. Force a translation table walk to occur for the area of memory whose translation table walk result is to be locked into TLB entry  $i$  as follows:
    - If a data TLB or unified TLB is being locked down, load an item of data from the area of memory.
    - If an instruction TLB is being locked down, use the CP15 c7 prefetch instruction cache line operation defined in [Table O-22 on page AppxO-2628](#) to fetch an instruction from the area of memory.

———— **Note** —————

If the FCSE is being used, take care in step 5b because:

- If a data TLB or a unified TLB is being locked down, the address used for the load instruction is subject to modification by the FCSE.
- If an instruction TLB is being locked down, the address used for the CP15 c7 operation is being treated as data and so is not subject to modification by the FCSE.

To minimize the possible confusion caused by this, ARM recommends that the lockdown procedure:

- starts by disabling the FCSE, by setting the PID to zero
- where appropriate, generates modified virtual addresses itself by ORing the appropriate PID value into the top 7 bits of the virtual addresses it uses.

- 
6. Write to the CP15 c10 register with  $\text{Base} == N$ ,  $\text{Victim} == N$ , and  $\text{P} == 0$ .

Where the Base field is fixed at zero, the algorithm can be simplified as follows:

1. Ensure that no processor exceptions can occur during the execution of this procedure, for example by disabling interrupts.
2. If any current locked entries must be removed, an appropriate sequence of invalidate single entry operations is required.
3. Turn off branch prediction.
4. If an instruction TLB is being locked down, ensure that all TLB entries are loaded that relate to any instruction that could be speculatively fetched by the rest of the lockdown procedure. Provided care is taken about where the lockdown procedure starts, one TLB entry can usually cover all of these. This means that the first instruction fetch after the TLB is invalidated can do this job.

If a data TLB is being locked down, ensure that all TLB entries are loaded that relate to any data accessed by the rest of the lockdown procedure, including any inline literals used by its software. Usually the best way to do this is to avoid using inline literals in the lockdown procedure, and to put all other data used by it in an area covered by a single TLB entry, and then to load one data item.

If a unified TLB is being locked down, do both of the above.

5. For each value of  $i$  from 0 to  $N-1$ :
  - a. Write to the CP15 c10 register with  $\text{Base} == 0$ ,  $\text{Victim} == i$ , and  $\text{P} == 1$ .
  - b. Force a translation table walk to occur for the area of memory whose translation table walk result is to be locked into TLB entry  $i$  as follows:
    - If a data TLB or unified TLB is being locked down, load an item of data from the area of memory.
    - If an instruction TLB is being locked down, use the CP15 c7 prefetch instruction cache line operation defined in [Table O-22 on page AppxO-2628](#) to cause an instruction to be fetched from the area of memory.
6. Clear the appropriate lockdown register.

### **TLB unlock procedure, using the by entry model**

To unlock the locked down portion of the TLB after it has been locked down using the above procedure:

1. Use CP15 c8 operations to invalidate each single entry that was locked down.
2. Write to the CP15 c10 register with Base == 0, Victim == 0, and P == 0.

#### **Note**

Step 1 ensures that P == 1 entries are not left in the TLB. If they are left in the TLB, the entire TLB invalidation step of a subsequent TLB lockdown procedure does not have the required effect.

### **The translate and lock model**

This mechanism uses explicit TLB operations to translate and lock specific addresses into the TLB. Entries are unlocked on a global basis using the unlock operations. Addresses are loaded using their MVA. The following actions are UNPREDICTABLE:

- accessing these functions with read (MRC) commands
- using functions when the MMU is disabled
- trying to translate and lock an address that is already present in the TLB.

Any abort generated during the translation is reported as a lock abort in the FSR. Only external aborts and Translation faults are guaranteed to be detected. Any access permission, domain, or alignment checks on these functions are IMPLEMENTATION DEFINED. Operations that generate an abort do not affect the target TLB.

Where this model is applied to a unified TLB, the data TLB operations must be used.

Invalidate\_all (I, D, or I and D) operations have no effect on locked entries.

### **TLB lockdown procedure, using the translate and lock model**

All previously locked entries can be unlocked by issuing the appropriate unlock operation, I or D side. Explicit lockdown operations are then issued with the required MVA in register Rt.

### **TLB unlock procedure, using the translate and lock model**

Issuing the appropriate unlock (I or D) TLB operation unlocks all locked entries. It is IMPLEMENTATION DEFINED whether an invalidate by MVA TLB operation removes the lock.

#### **Note**

The invalidate behavior is different in the TLB locking by entry model, where the invalidate by MVA operation is guaranteed to occur.

## **O.7.14 CP15 c13, VMSA FCSE support**

The FCSE described in [Appendix J Fast Context Switch Extension \(FCSE\)](#) is an IMPLEMENTATION DEFINED option in ARMv4 and ARMv5. The feature is supported by the [FCSEIDR](#). The ARMv7 Context ID and Software Thread ID registers are not supported in ARMv4 and ARMv5.

## **O.7.15 CP15 c15, IMPLEMENTATION DEFINED**

CP15 c15 is reserved for IMPLEMENTATION DEFINED use. It is typically used for processor-specific runtime and test features.



# Appendix P

## Pseudocode Definition

This appendix provides a definition of the pseudocode used in this manual, and lists the *helper* procedures and functions used by pseudocode to perform useful architecture-specific jobs. It contains the following sections:

- [About the ARMv7 pseudocode on page AppxP-2642](#)
- [Pseudocode for instruction descriptions on page AppxP-2643](#)
- [Data types on page AppxP-2645](#)
- [Expressions on page AppxP-2649](#)
- [Operators and built-in functions on page AppxP-2651](#)
- [Statements and program structure on page AppxP-2656](#)
- [Miscellaneous helper procedures and functions on page AppxP-2660.](#)

———— **Note** —————

The pseudocode in this manual describes ARMv7. Where it can reasonably also describe the differences in earlier versions of the architecture, it does so. However, it does not always do so. For details of the differences in earlier architectures, see [Appendix L ARMv6 Differences](#) and [Appendix O ARMv4 and ARMv5 Differences](#).

## P.1 About the ARMv7 pseudocode

The ARMv7 pseudocode provides precise descriptions of some areas of the ARMv7 architecture. This includes description of the decoding and operation of all valid instructions. [Pseudocode for instruction descriptions on page AppxP-2643](#) gives general information about this instruction pseudocode, including its limitations.

The following sections describe the ARMv7 pseudocode in detail:

- [Data types on page AppxP-2645](#)
- [Expressions on page AppxP-2649](#)
- [Operators and built-in functions on page AppxP-2651](#)
- [Statements and program structure on page AppxP-2656](#)

[Miscellaneous helper procedures and functions on page AppxP-2660](#) describes some pseudocode helper functions, that are used by the pseudocode functions that are described elsewhere in this manual. [Appendix Q](#) contains the following indexes to the pseudocode:

- [Pseudocode operators and keywords on page AppxQ-2666](#).
- [Pseudocode functions and procedures on page AppxQ-2669](#). This includes the helper functions, and all other functions and procedures defined in this manual.

### P.1.1 General limitations of ARMv7 pseudocode

The pseudocode statements `IMPLEMENTATION_DEFINED`, `SEE`, `SUBARCHITECTURE_DEFINED`, `UNDEFINED`, and `UNPREDICTABLE` indicate behavior that differs from that indicated by the pseudocode being executed. If one of them is encountered:

- Earlier behavior indicated by the pseudocode is only specified as occurring to the extent required to determine that the statement is executed.
- No subsequent behavior indicated by the pseudocode occurs. This means that these statements terminate pseudocode execution.

For more information, see [Simple statements on page AppxP-2656](#).

## P.2 Pseudocode for instruction descriptions

Each instruction description includes pseudocode that provides a precise description of what the instruction does, subject to the limitations described in *General limitations of ARMv7 pseudocode* on page AppxP-2642 and *Limitations of the instruction pseudocode* on page AppxP-2644.

In the instruction pseudocode, instruction fields are referred to by the names shown in the encoding diagram for the instruction. *Instruction encoding diagrams and instruction pseudocode* gives more information about the pseudocode provided for each instruction.

### P.2.1 Instruction encoding diagrams and instruction pseudocode

Instruction descriptions in this manual contain:

- An Encoding section, containing one or more encoding diagrams, each followed by some encoding-specific pseudocode that translates the fields of the encoding into inputs for the common pseudocode of the instruction, and picks out any encoding-specific special cases.
- An Operation section, containing common pseudocode that applies to all of the encodings being described. The Operation section pseudocode contains a call to the `EncodingSpecificOperations()` function, either at its start or after only a condition code check performed by `if ConditionPassed()` then.

An encoding diagram specifies each bit of the instruction as one of the following:

- An obligatory 0 or 1, represented in the diagram as 0 or 1. If this bit does not have this value, the encoding corresponds to a different instruction.
- A *should be* 0 or 1, represented in the diagram as (0) or (1). If this bit does not have this value, the instruction is UNPREDICTABLE.
- A named single bit or a bit in a named multi-bit field. The `cond` field in bits[31:28] of many ARM instructions has some special rules associated with it.

An encoding diagram matches an instruction if all obligatory bits are identical in the encoding diagram and the instruction, and one of the following is true:

- the encoding diagram is not for an ARM instruction
- the encoding diagram is for an ARM instruction that does not have a `cond` field in bits[31:28]
- the encoding diagram is for an ARM instruction that has a `cond` field in bits[31:28], and bits[31:28] of the instruction are not `0b1111`.

In the context of the instruction pseudocode, the execution model for an instruction is:

1. Find all encoding diagrams that match the instruction. It is possible that no encoding diagram matches. In that case, abandon this execution model and consult the relevant instruction set chapter instead to find out how the instruction is to be treated. The bit pattern of such an instruction is usually reserved and UNDEFINED, though there are some other possibilities. For example, unallocated hint instructions are documented as being reserved and executed as NOPs.
2. If the operation pseudocode for the matching encoding diagrams starts with a condition code check, perform that check. If the condition code check fails, abandon this execution model and treat the instruction as a NOP. If there are multiple matching encoding diagrams, either all or none of their corresponding pieces of common pseudocode start with a condition code check.
3. Perform the encoding-specific pseudocode for each of the matching encoding diagrams independently and in parallel. Each such piece of encoding-specific pseudocode starts with a bitstring variable for each named bit or multi-bit field in its corresponding encoding diagram, named the same as the bit or multi-bit field and initialized with the values of the corresponding bit or bits from the bit pattern of the instruction.

In a few cases, the encoding diagram contains more than one bit or field with same name. In these cases, the values of the different instances of those bits or fields must be identical. The encoding-specific pseudocode contains a special case using the `Consistent()` function to specify what happens if they are not identical. `Consistent()` returns `TRUE` if all instruction bits or fields with the same name as its argument have the same value, and `FALSE` otherwise.

If there are multiple matching encoding diagrams, all but one of the corresponding pieces of pseudocode must contain a special case that indicates that it does not apply. Discard the results of all such pieces of pseudocode and their corresponding encoding diagrams.

There is now one remaining piece of pseudocode and its corresponding encoding diagram left to consider. This pseudocode might also contain a special case, most commonly one indicating that it is `UNPREDICTABLE`. If so, abandon this execution model and treat the instruction according to the special case.

4. Check the *should be* bits of the encoding diagram against the corresponding bits of the bit pattern of the instruction. If any of them do not match, abandon this execution model and treat the instruction as `UNPREDICTABLE`.
5. Perform the rest of the operation pseudocode for the instruction description that contains the encoding diagram. That pseudocode starts with all variables set to the values they were left with by the encoding-specific pseudocode.

The `ConditionPassed()` call in the common pseudocode, if present, performs step 2, and the `EncodingSpecificOperations()` call performs steps 3 and 4.

## P.2.2 Limitations of the instruction pseudocode

The pseudocode descriptions of instruction functionality have a number of limitations. These are mainly due to the fact that, for clarity and brevity, the pseudocode is a sequential and mostly deterministic language.

These limitations include:

- Pseudocode does not describe the ordering requirements when an instruction generates multiple memory accesses, except in the case of `SWP` and `SWPB` instructions where the two accesses are to the same memory location. For a description of the ordering requirements on memory accesses see [Memory access order on page A3-145](#).
- Pseudocode does not describe the exact rules when an `UNDEFINED` instruction fails its condition code check. In such cases, the `UNDEFINED` pseudocode statement lies inside the `if ConditionPassed() then ...` structure, either directly or in the `EncodingSpecificOperations()` function call, and so the pseudocode indicates that the instruction executes as a `NOP`. [Conditional execution of undefined instructions on page B1-1208](#) describes the exact rules.
- Pseudocode does not describe the exact ordering requirements when a single instruction from the Floating-point Extension instruction set generates more than one floating-point exception and one or more of those floating-point exceptions is trapped. [Combinations of exceptions on page A2-71](#) describes the exact rules.

### ———— Note —————

There is no limitation in the case where all the floating-point exceptions are untrapped, because the pseudocode specifies the same behavior as the cross-referenced section.

- A processor exception can be taken during execution of the pseudocode for an instruction, either explicitly as a result of the execution of a pseudocode function such as `DataAbort()`, or implicitly, for example if an interrupt is taken during execution of an `LDM` instruction. If this happens, the pseudocode does not describe the extent to which the normal behavior of the instruction occurs. To determine that, see the descriptions of the processor exceptions in [Exception handling on page B1-1164](#).



## P.3 Data types

This section describes:

- [General data type rules](#)
- [Bitstrings](#)
- [Integers on page AppxP-2646](#)
- [Reals on page AppxP-2646](#)
- [Booleans on page AppxP-2646](#)
- [Enumerations on page AppxP-2646](#)
- [Lists on page AppxP-2647](#)
- [Arrays on page AppxP-2648.](#)

### P.3.1 General data type rules

ARM architecture pseudocode is a strongly-typed language. Every constant and variable is of one of the following types:

- bitstring
- integer
- Boolean
- real
- enumeration
- list
- array.

The type of a constant is determined by its syntax. The type of a variable is normally determined by assignment to the variable, with the variable being implicitly declared to be of the same type as whatever is assigned to it. For example, the assignments  $x = 1$ ,  $y = '1'$ , and  $z = \text{TRUE}$  implicitly declare the variables  $x$ ,  $y$  and  $z$  to have types integer, bitstring of length 1, and Boolean, respectively.

Variables can also have their types declared explicitly by preceding the variable name with the name of the type. This is most often done in function definitions for the arguments and the result of the function.

The remaining subsections describe each data type in more detail.

### P.3.2 Bitstrings

A bitstring is a finite-length string of 0s and 1s. Each length of bitstring is a different type. The minimum permitted length of a bitstring is 1.

The type name for bitstrings of length  $N$  is `bits(N)`. A synonym of `bits(1)` is `bit`.

Bitstring constants are written as a single quotation mark, followed by the string of 0s and 1s, followed by another single quotation mark. For example, the two constants of type `bit` are `'0'` and `'1'`. Spaces can be included in bitstrings for clarity.

A special form of bitstring constant with `'x'` bits is permitted in bitstring comparisons, see [Equality and non-equality testing on page AppxP-2651](#).

Every bitstring value has a left-to-right order, with the bits being numbered in standard *little-endian* order. That is, the leftmost bit of a bitstring of length  $N$  is bit  $(N-1)$  and its right-most bit is bit 0. This order is used as the most-significant-to-least-significant bit order in conversions to and from integers. For bitstring constants and bitstrings derived from encoding diagrams, this order matches the way they are printed.

Bitstrings are the only concrete data type in pseudocode, in the sense that they correspond directly to the contents of registers, memory locations, instructions, and so on. All of the remaining data types are abstract.

### P.3.3 Integers

Pseudocode integers are unbounded in size and can be either positive or negative. That is, they are mathematical integers rather than what computer languages and architectures commonly call integers. Computer integers are represented in pseudocode as bitstrings of the appropriate length, associated with suitable functions to interpret those bitstrings as integers.

The type name for integers is `integer`.

Integer constants are normally written in decimal, such as `0`, `15`, `-1234`. They can also be written in C-style hexadecimal, such as `0x55` or `0x80000000`. Hexadecimal integer constants are treated as positive unless they have a preceding minus sign. For example, `0x80000000` is the integer  $+2^{31}$ . If  $-2^{31}$  needs to be written in hexadecimal, it must be written as `-0x80000000`.

### P.3.4 Reals

Pseudocode reals are unbounded in size and precision. That is, they are mathematical real numbers, not computer floating-point numbers. Computer floating-point numbers are represented in pseudocode as bitstrings of the appropriate length, associated with suitable functions to interpret those bitstrings as reals.

The type name for reals is `real`.

Real constants are written in decimal with a decimal point. This means `0` is an integer constant, but `0.0` is a real constant.

### P.3.5 Booleans

A Boolean is a logical `TRUE` or `FALSE` value.

The type name for Booleans is `boolean`. This is not the same type as `bit`, which is a length-1 bitstring. Boolean constants are `TRUE` and `FALSE`.

### P.3.6 Enumerations

An enumeration is a defined set of symbolic constants, such as:

```
enumeration InstrSet {InstrSet_ARM, InstrSet_Thumb, InstrSet_Jazelle, InstrSet_ThumbEE};
```

An enumeration always contains at least one symbolic constant, and a symbolic constant must not be shared between enumerations.

Enumerations must be declared explicitly, although a variable of an enumeration type can be declared implicitly by assigning one of the symbolic constants to it. By convention, each of the symbolic constants starts with the name of the enumeration followed by an underscore. The name of the enumeration is its *type name*, or *type*, and the symbolic constants are its possible *constants*.

———— **Note** —————

A `boolean` is a pre-declared enumeration that does not follow the normal naming convention and that has a special role in some pseudocode constructs, such as `if` statements. This means the enumeration of a `boolean` is:

```
enumeration boolean {FALSE, TRUE};
```

### P.3.7 Lists

A list is an ordered set of other data items, separated by commas and enclosed in parentheses, for example:

```
(bits(32) shifter_result, bit shifter_carry_out)
```

A list always contains at least one data item.

Lists are often used as the return type for a function that returns multiple results. For example, this list at the start of this section is the return type of the function `Shift_C()` that performs a standard ARM shift or rotation, when its first operand is of type `bits(32)`.

Some specific pseudocode operators use lists surrounded by other forms of bracketing than the (...) parentheses. These are:

- bitstring extraction operators, that use lists of bit numbers or ranges of bit numbers surrounded by angle brackets `<...>`
- array indexing, that uses lists of array indexes surrounded by square brackets `[...]`
- array-like function argument passing, that uses lists of function arguments surrounded by square brackets `[...]`.

Each combination of data types in a list is a separate type, with type name given by listing the data types. This means that the example list at the start of this section is of type `(bits(32), bit)`. The general principle that types can be declared by assignment extends to the types of the individual list items in a list. For example:

```
(shift_t, shift_n) = ('00', 0);
```

implicitly declares `shift_t`, `shift_n` and `(shift_t, shift_n)` to be of types `bits(2)`, `integer` and `(bits(2), integer)`, respectively.

A list type can also be explicitly named, with explicitly named elements in the list. For example:

```
type ShiftSpec is (bits(2) shift, integer amount);
```

After this definition and the declaration:

```
ShiftSpec abc;
```

the elements of the resulting list can then be referred to as `abc.shift` and `abc.amount`. This qualified naming of list elements is only permitted for variables that have been explicitly declared, not for those that have been declared by assignment only.

Explicitly naming a type does not alter what type it is. For example, after the above definition of `ShiftSpec`, `ShiftSpec` and `(bits(2), integer)` are two different names for the same type, not the names of two different types. To avoid ambiguity in references to list elements, it is an error to declare a list variable multiple times using different names of its type or to qualify it with list element names not associated with the name by which it was declared.

An item in a list that is being assigned to can be written as “-” to indicate that the corresponding item of the assigned list value is discarded. For example:

```
(shifted, -) = LSL_C(operand, amount);
```

List constants are written as a list of constants of the appropriate types, for example the `('00', 0)` in the earlier example.

### P.3.8 Arrays

Pseudocode arrays are indexed by either enumerations or integer ranges. An integer range is represented by the lower inclusive end of the range, then `..`, then the upper inclusive end of the range.

For example:

```
// The names of the Banked core registers.  
  
enumeration RName {RName_0usr, RName_1usr, RName_2usr, RName_3usr, RName_4usr, RName_5usr,  
                  RName_6usr, RName_7usr, RName_8usr, RName_8fiq, RName_9usr, RName_9fiq,  
                  RName_10usr, RName_10fiq, RName_11usr, RName_11fiq, RName_12usr, RName_12fiq,  
                  RName_SPusr, RName_SPfiq, RName_SPirq, RName_SPsvc,  
                  RName_SPabt, RName_SPund, RName_SPmon, RName_SPhyp,  
                  RName_LRusr, RName_LRfiq, RName_LRirq, RName_LRsvc,  
                  RName_LRabt, RName_LRund, RName_LRmon,  
                  RName_PC};  
  
array bits(8) _Memory[0..0xFFFFFFFF];
```

Arrays are always explicitly declared, and there is no notation for a constant array. Arrays always contain at least one element, because:

- enumerations always contain at least one symbolic constant
- integer ranges always contain at least one integer.

Arrays do not usually appear directly in pseudocode. The items that syntactically look like arrays in pseudocode are usually array-like functions such as `R[i]`, `MemU[address, size]` or `Elem[vector, i, size]`. These functions package up and abstract additional operations normally performed on accesses to the underlying arrays, such as register banking, memory protection, endian-dependent byte ordering, exclusive-access housekeeping and Advanced SIMD element processing.

## P.4 Expressions

This section describes:

- [General expression syntax](#)
- [Operators and functions - polymorphism and prototypes on page AppxP-2650](#)
- [Precedence rules on page AppxP-2650.](#)

### P.4.1 General expression syntax

An expression is one of the following:

- a constant
- a variable, optionally preceded by a data type name to declare its type
- the word UNKNOWN preceded by a data type name to declare its type
- the result of applying a language-defined operator to other expressions
- the result of applying a function to other expressions.

Variable names normally consist of alphanumeric and underscore characters, starting with an alphabetic or underscore character.

Each register described in the text is to be regarded as declaring a correspondingly named bitstring variable, and that variable has the stated behavior of the register. For example, if a bit of a register is defined as RAZ/WI, then the corresponding bit of its variable reads as 0 and ignore writes.

An expression like `bits(32) UNKNOWN` indicates that the result of the expression is a value of the given type, but the architecture does not specify what value it is and software must not rely on such values. The value produced must not:

- Return information that cannot be accessed at the current or a lower level of privilege using instructions that are not UNPREDICTABLE and do not return UNKNOWN values,
- Be promoted as providing any useful information to software.

#### ———— **Note** —————

Some earlier documentation describes this as an UNPREDICTABLE value. UNKNOWN values are similar to the definition of UNPREDICTABLE, but do not indicate that the entire architectural state becomes unspecified.

Only the following expressions are assignable. This means that these are the only expressions that can be placed on the left-hand side of an assignment.

- Variables.
- The results of applying some operators to other expressions.  
The description of each language-defined operator that can generate an assignable expression specifies the circumstances under which it does so. For example, those circumstances might require that one or more of the expressions the operator operates is an assignable expression.
- The results of applying array-like functions to other expressions. The description of an array-like function specifies the circumstances under which it can generate an assignable expression.

Every expression has a data type.

- For a constant, this data type is determined by the syntax of the constant.
- For a variable, there are the following possible sources for the data type
  - an optional preceding data type name
  - a data type the variable was given earlier in the pseudocode by recursive application of this rule
  - a data type the variable is being given by assignment, either by direct assignment to the variable, or by assignment to a list of which the variable is a member).

It is a pseudocode error if none of these data type sources exists for a variable, or if more than one of them exists and they do not agree about the type.

- For a language-defined operator, the definition of the operator determines the data type.
- For a function, the definition of the function determines the data type.

## P.4.2 Operators and functions - polymorphism and prototypes

Operators and functions in pseudocode can be polymorphic, producing different functionality when applied to different data types. Each resulting form of an operator or function has a different prototype definition. For example, the operator + has forms that act on various combinations of integers, reals and bitstrings.

One particularly common form of polymorphism is between bitstrings of different lengths. This is represented by using `bits(N)`, `bits(M)`, or similar, in the prototype definition.

## P.4.3 Precedence rules

The precedence rules for expressions are:

1. Constants, variables and function invocations are evaluated with higher priority than any operators using their results.
2. Expressions on integers follow the normal operator precedence rules of *exponentiation before multiply/divide before add/subtract*, with sequences of multiply/divides or add/subtracts evaluated left-to-right.
3. Other expressions must be parenthesized to indicate operator precedence if ambiguity is possible, but need not be if all permitted precedence orders under the type rules necessarily lead to the same result. For example, if `i`, `j` and `k` are integer variables, `i > 0 && j > 0 && k > 0` is acceptable, but `i > 0 && j > 0 || k > 0` is not.

## P.5 Operators and built-in functions

This section describes:

- [Operations on generic types](#)
- [Operations on Booleans](#)
- [Bitstring manipulation](#)
- [Arithmetic on page AppxP-2654.](#)

### P.5.1 Operations on generic types

The following operations are defined for all types.

#### Equality and non-equality testing

Any two values  $x$  and  $y$  of the same type can be tested for equality by the expression  $x == y$  and for non-equality by the expression  $x != y$ . In both cases, the result is of type `boolean`.

A special form of comparison is defined with a bitstring constant that includes 'x' bits as well as '0' and '1' bits. The bits corresponding to the 'x' bits are ignored in determining the result of the comparison. For example, if `opcode` is a 4-bit bitstring, `opcode == '1x0x'` is equivalent to `opcode<3> == '1' && opcode<1> == '0'`.

———— **Note** —————

This special form is permitted in the implied equality comparisons in when parts of case ... of ... structures.

#### Conditional selection

If  $x$  and  $y$  are two values of the same type and  $t$  is a value of type `boolean`, then `if t then x else y` is an expression of the same type as  $x$  and  $y$  that produces  $x$  if  $t$  is `TRUE` and  $y$  if  $t$  is `FALSE`.

### P.5.2 Operations on Booleans

If  $x$  is a `boolean`, then `!x` is its logical inverse.

If  $x$  and  $y$  are `booleans`, then `x && y` is the result of ANDING them together. As in the C language, if  $x$  is `FALSE`, the result is determined to be `FALSE` without evaluating  $y$ .

If  $x$  and  $y$  are `booleans`, then `x || y` is the result of ORing them together. As in the C language, if  $x$  is `TRUE`, the result is determined to be `TRUE` without evaluating  $y$ .

If  $x$  and  $y$  are `booleans`, then `x ^ y` is the result of exclusive-ORing them together.

### P.5.3 Bitstring manipulation

The following bitstring manipulation functions are defined:

#### Bitstring length and most significant bit

If  $x$  is a bitstring:

- The bitstring length function `Len(x)` returns the length of  $x$  as an integer.
- `TopBit(x)` is the leftmost bit of  $x$ . Using bitstring extraction, this means:  
`TopBit(x) = x<Len(x)-1>`.

## Bitstring concatenation and replication

If  $x$  and  $y$  are bitstrings of lengths  $N$  and  $M$  respectively, then  $x:y$  is the bitstring of length  $N+M$  constructed by concatenating  $x$  and  $y$  in left-to-right order.

If  $x$  is a bitstring and  $n$  is an integer with  $n > 0$ :

- $\text{Replicate}(x, n)$  is the bitstring of length  $n \cdot \text{Len}(x)$  consisting of  $n$  copies of  $x$  concatenated together
- $\text{Zeros}(n) = \text{Replicate}('0', n)$ ,  $\text{Ones}(n) = \text{Replicate}('1', n)$ .

## Bitstring extraction

The bitstring extraction operator extracts a bitstring from either another bitstring or an integer. Its syntax is  $x\langle\text{integer\_list}\rangle$ , where  $x$  is the integer or bitstring being extracted from, and  $\langle\text{integer\_list}\rangle$  is a list of integers enclosed in angle brackets rather than the usual parentheses. The length of the resulting bitstring is equal to the number of integers in  $\langle\text{integer\_list}\rangle$ . In  $x\langle\text{integer\_list}\rangle$ , each of the integers in  $\langle\text{integer\_list}\rangle$  must be:

- $\geq 0$
- $< \text{Len}(x)$  if  $x$  is a bitstring.

The definition of  $x\langle\text{integer\_list}\rangle$  depends on whether  $\text{integer\_list}$  contains more than one integer:

- If  $\text{integer\_list}$  contains more than one integer,  $x\langle i, j, k, \dots, n \rangle$  is defined to be the concatenation:  
 $x\langle i \rangle : x\langle j \rangle : x\langle k \rangle : \dots : x\langle n \rangle$ .
- If  $\text{integer\_list}$  consists of just one integer  $i$ ,  $x\langle i \rangle$  is defined to be:
  - if  $x$  is a bitstring, '0' if bit  $i$  of  $x$  is a zero and '1' if bit  $i$  of  $x$  is a one.
  - if  $x$  is an integer, let  $y$  be the unique integer in the range  $0$  to  $2^{i+1}-1$  that is congruent to  $x$  modulo  $2^{i+1}$ . Then  $x\langle i \rangle$  is '0' if  $y < 2^i$  and '1' if  $y \geq 2^i$ .  
Loosely, this definition treats an integer as equivalent to a sufficiently long two's complement representation of it as a bitstring.

In  $\langle\text{integer\_list}\rangle$ , the notation  $i:j$  with  $i \geq j$  is shorthand for the integers in order from  $i$  down to  $j$ , with both end values included. For example,  $\text{instr}\langle 31:28 \rangle$  is shorthand for  $\text{instr}\langle 31, 30, 29, 28 \rangle$ .

The expression  $x\langle\text{integer\_list}\rangle$  is assignable provided  $x$  is an assignable bitstring and no integer appears more than once in  $\langle\text{integer\_list}\rangle$ . In particular,  $x\langle i \rangle$  is assignable if  $x$  is an assignable bitstring and  $0 \leq i < \text{Len}(x)$ .

Encoding diagrams for registers frequently show named bits or multi-bit fields. For example, the encoding diagram for the [APSR](#) shows its  $\text{bit}\langle 31 \rangle$  as  $N$ . In such cases, the syntax  $\text{APSR}.N$  is used as a more readable synonym for  $\text{APSR}\langle 31 \rangle$ .

## Logical operations on bitstrings

If  $x$  is a bitstring,  $\text{NOT}(x)$  is the bitstring of the same length obtained by logically inverting every bit of  $x$ .

If  $x$  and  $y$  are bitstrings of the same length,  $x \text{ AND } y$ ,  $x \text{ OR } y$ , and  $x \text{ EOR } y$  are the bitstrings of that same length obtained by logically ANDing, ORing, and exclusive-ORing corresponding bits of  $x$  and  $y$  together.

## Bitstring count

If  $x$  is a bitstring,  $\text{BitCount}(x)$  produces an integer result equal to the number of bits of  $x$  that are ones.



## Testing a bitstring for being all zero or all ones

If  $x$  is a bitstring:

- $\text{IsZero}(x)$  produces TRUE if all of the bits of  $x$  are zeros and FALSE if any of them are ones
- $\text{IsZeroBit}(x)$  produces '1' if all of the bits of  $x$  are zeros and '0' if any of them are ones.

$\text{IsOnes}(x)$  and  $\text{IsOnesBit}(x)$  work in the corresponding ways. This means:

```
IsZero(x)    = (BitCount(x) == 0)
IsOnes(x)   = (BitCount(x) == Len(x))
IsZeroBit(x) = if IsZero(x) then '1' else '0'
IsOnesBit(x) = if IsOnes(x) then '1' else '0'
```

## Lowest and highest set bits of a bitstring

If  $x$  is a bitstring, and  $N = \text{Len}(x)$ :

- $\text{LowestSetBit}(x)$  is the minimum bit number of any of its bits that are ones. If all of its bits are zeros,  $\text{LowestSetBit}(x) = N$ .
- $\text{HighestSetBit}(x)$  is the maximum bit number of any of its bits that are ones. If all of its bits are zeros,  $\text{HighestSetBit}(x) = -1$ .
- $\text{CountLeadingZeroBits}(x)$  is the number of zero bits at the left end of  $x$ , in the range 0 to  $N$ . This means:  
 $\text{CountLeadingZeroBits}(x) = N - 1 - \text{HighestSetBit}(x)$ .
- $\text{CountLeadingSignBits}(x)$  is the number of copies of the sign bit of  $x$  at the left end of  $x$ , excluding the sign bit itself, and is in the range 0 to  $N-1$ . This means:  
 $\text{CountLeadingSignBits}(x) = \text{CountLeadingZeroBits}(x \ll N-1) \text{ EOR } x \ll N-2$ .

## Zero-extension and sign-extension of bitstrings

If  $x$  is a bitstring and  $i$  is an integer, then  $\text{ZeroExtend}(x, i)$  is  $x$  extended to a length of  $i$  bits, by adding sufficient zero bits to its left. That is, if  $i = \text{Len}(x)$ , then  $\text{ZeroExtend}(x, i) = x$ , and if  $i > \text{Len}(x)$ , then:

```
ZeroExtend(x, i) = Replicate('0', i-Len(x)) : x
```

If  $x$  is a bitstring and  $i$  is an integer, then  $\text{SignExtend}(x, i)$  is  $x$  extended to a length of  $i$  bits, by adding sufficient copies of its leftmost bit to its left. That is, if  $i = \text{Len}(x)$ , then  $\text{SignExtend}(x, i) = x$ , and if  $i > \text{Len}(x)$ , then:

```
SignExtend(x, i) = Replicate(TopBit(x), i-Len(x)) : x
```

It is a pseudocode error to use either  $\text{ZeroExtend}(x, i)$  or  $\text{SignExtend}(x, i)$  in a context where it is possible that  $i < \text{Len}(x)$ .

## Converting bitstrings to integers

If  $x$  is a bitstring,  $\text{SInt}(x)$  is the integer whose two's complement representation is  $x$ :

```
// SInt()
// =====

integer SInt(bits(N) x)
    result = 0;
    for i = 0 to N-1
        if x<i> == '1' then result = result + 2^i;
        if x<N-1> == '1' then result = result - 2^N;
    return result;
```

UInt(x) is the integer whose unsigned representation is x:

```
// UInt()  
// =====  
  
integer UInt(bits(N) x)  
    result = 0;  
    for i = 0 to N-1  
        if x<i> == '1' then result = result + 2i;  
    return result;
```

Int(x, unsigned) returns either SInt(x) or UInt(x) depending on the value of its second argument:

```
// Int()  
// =====  
  
integer Int(bits(N) x, boolean unsigned)  
    result = if unsigned then UInt(x) else SInt(x);  
    return result;
```

## P.5.4 Arithmetic

Most pseudocode arithmetic is performed on integer or real values, with operands being obtained by conversions from bitstrings and results converted back to bitstrings afterwards. As these data types are the unbounded mathematical types, no issues arise about overflow or similar errors.

### Unary plus, minus and absolute value

If x is an integer or real, then +x is x unchanged, -x is x with its sign reversed, and Abs(x) is the absolute value of x. All three are of the same type as x.

### Addition and subtraction

If x and y are integers or reals, x+y and x-y are their sum and difference. Both are of type integer if x and y are both of type integer, and real otherwise.

Addition and subtraction are particularly common arithmetic operations in pseudocode, and so it is also convenient to have definitions of addition and subtraction acting directly on bitstring operands.

If x and y are bitstrings of the same length N, so that  $N = \text{Len}(x) = \text{Len}(y)$ , then x+y and x-y are the least significant N bits of the results of converting them to integers and adding or subtracting them. Signed and unsigned conversions produce the same result:

$$\begin{aligned}x+y &= (\text{SInt}(x) + \text{SInt}(y))\langle N-1:0 \rangle \\ &= (\text{UInt}(x) + \text{UInt}(y))\langle N-1:0 \rangle \\ x-y &= (\text{SInt}(x) - \text{SInt}(y))\langle N-1:0 \rangle \\ &= (\text{UInt}(x) - \text{UInt}(y))\langle N-1:0 \rangle\end{aligned}$$

If x is a bitstring of length N and y is an integer, x+y and x-y are the bitstrings of length N defined by  $x+y = x + y\langle N-1:0 \rangle$  and  $x-y = x - y\langle N-1:0 \rangle$ . Similarly, if x is an integer and y is a bitstring of length M, x+y and x-y are the bitstrings of length M defined by  $x+y = x\langle M-1:0 \rangle + y$  and  $x-y = x\langle M-1:0 \rangle - y$ .

### Comparisons

If x and y are integers or reals, then  $x == y$ ,  $x != y$ ,  $x < y$ ,  $x <= y$ ,  $x > y$ , and  $x >= y$  are equal, not equal, less than, less than or equal, greater than, and greater than or equal comparisons between them, producing Boolean results. In the case of == and !=, this extends the generic definition applying to any two values of the same type to also act between integers and reals.

### Multiplication

If x and y are integers or reals, then  $x * y$  is the product of x and y. It is of type integer if x and y are both of type integer, and real otherwise.

## Division and modulo

If  $x$  and  $y$  are integers or reals, then  $x/y$  is the result of dividing  $x$  by  $y$ , and is always of type real.

If  $x$  and  $y$  are integers, then  $x \text{ DIV } y$  and  $x \text{ MOD } y$  are defined by:

$$\begin{aligned}x \text{ DIV } y &= \text{RoundDown}(x/y) \\x \text{ MOD } y &= x - y * (x \text{ DIV } y)\end{aligned}$$

It is a pseudocode error to use any of  $x/y$ ,  $x \text{ MOD } y$ , or  $x \text{ DIV } y$  in any context where  $y$  can be zero.

## Square root

If  $x$  is an integer or a real,  $\text{Sqrt}(x)$  is its square root, and is always of type real.

## Rounding and aligning

If  $x$  is a real:

- $\text{RoundDown}(x)$  produces the largest integer  $n$  such that  $n \leq x$
- $\text{RoundUp}(x)$  produces the smallest integer  $n$  such that  $n \geq x$
- $\text{RoundTowardsZero}(x)$  produces  $\text{RoundDown}(x)$  if  $x > 0.0$ ,  $0$  if  $x == 0.0$ , and  $\text{RoundUp}(x)$  if  $x < 0.0$ .

If  $x$  and  $y$  are both of type integer,  $\text{Align}(x, y) = y * (x \text{ DIV } y)$  is of type integer.

If  $x$  is of type bitstring and  $y$  is of type integer,  $\text{Align}(x, y) = (\text{Align}(\text{UInt}(x), y)) \langle \text{Len}(x) - 1 : 0 \rangle$  is a bitstring of the same length as  $x$ .

It is a pseudocode error to use either form of  $\text{Align}(x, y)$  in any context where  $y$  can be 0. In practice,  $\text{Align}(x, y)$  is only used with  $y$  a constant power of two, and the bitstring form used with  $y = 2^n$  has the effect of producing its argument with its  $n$  low-order bits forced to zero.

## Scaling

If  $n$  is an integer,  $2^n$  is the result of raising 2 to the power  $n$  and is of type real.

If  $x$  and  $n$  are of type integer, then:

- $x \ll n = \text{RoundDown}(x * 2^n)$
- $x \gg n = \text{RoundDown}(x * 2^{-(n)})$ .

## Maximum and minimum

If  $x$  and  $y$  are integers or reals, then  $\text{Max}(x, y)$  and  $\text{Min}(x, y)$  are their maximum and minimum respectively. Both are of type integer if  $x$  and  $y$  are both of type integer, and real otherwise.

## P.6 Statements and program structure

This section describes the control statements used in the pseudocode.

### P.6.1 Simple statements

Each of the following simple statements must be terminated with a semicolon, as shown.

#### Assignments

An assignment statement takes the form:

```
<assignable_expression> = <expression>;
```

#### Procedure calls

A procedure call takes the form:

```
<procedure_name>(<arguments>;
```

#### Return statements

A procedure return takes the form:

```
return;
```

and a function return takes the form:

```
return <expression>;
```

where <expression> is of the type declared in the function prototype line.

#### UNDEFINED

This subsection describes the statement:

```
UNDEFINED;
```

This statement indicates a special case that replaces the behavior defined by the current pseudocode, apart from behavior required to determine that the special case applies. The replacement behavior is that the Undefined Instruction exception is taken.

#### UNPREDICTABLE

This subsection describes the statement:

```
UNPREDICTABLE;
```

This statement indicates a special case that replaces the behavior defined by the current pseudocode, apart from behavior required to determine that the special case applies. The replacement behavior is UNPREDICTABLE.

#### SEE...

This subsection describes the statement:

```
SEE <reference>;
```

This statement indicates a special case that replaces the behavior defined by the current pseudocode, apart from behavior required to determine that the special case applies. The replacement behavior is that nothing occurs as a result of the current pseudocode because some other piece of pseudocode defines the required behavior. The <reference> indicates where that other pseudocode can be found.

It usually refers to another instruction, but can also refer to another encoding or note of the same instruction.

## IMPLEMENTATION\_DEFINED

This subsection describes the statement:

```
IMPLEMENTATION_DEFINED {<text>;
```

This statement indicates a special case that replaces the behavior defined by the current pseudocode, apart from behavior required to determine that the special case applies. The replacement behavior is IMPLEMENTATION\_DEFINED. An optional <text> field can give more information.

## SUBARCHITECTURE\_DEFINED

This subsection describes the statement:

```
SUBARCHITECTURE_DEFINED {<text>;
```

This statement indicates a special case that replaces the behavior defined by the current pseudocode, apart from behavior required to determine that the special case applies. The replacement behavior is SUBARCHITECTURE\_DEFINED. An optional <text> field can give more information.

### P.6.2 Compound statements

Indentation normally indicates the structure in compound statements. The statements contained in structures such as if ... then ... else ... or procedure and function definitions are indented more deeply than the statement itself, and their end is indicated by returning to the original indentation level or less.

Indentation is normally done by four spaces for each level.

#### if ... then ... else ...

A multi-line if ... then ... else ... structure takes the form:

```
if <boolean_expression> then
    <statement 1>
    <statement 2>
    ...
    <statement n>
elseif <boolean_expression> then
    <statement a>
    <statement b>
    ...
    <statement z>
else
    <statement A>
    <statement B>
    ...
    <statement Z>
```

The block of lines consisting of elseif and its indented statements is optional, and multiple elseif blocks can be used.

The block of lines consisting of else and its indented statements is optional.

Abbreviated one-line forms can be used when there are only simple statements in the then part and in the else part, if it is present, such as:

```
if <boolean_expression> then <statement 1>
if <boolean_expression> then <statement 1> else <statement A>
if <boolean_expression> then <statement 1> <statement 2> else <statement A>
```

#### ————— Note —————

In these forms, <statement 1>, <statement 2> and <statement A> must be terminated by semicolons. This and the fact that the else part is optional are differences from the if ... then ... else ... expression.

### repeat ... until ...

A repeat ... until ... structure takes the form:

```
repeat
  <statement 1>
  <statement 2>
  ...
  <statement n>
until <boolean_expression>;
```

### while ... do

A while ... do structure takes the form:

```
while <boolean_expression> do
  <statement 1>
  <statement 2>
  ...
  <statement n>
```

### for ...

A for ... structure takes the form:

```
for <assignable_expression> = <integer_expr1> to <integer_expr2>
  <statement 1>
  <statement 2>
  ...
  <statement n>
```

### case ... of ...

A case ... of ... structure takes the form:

```
case <expression> of
  when <constant values>
    <statement 1>
    <statement 2>
    ...
    <statement n>
  ... more "when" groups ...
  otherwise
    <statement A>
    <statement B>
    ...
    <statement Z>
```

In this structure, <constant values> consists of one or more constant values of the same type as <expression>, separated by commas. Abbreviated one line forms of when and otherwise parts can be used when they contain only simple statements.

If <expression> has a bitstring type, <constant values> can also include bitstring constants containing 'x' bits. For details see [Equality and non-equality testing on page AppxP-2651](#).

## Procedure and function definitions

A procedure definition takes the form:

```
<procedure name>(<argument prototypes>)  
  <statement 1>  
  <statement 2>  
  ...  
  <statement n>
```

where <argument prototypes> consists of zero or more argument definitions, separated by commas. Each argument definition consists of a type name followed by the name of the argument.

### ————— **Note** —————

This first prototype line is not terminated by a semicolon. This helps to distinguish it from a procedure call.

A function definition is similar, but also declares the return type of the function:

```
<return type> <function name>(<argument prototypes>)  
  <statement 1>  
  <statement 2>  
  ...  
  <statement n>
```

An array-like function is similar, but with square brackets:

```
<return type> <function name>[<argument prototypes>]  
  <statement 1>  
  <statement 2>  
  ...  
  <statement n>
```

An array-like function also usually has an assignment prototype:

```
<function name>[<argument prototypes>] = <value prototypes>  
  <statement 1>  
  <statement 2>  
  ...  
  <statement n>
```

## P.6.3 Comments

Two styles of pseudocode comment exist:

- // starts a comment that is terminated by the end of the line.
- /\* starts a comment that is terminated by \*/.

## P.7 Miscellaneous helper procedures and functions

The functions described in this section are not part of the pseudocode specification. They are miscellaneous *helper* procedures and functions used by pseudocode that are not described elsewhere in this manual. Each has a brief description and a pseudocode prototype, except that the prototype is omitted where it is identical to the section title.

### P.7.1 ArchVersion()

This function returns the major version number of the architecture.

```
integer ArchVersion()
```

### P.7.2 Breakpoint()

This procedure causes a debug breakpoint to occur.

### P.7.3 EndOfInstruction()

This procedure terminates processing of the current instruction.

### P.7.4 GenerateAlignmentException()

This procedure generates the appropriate exception for an alignment error.

In all architecture variants and profiles described in this manual, `GenerateAlignmentException()` generates a Data Abort exception.

### P.7.5 GenerateCoprorocessorException()

This procedure generates the appropriate exception for a rejected coprocessor instruction.

In all architecture variants and profiles described in this manual, `GenerateCoprorocessorException()` generates an Undefined Instruction exception.

### P.7.6 GenerateIntegerZeroDivide()

This procedure generates the appropriate exception for a division by zero in the integer division instructions `SDIV` and `UDIV`.

In the ARMv7-R profile, `GenerateIntegerZeroDivide()` generates an Undefined Instruction exception. In an implementation of the ARMv7-A profile that supports `SDIV` and `UDIV`, division by zero always returns a result of zero, so the `GenerateIntegerZeroDivide()` procedure is never called.

### P.7.7 HaveLPAE()

This function returns `TRUE` if the implementation includes the Large Physical Address Extension.

```
boolean HaveLPAE()
```

### P.7.8 HaveMPEExt()

This function returns `TRUE` if the implementation includes the Multiprocessing Extensions.

```
boolean HaveMPEExt()
```

### P.7.9 HaveVirtExt()

This function returns `TRUE` if the implementation includes the Virtualization Extensions.

```
boolean HaveVirtExt()
```



**P.7.10 Hint\_Debug()**

This procedure supplies a hint to the debug system.

Hint\_Debug(bits(4) option)

**P.7.11 Hint\_PreloadData()**

This procedure performs a *preload data* hint.

Hint\_PreloadData(bits(32) address)

**P.7.12 Hint\_PreloadDataForWrite()**

This procedure performs a *preload data* hint with a probability that the use will be for a write.

Hint\_PreloadDataForWrite(bits(32) address)

**P.7.13 Hint\_PreloadInstr()**

This procedure performs a *preload instructions* hint.

Hint\_PreloadInstr(bits(32) address)

**P.7.14 Hint\_Yield()**

This procedure performs a *Yield* hint.

**P.7.15 InstrIsPL0Undefined()**

This function returns TRUE if the instruction identified by *instr* is UNDEFINED at PL0, and FALSE otherwise:

InstrIsPL0Undefined(bits(32) instr)

**P.7.16 IntegerZeroDivideTrappingEnabled()**

This function returns TRUE if the trapping of divisions by zero in the integer division instructions SDIV and UDIV is enabled, and FALSE otherwise.

In the ARMv7-R profile, this is controlled by the [SCTLR.DZ](#) bit. The function returns TRUE if the bit is 1, and FALSE if it is 0.

The ARMv7-A profile does not support trapping of integer division by zero. In an implementation of the ARMv7-A profile that supports SDIV and UDIV, this function always returns FALSE.

boolean IntegerZeroDivideTrappingEnabled()

**P.7.17 IsExternalAbort()**

This function returns TRUE if the abort currently being processed is an external abort and FALSE otherwise. It is used only in exception entry pseudocode.

boolean IsExternalAbort()

**P.7.18 IsAlignmentFault()**

This function returns TRUE if the exception currently being processed is generated because of an Alignment fault, and FALSE otherwise. It is used only in exception entry pseudocode.

boolean IsAlignmentFault()

### P.7.19 IsAsyncAbort()

This function returns TRUE if the abort currently being processed is an asynchronous abort, and FALSE otherwise. It is used only in exception entry pseudocode.

```
boolean IsExternalAbort()
```

### P.7.20 JazelleAcceptsExecution()

This function indicates whether Jazelle hardware will take over execution when a BXJ instruction is executed.

```
boolean JazelleAcceptsExecution()
```

### P.7.21 LSInstructionSyndrome()

This function returns the extended syndrome information for a fault reported in the [HSR](#).

```
bits(9) LSInstructionSyndrome()
```

### P.7.22 MemorySystemArchitecture()

This function returns a value indicating which memory system architecture is in use on the system.

```
enumeration MemArch {MemArch_VMSA, MemArch_PMSA};  
MemArch MemorySystemArchitecture()
```

### P.7.23 ProcessorID()

This function returns an integer that uniquely identifies the executing processor in the system.

```
integer ProcessorID()
```

### P.7.24 RemapRegsHaveResetValues()

This function returns TRUE if the remap registers PRRR and NMRR have their IMPLEMENTATION DEFINED reset values, and FALSE otherwise.

```
boolean RemapRegsHaveResetValues()
```

### P.7.25 SwitchToJazelleExecution()

This procedure passes control of execution to Jazelle hardware (for a BXJ instruction).

```
SwitchToJazelleExecution()
```

### P.7.26 ThisInstr()

This function returns the bitstring encoding of the currently-executing instruction.

```
bits(32) ThisInstr()
```

———— **Note** —————

Currently, this function is used only on 32-bit instruction encodings.

### P.7.27 ThisInstrLength()

This function returns the length, in bits, of the current instruction. This means it returns 32 or 16:

```
integer ThisInstrLength()
```

### P.7.28 TLBLookupCameFromCacheMaintenance()

This function returns TRUE if a TLB lookup is caused by a [DCIMVAC](#), [DCCIMVAC](#), [DCCMVAC](#), [DCCMVAU](#), or [ICIMVAU](#) cache maintenance operation, and otherwise returns FALSE.

```
boolean TLBLookupCameFromCacheMaintenance()
```

### P.7.29 UnalignedSupport()

This function returns TRUE if the processor currently provides support for unaligned memory accesses, or FALSE otherwise. This is always TRUE in ARMv7, controllable by the SCTL.R.U bit in ARMv6, and always FALSE before ARMv6.

```
boolean UnalignedSupport()
```



# Appendix Q

## Pseudocode Index

This appendix provides an index to pseudocode operators and functions that occur elsewhere in this manual. It contains the following sections:

- *Pseudocode operators and keywords* on page AppxQ-2666
- *Pseudocode functions and procedures* on page AppxQ-2669.

## Q.1 Pseudocode operators and keywords

Table Q-1 lists the pseudocode operators and keywords, and is an index to their descriptions:

**Table Q-1 Pseudocode operators and keywords**

Operator	Meaning	See
-	Unary minus on integers or reals	<i>Unary plus, minus and absolute value on page AppxP-2654</i>
-	Subtraction of integers, reals and bitstrings	<i>Addition and subtraction on page AppxP-2654</i>
+	Unary plus on integers or reals	<i>Unary plus, minus and absolute value on page AppxP-2654</i>
+	Addition of integers, reals and bitstrings	<i>Addition and subtraction on page AppxP-2654</i>
.	Extract named member from a list	<i>Lists on page AppxP-2647</i>
.	Extract named bit or field from a register	<i>Bitstring extraction on page AppxP-2652</i>
^	Boolean exclusive-OR	<i>Operations on Booleans on page AppxP-2651</i>
:	Bitstring concatenation	<i>Bitstring concatenation and replication on page AppxP-2652</i>
:	Integer range in bitstring extraction operator	<i>Bitstring extraction on page AppxP-2652</i>
!	Boolean NOT	<i>Operations on Booleans on page AppxP-2651</i>
!=	Compare for non-equality (any type)	<i>Equality and non-equality testing on page AppxP-2651</i>
!=	Compare for non-equality (between integers and reals)	<i>Comparisons on page AppxP-2654</i>
(...)	Around arguments of procedure	<i>Procedure calls on page AppxP-2656, Procedure and function definitions on page AppxP-2659</i>
(...)	Around arguments of function	<i>General expression syntax on page AppxP-2649, Procedure and function definitions on page AppxP-2659</i>
[...]	Around array index	<i>Arrays on page AppxP-2648</i>
[...]	Around arguments of array-like function	<i>General expression syntax on page AppxP-2649, Procedure and function definitions on page AppxP-2659</i>
*	Multiplication of integers and reals	<i>Multiplication on page AppxP-2654</i>
/	Division of integers and reals (real result)	<i>Division and modulo on page AppxP-2655</i>
/*...*/	Comment delimiters	<i>Comments on page AppxP-2659</i>
//	Introduces comment terminated by end of line	<i>Comments on page AppxP-2659</i>
&&	Boolean AND	<i>Operations on Booleans on page AppxP-2651</i>
<	Less than comparison of integers and reals	<i>Comparisons on page AppxP-2654</i>
<...>	Extraction of specified bits of bitstring or integer	<i>Bitstring extraction on page AppxP-2652</i>
<<	Multiply integer by power of 2 (with rounding towards -infinity)	<i>Scaling on page AppxP-2655</i>

**Table Q-1 Pseudocode operators and keywords (continued)**

<b>Operator</b>	<b>Meaning</b>	<b>See</b>
<=	<i>Less than or equal</i> comparison of integers and reals	<i>Comparisons</i> on page AppxP-2654
=	Assignment	<i>Assignments</i> on page AppxP-2656
==	Compare for equality (any type)	<i>Equality and non-equality testing</i> on page AppxP-2651
==	Compare for equality (between integers and reals)	<i>Comparisons</i> on page AppxP-2654
>	<i>Greater than</i> comparison of integers and reals	<i>Comparisons</i> on page AppxP-2654
>=	<i>Greater than or equal</i> comparison of integers and reals	<i>Comparisons</i> on page AppxP-2654
>>	Divide integer by power of 2 (with rounding towards -infinity)	<i>Scaling</i> on page AppxP-2655
	Boolean OR	<i>Operations on Booleans</i> on page AppxP-2651
2^N	Power of two (real result)	<i>Scaling</i> on page AppxP-2655
AND	Bitwise AND of bitstrings	<i>Logical operations on bitstrings</i> on page AppxP-2652
array	Keyword introducing array type definition	<i>Arrays</i> on page AppxP-2648
bit	Bitstring type of length 1	<i>Bitstrings</i> on page AppxP-2645
bits(N)	Bitstring type of length N	<i>Bitstrings</i> on page AppxP-2645
boolean	Boolean type	<i>Booleans</i> on page AppxP-2646
case ... of ...	Control structure	<i>case ... of ...</i> on page AppxP-2658
DIV	Quotient from integer division	<i>Division and modulo</i> on page AppxP-2655
enumeration	Keyword introducing enumeration type definition	<i>Enumerations</i> on page AppxP-2646
EOR	Bitwise EOR of bitstrings	<i>Logical operations on bitstrings</i> on page AppxP-2652
FALSE	Boolean constant	<i>Booleans</i> on page AppxP-2646
for ...	Control structure	<i>for ...</i> on page AppxP-2658
if ... then ... else ...	Expression selecting between two values	<i>Conditional selection</i> on page AppxP-2651
if ... then ... else ...	Control structure	<i>if ... then ... else ...</i> on page AppxP-2657
IMPLEMENTATION_DEFINED	Describes IMPLEMENTATION_DEFINED behavior	<i>IMPLEMENTATION_DEFINED</i> on page AppxP-2657
integer	Unbounded integer type	<i>Integers</i> on page AppxP-2646
MOD	Remainder from integer division	<i>Division and modulo</i> on page AppxP-2655
OR	Bitwise OR of bitstrings	<i>Logical operations on bitstrings</i> on page AppxP-2652
otherwise	Introduces default case in case ... of ... control structure	<i>case ... of ...</i> on page AppxP-2658

**Table Q-1 Pseudocode operators and keywords (continued)**

<b>Operator</b>	<b>Meaning</b>	<b>See</b>
real	Real number type	<i>Reals</i> on page AppxP-2646
repeat ... until ...	Control structure	<i>repeat ... until ...</i> on page AppxP-2658
return	Procedure or function return	<i>Return statements</i> on page AppxP-2656
SEE	Points to other pseudocode to use instead	<i>SEE...</i> on page AppxP-2656
SUBARCHITECTURE_DEFINED	Describes SUBARCHITECTURE_DEFINED behavior	<i>SUBARCHITECTURE_DEFINED</i> on page AppxP-2657
TRUE	Boolean constant	<i>Booleans</i> on page AppxP-2646
UNDEFINED	Cause Undefined Instruction exception	<i>UNDEFINED</i> on page AppxP-2656
UNKNOWN	Unspecified value	<i>General expression syntax</i> on page AppxP-2649
UNPREDICTABLE	Unspecified behavior	<i>UNPREDICTABLE</i> on page AppxP-2656
when	Introduces specific case in case ... of ... control structure	<i>case ... of ...</i> on page AppxP-2658
while ... do ...	Control structure	<i>while ... do</i> on page AppxP-2658



## Q.2 Pseudocode functions and procedures

Table Q-2 lists the pseudocode functions and procedures used in this manual, and is an index to their descriptions:

**Table Q-2 Pseudocode functions and procedures**

Function	Meaning	See
<code>_D[]</code>	Advanced SIMD and Floating-point Extension 64-bit extension register bank	<i>Pseudocode details of Advanced SIMD and Floating-point Extension registers on page A2-57.</i>
<code>_Dclone[]</code>	Copy of Advanced SIMD and Floating-point Extension 64-bit extension register bank	
<code>_Mem[]<sup>a</sup></code>	Basic memory accesses	<i>Basic memory accesses on page B2-1293.</i>
<code>_R[]</code>	The physical array of Banked ARM core registers	<i>Pseudocode details of ARM core register operations on page B1-1144.</i>
<code>Abs()<sup>a</sup></code>	Absolute value of an integer or real	<i>Unary plus, minus and absolute value on page AppxP-2654.</i>
<code>AddWithCarry()</code>	Addition of bitstrings, with carry input and carry/overflow outputs	<i>Pseudocode details of addition and subtraction on page A2-43.</i>
<code>AdvancedSIMDExpandImm()</code>	Expansion of immediates for Advanced SIMD instructions	<i>Advanced SIMD expand immediate pseudocode on page A7-271.</i>
<code>Align()<sup>a</sup></code>	Align integer or bitstring to multiple of an integer	<i>Rounding and aligning on page AppxP-2655.</i>
<code>AlignmentFault()</code>	Generate an Alignment fault on the memory system in use	<i>Interfaces to memory system specific pseudocode on page B2-1293.</i>
<code>AlignmentFaultP()</code>	Generate an Alignment fault on the PMSA memory system	<i>Alignment fault on page B5-1804.</i>
<code>AlignmentFaultV()</code>	Generate an Alignment fault on the VMSA memory system	<i>Alignment fault on page B3-1503.</i>
<code>ALUWritePC()</code>	Write value to PC, with interworking for ARM only from ARMv7	<i>Pseudocode details of operations on ARM core registers on page A2-47.</i>
<code>ArchVersion()<sup>a</sup></code>	Major version number of the architecture	<i>ArchVersion() on page AppxP-2660.</i>
<code>ARMEExpandImm_C()</code>	Expansion of immediates for ARM instructions, with carry output	<i>Operation of modified immediate constants, ARM instructions on page A5-201.</i>
<code>ARMEExpandImm()</code>	Expansion of immediates for ARM instructions	
<code>ASR_C()</code>	Arithmetic shift right of a bitstring, with carry output	<i>Pseudocode details of shift and rotate operations on page A2-41.</i>
<code>ASR()</code>	Arithmetic shift right of a bitstring	
<code>BadMode()</code>	Test whether mode number is valid	<i>Pseudocode details of mode operations on page B1-1142.</i>
<code>BankedRegisterAccessValid()</code>	Checks for MRS or MSR accesses to the Banked ARM core registers that are UNPREDICTABLE	<i>Pseudocode support for the Banked register transfer instructions on page B9-1974</i>

**Table Q-2 Pseudocode functions and procedures (continued)**

<b>Function</b>	<b>Meaning</b>	<b>See</b>
BigEndian()	Returns TRUE if big-endian memory accesses selected	<i>Pseudocode details of ENDIANSTATE operations on page A2-53.</i>
BigEndianReverse()	Endian-reverse the bytes of a bitstring	<i>Reverse endianness on page B2-1296.</i>
BitCount() <sup>a</sup>	Count number of ones in a bitstring	<i>Bitstring count on page AppxP-2652.</i>
BKPTInstrDebugEvent() <sup>a</sup>	Generate a debug event for a BKPT instruction	<i>Debug events on page C3-2078.</i>
BranchTo()	Continue execution at specified address	<i>Pseudocode details of ARM core register operations on page B1-1144.</i>
BranchWritePC()	Write value to PC, without interworking	<i>Pseudocode details of operations on ARM core registers on page A2-47.</i>
BreakpointDebugEvent() <sup>a</sup>	Generate a debug event for a breakpoint	<i>Debug events on page C3-2078.</i>
BreakpointLinkMatch()	Check whether an access matches a linked breakpoint definition	<i>Breakpoints and Vector catches on page C3-2078.</i>
BreakpointMatch()	Check whether an instruction unit access matches a breakpoint definition	
BreakpointValueMatch()	Check whether the value part of a breakpoint definition matches	
BreakpointWatchpointStateMatch()	Check whether the state part of a breakpoint or watchpoint definition matches	
BXWritePC()	Write value to PC, with interworking	<i>Pseudocode details of operations on ARM core registers on page A2-47.</i>
CallHypervisor()	Generate exception for HVC instruction	<i>Calling the hypervisor on page B3-1519</i>
CallSupervisor()	Generate exception for SVC instruction	<i>Calling the supervisor on page A8-299.</i>
CheckAdvSIMDEnabled()	Undefined Instruction exception if the Advanced SIMD Extension is not enabled	<i>Pseudocode details of enabling the Advanced SIMD and Floating-point Extensions on page B1-1234.</i>
CheckAdvSIMDorVFPEEnabled()	Undefined Instruction exception if the specified one of the Advanced SIMD and Floating-point Extensions is not enabled	
CheckDomain()	VMSA check for Domain fault	<i>Domain checking on page B3-1505.</i>
CheckPermission()	Memory system check of access permissions	<i>Access permission checking on page B2-1298.</i>
CheckPermissionS2()	VMSA check of access permissions on a stage 2 translation	<i>Stage 2 translation table walk on page B3-1516</i>
CheckVFPEEnabled()	Undefined Instruction exception if the Floating-point Extension is not enabled	<i>Pseudocode details of enabling the Advanced SIMD and Floating-point Extensions on page B1-1234.</i>
ClearEventRegister() <sup>a</sup>	Clear the Event Register of the current processor	<i>Pseudocode details of the Wait For Event lock mechanism on page B1-1201.</i>

**Table Q-2 Pseudocode functions and procedures (continued)**

<b>Function</b>	<b>Meaning</b>	<b>See</b>
ClearExclusiveByAddress() <sup>a</sup>	Clear global exclusive monitor records for an address range	<i>Exclusive monitors operations on page B2-1297.</i>
ClearExclusiveLocal() <sup>a</sup>	Clear local exclusive monitor record of a processor	
CombineS1S2Desc()	Combine the access permissions from stages 1 and 2 of a VMSA access	<i>Stage 2 translation table walk on page B3-1516</i>
ConditionPassed()	Returns TRUE if the current instruction passes its condition code check	<i>Pseudocode details of conditional execution on page A8-289.</i>
Consistent() <sup>a</sup>	Test identically-named instruction bits or fields are identical	<i>Instruction encoding diagrams and instruction pseudocode on page AppxP-2643.</i>
ConvertAttrHints()	Convert Normal memory cacheability attribute to separate attribute and allocation hint	<i>Translation table walk using the Short-descriptor translation table format for stage 1 on page B3-1506</i>
Coproc_Accepted()	Determine whether a coprocessor accepts an instruction	<i>Pseudocode details of coprocessor operations on page A8-296.</i>
Coproc_DoneLoading() <sup>a</sup>	Returns TRUE if enough words have been loaded, for an LDC or LDC2 instruction	
Coproc_DoneStoring() <sup>a</sup>	Returns TRUE if enough words have been stored, for an STC or STC2 instruction	
Coproc_GetOneWord() <sup>a</sup>	Get word from coprocessor, for an MRC or MRC2 instruction	
Coproc_GetTwoWords() <sup>a</sup>	Get two words from coprocessor, for an MRRC or MRRC2 instruction	
Coproc_GetWordToStore() <sup>a</sup>	Get next word to store from coprocessor, for STC or STC2 instruction	
Coproc_InternalOperation() <sup>a</sup>	Instruct coprocessor to perform an internal operation, for a CDP or CDP2 instruction	
Coproc_SendLoadedWord() <sup>a</sup>	Send next loaded word to coprocessor, for LDC or LDC2 instruction	
Coproc_SendOneWord() <sup>a</sup>	Send word to coprocessor, for an MCR or MCR2 instruction	
Coproc_SendTwoWords() <sup>a</sup>	Send two words to coprocessor, for an MCRR or MCRR2 instruction	
CounterEnabled()	Returns TRUE if PMN <sub>x</sub> counts events in the current mode and state	<i>Pseudocode details of event filtering on page C12-2309</i>
CountLeadingSignBits() <sup>a</sup>	Number of identical sign bits at left end of bitstring, excluding the leftmost bit itself	<i>Lowest and highest set bits of a bitstring on page AppxP-2653.</i>
CountLeadingZeroBits() <sup>a</sup>	Number of zeros at left end of bitstring	

**Table Q-2 Pseudocode functions and procedures (continued)**

Function	Meaning	See
CP14DebugInstrDecode() <sup>a</sup>	Decodes an accepted access to a CP14 debug register	<i>Pseudocode details of coprocessor operations on page A8-296</i>
CP14JazelleInstrDecode() <sup>a</sup>	Decodes an accepted access to a CP14 Jazelle register	
CP14TraceInstrDecode() <sup>a</sup>	Decodes an accepted access to a CP14 Trace register	
CP15InstrDecode() <sup>a</sup>	Decodes an accepted access to a CP15 register	
CPSRWriteByInstr()	<b>CPSR</b> write by an instruction	<i>Pseudocode details of PSR operations on page B1-1152.</i>
CPxInstrDecode()	Decodes an accepted access to a coprocessor other than CP10, CP11, CP14 or CP15	<i>Pseudocode details of coprocessor operations on page A8-296</i>
CurrentCond() <sup>a</sup>	Returns the condition code for the current instruction	<i>Pseudocode details of conditional execution on page A8-289.</i>
CurrentInstrSet()	Returns the instruction set currently in use	<i>Pseudocode details of ISETSTATE operations on page A2-51.</i>
CurrentModeIsHyp()	Returns TRUE if current mode is Hyp mode	<i>Pseudocode details of mode operations on page B1-1142.</i>
CurrentModeIsNotUser()	Returns TRUE if current mode executes at PL1 or higher	
CurrentModeIsUserOrSystem()	Returns TRUE if current mode is User or System mode	
D[]	Doubleword or double-precision view of the Advanced SIMD and Floating-point Extension registers	<i>Pseudocode details of Advanced SIMD and Floating-point Extension registers on page A2-57.</i>
DataAbort()	Cause a Data Abort exception of a specified type	<i>Data Abort exception on page B2-1300.</i>
DataMemoryBarrier() <sup>a</sup>	Perform a Data Memory Barrier operation	<i>Pseudocode details of memory barriers on page A3-154.</i>
DataSynchronizationBarrier() <sup>a</sup>	Perform a Data Synchronization Barrier operation	
Debug_CheckDataAccess()	Check a data access for watchpoints	<i>Watchpoints on page C3-2085.</i>
Debug_CheckInstruction()	Check an instruction access for breakpoints and Vector catches	<i>Breakpoints and Vector catches on page C3-2078.</i>
DecodeImmShift()	Decode shift type and amount for an immediate shift	<i>Pseudocode details of instruction-specified shifts and rotates on page A8-292.</i>
DecodeRegShift()	Decode shift type for a register-controlled shift	
DefaultMemoryAttributes()	Determine memory attributes for an address in the PMSA default memory map	<i>Default memory map attributes on page B5-1805.</i>
DefaultTEXDecode()	Determine default memory attributes for a set of TEX[2:0], C, B bits	

**Table Q-2 Pseudocode functions and procedures (continued)**

<b>Function</b>	<b>Meaning</b>	<b>See</b>
Din[]	Returns a Doubleword register from the _DC1one[] copy of the Advanced SIMD and Floating-point Extension registers	<i>Pseudocode details of Advanced SIMD and Floating-point Extension registers on page A2-57</i>
Elem[]	Access element of a vector	<i>Advanced SIMD vectors on page A2-60.</i>
EncodeLDFSR()	Return the fault encoding for a VMSA access using the Long-descriptor translation table format	<i>Data Abort exception on page B2-1300</i>
EncodePMSAFSR()	Return the fault encoding for a PMSA access	
EncodeSDFSR()	Return the fault encoding for a VMSA access using the Short-descriptor translation table format	
EncodingSpecificOperations() <sup>a</sup>	Invoke encoding-specific pseudocode and should be checks	<i>Instruction encoding diagrams and instruction pseudocode on page AppxP-2643.</i>
EndOfInstruction() <sup>a</sup>	Terminate processing of current instruction	<i>EndOfInstruction() on page AppxP-2660.</i>
EnterHypMode()	Performs entry to Hyp mode	<i>Additional pseudocode functions for exception handling on page B1-1223.</i>
EnterMonitorMode()	Performs entry to Monitor mode	
EventRegistered() <sup>a</sup>	Determine whether the Event Register of the current processor is set	<i>Pseudocode details of the Wait For Event lock mechanism on page B1-1201.</i>
ExclusiveMonitorsPass()	Check whether Store-Exclusive operation has control of exclusive monitors	<i>Exclusive monitors operations on page B2-1297.</i>
ExcVectorBase()	Return non-Monitor mode exception base address for current security state	<i>Pseudocode determination of the exception base address on page B1-1167.</i>
FCSETranslate()	FCSE virtual address to modified virtual address translation	<i>FCSE translation on page B3-1503</i>
FixedToFP()	Convert integer or fixed-point to floating-point	<i>Floating-point conversions on page A2-90.</i>
FPAbs()	Floating-point absolute value	<i>Floating-point negation and absolute value on page A2-75.</i>
FPAdd()	Floating-point addition	<i>Floating-point addition and subtraction on page A2-82.</i>
FPCompare()	Floating-point comparison, producing NZCV condition flag result	<i>Floating-point comparisons on page A2-80.</i>
FPCompareEQ()	Floating-point test for equality	
FPCompareGE()	Floating-point test for greater than or equal	
FPCompareGT()	Floating-point test for greater than	
FPDefaultNaN()	Generate floating-point default NaN	<i>Generation of specific floating-point values on page A2-73.</i>
FPDiv()	Floating-point division	<i>Floating-point multiplication and division on page A2-83.</i>

**Table Q-2 Pseudocode functions and procedures (continued)**

<b>Function</b>	<b>Meaning</b>	<b>See</b>
FPCDoubleToSingle()	Convert double-precision floating-point to single-precision floating-point	<i>Floating-point conversions on page A2-90.</i>
FPHalfToSingle()	Convert half-precision floating-point to single-precision floating-point	
FPHalfSub()	Subtracts one floating-point value from another and halves the result	<i>Floating-point reciprocal square root estimate and step on page A2-87</i>
FPIInfinity()	Generate floating-point infinity	<i>Generation of specific floating-point values on page A2-73.</i>
FPCMax()	Floating-point maximum	<i>Floating-point maximum and minimum on page A2-81.</i>
FPCMaxNormal()	Generate maximum normalized floating-point value	<i>Generation of specific floating-point values on page A2-73.</i>
FPCMin()	Floating-point minimum	<i>Floating-point maximum and minimum on page A2-81.</i>
FPCMul()	Floating-point multiplication	<i>Floating-point multiplication and division on page A2-83.</i>
FPCMulAdd()	Floating-point fused multiply-add	<i>Floating-point fused multiply-add on page A2-84.</i>
FPCNeg()	Floating-point negation	<i>Floating-point negation and absolute value on page A2-75.</i>
FPCProcessException()	Process a floating-point exception	<i>Floating-point exception and NaN handling on page A2-76.</i>
FPCProcessNaN()	Generate correct result and exceptions for a NaN operand	
FPCProcessNaNs()	Perform NaN operand checks and processing for a 2-operand floating-point operation	
FPCProcessNaNs3()	Perform NaN operand checks and processing for a 3-operand floating-point operation	
FPCRecipEstimate()	Floating-point reciprocal estimate	<i>Floating-point reciprocal estimate and step on page A2-85.</i>
FPCRecipStep()	Floating-point 2-xy operation for Newton-Raphson reciprocal iteration	
FPCRound()	Floating-point rounding	<i>Floating-point rounding on page A2-78.</i>
FPCRSqrtEstimate()	Floating-point reciprocal square root estimate	<i>Floating-point reciprocal square root estimate and step on page A2-87.</i>
FPCRSqrtStep()	Floating-point (3-xy)/2 operation for Newton-Raphson reciprocal square root iteration	
FPCSingleToDouble()	Convert single-precision floating-point to double-precision floating-point	<i>Floating-point conversions on page A2-90.</i>
FPCSingleToHalf()	Convert single-precision floating-point to half-precision floating-point	

**Table Q-2 Pseudocode functions and procedures (continued)**

<b>Function</b>	<b>Meaning</b>	<b>See</b>
FPSqrt()	Floating-point square root	<i>Floating-point square root on page A2-87.</i>
FPSub()	Floating-point subtraction	<i>Floating-point addition and subtraction on page A2-82.</i>
FPTThree()	Generate floating-point value 3.0	<i>Generation of specific floating-point values on page A2-73.</i>
FPToFixed()	Convert floating-point to integer or fixed-point	<i>Floating-point conversions on page A2-90.</i>
FPTwo()	Generate floating-point value 2.0	<i>Generation of specific floating-point values on page A2-73.</i>
FPUnpack()	Produce type, sign bit and real value of a floating-point number	<i>Floating-point value unpacking on page A2-75.</i>
FPZero()	Generate floating-point zero	<i>Generation of specific floating-point values on page A2-73.</i>
GenerateAlignmentException() <sup>a</sup>	Generate the exception for a failed address alignment check	<i>GenerateAlignmentException() on page AppxP-2660.</i>
GenerateCoproprocessorException() <sup>a</sup>	Generate the exception for an unclaimed coprocessor instruction	<i>GenerateCoproprocessorException() on page AppxP-2660.</i>
GenerateIntegerZeroDivide() <sup>a</sup>	Generate the exception for a trapped divide-by-zero for an integer divide instruction	<i>GenerateIntegerZeroDivide() on page AppxP-2660.</i>
HaveEightBitWatchpointBAS() <sup>a</sup>	Returns TRUE if watchpoint matching uses eight bits for byte address select and FALSE if it uses four	<i>Watchpoints on page C3-2085.</i>
HaveLPAE() <sup>a</sup>	Returns TRUE if the implementation includes the Large Physical Address Extension	<i>HaveLPAE() on page AppxP-2660</i>
HaveMPEExt() <sup>a</sup>	Returns TRUE if the implementation includes the Multiprocessing Extensions	<i>HaveMPEExt() on page AppxP-2660.</i>
HaveSecurityExt() <sup>a</sup>	Returns TRUE if the implementation includes the Security Extensions	<i>Pseudocode details of Secure state operations on page B1-1157.</i>
HaveVirtExt() <sup>a</sup>	Returns TRUE if the implementation includes the Virtualization Extensions	<i>HaveVirtExt() on page AppxP-2660.</i>
HighestSetBit() <sup>a</sup>	Position of leftmost 1 in a bitstring	<i>Lowest and highest set bits of a bitstring on page AppxP-2653.</i>
Hint_Debug() <sup>a</sup>	Perform function of DBG hint instruction	<i>Hint_Debug() on page AppxP-2661.</i>
Hint_PreloadData() <sup>a</sup>	Perform function of PLD memory hint instruction	<i>Hint_PreloadData() on page AppxP-2661.</i>
Hint_PreloadDataForWrite() <sup>a</sup>	Perform function of PLDW Memory hint instruction	<i>Hint_PreloadDataForWrite() on page AppxP-2661.</i>
Hint_PreloadInstr() <sup>a</sup>	Perform function of PLI memory hint instruction	<i>Hint_PreloadInstr() on page AppxP-2661.</i>



**Table Q-2 Pseudocode functions and procedures (continued)**

<b>Function</b>	<b>Meaning</b>	<b>See</b>
<code>Hint_Yield()</code> <sup>a</sup>	Perform function of YIELD hint instruction	<i>Hint_Yield()</i> on page AppxP-2661.
<code>InITBlock()</code>	Return TRUE if current instruction is in an IT block	<i>Pseudocode details of ITSTATE operations</i> on page A2-52.
<code>InstrIsPL0Undefined()</code> <sup>a</sup>	Return TRUE if instruction is UNDEFINED at PL0	<i>InstrIsPL0Undefined()</i> on page AppxP-2661
<code>InstructionSynchronizationBarrier()</code> <sup>a</sup>	Perform an Instruction Synchronization Barrier operation	<i>Pseudocode details of memory barriers</i> on page A3-154.
<code>Int()</code>	Convert bitstring to integer in argument-specified fashion	<i>Converting bitstrings to integers</i> on page AppxP-2653.
<code>IntegerZeroDivideTrappingEnabled()</code> <sup>a</sup>	Check whether divide-by-zero trapping is enabled for integer divide instructions	<i>IntegerZeroDivideTrappingEnabled()</i> on page AppxP-2661.
<code>IsAlignmentFault()</code> <sup>a</sup>	Returns TRUE if exception being processed is caused by an Alignment fault	<i>IsAlignmentFault()</i> on page AppxP-2661
<code>IsAsyncAbort()</code> <sup>a</sup>	Returns TRUE if abort being processed is asynchronous	<i>IsAsyncAbort()</i> on page AppxP-2662.
<code>IsExclusiveGlobal()</code> <sup>a</sup>	Check a global exclusive access record	<i>Exclusive monitors operations</i> on page B2-1297.
<code>IsExclusiveLocal()</code> <sup>a</sup>	Check a local exclusive access record	
<code>IsExternalAbort()</code> <sup>a</sup>	Returns TRUE if abort being processed is an external abort	<i>IsExternalAbort()</i> on page AppxP-2661.
<code>IsOnes()</code>	Test for all-ones bitstring (Boolean result)	<i>Testing a bitstring for being all zero or all ones</i> on page AppxP-2653.
<code>IsOnesBit()</code>	Test for all-ones bitstring (bit result)	
<code>IsSecure()</code>	Returns TRUE in Secure state or if no Security Extensions	<i>Pseudocode details of Secure state operations</i> on page B1-1157.
<code>IsZero()</code>	Test for all-zeros bitstring (Boolean result)	<i>Testing a bitstring for being all zero or all ones</i> on page AppxP-2653.
<code>IsZeroBit()</code>	Test for all-zeros bitstring (bit result)	
<code>ITAdvance()</code>	Advance the ITSTATE bits to their values for the next instruction	<i>Pseudocode details of ITSTATE operations</i> on page A2-52.
<code>JazelleAcceptsExecution()</code> <sup>a</sup>	Returns TRUE if the Jazelle extension can start bytecode execution	<i>JazelleAcceptsExecution()</i> on page AppxP-2662.
<code>LastInITBlock()</code>	Return TRUE if current instruction is the last instruction of an IT block	<i>Pseudocode details of ITSTATE operations</i> on page A2-52.
<code>Len()</code> <sup>a</sup>	Bitstring length	<i>Bitstring length and most significant bit</i> on page AppxP-2651.
<code>LoadWritePC()</code>	Write value to PC, with interworking (without it before ARMv5T)	<i>Pseudocode details of operations on ARM core registers</i> on page A2-47.
<code>LookUpRName()</code>	Find Banked register for specified register number and mode	<i>Pseudocode details of ARM core register operations</i> on page B1-1144.
<code>LowestSetBit()</code> <sup>a</sup>	Position of rightmost 1 in a bitstring	<i>Lowest and highest set bits of a bitstring</i> on page AppxP-2653.



**Table Q-2 Pseudocode functions and procedures (continued)**

<b>Function</b>	<b>Meaning</b>	<b>See</b>
LR	Access the LR from the main ARM core register bank, R[], using current mode	<i>Pseudocode details of ARM core register operations on page B1-1144</i>
LSInstructionSyndrome() <sup>a</sup>	Returns extended syndrome information for a fault reported in the HSR	<i>LSInstructionSyndrome() on page AppxP-2662</i>
LSL_C()	Logical shift left of a bitstring, with carry output	<i>Pseudocode details of shift and rotate operations on page A2-41.</i>
LSL()	Logical shift left of a bitstring	
LSR_C()	Logical shift right of a bitstring, with carry output	
LSR()	Logical shift right of a bitstring	
MAIRDecode()	Use MAIR <sub>n</sub> or HMAIR <sub>n</sub> to decode the Attr[2:0] field from a translation table descriptor	<i>Translation table walk using the Long-descriptor translation table format for stage 1 on page B3-1510</i>
MarkExclusiveGlobal() <sup>a</sup>	Set a global exclusive access record	<i>Exclusive monitors operations on page B2-1297.</i>
MarkExclusiveLocal() <sup>a</sup>	Set a local exclusive access record	
Max() <sup>a</sup>	Maximum of integers or reals	<i>Maximum and minimum on page AppxP-2655.</i>
MemA_unpriv[]	Memory access that must be aligned, unprivileged	<i>Aligned memory accesses on page B2-1294.</i>
MemA_with_priv[]	Memory access that must be aligned, at specified privilege level	
MemA[]	Memory access that must be aligned, at current privilege level	
MemorySystemArchitecture() <sup>a</sup>	Return memory architecture of system, VMSA or PMSA	<i>MemorySystemArchitecture() on page AppxP-2662.</i>
MemU_unpriv[]	Memory access without alignment requirement, unprivileged	<i>Unaligned memory accesses on page B2-1295.</i>
MemU_with_priv[]	Memory access without alignment requirement, at specified privilege level	
MemU[]	Memory access without alignment requirement, at current privilege level	
Min() <sup>a</sup>	Minimum of integers or reals	<i>Maximum and minimum on page AppxP-2655.</i>
NOT() <sup>a</sup>	Bitwise inversion of a bitstring	<i>Logical operations on bitstrings on page AppxP-2652.</i>
NullCheckIfThumbEE()	Perform base register null check if a ThumbEE instruction	<i>Null checking on page A9-1113.</i>
Ones() <sup>a</sup>	All-ones bitstring	<i>Bitstring concatenation and replication on page AppxP-2652.</i>

**Table Q-2 Pseudocode functions and procedures (continued)**

Function	Meaning	See
PC	Access the PC from the main ARM core register bank, R[], using current mode	<i>Pseudocode details of ARM core register operations on page B1-1144</i>
PCStoreValue()	Value stored when an ARM instruction stores the PC	<i>Pseudocode details of operations on ARM core registers on page A2-47.</i>
PMUIRQ()	Returns a value that corresponds to the level-sensitive overflow interrupt request	<i>Pseudocode details of overflow interrupt requests on page C12-2305</i>
PolynomialMult()	Multiplication of polynomials over {0, 1}	<i>Pseudocode details of polynomial multiplication on page A2-93.</i>
ProcessorID() <sup>a</sup>	Return integer identifying the processor	<i>ProcessorID() on page AppxP-2662.</i>
Q[]	Quadword view of the Advanced SIMD and Floating-point Extension registers	<i>Pseudocode details of Advanced SIMD and Floating-point Extension registers on page A2-57.</i>
Qin[]	Returns a Quadword register from the _DC1one[] copy of the Advanced SIMD and Floating-point Extension registers	
R[]	Access the main ARM core register bank, using current mode	<i>Pseudocode details of ARM core register operations on page B1-1144.</i>
RBankSelect()	Evaluate register Banking for R8-R14	
RemappedTEXDecode()	Determine memory attributes for a set of TEX[2:0], C, B bits when TEX remap enabled	<i>Memory access decode when TEX remap is enabled on page B3-1520.</i>
RemapRegsHaveResetValues() <sup>a</sup>	Check PRRR and NMRR for reset values	<i>RemapRegsHaveResetValues() on page AppxP-2662.</i>
Replicate() <sup>a</sup>	Bitstring replication	<i>Bitstring concatenation and replication on page AppxP-2652.</i>
ResetControlRegisters() <sup>a</sup>	Resets CP14 and CP15 registers and register fields to their defined reset values	For VMSAv7, <i>Pseudocode details of resetting CP14 and CP15 registers on page B3-1451.</i> For PMSAv7, <i>Pseudocode details of resetting CP14 and CP15 registers on page B5-1777.</i>
RfiqBankSelect()	Evaluate register Banking for R8-R12	<i>Pseudocode details of ARM core register operations on page B1-1144.</i>
Rmode[]	Access the main ARM core register bank, using specified mode	
ROR_C()	Rotate right of a bitstring, with carry output	<i>Pseudocode details of shift and rotate operations on page A2-41.</i>
ROR()	Rotate right of a bitstring	
RoundDown() <sup>a</sup>	Round real to integer, rounding towards -infinity	<i>Rounding and aligning on page AppxP-2655.</i>
RoundTowardsZero() <sup>a</sup>	Round real to integer (rounding towards zero)	
RoundUp() <sup>a</sup>	Round real to integer (rounding towards +infinity)	

**Table Q-2 Pseudocode functions and procedures (continued)**

<b>Function</b>	<b>Meaning</b>	<b>See</b>
RRX_C()	Rotate right with extend of a bitstring, with carry output	<i>Pseudocode details of shift and rotate operations on page A2-41.</i>
RRX()	Rotate right with extend of a bitstring	
S[]	Single word/single-precision view of the Advanced SIMD and Floating-point Extension registers	<i>Pseudocode details of Advanced SIMD and Floating-point Extension registers on page A2-57.</i>
S2AttrDecode()	Decode the Attr[3:0] from a stage 2 translation table descriptor	<i>Translation table walk using the Long-descriptor translation table format for stage 1 on page B3-1510.</i>
Sat()	Convert integer to bitstring with specified saturation	<i>Pseudocode details of saturation on page A2-44.</i>
SatQ()	Convert integer to bitstring with specified saturation, with saturated flag output	
SecondStageTranslate()	Perform a stage 2 translation for a VMSA memory access.	<i>Stage 2 translation table walk on page B3-1516</i>
SelectInstrSet()	Sets the instruction set currently in use	<i>Pseudocode details of ISETSTATE operations on page A2-51.</i>
SendEvent() <sup>a</sup>	Perform function of SEV hint instruction	<i>Pseudocode details of the Wait For Event lock mechanism on page B1-1201.</i>
SerializeVFP() <sup>a</sup>	Ensure exceptional conditions in preceding Floating-point Extension instructions have been detected	<i>Asynchronous bounces, serialization, and Floating-point exception barriers on page B1-1237.</i>
SetExclusiveMonitors()	Set exclusive monitors for a Load-Exclusive operation	<i>Exclusive monitors operations on page B2-1297.</i>
Shift_C()	Perform a specified shift by a specified amount on a bitstring, with carry output	<i>Pseudocode details of instruction-specified shifts and rotates on page A8-292.</i>
Shift()	Perform a specified shift by a specified amount on a bitstring	
SignedSat()	Convert integer to bitstring with signed saturation	<i>Pseudocode details of saturation on page A2-44.</i>
SignedSatQ()	Convert integer to bitstring with signed saturation, with saturated flag output	
SignExtend() <sup>a</sup>	Extend bitstring to left with copies of its leftmost bit	<i>Zero-extension and sign-extension of bitstrings on page AppxP-2653.</i>
SInt()	Convert bitstring to integer in signed (two's complement) fashion	<i>Converting bitstrings to integers on page AppxP-2653.</i>
SP	Access the SP from the main ARM core register bank, R[], using current mode	<i>Pseudocode details of ARM core register operations on page B1-1144</i>
SPSR[]	Access the <b>SPSR</b> of the current mode	<i>Pseudocode details of PSR operations on page B1-1152.</i>

**Table Q-2 Pseudocode functions and procedures (continued)**

<b>Function</b>	<b>Meaning</b>	<b>See</b>
SPSRaccessValid()	Checks for MRS or MSR accesses to the Banked SPSRs that are UNPREDICTABLE	<i>Pseudocode support for the Banked register transfer instructions on page B9-1974</i>
SPSRwriteByInstr()	SPSR write by an instruction	<i>Pseudocode details of PSR operations on page B1-1152</i>
Sqrt() <sup>a</sup>	Calculate the square root of an integer or real number	<i>Square root on page AppxP-2655.</i>
StandardFPSCRValue()	Returns the FPSCR value that selects ARM standard floating-point arithmetic	<i>Selection of ARM standard floating-point arithmetic on page A2-79.</i>
SwitchToJazelleExecution() <sup>a</sup>	Start Jazelle extension execution of bytecodes	<i>SwitchToJazelleExecution() on page AppxP-2662.</i>
TakeDataAbortException()	Perform a Data Abort exception entry	<i>Pseudocode description of taking the Data Abort exception on page B1-1215.</i>
TakeHVCEException()	Perform a Hypervisor Call exception entry	<i>Pseudocode description of taking the Hypervisor Call exception on page B1-1212.</i>
TakeHypTrapException()	Perform a Hyp Trap exception entry	<i>Pseudocode description of taking the Hyp Trap exception on page B1-1209.</i>
TakePhysicalFIQException()	Perform an FIQ interrupt exception entry	<i>Pseudocode description of taking the FIQ exception on page B1-1221.</i>
TakePhysicalIRQException()	Perform an IRQ interrupt exception entry	<i>Pseudocode description of taking the IRQ exception on page B1-1219.</i>
TakePrefetchAbortException()	Perform a Prefetch Abort exception entry	<i>Pseudocode description of taking the Prefetch Abort exception on page B1-1213.</i>
TakeReset()	Perform a Reset exception entry	<i>Pseudocode description of taking the Reset exception on page B1-1205.</i>
TakeSMCEException()	Perform a Secure Monitor Call exception entry	<i>Pseudocode description of taking the Secure Monitor Call exception on page B1-1211.</i>
TakeSVCEException()	Perform a Supervisor Call exception entry	<i>Pseudocode description of taking the Supervisor Call exception on page B1-1209.</i>
TakeUndefInstrException()	Perform an Undefined Instruction exception entry	<i>Pseudocode description of taking the Undefined Instruction exception on page B1-1207.</i>
TakeVirtualAbortException()	Perform a Virtual Data Abort exception entry	<i>Pseudocode description of taking the Virtual Abort exception on page B1-1217.</i>
TakeVirtualFIQException()	Perform a Virtual FIQ interrupt exception entry	<i>Pseudocode description of taking the Virtual FIQ exception on page B1-1223.</i>
TakeVirtualIRQException()	Perform a Virtual IRQ interrupt exception entry	<i>Pseudocode description of taking the Virtual IRQ exception on page B1-1220.</i>

**Table Q-2 Pseudocode functions and procedures (continued)**

<b>Function</b>	<b>Meaning</b>	<b>See</b>
TestEventCNTP() TestEventCNTx() TestEventCNTV()	Test the counters to generate an event in the event stream when required	<i>Event streams</i> on page B8-1962
ThisInstr() <sup>a</sup>	Returns the bitstring encoding of the current instruction	<i>ThisInstr()</i> on page AppxP-2662.
ThisInstrLength() <sup>a</sup>	Returns the length of the current instruction	<i>ThisInstrLength()</i> on page AppxP-2662.
ThumbExpandImm_C()	Expansion of immediates for Thumb instructions, with carry output	<i>Operation of modified immediate constants, Thumb instructions</i> on page A6-233.
ThumbExpandImm()	Expansion of immediates for Thumb instructions	.
TLBLookupCameFromCacheMaintenance() <sup>a</sup>	Returns TRUE if a TLB lookup is caused by a cache maintenance operation	<i>TLBLookupCameFromCacheMaintenance()</i> on page AppxP-2663
TopBit() <sup>a</sup>	Leftmost bit of a bitstring	<i>Bitstring length and most significant bit</i> on page AppxP-2651.
TranslateAddress()	Perform address translation and obtain memory attributes for a memory access	<i>Interfaces to memory system specific pseudocode</i> on page B2-1293.
TranslateAddressP()	Perform address translation and obtain memory attributes for a PMSA memory access	<i>Address translation</i> on page B5-1804.
TranslateAddressV()	Perform address translation and obtain memory attributes for a VMSA memory access	
TranslateAddressVS10ff()	Perform address translation and obtain memory attributes for a VMSA memory access when the stage 1 MMU is disabled	<i>Address translation when the stage 1 MMU is disabled</i> on page B3-1505
TranslationTableWalkLD()	Perform translation table walk using Short-descriptor format stage 1 translation tables	<i>Translation table walk using the Long-descriptor translation table format for stage 1</i> on page B3-1510.
TranslationTableWalkSD()	Perform translation table walk using Short-descriptor format stage 1 translation tables	<i>Translation table walk using the Short-descriptor translation table format for stage 1</i> on page B3-1506.
UInt()	Convert bitstring to integer in unsigned fashion	<i>Converting bitstrings to integers</i> on page AppxP-2653.
UnalignedSupport() <sup>a</sup>	Check whether unaligned memory access support is in use	<i>UnalignedSupport()</i> on page AppxP-2663.
UnsignedRecipEstimate()	Unsigned fixed-point reciprocal estimate	<i>Floating-point reciprocal estimate and step</i> on page A2-85.
UnsignedRSqrtEstimate()	Unsigned fixed-point reciprocal square root estimate	<i>Floating-point reciprocal square root estimate and step</i> on page A2-87.

**Table Q-2 Pseudocode functions and procedures (continued)**

<b>Function</b>	<b>Meaning</b>	<b>See</b>
UnsignedSat()	Convert integer to bitstring with unsigned saturation	<i>Pseudocode details of saturation on page A2-44.</i>
UnsignedSatQ()	Convert integer to bitstring with unsigned saturation, with saturated flag output	
VCR_OnTakingInterrupt()	Track most recently used interrupt vectors for Vector catch purposes	<i>Breakpoints and Vector catches on page C3-2078.</i>
VCRMatch()	Check whether a Vector catch occurs for an instruction unit access	
VCRVectorMatch()	Check whether an instruction unit access matches a vector	
VectorCatchDebugEvent() <sup>a</sup>	Generate a debug event for a Vector catch	<i>Debug events on page C3-2078.</i>
VFPExcBarrier() <sup>a</sup>	Ensure all outstanding Floating-point Extension exception processing has occurred	<i>Asynchronous bounces, serialization, and Floating-point exception barriers on page B1-1237.</i>
VFPEExpandImm()	Expansion of immediates for Floating-point Extension instructions	<i>Operation of modified immediate constants, Floating-point on page A7-273.</i>
VFPSmallRegisterBank() <sup>a</sup>	Returns TRUE if 16-doubleword Floating-point Extension register bank implemented	<i>Pseudocode details of Advanced SIMD and Floating-point Extension registers on page A2-57.</i>
WaitForEvent() <sup>a</sup>	Wait until WFE instruction completes	<i>Pseudocode details of the Wait For Event lock mechanism on page B1-1201.</i>
WaitForInterrupt() <sup>a</sup>	Wait until WFI instruction completes	<i>Pseudocode details of Wait For Interrupt on page B1-1203.</i>
WatchpointDebugEvent() <sup>a</sup>	Generate a debug event for a watchpoint	<i>Debug events on page C3-2078.</i>
WatchpointMatch()	Check whether a data access matches a watchpoint definition	<i>Watchpoints on page C3-2085.</i>
WriteHSR()	Writes a syndrome value to the HSR	<i>Writing to the HSR on page B3-1519</i>
ZeroExtend() <sup>a</sup>	Extend bitstring to left with zero bits	<i>Zero-extension and sign-extension of bitstrings on page AppxP-2653.</i>
Zeros() <sup>a</sup>	All-zeros bitstring	<i>Bitstring concatenation and replication on page AppxP-2652.</i>

a. Prototype only. This manual gives only the prototype for the function, and a summary of its purpose. For all other functions, this manual includes the complete pseudocode function.

# Appendix R

## Register Index

This appendix provides an index to the descriptions of the ARM registers in this manual. It contains the following sections:

- *Alphabetic index of ARMv7 registers, by register name* on page AppxR-2684
- *Full registers index* on page AppxR-2695.

## R.1 Alphabetic index of ARMv7 registers, by register name

Table R-1 is an index of all ARMv7 registers, by their register names. It does not include:

- IMPLEMENTATION DEFINED registers for which the architecture does not define the register names, see:
  - [Cache and TCM lockdown registers, VMSA on page B4-1750](#) and [Cache and TCM lockdown registers, PMSA on page B6-1944](#)
  - [IMPLEMENTATION DEFINED TLB control operations, VMSA on page B4-1750](#)
  - [DMA support, VMSA on page B4-1751](#) and [DMA support, PMSA on page B6-1945](#)
- Registers that are define only in architecture versions before ARMv7.

———— **Note** —————

This section is provided for users of electronic forms of this document. The short links in this table are not useful in a printed copy of this manual. However, the index in [Full registers index on page AppxR-2695](#) includes entries for all of these registers, and gives a page number reference for each register.

For the table entries for:

- Non-debug system control registers, the link in the *Name, VMSA* column links to the full description of the register in [Chapter B4 System Control Registers in a VMSA implementation](#), and the link in the *Name, PMSA* column links to the full description of the register in [Chapter B6 System Control Registers in a PMSA implementation](#).
- Some non-debug system control register encodings that are used for operations, a single section describes a number of related operations. In these cases:
  - the links in the *Name, VMSA* and *Name, PMSA* columns are to short summary sections
  - the entry in the *Description* column links to the full description of the operation.
- Other registers:
  - A link that is centered across the *Name, VMSA* and *Name, PMSA* columns links to the full description of the register. For the Debug system control register these descriptions are all in [Chapter C11 The Debug Registers](#).
  - If the name that is centered across the *Name, VMSA* and *Name, PMSA* columns is not a link, the entry in the *Description* column links to the full description of the register.

**Table R-1 Alphabetic index of ARMv7 registers, by register name**

<b>Name, VMSA</b>	<b>Name, PMSA</b>	<b>Description</b>
<a href="#">ACTLR</a>	<a href="#">ACTLR</a>	IMPLEMENTATION DEFINED Auxiliary Control Register
<a href="#">ADFSR</a>	<a href="#">ADFSR</a>	See entry for <a href="#">AxFSR</a>
<a href="#">AIDR</a>	<a href="#">AIDR</a>	IMPLEMENTATION DEFINED Auxiliary ID Register
<a href="#">AIFSR</a>	<a href="#">AIFSR</a>	See entry for <a href="#">AxFSR</a>
<a href="#">AMAIR0</a>	-	Auxiliary Memory Attribute Indirection Register 0
<a href="#">AMAIR1</a>	-	Auxiliary Memory Attribute Indirection Register 1
	<a href="#">APSR</a>	Application Program Status Register
<a href="#">ATS12NSOPR</a>	-	<a href="#">Performing address translation operations on page B4-1747</a>
<a href="#">ATS12NSOPW</a>	-	<a href="#">Performing address translation operations on page B4-1747</a>
<a href="#">ATS12NSOUR</a>	-	<a href="#">Performing address translation operations on page B4-1747</a>



**Table R-1 Alphabetic index of ARMv7 registers, by register name (continued)**

Name, VMSA	Name, PMSA	Description
ATS12NSOUW	-	<i>Performing address translation operations on page B4-1747</i>
ATS1CPR	-	<i>Performing address translation operations on page B4-1747</i>
ATS1CPW	-	<i>Performing address translation operations on page B4-1747</i>
ATS1CUR	-	<i>Performing address translation operations on page B4-1747</i>
ATS1CUW	-	<i>Performing address translation operations on page B4-1747</i>
ATS1HR	-	<i>Performing address translation operations on page B4-1747</i>
ATS1HW	-	<i>Performing address translation operations on page B4-1747</i>
AxFSR	AxFSR	ADFSR and AIFSR, Auxiliary Data and Instruction Fault Status Registers
BPIALL	BPIALL	<i>Cache and branch predictor maintenance operations, PMSA on page B6-1941</i> <i>Cache and branch predictor maintenance operations, VMSA on page B4-1740</i>
BPIALLIS	BPIALLIS	<i>Cache and branch predictor maintenance operations, PMSA on page B6-1941</i> <i>Cache and branch predictor maintenance operations, VMSA on page B4-1740</i>
BPIMVA	BPIMVA	<i>Cache and branch predictor maintenance operations, PMSA on page B6-1941</i> <i>Cache and branch predictor maintenance operations, VMSA on page B4-1740</i>
	c0-c15	<i>Full list of PMSA CP15 registers, by coprocessor register number on page B5-1792</i> <i>Full list of VMSA CP15 registers, by coprocessor register number on page B3-1481</i>
CCSIDR	CCSIDR	Cache Size ID Registers
CLIDR	CLIDR	Cache Level ID Register
	CNTACR	Counter Access Control Registers, memory-mapped interface only
	CNTCR	Counter Control Register, memory-mapped interface only
	CNTCV	Counter Count Value register, memory-mapped interface only
CNTFRQ	CNTFRQ	Counter Frequency register, see also <i>CNTFRQ</i> , <i>Counter Frequency register, system level on page AppxE-2410</i>
CNTHCTL	-	Timer PL2 Control register
CNTHP_CTL	-	PL2 Physical Timer Control register
CNTHP_CVAL	-	PL2 Physical Timer CompareValue register
CNTHP_TVAL	-	PL2 Physical TimerValue register
CNTKCTL	CNTKCTL	Timer PL1 Control register
	CNTNSAR	Counter Non-Secure Access Register, memory-mapped interface only
CNTP_CTL	CNTP_CTL	PL1 Physical Timer Control register, see also <i>CNTP_CTL</i> , <i>PL1 Physical Timer Control register, system level on page AppxE-2412</i>
CNTP_CVAL	CNTP_CVAL	PL1 Physical Timer CompareValue register, see also <i>CNTP_CVAL</i> , <i>PL1 Physical Timer CompareValue register, system level on page AppxE-2413</i>
CNTP_TVAL	CNTP_TVAL	PL1 Physical TimerValue register, see also <i>CNTP_TVAL</i> , <i>PL1 Physical TimerValue register, system level on page AppxE-2414</i>

**Table R-1 Alphanumeric index of ARMv7 registers, by register name (continued)**

Name, VMSA	Name, PMSA	Description
CNTPCT	CNTPCT	Physical Count register, see also <i>CNTPCT, Physical Count register, system level on page AppxE-2414</i>
	CNTPL0ACR	Counter PL0 Access Control Register, memory-mapped interface only
	CNTR	Counter Status Register, memory-mapped interface only
	CNTTIDR	Counter Timer ID Register, memory-mapped interface only
CNTV_CTL	CNTV_CTL	Virtual Timer Control register, see also <i>CNTV_CTL, Virtual Timer Control register, system level on page AppxE-2419</i>
CNTV_CVAL	CNTV_CVAL	Virtual Timer Compare Value register, see also <i>CNTV_CVAL, Virtual Timer Compare Value register, system level on page AppxE-2419</i>
CNTV_TVAL	CNTV_TVAL	Virtual Timer Value register, see also <i>CNTV_TVAL, Virtual Timer Value register, system level on page AppxE-2420</i>
CNTVCT	CNTVCT	Virtual Count register, see also <i>CNTVCT, Virtual Count register, system level on page AppxE-2420</i>
CNTVOFF	-	Virtual Offset register, see also <i>CNTVOFFn, Virtual Offset register, system level on page AppxE-2421</i>
CONTEXTIDR	CONTEXTIDR	Context ID Register
	CounterIDn	Counter ID registers 0-11, memory-mapped interface only
CP15DMB	CP15DMB	<i>Data and instruction barrier operations, PMSA on page B6-1943</i> <i>Data and instruction barrier operations, VMSA on page B4-1749</i>
CP15DSB	CP15DSB	<i>Data and instruction barrier operations, PMSA on page B6-1943</i> <i>Data and instruction barrier operations, VMSA on page B4-1749</i>
CP15ISB	CP15ISB	<i>Data and instruction barrier operations, PMSA on page B6-1943</i> <i>Data and instruction barrier operations, VMSA on page B4-1749</i>
CPACR	CPACR	Coprocessor Access Control Register
	CPSR	Current Program Status Register
CSSELR	CSSELR	Cache Size Selection Register
CTR	CTR	Cache Type Register
	D0 - D31	<i>Advanced SIMD and Floating-point Extension registers on page A2-56</i>
DACR	-	Domain Access Control Register
	DBGAUTHSTATUS	Authentication Status Register, Debug
	DBGBCR	Breakpoint Control Registers, Debug
	DBGBVR	Breakpoint Value Registers, Debug
	DBGBXVR	Breakpoint Extended Value Registers, Debug
	DBGCID0	Debug Component ID Register 0
	DBGCID1	Debug Component ID Register 1
	DBGCID2	Debug Component ID Register 2

**Table R-1 Alphabetic index of ARMv7 registers, by register name (continued)**

Name, VMSA	Name, PMSA	Description
	DBGCID3	Debug Component ID Register 3
	DBGCIDSR	Context ID Sampling Register, Debug
	DBGCLAIMCLR	Claim Tag Clear Register, Debug
	DBGCLAIMSET	Claim Tag Set Register, Debug
	DBGDEVID	Debug Device ID register
	DBGDEVID1	Debug Device ID register 1
	DBGDEVID2	<i>Debug identification registers on page C11-2196</i>
	DBGDEVTYPE	Device Type Register, Debug
	DBGDIDR	Debug ID Register
	DBGDRAR	Debug ROM Address Register
	DBGDRCR	Debug Run Control Register
	DBGDSAR	Debug Self Address Offset Register
	DBGDSCCR	Debug State Cache Control Register
	DBGDSCR	Debug Status and Control Register
	DBGDSMCR	Debug State MMU Control Register
	DBGDTRRX	Host to Target Data Transfer Register, Debug
	DBGDTRTX	Target to Host Data Transfer Register, Debug
	DBGEACR	External Auxiliary Control Register, Debug
	DBGECR	Event Catch Register, Debug
	DBGITCTRL	Integration Mode Control Register, Debug
	DBGITR	Instruction Transfer Register, Debug
	DBGLAR	Lock Access Register, Debug
	DBGLSR	Lock Status Register, Debug
	DBGOSDLR	OS Double Lock Register, Debug
	DBGOSLAR	OS Lock Access Register, Debug
	DBGOSLSR	OS Lock Status Register, Debug
	DBGOSSRR	OS Save and Restore Register, Debug
	DBGPCSR	Program Counter Sampling Register, Debug
	DBGPID0	Debug Peripheral ID Register 0
	DBGPID1	Debug Peripheral ID Register 1
	DBGPID2	Debug Peripheral ID Register 2
	DBGPID3	Debug Peripheral ID Register 3

**Table R-1 Alphanumeric index of ARMv7 registers, by register name (continued)**

Name, VMSA	Name, PMSA	Description
	DBGPID4	Debug Peripheral ID Register 4
	DBGPRCR	Device Powerdown and Reset Control Register, Debug
	DBGPRSR	Device Powerdown and Reset Status Register, Debug
	DBGVCR	Vector Catch Register, Debug
	DBGVIDSR	Virtualization ID Sampling Register, Debug
	DBGWCR	Watchpoint Control Registers, Debug
	DBGWFAR	Watchpoint Fault Address Register, Debug
	DBGWVR	Watchpoint Value Registers, Debug
	DCC	<i>Internal and external views of the DBGDSCR and the DCC registers on page C8-2165</i>
DCCIMVAC	DCCIMVAC	<i>Cache and branch predictor maintenance operations, PMSA on page B6-1941 Cache and branch predictor maintenance operations, VMSA on page B4-1740</i>
DCCISW	DCCISW	<i>Cache and branch predictor maintenance operations, PMSA on page B6-1941 Cache and branch predictor maintenance operations, VMSA on page B4-1740</i>
DCCMVAC	DCCMVAC	<i>Cache and branch predictor maintenance operations, PMSA on page B6-1941 Cache and branch predictor maintenance operations, VMSA on page B4-1740</i>
DCCMVAU	DCCMVAU	<i>Cache and branch predictor maintenance operations, PMSA on page B6-1941 Cache and branch predictor maintenance operations, VMSA on page B4-1740</i>
DCCSW	DCCSW	<i>Cache and branch predictor maintenance operations, PMSA on page B6-1941 Cache and branch predictor maintenance operations, VMSA on page B4-1740</i>
DCIMVAC	DCIMVAC	<i>Cache and branch predictor maintenance operations, PMSA on page B6-1941 Cache and branch predictor maintenance operations, VMSA on page B4-1740</i>
DCISW	DCISW	<i>Cache and branch predictor maintenance operations, PMSA on page B6-1941 Cache and branch predictor maintenance operations, VMSA on page B4-1740</i>
DFAR	DFAR	Data Fault Address Register
DFSR	DFSR	Data Fault Status Register
-	DRACR	Data Region Access Control Register
-	DRBAR	Data Region Base Address Register
-	DRSR	Data Region Size and Enable Register
DTLBIALL	-	<i>TLB maintenance operations, not in Hyp mode on page B4-1743</i>
DTLBIASID	-	<i>TLB maintenance operations, not in Hyp mode on page B4-1743</i>
DTLBIMVA	-	<i>TLB maintenance operations, not in Hyp mode on page B4-1743</i>
	ENDIANSTATE	Endianness mapping register
	Event	Event Register

**Table R-1 Alphabetic index of ARMv7 registers, by register name (continued)**

Name, VMSA	Name, PMSA	Description
	FAR	<i>DFAR, Data Fault Address Register; PMSA on page B6-1836</i> <i>DFAR, Data Fault Address Register; VMSA on page B4-1560</i> <i>IFAR, Instruction Fault Address Register; PMSA on page B6-1883</i> <i>IFAR, Instruction Fault Address Register; VMSA on page B4-1636</i> <i>DBGWFAR, Watchpoint Fault Address Register on page C11-2296</i> <i>CP15 c6, Watchpoint Fault Address Register; DBGWFAR on page AppxL-2531, ARMv6</i>
FCSEIDR	-	FCSE Process ID Register
FPEXC	FPEXC	Floating-Point Exception Register
	FPINST and FPINST2	Floating-Point Instruction Registers, VFP subarchitecture
FPSCR	FPSCR	Floating-point Status and Control Register
FPSID	FPSID	Floating-point System ID Register
	FSR	<i>DFSR, Data Fault Status Register; PMSA on page B6-1837</i> <i>DFSR, Data Fault Status Register; VMSA on page B4-1561</i> <i>IFSR, Instruction Fault Status Register; PMSA on page B6-1884</i> <i>IFSR, Instruction Fault Status Register; VMSA on page B4-1637</i>
HACR	-	Hyp Auxiliary Configuration Register, Virtualization Extensions
HACTLR	-	Hyp Auxiliary Control Register, Virtualization Extensions
HAMAIR0	-	Hyp Auxiliary Memory Attribute Indirection Register 0, Virtualization Extensions
HAMAIR1	-	Hyp Auxiliary Memory Attribute Indirection Register 1, Virtualization Extensions
HAXFSR	-	HADFSR and HAIFSR, Hyp Auxiliary Fault Syndrome Registers, Virtualization Extensions
HCPTR	-	Hyp Coprocessor Trap Register, Virtualization Extensions
HCR	-	Hyp Configuration Register, Virtualization Extensions
HDCR	-	Hyp Debug Configuration Register, Virtualization Extensions
HDFAR	-	Hyp Data Fault Address Register, Virtualization Extensions
HIFAR	-	Hyp Instruction Fault Address Register, Virtualization Extensions
HMAIR0	-	Hyp Memory Attribute Indirection Register 0, Virtualization Extensions
HMAIR1	-	Hyp Memory Attribute Indirection Register 1, Virtualization Extensions
HPFAR	-	Hyp IPA Fault Address Register, Virtualization Extensions
HSCTLR	-	Hyp System Control Register, Virtualization Extensions
HSR	-	Hyp Syndrome Register, Virtualization Extensions
HSTR	-	Hyp System Trap Register, Virtualization Extensions
HTCR	-	Hyp Translation Control Register, Virtualization Extensions
HTPIDR	-	Hyp Software Thread ID Register, Virtualization Extensions
HTTBR	-	Hyp Translation Table Base Register, Virtualization Extensions

**Table R-1 Alphabetic index of ARMv7 registers, by register name (continued)**

<b>Name, VMSA</b>	<b>Name, PMSA</b>	<b>Description</b>
HVBAR	-	Hyp Vector Base Address Register, Virtualization Extensions
ICIALLU	ICIALLU	<i>Cache and branch predictor maintenance operations, PMSA on page B6-1941</i> <i>Cache and branch predictor maintenance operations, VMSA on page B4-1740</i>
ICIALLUIS	ICIALLUIS	<i>Cache and branch predictor maintenance operations, PMSA on page B6-1941</i> <i>Cache and branch predictor maintenance operations, VMSA on page B4-1740</i>
ICIMVAU	ICIMVAU	<i>Cache and branch predictor maintenance operations, PMSA on page B6-1941</i> <i>Cache and branch predictor maintenance operations, VMSA on page B4-1740</i>
ID_AFR0	ID_AFR0	Auxiliary Feature Register 0
ID_DFR0	ID_DFR0	Debug Feature Register 0
ID_ISAR0	ID_ISAR0	Instruction Set Attribute Register 0
ID_ISAR1	ID_ISAR1	Instruction Set Attribute Register 1
ID_ISAR2	ID_ISAR2	Instruction Set Attribute Register 2
ID_ISAR3	ID_ISAR3	Instruction Set Attribute Register 3
ID_ISAR4	ID_ISAR4	Instruction Set Attribute Register 4
ID_ISAR5	ID_ISAR5	Instruction Set Attribute Register 5
ID_MMFR0	ID_MMFR0	Memory Model Feature Register 0
ID_MMFR1	ID_MMFR1	Memory Model Feature Register 1
ID_MMFR2	ID_MMFR2	Memory Model Feature Register 2
ID_MMFR3	ID_MMFR3	Memory Model Feature Register 3
ID_PFR0	ID_PFR0	Processor Feature Register 0
ID_PFR1	ID_PFR1	Processor Feature Register 1
IFAR	IFAR	Instruction Fault Address Register
IFSR	IFSR	Instruction Fault Status Register
-	IRACR	Instruction Region Access Control Register
-	IRBAR	Instruction Region Base Address Register
-	IRSR	Instruction Region Size and Enable Register
	ISSETSTATE	Instruction set state register
ISR	-	Interrupt Status Register, Security Extensions
ITLBIALL	-	<i>TLB maintenance operations, not in Hyp mode on page B4-1743</i>
ITLBIASID	-	<i>TLB maintenance operations, not in Hyp mode on page B4-1743</i>
ITLBIMVA	-	<i>TLB maintenance operations, not in Hyp mode on page B4-1743</i>
	ITSTATE	IT block state register
JIDR	JIDR	Jazelle ID Register

**Table R-1 Alphabetic index of ARMv7 registers, by register name (continued)**

Name, VMSA	Name, PMSA	Description
JMCR	JMCR	Jazelle Main Configuration Register
JOSCR	JOSCR	Jazelle OS Control Register
	LR	<a href="#">ARM core registers on page A2-45</a> for application level description <a href="#">ARM core registers on page B1-1143</a> for system level description
LR_abt, LR_fiq, LR_irq, LR_mon, LR_svc, LR_und, LR_usr		<a href="#">ARM core registers on page B1-1143</a>
MAIRO	-	Memory Attribute Indirection Register 0
MAIR1	-	Memory Attribute Indirection Register 1
MIDR	MIDR	Main ID Register
MPIDR	MPIDR	Multiprocessor Affinity Register
-	MPUIR	MPU Type Register
MVBAR	-	Monitor Vector Base Address Register, Security Extensions
MVFR0	MVFR0	Media and VFP Feature Register 0
MVFR1	MVFR1	Media and VFP Feature Register 1
NMRR	-	Normal Memory Remap Register
NSACR	-	Non-Secure Access Control Register, Security Extensions
PAR	-	Physical Address Register
	PC	<a href="#">ARM core registers on page A2-45</a> for application level description <a href="#">ARM core registers on page B1-1143</a> for system level description
PMAUTHSTATUS		Performance Monitors Authentication Status register, memory-mapped interface only
PMCCFILTR	PMCCFILTR	See <a href="#">PMXEVTYPER</a> (VMSA) or <a href="#">PMXEVTYPER</a> (PMSA)  <div style="text-align: center;"> <b>————— Note —————</b>                      PMCCFILTR is an obsolete name for <a href="#">PMXEVTYPER31</a>.                      —————                 </div>
PMCCNTR	PMCCNTR	Performance Monitors Cycle Count Register
PMCEID0	PMCEID0	Performance Monitors Common Event Identification Register 0
PMCEID1	PMCEID1	Performance Monitors Common Event Identification Register 1
	PMCFGR	Performance Monitors Configuration Register, memory-mapped interface only
	PMCID0	Performance Monitors Component ID register 0, memory-mapped interface only
	PMCID1	Performance Monitors Component ID register 1, memory-mapped interface only
	PMCID2	Performance Monitors Component ID register 2, memory-mapped interface only
	PMCID3	Performance Monitors Component ID register 0, memory-mapped interface only
PMCNTENCLR	PMCNTENCLR	Performance Monitors Count Enable Clear register
PMCNTENSET	PMCNTENSET	Performance Monitors Count Enable Set register



**Table R-1 Alphabetic index of ARMv7 registers, by register name (continued)**

Name, VMSA	Name, PMSA	Description
PMCR	PMCR	Performance Monitors Control Register
	PMDEVTYPE	Performance Monitors Device Type register, memory-mapped interface only
PMINTENCLR	PMINTENCLR	Performance Monitors Interrupt Enable Clear register
PMINTENSET	PMINTENSET	Performance Monitors Interrupt Enable Set register
	PMLAR	Performance Monitors Lock Access Register, memory-mapped interface only
	PMLSR	Performance Monitors Lock Status Register, memory-mapped interface only
PMOVSRR	PMOVSRR	Performance Monitors Overflow Flag Status Register
PMOVSSET	-	Performance Monitors Overflow Flag Status Set register
	PMPID0	Performance Monitors Peripheral ID register 0, memory-mapped interface only
	PMPID1	Performance Monitors Peripheral ID register 1, memory-mapped interface only
	PMPID2	Performance Monitors Peripheral ID register 2, memory-mapped interface only
	PMPID3	Performance Monitors Peripheral ID register 3, memory-mapped interface only
	PMPID4	Performance Monitors Peripheral ID register 4, memory-mapped interface only
PMSELR	PMSELR	Performance Monitors Event Counter Selection Register
PMSWINC	PMSWINC	Performance Monitors Software Increment register
PMUSERENR	PMUSERENR	Performance Monitors User Enable Register
PMXEVCNTR	PMXEVCNTR	Performance Monitors Event Count Register
PMXEVTPER	PMXEVTPER	Performance Monitors Event Type Select Register
PRRR	-	Primary Region Remap Register
	PSR	<i>Program Status Registers (PSRs) on page B1-1147</i>
	Q0-Q15	<i>Advanced SIMD and Floating-point Extension registers on page A2-56</i>
	R0_usr-R12_usr	<i>ARM core registers on page B1-1143</i>
	R0-R15	<i>ARM core registers on page A2-45 for application level description</i> <i>ARM core registers on page B1-1143 for system level description</i>
	R8_fiq-R12_fiq	<i>ARM core registers on page B1-1143</i>
REVIDR	REVIDR	Revision ID Register
-	RGNR	MPU Region Number Register
	S0-S31	<i>Advanced SIMD and Floating-point Extension registers on page A2-56</i>
SCR	-	Secure Configuration Register, Security Extensions
SCTLR	SCTLR	System Control Register
SDER	-	Secure Debug Enable Register, Security Extensions
	SP	<i>ARM core registers on page A2-45 for application level description</i> <i>ARM core registers on page B1-1143 for system level description</i>



**Table R-1 Alphabetic index of ARMv7 registers, by register name (continued)**

Name, VMSA	Name, PMSA	Description
SP_abt, SP_fiq, SP_irq, SP_mon, SP_svc, SP_und, SP_usr		<i>ARM core registers on page B1-1143</i>
SPSR		Saved Program Status Registers
SPSR_abt, SPSR_fiq, SPSR_irq, SPSR_mon, SPSR_svc, SPSR_und		<i>ARM core registers on page B1-1143</i>
TCMTR	TCMTR	TCM Type Register
TEECR	TEECR	ThumbEE Configuration Register
TEEHBR	TEEHBR	ThumbEE Handler Base Register
TLBIALL	-	<i>TLB maintenance operations, not in Hyp mode on page B4-1743</i>
TLBIALLH	-	<i>Hyp mode TLB maintenance operations, Virtualization Extensions on page B4-1746</i>
TLBIALLHIS	-	<i>Hyp mode TLB maintenance operations, Virtualization Extensions on page B4-1746</i>
TLBIALLIS	-	<i>TLB maintenance operations, not in Hyp mode on page B4-1743</i>
TLBIALLNSNH	-	<i>Hyp mode TLB maintenance operations, Virtualization Extensions on page B4-1746</i>
TLBIALLNSNHIS	-	<i>Hyp mode TLB maintenance operations, Virtualization Extensions on page B4-1746</i>
TLBIASID	-	<i>TLB maintenance operations, not in Hyp mode on page B4-1743</i>
TLBIASIDIS	-	<i>TLB maintenance operations, not in Hyp mode on page B4-1743</i>
TLBIMVA	-	<i>TLB maintenance operations, not in Hyp mode on page B4-1743</i>
TLBIMVAA	-	<i>TLB maintenance operations, not in Hyp mode on page B4-1743</i>
TLBIMVAAIS	-	<i>TLB maintenance operations, not in Hyp mode on page B4-1743</i>
TLBIMVAH	-	<i>Hyp mode TLB maintenance operations, Virtualization Extensions on page B4-1746</i>
TLBIMVAHIS	-	<i>Hyp mode TLB maintenance operations, Virtualization Extensions on page B4-1746</i>
TLBIMVAIS	-	<i>TLB maintenance operations, not in Hyp mode on page B4-1743</i>
TLBTR	-	TLB Type Register
TPIDRPRW	TPIDRPRW	PL1 only Thread ID Register
TPIDRURO	TPIDRURO	User Read-Only Thread ID Register
TPIDRURW	TPIDRURW	User Read/Write Thread ID Register
TTBCR	-	Translation Table Base Control Register
TTBR0	-	Translation Table Base Register 0
TTBR1	-	Translation Table Base Register 1
VBAR	-	Vector Base Address Register, Security Extensions
VMPIDR	-	Virtualization Multiprocessor ID Register, Virtualization Extensions

**Table R-1 Alphabetic index of ARMv7 registers, by register name (continued)**

<b>Name, VMSA</b>	<b>Name, PMSA</b>	<b>Description</b>
<a href="#">VPIDR</a>	-	Virtualization Processor ID Register, Virtualization Extensions
<a href="#">VTCR</a>	-	Virtualization Translation Control Register, Virtualization Extensions
<a href="#">VTTBR</a>	-	Virtualization Translation Table Base Register, Virtualization Extensions

## R.2 Full registers index

Table R-2 is a full alphabetic index of the registers described in this manual, that lists both the register short names and the descriptive names of all registers, and references the main description of each register. The non-debug system control registers are described separately for VMSA and PMSA implementations, in:

- Chapter B4 *System Control Registers in a VMSA implementation*
- Chapter B6 *System Control Registers in a PMSA implementation*.

Where appropriate, Table R-2 references both descriptions of a registers. The PMSA and VMSA implementations of a register can differ.

**Table R-2 Full registers index**

Register	Description, see
Access Control, Counter	<i>CNTACRn, Counter Access Control Register on page AppxE-2406</i>
Access Control, Counter PL0	<i>CNTPL0ACR, Counter PL0 Access Control Register on page AppxE-2415</i>
Access Permissions, pre-ARMv6	<i>CP15 c5, Memory Region Access Permissions Registers, DAPR and IAPR, ARMv4 and ARMv5 on page AppxO-2624</i>
ACTLR	<i>ACTLR, IMPLEMENTATION DEFINED Auxiliary Control Register, PMSA on page B6-1808</i> <i>ACTLR, IMPLEMENTATION DEFINED Auxiliary Control Register, VMSA on page B4-1522</i>
ADFSR	<i>ADFSR and AIFSR, Auxiliary Data and Instruction Fault Status Registers, PMSA on page B6-1810</i> <i>ADFSR and AIFSR, Auxiliary Data and Instruction Fault Status Registers, VMSA on page B4-1523</i>
AIDR	<i>AIDR, IMPLEMENTATION DEFINED Auxiliary ID Register, PMSA on page B6-1809</i> <i>AIDR, IMPLEMENTATION DEFINED Auxiliary ID Register, VMSA on page B4-1524</i>
AIFSR	<i>ADFSR and AIFSR, Auxiliary Data and Instruction Fault Status Registers, PMSA on page B6-1810</i> <i>ADFSR and AIFSR, Auxiliary Data and Instruction Fault Status Registers, VMSA on page B4-1523</i>
AMAIRO	<i>AMAIRO and AMAIR1, Auxiliary Memory Attribute Indirection Registers 0 and 1, VMSA on page B4-1525</i>
AMAIR1	
Application Program Status	<i>The Application Program Status Register (APSR) on page A2-49</i>
APSR	<i>The Application Program Status Register (APSR) on page A2-49</i>
ATS12NSOPR	<i>Performing address translation operations on page B4-1747</i>
ATS12NSOPW	
ATS12NSOUR	
ATS12NSOUW	
ATS1CPR	
ATS1CPW	
ATS1CUR	
ATS1CUW	
ATS1HR	
ATS1HW	

**Table R-2 Full registers index (continued)**

<b>Register</b>	<b>Description, see</b>
Authentication Status, Debug	<i>DBGAUTHSTATUS, Authentication Status register on page C11-2209</i>
Authentication Status, Performance Monitors	<i>PMAUTHSTATUS, Performance Monitors Authentication Status register on page AppxB-2361</i>
Auxiliary Control	<i>ACTLR, IMPLEMENTATION DEFINED Auxiliary Control Register, PMSA on page B6-1808 ACTLR, IMPLEMENTATION DEFINED Auxiliary Control Register, VMSA on page B4-1522</i>
Auxiliary Fault Status	<i>ADFSR and AIFSR, Auxiliary Data and Instruction Fault Status Registers, PMSA on page B6-1810 ADFSR and AIFSR, Auxiliary Data and Instruction Fault Status Registers, VMSA on page B4-1523</i>
Auxiliary Feature 0	<i>ID_AFR0, Auxiliary Feature Register 0, PMSA on page B6-1851 ID_AFR0, Auxiliary Feature Register 0, VMSA on page B4-1603</i>
Auxiliary ID	<i>AIDR, IMPLEMENTATION DEFINED Auxiliary ID Register, PMSA on page B6-1809 AIDR, IMPLEMENTATION DEFINED Auxiliary ID Register, VMSA on page B4-1524</i>
Auxiliary Memory Attribute Indirection	<i>AMAIRO and AMAIR1, Auxiliary Memory Attribute Indirection Registers 0 and 1, VMSA on page B4-1525</i>
Block Transfer Status, ARMv6	<i>CP15 c7, Block Transfer Status Register on page AppxL-2536</i>
BPIALL	<i>Cache and branch predictor maintenance operations, PMSA on page B6-1941</i>
BPIALLIS	<i>Cache and branch predictor maintenance operations, VMSA on page B4-1740</i>
BPIMVA	
Breakpoint Control, Debug	<i>DBGBCR, Breakpoint Control Registers on page C11-2211</i>
Breakpoint Extended Value, Debug	<i>DBGBXVR, Breakpoint Extended Value Registers on page C11-2217</i>
Breakpoint Value, Debug	<i>DBGBVR, Breakpoint Value Registers on page C11-2216</i>
c0 - c15	<i>Full list of PMSA CP15 registers, by coprocessor register number on page B5-1792 Full list of VMSA CP15 registers, by coprocessor register number on page B3-1481</i>
Cache and branch predictor maintenance operations	<i>Cache and branch predictor maintenance operations, PMSA on page B6-1941 Cache and branch predictor maintenance operations, VMSA on page B4-1740</i>
Cache Behavior Override, ARMv6 Security Extensions	<i>CP15 c9, Cache Behavior Override Register, CBOR on page AppxL-2541</i>
Cache Dirty Status, ARMv6	<i>CP15 c7, Cache Dirty Status Register, CDSR on page AppxL-2532</i>
Cache Level ID	<i>CLIDR, Cache Level ID Register, PMSA on page B6-1814 CLIDR, Cache Level ID Register, VMSA on page B4-1530</i>
Cache Lockdown, pre-ARMv7	<i>CP15 c9, cache lockdown support on page AppxO-2630</i>
Cache Size ID	<i>CCSIDR, Cache Size ID Registers, PMSA on page B6-1812 CCSIDR, Cache Size ID Registers, VMSA on page B4-1528</i>
Cache Size Selection	<i>CSSELR, Cache Size Selection Register, PMSA on page B6-1832 CSSELR, Cache Size Selection Register, VMSA on page B4-1555</i>
Cache Type	<i>CTR, Cache Type Register, PMSA on page B6-1833 CTR, Cache Type Register, VMSA on page B4-1556</i>

**Table R-2 Full registers index (continued)**

<b>Register</b>	<b>Description, see</b>
Cacheability, pre-ARMv6	<i>CP15 c2, Memory Region Cacheability Registers, DCR and ICR, ARMv4 and ARMv5 on page AppxO-2623</i>
CBOR, ARMv6 Security Extensions	<i>CP15 c9, Cache Behavior Override Register, CBOR on page AppxL-2541</i>
CCSIDR	<i>CCSIDR, Cache Size ID Registers, PMSA on page B6-1812 CCSIDR, Cache Size ID Registers, VMSA on page B4-1528</i>
CDSR, ARMv6	<i>CP15 c7, Cache Dirty Status Register, CDSR on page AppxL-2532</i>
Claim Tag Clear, Debug	<i>DBGCLAIMCLR, Claim Tag Clear register on page C11-2222</i>
Claim Tag Set, Debug	<i>DBGCLAIMSET, Claim Tag Set register on page C11-2223</i>
CLIDR	<i>CLIDR, Cache Level ID Register, PMSA on page B6-1814 CLIDR, Cache Level ID Register, VMSA on page B4-1530</i>
CNTACRn	<i>CNTACRn, Counter Access Control Register on page AppxE-2406</i>
CNTCR	<i>CNTCR, Counter Control Register on page AppxE-2408</i>
CNTCV	<i>CNTCV, Counter Count Value register on page AppxE-2409</i>
CNTFRQ	<i>CNTFRQ, Counter Frequency register, PMSA on page B6-1816 CNTFRQ, Counter Frequency register, system level on page AppxE-2410 CNTFRQ, Counter Frequency register, VMSA on page B4-1532</i>
CNTHCTL	<i>CNTHCTL, Timer PL2 Control register, Virtualization Extensions on page B4-1533</i>
CNTHP_CTL	<i>CNTHP_CTL, PL2 Physical Timer Control register, Virtualization Extension on page B4-1535</i>
CNTHP_CVAL	<i>CNTHP_CVAL, PL2 Physical Timer CompareValue register, Virtualization Extensions on page B4-1535</i>
CNTKCTL	<i>CNTKCTL, Timer PL1 Control register, PMSA on page B6-1817 CNTKCTL, Timer PL1 Control register, VMSA on page B4-1537</i>
CNTNSAR	<i>CNTNSAR, Counter Non-Secure Access Register on page AppxE-2411</i>
CNTP_CTL	<i>CNTP_CTL, PL1 Physical Timer Control register, PMSA on page B6-1819 CNTP_CTL, PL1 Physical Timer Control register, system level on page AppxE-2412 CNTP_CTL, PL1 Physical Timer Control register, VMSA on page B4-1539</i>
CNTP_CVAL	<i>CNTP_CVAL, PL1 Physical Timer CompareValue register, PMSA on page B6-1821 CNTP_CVAL, PL1 Physical Timer CompareValue register, system level on page AppxE-2413 CNTP_CVAL, PL1 Physical Timer CompareValue register, VMSA on page B4-1541</i>
CNTP_TVAL	<i>CNTP_TVAL, PL1 Physical TimerValue register, PMSA on page B6-1822 CNTP_TVAL, PL1 Physical TimerValue register, system level on page AppxE-2414 CNTP_TVAL, PL1 Physical TimerValue register, VMSA on page B4-1542</i>
CNTPCT	<i>CNTPCT, Physical Count register, PMSA on page B6-1823 CNTPCT, Physical Count register, system level on page AppxE-2414 CNTPCT, Physical Count register, VMSA on page B4-1543</i>
CNTPL0ACR	<i>CNTPL0ACR, Counter PL0 Access Control Register on page AppxE-2415</i>

**Table R-2 Full registers index (continued)**

<b>Register</b>	<b>Description, see</b>
CNTR	<i>CNTR, Counter Status Register on page AppxE-2417</i>
CNTTIDR	<i>CNTTIDR, Counter Timer ID Register on page AppxE-2418</i>
CNTV_CTL	<i>CNTV_CTL, Virtual Timer Control register, PMSA on page B6-1824</i> <i>CNTV_CTL, Virtual Timer Control register, system level on page AppxE-2419</i> <i>CNTV_CTL, Virtual Timer Control register, VMSA on page B4-1544</i>
CNTV_CVAL	<i>CNTV_CVAL, Virtual Timer CompareValue register, PMSA on page B6-1824</i> <i>CNTV_CVAL, Virtual Timer CompareValue register, system level on page AppxE-2419</i> <i>CNTV_CVAL, Virtual Timer CompareValue register, VMSA on page B4-1544</i>
CNTV_TVAL	<i>CNTV_TVAL, Virtual TimerValue register, PMSA on page B6-1825</i> <i>CNTV_TVAL, Virtual TimerValue register, system level on page AppxE-2420</i> <i>CNTV_TVAL, Virtual TimerValue register, VMSA on page B4-1545</i>
CNTVCT	<i>CNTVCT, Virtual Count register, PMSA on page B6-1826</i> <i>CNTVCT, Virtual Count register, system level on page AppxE-2420</i> <i>CNTVCT, Virtual Count register, VMSA on page B4-1546</i>
CNTVOFF	<i>CNTVOFFn, Virtual Offset register, system level on page AppxE-2421</i> <i>CNTVOFF, Virtual Offset register, VMSA on page B4-1547</i>
Component ID, Debug	<i>About the Debug Component Identification Registers on page C11-2208</i>
Component ID, Performance Monitors	<i>PMCID0, Performance Monitors Component ID register 0 on page AppxB-2364 -</i> <i>PMCID3, Performance Monitors Component ID register 3 on page AppxB-2365</i>
Configuration, Hyp	<i>HCR, Hyp Configuration Register, Virtualization Extensions on page B4-1580</i>
Configuration, Hyp Auxiliary	<i>HACR, Hyp Auxiliary Configuration Register, Virtualization Extensions on page B4-1574</i>
Configuration, Hyp Debug	<i>HDCR, Hyp Debug Configuration Register, Virtualization Extensions on page B4-1583</i>
Configuration, Jazelle Main	<i>JMCR, Jazelle Main Configuration Register, VMSA on page B4-1642</i> <i>JMCR, Jazelle Main Configuration Register, PMSA on page B6-1889</i>
Configuration, Performance Monitors	<i>PMCFGR, Performance Monitors Configuration Register on page AppxB-2363</i>
Configuration, Secure	<i>SCR, Secure Configuration Register, Security Extensions on page B4-1702</i>
Configuration, ThumbEE	<i>TEECR, ThumbEE Configuration Register, VMSA on page B4-1714</i> <i>TEECR, ThumbEE Configuration Register, PMSA on page B6-1937</i>
Context ID	<i>CONTEXTIDR, Context ID Register, PMSA on page B6-1827</i> <i>CONTEXTIDR, Context ID Register, VMSA on page B4-1548</i>
Context ID Sampling, Debug	<i>DBGCIDSR, Context ID Sampling Register on page C11-2221</i>
CONTEXTIDR	<i>CONTEXTIDR, Context ID Register, PMSA on page B6-1827</i> <i>CONTEXTIDR, Context ID Register, VMSA on page B4-1548</i>
Control	<i>SCTLR, System Control Register, PMSA on page B6-1930</i> <i>SCTLR, System Control Register, VMSA on page B4-1705</i>
Control, Counter	<i>CNTR, Counter Control Register on page AppxE-2408</i>

**Table R-2 Full registers index (continued)**

<b>Register</b>	<b>Description, see</b>
Coprocessor Access Control	<i>CPACR, Coprocessor Access Control Register, PMSA on page B6-1829</i> <i>CPACR, Coprocessor Access Control Register, VMSA on page B4-1551</i>
Count Enable Clear	<i>PMCNTENCLR, Performance Monitors Count Enable Clear register, PMSA on page B6-1906</i> <i>PMCNTENCLR, Performance Monitors Count Enable Clear register, VMSA on page B4-1672</i>
Count Enable Set	<i>PMCNTENSET, Performance Monitors Count Enable Set register, PMSA on page B6-1908</i> <i>PMCNTENSET, Performance Monitors Count Enable Set register, VMSA on page B4-1674</i>
Count Value, Counter	<i>CNTCV, Counter Count Value register on page AppxE-2409</i>
Counter Access Control	<i>CNTACRn, Counter Access Control Register on page AppxE-2406</i>
Counter Control	<i>CNTCR, Counter Control Register on page AppxE-2408</i>
Counter Count Value	<i>CNTCV, Counter Count Value register on page AppxE-2409</i>
Counter Frequency	<i>CNTFRQ, Counter Frequency register, PMSA on page B6-1816</i> <i>CNTFRQ, Counter Frequency register, system level on page AppxE-2410</i> <i>CNTFRQ, Counter Frequency register, VMSA on page B4-1532</i>
Counter ID0-Counter ID11	<i>CounterIDn, Counter ID registers 0-11 on page AppxE-2422</i>
Counter Non-Secure Access	<i>CNTNSAR, Counter Non-Secure Access Register on page AppxE-2411</i>
Counter PL0 Access Control	<i>CNTPL0ACR, Counter PL0 Access Control Register on page AppxE-2415</i>
Counter Status	<i>CNTSR, Counter Status Register on page AppxE-2417</i>
Counter Timer ID	<i>CNTTIDR, Counter Timer ID Register on page AppxE-2418</i>
CP15 Data Memory Barrier operation	<i>CP15DMB, CP15 Data Memory Barrier operation, PMSA on page B6-1828</i> <i>CP15DMB, CP15 Data Memory Barrier operation, VMSA on page B4-1550</i>
CP15 Data Synchronization Barrier operation	<i>CP15DSB, CP15 Data Synchronization Barrier operation, PMSA on page B6-1828</i> <i>CP15DSB, CP15 Data Synchronization Barrier operation, VMSA on page B4-1550</i>
CP15 Instruction Synchronization Barrier operation	<i>CP15ISB, CP15 Instruction Synchronization Barrier operation, PMSA on page B6-1828</i> <i>CP15ISB, CP15 Instruction Synchronization Barrier operation, VMSA on page B4-1550</i>
CP15DMB	<i>CP15DMB, CP15 Data Memory Barrier operation, PMSA on page B6-1828</i> <i>CP15DMB, CP15 Data Memory Barrier operation, VMSA on page B4-1550</i>
CP15DSB	<i>CP15DSB, CP15 Data Synchronization Barrier operation, PMSA on page B6-1828</i> <i>CP15DSB, CP15 Data Synchronization Barrier operation, VMSA on page B4-1550</i>
CP15ISB	<i>CP15ISB, CP15 Instruction Synchronization Barrier operation, PMSA on page B6-1828</i> <i>CP15ISB, CP15 Instruction Synchronization Barrier operation, VMSA on page B4-1550</i>
CPACR	<i>CPACR, Coprocessor Access Control Register, PMSA on page B6-1829</i> <i>CPACR, Coprocessor Access Control Register, VMSA on page B4-1551</i>
CPSR	<i>The Current Program Status Register (CPSR) on page B1-1147</i>
CSSELR	<i>CSSELR, Cache Size Selection Register, PMSA on page B6-1832</i> <i>CSSELR, Cache Size Selection Register, VMSA on page B4-1555</i>



**Table R-2 Full registers index (continued)**

<b>Register</b>	<b>Description, see</b>
CTR	<i>CTR, Cache Type Register, PMSA on page B6-1833</i> <i>CTR, Cache Type Register, VMSA on page B4-1556</i>
Cycle Count	<i>PMCCNTR, Performance Monitors Cycle Count Register, PMSA on page B6-1903</i> <i>PMCCNTR, Performance Monitors Cycle Count Register, VMSA on page B4-1669</i>
D0 - D31	<i>Advanced SIMD and Floating-point Extension registers on page A2-56</i>
DACR	<i>DACR, Domain Access Control Register, VMSA on page B4-1558</i>
DAPR, pre-ARMv6	<i>CP15 c5, Memory Region Access Permissions Registers, DAPR and IAPR, ARMv4 and ARMv5 on page AppxO-2624</i>
Data Fault Address	<i>DFAR, Data Fault Address Register, PMSA on page B6-1836</i> <i>DFAR, Data Fault Address Register, VMSA on page B4-1560</i>
Data Fault Status	<i>DFSR, Data Fault Status Register, PMSA on page B6-1837</i> <i>DFSR, Data Fault Status Register, VMSA on page B4-1561</i>
Data Memory Barrier operation, CP15	<i>CP15DMB, CP15 Data Memory Barrier operation, PMSA on page B6-1828</i> <i>CP15DMB, CP15 Data Memory Barrier operation, VMSA on page B4-1550</i>
Data Memory Region Access Permissions, pre-ARMv6	<i>CP15 c5, Memory Region Access Permissions Registers, DAPR and IAPR, ARMv4 and ARMv5 on page AppxO-2624</i>
Data Memory Region Bufferability, pre-ARMv6	<i>CP15 c3, Memory Region Bufferability Register, DBR, ARMv4 and ARMv5 on page AppxO-2624</i>
Data Memory Region Cacheability, pre-ARMv6	<i>CP15 c2, Memory Region Cacheability Registers, DCR and ICR, ARMv4 and ARMv5 on page AppxO-2623</i>
Data Memory Region Extended Access Permissions, pre-ARMv6	<i>CP15 c5, Memory Region Extended Access Permissions Registers, DEAPR and IEAPR, ARMv4 and ARMv5 on page AppxO-2625</i>
Data or unified Cache Lockdown, pre-ARMv7	<i>CP15 c9, cache lockdown support on page AppxO-2630</i>
Data or unified Memory Region, pre-ARMv6	<i>CP15 c6, Memory Region Registers, DMRR0-DMRR7 and IMRR0-IMRR7, ARMv4 and ARMv5 on page AppxO-2626</i>
Data or unified TLB Lockdown, pre-ARMv7	<i>CP15 c10, TLB lockdown support, VMSA on page AppxO-2636</i>
Data Region Access Control	<i>DRACR, Data Region Access Control Register, PMSA on page B6-1838</i>
Data Region Base Address	<i>DRBAR, Data Region Base Address Register, PMSA on page B6-1840</i>
Data Region Size and Enable	<i>DRSR, Data Region Size and Enable Register, PMSA on page B6-1841</i>
Data Synchronization Barrier operation, CP15	<i>CP15DSB, CP15 Data Synchronization Barrier operation, PMSA on page B6-1828</i> <i>CP15DSB, CP15 Data Synchronization Barrier operation, VMSA on page B4-1550</i>
Data TCM Non-Secure Access Control, ARMv6	<i>CP15 c9, TCM Non-Secure Access Control Registers, DTCM-NSACR and ITCM-NSACR on page AppxL-2543</i>
Data TCM Region, ARMv6	<i>CP15 c9, TCM Region Registers. DTCMRR and ITCMRR on page AppxL-2539</i>
Data Transfer, Debug	<i>DBGDTRRX, Host to Target Data Transfer register on page C11-2259</i> <i>DBGDTRTX, Target to Host Data Transfer register on page C11-2260</i>



**Table R-2 Full registers index (continued)**

<b>Register</b>	<b>Description, see</b>
DBGAUTHSTATUS	<i>DBGAUTHSTATUS, Authentication Status register on page C11-2209, Debug</i>
DBGBCR0 - DBGBCR15	<i>DBGBCR, Breakpoint Control Registers on page C11-2211, Debug</i>
DBGBVR0 - DBGBVR15	<i>DBGBVR, Breakpoint Value Registers on page C11-2216, Debug</i>
DBGBXVR0 - DBGXVR15	<i>DBGXVR, Breakpoint Extended Value Registers on page C11-2217, Debug</i>
DBGCID0 - DBGCID3	<i>About the Debug Component Identification Registers on page C11-2208, Debug</i>
DBGCIDSR	<i>DBGCIDSR, Context ID Sampling Register on page C11-2221, Debug</i>
DBGCLAIMCLR	<i>DBGCLAIMCLR, Claim Tag Clear register on page C11-2222, Debug</i>
DBGCLAIMSET	<i>DBGCLAIMSET, Claim Tag Set register on page C11-2223, Debug</i>
DBGDEVID	<i>DBGDEVID, Debug Device ID register on page C11-2224.</i>
DBGDEVID1	<i>DBGDEVID1, Debug Device ID register 1 on page C11-2227</i>
DBGDEVID2	<i>Debug identification registers on page C11-2196.</i>
DBGDEVTYPE	<i>DBGDEVTYPE, Device Type Register on page C11-2228, Debug</i>
DBGDIDR	<i>DBGDIDR, Debug ID Register on page C11-2229</i>
DBGDRAR	<i>DBGDRAR, Debug ROM Address Register on page C11-2232</i>
DBGDRCR	<i>DBGDRCR, Debug Run Control Register on page C11-2234</i>
DBGDSAR	<i>DBGDSAR, Debug Self Address Offset Register on page C11-2237</i>
DBGDSCCR	<i>DBGDSCCR, Debug State Cache Control Register on page C11-2239</i>
DBGDSCR	<i>DBGDSCR, Debug Status and Control Register on page C11-2241</i>
DBGDSCRext	<i>Internal and external views of the DBGDSCR and the DCC registers on page C8-2165, Debug</i>
DBGDSCRint	
DBGDSMCR	<i>DBGDSMCR, Debug State MMU Control Register on page C11-2257</i>
DBGDTRRX	<i>DBGDTRRX, Host to Target Data Transfer register on page C11-2259, Debug</i>
DBGDTRRXext	<i>Internal and external views of the DBGDSCR and the DCC registers on page C8-2165, Debug</i>
DBGDTRRXint	
DBGDTRTX	<i>DBGDTRTX, Target to Host Data Transfer register on page C11-2260, Debug</i>
DBGDTRTXext	<i>Internal and external views of the DBGDSCR and the DCC registers on page C8-2165</i>
DBGDTRTXint	
DBGEACR	<i>DBGEACR, External Auxiliary Control Register on page C11-2261, Debug</i>
DBGECR	<i>DBGECR, Event Catch Register on page C11-2261, Debug</i>
DBGITCTRL	<i>DBGITCTRL, Integration Mode Control register on page C11-2262, Debug</i>
DBGITR	<i>DBGITR, Instruction Transfer Register on page C11-2263, Debug</i>
DBGLAR	<i>DBGLAR, Lock Access Register on page C11-2264, Debug</i>

**Table R-2 Full registers index (continued)**

<b>Register</b>	<b>Description, see</b>
DBGLSR	<i>DBGLSR, Lock Status Register on page C11-2265, Debug</i>
DBGOSDLR	<i>DBGOSDLR, OS Double Lock Register on page C11-2266, Debug</i>
DBGOSLAR	<i>DBGOSLAR, OS Lock Access Register on page C11-2267, Debug</i>
DBGOSLSR	<i>DBGOSLSR, OS Lock Status Register on page C11-2268, Debug</i>
DBGOSSRR	<i>DBGOSSRR, OS Save and Restore Register on page C11-2270, Debug</i>
DBGPCSR	<i>DBGPCSR, Program Counter Sampling Register on page C11-2271, Debug</i>
DBGPID0 - DBGPID4	<i>About the Debug Peripheral Identification Registers on page C11-2206</i>
DBGPRCR	<i>DBGPRCR, Device Powerdown and Reset Control Register on page C11-2278, Debug</i>
DBGPRSR	<i>DBGPRSR, Device Powerdown and Reset Status Register on page C11-2282, Debug</i>
DBGVCR	<i>DBGVCR, Vector Catch Register on page C11-2286, Debug</i>
DBGVIDSR	<i>DBGVIDSR, Virtualization ID Sampling Register on page C11-2289, Debug</i>
DBGWCR0 - DBGWCR15	<i>DBGWCR, Watchpoint Control Registers on page C11-2291, Debug</i>
DBGWFAR, CP14	<i>DBGWFAR, Watchpoint Fault Address Register on page C11-2296, Debug</i>
DBGWFAR, CP15, ARMv6	<i>CP15 c6, Watchpoint Fault Address Register; DBGWFAR on page AppxL-2531, Debug</i>
DBGWVR0 - DBGWVR15	<i>DBGWVR, Watchpoint Value Registers on page C11-2297, Debug</i>
DBR, pre-ARMv6	<i>CP15 c3, Memory Region Bufferability Register; DBR, ARMv4 and ARMv5 on page AppxO-2624</i>
DCC	<i>Internal and external views of the DBGDSCR and the DCC registers on page C8-2165</i>
DCCIMVAC	<i>Cache and branch predictor maintenance operations, PMSA on page B6-1941</i>
DCCISW	<i>Cache and branch predictor maintenance operations, VMSA on page B4-1740</i>
DCCMVAC	
DCCMVAU	
DCCSW	
DCIMVAC	
DCISW	
DCLR, pre-ARMv7	<i>CP15 c9, cache lockdown support on page AppxO-2630</i>
DCLR2, pre-ARMv7	<i>CP15 c9, Format D Data or unified Cache Lockdown Register; DCLR2, ARMv4 and ARMv5 on page AppxO-2635</i>
DCR, pre-ARMv6	<i>CP15 c2, Memory Region Cacheability Registers, DCR and ICR, ARMv4 and ARMv5 on page AppxO-2623</i>
DEAPR, pre-ARMv6	<i>CP15 c5, Memory Region Extended Access Permissions Registers, DEAPR and IEAPR, ARMv4 and ARMv5 on page AppxO-2625</i>
Debug Component ID	<i>About the Debug Component Identification Registers on page C11-2208</i>
Debug Context ID Sampling	<i>DBGCIDSR, Context ID Sampling Register on page C11-2221</i>

**Table R-2 Full registers index (continued)**

<b>Register</b>	<b>Description, see</b>
Debug Device ID	<i>DBGDEVID, Debug Device ID register on page C11-2224.</i>
Debug Device ID 1	<i>DBGDEVID1, Debug Device ID register 1 on page C11-2227</i>
Debug Device ID 2	<i>Debug identification registers on page C11-2196</i>
Debug Feature 0	<i>ID_DFR0, Debug Feature Register 0, PMSA on page B6-1852</i> <i>ID_DFR0, Debug Feature Register 0, VMSA on page B4-1604</i>
Debug ID	<i>DBGDIDR, Debug ID Register on page C11-2229</i>
Debug Peripheral ID	<i>About the Debug Peripheral Identification Registers on page C11-2206</i>
Debug Program Counter Sampling	<i>DBGPCSR, Program Counter Sampling Register on page C11-2271</i>
Debug ROM Address	<i>DBGDRAR, Debug ROM Address Register on page C11-2232</i>
Debug Run Control	<i>DBGDRCR, Debug Run Control Register on page C11-2234</i>
Debug Self Address Offset	<i>DBGDSAR, Debug Self Address Offset Register on page C11-2237</i>
Debug State Cache Control	<i>DBGDSCCR, Debug State Cache Control Register on page C11-2239</i>
Debug State MMU Control	<i>DBGDSMCR, Debug State MMU Control Register on page C11-2257</i>
Debug Status and Control	<i>DBGDSCR, Debug Status and Control Register on page C11-2241</i>
Device ID 1, Debug	<i>DBGDEVID1, Debug Device ID register 1 on page C11-2227</i>
Device ID 2, Debug	<i>Debug identification registers on page C11-2196</i>
Device ID, Debug	<i>DBGDEVID, Debug Device ID register on page C11-2224</i>
Device Powerdown and Reset Control, Debug	<i>DBGPRCR, Device Powerdown and Reset Control Register on page C11-2278</i>
Device Powerdown and Reset Status, Debug	<i>DBGPRSR, Device Powerdown and Reset Status Register on page C11-2282</i>
Device Type, Debug	<i>DBGDEVTYPE, Device Type Register on page C11-2228</i>
Device Type, Performance Monitors	<i>PMDEVTYPE, Performance Monitors Device Type register on page AppxB-2366</i>
DFAR	<i>DFAR, Data Fault Address Register, PMSA on page B6-1836</i> <i>DFAR, Data Fault Address Register, VMSA on page B4-1560</i>
DFSR	<i>DFSR, Data Fault Status Register, PMSA on page B6-1837</i> <i>DFSR, Data Fault Status Register, VMSA on page B4-1561</i>
DMRR0-DMRR7, pre-ARMv6	<i>CP15 c6, Memory Region Registers, DMRR0-DMRR7 and IMRR0-IMRR7, ARMv4 and ARMv5 on page AppxO-2626</i>
Domain Access Control	<i>DACR, Domain Access Control Register, VMSA on page B4-1558</i>
Double Lock, OS, Debug	<i>DBGOSDLR, OS Double Lock Register on page C11-2266</i>
DRACR	<i>DRACR, Data Region Access Control Register, PMSA on page B6-1838</i>
DRBAR	<i>DRBAR, Data Region Base Address Register, PMSA on page B6-1840</i>

**Table R-2 Full registers index (continued)**

<b>Register</b>	<b>Description, see</b>
DRSR	<i>DRSR, Data Region Size and Enable Register, PMSA on page B6-1841</i>
DTCM-NSACR, ARMv6	<i>CP15 c9, TCM Non-Secure Access Control Registers, DTCM-NSACR and ITCM-NSACR on page AppxL-2543</i>
DTCMRR, ARMv6	<i>CP15 c9, TCM Region Registers. DTCMRR and ITCMRR on page AppxL-2539</i>
DTLBIALL	<i>TLB maintenance operations, not in Hyp mode on page B4-1743</i>
DTLBIASID	
DTLBIMVA	
DTLBLR, pre-ARMv7	<i>CP15 c10, TLB lockdown support, VMSA on page AppxO-2636</i>
DWB, pre-ARMv7	<i>Data and instruction barrier operations, PMSA on page B6-1943</i> <i>Data and instruction barrier operations, VMSA on page B4-1749</i>
ENDIANSTATE	<i>Endianness mapping register, ENDIANSTATE on page A2-53</i>
Event	<i>The Event Register on page B1-1200</i>
Event Catch, Debug	<i>DBGECR, Event Catch Register on page C11-2261</i>
Event Count	<i>PMCCNTR, Performance Monitors Cycle Count Register, PMSA on page B6-1903</i> <i>PMCCNTR, Performance Monitors Cycle Count Register, VMSA on page B4-1669</i>
Event Counter Selection	<i>PMSELR, Performance Monitors Event Counter Selection Register, PMSA on page B6-1919</i> <i>PMSELR, Performance Monitors Event Counter Selection Register, VMSA on page B4-1687</i>
Event Type Select	<i>PMXEVTYPER, Performance Monitors Event Type Select Register, PMSA on page B6-1924</i> <i>PMXEVTYPER, Performance Monitors Event Type Select Register, VMSA on page B4-1694</i>
Extended Access Permissions, pre-ARMv6	<i>CP15 c5, Memory Region Extended Access Permissions Registers, DEAPR and IEAPR, ARMv4 and ARMv5 on page AppxO-2625</i>
External Auxiliary Control, Debug	<i>DBGEACR, External Auxiliary Control Register on page C11-2261</i>
FAR	<i>See Fault Address</i>
Fault Address	<i>DFAR, Data Fault Address Register, PMSA on page B6-1836</i> <i>DFAR, Data Fault Address Register, VMSA on page B4-1560</i> <i>IFAR, Instruction Fault Address Register, PMSA on page B6-1883</i> <i>IFAR, Instruction Fault Address Register, VMSA on page B4-1636</i> <i>DBGWFAR, Watchpoint Fault Address Register on page C11-2296</i> <i>CP15 c6, Watchpoint Fault Address Register, DBGWFAR on page AppxL-2531, ARMv6</i>
Fault Status	<i>DFSR, Data Fault Status Register, PMSA on page B6-1837</i> <i>DFSR, Data Fault Status Register, VMSA on page B4-1561</i> <i>IFSR, Instruction Fault Status Register, PMSA on page B6-1884</i> <i>IFSR, Instruction Fault Status Register, VMSA on page B4-1637</i>
FCSE Process ID	<i>FCSEIDR, FCSE Process ID Register, VMSA on page B4-1565</i>
FCSEIDR	<i>FCSEIDR, FCSE Process ID Register, VMSA on page B4-1565</i>

**Table R-2 Full registers index (continued)**

<b>Register</b>	<b>Description, see</b>
Floating-point Exception	<i>FPEXC, Floating-Point Exception Control register, PMSA on page B6-1843</i> <i>FPEXC, Floating-Point Exception Control register, VMSA on page B4-1567</i>
Floating-point Instruction	<i>The Floating-Point Instruction Registers, FPINST and FPINST2 on page AppxF-2443</i>
Floating-point System ID	<i>FPSID, Floating-point System ID Register, PMSA on page B6-1848</i> <i>FPSID, Floating-point System ID Register, VMSA on page B4-1572</i>
Format D Data Cache Lockdown, pre-ARMv7	<i>CP15 c9, Format D Data or unified Cache Lockdown Register, DCLR2, ARMv4 and ARMv5 on page AppxO-2635</i>
FPEXC	<i>FPEXC, Floating-Point Exception Control register, PMSA on page B6-1843</i> <i>FPEXC, Floating-Point Exception Control register, VMSA on page B4-1567</i>
FPINST, FPINST2	<i>The Floating-Point Instruction Registers, FPINST and FPINST2 on page AppxF-2443</i>
FPSCR	<i>FPSCR, Floating-point Status and Control Register, PMSA on page B6-1845</i> <i>FPSCR, Floating-point Status and Control Register, VMSA on page B4-1569</i>
FPSID	<i>FPSID, Floating-point System ID Register, PMSA on page B6-1848</i> <i>FPSID, Floating-point System ID Register, VMSA on page B4-1572</i>
FSR	<i>See Fault Status</i>
HACR	<i>HACR, Hyp Auxiliary Configuration Register, Virtualization Extensions on page B4-1574</i>
HACTLR	<i>HACTLR, Hyp Auxiliary Control Register, Virtualization Extensions on page B4-1574</i>
HADFSR	<i>HADFSR and HAIFSR, Hyp Auxiliary Fault Syndrome Registers, Virtualization Extensions on page B4-1575</i>
HAIFSR	
HAMAIR0	<i>HAMAIR0 and HAMAIR1, Hyp Auxiliary Memory Attribute Indirection Registers 0 and 1 on page B4-1576</i>
HAMAIR0	
HAXFSR	<i>HADFSR and HAIFSR, Hyp Auxiliary Fault Syndrome Registers, Virtualization Extensions on page B4-1575</i>
HCPTR	<i>HCPTR, Hyp Coprocessor Trap Register, Virtualization Extensions on page B4-1577</i>
HCR	<i>HCR, Hyp Configuration Register, Virtualization Extensions on page B4-1580</i>
HDCR	<i>HDCR, Hyp Debug Configuration Register, Virtualization Extensions on page B4-1583</i>
HDFAR	<i>HDFAR, Hyp Data Fault Address Register, Virtualization Extensions on page B4-1586</i>
HIFAR	<i>HIFAR, Hyp Instruction Fault Address Register, Virtualization Extensions on page B4-1587</i>
HMAIR0	<i>HMAIRn, Hyp Memory Attribute Indirection Registers 0 and 1, Virtualization Extensions on page B4-1588</i>
HMAIR1	
Host to Target Data Transfer, Debug	<i>DBGDTRRX, Host to Target Data Transfer register on page C11-2259</i>
HPFAR	<i>HPFAR, Hyp IPA Fault Address Register, Virtualization Extensions on page B4-1589</i>
HSCTLR	<i>HSCTLR, Hyp System Control Register, Virtualization Extensions on page B4-1590</i>
HSR	<i>HSR, Hyp Syndrome Register, Virtualization Extensions on page B4-1593</i>

**Table R-2 Full registers index (continued)**

<b>Register</b>	<b>Description, see</b>
HSTR	<i>HSTR, Hyp System Trap Register, Virtualization Extensions on page B4-1594</i>
HTCR	<i>HTCR, Hyp Translation Control Register, Virtualization Extensions on page B4-1596</i>
HTPIDR	<i>HTPIDR, Hyp Software Thread ID Register, Virtualization Extensions on page B4-1598</i>
HTTBR	<i>HTTBR, Hyp Translation Table Base Register, Virtualization Extensions on page B4-1599</i>
HVBAR	<i>HVBAR, Hyp Vector Base Address Register, Virtualization Extensions on page B4-1601</i>
Hyp Auxiliary Configuration	<i>HACR, Hyp Auxiliary Configuration Register, Virtualization Extensions on page B4-1574</i>
Hyp Auxiliary Control	<i>HACTLR, Hyp Auxiliary Control Register, Virtualization Extensions on page B4-1574</i>
Hyp Auxiliary Fault Syndrome	<i>HADFSR and HAIFSR, Hyp Auxiliary Fault Syndrome Registers, Virtualization Extensions on page B4-1575</i>
Hyp Auxiliary Memory Attribute Indirection 0 and 1	<i>HAMAIR0 and HAMAIR1, Hyp Auxiliary Memory Attribute Indirection Registers 0 and 1 on page B4-1576</i>
Hyp Configuration	<i>HCR, Hyp Configuration Register, Virtualization Extensions on page B4-1580</i>
Hyp Coprocessor Trap	<i>HCPTTR, Hyp Coprocessor Trap Register, Virtualization Extensions on page B4-1577</i>
Hyp Data Fault Address	<i>HDFAR, Hyp Data Fault Address Register, Virtualization Extensions on page B4-1586</i>
Hyp Debug Configuration	<i>HDCR, Hyp Debug Configuration Register, Virtualization Extensions on page B4-1583</i>
Hyp Instruction Fault Address	<i>HIFAR, Hyp Instruction Fault Address Register, Virtualization Extensions on page B4-1587</i>
Hyp IPA Fault Address	<i>HPFAR, Hyp IPA Fault Address Register, Virtualization Extensions on page B4-1589</i>
Hyp Memory Attribute Indirection 0 and 1	<i>HMAIRn, Hyp Memory Attribute Indirection Registers 0 and 1, Virtualization Extensions on page B4-1588</i>
Hyp Software Thread ID	<i>HTPIDR, Hyp Software Thread ID Register, Virtualization Extensions on page B4-1598</i>
Hyp Syndrome	<i>HSR, Hyp Syndrome Register, Virtualization Extensions on page B4-1593</i>
Hyp System Control	<i>HSCTLR, Hyp System Control Register, Virtualization Extensions on page B4-1590</i>
Hyp System Trap	<i>HSTR, Hyp System Trap Register, Virtualization Extensions on page B4-1594</i>
Hyp Translation Control	<i>HTCR, Hyp Translation Control Register, Virtualization Extensions on page B4-1596</i>
Hyp Translation Table Base	<i>HTTBR, Hyp Translation Table Base Register, Virtualization Extensions on page B4-1599</i>
Hyp Vector Base Address	<i>HVBAR, Hyp Vector Base Address Register, Virtualization Extensions on page B4-1601</i>
IAPR, pre-ARMv6	<i>CP15 c5, Memory Region Access Permissions Registers, DAPR and IAPR, ARMv4 and ARMv5 on page AppxO-2624</i>
ICIALLU	<i>Cache and branch predictor maintenance operations, PMSA on page B6-1941</i>
ICIALLUIS	<i>Cache and branch predictor maintenance operations, VMSA on page B4-1740</i>
ICIMVAU	
ICLR, pre-ARMv7	<i>CP15 c9, cache lockdown support on page AppxO-2630</i>
ICR, pre-ARMv6	<i>CP15 c2, Memory Region Cacheability Registers, DCR and ICR, ARMv4 and ARMv5 on page AppxO-2623</i>



Table R-2 Full registers index (continued)

Register	Description, see
ID_AFR0	<i>ID_AFR0, Auxiliary Feature Register 0, PMSA on page B6-1851</i> <i>ID_AFR0, Auxiliary Feature Register 0, VMSA on page B4-1603</i>
ID_DFR0	<i>ID_DFR0, Debug Feature Register 0, PMSA on page B6-1852</i> <i>ID_DFR0, Debug Feature Register 0, VMSA on page B4-1604</i>
ID_ISAR0	<i>ID_ISAR0, Instruction Set Attribute Register 0, PMSA on page B6-1854</i> <i>ID_ISAR0, Instruction Set Attribute Register 0, VMSA on page B4-1607</i>
ID_ISAR1	<i>ID_ISAR1, Instruction Set Attribute Register 1, PMSA on page B6-1856</i> <i>ID_ISAR1, Instruction Set Attribute Register 1, VMSA on page B4-1609</i>
ID_ISAR2	<i>ID_ISAR2, Instruction Set Attribute Register 2, PMSA on page B6-1859</i> <i>ID_ISAR2, Instruction Set Attribute Register 2, VMSA on page B4-1612</i>
ID_ISAR3	<i>ID_ISAR3, Instruction Set Attribute Register 3, PMSA on page B6-1861</i> <i>ID_ISAR3, Instruction Set Attribute Register 3, VMSA on page B4-1614</i>
ID_ISAR4	<i>ID_ISAR4, Instruction Set Attribute Register 4, PMSA on page B6-1864</i> <i>ID_ISAR4, Instruction Set Attribute Register 4, VMSA on page B4-1617</i>
ID_ISAR5	<i>ID_ISAR5, Instruction Set Attribute Register 5, PMSA on page B6-1866</i> <i>ID_ISAR5, Instruction Set Attribute Register 5, VMSA on page B4-1619</i>
ID_MMFR0	<i>ID_MMFR0, Memory Model Feature Register 0, PMSA on page B6-1867</i> <i>ID_MMFR0, Memory Model Feature Register 0, VMSA on page B4-1620</i>
ID_MMFR1	<i>ID_MMFR1, Memory Model Feature Register 1, PMSA on page B6-1869</i> <i>ID_MMFR1, Memory Model Feature Register 1, VMSA on page B4-1622</i>
ID_MMFR2	<i>ID_MMFR2, Memory Model Feature Register 2, PMSA on page B6-1873</i> <i>ID_MMFR2, Memory Model Feature Register 2, VMSA on page B4-1626</i>
ID_MMFR3	<i>ID_MMFR3, Memory Model Feature Register 3, PMSA on page B6-1876</i> <i>ID_MMFR3, Memory Model Feature Register 3, VMSA on page B4-1629</i>
ID_PFR0	<i>ID_PFR0, Processor Feature Register 0, PMSA on page B6-1879</i> <i>ID_PFR0, Processor Feature Register 0, VMSA on page B4-1632</i>
ID_PFR1	<i>ID_PFR1, Processor Feature Register 1, PMSA on page B6-1881</i> <i>ID_PFR1, Processor Feature Register 1, VMSA on page B4-1634</i>
ID, Counter	<i>CounterIDn, Counter ID registers 0-11 on page AppxE-2422</i>
ID, Debug	<i>DBGDIDR, Debug ID Register on page C11-2229</i>
IEAPR, pre-ARMv6	<i>CP15 c5, Memory Region Extended Access Permissions Registers, DEAPR and IEAPR, ARMv4 and ARMv5 on page AppxO-2625</i>
IFAR	<i>IFAR, Instruction Fault Address Register, PMSA on page B6-1883</i> <i>IFAR, Instruction Fault Address Register, VMSA on page B4-1636</i>
IFSR	<i>IFSR, Instruction Fault Status Register, PMSA on page B6-1884</i> <i>IFSR, Instruction Fault Status Register, VMSA on page B4-1637</i>
IMRR0-IMRR7, pre-ARMv6	<i>CP15 c6, Memory Region Registers, DMRR0-DMRR7 and IMRR0-IMRR7, ARMv4 and ARMv5 on page AppxO-2626</i>

**Table R-2 Full registers index (continued)**

<b>Register</b>	<b>Description, see</b>
Instruction Cache Lockdown, pre-ARMv7	<i>CP15 c9, cache lockdown support on page AppxO-2630</i>
Instruction Fault Address	<i>IFAR, Instruction Fault Address Register, PMSA on page B6-1883</i> <i>IFAR, Instruction Fault Address Register, VMSA on page B4-1636</i>
Instruction Fault Status	<i>IFSR, Instruction Fault Status Register, PMSA on page B6-1884</i> <i>IFSR, Instruction Fault Status Register, VMSA on page B4-1637</i>
Instruction Memory Region Access Permissions, pre-ARMv6	<i>CP15 c5, Memory Region Access Permissions Registers, DAPR and IAPR, ARMv4 and ARMv5 on page AppxO-2624</i>
Instruction Memory Region Cacheability, pre-ARMv6	<i>CP15 c2, Memory Region Cacheability Registers, DCR and ICR, ARMv4 and ARMv5 on page AppxO-2623</i>
Instruction Memory Region Extended Access Permissions, pre-ARMv6	<i>CP15 c5, Memory Region Extended Access Permissions Registers, DEAPR and IEAPR, ARMv4 and ARMv5 on page AppxO-2625</i>
Instruction Memory Region, pre-ARMv6	<i>CP15 c6, Memory Region Registers, DMRR0-DMRR7 and IMRR0-IMRR7, ARMv4 and ARMv5 on page AppxO-2626</i>
Instruction Region Access Control	<i>IRACR, Instruction Region Access Control Register, PMSA on page B6-1885</i>
Instruction Region Base Address	<i>IRBAR, Instruction Region Base Address Register, PMSA on page B6-1886</i>
Instruction Region Size and Enable	<i>IRSR, Instruction Region Size and Enable Register, PMSA on page B6-1887</i>
Instruction Set Attribute	<i>About the Instruction Set Attribute registers on page B7-1950</i>
Instruction Set Attribute 0	<i>ID_ISAR0, Instruction Set Attribute Register 0, PMSA on page B6-1854</i> <i>ID_ISAR0, Instruction Set Attribute Register 0, VMSA on page B4-1607</i>
Instruction Set Attribute 1	<i>ID_ISAR1, Instruction Set Attribute Register 1, PMSA on page B6-1856</i> <i>ID_ISAR1, Instruction Set Attribute Register 1, VMSA on page B4-1609</i>
Instruction Set Attribute 2	<i>ID_ISAR2, Instruction Set Attribute Register 2, PMSA on page B6-1859</i> <i>ID_ISAR2, Instruction Set Attribute Register 2, VMSA on page B4-1612</i>
Instruction Set Attribute 3	<i>ID_ISAR3, Instruction Set Attribute Register 3, PMSA on page B6-1861</i> <i>ID_ISAR3, Instruction Set Attribute Register 3, VMSA on page B4-1614</i>
Instruction Set Attribute 4	<i>ID_ISAR4, Instruction Set Attribute Register 4, PMSA on page B6-1864</i> <i>ID_ISAR4, Instruction Set Attribute Register 4, VMSA on page B4-1617</i>
Instruction Set Attribute 5	<i>ID_ISAR5, Instruction Set Attribute Register 5, PMSA on page B6-1866</i> <i>ID_ISAR5, Instruction Set Attribute Register 5, VMSA on page B4-1619</i>
Instruction Synchronization Barrier operation, CP15	<i>CP15ISB, CP15 Instruction Synchronization Barrier operation, PMSA on page B6-1828</i> <i>CP15ISB, CP15 Instruction Synchronization Barrier operation, VMSA on page B4-1550</i>
Instruction TCM Non-Secure Access Control, ARMv6	<i>CP15 c9, TCM Non-Secure Access Control Registers, DTCM-NSACR and ITCM-NSACR on page AppxL-2543</i>



**Table R-2 Full registers index (continued)**

<b>Register</b>	<b>Description, see</b>
Instruction TCM Region, ARMv6	<i>CP15 c9, TCM Region Registers. DTCMRR and ITCMRR on page AppxL-2539</i>
Instruction TLB Invalidate All	<i>ITLBIALL, Instruction TLB Invalidate All, VMSA only on page B4-1640</i>
Instruction TLB Invalidate by ASID	<i>ITLBIASID, Instruction TLB Invalidate by ASID, VMSA only on page B4-1640</i>
Instruction TLB Invalidate by MVA	<i>ITLBIMVA, Instruction TLB Invalidate by MVA, VMSA only on page B4-1640</i>
Instruction TLB Lockdown Register, pre-ARMv7	<i>CP15 c10, TLB lockdown support, VMSA on page AppxO-2636</i>
Instruction Transfer Register, Debug	<i>DBGITR, Instruction Transfer Register on page C11-2263</i>
Integration Mode Control, Debug	<i>DBGITCTRL, Integration Mode Control register on page C11-2262</i>
Interrupt Enable Clear	<i>PMINTENCLR, Performance Monitors Interrupt Enable Clear register; PMSA on page B6-1913 PMINTENCLR, Performance Monitors Interrupt Enable Clear register; VMSA on page B4-1679</i>
Interrupt Enable Set	<i>PMINTENSET, Performance Monitors Interrupt Enable Set register; PMSA on page B6-1915 PMINTENSET, Performance Monitors Interrupt Enable Set register; VMSA on page B4-1681</i>
Interrupt Status	<i>ISR, Interrupt Status Register; Security Extensions on page B4-1639</i>
IRACR	<i>IRACR, Instruction Region Access Control Register; PMSA on page B6-1885</i>
IRBAR	<i>IRBAR, Instruction Region Base Address Register; PMSA on page B6-1886</i>
IRSR	<i>IRSR, Instruction Region Size and Enable Register; PMSA on page B6-1887</i>
ISETSTATE	<i>Instruction set state register; ISETSTATE on page A2-50</i>
ISR	<i>ISR, Interrupt Status Register; Security Extensions on page B4-1639</i>
ITCM-NSACR, ARMv6	<i>CP15 c9, TCM Non-Secure Access Control Registers, DTCM-NSACR and ITCM-NSACR on page AppxL-2543</i>
ITCMRR, ARMv6	<i>CP15 c9, TCM Region Registers. DTCMRR and ITCMRR on page AppxL-2539</i>
ITLBIALL	<i>TLB maintenance operations, not in Hyp mode on page B4-1743</i>
ITLBIASID	
ITLBIMVA	
ITLBLR, pre-ARMv7	<i>CP15 c10, TLB lockdown support, VMSA on page AppxO-2636</i>
ITSTATE	<i>IT block state register; ITSTATE on page A2-51</i>
Jazelle ID	<i>JIDR, Jazelle ID Register; PMSA on page B6-1888 JIDR, Jazelle ID Register; VMSA on page B4-1641</i>
Jazelle Main Configuration	<i>JMCR, Jazelle Main Configuration Register; PMSA on page B6-1889 JMCR, Jazelle Main Configuration Register; VMSA on page B4-1642</i>
Jazelle OS Control	<i>JOSCR, Jazelle OS Control Register; PMSA on page B6-1890 JOSCR, Jazelle OS Control Register; VMSA on page B4-1643</i>

**Table R-2 Full registers index (continued)**

<b>Register</b>	<b>Description, see</b>
JIDR	<i>JIDR, Jazelle ID Register, PMSA on page B6-1888</i> <i>JIDR, Jazelle ID Register, VMSA on page B4-1641</i>
JMCR	<i>JMCR, Jazelle Main Configuration Register, PMSA on page B6-1889</i> <i>JMCR, Jazelle Main Configuration Register, VMSA on page B4-1642</i>
JOSCR	<i>JOSCR, Jazelle OS Control Register, PMSA on page B6-1890</i> <i>JOSCR, Jazelle OS Control Register, VMSA on page B4-1643</i>
Lock Access, Debug	<i>DBGLAR, Lock Access Register on page C11-2264</i>
Lock Access, OS	<i>DBGOSLAR, OS Lock Access Register on page C11-2267</i>
Lock Access, Performance Monitors	<i>PMLAR, Performance Monitors Lock Access Register on page AppxB-2367</i>
Lock Status, Debug	<i>DBGLSR, Lock Status Register on page C11-2265</i>
Lock Status, OS	<i>DBGOSLSR, OS Lock Status Register on page C11-2268</i>
Lock Status, Performance Monitors	<i>PMLSR, Performance Monitors Lock Status Register on page AppxB-2368</i>
LR	<i>ARM core registers on page A2-45 for application level description</i> <i>ARM core registers on page B1-1143 for system level description</i>
LR_abt	<i>ARM core registers on page B1-1143</i>
LR_fiq	
LR_irq	
LR_mon	
LR_svc	
LR_und	
LR_usr	
Main ID	<i>MIDR, Main ID Register, PMSA on page B6-1892</i> <i>MIDR, Main ID Register, VMSA on page B4-1648</i>
MAIR0	<i>MAIR0 and MAIR1, Memory Attribute Indirection Registers 0 and 1, VMSA on page B4-1645</i>
MAIR1	
Media and VFP Feature	<i>About the Media and VFP Feature registers on page B7-1955</i>
Memory Attribute Indirection 0	<i>MAIR0 and MAIR1, Memory Attribute Indirection Registers 0 and 1, VMSA on page B4-1645</i>
Memory Attribute Indirection 1	
Memory Model Feature 0	<i>ID_MMFR0, Memory Model Feature Register 0, PMSA on page B6-1867</i> <i>ID_MMFR0, Memory Model Feature Register 0, VMSA on page B4-1620</i>
Memory Model Feature 1	<i>ID_MMFR1, Memory Model Feature Register 1, PMSA on page B6-1869</i> <i>ID_MMFR1, Memory Model Feature Register 1, VMSA on page B4-1622</i>

**Table R-2 Full registers index (continued)**

<b>Register</b>	<b>Description, see</b>
Memory Model Feature 2	<i>ID_MMFR2, Memory Model Feature Register 2, PMSA on page B6-1873</i> <i>ID_MMFR2, Memory Model Feature Register 2, VMSA on page B4-1626</i>
Memory Model Feature 3	<i>ID_MMFR3, Memory Model Feature Register 3, PMSA on page B6-1876</i> <i>ID_MMFR3, Memory Model Feature Register 3, VMSA on page B4-1629</i>
Memory Region Access Permissions, pre-ARMv6	<i>CP15 c5, Memory Region Access Permissions Registers, DAPR and IAPR, ARMv4 and ARMv5 on page AppxO-2624</i>
Memory Region Bufferability, pre-ARMv6	<i>CP15 c3, Memory Region Bufferability Register, DBR, ARMv4 and ARMv5 on page AppxO-2624</i>
Memory Region Cacheability, pre-ARMv6	<i>CP15 c2, Memory Region Cacheability Registers, DCR and ICR, ARMv4 and ARMv5 on page AppxO-2623</i>
Memory Region, pre-ARMv6	<i>CP15 c6, Memory Region Registers, DMRR0-DMRR7 and IMRR0-IMRR7, ARMv4 and ARMv5 on page AppxO-2626</i>
Memory Remap	<i>VMSA CP15 c10 register summary, memory remapping and TLB control registers on page B3-1478</i>
MIDR	<i>MIDR, Main ID Register, PMSA on page B6-1892</i> <i>MIDR, Main ID Register, VMSA on page B4-1648</i>
Monitor Vector Base Address	<i>MVBAR, Monitor Vector Base Address Register, Security Extensions on page B4-1653</i>
MPIDR	<i>MPIDR, Multiprocessor Affinity Register, PMSA on page B6-1894</i> <i>MPIDR, Multiprocessor Affinity Register, VMSA on page B4-1650</i>
MPU Region Number	<i>RGNR, MPU Region Number Register, PMSA on page B6-1928</i>
MPU Type	<i>MPUIR, MPU Type Register, PMSA on page B6-1897</i>
MPUIR	
Multiprocessor affinity	<i>MPIDR, Multiprocessor Affinity Register, PMSA on page B6-1894</i> <i>MPIDR, Multiprocessor Affinity Register, VMSA on page B4-1650</i>
MVBAR	<i>MVBAR, Monitor Vector Base Address Register, Security Extensions on page B4-1653</i>
MVFR0	<i>MVFR0, Media and VFP Feature Register 0, PMSA on page B6-1898</i> <i>MVFR0, Media and VFP Feature Register 0, VMSA on page B4-1654</i>
MVFR1	<i>MVFR1, Media and VFP Feature Register 1, PMSA on page B6-1901</i> <i>MVFR1, Media and VFP Feature Register 1, VMSA on page B4-1657</i>
NMRR	<i>NMRR, Normal Memory Remap Register, VMSA on page B4-1659</i>
Non-Secure Access Control	<i>NSACR, Non-Secure Access Control Register, Security Extensions on page B4-1661</i>
Non-Secure Access Control, ARMv6 differences	<i>CP15 c1, VMSA Security Extensions support on page AppxL-2529</i>
Non-Secure Access, Counter	<i>CNTNSAR, Counter Non-Secure Access Register on page AppxE-2411</i>
Normal Memory Remap	<i>NMRR, Normal Memory Remap Register, VMSA on page B4-1659</i>
NSACR	<i>CP15 c9, TCM Non-Secure Access Control Registers, DTCM-NSACR and ITCM-NSACR on page AppxL-2543</i> <i>NSACR, Non-Secure Access Control Register, Security Extensions on page B4-1661</i>

**Table R-2 Full registers index (continued)**

<b>Register</b>	<b>Description, see</b>
OS Double Lock, Debug	<i>DBGOSDLR, OS Double Lock Register on page C11-2266</i>
OS Lock Access, Debug	<i>DBGOSLAR, OS Lock Access Register on page C11-2267</i>
OS Lock Status, Debug	<i>DBGOSLSR, OS Lock Status Register on page C11-2268</i>
OS Save and Restore, Debug	<i>DBGOSSRR, OS Save and Restore Register on page C11-2270</i>
Overflow Flag Status	<i>PMOVSR, Performance Monitors Overflow Flag Status Register, PMSA on page B6-1917</i> <i>PMOVSR, Performance Monitors Overflow Flag Status Register, VMSA on page B4-1683</i>
PAR	<i>PAR, Physical Address Register, VMSA on page B4-1664</i>
PC	<i>ARM core registers on page A2-45 for application level description</i> <i>ARM core registers on page B1-1143 for system level description</i>
Performance Monitors Authentication Status	<i>PMAUTHSTATUS, Performance Monitors Authentication Status register on page AppxB-2361</i>
Performance Monitors Common Event Identification 0	<i>PMCEID0 and PMCEID1, Performance Monitors Common Event ID registers, PMSA on page B6-1904</i>
Performance Monitors Common Event Identification 1	<i>PMCEID0 and PMCEID1, Performance Monitors Common Event ID registers, VMSA on page B4-1670</i>
Performance Monitors Component ID 0-3	<i>PMCID0, Performance Monitors Component ID register 0 on page AppxB-2364 - PMCID3, Performance Monitors Component ID register 3 on page AppxB-2365</i>
Performance Monitors Configuration	<i>PMCFGR, Performance Monitors Configuration Register on page AppxB-2363</i>
Performance Monitors Control	<i>PMCR, Performance Monitors Control Register, PMSA on page B6-1910</i> <i>PMCR, Performance Monitors Control Register, VMSA on page B4-1676</i>
Performance Monitors Count Enable Clear	<i>PMCNTENCLR, Performance Monitors Count Enable Clear register, PMSA on page B6-1906</i> <i>PMCNTENCLR, Performance Monitors Count Enable Clear register, VMSA on page B4-1672</i>
Performance Monitors Count Enable Set	<i>PMCNTENSET, Performance Monitors Count Enable Set register, PMSA on page B6-1908</i> <i>PMCNTENSET, Performance Monitors Count Enable Set register, VMSA on page B4-1674</i>
Performance Monitors Cycle Count	<i>PMCCNTR, Performance Monitors Cycle Count Register, PMSA on page B6-1903</i> <i>PMCCNTR, Performance Monitors Cycle Count Register, VMSA on page B4-1669</i>
Performance Monitors Cycle Count Filter Control	see <i>PMXEVTYPYPER, Performance Monitors Event Type Select Register, VMSA on page B4-1694</i> see <i>PMXEVTYPYPER, Performance Monitors Event Type Select Register, PMSA on page B6-1924</i>
Performance Monitors Device Type	<i>PMDEVTYPE, Performance Monitors Device Type register on page AppxB-2366</i>
Performance Monitors Event Count	<i>PMXEVCNTR, Performance Monitors Event Count Register, PMSA on page B6-1923</i> <i>PMXEVCNTR, Performance Monitors Event Count Register, VMSA on page B4-1692</i>
Performance Monitors Event Counter Selection	<i>PMSELR, Performance Monitors Event Counter Selection Register, PMSA on page B6-1919</i> <i>PMSELR, Performance Monitors Event Counter Selection Register, VMSA on page B4-1687</i>
Performance Monitors Event Type Select	<i>PMXEVTYPYPER, Performance Monitors Event Type Select Register, PMSA on page B6-1924</i> <i>PMXEVTYPYPER, Performance Monitors Event Type Select Register, VMSA on page B4-1694</i>

**Table R-2 Full registers index (continued)**

<b>Register</b>	<b>Description, see</b>
Performance Monitors Interrupt Enable Clear	<i>PMINTENCLR, Performance Monitors Interrupt Enable Clear register, PMSA on page B6-1913</i> <i>PMINTENCLR, Performance Monitors Interrupt Enable Clear register, VMSA on page B4-1679</i>
Performance Monitors Interrupt Enable Set	<i>PMINTENSET, Performance Monitors Interrupt Enable Set register, PMSA on page B6-1915</i> <i>PMINTENSET, Performance Monitors Interrupt Enable Set register, VMSA on page B4-1681</i>
Performance Monitors Lock Access	<i>PMLAR, Performance Monitors Lock Access Register on page AppxB-2367</i>
Performance Monitors Lock Status	<i>PMLSR, Performance Monitors Lock Status Register on page AppxB-2368</i>
Performance Monitors Overflow Flag Status	<i>PMOVSr, Performance Monitors Overflow Flag Status Register, PMSA on page B6-1917</i> <i>PMOVSr, Performance Monitors Overflow Flag Status Register, VMSA on page B4-1683</i>
Performance Monitors Overflow Flag Status Set	<i>PMOVSSET, Performance Monitors Overflow Flag Status Set register, Virtualization Extensions on page B4-1685</i>
Performance Monitors Peripheral ID 0-4	<i>PMPID0, Performance Monitors Peripheral ID register 0 on page AppxB-2369 - PMPID4,</i> <i>Performance Monitors Peripheral ID register 4 on page AppxB-2373</i>
Performance Monitors Software Increment	<i>PMSWINC, Performance Monitors Software Increment register, PMSA on page B6-1921</i> <i>PMSWINC, Performance Monitors Software Increment register, VMSA on page B4-1689</i>
Performance Monitors User Enable	<i>PMUSERENR, Performance Monitors User Enable Register, PMSA on page B6-1922</i> <i>PMUSERENR, Performance Monitors User Enable Register, VMSA on page B4-1691</i>
Peripheral ID, Debug	<i>About the Debug Peripheral Identification Registers on page C11-2206</i>
Peripheral ID, Performance Monitors	<i>PMPID0, Performance Monitors Peripheral ID register 0 on page AppxB-2369 - PMPID4,</i> <i>Performance Monitors Peripheral ID register 4 on page AppxB-2373</i>
PFF, pre-ARMv7	<i>Data and instruction barrier operations, PMSA on page B6-1943</i> <i>Data and instruction barrier operations, VMSA on page B4-1749</i>
Physical Address	<i>PAR, Physical Address Register, VMSA on page B4-1664</i>
Physical Count	<i>CNTPCT, Physical Count register, PMSA on page B6-1823</i> <i>CNTPCT, Physical Count register, system level on page AppxE-2414</i> <i>CNTPCT, Physical Count register, VMSA on page B4-1543</i>
Physical Timer CompareValue, PL1	<i>CNTP_CVAL, PL1 Physical Timer CompareValue register, PMSA on page B6-1821</i> <i>CNTP_CVAL, PL1 Physical Timer CompareValue register, system level on page AppxE-2413</i> <i>CNTP_CVAL, PL1 Physical Timer CompareValue register, VMSA on page B4-1541</i>
Physical Timer CompareValue, PL2	<i>CNTHP_CVAL, PL2 Physical Timer CompareValue register, Virtualization Extensions on page B4-1535</i>
Physical Timer Control, PL1	<i>CNTP_CTL, PL1 Physical Timer Control register, PMSA on page B6-1819</i> <i>CNTP_CTL, PL1 Physical Timer Control register, system level on page AppxE-2412</i> <i>CNTP_CTL, PL1 Physical Timer Control register, VMSA on page B4-1539</i>
Physical Timer Control, PL2	<i>CNTHP_CTL, PL2 Physical Timer Control register, Virtualization Extension on page B4-1535</i>
Physical TimerValue, PL1	<i>CNTP_TVAL, PL1 Physical TimerValue register, PMSA on page B6-1822</i> <i>CNTP_TVAL, PL1 Physical TimerValue register, system level on page AppxE-2414</i> <i>CNTP_TVAL, PL1 Physical TimerValue register, VMSA on page B4-1542</i>



**Table R-2 Full registers index (continued)**

<b>Register</b>	<b>Description, see</b>
PL1 Physical Timer CompareValue	<i>CNTP_CVAL</i> , PL1 Physical Timer CompareValue register, PMSA on page B6-1821 <i>CNTP_CVAL</i> , PL1 Physical Timer CompareValue register, system level on page AppxE-2413 <i>CNTP_CVAL</i> , PL1 Physical Timer CompareValue register, VMSA on page B4-1541
PL1 Physical Timer Control	<i>CNTP_CTL</i> , PL1 Physical Timer Control register, PMSA on page B6-1819 <i>CNTP_CTL</i> , PL1 Physical Timer Control register, system level on page AppxE-2412 <i>CNTP_CTL</i> , PL1 Physical Timer Control register, VMSA on page B4-1539
PL1 Physical TimerValue	<i>CNTP_TVAL</i> , PL1 Physical TimerValue register, PMSA on page B6-1822 <i>CNTP_TVAL</i> , PL1 Physical TimerValue register, system level on page AppxE-2414 <i>CNTP_TVAL</i> , PL1 Physical TimerValue register, VMSA on page B4-1542
PL1 Timer Control	<i>CNTKCTL</i> , Timer PL1 Control register, PMSA on page B6-1817 <i>CNTKCTL</i> , Timer PL1 Control register, VMSA on page B4-1537
PL2 Physical Timer CompareValue	<i>CNTHP_CVAL</i> , PL2 Physical Timer CompareValue register, Virtualization Extensions on page B4-1535
PL2 Physical Timer Control	<i>CNTHP_CTL</i> , PL2 Physical Timer Control register, Virtualization Extension on page B4-1535
PMAUTHSTATUS	<i>PMAUTHSTATUS</i> , Performance Monitors Authentication Status register on page AppxB-2361
PMCCFILTR	An obsolete name for PMXEVTYP31. See either: <ul style="list-style-type: none"> <li><i>PMXEVTYP31</i>, Performance Monitors Event Type Select Register, VMSA on page B4-1694</li> <li><i>PMXEVTYP31</i>, Performance Monitors Event Type Select Register, PMSA on page B6-1924</li> </ul>
PMCCNTR	<i>PMCCNTR</i> , Performance Monitors Cycle Count Register, PMSA on page B6-1903 <i>PMCCNTR</i> , Performance Monitors Cycle Count Register, VMSA on page B4-1669
PMCEID0	<i>PMCEID0</i> and <i>PMCEID1</i> , Performance Monitors Common Event ID registers, PMSA on page B6-1904
PMCEID1	<i>PMCEID0</i> and <i>PMCEID1</i> , Performance Monitors Common Event ID registers, VMSA on page B4-1670
PMCFGR	<i>PMCFGR</i> , Performance Monitors Configuration Register on page AppxB-2363
PMCID0-3	<i>PMCID0</i> , Performance Monitors Component ID register 0 on page AppxB-2364 - <i>PMCID3</i> , Performance Monitors Component ID register 3 on page AppxB-2365
PMCNTENCLR	<i>PMCNTENCLR</i> , Performance Monitors Count Enable Clear register, PMSA on page B6-1906 <i>PMCNTENCLR</i> , Performance Monitors Count Enable Clear register, VMSA on page B4-1672
PMCNTENSET	<i>PMCNTENSET</i> , Performance Monitors Count Enable Set register, PMSA on page B6-1908 <i>PMCNTENSET</i> , Performance Monitors Count Enable Set register, VMSA on page B4-1674
PMCR	<i>PMCR</i> , Performance Monitors Control Register, PMSA on page B6-1910 <i>PMCR</i> , Performance Monitors Control Register, VMSA on page B4-1676
PMDEVTYPE	<i>PMDEVTYPE</i> , Performance Monitors Device Type register on page AppxB-2366
PMINTENCLR	<i>PMINTENCLR</i> , Performance Monitors Interrupt Enable Clear register, PMSA on page B6-1913 <i>PMINTENCLR</i> , Performance Monitors Interrupt Enable Clear register, VMSA on page B4-1679
PMINTENSET	<i>PMINTENSET</i> , Performance Monitors Interrupt Enable Set register, PMSA on page B6-1915 <i>PMINTENSET</i> , Performance Monitors Interrupt Enable Set register, VMSA on page B4-1681
PMLAR	<i>PMLAR</i> , Performance Monitors Lock Access Register on page AppxB-2367

**Table R-2 Full registers index (continued)**

<b>Register</b>	<b>Description, see</b>
PMLSR	<i>PMLSR, Performance Monitors Lock Status Register on page AppxB-2368</i>
PMOVS	<i>PMOVS, Performance Monitors Overflow Flag Status Register, PMSA on page B6-1917</i> <i>PMOVS, Performance Monitors Overflow Flag Status Register, VMSA on page B4-1683</i>
PMOVSSET	<i>PMOVSSET, Performance Monitors Overflow Flag Status Set register, Virtualization Extensions on page B4-1685</i>
PMPID0-4	<i>PMPID0, Performance Monitors Peripheral ID register 0 on page AppxB-2369 - PMPID4, Performance Monitors Peripheral ID register 4 on page AppxB-2373</i>
PMSELR	<i>PMSELR, Performance Monitors Event Counter Selection Register, PMSA on page B6-1919</i> <i>PMSELR, Performance Monitors Event Counter Selection Register, VMSA on page B4-1687</i>
PMSWINC	<i>PMSWINC, Performance Monitors Software Increment register, PMSA on page B6-1921</i> <i>PMSWINC, Performance Monitors Software Increment register, VMSA on page B4-1689</i>
PMUSERENR	<i>PMUSERENR, Performance Monitors User Enable Register, PMSA on page B6-1922</i> <i>PMUSERENR, Performance Monitors User Enable Register, VMSA on page B4-1691</i>
PMXEVCNTR	<i>PMXEVCNTR, Performance Monitors Event Count Register, PMSA on page B6-1923</i> <i>PMXEVCNTR, Performance Monitors Event Count Register, VMSA on page B4-1692</i>
PMXEVTYPER	<i>PMXEVTYPER, Performance Monitors Event Type Select Register, PMSA on page B6-1924</i> <i>PMXEVTYPER, Performance Monitors Event Type Select Register, VMSA on page B4-1694</i>
Powerdown and Reset Control	<i>DBGPRCR, Device Powerdown and Reset Control Register on page C11-2278</i>
Powerdown and Reset Status	<i>DBGPRSR, Device Powerdown and Reset Status Register on page C11-2282</i>
Prefetch Status, ARMv6	<i>CP15 c7, Block Transfer Status Register on page AppxL-2536</i>
Primary Region Remap	<i>PRRR, Primary Region Remap Register, VMSA on page B4-1698</i>
Processor Feature 0	<i>ID_PFR0, Processor Feature Register 0, PMSA on page B6-1879</i> <i>ID_PFR0, Processor Feature Register 0, VMSA on page B4-1632</i>
Processor Feature 1	<i>ID_PFR1, Processor Feature Register 1, PMSA on page B6-1881</i> <i>ID_PFR1, Processor Feature Register 1, VMSA on page B4-1634</i>
Program Counter Sampling, Debug	<i>DBGPCSR, Program Counter Sampling Register on page C11-2271</i>
PRRR	<i>PRRR, Primary Region Remap Register, VMSA on page B4-1698</i>
PSR	<i>Program Status Registers (PSRs) on page B1-1147</i>
Q0 - Q15	<i>Advanced SIMD and Floating-point Extension registers on page A2-56</i>
R0 - R15	<i>ARM core registers on page A2-45 for application level description</i> <i>ARM core registers on page B1-1143 for system level description</i>
R0_usr - R12_usr	<i>ARM core registers on page B1-1143</i>
R8_fiq - R12_fiq	
REVIDR	<i>REVIDR, Revision ID Register, PMSA on page B6-1927</i> <i>REVIDR, Revision ID Register, VMSA on page B4-1701</i>
Revision ID	

**Table R-2 Full registers index (continued)**

<b>Register</b>	<b>Description, see</b>
RGNR	<i>RGNR, MPU Region Number Register, PMSA on page B6-1928</i>
Run Control, Debug	<i>DBGDRCR, Debug Run Control Register on page C11-2234</i>
S0 - S31	<i>Advanced SIMD and Floating-point Extension registers on page A2-56</i>
SCR	<i>SCR, Secure Configuration Register, Security Extensions on page B4-1702</i>
SCTLR	<i>SCTLR, System Control Register, PMSA on page B6-1930</i> <i>SCTLR, System Control Register, VMSA on page B4-1705</i>
SDER	<i>SDER, Secure Debug Enable Register, Security Extensions on page B4-1712</i>
Secure Configuration	<i>SCR, Secure Configuration Register, Security Extensions on page B4-1702</i>
Secure Debug Enable	<i>SDER, Secure Debug Enable Register, Security Extensions on page B4-1712</i>
Software Increment	<i>PMSWINC, Performance Monitors Software Increment register, VMSA on page B4-1689</i>
Software Thread ID	<i>Miscellaneous operations, functional group on page B5-1802, for PMSA description</i> <i>Miscellaneous operations, functional group on page B3-1499, for VMSA description</i>
SP	<i>ARM core registers on page A2-45 for application level description</i> <i>ARM core registers on page B1-1143 for system level description</i>
SP_abt	<i>ARM core registers on page B1-1143</i>
SP_fiq	
SP_irq	
SP_mon	
SP_svc	
SP_und	
SP_usr	
SPSR	<i>The Saved Program Status Registers (SPSRs) on page B1-1148</i>
SPSR_abt	<i>ARM core registers on page B1-1143</i>
SPSR_fiq	
SPSR_irq	
SPSR_mon	
SPSR_svc	
SPSR_und	
Status and Control, Debug	<i>DBGDSCR, Debug Status and Control Register on page C11-2241</i>
Status, Counter	<i>CNTSR, Counter Status Register on page AppxE-2417</i>
System Control	<i>PMSA CP15 c1 register summary, system control registers on page B5-1788</i> <i>VMSA CP15 c1 register summary, system control registers on page B3-1472</i>
System Control	<i>SCTLR, System Control Register, PMSA on page B6-1930</i> <i>SCTLR, System Control Register, VMSA on page B4-1705</i>



**Table R-2 Full registers index (continued)**

<b>Register</b>	<b>Description, see</b>
Target to Host Data Transfer, Debug	<i>DBGDTRTX, Target to Host Data Transfer register on page C11-2260</i>
TCM Data Region, ARMv6	<i>CP15 c9, TCM Region Registers. DTCMRR and ITCMRR on page AppxL-2539</i>
TCM Instruction or unified Region, ARMv6	<i>CP15 c9, TCM Region Registers. DTCMRR and ITCMRR on page AppxL-2539</i>
TCM Non-Secure Access Control, ARMv6	<i>CP15 c9, TCM Non-Secure Access Control Registers, DTCM-NSACR and ITCM-NSACR on page AppxL-2543</i>
TCM Selection, ARMv6	<i>CP15 c9, TCM Selection Register; TCMSR on page AppxL-2538</i>
TCM Type	<i>TCMTR, TCM Type Register; PMSA on page B6-1936</i> <i>TCMTR, TCM Type Register; VMSA on page B4-1713</i>
TCMSR, ARMv6	<i>CP15 c9, TCM Selection Register; TCMSR on page AppxL-2538</i>
TCMTR	<i>TCMTR, TCM Type Register; PMSA on page B6-1936</i> <i>TCMTR, TCM Type Register; VMSA on page B4-1713</i>
TEECR	<i>TEECR, ThumbEE Configuration Register; PMSA on page B6-1937</i> <i>TEECR, ThumbEE Configuration Register; VMSA on page B4-1714</i>
TEEHBR	<i>TEEHBR, ThumbEE Handler Base Register; PMSA on page B6-1938</i> <i>TEEHBR, ThumbEE Handler Base Register; VMSA on page B4-1715</i>
TEX remap	<i>VMSA CP15 c10 register summary, memory remapping and TLB control registers on page B3-1478</i>
ThumbEE Configuration	<i>TEECR, ThumbEE Configuration Register; PMSA on page B6-1937</i> <i>TEECR, ThumbEE Configuration Register; VMSA on page B4-1714</i>
ThumbEE Handler Base	<i>TEEHBR, ThumbEE Handler Base Register; PMSA on page B6-1938</i> <i>TEEHBR, ThumbEE Handler Base Register; VMSA on page B4-1715</i>
Timer ID, Counter	<i>CNTTIDR, Counter Timer ID Register on page AppxE-2418</i>
Timer PL1 Control	<i>CNTKCTL, Timer PL1 Control register; PMSA on page B6-1817</i> <i>CNTKCTL, Timer PL1 Control register; VMSA on page B4-1537</i>
Timer PL2 Control	<i>CNTHCTL, Timer PL2 Control register; Virtualization Extensions on page B4-1533</i>
TLB Lockdown Register, pre-ARMv7	<i>CP15 c10, TLB lockdown support, VMSA on page AppxO-2636</i>
TLB Type	<i>TLBTR, TLB Type Register; VMSA on page B4-1718</i>

**Table R-2 Full registers index (continued)**

<b>Register</b>	<b>Description, see</b>
TLBIALL	<i>TLB maintenance operations, not in Hyp mode on page B4-1743</i>
TLBIALLIS	
TLBIASID	
TLBIASIDIS	
TLBIMVA	
TLBIMVAA	
TLBIMVAAIS	
TLBIMVAIS	
TLBTR	<i>TLBTR, TLB Type Register, VMSA on page B4-1718</i>
TPIDRPRW	<i>TPIDRPRW, PL1 only Thread ID Register, PMSA on page B6-1939</i> <i>TPIDRPRW, PL1 only Thread ID Register, VMSA on page B4-1719</i>
TPIDRURO	<i>TPIDRURO, User Read-Only Thread ID Register, PMSA on page B6-1939</i> <i>TPIDRURO, User Read-Only Thread ID Register, VMSA on page B4-1719</i>
TPIDRURW	<i>TPIDRURW, User Read/Write Thread ID Register, PMSA on page B6-1940</i> <i>TPIDRURW, User Read/Write Thread ID Register, VMSA on page B4-1720</i>
Translation Table Base	<i>VMSA CP15 c2 and c3 register summary, Memory protection and control registers on page B3-1473</i>
Translation Table Base 0	<i>TTBR0, Translation Table Base Register 0, VMSA on page B4-1726</i>
Translation Table Base 1	<i>TTBR1, Translation Table Base Register 1, VMSA on page B4-1730</i>
Translation Table Base Control	<i>TTBCR, Translation Table Base Control Register, VMSA on page B4-1721</i>
TTBCR	<i>TTBCR, Translation Table Base Control Register, VMSA on page B4-1721</i>
TTBR0	<i>TTBR0, Translation Table Base Register 0, VMSA on page B4-1726</i>
TTBR1	<i>TTBR1, Translation Table Base Register 1, VMSA on page B4-1730</i>
User Enable	<i>PMUSERENR, Performance Monitors User Enable Register, PMSA on page B6-1922</i> <i>PMUSERENR, Performance Monitors User Enable Register, VMSA on page B4-1691</i>
UTLBIALL	<i>Previous names for the CP15 c8 operations TLBIALL, TLBIASID, and TLBIMVA, see TLB maintenance operations, not in Hyp mode on page B4-1743</i>
UTLBIASID	
UTLBIMVA	
V2PCWPR	<i>See entry for ATS1CPR and Naming of the address translation operations, and operation summary on page B3-1438</i>
V2PCWPW	<i>See entry for ATS1CPW and Naming of the address translation operations, and operation summary on page B3-1438</i>
V2PCWUR	<i>See entry for ATS1CUR and Naming of the address translation operations, and operation summary on page B3-1438</i>
V2PCWUW	<i>See entry for ATS1CUW and Naming of the address translation operations, and operation summary on page B3-1438</i>

**Table R-2 Full registers index (continued)**

<b>Register</b>	<b>Description, see</b>
V2POWPR	See entry for ATS12NSOPR and <i>Naming of the address translation operations, and operation summary</i> on page B3-1438
V2POWPW	See entry for ATS12NSOPW and <i>Naming of the address translation operations, and operation summary</i> on page B3-1438
V2POWUR	See entry for ATS12NSOUR and <i>Naming of the address translation operations, and operation summary</i> on page B3-1438
V2POWUW	See entry for ATS12NSOUW and <i>Naming of the address translation operations, and operation summary</i> on page B3-1438
VBAR	<i>VBAR, Vector Base Address Register, Security Extensions</i> on page B4-1732
Vector Base Address	<i>VBAR, Vector Base Address Register, Security Extensions</i> on page B4-1732
Vector Catch, Debug	<i>DBGVCR, Vector Catch Register</i> on page C11-2286
Virtual Count	<i>CNTVCT, Virtual Count register, PMSA</i> on page B6-1826 <i>CNTVCT, Virtual Count register, system level</i> on page AppxE-2420 <i>CNTVCT, Virtual Count register, VMSA</i> on page B4-1546
Virtual Offset	<i>CNTVOFFn, Virtual Offset register, system level</i> on page AppxE-2421 <i>CNTVOFF, Virtual Offset register, VMSA</i> on page B4-1547
Virtual Timer CompareValue	<i>CNTV_CVAL, Virtual Timer CompareValue register, PMSA</i> on page B6-1824 <i>CNTV_CVAL, Virtual Timer CompareValue register, system level</i> on page AppxE-2419 <i>CNTV_CVAL, Virtual Timer CompareValue register, VMSA</i> on page B4-1544
Virtual Timer Control	<i>CNTV_CTL, Virtual Timer Control register, PMSA</i> on page B6-1824 <i>CNTV_CTL, Virtual Timer Control register, system level</i> on page AppxE-2419 <i>CNTV_CTL, Virtual Timer Control register, VMSA</i> on page B4-1544
Virtual TimerValue	<i>CNTV_TVVAL, Virtual TimerValue register, PMSA</i> on page B6-1825 <i>CNTV_TVVAL, Virtual TimerValue register, system level</i> on page AppxE-2420 <i>CNTV_TVVAL, Virtual TimerValue register, VMSA</i> on page B4-1545
Virtualization ID Sampling, Debug	<i>DBGVIDSR, Virtualization ID Sampling Register</i> on page C11-2289
Virtualization Multiprocessor ID	<i>VMPIDR, Virtualization Multiprocessor ID Register, Virtualization Extensions</i> on page B4-1733
Virtualization Processor ID	<i>VPIDR, Virtualization Processor ID Register, Virtualization Extensions</i> on page B4-1734
Virtualization Translation Control	<i>VTCCR, Virtualization Translation Control Register, Virtualization Extensions</i> on page B4-1735
Virtualization Translation Table Base	<i>VTTBR, Virtualization Translation Table Base Register, Virtualization Extensions</i> on page B4-1738
VMPIDR	<i>VMPIDR, Virtualization Multiprocessor ID Register, Virtualization Extensions</i> on page B4-1733
VPIDR	<i>VPIDR, Virtualization Processor ID Register, Virtualization Extensions</i> on page B4-1734
VTCCR	<i>VTCCR, Virtualization Translation Control Register, Virtualization Extensions</i> on page B4-1735
VTTBR	<i>VTTBR, Virtualization Translation Table Base Register, Virtualization Extensions</i> on page B4-1738

**Table R-2 Full registers index (continued)**

<b>Register</b>	<b>Description, see</b>
Watchpoint Control, Debug	<i>DBGWCR, Watchpoint Control Registers on page C11-2291</i>
Watchpoint Fault Address, CP14, Debug	<i>DBGWFAR, Watchpoint Fault Address Register on page C11-2296</i>
Watchpoint Fault Address, CP15, ARMv6	<i>CP15 c6, Watchpoint Fault Address Register; DBGWFAR on page AppxL-2531</i>
Watchpoint Value, Debug	<i>DBGWVR, Watchpoint Value Registers on page C11-2297</i>

# Glossary

- Abort** An exception caused by an illegal memory access. Aborts can be caused by the external memory system or the MMU or MPU.
- Addressing mode** Means a method for generating the memory address used by a load/store instruction.
- Advanced SIMD** An extension to the ARM architecture that provides SIMD operations on a bank of extension registers. If the Floating-point extension is also implemented, the two extensions share the register bank and the Advanced SIMD operations include single-precision floating-point SIMD operations.
- Aligned** A data item stored at an address that is divisible by the highest power of 2 that divides into its size in bytes. Aligned halfwords, words and doublewords therefore have addresses that are divisible by 2, 4 and 8 respectively.
- An aligned access is one where the address of the access is aligned to the size of each element of the access.
- ARM core registers**
- The ARM core registers comprise:
- thirteen general-purpose registers, R0 to R12, that software can use for processing
  - SP, the *stack pointer*, that can also be referred to as R13
  - LR, the *link register*, that can also be referred to as R14
  - PC, the *program counter*, that can also be referred to as R15.
- In some situations, software can use SP, LR, and PC for processing. The instruction descriptions include any constraints on the use of SP, LR, and PC.
- See also [High registers](#).
- ARM instruction**
- A word that specifies an operation for a processor in ARM state to perform. ARM instructions must be word-aligned.
- Associativity** See [Cache associativity](#).

<b>Atomicity</b>	Describes either single-copy atomicity or multi-copy atomicity. <i>Atomicity in the ARM architecture on page A3-127</i> defines these forms of atomicity for the ARM architecture.  <i>See also</i> <a href="#">Multi-copy atomicity</a> , <a href="#">Single-copy atomicity</a> .
<b>Banked register</b>	A register that has multiple instances, with the instance that is in use depending on the processor mode, security state, or other processor state.
<b>Base register</b>	A register specified by a load/store instruction that is used as the base value for the address calculation for the instruction. Depending on the instruction and its addressing mode, an offset can be added to or subtracted from the base register value to form the virtual address that is sent to memory.
<b>Base register writeback</b>	Describes writing back a modified value to the base register used in an address calculation.
<b>Big-endian memory</b>	Means that: <ul style="list-style-type: none"> <li>• a byte or halfword at a word-aligned address is the most significant byte or halfword in the word at that address</li> <li>• a byte at a halfword-aligned address is the most significant byte in the halfword at that address.</li> </ul>
<b>Blocking</b>	Describes an operation that does not permit following instructions to be executed before the operation completes.  A non-blocking operation can permit following instructions to be executed before the operation completes, and in the event of encountering an exception does not signal an exception to the processor. This enables implementations to retire following instructions while the non-blocking operation is executing, without the need to retain precise processor state.
<b>Branch prediction</b>	Is where a processor selects a future execution path to fetch along. For example, after a branch instruction, the processor can choose to speculatively fetch either the instruction following the branch or the instruction at the branch target.  <i>See also</i> <a href="#">Prefetching</a> .
<b>Breakpoint</b>	A debug event triggered by the execution of a particular instruction, specified by one or both of the address of the instruction and the state of the processor when the instruction is executed.
<b>Byte</b>	An 8-bit data item.
<b>Cache associativity</b>	The number of locations in a cache set to which an address can be assigned. Each location is identified by its <i>way</i> value.
<b>Cache hit</b>	A memory access that can be processed at high speed because the data it addresses is already in the cache.
<b>Cache level</b>	The position of a cache in the cache hierarchy. In the ARM architecture, the lower numbered levels are those closest to the processor. For more information see <a href="#">Terms used in describing the maintenance operations on page B2-1274</a> .
<b>Cache line</b>	The basic unit of storage in a cache. Its size in words is always a power of two, usually 4 or 8 words. A cache line must be aligned to a suitable memory boundary. A <i>memory cache line</i> is a block of memory locations with the same size and alignment as a cache line. Memory cache lines are sometimes loosely called cache lines.
<b>Cache lockdown</b>	Enables critical software and data to be loaded into the cache so that the cache lines containing them are not subsequently reallocated. It alleviates the delays caused by accessing a cache in a worst-case situation. This ensures that all subsequent accesses to the software and data concerned are cache hits and so complete quickly.
<b>Cache miss</b>	A memory access that cannot be processed at high speed because the data it addresses is not in the cache.
<b>Cache sets</b>	Areas of a cache, divided up to simplify and speed up the process of determining whether a cache hit occurs. The number of cache sets is always a power of two.

- Cache way** A cache way consists of one cache line from each cache set. The cache ways are indexed from 0 to (Associativity-1). Each cache line in a cache way is chosen to have the same index as the cache way. For example, cache way *n* consists of the cache line with index *n* from each cache set.
- Coherence order**  
See [Coherent](#).
- Coherent** Data accesses from a set of observers to a memory location are coherent if accesses to that memory location by the members of the set of observers are consistent with there being a single total order of all writes to that memory location by all members of the set of observers. This single total order of all to writes to that memory location is the *coherence order* for that location.
- Condition code field**  
A 4-bit field in an instruction that specifies the condition under which the instruction executes.
- Conditional execution**  
When a conditional instruction starts executing, if the condition flags indicate that the required condition is TRUE, the instruction executes normally. Otherwise, it does nothing.
- Condition flags** The N, Z, C, and V bits of the APSR, CPSR, SPSR, or FPSCR. See the register descriptions for more information.
- Context switch** The saving and restoring of computational state when switching between different threads or processes. In this manual, the term context switch describes any situations where the context is switched by an operating system and might or might not include changes to the address space.
- Context synchronization operation**  
One of:
- the execution of an ISB instruction
  - the taking of an exception
  - the return from an exception.
- The architecture requires a context synchronization operation to guarantee visibility of any change to a system control register.
- Digital signal processing (DSP)**  
Algorithms for processing signals that have been sampled and converted to digital form. DSP algorithms often use saturated arithmetic.
- Direct Memory Access (DMA)**  
An operation that accesses main memory directly, without the processor performing any accesses to the data concerned.
- DMA** See [Direct Memory Access \(DMA\)](#).
- DNM** See [Do-Not-Modify \(DNM\)](#).
- Domain** In the ARM architecture, *domain* is used in the following contexts.
- Shareability domain** Defines a set of observers for which the shareability attributes make the data or unified caches transparent for data accesses.
- Power domain** Defines a block of logic with a single, common, power supply.
- Memory regions domain**  
When using the Short-descriptor translation table format, defines a collection of Sections, Large pages and Small pages of memory, that can have their access permissions switched rapidly by writing to the *Domain Access Control Register* (DACR). ARM deprecates any use of memory regions domains.
- Do-Not-Modify (DNM)**  
Means the value must not be altered by software. DNM fields read as UNKNOWN values, and must only be written with the value read from the same field on the same processor.

**Double-precision value**

Consists of two consecutive 32-bit words that are interpreted as a basic double-precision floating-point number according to the IEEE 754 standard.

**Deprecated**

Something that is present in the ARM architecture for backwards compatibility. Whenever possible software must avoid using deprecated features. Features that are deprecated but are not optional are present in current implementations of the ARM architecture, but might not be present, or might be deprecated and **OPTIONAL**, in future versions of the ARM architecture.

*See also* [OPTIONAL](#).

**Doubleword**

A 64-bit data item. Doublewords are normally at least word-aligned in ARM systems.

**Doubleword-aligned**

Means that the address is divisible by 8.

**DSP**

*See* [Digital signal processing \(DSP\)](#).

**Endianness**

An aspect of the system memory mapping.

*See also* [Big-endian memory](#) and [Little-endian memory](#).

**Exception**

Handles an event. For example, an exception could handle an external interrupt or an undefined instruction.

**Exception vector**

A fixed address that contains the address of the first instruction of the corresponding exception handler.

**Execution stream**

The stream of instructions that would have been executed by sequential execution of the program.

**Explicit access**

A read from memory, or a write to memory, generated by a load or store instruction executed by the processor. Reads and writes generated by hardware translation table accesses are not explicit accesses.

**External abort**

An abort that is generated by the external memory system.

**Fast Context Switch Extension (FCSE)**

Modifies the behavior of an ARM memory system to enable multiple programs running on the ARM processor to use identical address ranges, while ensuring that the addresses they present to the rest of the memory system differ. From ARMv6, ARM deprecates any use of the FCSE. The FCSE is:

- optional in an ARMv7 implementation that does not include the Multiprocessing Extensions
- obsolete from the introduction of the Multiprocessing Extensions.

**FCSE**

*See* [Fast Context Switch Extension \(FCSE\)](#).

**Flat address mapping**

Is where the physical address for every access is equal to its virtual address.

**Flush-to-zero mode**

A special processing mode that optimizes the performance of some floating-point algorithms by replacing the denormalized operands and intermediate results with zeros, without significantly affecting the accuracy of their final results.

**General-purpose registers**

An older term for the ARM core registers.

*See also* [ARM core registers](#).

**Halfword**

A 16-bit data item. Halfwords are normally halfword-aligned in ARM systems.

**Halfword-aligned**

Means that the address is divisible by 2.

**High registers**

ARM core registers 8 to 15, that cannot be accessed by some Thumb instructions.

*See also* [Low registers](#).



<b>High vectors</b>	An alternative location for the exception vectors. The high vector address range is near the top of the address space, rather than at the bottom.
<b>Hit</b>	See <a href="#">Cache hit</a> .
<b>Immediate and offset fields</b>	Are unsigned unless otherwise stated.
<b>Immediate value</b>	A value that is encoded directly in the instruction and used as numeric data when the instruction is executed. Many ARM and Thumb instructions can be used with an immediate argument.
<b>IMP</b>	An abbreviation used in diagrams to indicate that one or more bits have IMPLEMENTATION DEFINED behavior.
<b>IMPLEMENTATION DEFINED</b>	Means that the behavior is not architecturally defined, but must be defined and documented by individual implementations. In body text, the term IMPLEMENTATION DEFINED is shown in SMALL CAPITALS.
<b>Index register</b>	A register specified in some load and store instructions. The value of this register is used as an offset to be added to or subtracted from the base register value to form the virtual address that is sent to memory. Some instruction forms permit the index register value to be shifted before the addition or subtraction.
<b>Inline literals</b>	These are constant addresses and other data items held in the same area as the software itself. They are automatically generated by compilers, and can also appear in assembler code.
<b>Intermediate Physical Address (IPA)</b>	An implementation of virtualization, the address to which an Guest OS maps a VA.  See also <a href="#">Physical address (PA)</a> , <a href="#">Virtual address (VA)</a> .
<b>Interworking</b>	A method of working that permits branches between software using the ARM and Thumb instruction sets.
<b>IPA</b>	See <a href="#">Intermediate Physical Address (IPA)</a> .
<b>Level</b>	See <a href="#">Cache level</a> .
<b>Level of coherence (LoC)</b>	The last level of cache that must be cleaned or invalidated when cleaning or invalidating to the point of coherency. For more information see <a href="#">Terms used in describing the maintenance operations on page B2-1274</a> .  See also <a href="#">Cache level</a> , <a href="#">Point of coherency (PoC)</a> .
<b>Level of unification, Inner Shareable (LoUIS)</b>	The last level of cache that must be cleaned or invalidated when cleaning or invalidating to the point of unification for the Inner Shareable shareability domain. For more information see <a href="#">Terms used in describing the maintenance operations on page B2-1274</a> .  See also <a href="#">Cache level</a> , <a href="#">Point of unification (PoU)</a> .
<b>Level of unification, uniprocessor (LoUU)</b>	For a processor, the last level of cache that must be cleaned or invalidated when cleaning or invalidating to the point of unification for that processor. For more information see <a href="#">Terms used in describing the maintenance operations on page B2-1274</a> .  See also <a href="#">Cache level</a> , <a href="#">Point of unification (PoU)</a> .
<b>Line</b>	See <a href="#">Cache line</a> .
<b>Little-endian memory</b>	Means that: <ul style="list-style-type: none"> <li>• a byte or halfword at a word-aligned address is the least significant byte or halfword in the word at that address</li> <li>• a byte at a halfword-aligned address is the least significant byte in the halfword at that address.</li> </ul>

**Load/Store architecture**

An architecture where data-processing operations only operate on register contents, not directly on memory contents.

**LoC** See [Level of coherence \(LoC\)](#).

**LoUIS** See [Level of unification, Inner Shareable \(LoUIS\)](#).

**LoUU** See [Level of unification, uniprocessor \(LoUU\)](#).

**Lockdown** See [Cache lockdown](#).

**Low registers** ARM core registers 0 to 7. Unlike the High registers, all Thumb instructions can access the Low registers.

See also [High registers](#).

**Memory barrier** See [Memory barriers on page A3-150](#)

**Memory coherency**

The problem of ensuring that when a memory location is read, either by a data read or an instruction fetch, the value actually obtained is always the value that was most recently written to the location. This can be difficult when there are multiple possible physical locations, such as main memory and at least one of a write buffer and one or more levels of cache.

**Memory Management Unit (MMU)**

Provides detailed control of the part of a memory system that provides a single stage of address translation. Most of the control is provided using translation tables that are held in memory, and define the attributes of different regions of the physical memory map.

**Memory Protection Unit (MPU)**

A hardware unit whose registers provide simple control of a limited number of protection regions in memory.

**Miss** See [Cache miss](#).

**Modified Virtual Address (MVA)**

The address produced by the FCSE that is sent to the rest of the memory system to be used in place of the normal virtual address. When the FCSE is absent or disabled the MVA and the *Virtual Address* (VA) have the same value.

From ARMv6, ARM deprecates any use of the FCSE. The FCSE is:

- optional in an ARMv7 implementation that does not include the Multiprocessing Extensions
- obsolete from the introduction of the Multiprocessing Extensions.

**MMU** See [Memory Management Unit \(MMU\)](#).

**MPU** See [Memory Protection Unit \(MPU\)](#).

**Multi-copy atomicity**

The form of atomicity described in [Multi-copy atomicity on page A3-129](#).

See also [Atomicity](#), [Single-copy atomicity](#).

**MVA** See [Modified Virtual Address \(MVA\)](#).

**NaN** Special floating-point values that can be used when neither a numeric value nor an infinity is appropriate. NaNs can be *quiet* NaNs that propagate through most floating-point operations, or *signaling* NaNs that cause Invalid Operation floating-point exceptions when used. For more information, see the IEEE 754 standard.

**Observer** A processor or mechanism in the system, such as a peripheral device, that can generate reads from or writes to memory.

**Offset addressing**

Means that the memory address is formed by adding or subtracting an offset to or from the base register value.

- OPTIONAL** When applied to a feature of the architecture, **OPTIONAL** indicates a feature that is not required in an implementation of the ARM architecture:
- If a feature is **OPTIONAL** and deprecated, this indicates that the feature is being phased out of the architecture. ARM expects such a feature to be included in a new implementation only if there is a known backwards-compatibility reason for the inclusion of the feature.  
A feature that is **OPTIONAL** and deprecated might not be present in future versions of the architecture.
  - A feature that is **OPTIONAL** but not deprecated is, typically, a feature added to a version of the ARM architecture after the initial release of that version of the architecture. ARM recommends that such features are included in all new implementations of the architecture.
- In body text, these meanings of the term **OPTIONAL** are shown in **SMALL CAPITALS**
- Note:** Do not confuse these ARM-specific uses of **OPTIONAL** with other uses of *optional*, where it has its usual meaning. These include:
- Optional arguments in the syntax of many instructions.
  - Behavior determined by an implementation choice, for example the optional byte order reversal in an ARMv7-R implementation, where the **SCTLR.IE** bit indicates the implemented option.
- See also [Deprecated](#).
- PA** See [Physical address \(PA\)](#).
- Physical address (PA)**  
Identifies a main memory location.  
  
See also [Intermediate Physical Address \(IPA\)](#), [Virtual address \(VA\)](#).
- PoC** See [Point of coherency \(PoC\)](#).
- PoU** See [Point of unification \(PoU\)](#).
- Point of coherency (PoC)**  
For a particular MVA, the point at which all agents that can access memory are guaranteed to see the same copy of a memory location. For more information see [Terms used in describing the maintenance operations on page B2-1274](#).
- Point of unification (PoU)**  
For a particular processor, the point by which the instruction and data caches and the translation table walks of that processor are guaranteed to see the same copy of a memory location. For more information see [Terms used in describing the maintenance operations on page B2-1274](#).
- Post-indexed addressing**  
Means that the memory address is the base register value, but an offset is added to or subtracted from the base register value and the result is written back to the base register.
- Prefetching**  
Prefetching refers to speculatively fetching instructions or data from the memory system. In particular, instruction prefetching is the process of fetching instructions from memory before the instructions that precede them, in simple sequential execution of the program, have finished executing. Prefetching an instruction does not mean that the instruction has to be executed.  
  
In this manual, references to instruction or data fetching apply also to prefetching, unless the context explicitly indicates otherwise.  
  
**Note**, in particular, that the Prefetch Abort exception can be generated on any instruction fetch, and is not limited to speculative instruction fetches.
- Pre-indexed addressing**  
Means that the memory address is formed in the same way as for offset addressing, but the memory address is also written back to the base register.
- Process ID** In the FCSE, this is a 7-bit number that identifies which process block the current process is loaded into.

**Protection region**

A memory region whose position, size, and other properties are defined by Memory Protection Unit registers.

**Protection Unit** See [Memory Protection Unit \(MPU\)](#).

**Pseudo-instruction**

UAL assembler syntax that assembles to an instruction encoding that is expected to disassemble to a different assembler syntax, and is described in this manual under that other syntax. For example, `MOV <Rd>, <Rm>, LSL #<n>` is a pseudo-instruction that is expected to disassemble as `LSL <Rd>, <Rm>, #<n>`

**Quadword** A 128-bit data item. Quadwords are normally at least word-aligned in ARM systems.

**Quadword-aligned**

Means that the address is divisible by 16.

**Quiet NaN** A NaN that propagates unchanged through most floating-point operations.

**RAO** See [Read-As-One \(RAO\)](#)

**RAZ** See [Read-As-Zero \(RAZ\)](#).

**RAO/SBOP** Read-As-One, Should-Be-One-or-Preserved on writes.

Hardware must implement the field as Read-as-One, and must ignore writes to the field.

Software can rely on the field reading as all 1s, but must use an SBOP policy to write to the field.

This description can apply to a single bit that reads as 1, or to a field that reads as all 1s.

See also [Read-As-One \(RAO\)](#), [Should-Be-One-or-Preserved \(SBOP\)](#).

**RAO/WI** Read-As-One, Writes Ignored.

Hardware must implement the field as read as Read-as-One, and must ignore writes to the field.

Software can rely on the field reading as all 1s, and on writes being ignored.

This description can apply to a single bit that reads as 1, or to a field that reads as all 1s.

See also [Read-As-One \(RAO\)](#).

**RAZ/SBZP** Read-As-Zero, Should-Be-Zero-or-Preserved on writes.

Hardware must implement the field as Read-as-Zero, and must ignore writes to the field.

Software can rely on the field reading as all 0s, but must use an SBZP policy to write to the field.

This description can apply to a single bit that reads as 0, or to a field that reads as all 0s.

See also [Read-As-Zero \(RAZ\)](#), [Should-Be-Zero-or-Preserved \(SBZP\)](#).

**RAZ/WI** Read-As-Zero, Writes Ignored.

Hardware must implement the field as Read-as-Zero, and must ignore writes to the field.

Software can rely on the field reading as all 0s, and on writes being ignored.

This description can apply to a single bit that reads as 0, or to a field that reads as all 0s.

See also [Read-As-Zero \(RAZ\)](#).

**Read-allocate cache**

A cache in which a cache miss on reading data causes a cache line to be allocated into the cache.

**Read-As-One (RAO)**

Hardware must implement the field as reading as all 1s.

Software can rely on the field reading as all 1s.

This description can apply to a single bit that reads as 1, or to a field that reads as all 1s.

**Read-As-Zero (RAZ)**

Hardware must implement the field as reading as all 0s.

Software can rely on the field reading as all 0s

This description can apply to a single bit that reads as 0, or to a field that reads as all 0s.

**Read, modify, write**

In a read, modify, write instruction sequence, a value is read to a general-purpose register, the relevant fields updated in that register, and the new value written back.

**Reserved**

Unless otherwise stated:

- instructions that are reserved or that access reserved registers have UNPREDICTABLE behavior
- bit positions described as reserved are:
  - in an RW register, UNK/SBZP
  - in an RO register, UNK
  - in a WO register, SBZ.

**RISC**

Reduced Instruction Set Computer.

**Rounding error**

The value of the rounded result of an arithmetic operation minus the exact result of the operation.

**Rounding mode**

Specifies how the exact result of a floating-point operation is rounded to a value that is representable in the destination format.

**Round to Nearest (RN) mode**

Means that the rounded result is the nearest representable number to the unrounded result.

**Round towards Plus Infinity (RP) mode**

Means that the rounded result is the nearest representable number that is greater than or equal to the exact result.

**Round towards Minus Infinity (RM) mode**

Means that the rounded result is the nearest representable number that is less than or equal to the exact result.

**Round towards Zero (RZ) mode**

Means that results are rounded to the nearest representable number that is no greater in magnitude than the unrounded result.

**Saturated arithmetic**

Integer arithmetic in which a result that would be greater than the largest representable number is set to the largest representable number, and a result that would be less than the smallest representable number is set to the smallest representable number. Signed saturated arithmetic is often used in DSP algorithms. It contrasts with the normal signed integer arithmetic used in ARM processors, in which overflowing results wrap around from  $+2^{31}-1$  to  $-2^{31}$  or vice versa.

**SBO**

See [Should-Be-One \(SBO\)](#).

**SBOP**

See [Should-Be-One-or-Preserved \(SBOP\)](#).

**SBZ**

See [Should-Be-Zero \(SBZ\)](#).

**SBZP**

See [Should-Be-Zero-or-Preserved \(SBZP\)](#).

**Security hole**

A mechanism by which execution at the current level of privilege can achieve an outcome that cannot be achieved at the current or a lower level of privilege using instructions that are not UNPREDICTABLE. The ARM architecture forbids security holes.

**Self-modifying code**

Code that writes one or more instructions to memory and then executes them. When using self-modifying code you must use cache maintenance and barrier instructions to ensure synchronization. For more information see [Ordering of cache and branch predictor maintenance operations on page B2-1289](#).

**Set**

See [Cache sets](#).

**Should-Be-One (SBO)**

Hardware must ignore writes to the field.

Software should write the field as all 1s. If software writes a value that is not all 1s, it must expect an UNPREDICTABLE result.

This description can apply to a single bit that should be written as 1, or to a field that should be written as all 1s.

### Should-Be-One-or-Preserved (SBOP)

The Large Physical Address Extension modifies the definition of SBOP for register bits that are reallocated by the extension, and as a result are SBOP in some but not all contexts. For more information see [Meaning of fixed bit values in register diagrams on page B3-1466](#). The generic definition of SBOP given here applies only to bits that are not affected by this modification.

Hardware must ignore writes to the field.

If software has read the field since the processor implementing the field was last reset and initialized, it should preserve the value of the field by writing the value that it previously read from the field. Otherwise, it should write the field as all 1s.

If software writes a value to the field that is not a value previously read for the field and is not all 1s, it must expect an UNPREDICTABLE result.

This description can apply to a single bit that should be written as its preserved value or as 1, or to a field that should be written as its preserved value or as all 1s.

### Should-Be-Zero (SBZ)

Hardware must ignore writes to the field.

Software should write the field as all 0s. If software writes a value that is not all 0s, it must expect an UNPREDICTABLE result.

This description can apply to a single bit that should be written as 0, or to a field that should be written as all 0s.

### Should-Be-Zero-or-Preserved (SBZP)

The Large Physical Address Extension modifies the definition of SBZP for register bits that are reallocated by the extension, and as a result are SBZP in some but not all contexts. For more information see [Meaning of fixed bit values in register diagrams on page B3-1466](#). The generic definition of SBZP given here applies only to bits that are not affected by this modification.

Hardware must ignore writes to the field.

If software has read the field since the processor implementing the field was last reset and initialized, it must preserve the value of the field by writing the value that it previously read from the field. Otherwise, it must write the field as all 0s.

If software writes a value to the field that is not a value previously read for the field and is not all 0s, it must expect an UNPREDICTABLE result.

This description can apply to a single bit that should be written as its preserved value or as 0, or to a field that should be written as its preserved value or as all 0s.

**Signaling NaNs** Cause an Invalid Operation exception whenever any floating-point operation receives a signaling NaN as an operand. Signaling NaNs can be used in debugging, to track down some uses of uninitialized variables.

### Signed immediate and offset fields

Are encoded in two's complement notation unless otherwise stated.

### SIMD

Single-Instruction, Multiple-Data.

The SIMD instructions in the ARMv7 architecture are:

- The instructions summarized in [Parallel addition and subtraction instructions on page A4-171](#).
- the Advanced SIMD instructions summarized in [Chapter A7 Advanced SIMD and Floating-point Instruction Encoding](#), when operating on vectors.

---

**Note**

---

In ARMv7, some VFP instructions can operate on vectors. However, ARM deprecates those instruction uses, and strongly recommends that Advanced SIMD instructions are always used for vector operations.

---

**Simple sequential execution**

The behavior of an implementation that fetches, decodes and completely executes each instruction before proceeding to the next instruction. Such an implementation performs no speculative accesses to memory, including to instruction memory. The implementation does not pipeline any phase of execution. In practice, this is the theoretical execution model that the architecture is based on, and ARM does not expect this model to correspond to a realistic implementation of the architecture.

**Single-copy atomicity**

The form of atomicity described in *Single-copy atomicity on page A3-127*.

See also *Atomicity, Multi-copy atomicity*.

**Single-precision value**

A 32-bit word that is interpreted as a basic single-precision floating-point number according to the IEEE 754 standard.

**Spatial locality**

The observed effect that after a program has accessed a memory location, it is likely to also access nearby memory locations in the near future. Caches with multi-word cache lines exploit this effect to improve performance.

**SUBARCHITECTURE DEFINED**

Means that the behavior is expected to be specified by a subarchitecture definition. This definition might be shared by multiple implementations, but it must not be relied on by architecturally-portable software.

In this manual, subarchitecture definitions are used for:

- the interface between a VFP implementation and its support code
- the interface between an implementation of the Jazelle extension and an Enabled JVM.

In body text, the term SUBARCHITECTURE DEFINED is shown in SMALL CAPITALS.

**Temporal locality**

The observed effect that after a program has accesses a memory location, it is likely to access the same memory location again in the near future. Caches exploit this effect to improve performance.

**Thumb instruction**

One or two halfwords that specify an operation for a processor in Thumb state to perform. Thumb instructions must be halfword-aligned.

**TLB**

See *Translation Lookaside Buffer (TLB)*.

**TLB lockdown**

A way to prevent specific translation table walk results being accessed. This ensures that accesses to the associated memory areas never cause a translation table walk.

**Translation Lookaside Buffer (TLB)**

A memory structure containing the results of translation table walks. They help to reduce the average cost of a memory access. Usually, there is a TLB for each memory interface of the ARM implementation.

**Translation table**

A table held in memory that defines the properties of memory areas of various sizes from 1KB to 1MB.

**Translation table walk**

The process of doing a full translation table lookup. It is performed automatically by hardware.

**Trap enable bits**

In VFPv2, VFPv3U, and VFPv4U, determine whether trapped or untrapped exception handling is selected. If trapped exception handling is selected, the way it is carried out is IMPLEMENTATION DEFINED.

**Unaligned**

An unaligned access is an access where the address of the access is not aligned to the size of an element of the access.

**Unaligned memory accesses**

Are memory accesses that are not, or might not be, appropriately halfword-aligned, word-aligned, or doubleword-aligned.



- Unallocated** Except where otherwise stated, an instruction encoding is unallocated if the architecture does not assign a specific function to the entire bit pattern of the instruction, but instead describes it as UNDEFINED, UNPREDICTABLE, or an unallocated hint instruction.
- A bit in a register is unallocated if the architecture does not assign a function to that bit.
- UNDEFINED** Indicates an instruction that generates an Undefined Instruction exception.
- In body text, the term UNDEFINED is shown in SMALL CAPITALS.
- See also [Undefined Instruction exception on page B1-1205](#).*
- Unified cache** Is a cache used for both processing instruction fetches and processing data loads and stores.
- Unindexed addressing** Means addressing in which the base register value is used directly as the virtual address to send to memory, without adding or subtracting an offset. In most types of load/store instruction, unindexed addressing is performed by using offset addressing with an immediate offset of 0. The LDC, LDC2, STC, and STC2 instructions have an explicit unindexed addressing mode that permits the offset field in the instruction to specify additional coprocessor options.
- UNK** An abbreviation indicating that software must treat a field as containing an UNKNOWN value.
- Hardware must implement the bit as read as 0, or all 0s for a bit field. Software must not rely on the field reading as zero.
- See also [UNKNOWN](#).*
- UNK/SBOP** Hardware must implement the field as Read-As-One, and must ignore writes to the field.
- Software must not rely on the field reading as all 1s, and except for writing back to the register it must treat the value as if it is UNKNOWN. Software must use an SBOP policy to write to the field.
- This description can apply to a single bit that should be written as its preserved value or as 1, or to a field that should be written as its preserved value or as all 1s.
- See also [Read-As-One \(RAO\)](#), [Should-Be-One-or-Preserved \(SBOP\)](#), [UNKNOWN](#).*
- UNK/SBZP** Hardware must implement the bit as Read-As-Zero, and must ignore writes to the field.
- Software must not rely on the field reading as all 0s, and except for writing back to the register must treat the value as if it is UNKNOWN. Software must use an SBZP policy to write to the field.
- This description can apply to a single bit that should be written as its preserved value or as 0, or to a field that should be written as its preserved value or as all 0s.
- See also [Read-As-Zero \(RAZ\)](#), [Should-Be-Zero-or-Preserved \(SBZP\)](#), [UNKNOWN](#).*
- UNKNOWN** An UNKNOWN value does not contain valid data, and can vary from moment to moment, instruction to instruction, and implementation to implementation. An UNKNOWN value must not return information that cannot be accessed at the current or a lower level of privilege using instructions that are not UNPREDICTABLE and do not return UNKNOWN values.
- An UNKNOWN value must not be documented or promoted as having a defined value or effect.
- In body text, the term UNKNOWN is shown in SMALL CAPITALS.
- See also [UNK](#).*
- UNPREDICTABLE** Means the behavior cannot be relied upon. UNPREDICTABLE behavior must not perform any function that cannot be performed at the current or a lower level of privilege using instructions that are not UNPREDICTABLE.
- UNPREDICTABLE behavior must not be documented or promoted as having a defined effect.
- An instruction that is UNPREDICTABLE can be implemented as UNDEFINED.
- In an implementation that includes the Virtualization Extensions, execution in a Non-secure PL1 or PL0 mode of an instruction that is UNPREDICTABLE can be implemented as generating a Hyp Trap exception, provided that at least one instruction that is not UNPREDICTABLE causes a Hyp Trap exception.



In body text, the term UNPREDICTABLE is shown in SMALL CAPITALS.

**VA** See [Virtual address \(VA\)](#).

**VFP** A coprocessor extension to the ARM architecture, that provides single-precision and double-precision floating-point arithmetic.

**Virtual address (VA)**

An address generated by an ARM processor. For a PMSA implementation, the virtual address is identical to the physical address.

See also [Intermediate Physical Address \(IPA\)](#), [Physical address \(PA\)](#).

**Watchpoint** A debug event triggered by an access to memory, specified in terms of the address of the location in memory being accessed.

**Way** See [Cache way](#).

**Word** A 32-bit data item. Words are normally word-aligned in ARM systems.

**Word-aligned** Means that the address is divisible by 4.

**Write-allocate cache**

A cache in which a cache miss on storing data causes a cache line to be allocated into the cache.

**Write-back cache**

A cache in which when a cache hit occurs on a store access, the data is only written to the cache. Data in the cache can therefore be more up-to-date than data in main memory. Any such data is written back to main memory when the cache line is cleaned or reallocated. Another common term for a write-back cache is a *copy-back cache*.

**Write-through cache**

A cache in which when a cache hit occurs on a store access, the data is written both to the cache and to main memory. This is normally done via a write buffer, to avoid slowing down the processor.

**Write buffer** A block of high-speed memory that optimizes stores to main memory.

