



Canon

English Edition

SERVICE MANUAL

By Portable Document Format

EOS 40D

C12-6171

Preface

General

Technical

Repair

Adjustments

Parts Catalog

Circuit Diagrams

Software

Appendix

CLOSE

Canon

EOS 40D

REF. NO. C12-6171

**SERVICE
MANUAL**

PREFACE

This manual contains information for servicing the product, and has the following sections:

General Information

Provides the basic information needed to understand the product.

(Operating instructions are not included. Refer to the product's instruction book if necessary.)

Technical Information

Provides technical information about the mechanism and electronics of the product.

Repair Information

Provides information about disassembly and assembly, as well as tools and expendables to be used.

Adjustments

Provides information about adjustment items and procedures, as well as tools to be used.

Parts Catalog

Circuit Diagrams

Software Information

Appendix

General Information

Trademarks

The product names and company names described in this Service Manual are the registered trademarks of the individual companies.

Copyright

Canon Inc. retains the copyright to this Service Manual. Reproduction, publication (including on the World Wide Web), alteration, translation into another language, or other use of the data in whole or part, contained on this Service Manual without the written consent of Canon Inc. is prohibited.

CONTENTS

	Page
General Information	
1. FEATURES	1
1.1 Fine Detail and High Image Quality	1
1.2 Fast Shooting	1
1.3 Ease of Use	2
1.4 EOS 30D's Outstanding Features Retained	2
1.5 Expandable Shooting System	2
2. OVERVIEW	3
2.1 EOS 40D body	3
2.2 New System Accessories	16
2.3 EOS 40D software (=EOS-1D Mark III)	17
3. SPECIFICATIONS	18
4. NOMENCLATURE AND DIMENSIONS	31
4.1 Nomenclature	31
4.2 Dimensions	32
5. VISUAL INDICATORS	33
5.1 Viewfinder Information	33
5.2 LCD Panel Information and Model Dial	34
6. CUSTOM FUNCTION	36
6.1 Custom Function List	36
7. PROGRAM DIAGRAMS	38
7.1 Program Diagrams	38
8. SYSTEM ACCESSORIES COMPATIBILITY TABLES	39
8.1 System Accessories	39
8.2 System Accessory Compatibility	40

1. FEATURES

(Features superior to EOS 30D in blue.)

1.1 Fine Detail and High Image Quality

- Effective pixels: Approx. 10.1 megapixels for fine detail and high image quality
- Newly-developed, large, single-piece 22.2 × 14.8mm CMOS sensor
 - * Lens crop factor: Approx. 1.6x the lens focal length
- DIGIC III for fine-detail, and natural color processing at high speed
- 14-bit A/D conversion for fine gradation
- Picture Styles optimized for the photographic subject and intention
 - * Picture Style button provided
- Six JPEG recording quality modes and RAW, sRAW, RAW+JPEG, and sRAW+JPEG simultaneous recording
- Accurate white balance
- WB correction and WB bracketing provided
- Excellent noise reduction
 - * Noise reduction for long exposures
 - * Noise reduction for high ISO speeds
- Highlight tone priority
- Automatic brightness and contrast correction
 - * Functions in Basic Zone modes
- Complies to Design rule for Camera File System 2.0 and Exif 2.21 which support Adobe RGB

1.2 Fast Shooting

- Nine cross-type AF points with center AF point sensitive to vertical and horizontal lines at f/2.8
 - * AF Start button provided
- Approx. 6.5 fps maximum continuous shooting speed
- Maximum burst during continuous shooting: Approx. 75 shots in JPEG Large/Fine or 17 shots in RAW
 - * Based on Canon's testing standards and 1GB CF card in high-speed continuous shooting mode.

1.3 Ease of Use

- **High-magnification viewfinder and interchangeable focusing screens**
 - * 0.95x viewfinder magnification
 - * Interchangeable focusing screens: One with grid lines and one with easy-to-see point of focus
- **EOS Integrated Cleaning System incorporated**
 - * Self Cleaning Sensor Unit enables Dust Delete Data to be obtained and appended to images
- **Live View shooting with the camera or PC**
 - * Silent shooting also possible
- **3.0-in., 230,000-pixel LCD monitor with wide viewing angle**
 - * Vertical and horizontal viewing angle approx. 140°, and larger menu text size
 - * Seven brightness levels
 - * LCD panel-like shooting information display also provided
- **Startup time approx. 0.15 sec.**
- **Data writing continues even if you open the CF card slot cover while data is being written to the CF card**

1.4 EOS 30D's Outstanding Features Retained

- **1/8000 sec. - 30 sec. shutter speed, Bulb, 1/250 sec. X-sync**
- **Shooting modes, metering modes, AF modes, and other shooting features retained**
- **Compatible with all EF lenses including EF-S lenses**
- **Shooting-priority operation**
- **High degree of customization**
 - * Up to three sets of camera user settings can be registered
 - * 24 Custom Functions with 62 settings
 - * My Menu
 - * Flash Custom Functions
- **USB 2.0 Hi-Speed for high-speed image transfers**
- **More advanced PictBridge features**
 - * Preview of printing effects, tilt correction ($\pm 10^\circ$ in 0.5° increments)

1.5 Expandable Shooting System

- **Wireless/wired LAN for image transfers (via WFT-E3)**
- **Compatible with external recording media and GPS device (via WFT-E3)**
 - * With external recording media, the image recording can switch automatically between different recording media or images can be recorded separately to different media. Images can also be recorded simultaneously to multiple recording media and images in the CF card can be backed up to external recording media.
- **Original data verification system (via OSK-E3)**
- **Set Speedlite settings with the camera (with SPEEDLITE 580EX II)**

2. OVERVIEW

2.1 EOS 40D body

The major differences in features compared to the EOS 30D are outlined below.

Table 001 Specifications Comparison of EOS 40D and EOS 30D (1/2)

Item		EOS 40D	EOS 30D	
Image sensor	Image sensor	CMOS		
	Effective pixels [Approx. megapixels]	10.10	8.20	
	Image sensor size [mm]	22.2×14.8	22.5×15.0	
	Lens Crop Factor [Approx. magnification]	1.6		
	Pixel size [μm square]	5.7	6.4	
	Color filter	Primary colors		
Recording System	Cleaning system (EICS)	Yes	—	
	A/D conversion [bits]	14	12	
	Image type	JPEG	Large, Medium, Small Fine and Normal provided for each	
		RAW	sRAW, RAW	RAW
	RAW+JPEG	RAW+JPEG and sRAW+JPEG enabled in all combinations	RAW+JPEG enabled in all combinations	
	Recording pixels [Approx. megapixels]	Large	10.10	8.20
		Medium	5.30	4.30
		Small	2.50	2.00
		RAW	10.10	8.20
		sRAW	2.50	—
	Highlight tone priority	Provided	—	
	Picture Styles	Yes (6 presets, 3 custom sets)		
	Brightness and contrast auto correction	Yes (Basic Zone modes)	—	
	Color space	sRGB / Adobe RGB		
	Noise reduction	Long exposures	Off / Auto / On	
High ISO speed		Yes	—	
Recording Media	Recording media	Compact Flash		
	Slot/Qty	CF Type I, II/1		
	External recording media	Enabled with WFT-E3 (Auto switch media / Rec. separately / Rec. to multiple / Backup)	—	
	Max. images per folder	9999		
	File No.	Continuous / Auto Reset / Manual Reset		
Compatible card capacity	2 GB and higher			
Imaging engine	DIGIC III	DIGIC II		
White Balance	Settings	1. Auto / 2. Daylight / 3. Shade / 4. Cloudy, Twilight, Sunset 5. Tungsten light / 6. White Fluorescent light / 7. Flash / 8. Custom / 9. Color temperature		
	WB correction [levels]	Blue/amber bias: ±9, Magenta/green bias: ±9		
	WB bracketing	Amount	±3 levels in 1-level increments	
		Direction	Blue/amber bias, Magenta/green bias	
	Shutter Release	3 images with one shot		
Color Temp. Spec. [Range/Increments, K]	2500 - 10000/100	2800 - 10000/100		
Viewfinder	Coverage [Approx.]	95% vertical, 95% horizontal		
	Magnification [magnification]	0.95	0.9	
	Eye point [mm]	22	20	
	Angle of view [°]	26.4	25.1	
	Dioptric adjustment [dpt]	-3 - +1		
	Focusing Screen	Interchangeable (Standard, grid lines, point of focus)	Fixed	
Information display	ISO speed, B/W, 2-digit maximum burst	—		
Live View shooting	Yes	—		
Autofocus	AF Points	9		
	Cross-type AF points	9	1	
	f/2.8 sensor at center	Vertical/horizontal-line sensitive	Vertical-line sensitive only	
	AF point selection	Multi-controller		
	Focusing brightness range [EV]	-0.5 - 18		
	AF mode	One-Shot / AI SERVO / AI Focus		
	Superimposed display	Yes (LED)		
	50 kph predictive AF [EF300mm f/2.8L IS USM, approx. m]	8		
	AF start button	Yes	—	
	AF-assist beam	Method	Stroboscopic flash	
Effective Range [m]	Center: 4, Periphery: 3.5			
Exposure Control	Sensor Zones	35		
	Metering range [EV]	1 - 20		
	Metering Modes	Evaluative / Partial / Spot / Center-weighted average		
	Shooting Modes	Basic Zone	1. Full Auto 2. Portrait 3. Landscape 4. Close-up 5. Sports 6. Night Portrait 7. Flash Off	
		Creative Zone	Program AE / Shutter-priority AE / Aperture-priority AE / Manual exposure / Automatic Depth-of-field AE / Camera user setting 1 - 3	Program AE / Shutter-priority AE / Aperture-priority AE / Manual exposure / Automatic Depth-of-field AE
	ISO Speed	Basic Zone	Auto 100 - 800	Auto 100 - 400
		Creative Zone	Auto, 100 - 1600 (1/3-stop), H:3200	100 - 1600 (1/3-stop), H:3200
	Exposure Compensation [increments and range]	1/3, 1/2, ±2		
AEB [increments and range]	1/3, 1/2, ±2			

Table 001 Specifications Comparison of EOS 40D and EOS 30D (2/2)

Item		EOS 40D	EOS 30D
Shutter	Speeds [sec.]	1/8000 - 30, bulb	
	X-sync [sec.]	1/250	
	Durability	100,000	
	Release time lag [Approx.]	59 ms	65ms
	Shoot → Press Shutter Button Halfway → Shoot [Single shooting]	Enabled	—
Silent shooting		Enabled during Live View shooting	
Drive	Drive Modes	Single / Continuous L / Continuous H / Self-timer (10 sec. or 2 sec.)	Single / Continuous L / Continuous H / Self-timer
	Continuous shooting [Approx. fps]	High-speed: 6.5 / Low-speed: 3	High-speed: 5 / Low-speed: 3
	Max. Burst	JPEG (L/F) 75	30
	[High-speed]	RAW 17 RAW+JPEG 14	11 9
Built-in Flash	Flash Exposure Control	E-TTL II	
	GNo. [ISO100-m]	13	
	Flash Coverage [mm]	17	
	Recycling Time [Approx. sec.]	3	
	Red-eye Reduction	Lamp	
	Flash Exposure Compensation [increments and range]	1/3, 1/2 · ±2	
	FE Lock	Yes	—
	Flash settings with menu	Yes	—
External Flash	Flash Exposure Control	E-TTL II	
	FP Flash/FE Lock/ Flash Exposure Compensation/FEB	Yes	
	Wireless Multiple Flash Control	Yes (for 3 groups)	
	Flash settings with menu	Yes	—
LCD Monitor	Screen Size [in.]	3	2.5
	Pixels displayed [Approx.]	230,000	
	Brightness [Levels]	7	Yes (5, Gray chart)
	LCD panel-like shooting info screen	Yes	—
Playback	Display Modes	Single image	2
	[Types]	Index	4-image / 9-image index
	Histogram	Brightness / RGB	
	Highlight alert	Yes	
	AF point display	Yes	
	Zoom-in magnification	1.5x - 10x (15 levels)	
	Magnification of Image Displayed Immediately after Shooting	—	Yes (C.Fn-17-1)
	Rotate image [°]	90, 270	
	Image protect [unit]	1	
	Image jump	By 10 shots / 100 shots / Index 1 screen / date	By 10 shots / 100 shots / date
Video OUT		NTSC/PAL	
Erase Image	Single / Erase selected images / All images on card	Single / All images on card	
Menu Languages		18	15
Camera direct/ Printing	Direct Print	Yes	Yes
	PictBridge (PTP) Compatibility	Yes (Extended functions + advanced futures)	Yes (Extended functions)
	CP/BJ Direct Compatibility	—	Yes
Digital Camera Standards		Design rule for Camera File System Ver. 2.0 / Exif Ver. 2.21 / DPOF Ver. 1.1	
Direct Image Transfer		Yes	
Customization	Custom Functions [Qty/settings]	24/62	19/53
	Register camera settings	Yes	—
	My Menu	Yes	—
Original image verification data		Yes	
Error Warning		LCD monitor / LCD panel	
External Interface	USB [Ver.]	2.0 Hi-Speed	
	Video OUT	Yes	
	Remote Control Terminal	Yes (N3-type)	
	PC Terminal	Yes	
	Extension system terminal	Yes	—
Power Source	Possible Shots [23°C/73°F, FA50%, BP-511A]	800	750
	Batteries	BP-511A/BP-511/BP-514/BP-512	
	AC Power	Yes	
	Date/Time Backup Battery	CR2016	
	Battery Grip	BG-E2N / BG-E2 (size-AA batteries compatible)	
	Battery check	Auto (4 levels)	
	Return from Auto Power Off	Pressing shutter button halfway / PLAY / MENU / AEL	
Exterior	Material	Magnesium	
	Exterior Color	Black	
	LCD Panel Illumination	Yes	
	EF-S lens compatible	Yes	
Chassis Material		Stainless steel	
Startup time [Approx. sec.]		0.15	
Dimensions [W×H×D]		145.5 x 107.8×73.5mm	144 x 105.5×73.5mm
Weight [g]		740	700
Ambient temperature		0 - 40°C/32-104°F	
Ambient humidity		85% or less	

EOS 40D

EOS 30D

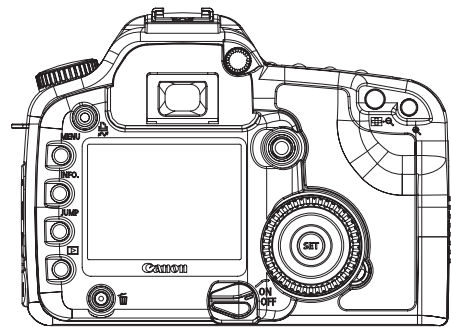
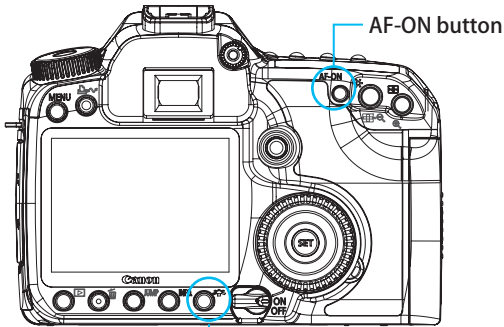
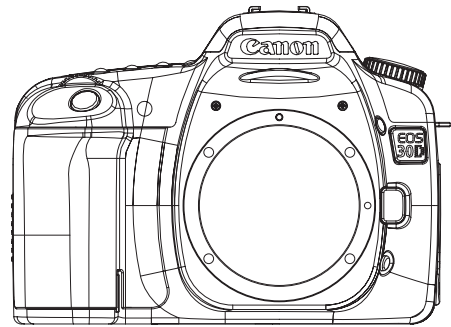
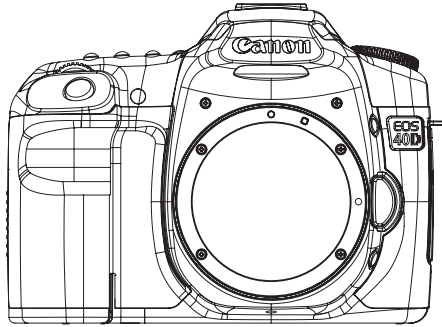
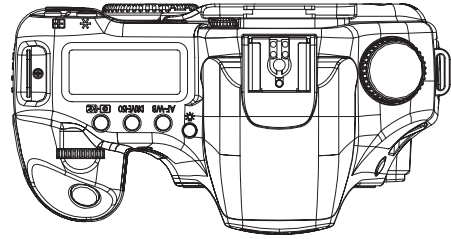
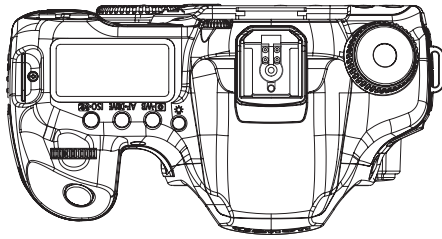

Picture Style button

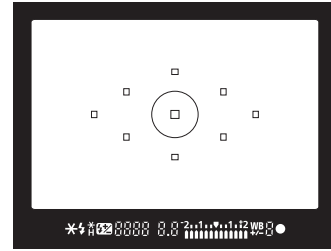
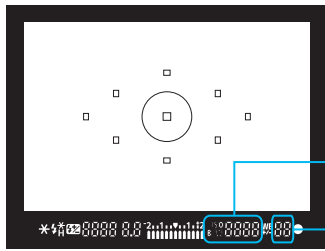

ISO speed
Monochrome shooting

2-digit display for
continuous shooting
max. burst

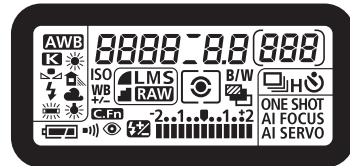
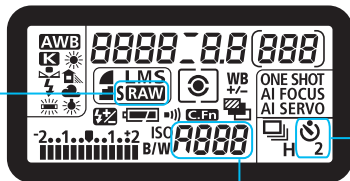

Small RAW

Self-timer 2 sec.

ISO speed always displayed

Camera user
settings

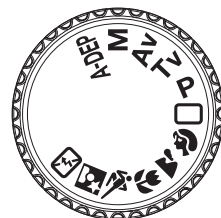
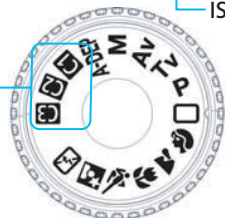

Fig. 001 EOS 40D: Exterior comparison with EOS 30D

1) Image recording

(1) Large, single-piece CMOS sensor with approx.

10.1-megapixels (=EOS DIGITAL REBEL XT_i / 400D DIGITAL)

The same 10.1-megapixel* CMOS sensor (Fig. 002) used in the EOS DIGITAL REBEL XT_i / 400D DIGITAL is incorporated. With an image sensor size of 22.2 mm × 14.8 mm, the effective angle of view is approx. 1.6 times the lens focal length.

* Effective pixels.

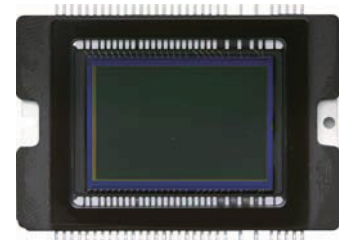

Fig. 002 CMOS sensor (actual size)

(2) DIGIC III (=EOS-1D Mark III)

While retaining the DIGIC II's features for fine image detail, natural colors, and high speed, the new DIGIC III imaging engine attains faster signal processing speed.

(3) 14-bit A/D conversion (=EOS-1D Mark III)

The analog output signal from the imaging element is converted into a digital signal with 14-bit (16384 colors) processing instead of the previous 12-bit (4096 colors). This creates digital data with finer gradation.

With RAW/sRAW images recorded with 14-bit processing, you can use DPP to post process and save the image as a 16-bit TIFF image. This brings out the maximum range of colors afforded by 14-bit processing. Also, since images recorded in JPEG (8 bits per color) are also generated from 14-bit RAW data, they have fewer blown highlights than before and the gradation is excellent.

(4) Image-recording quality

In addition to the image-recording quality modes provided by EOS 30D, the new small RAW* is provided. Small RAW can also be recorded simultaneously with any JPEG recording quality (Fig. 003). Table 002 shows the pixels for the respective image-recording quality.

As with the EOS-1D Mark III, even if you open the CF card slot cover while data is being written to the CF card, the data writing still continues with the EOS 40D.

* The recorded number of pixels is about one-fourth that of a normal RAW image, and the file size is about half the size of RAW.

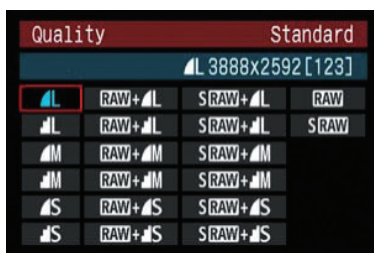

Fig. 003 Image-recording quality selection screen

Table 002 Recorded Pixels

Image-recording quality	Recorded Pixels
Large	3888 × 2592 (Approx. 10.10 megapixels)
Medium	2816 × 1880 (Approx. 5.30 megapixels)
Small	1936 × 1288 (Approx. 2.50 megapixels)
RAW	3888 × 2592 (Approx. 10.10 megapixels)
sRAW	1936 × 1288 (Approx. 2.50 megapixels)

(5)ISO speed

As with the EOS 30D, the ISO speed range is 100-1600, settable in 1/3-stop or whole-stop increments. ISO 3200 extension can also be set. The ISO speed is now always displayed in the viewfinder and on the LCD panel.

●Auto ISO speed enabled in Creative Zone modes

With the EOS 40D, you can now set auto ISO speed even in the Creative Zone modes (Fig. 004). When the ISO speed is set to [Auto], ISO 400 is initially set. Then depending on the lighting conditions, the ISO speed is set automatically as shown in Table 003. The automatically-set ISO speed is displayed in the viewfinder and on the LCD panel while the metering is active.

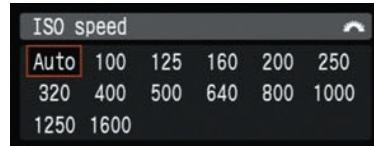

Fig. 004 ISO speed setting screen

In the Basic Zone modes, the automatically-set ISO speed range is 100-800 which is 1 stop higher on the high end than the EOS 30D.

Table 003 [Auto] ISO Speed Settings

Shooting mode		ISO Speed Settings
Creative Zone modes	P/Av/ A-DEP	Set within ISO 400-800 so that the respective shutter speed will not cause camera shake under the current lighting conditions. If overexposure will result at ISO 400, a lower ISO speed, as low as ISO 100, is set.
	Tv	If overexposure or underexposure will result at ISO 400, the ISO speed is shifted within 100-800. (=EOS-1D Mark III's C.Fn I-8-2)
	M	Fixed at ISO 400.
Basic Zone modes	/ /	Automatically set within ISO 100-800, according to the brightness.
		Automatically set within ISO 400-800, according to the brightness.
		Fixed at ISO 100.
With flash		Set to ISO 400 in all shooting modes. If overexposure would result in fill-in flash, a lower ISO speed, as low as ISO 100, will be set.

2) Image processing (=EOS 30D)

(1)Picture Styles

The Picture Styles have the same specifications as the EOS 30D's Picture Styles. The EOS 40D has a separate Picture Style selection button to make the selection easier.

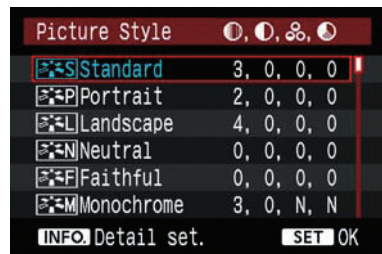

Fig. 005 Picture Style selection screen

(2)Noise reduction

●Long exposures noise reduction (=EOS 30D)

[Off], [Auto], or [On] can be selected.

● **High ISO speed noise reduction (C.Fn II-2)**

This is noise reduction for images taken at a high ISO speed as in the EOS-1D Mark III. Although noise reduction is applied at all ISO speeds, it is particularly effective at high ISO speeds. At low ISO speeds, the noise in the shadow areas is further reduced. Also, when [High ISO speed noise reduction] is set, the maximum burst during continuous shooting will decrease to 8, regardless of the image-recording quality.

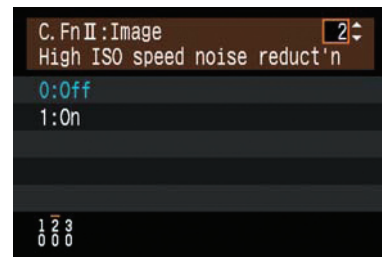

Fig. 006 C.Fn II-2

(3) **Highlight tone priority (C.Fn II-3)** (=EOS-1D Mark III)

This function seeks to improve the highlight detail. The range is extended between 18% gray and the maximum highlight tone. This makes the gradation finer from the grays to the highlights and reduces blown highlights.

This function also limits the settable ISO speed range to 200-1600.

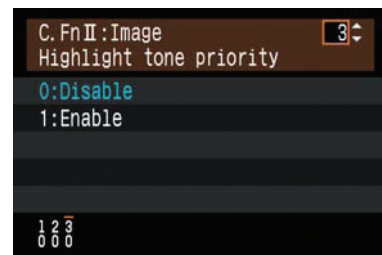

Fig. 007 C.Fn II-3

(4) **White balance**

The white balance settings are the same as the EOS 30D's. Only the color temperature (K) as a preset WB is new (Fig. 008). The minimum color temperature has been lowered from 2800K to 2500K in order to cover tungsten light.

You can now register the personal white balance (1 setting) under <WB> with the provided software.

The WB correction and WB bracketing settings can now all be canceled with the INFO. button.

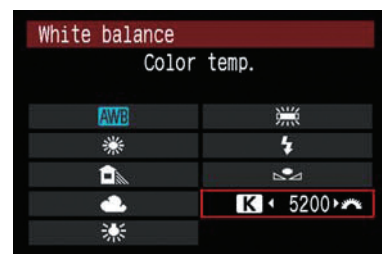

Fig. 008 White balance setting screen

(5) **Automatic brightness and contrast correction**

In Basic Zone modes, the image is now adjusted automatically during processing to obtain the best brightness and contrast, due to the shooting results (brightness and contrast).

(6) **Compatible with external recording media** (=EOS-1D Mark III)

With the WFT-E3 attached to the camera and external recording media such as a portable hard drive attached via USB, the external media can be selected as the recording media.

● **Image recording function**

As with the EOS-1D Mark III, the image recording can be set to [Standard], [Auto switch media], [Rec. separately], or [Rec. to multiple] (Fig. 009).

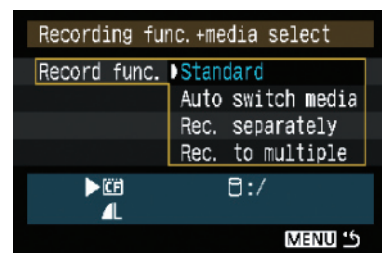

Fig. 009 Recording function

● **Shooting backup**

Images in the CF card can be backed up to external media. Besides the quick backup feature also found in the EOS-1D Mark III, the folder to back up the images can be created or selected. Only checkmarked images can also be backed up (Fig. 010).

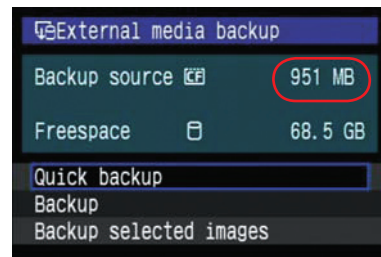

Fig. 010 Backup

3) **EOS Integrated Cleaning System** (=EOS-1D Mark III)

The Self Cleaning Sensor Unit is the same type as in the EOS-1D Mark III (Fig. 011). The specifications for acquiring and appending Dust Delete Data to the image are the same as with the EOS-1D Mark III.

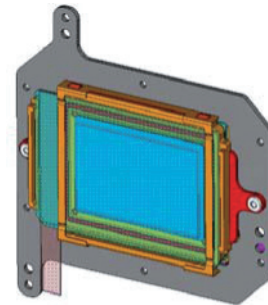

Fig. 011 Self Cleaning Sensor Unit

4) **Shooting functions**

(1) **Autofocus**

● **Nine cross-type AF points** (center AF point sensitive to vertical and horizontal lines at f/2.8).

The newly-developed AF sensor (Fig. 012) with nine cross-type AF points greatly boosts AF performance. The AF sensitivity is EV -0.5 - EV 18.

• **Nine cross-type AF points**

All AF points work as cross-type points at f/5.6. High-precision AF is attained with fewer AF failures with hard-to-focus subjects.

• **First EOS with cross-type AF sensitive to f/2.8**

The center AF point has a cross-type AF sensor sensitive to vertical and horizontal lines at f/2.8.

*The f/2.8 sensor is a diagonal, cross-type sensor so that it does not obstruct the f/5.6 sensor positioned vertically at the center.

• **Handles extreme defocus**

The sensor can handle extreme defocus. It can still focus even when the scene is way out of focus.

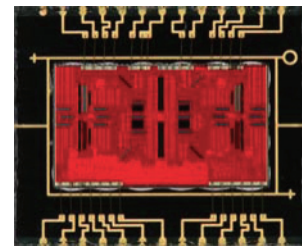

Fig. 012 AF sensor

● **AF Start button** (=EOS-1D Mark III)

Like the EOS-1D Mark III, the <AF-ON> button is provided.

● **AF mode selection** (=EOS 30D)

Like the EOS 30D, the AF mode (One-Shot AF, AI Focus AF, AI SERVO AF) is selectable even in the Creative Zone modes.

● **AF point selection** (=EOS 30D)

Like the EOS 30D, you can use the Multi-controller or Main/Quick Control dial to select the AF point while looking at the superimposed AF point in the viewfinder or the LCD panel's AF point selection display.

(2)Drive

Continuous shooting speed at approx. 6.5 fps (maximum) and approx. 3 fps. The drive mode selection loop now includes 2-sec. self-timer.

The maximum burst during continuous shooting is approx. 75 Large/Fine shots and approx. 17 RAW shots (both during high-speed continuous shooting). Despite the higher number of megapixels due to the larger image size, continuous shooting is still fast.

(3)Shutter (=EOS 30D)

The shutter unit is the same as the EOS 30D's. The shutter speed range is 1/8000 sec. to 30 sec. with Bulb and X-sync at 1/250 sec.

(4)Exposure control (=EOS 30D)

The shooting modes, 35-zone metering sensor, and metering modes (evaluative, partial, spot, and center-weighted average) are all the same as the EOS 30D.

(5)Viewfinder

●Viewfinder optics

To make the viewfinder clearer to see, 0.95x magnification, 26.4° angle of view, and 22mm eyepoint are provided. (The EOS 30D's viewfinder gave 0.9x magnification, 25.1° angle of view, and 20mm eyepoint.)

●Focusing screen

Interchangeable. Besides the standard focusing screen, there is one to make it easier to see the point of focus and one with grid lines.

●Viewfinder display

Besides the EOS 30D's viewfinder's display items, the EOS 40D's viewfinder display now includes the ISO speed (always displayed) and B/W shooting icon. Also, the maximum burst is now displayed in 2 digits instead of only 1 digit.

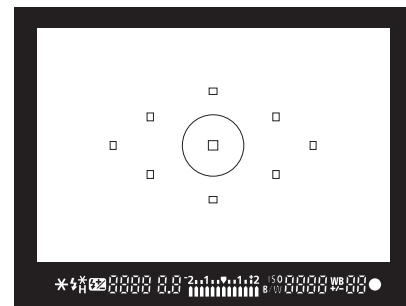

Fig. 013 Viewfinder information

(6)Live View shooting mode

Compared to the EOS-1D Mark III's Live View shooting mode, the following improvements have been incorporated:

●Shorter shutter-release time lag and silent shooting mode

The EOS 40D's CMOS sensor has an electronic 1st-curtain shutter function. It enables shooting with the mechanical shutter completely open. As a result, the [Silent shoot.] (Fig. 014) Mode 1 and Mode 2 make the shutter-release time lag shorter and reduce the shutter-cocking noise.

With Mode 2, the shutter cocking does not occur after shutter release. It occurs only when the shutter button is SW-2 OFF. When the shot is taken, only the shutter curtains make noise so the shooting is quiet.

*Live View shooting with EOS-1D Mark III had the shutter closing after the shutter release before the start of the exposure. This caused shutter-release time lag and shutter-cocking noise.

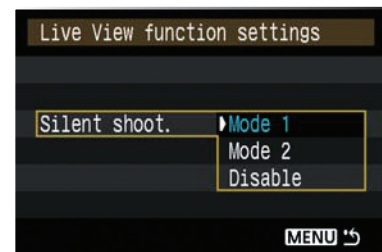

Fig. 014 Silent shooting screen

● AF function (C.Fn III-6)

Pressing the AF-ON button pauses the Live View shooting (reflex mirror goes down) and executes AF. Letting go of the AF-ON button resumes the Live View shooting. (C.Fn)

(7)Flash

The built-in flash unit is basically the same as the EOS 30D's. The EOS 30D's Custom Functions "Flash firing," "E-TTL II," and "Shutter curtain sync" have been consolidated into the menu's [Built-in flash func. setting] (Fig. 015).

Also, with the SPEEDLITE 580EX II, the camera can be used to set the SPEEDLITE 580EX II's settings as with the EOS-1D Mark III.

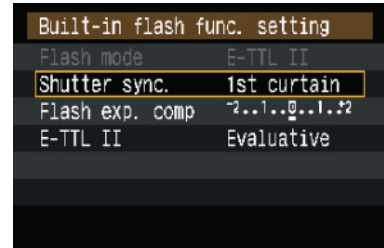

Fig. 015 Built-in flash func. screen

(8)Compatible with EF-S lenses

The camera is compatible with all EF lenses, including EF-S lenses.

5) Large LCD monitor

This is a 3.0-in. TFT liquid-crystal color monitor (Fig. 016) with approx. 230,000 pixels and a wide viewing angle. It displays a very fine image and the brightness is adjustable to one of seven levels.



Fig. 016 Comparison with EOS 30D screen

(1)Camera setting display modes

Press the INFO. button to change the screen as follows: 1. Camera settings display, 2. LCD panel-like display, 3. Display off (Fig. 017).

With the LCD panel-like display, pressing the ISO speed button, etc., will display the respective setting screen as with the EOS DIGITAL REBEL XT_i / 400D DIGITAL (Fig. 018).

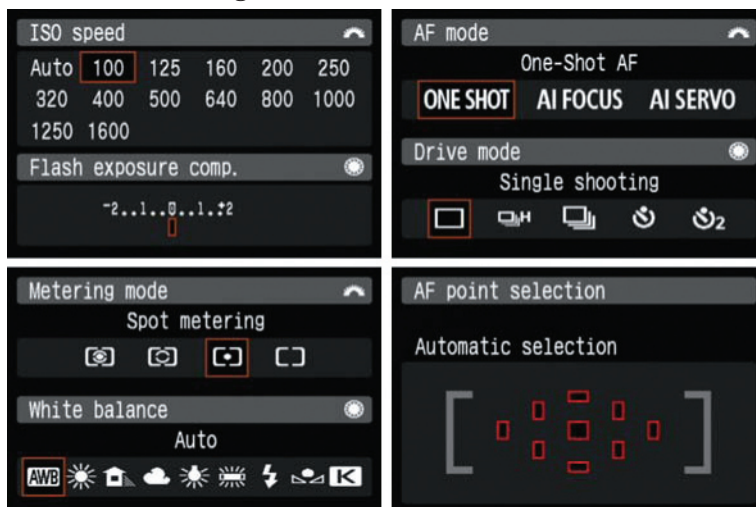

Fig. 018 Setting screens

LCD monitor OFF

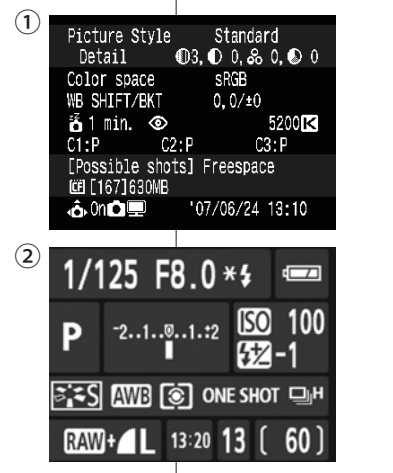

Fig. 017 INFO display

Since the EOS 40D does not have a display-off sensor, press the INFO. button to turn on/off the INFO display.

* If auto power off is [Off] and the camera is left idle, the LCD monitor will turn off automatically after 30 min. (The camera power does not turn off.)

(2) Menu display

As with the EOS-1D Mark III, turn the Main Dial to select the menu tab and turn the Quick Control Dial to select the menu option (Fig. 019). You can also use the Multi-controller for menu operations.



Fig. 019 Menu options

(3) Playback display

● Single-image playback (=EOS-1D Mark III)

During single-image playback, pressing the <INFO.> button switches the shooting information screen like the EOS-1D Mark III. You can also set the menu option to display the overexposed highlight warning and AF point which achieved focus.

● Index display (=EOS-1D Mark III)

In addition to the 9-image index display, a 4-image index display is provided.

● Jump display

Press the <JUMP> button, then turn the Quick Control Dial to select the jump method (jump by 1 image, 10 images, 100 images, 1 screen, or shooting date). It is now similar to the EOS-1D Mark III's jump operation with the Main Dial. (Fig. 020)



Fig. 020 Jump display

●Erasing images

With the [Erase images] menu, select [Select and erase images] and checkmark the images to be erased. Then all the checkmarked images can be erased at one time. (Fig. 021)

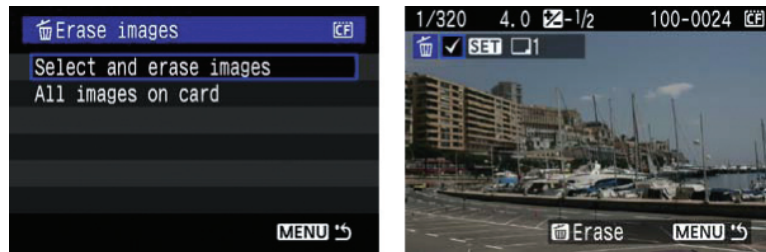

Fig. 021 Erase images screen

6) Design and operation ease

(1)Design

The camera design is based on the following three concepts:

●New-generation design for advanced amateurs

A revamping of the old EOS 20D-series design.

●Joy of ergonomics

The successive steps of holding the camera, framing the subject, turning a dial, and pressing a button all feel good.

●Joy of ownership

Cool-looking camera, making you a proud owner.

Key words: Heavy-duty, great design, nice shape, suited to adult tastes.

(2)Operation ease

Shooting functions are now assigned to three buttons above the LCD panel. Through these buttons, the most frequently-changed settings are now accessible near the Main Dial (Fig. 022). Similar to the EOS-1D Mark III, you use the Main Dial to change the ISO speed, AF mode, and metering mode. And you use the Quick Control Dial to change the flash exposure compensation, drive mode, and white balance.

Also, the menu operation method is now the same as with the EOS-1D Mark III. The camera operation method is being made uniform as much as possible among the professional and advanced amateur cameras.

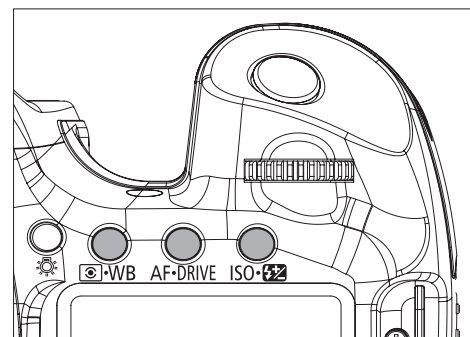

operation: ISO/AF/ [Main Dial icon]
operation: [Quick Control Dial icon]/DRIVE/WB

Fig. 022 Layout of shooting buttons

7) Customization

(1) Register camera user settings

The camera's shooting function settings and menu settings can be registered to the Mode Dial's C1, C2, or C3 (Fig. 023). Except for the date/time and other settings which need not be registered, almost all the camera settings can be registered.

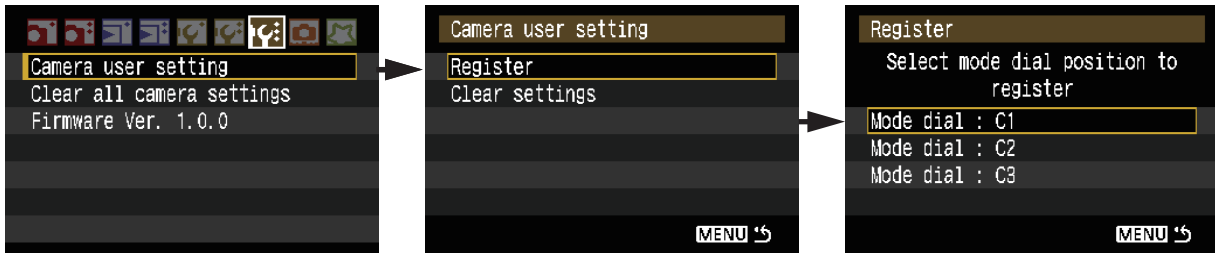

Fig. 023 Register camera user settings

(2) Custom Functions

The 24 Custom Functions are categorized according to basic function make it faster to find and set the desired Custom Function. (Fig. 024)

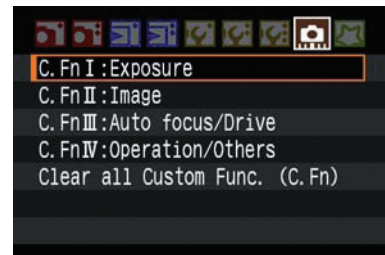

Fig. 024 Custom Functions

(3) Flash Custom Functions

With the SPEEDLITE 580EX II attached to the camera, you can set or cancel the Speedlite's Custom Function settings (C.Fn-0 to 13) with the camera (Fig. 025).

* With an EX-series Speedlite other than the SPEEDLITE 580EX II, the camera cannot be used to set the Speedlite's Custom Functions.

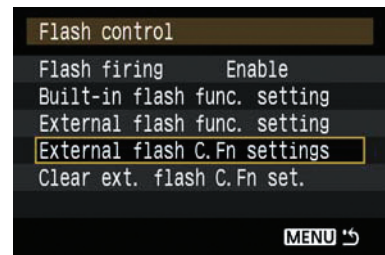

Fig. 025 External flash Custom Functions

(4) My Menu (=EOS-1D Mark III)

Like the EOS-1D Mark III, you can register up to six of the most frequently-set menu options and Custom Functions under My Menu.

Also, when [Display from My Menu: Enable] is set, pressing the Menu button will first display the My Menu screen (tab).

You can also use EOS Utility to set My Menu and register it to the camera.

8) Camera Direct Printing

(1) Direct printing

As with the EOS-1D Mark III, RAW and sRAW printing and Red-Eye 1 are provided. Compatible only with PictBridge. BubbleJet Direct and CP Direct are not supported. Also, the following features are new.

● Printing effects preview

Printing effects like B/W, Vivid, Brightness, and Adjust levels are now reflected in the displayed image so you can see the effect. (Fig. 026. Excluding Face Brightener and Red-eye corr.)

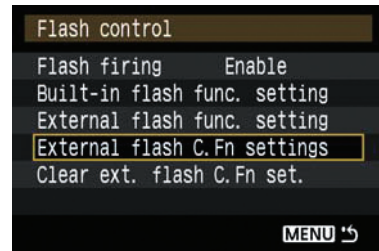

Fig. 026 Printing effects

● Tilt correction

With the trimming screen, turn the Quick Control Dial to tilt the image up to ± 10 degrees in 0.5° increments. (Fig. 027)



Fig. 027 Tilt correction

(2) Print order (DPOF) and direct image transfer

Same as with EOS 30D.

9) Interface

USB 2.0 Hi-Speed is provided for the interface with personal computers and camera direct printing. As shown in Fig. 028, the other terminals are the same as EOS 30D.

Also, the camera bottom has an extension system terminal (Fig. 029).



Fig. 028 Terminals



Fig. 029 Extension system terminal

10) Power source and shooting performance

The power source system is the same as the EOS 30D's with Battery Pack BP-511A. With a fully-charged battery pack, the number of possible shots without flash use is about 1100 shots at 23° C/73° F. With 50% flash use, it is about 800 shots.

As with the EOS 30D, the date/time backup battery is the CR2016 lithium battery installed in the battery compartment.

Detaching and attaching the battery compartment cover is now easier. You can pull it out or put it on at the slanted (45-degree) angle (Fig. 030).

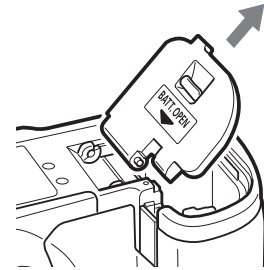

Fig. 030 Battery compartment cover

11) Dimensions and weight

Dimensions (W×H×D): 145.5×107.8×73.5 mm / 5.7×4.2×2.9 in.,
Weight: 740 g / 26.1 oz.

2.2 New System Accessories

1) Battery Grip BG-E2N

A new grip was made from Battery Grip BG-E2 with the new sealing material around battery compartment cover to better resist water and dust.

Battery Grip BG-E2 is also compatible with EOS 40D.

The BG-E2N is also compatible with EOS 30D.

2) WFT-E3

New accessory having the same wireless/wired LAN functions as WFT-E2 and a USB host function for connecting external storage media and GPS device. It is attached to the camera bottom and also has vertical-grip camera controls (shutter button, Main Dial, AF point selection button, AE lock button, AF start button, vertical-grip control ON/OFF switch). (Fig. 031)

To power the WFT-E3 (but not the EOS 40D), it also accommodates BP-511A×1.



Fig. 031 WFT-E3

3) Interchangeable focusing screens

Besides the standard focusing screen, there is a focusing screen making it easier to see the point of focus and one with grid lines (Fig. 032).

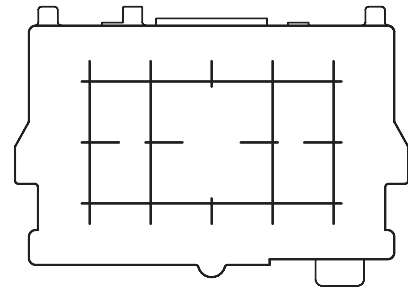

Fig. 032 Focusing screen with grid lines

2.3 EOS 40D software (=EOS-1D Mark III)

The EOS 40D is bundled with the EOS DIGITAL SOLUTION DISK Ver.15 containing the programs below. Picture Style Editor 1.0 (Win/Mac) has been newly developed to create Picture Style files. Otherwise, the bundled programs are the same as with EOS-1D Mark III.

- EOS Utility 2.1 (Win/Mac)
- Digital Photo Professional 3.1 (Win/Mac)
- [Picture Style Editor 1.0 \(Win/Mac\)](#)
- ZoomBrowser EX 5.8 (Win)
- ImageBrowser 5.8 (Mac)
- RAW Image Task 2.7 (Win/Mac)
- PhotoStitch 3.1 (Win/Mac)
- CameraWindow MC 6.4 (Win) /6.5 (Mac)
- WFT-E1 Utility 3.1 (Win/Mac)
- WFT-E2 Utility 3.1 (Win/Mac)
- WFT Pairing Software 1.1 (Win/Mac)
- Original Data Security Utility 1.1 (Win)
- Original Data security Administrator 1.1 (Win)
- Win 2000 Driver (with Vista/XP, the OS is used)







3. SPECIFICATIONS

(Specifications different from EOS 30D are in blue.)

1. Type
 - 1-1 Type: Digital AF/AE single-lens reflex camera with built-in flash
 - 1-2 Compatible lenses: Canon EF lenses (including EF-S lenses)
 - 1-3 Lens mount: Canon EF mount
 - 1-4 Lens restrictions: None
 - 1-5 Lens focal length: Equivalent to 1.6x the normal lens focal length

2. Image Sensor
 - 2-1 Type: High-sensitivity, high-resolution, single-plate, CMOS sensor
 - 2-2 Image sensor size: 22.2 mm × 14.8 mm
 - 2-3 Effective pixels: Approx. 10.10 megapixels: 3904 (H) × 2598 (V) pixels
 - 2-4 Total pixels: Approx. 10.50 megapixels: 3996 (H) × 2620 (V) pixels
 - 2-5 Pixel unit: 5.7 μm square
 - 2-6 Aspect ratio: 2:3 (Vertical:Horizontal)
 - 2-7 Color filter type: RGB primary color filters
 - 2-8 Low-pass filter: Fixed position in front of the image sensor
 - 2-9 Dust delete feature:
 - 1) Self Cleaning Sensor Unit
 - * Removes dust adhering to the low-pass filter.
 - * Can be executed automatically when power on/off (approx. 1 sec. operation time) or manually (approx. 2.5 sec. operation time).
 - 2) Dust Delete Data acquisition and appending
 - * The coordinates of the dust adhering to the low-pass filter are detected by a test shot and appended to subsequent images.
 - * The dust coordinate data appended to the image is used by the provided software to automatically erase the dust spots.
 - 3) Manual cleaning

3. Recording System
 - 3-1 Image type: JPEG, RAW (14 bit)

Image-recording Quality	Pixels	Image Type
 L,  L	3888 × 2592 (Approx. 10.10 megapixels)	JPEG
 M,  M	2816 × 1880 (Approx. 5.30 megapixels)	
 S,  S	1936 × 1288 (Approx. 2.50 megapixels)	
RAW	3888 × 2592 (Approx. 10.10 megapixels)	Lossless RAW
sRAW	1936 × 1288 (Approx. 2.50 megapixels)	
 - 3-2 RAW+JPEG simultaneous recording: Same as above for JPEG

3-3 File size and recording capacity:

Image-recording Quality	Image File Size [Approx. MB]	Possible Shots [Approx.]	Max burst [Approx.]	
			High-speed	Low-speed
L	3.5	274	75	205
L	1.8	523	171	523
M	2.1	454	140	454
M	1.1	854	303	854
S	1.2	779	271	779
S	0.7	1451	625	1451
RAW	12.4	76	17	20
RAW + L	12.4+3.5	59	14	16
RAW + L	12.4+1.8	66	14	16
RAW + M	12.4+2.1	65	14	16
RAW + M	12.4+1.1	70	14	16
RAW + S	12.4+1.2	69	14	16
RAW + S	12.4+0.7	72	14	16
sRAW	7.1	135	20	34
sRAW + L	7.1+3.5	90	17	21
sRAW + L	7.1+1.8	107	17	22
sRAW + M	7.1+2.1	103	17	22
sRAW + M	7.1+1.1	116	17	23
sRAW + S	7.1+1.2	115	17	24
sRAW + S	7.1+0.7	124	17	25

* The number of possible shots and maximum burst apply to a 1GB CF card based on Canon's testing standards

* The single-image size, number of possible shots, and maximum burst during continuous shooting will vary depending on the subject, CF card brand, ISO speed, Picture Style, etc.

3-4 Highlight tone priority:

Enabled (C.Fn II-3-1)

3-5 Image recording format:

Complies with Design rule for Camera File system 2.0 and Exif 2.21

3-6 Extension:

JPEG: JPG, RAW: CR2 (Canon Raw 2nd edition)

3-7 File No.:

The following three types of file numbers can be set:

1) Continuous numbering

* The continuous numbering of captured images will continue even after you replace the camera's CF card. (The numbering continues even when the folder changes.)

2) Auto reset

* When you replace the camera's CF card, the numbering will be reset to start from 0001. If the new CF card already contains images, the numbering will continue from the last recorded image in the CF card.

3) Manual reset

* Resets the file number to 0001, and creates a new folder automatically.

- 3-8 **Picture Style:**
- 1) Standard
 - 2) Portrait
 - 3) Landscape
 - 4) Neutral
 - 5) Faithful
 - 6) Monochrome
 - 7) User Defined 1-3
- *If the Basic Zone's Portrait mode is set, "Portrait" is set automatically.
And if the Basic Zone's Landscape mode is set, "Landscape" will be set automatically. In other Basic Zone modes, "Standard" will be set automatically.
- *In the Creative Zone modes, you can select and set the desired Picture Style.

3-9 **Picture Style settings:**

Item	Selections / Settings
Base style	Standard / Portrait / Landscape / Neutral / Faithful / Monochrome / Picture Style file
Sharpness	0 / 1 / 2 / 3 / 4 / 5 / 6 / 7
Contrast	-4 / -3 / -2 / -1 / 0 / +1 / +2 / +3 / +4
Color saturation	-4 / -3 / -2 / -1 / 0 / +1 / +2 / +3 / +4
Color tone	-4 / -3 / -2 / -1 / 0 / +1 / +2 / +3 / +4
Filter effect	N: None, Ye: Yellow, Or: Orange, R: Red, G: Green
Toning effect	N: None, S: Sepia, B: Blue, P: Purple, G: Green

- 3-10 **Color space:** Selectable between sRGB and Adobe RGB
- 3-11 **Noise reduction:**
- 1) Long exposure noise reduction (C.Fn II-1)
Functions with exposures 1 sec. or longer. [Auto] or [On] (Always applied) settable.
 - 2) High ISO speed noise reduction (C.Fn II-2)
[Off] or [On] can be selected.

4. **Recording Media Drive**

- 4-1 **Recording media:** CF card
*Accepts CF card Types I and II
*With WFT-E3, external recording media can also be used.
- 4-2 **Format:** CF card standard formatting
*Compatible with 2GB and higher-capacity CF cards.
- 4-3 **CF card access indicator:** Access lamp blinking
- 4-4 **Read error warning:** The respective error warning is displayed in the viewfinder and on the LCD monitor, and the shutter release locks.
- 4-5 **CF card formatting:** Enabled
- 4-6 **No CF card warning:** Provided

- 4-7 **Recording functions via WFT-E3:** With a CF card in the camera and external recording media connected via WFT-E3, the following recording functions are possible:
- 1) Standard
 - * No automatic switching of recording media.
 - 2) Automatic switching of recording media
 - * When the current recording media becomes full, it switches to another recording media automatically and continues recording.
 - 3) Separate recording
 - * Each recording media can be set to record a specific image-recording quality (L, L, M, M, S, S, RAW, sRAW) for each shot.
 - 4) Recording of identical images
 - * Images can also be recorded at the same size to both recording media (RAW+JPEG or sRAW+JPEG).
 - 5) Backup to external recording media
 - * Selected images, all images, and quick backup are possible.

5. White Balance

- 5-1 **Type:** Auto white balance with the image sensor
 5-2 **Modes:**

WB Mode	Color Temperature (Kelvin)
① Auto (AWB)	Approx. 3000-7000
② Daylight	Approx. 5200
③ Shade	Approx. 7000
④ Cloudy, twilight, sunset	Approx. 6000
⑤ Tungsten light	Approx. 3200
⑥ White fluorescent light	Approx. 4000
⑦ Flash	Approx. 6000
⑧ Custom (Custom WB)	Approx. 2000-10000
⑨ Color Temperature	Approx. 2500-10000

* In Basic Zone modes, Auto (AWB) is set automatically.

- 5-3 **White balance correction:**
- Blue/amber bias: ± 9 levels
 - Magenta/green bias: ± 9 levels
- * Corrected in reference to the current WB mode's (any mode listed in 5-2 above) color temperature.
- 5-4 **White balance bracketing:**
- ± 3 levels, in single-level increments
- * With the current WB mode's (any mode listed in 5-2 above) color temperature as the standard, one image each for "Set value/Blue bias/Amber bias" or "Set value/Magenta bias/Green bias" is created.
- * Both "Blue bias/Amber bias" and "Magenta bias/Green bias" cannot be set together.
- * White balance correction and AEB can also be set in combination.

6. Viewfinder

- 6-1 **Type:** Eye-level SLR (with fixed pentaprism)
 6-2 **Focusing screen:** Ef-A provided as the standard focusing screen (Interchangeable. Ef-D: Grid lines, Ef-S: Point of focus)
 6-3 **Dioptric adjustment:** Adjustable from -3.0 dpt to +1.0 m⁻¹ (dpt)
 6-4 **Eye point:** 22 mm
 6-5 **Coverage:** Approx. 95% vertically and horizontally

6-6	Magnification:	Approx. 0.95x (with 50mm lens at infinity, -1 m ⁻¹ (dpt))
6-7	Viewfinder information:	1) AF information AF points and focus confirmation light 2) Exposure information Shutter speed, aperture, ISO speed (Always displayed), AE lock, exposure level, spot metering circle, exposure warning 3) Flash information Flash ready, flash exposure compensation, high-speed sync, FE lock, red-eye reduction light 4) Image information Monochrome shooting, maximum burst (2-digit display), white balance correction, CF card information
6-8	Mirror:	Quick-return half mirror (Transmittance:reflectance ratio of 40:60)
6-9	Viewfinder blackout time:	Approx. 0.1 sec. at 1/60 sec. or faster speeds.
6-10	Mirror lockup:	Enabled with C.Fn III-7-1
6-11	Mirror cut-off:	No mirror cut-off with lenses up to EF600mm f/4L IS USM
6-12	Depth-of-field preview:	Enabled with depth-of-field preview button
6-13	Eyepiece shutter:	None (Eyepiece cover attached to strap)
6-14	Misc.:	Eyecup Ef provided

7. Live View Shooting

7-1	Type:	Electronic viewfinder with imaging sensor
7-2	Coverage:	Approx. 100% vertically and horizontally
7-3	Frame rate:	30 fps
7-4	Focusing:	1) Manual focus *Magnify the image by 5x or 10x and focus manually. 2) Autofocus *With C.FnIII-6, press the <AF-ON> button and the reflex mirror will go back down (Live View shooting interrupted). The same phase difference as during normal shooting is executed. After focus is achieved, let go of the <AF-ON> button and Live View shooting will resume.
7-5	Metering:	Real-time evaluative metering with the imaging element *AE lock possible. *Metering range: EV 0 - EV 20 (At 23° C/73° F, 50mm f/1.4 lens, ISO 100) *The active metering time can be changed.
7-6	Exposure confirmation:	Exposure compensation and AEB simulation possible (C.Fn IV-7-1)
7-7	Depth-of-field preview:	Possible with Depth-of-field preview button
7-8	Magnified view:	Magnify by 5x or 10x at the AF point position
7-9	Grid display:	Two vertical and two horizontal lattice lines displayable

- 7-10 **On-screen information display:** 1) Focus information
AF point
2) Exposure information
Shutter speed, aperture, AE lock, ISO speed, exposure level
3) Captured image information
Picture Style, histogram, shots remaining
4) Battery check icon
- 7-11 **Silent shooting:** Provided (Mode 1 and Mode 2)
- 7-12 **Number of possible shots:** With Battery Pack BP-511A

Temperature	Shooting Conditions	
	AE 100%	AE 50%, FA 50%
At 23°C /73°F	Approx. 180	Approx. 170
At 0°C /32°F	Approx. 140	Approx. 130

* Based on CIPA (Camera & Imaging Products Association) testing standards.

- 7-13 **Shutter-release time lag:** 1) With SW-1 ON, time lag from SW-2 ON to the start of the exposure: 0.059 sec.
2) With SW-1 and SW-2 pressed simultaneously, time lag until the start of the exposure: 0.126 sec.
* Time lag figures above apply with the aperture stopped down by up to 3 stops (reflex mirror operation time excluded).

- 7-14 **Remote Live View shooting:** Enabled with EOS Utility

8. Autofocus

- 8-1 **Type:** TTL-CT-SIR AF-dedicated CMOS sensor
- 8-2 **AF points:** Nine cross-type AF points (f/2.8 at center)
- 8-3 **Focusing modes:** 1) Autofocus
(1) One-Shot AF
* Set automatically in the Portrait, Landscape, Close-up, and Night Portrait modes.
(2) Predictive AI Servo AF
* Set automatically in Sports mode.
(3) AI Focus AF (Switches between One-Shot AF and AI SERVO AF automatically)
* Set automatically in Full Auto and Flash Off modes.
- 2) Manual focus
- 8-4 **Focusing point selection:** 1) Manual selection
* With C.Fn III-3-1/2, the Multi-controller or Quick Control Dial can be used to select the AF point directly.
2) Automatic selection
* Set automatically in Basic Zone and A-DEP modes.
- 8-5 **Selected AF point display:** Indicated by superimposed display in the viewfinder and on the LCD panel
- 8-6 **AF activation:** Press the shutter button halfway or press the AF start button
- 8-7 **Focus confirmation:** Indicated by superimposed display in viewfinder, focus confirmation light, and beeper
- 8-8 **AF working range:** EV -0.5 - 18 (at 23° C/73° F and ISO 100, under Canon's testing standards)

- 8-9 AF-assist beam: Intermittent firing of built-in flash.
 Effective range: Approx. 4 m/13.1 ft at center, approx. 3.5 m/11.5 ft at periphery.
 * With an EOS-dedicated Speedlite attached, the Speedlite's AF-assist beam is emitted instead.

9. Exposure Control

- 9-1 Type: Max. aperture TTL metering with 35-zone SPC with the following selectable modes:
 1) Evaluative metering (linked to all AF points)
 2) Partial metering (center, approx. 9% of viewfinder)
 3) Spot metering (center, approx. 3.8% of viewfinder)
 4) Center-weighted average metering
- 9-2 Exposure modes:
 1) Program AE (shiftable)
 2) Shutter-priority AE (Safety shift possible: C.Fn I-6-1)
 3) Aperture-priority AE (Safety shift possible: C.Fn I-6-1)
 4) Depth-of-field AE
 5) Full Auto
 6) Programmed Image Control modes (6)
 * Portrait, Landscape, Close-up, Sports, Night Portrait, Flash OFF
 7) Manual exposure (including bulb)
 8) E-TTL II autoflash program AE
 * Evaluative metering, Averaged metering
- 9-3 Metering range: EV 0-20 (at 23° C/73° F with 50mm f/1.4 lens at ISO 100, under Canon's testing standards)
- 9-4 Exposure beyond range warning: Shutter speed or aperture reading blinks on the LCD panel and in the viewfinder
- 9-5 Exposure metering: Activated when shutter button is pressed halfway (SW-1 ON)
- 9-6 ISO Speed (Recommended exposure index): **Automatically set**, 100 - 1600 (in 1/3-stop or whole-stop increments)
 * ISO 100-800 set automatically in Basic Zone modes.
 * ISO 3200 extension settable with C.Fn I-3-1.
 * With [Highlight tone priority], the settable ISO speed range will be 200 - 1600.
- 9-7 Exposure Compensation: ±3 stops in 1/3-stop or 1/2-half increments. Manual and AEB correction factor

Shooting Mode	Factor	
	Shutter Speed	Aperture
① Shutter-priority AE	—	Yes
② Aperture-priority AE	Yes	—
③ Program AE	Yes	Yes
④ Manual	Yes	—

- * Manual exposure compensation and AEB can be combined.
 * The AEB shooting sequence will be correct exposure, underexposure, and overexposure.
 * With the self-timer, three continuous shots will be taken regardless of the current drive mode.

- 9-8 **AE Lock:** 1)Auto AE lock
 * In the One-Shot AF mode with evaluative metering, AE lock takes effect when focus is achieved.
 2)Manual AE lock
 * With AE lock button. (AE lock is updated each time you press the button.)
 Enabled in all metering modes.
- 9-9 **Multiple exposures:** Not possible
- 10. Shutter**
- 10-1 **Type:** Vertical-travel, mechanical, focal-plane shutter with all speeds electronically-controlled
- 10-2 **Shutter speeds:** 1/8000 sec. to 30 sec. (1/3-stop increments) X-sync at 1/250 sec.
- 10-3 **Shutter release:** Soft-touch electromagnetic release
- 10-4 **Shutter-release time lag:** 1)During SW-1 ON, time lag between SW-2 ON and start of exposure: **Approx. 0.059 sec.**
 2)Time lag between simultaneous SW-1/SW-2 ON and start of exposure: **Approx. 0.126 sec.**
 * Time lag with the aperture stopped down by 3.5 stops or less. Excludes AF operation time.
- 10-5 **Self-timer:** 10-sec. or **2-sec.** delay
- 10-6 **Self-timer operation indicator:**
 - Red-eye reduction lamp (blinks for the first 8 sec., then lights for the remaining 2 sec.)
 - Countdown displayed on LCD panel
 - Beeper (Beeps at 2 Hz for the first 8 sec., then at 8 Hz for last 2 sec.)
- 10-7 **Camera shake warning:** Provided in Full Auto and Basic Zone modes
 *If the shutter speed (Tv-auto) is 0 to 0.5 stops slower than the reciprocal of the lens focal length \times 1.25, the shutter speed display blinks.
- 11. Built-in Flash**
- 11-1 **Type:** Auto pop-up, retractable, built-in flash in the pentaprism
- 11-2 **Guide No.:** Guide No. 13/43 (at ISO 100 in meters/feet)
- 11-3 **Recycling time:** Approx. 3 sec.
- 11-4 **Flash coverage:** Up to 17mm focal length (equivalent to 27mm in 135 format)
- 11-5 **Firing conditions:** 1)Creative Zone modes: After pop-up, fires at all times
 2)Basic Zone modes (except Landscape, Sports, Flash off):
 Auto pop-up and firing under low-light and backlit conditions
- 11-6 **Flash sync speed:** Max. X-sync speed 1/250 sec.
- 11-7 **Autoflash system:** E-TTL II autoflash (Evaluative, Average), FE lock
- 11-8 **Flash exposure compensation:** Up to ± 2 stops in 1/3- or 1/2-stop increments
 *Flash exposure compensation for built-in flash and Speedlite can be set with the camera.

11-9 Effective flash range: (Approx. m/ft)

ISO	EF-S18-55mm f/3.5-5.6 IS	
	WIDE : 18mm	TELE : 55mm
100	1 - 3.7 / 3.3 - 12.1	1 - 2.3 / 3.3 - 7.5
200	1 - 5.3 / 3.3 - 17.4	1 - 3.3 / 3.3 - 10.8
400	1 - 7.4 / 3.3 - 24.3	1 - 4.6 / 3.3 - 15.1
800	1 - 10.5 / 3.3 - 34.4	1 - 6.6 / 3.3 - 21.7
1600	1 - 14.9 / 3.3 - 48.9	1 - 9.3 / 3.3 - 30.5

11-10 Improper FE lock warning: During FE lock, the flash icon blinks

11-11 Sufficient flash indicator: None

11-12 Flash-sync timing: 1st-curtain sync
 *By selecting from Menu's [Flash control] → [Built-in flash func. setting] → [Shutter sync], 2nd-curtain sync is possible.

11-13 Flash duration: 1 ms or shorter

11-14 Color temperature: Equivalent to daylight

11-15 Optical axis space: Lens axis to flash center: 92.5 mm

11-16 Red-eye reduction: With red-eye reduction lamp

12. External Speedlite

12-1 Sync contacts: 1) Accessory shoe: X-sync contact
 *Flash sync at 1/250 sec. or slower
 2) Side panel: PC terminal (No polarity)
 *X-sync at 1/125 sec.
 *Both 1) and 2) can be used simultaneously for simultaneous flash firing.

12-2 Flash exposure compensation: ±2 stops in 1/3-stop or 1/2-stop increments

12-3 Setting procedure: With an EX-series Speedlite, the following settings are possible:
 1) External flash control
 *Flash mode, sync setting, FEB, flash exposure compensation, E-TTL II, zoom, wireless flash, and clear settings.
 2) Flash Custom Function setting

13. Drive

13-1 Drive modes: Single, high-speed continuous (approx. 6.5 fps), low-speed continuous (approx. 3 fps), 10-sec. or 2-sec. self-timer

13-2 Maximum burst: Refer to 3-3.

13-3 Battery life:

1) With Battery Pack BP-511A

Battery	Temperature	Shooting Conditions	
		AE 100%	AE 50%, FA 50%
BP-511A×1	At 23°C /73°F	Approx. 1100	Approx. 800
	At 0°C /32°F	Approx. 950	Approx. 700

2) With BG-E2N (BG-E2N) + Battery Pack BP-511A

Battery	Temperature	Shooting Conditions	
		AE 100%	AE 50%, FA 50%
BP-511A×1	Same as 1)		
BP-511A×2	At 23°C /73°F	Approx. 2200	Approx. 1600
	At 0°C /32°F	Approx. 1900	Approx. 1400

* Based on CIPA (Camera & Imaging Products Association) testing standards.

14. LCD Monitor

- 14-1 Type: TFT color, liquid-crystal monitor
- 14-2 Screen size: 3.0 in.
- 14-3 Pixels: Approx. 230,000 pixels
- 14-4 Coverage: Approx. 100%
- 14-5 Viewing angle: Approx. 140° vertically and horizontally
- 14-6 Brightness adjustment: 7 levels
- 14-7 Angle adjustment: None
- 14-8 Protective cover: None

15. Playback

- 15-1 Image review: Set to Off, 2/4/8 sec., or hold
- 15-2 Image display format: 1) Single image display
Two types of single-image full display and two types of shooting information display.
2) Index display
4-image index and 9-index image.
3) Jump display
10/100 images, index screen, shooting date
- 15-3 Display conditions: Images saved in Design rule for Camera File system format
- 15-4 AF point display: AF point which achieved focus is displayed
- 15-5 Highlight alert: With single-image display (Info.) and single-image display, overexposed highlight areas will blink
- 15-6 Histogram display: 1. Brightness 2. RGB
- 15-7 Magnify zoom display: Magnification approx. 1.5x to 10x enabled in 15 steps
- 15-8 Rotated display: 1) Manual
2) Auto rotate
- 15-9 Video output: Compatible with NTSC and PAL depending on the video OUT terminal

16. Protection/Deletion of Recorded Images

- 16-1 Protection: Erase protect (or cancel) each image individually

16-2 Erase: Erase single image, [erase selected images](#), erase all images in a card, or erase only unprotected images

17. Menus

17-1 Description: Shooting, Playback, Set-up, Custom Function, My Menu
 17-2 LCD monitor language: Any of the following [18 languages](#) can be selected: English, German, French, Dutch, Danish, [Portuguese](#), Finnish, Italian, Norwegian, Swedish, Spanish, [Greek](#), Russian, [Polish](#), Simplified Chinese, Traditional Chinese, Korean and Japanese.
 17-3 Firmware updating: Enabled by the user

18. PictBridge

18-1 Paper sizes: Credit card size (5.4 cm×8.6 cm) to A3+/13×19, 14"×17", roll paper (width 9 cm/4"/13 cm/21 cm)
 18-2 Paper types: Plain, Photo, Fast Photo, Fine Art, Semi-gloss
 18-3 Printing effects: Default, On, Off, Vivid, NR, Vivid+NR, Natural, Natural M, B/W, Cool tone, Warm tone,
 *Brightness, Adjust levels, face brightener, red-eye correction, contrast, color saturation, color tone, and color balance are adjustable.
 *[Printing effects preview enabled \(except for face brightener and red-eye correction\)](#)
 *The selectable printing effects may differ depending on the printer.
 18-4 Layout: Borders, borderless, 2/4/8/9/16/20/35-image layout (duplicate images on one sheet), print + shooting information, 20-image index + shooting information, 35-image contact sheet index, standard setting
 18-5 Trimming: Trim horizontally up to 16 steps, vertically up to 10 steps
 18-6 [Tilt correction](#): [With the trimming screen, the image can be tilted up to ±10° in 0.5° increments](#)
 18-7 Date and file No. imprinting: Date, file No., Both, Off, Default setting
 18-8 DPOF-compatible: DPOF print ordering provided
 *If both Standard and Index are set, only Standard will take effect for printing.
 18-9 Printable images: [RAW](#), [sRAW](#), and JPEG images complying to Design rule for Camera File System
 18-10 BubbleJet Direct and CP Direct: Not supported

*Since available PictBridge features differ depending on the printer, details are not provided here. If a Canon printer is used, see the specifications at the following Web site after the product announcement.

<http://canon.jp/pictbridge/> (Japanese)

<http://canon.com/pictbridge/> (English)

19. Print specification (DPOF)

19-1 System: Complies to DPOF Version 1.1
 19-2 Specification with print screen: 1) Individual images
 2) All images in CF card
 *Print specification is not possible for RAW/sRAW images.

- 19-3 **Print type:** 1)Standard
2)Index
3)Both
- 19-4 **Date/File No. print:** Enabled
*For the index, both the date and image number cannot be set to [On].
- 19-5 **Camera direct:** All the selected images can be printed in a batch
20. **Direct Image Transfer**
- 20-1 **Compatible PC:** Windows and Macintosh computers with EOS DIGITAL Solution Disk Ver.15 installed
- 20-2 **Transferable images:** JPEG / RAW / sRAW images
- 20-3 **Image transfer:**
- 1)All images
*All images stored in the CF card are transferred to the PC.
 - 2)All images not yet transferred
*Only images that haven't been transferred to the PC are automatically selected for transfer.
 - 3)Images marked for transfer
*Select images individually [Sel. image] or select all images [All image] to be transferred to the personal computer.
*Up to 998 images can be selected for the transfer.
 - 4)Select and transfer
*Select the images to be transferred and they will be transferred one by one.
 - 5)Personal computer wallpaper
*Select the image to be the personal computer's wallpaper, then transfer it (JPEG only).
21. **Customization**
- 21-1 **Custom Functions:** 24 Custom Functions with 62 settings settable with the camera
- 21-2 **Camera user settings:** Current camera settings can be registered under the Mode Dial's C1, C2, and C3 settings
- 21-3 **My Menu:** Up to six top-tier menu options and Custom Function settings can be registered
22. **External Interface**
- 22-1 **Digital terminal:** USB 2.0 Hi-Speed, mini B port
- 22-2 **Video output terminal:** Provided (NTSC/PAL)
- 22-3 **Remote control terminal:** N3-type terminal
- 22-4 **Extension system terminal:** For WFT-E3
23. **Power Source**
- 23-1 **Battery:** Battery Pack BP-511A×1
*With the AC Adapter Kit ACK-E2, AC power is possible.
*With BG-E2N or BG-E2, two battery packs can be used. Or six size-AA batteries can be used.
- 23-2 **Main switch:** OFF/ON/ON (Quick Control Dial ON), 3 settings
- 23-3 **Start-up time:** Approx. 0.15 sec.

23-4	Battery check:	Automatic battery check when the main switch is turned on. The battery level is indicated by one of four levels on the LCD panel.
23-5	Power-saving feature (Auto power off):	Power turns off after the set time (1, 2, 4, 8, 15, or 30 min.) of non-operation elapses
23-6	Date/time back-up battery:	<ul style="list-style-type: none"> • Lithium CR2016 button battery × 1 • Battery life approx. 5 years
24.	Body (Chassis) Material	Stainless steel and polycarbonate with glass fiber
25.	Exterior	
25-1	Exterior material:	Magnesium alloy
25-2	Exterior color:	Paint finish: Black
25-3	Tripod socket:	CU 1/4
25-4	LCD panel illumination:	Approx. 6-sec. illumination with panel illumination button
26.	Dimensions	145.5 (W) × 107.8 (H) × 73.5 (D) mm 5.7 (W) × 4.2 (H) × 2.9 (D) in.
27.	Weight	740 g / 26.1 oz. *Excludes battery pack, CF card, and body cap. *Includes backup battery and eyecup.
28.	Operating Environment	
28-1	Operating temperature:	0° C to 40° C / 32 to 104° F
28-2	Operating humidity:	85% or less
29.	Accessories	
29-1	Focusing screen:	Ef-A (standard precision matte), Ef-D (precision matte with grid), Ef-S (super precision matte)
29-2	Wireless/wired LAN accessories:	WFT-E3
29-3	Grip:	BG-E2N Battery Grip BG-E2
29-4	Battery Pack:	Battery Pack BP-511A
29-5	Battery Charger:	Battery Charger CG-580, CB-5L
29-6	AC power source:	AC adapter kit ACK-E2
29-7	Interface Cable:	Interface Cable IFC-200U, IFC-500U
29-8	Video Cable:	Video Cable VC-100
29-9	Strap:	Wide Strap EW-100DGR
29-10	EOS System Accessories:	See the System Accessory Compatibility Table

4. NOMENCLATURE AND DIMENSIONS

4.1 Nomenclature (Function names different from EOS 30D are in blue.)



Fig. 033 Nomenclature

4.2 Dimensions

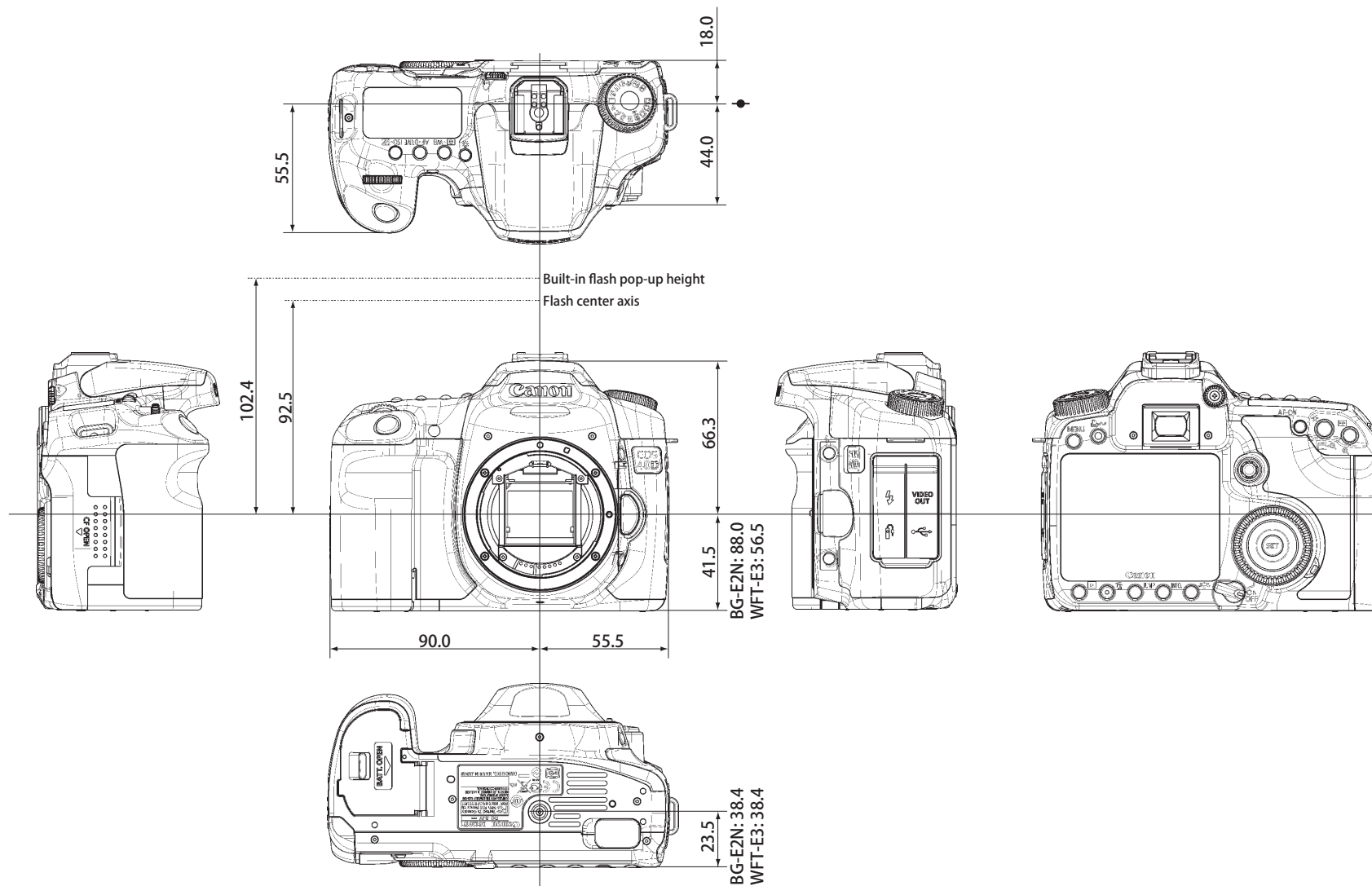

Fig. 034 Six Exterior Views

5. VISUAL INDICATORS

5.1 Viewfinder Information

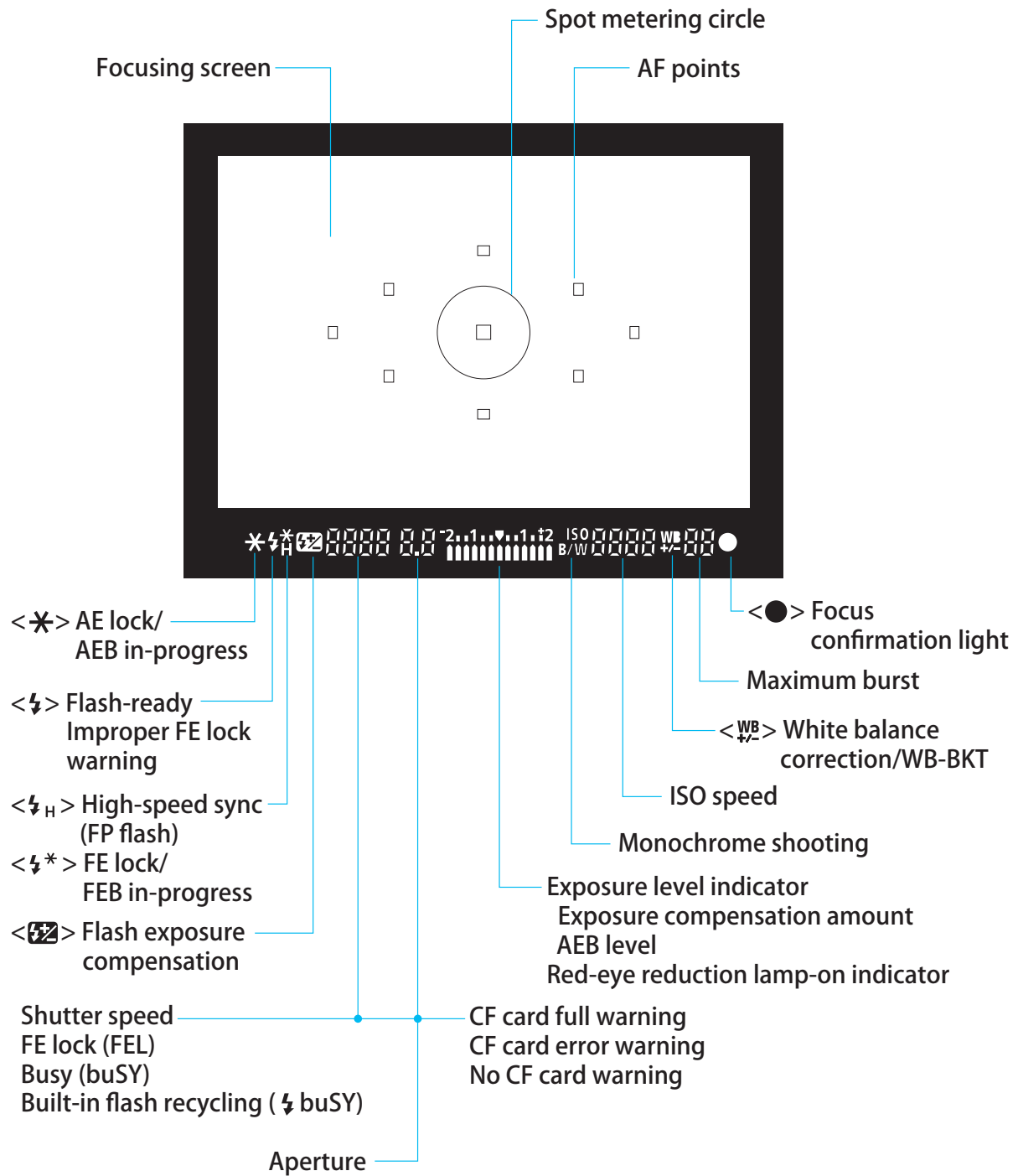

Fig. 035 Viewfinder Information

5.2 LCD Panel Information and Model Dial

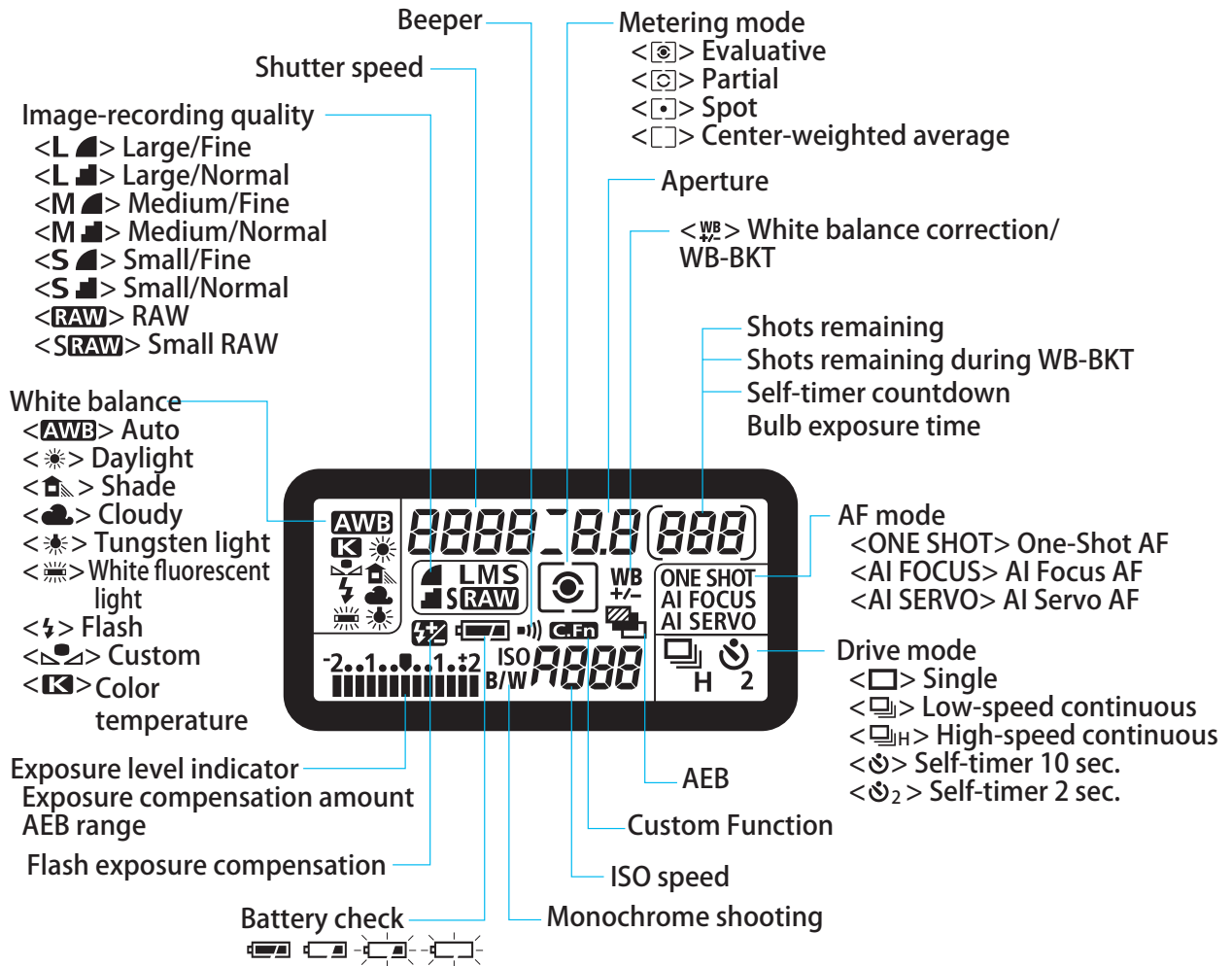

Fig. 036 LCD Panel

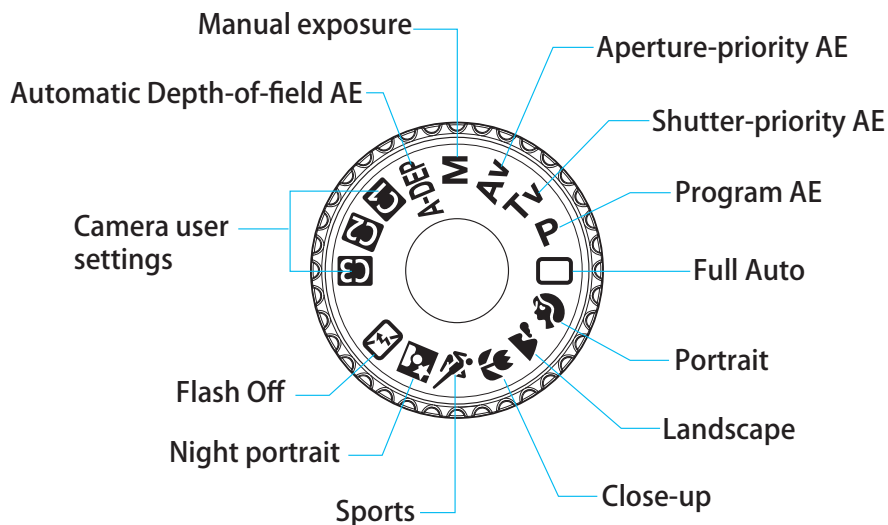

Fig. 037 Mode dial

Table 004 Function Availability Table

● : Set automatically ○ : User selectable ■ : Not selectable

Mode Dial		Basic Zone						Creative Zone					
								P	Tv	Av	M	A-DEP	
Image-recording Quality	JPEG	○	○	○	○	○	○	○	○	○	○	○	
	RAW	■	■	■	■	■	■	○	○	○	○	○	
	RAW+JPEG	○	○	○	○	○	○	○	○	○	○	○	
ISO speed	Auto	●	●	●	●	●	●	○	○	○	○	○	
	Manual	■	■	■	■	■	■	○	○	○	○	○	
Picture Style	Standard	●	■	■	●	●	●	○	○	○	○	○	
	Portrait	■	●	■	■	■	■	○	○	○	○	○	
	Landscape	■	■	●	■	■	■	○	○	○	○	○	
	Neutral	■	■	■	■	■	■	○	○	○	○	○	
	Faithful	■	■	■	■	■	■	○	○	○	○	○	
	Monochrome	■	■	■	■	■	■	○	○	○	○	○	
	User Defined	○	○	○	○	○	○	○	○	○	○	○	
Color space	sRGB	●	●	●	●	●	●	○	○	○	○	○	
	Adobe RGB	■	■	■	■	■	■	○	○	○	○	○	
White balance	Auto WB	●	●	●	●	●	●	○	○	○	○	○	
	Preset WB	■	■	■	■	■	■	○	○	○	○	○	
	Custom WB	■	■	■	■	■	■	○	○	○	○	○	
	Color temperature setting	■	■	■	■	■	■	○	○	○	○	○	
	WB correction	■	■	■	■	■	■	○	○	○	○	○	
	WB bracketing	■	■	■	■	■	■	○	○	○	○	○	
AF	One-Shot	■	●	●	●	■	●	○	○	○	○	●	
	AI Servo	■	■	■	■	■	●	○	○	○	○	■	
	AI Focus	●	■	■	■	■	■	○	○	○	○	■	
	AF point selection	Auto	●	●	●	●	●	●	○	○	○	○	●
		Manual	■	■	■	■	■	■	○	○	○	○	■
AF-assist beam	●	●	■	●	■	●	○	○	○	○	○		
Metering mode	Evaluative	●	●	●	●	●	●	○	○	○	○	○	
	Partial	■	■	■	■	■	■	○	○	○	○	○	
	Spot	■	■	■	■	■	■	○	○	○	○	○	
	Center-weighted average	■	■	■	■	■	■	○	○	○	○	○	
Exposure	Program shift	■	■	■	■	■	■	○	■	■	■	■	
	Exposure compensation	■	■	■	■	■	■	○	○	○	■	○	
	AEB	■	■	■	■	■	■	○	○	○	○	○	
	AE lock	■	■	■	■	■	■	○	○	○	■	○	
	Depth-of-field preview	■	■	■	■	■	■	○	○	○	○	○	
Drive	Single	●	■	●	●	■	●	○	○	○	○	○	
	High-speed continuous	■	■	■	■	■	●	○	○	○	○	○	
	Low-speed continuous	■	●	■	■	■	■	○	○	○	○	○	
	Self-timer 10 sec.	○	○	○	○	○	○	○	○	○	○	○	
	Self-timer 2 sec.	■	■	■	■	■	■	○	○	○	○	○	
Built-in flash	Auto	●	●	■	●	■	●	■	■	■	■	■	
	Manual	■	■	■	■	■	■	○	○	○	○	○	
	Flash off	■	■	●	■	●	■	■	■	■	■	■	
	Red-eye reduction	○	○	■	○	■	○	○	○	○	○	○	
	FE lock	■	■	■	■	■	■	○	○	○	○	○	
	Flash exposure compensation	■	■	■	■	■	■	○	○	○	○	○	
Live View shooting	■	■	■	■	■	■	○	○	○	○	○		

6. CUSTOM FUNCTION

6.1 Custom Function List

Table 005 Custom Functions (1/2)

Category	No.	Function	Settings	
C.Fn I : Exposure	1	Exposure level increments	0	1/3-stop
			1	1/2-stop
	2	ISO speed setting increments	0	1/3-stop
			1	1-stop
	3	ISO expansion	0	Off
			1	On
	4	Bracketing auto cancel	0	On
			1	Off
	5	Bracketing sequence	0	0, -, +
			1	-, 0, +
	6	Safety shift	0	Disable
			1	Enable (Tv/Av)
	7	Flash sync. speed in Av mode	0	Auto
			1	1/250sec. (fixed)
C.Fn II : Image	1	Long exp. noise reduction	0	Off
			1	Auto
			2	On
	2	High ISO speed noise reduct'n	0	Off
			1	On
	3	Highlight tone priority	0	Disable
1			Enable	
C.Fn III : Auto focus / Drive	1	Lens drive when AF impossible	0	Focus search on
			1	Focus search off
	2	Lens AF stop button function	0	AF stop
			1	AF start
			2	AE lock
			3	AF point:M → Auto/Auto → ctr
			4	ONE SHOT ↔ AI SERVO
	3	AF point selection method	0	Normal
			1	Multi-controller direct
			2	Quick Control Dial direct
	4	Superimposed display	0	On
			1	Off
	5	AF-assist beam firing	0	Enable
			1	Disable
			2	Only external flash emits
	6	AF during Live View shooting	0	Disable
			1	Enable
	7	Mirror lockup	0	Disable
			1	Enable

Table 005 Custom Functions (2/2)

Category	No.	Function	Settings	
C.Fn IV : Operation / Others	1	Shutter button/AF-ON button	0	Metering + AF start
			1	Metering + AF start/AF stop
			2	Metering start/Meter + AF start
			3	AE lock/Metering + AF start
			4	Metering + AF start / disable
	2	AF-ON/AE lock button switch	0	Disable
			1	Enable
	3	SET button when shooting	0	Normal (disabled)
			1	Change quality
			2	Change Picture Style
			3	Menu display
			4	Image replay
	4	Dial direction during Tv/Av	0	Normal
			1	Reverse direction
	5	Focusing Screen	0	Ef-A
			1	Ef-D
			2	Ef-S
	6	Add original decision data	0	Off
			1	On
	7	Live View exposure simulation	0	Disable (LCD auto adjust)
			1	Enable (simulates exposure)

7. PROGRAM DIAGRAMS

7.1 Program Diagrams

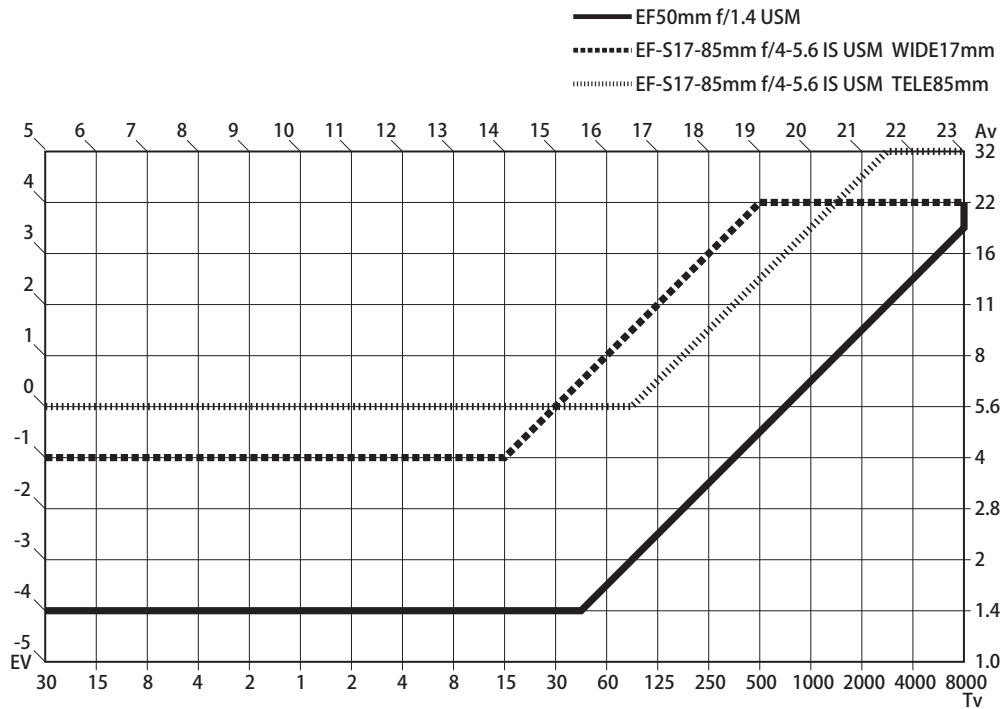

Fig. 038 Normal Program AE Lines

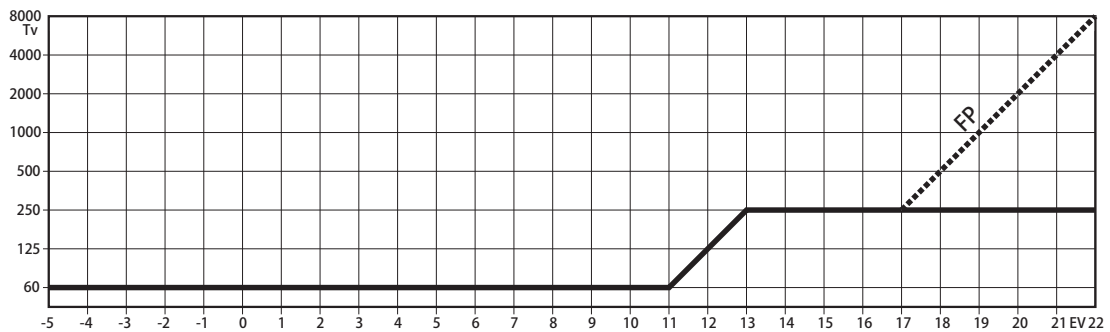
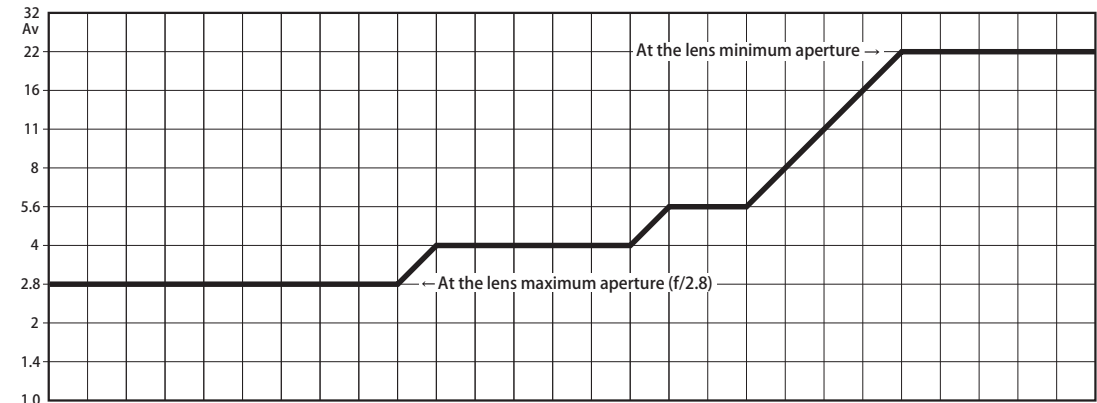

Fig. 039 E-TTL II autoflash program line (EF50mm f/1.4 USM, at ISO 100)

8. SYSTEM ACCESSORIES COMPATIBILITY TABLES

8.1 System Accessories

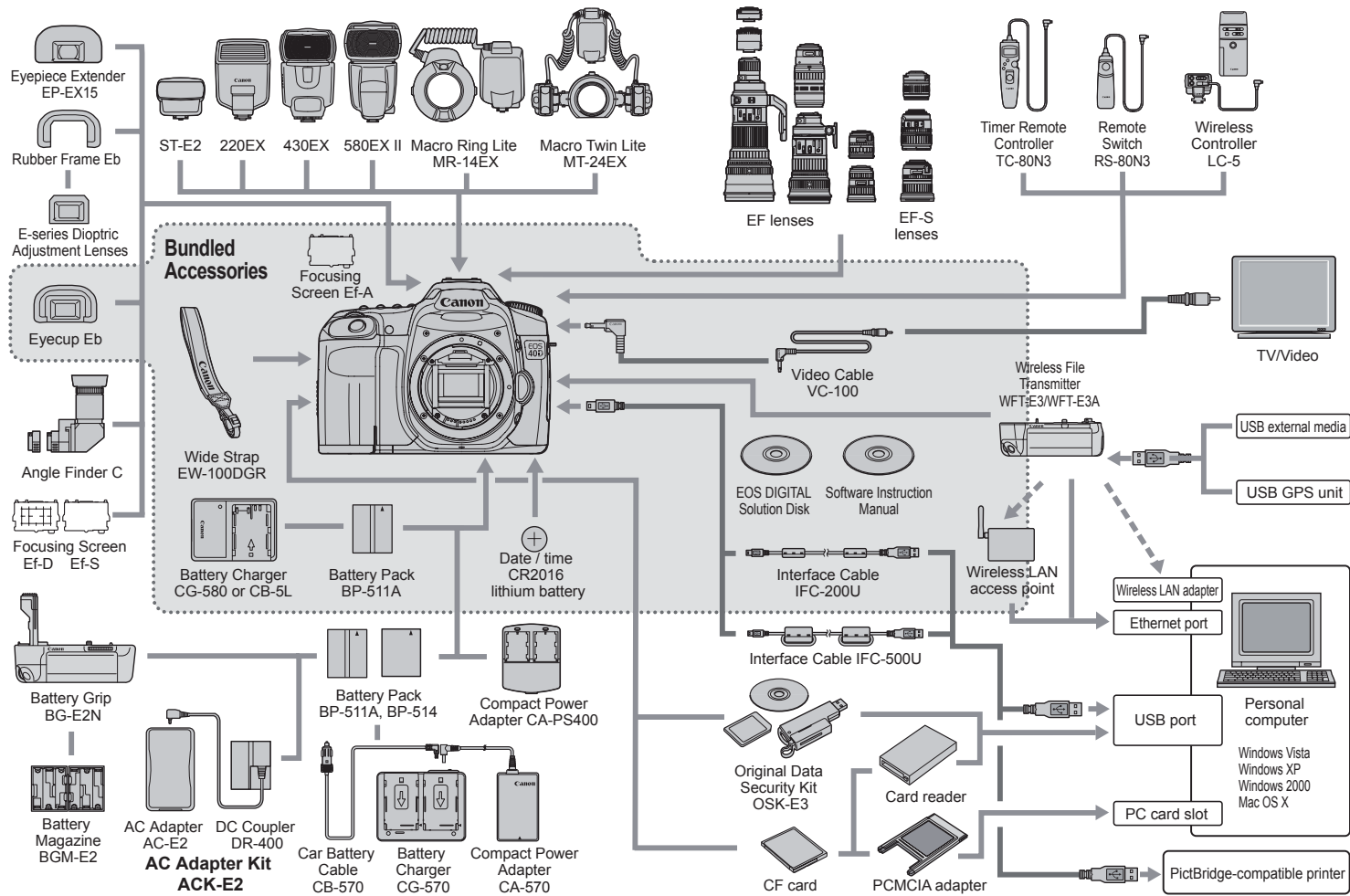

Fig. 040 System map

8.2 System Accessory Compatibility

Note that the following system accessories have some restrictions when used with the EOS 40D.

Table 006 Accessories with Restrictions

Interchangeable Lenses	
Lens Mount Converter FD-EOS	Although it can be used with manual exposure, exposure error occurs. Therefore, these items will be officially listed as incompatible.
Macro Lens Mount Converter FD-EOS	
Speedlites	
480EG	Compatible with external flash metering and manual flash. (With TTL autoflash, the flash can be fired at full output only.)
540EZ	
430EZ	Compatible with manual flash. (With TTL autoflash, the flash can be fired at full output only.)
420EZ	
ML-3	The flash can be fired at full output only.
300EZ	
200E	
Wired multi-Speedlite accessories	Same with the Speedlites above.

System accessories not listed above are completely compatible with EOS 40D.

Technical Information

Trademarks

The product names and company names described in this Service Manual are the registered trademarks of the individual companies.

Copyright

Canon Inc. retains the copyright to this Service Manual. Reproduction, publication (including on the World Wide Web), alteration, translation into another language, or other use of the data in whole or part, contained on this Service Manual without the written consent of Canon Inc. is prohibited.

CONTENTS

	Page
Technical Information	
<hr/>	
1. TECHNICAL DESCRIPTION.....	1
1.1 Imaging element and CMOS sensor.....	1
1.2 Image-recording and processing	2
1.3 Dust delete feature	5
1.4 AF System.....	6
1.5 Viewfinder	8
1.6 Exposure control	9
1.7 Flash.....	9
1.8 Drive	10
1.9 Live View shooting	11
1.10 Basic operation concept and LCD monitor display	13
1.11 Internal construction	14

1. TECHNICAL DESCRIPTION

This section focuses on the new technologies incorporated after the EOS 30D. The explanation of new features already incorporated in the EOS-1D Mark III will be cited in the EOS-1D Mark III "Service Manual."

*Normally, topics related to direct printing, direct image transfer, print ordering, interface, and power source covered in the "Technical Information" do not delve into technical details any more than in "General Information". They are only cited here.

1.1 Imaging element and CMOS sensor

1) Overview

The CMOS sensor (Fig. 001) has been developed and manufactured by Canon. It boasts the highest performance in its class: Approx. 10.10 megapixels, ISO 100-1600 and H 3200, high-speed signal reading with 6.5 fps shooting, Live View silent shooting mode with electronic 1st-curtain shutter, etc.

Table 001 CMOS sensor specifications

Specification	EOS 40D	EOS 30D
Effective pixels	3904×2598 (Approx. 10.10 million)	3520×2342 (Approx. 8.20 million)
Total pixels	3996×2620 (Approx. 10.50 million)	3600×2360 (Approx. 8.50 million)
Effective sensor size [mm]	22.2×14.8	22.5×15.0
Pixel size [μm]	5.7	6.4
Color filter	RGB primary color filter	
Aspect ratio	3:2	

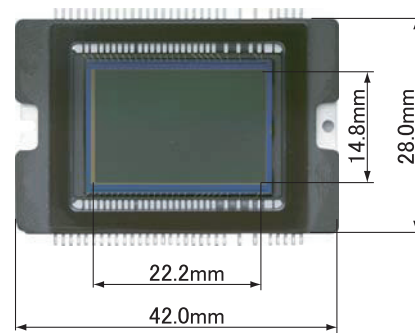

Fig. 001 CMOS sensor

2) Wide ISO speed range and low noise

While based on the EOS DIGITAL REBEL XTi/400D DIGITAL's CMOS sensor design and manufacturing technology, new processes were incorporated in the CMOS semiconductor fabrication and microlens-forming process. By improving the light-condensing efficiency, the same ISO range and low noise (S/N ratio) as the EOS 30D were attained.

Table 002 ISO Speed and Pixel Size

Camera	ISO Speed	Pixel Size [μm]
EOS 40D	100 - 1600, 3200	5.7
EOS 30D	100 - 1600, 3200	6.4
EOS DIGITAL REBEL XTi/400D DIGITAL	100 - 1600	5.7
EOS-1D Mark III	50, 100 - 3200, 6400	7.2
EOS-1Ds Mark II	50, 100 - 1600, 3200	7.2

3) High-speed, 4-channel reading

With 4-channel reading per line and faster reading (about twice as fast as EOS 30D), high-speed signal reading enabling approx. 6.5 fps continuous shooting is attained.

4) **Electronic 1st-curtain shutter for Live View silent shooting**

With Live View image displayed, the camera can seamlessly shift to slit exposures with the electronic 1st-curtain shutter. It enables silent shooting which is not possible with a mechanical 1st-curtain shutter. This electronic 1st-curtain shutter uses a unique high-speed scanning and electronic reset system which accurately mimics the EOS 40D's high-speed mechanical shutter operation. It synchronizes with the mechanical 2nd-curtain shutter to obtain a slit exposure.

*With CMOS, it is difficult to have an electronic 2nd-curtain shutter. Therefore, only the 1st-curtain shutter is electronic.

5) **Power saving**

To minimize the higher power consumption required by the high-speed signal reading, the output amp's power consumption has been kept to an absolute minimum. Also, like the EOS DIGITAL REBEL XTi/400D DIGITAL, to save power during long exposures, power to the output amp is turned off and the standard current driving the circuit is also cut off.

During Live View shooting, the power distribution for the signal-reading operation is optimized as with the EOS-1D Mark III. Such measures enable more minute power-saving control.

6) **Infrared, low-pass filter**

The basic construction and performance of the infrared, low-pass filter are the same as the EOS DIGITAL REBEL XTi/400D DIGITAL's. (Fig. 002)

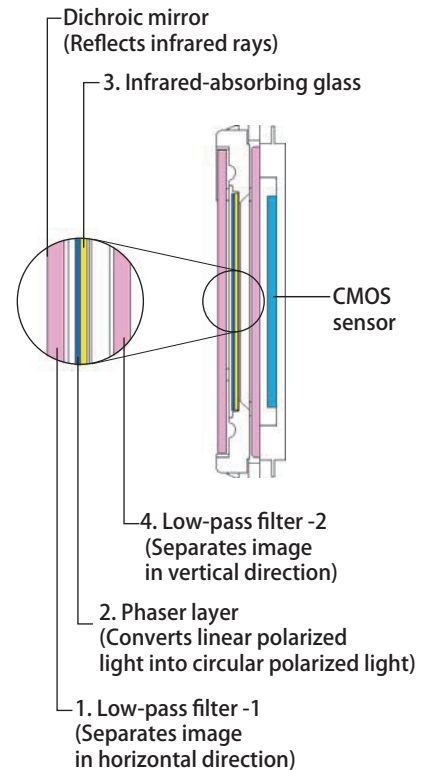

Fig. 002 Infrared, low-pass filter construction

1.2 Image-recording and processing

Compared with the EOS 30D, the EOS 40D's image quality is much improved as follows, thanks to the 10.10-megapixel CMOS sensor, DIGIC III imaging engine (single), etc.

● **High image quality factors with the EOS 40D**

1. Higher resolution with approx. 10.10 megapixels (CMOS sensor)
2. 14-bit signal processing for higher image quality (DIGIC III)
3. Noise reduction of high ISO shots (DIGIC III, C.Fn II-2)
4. Highlight tone priority (C.Fn II-3)

*For 2, see "Technical Information." For 3 and 4, see EOS-1D Mark III "Service Manual."

1) Image-recording quality and image size

On the image-recording quality selection screen (Fig. 003), when you select the image-recording quality, the respective pixel count (horizontal×vertical) and the number of shots possible with the current CF card are now displayed as well.

Also, sRAW (approx. 2.50 megapixels) has been newly added as a image-recording quality option. sRAW+JPEG is also possible.

For the image size and number of possible shots with the respective image-recording quality, see "General Information."

Selected image-recording quality and the respective pixels are displayed

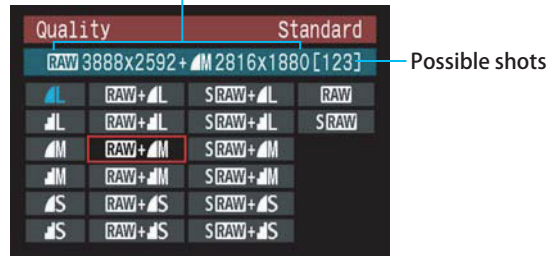

Fig. 003 Quality selection screen

2) Picture Styles

The Picture Styles and their effects, etc., are the same as with the EOS 30D.

On the left of the power switch is the new Picture Style selection button. Next to it is the INFO. button which displays the parameter setting screen for the sharpness and other parameters. The buttons improve the ease of selecting and adjusting the Picture Styles (Fig. 004).

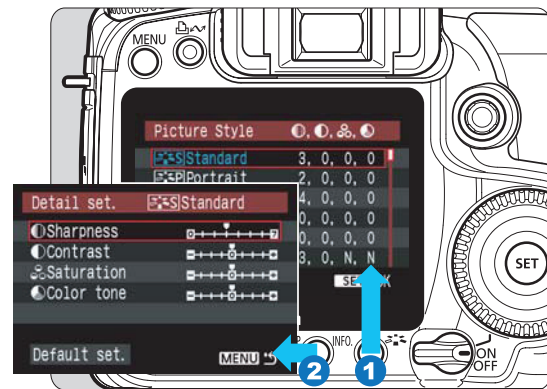

Fig. 004 Picture Style screen

3) Noise reduction

The camera has the same noise reduction feature (noise reduction for long exposures and high ISO shots) as the EOS-1D Mark III. For details, see EOS-1D Mark III "Service Manual."



4) Highlight tone priority (C.Fn II-3)

This is the same feature as the EOS-1D Mark III's. The ISO range is ISO 200-1600. For details, see EOS-1D Mark III "Service Manual."

5) Auto brightness and contrast adjustment

In the Basic Zone modes, when the image is processed internally, the brightness, contrast, and other image characteristics are detected and automatically adjusted to obtain favorable brightness and contrast. This is effective in the sample shots below:

Table 003 Sample adjustment of brightness and contrast

<p style="text-align: center;">Underexposed AE</p>  <p>* In bright scenes such as at the beach and on ski slopes, underexposure tends to result. The automatic adjustment makes the highlights brighter, resulting in a more natural-looking brightness.</p>	<p style="text-align: center;">Underexposed flash</p>  <p>* When the subject is beyond the range of the flash and becomes underexposed, the automatic adjustment makes the highlights brighter. This results in a standard flash exposure.</p>
<p style="text-align: center;">Low contrast</p>  <p>* In the case of low-contrast, hazy scenes, the contrast is adjusted to obtain a clearer and more distinct image.</p>	

6) Image recording to a CF card

The CF card access speed is now 1.7 times faster, thanks to DIGIC III. With the EOS 30D, if you opened the CF card slot cover while data is being written to the CF card, the image data would be erased. However, with the EOS 40D (and EOS-1D Mark III), the data writing still continues even if you open the CF card slot cover. If you open the slot cover, the beeper will sound and a warning screen will be displayed (Fig. 005) until you close the slot cover. Also, if you turn off the power switch while data is being written to the CF card, the screen shown in Fig. 006 is displayed during the writing. When the writing ends, the camera turns off.



Fig. 005 Open-cover warning screen

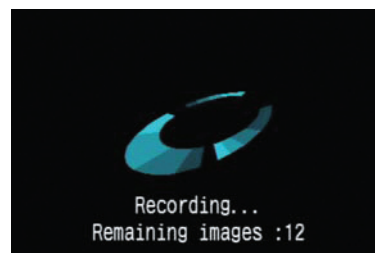

Fig. 006 Power-off screen

For specifications related to folders and file numbering, see "General Information".

1.3 Dust delete feature

As with the EOS DIGITAL REBEL XTi/400D DIGITAL and EOS-1D Mark III, the camera incorporates the EOS Integrated Cleaning System to help prevent dust generation, adhesion, and remaining.

1) Self Cleaning Sensor Unit

While it is basically the same system as the one employed in the EOS-1D Mark III, the unit uses only one piezoelectric element instead of two, and it is optimized for the smaller APS-C size instead of the larger APS-H size (Fig. 007 and 008). The dust removal performance is the same as the EOS DIGITAL REBEL XTi/400D DIGITAL and EOS-1D Mark III's unit.

The [Sensor cleaning] menu is basically the same as the EOS-1D Mark III's. However, there are slight differences such as the shutter operation* for [Clean now].

*EOS 40D: Cleaning operation → Shutter release → Cleaning operation

*EOS-1D Mark III : Cleaning operation → Shutter cocking → Cleaning operation → Shutter cocking → Cleaning operation

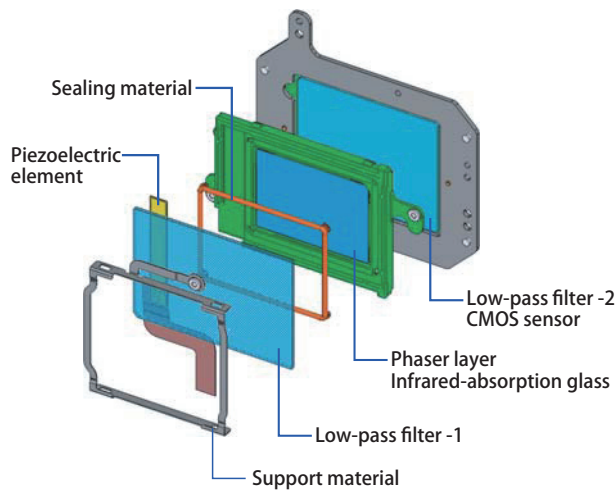

Fig. 007 Unit construction diagram

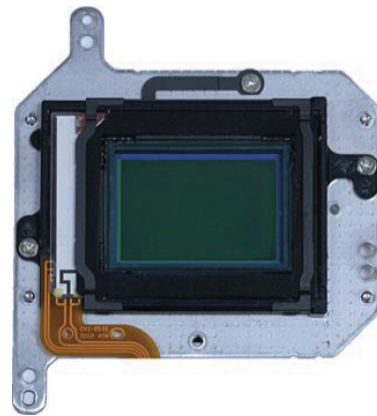

Fig. 008 Self Cleaning Sensor Unit

2) Dust Delete Data

The specifications are the same as with the EOS DIGITAL REBEL XTi/400D DIGITAL and EOS-1D Mark III.

1.4 AF System

1) Newly-developed AF sensor

With all cross-type sensors, improved AF detection precision, and extreme-defocus compatibility, the newly-developed AF sensor (Fig. 009) has much higher performance than the EOS 30D's AF sensor (Table 004). With the EOS 40D, the minute shifting the point of focus due to the difference in the spectral characteristics of the light source is corrected automatically and more stable autofocusing is enabled. This feature is especially effective for artificial light sources. The positioning of the AF points (Fig. 010) is almost the same as with the EOS 30D's AF sensor.

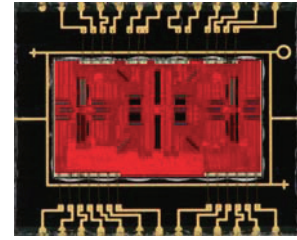

Fig. 009 AF sensor

Table 004 Specifications Comparison of AF Sensors

	EOS 40D	EOS 30D
Cross-type sensors	9 (All cross-type)	1 (Center)
High-precision f/2.8 compatibility	Cross-type sensor at center	Vertical-line sensitive at center
Extreme-defocus compatibility	Yes	—
EV range [EV]	-0.5 - 18	
Sensor pitch [μm]	14.4	16

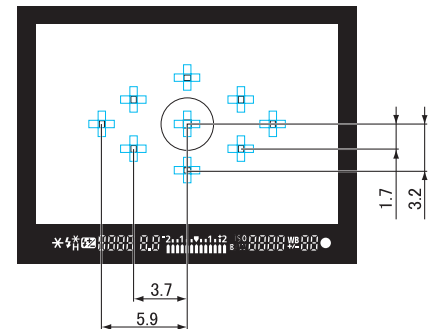

Fig. 010 AF point position and spacing

(1) All cross-type AF points

All the AF points have a cross-type line sensor for f/5.6. Both vertical- and horizontal-line sensitive focus detection works with any AF point for stable focusing.

(2) Improved AF detection precision (Fig. 011)

• Cross-type focusing at f/2.8

Previously, the sensor for f/2.8 was only vertical-line sensitive. But now, for the first time, it is both vertical- and horizontal-line sensitive. The focusing is thereby more sensitive. Also, with the sensor pitch made smaller from 16 μm to 14.4 μm , the detection performance is higher.

* Excluding the EF50mm f/2.5 MACRO and EF28-80mm f/2.8-4L USM lenses.

• Two-line focusing with horizontal-line sensitive sensors

The upper center, center, and bottom three horizontal-line sensitive sensors are in a two-line, zigzag configuration. With this double focusing system, inconsistent focusing detection is reduced.

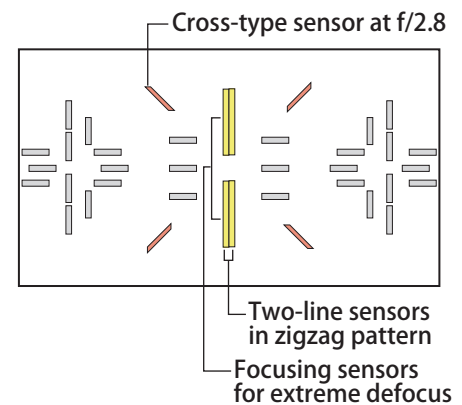

Fig. 011 Sensor configuration

(3) Extreme defocus compatibility

By using the entire two-line focusing sensors described above, a subject in extreme defocus can be detected and AF control is quick and easy. (Fig. 011)

2) **AF unit**

To attain more stable AF performance than before, the AF unit has more precise AF optics and environment-resistant construction and materials. (Fig. 012)

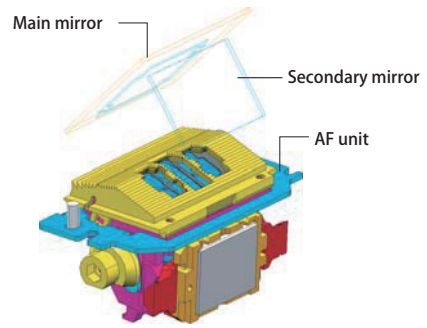

Fig. 012 AF unit

3) **AF speed and focusing calculation**

Compared to the EOS 30D, the focusing calculation speed is 1.3 times faster, and the AF data-processing time is shorter. Despite the AF sensor's number of lines and the higher number of pixels, AI SERVO AF at approx. 6.5 fps is attained.

4) **AF modes**

The AF modes are the same as the EOS 30D: One-Shot AF, AI Focus AF, and AI SERVO AF.

5) **AI SERVO AF**

Predictive AF can track a subject approaching at 50 kph up to about 8 m/26.2 ft away with an EF300mm f/2.8L IS USM lens. Since subject detection has been improved with all cross-type AF points, high-speed continuous shooting in the AI SERVO AF mode is more stable than with the EOS 30D.

6) **Automatic AF point selection**

The algorithm is the same as the EOS 30D's. However, with all AF points being cross-type sensors, the subject detection is improved, making the AI SERVO AF subject-tracking performance better. Also in the One-Shot AF mode, it increases the probability of capturing the subject as intended.

7) **AF-assist beam**

The AF-assist beam is a series of flashes. The effective range is approx. 4 meters/13.1 feet at the center AF point and approx. 3.5 meters/11.5 feet at the eight off-center AF points.

Table 005 AF-assist beam with External Speedlites

Speedlite	Automatic Selection	Manual Selection			
		Center	Top/Bottom	Left/Right	Mid-left/Mid-right
580EX II	Yes	Yes	Yes	Yes	Yes
580EX	Yes	Yes	Yes	Yes	Yes
550EX, ST-E2	Yes	Yes	N/A	Yes	Yes
430EX, 420EX	Yes	Yes	Yes	Yes	Yes
380EX, 220EX	Yes*	Yes	N/A	N/A	N/A

* Focus can be achieved only with the center AF point.

1.5 Viewfinder

1) Viewfinder optics for easy viewing

With an optimized pentaprism and larger diameter eyepiece lens, the viewfinder looks bigger with less vignetting. Fig. 013 compares the viewfinder coverage with the EOS 30D's viewfinder. Table 006 compares the specifications.

Table 006 Major Viewfinder Specifications

Item	EOS 40D	EOS 30D
Coverage [Approx. %]	95	
Magnification [Approx.]	0.95	0.9
Viewing angle [°]	26.4	25.1
Eye point [Approx. mm]	22*	20
Dioptric adjustment [dpt]	-3 - +1	

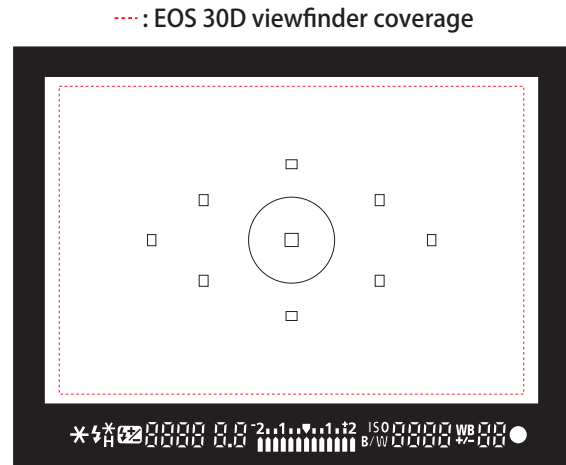

Fig. 013 Viewfinder coverage comparison

*The EOS 40D's 22mm eyepoint is the distance at which the viewfinder image area can be viewed without any vignetting of the viewfinder (on all four edges). Normally, most manufacturers define the eyepoint as the distance where both the viewfinder image area and information display are visible. Therefore, when stating the eyepoint, also add a note indicating that it is the distance where the viewfinder image area can be viewed without any vignetting on all four edges.

2) Superimposed display

The basic configuration of the superimposed display optics is the same as the EOS 30D's.

3) Ef-series focusing screens

The Ef-series focusing screens have been newly developed. Ef-A Standard Precision Matte, Ef-D Precision Matte with Grid, and Ef-S Super Precision Matte are available. All three focusing screens have a fresnel lens area produced by a technique attaining excellent transfer characteristics. This results in a bright focusing screen. (Same production technique used for EOS-1D Mark III's Ec-C IV focusing screen.)

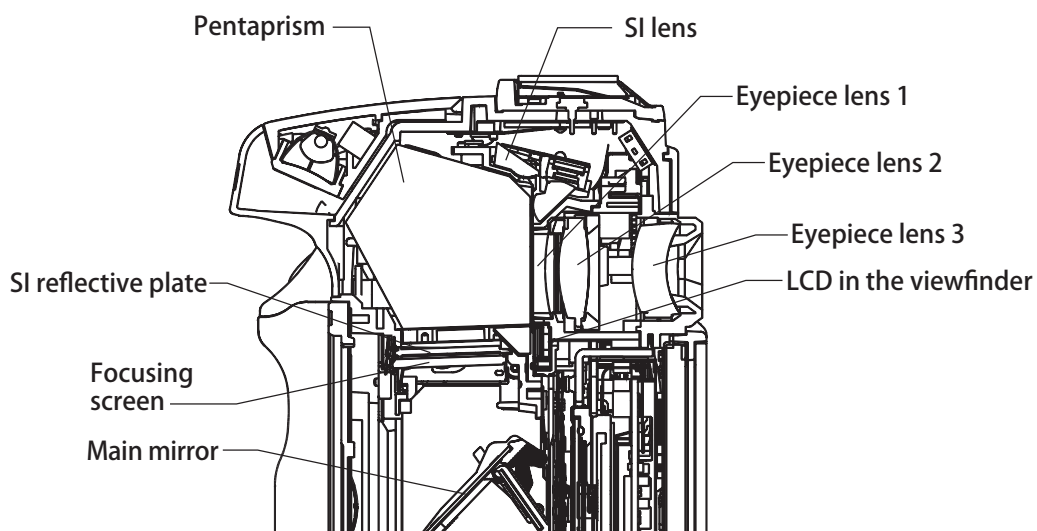

Fig. 014 Viewfinder Optics

1.6 Exposure control

1) Metering

(1) Metering sensor and metering modes

It is the same 35-zone metering sensor (Fig. 015) as in the EOS 30D. The metering modes are evaluative, partial (approx. 9% of viewfinder area), spot (approx. 3.8% of viewfinder area), and center-weighted average metering.

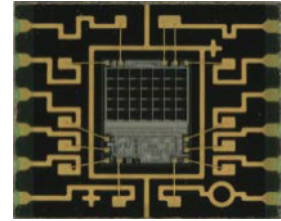

Fig. 015 Metering sensor

(2) Evaluative metering algorithm

Previously, during automatic AF point selection and AF point-centered evaluative metering, there was a tendency for slightly excessive compensation. The compensation is now more loose so that the exposure is more consistent.

(3) E-TTL II autoexposure algorithm

This is the same one as the EOS-1D Mark III's E-TTL II autoexposure algorithm. By optimizing the method of using the lens distance information, the exposure becomes more accurate for highly reflective subjects.

The ambient light is metered in the selected metering mode.

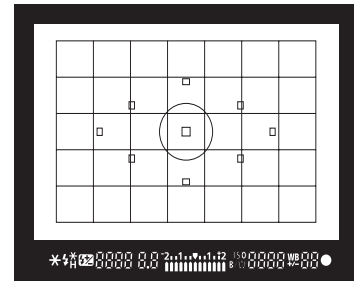

Fig. 016 Metering zones

2) Exposure control

Same as the EOS 30D's exposure control system with eleven AE modes and manual mode.

3) Shutter

While based on the EOS 30D's shutter unit, the shutter is now more reliable with a contactless switch instead of a contact switch for running the 1st and 2nd curtains. Shutter durability is approx. 100,000 cycles, the same as the EOS 30D's shutter.

* With a fully-charged BP-511A, a bulb exposure can be as long as about 2.5 hours.

4) ISO speed

See the "General Information".

1.7 Flash

1) Built-in flash

The flash unit is the same as the EOS 30D's. Guide No. 13.

If the built-in flash is fired rapidly in succession, the flash firing will be stopped to prevent heat damage to the built-in flash cover and fresnel lens (diffuser).

* In the case of the EOS DIGITAL REBEL XTi/400D DIGITAL which has similar specifications, if the built-in flash is fired 20 times successively at 10-sec. or shorter intervals, the firing will be stopped. With the EOS 40D, the flash control is more minute so that the flash stoppage is less likely to occur than with the EOS DIGITAL REBEL XTi/400D DIGITAL.

* Although the degree of heat from the built-in flash is the same as with the EOS 30D, the flash stoppage is provided for product safety.

2) Flash settings with the menu

The built-in flash and external Speedlite settings can be set with the menu screen (Fig. 017 to 019). [Built-in flash func. setting] is a group with [Flash exp. comp], [Shutter sync], and [E-TTL II] (Evaluative/Averaged metering). The latter two were previously Custom Functions.

[External flash func. setting] now includes [Wireless set.] from the EOS-1D Mark III's [Flash function settings]. This is to enable wireless, multi-Speedlite control.

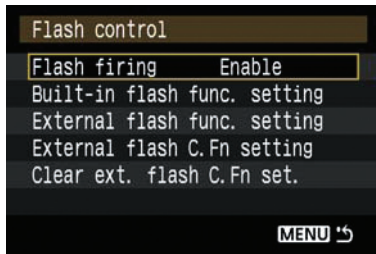

Fig. 017 Flash control

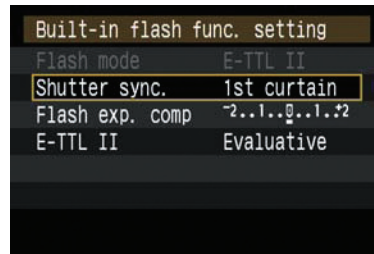

Fig. 018 Built-in flash control

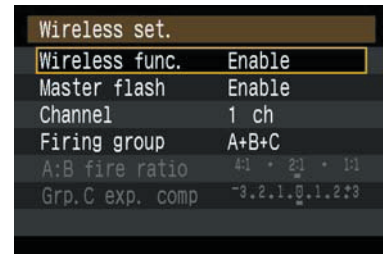

Fig. 019 Wireless flash control

1.8 Drive

1) 6.5 fps high-speed continuous shooting

Maximum continuous shooting speed of approx. 6.5 fps (in both One-Shot AF and AI SERVO AF modes) and a stable viewfinder image are attained by the following technologies:

- Two-motor system. One motor dedicated to driving the mirror, and one motor dedicated to cocking the shutter in high-speed (Fig. 020).
- A stopper is incorporated to prevent the bounding of the main mirror and secondary mirror (Fig. 020). This results in shorter viewfinder blackout and a stable viewfinder image during continuous shooting.
- A 10.10-megapixel CMOS sensor executing 4-channel, high-speed reading.
- DIGIC III for high-speed image processing.
- The buffer memory is a DDR SDRAM for high-speed reading and writing. (EOS 30D had SDRAM.)

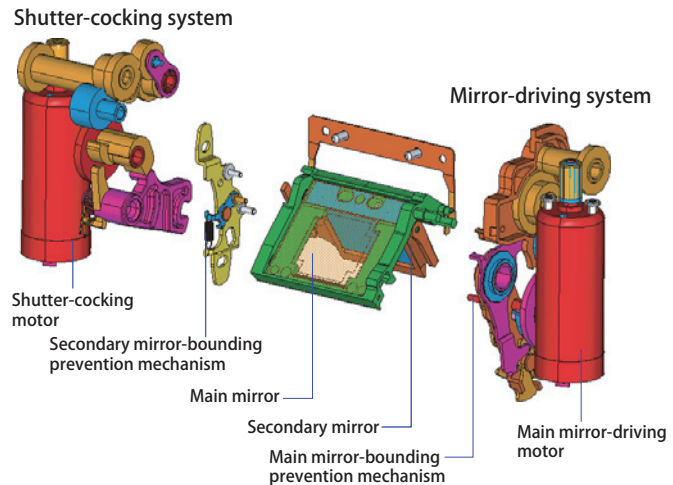

Fig. 020 Two-motor system

2) Maximum burst during continuous shooting

With DIGIC III and DDR SDRAM and a circuit design to take advantage of their maximum performance, the maximum burst at approx. 6.5 fps is approx. 75 shots in JPEG Large/Fine and approx. 17 shots in RAW.

*Based on Canon's testing standards with a 1GB CF card. The maximum burst during continuous shooting varies depending on the shooting conditions (subject, CF card brand, ISO speed, Picture Style, etc.).

1.9 Live View shooting

In addition to the same Live View shooting feature found in EOS-1D Mark III, the camera enables "AF during Live View shooting" (C.Fn III-6) and "Silent shooting." This section explains only the differences with the EOS-1D Mark III's Live View shooting feature.

Live View shooting is only possible with the Creative Zone modes.

1) AF during Live View shooting

With C.Fn III-6 (Fig. 022), the set AF mode and AF point (automatic selection possible) will be applied during AF while you hold down the AF-ON button. Note that during this time, there will be no Live View image displayed since the reflex mirror will be down. (Fig. 023) Since no AF points are displayed on the Live View screen, positioning the magnified display's focusing frame at the center and selecting the center AF point for autofocusing is recommended.

During AF operation, shutter release is not possible. You must first let go of the AF-ON button and wait until the Live View image is displayed, then shoot.

2) Silent shooting

(1) Mode 1 and Mode 2

With the CMOS sensor's electronic 1st-curtain shutter, shooting is possible while the Live View image is displayed and the mechanical 1st curtain is open. The mechanical 1st curtain need not be closed in order to shoot. This eliminates the mechanical 1st curtain's shutter sound at SW-2 ON which occurs with the EOS-1D Mark III during Live View shooting. Silent shooting is thereby possible.

Mode 1 enables continuous shooting (approx. 6 fps for high-speed continuous). Continuous shooting is not possible with Mode 2. However, since the shutter is not cocked up until SW-2 OFF, the shutter sound during the exposure can be limited to only the quieter mechanical 2nd-curtain shutter sound.

(2) Disable

As with the EOS-1D Mark III's Live View shooting, the exposure is controlled with the mechanical shutter's 1st and 2nd curtains. Set to "Disable" when using a TS-E lens shifted up or down or when using an Extension Tube. If you set Mode 1 or Mode 2 when using a TS-E lens, the slit created between the electronic 1st-curtain shutter and mechanical 2nd-curtain shutter (hardly no slit between the mechanical 1st-curtain and 2nd-curtain shutters) will be in the same orientation as the optical axis, resulting in underexposure or overexposure. With an Extension Tube, the exposure will be uneven at the top and bottom of the image. (Fig. 025)

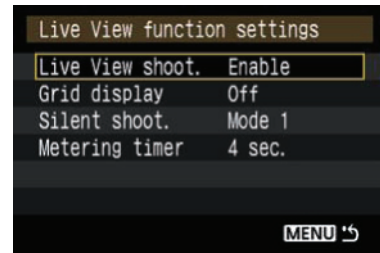

Fig. 021 Live View shooting menu

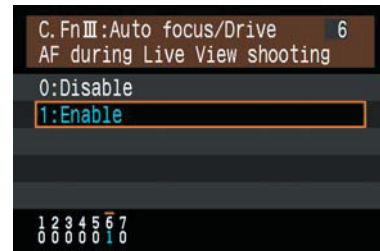

Fig. 022 C.Fn-III-6

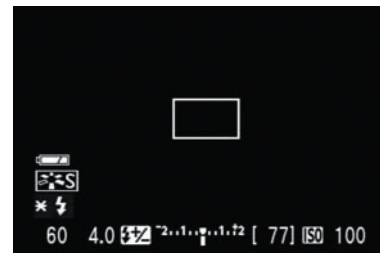

Fig. 023 AF during Live View shooting

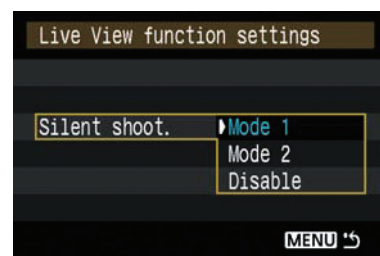
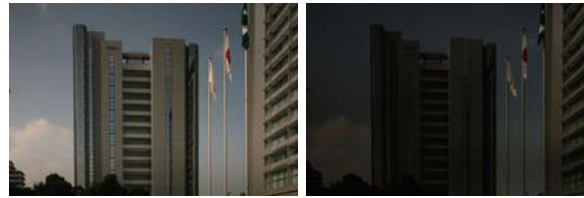

Fig. 024 Silent shooting

However, such over/under or uneven exposure only occurs at high shutter speeds when using a TS-E lens or Extension Tube. If the shutter is slower than 1/2000 sec., there is almost no effect even if Mode 1 or 2 is used.



No shift movement 11mm shift up

Fig. 025 TS-E Lens + 1/8000 sec.

(3) Flash shooting

The shooting sequence will be the same as the EOS-1D Mark III's Live View flash shooting in either silent shooting Mode 1 or 2.

3) Live View metering timer

Geared mainly for still-life subjects, Live View shooting enables the metering timer such as AE lock to be changed. The metering timer can be changed to one of six settings from 4 sec. to 30 min. (Fig. 026)

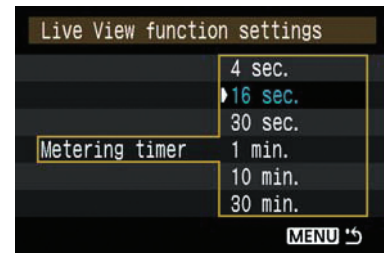

Fig. 026 Live View metering timer

4) Aspect ratio information

Not to be included in the official specifications.

5) Number of possible shots

During Live View shooting, approx. 170 shots at 23° C/73° F and approx. 130 shots at 0° C/32° F (with 50% flash used).

* Without using flash, approx. 180 shots at 23° C/73° F and approx. 140 shots at 0° C/32° F.

* With a fully-charged BP-511A and based on CIPA testing standards.

6) Screen display

An icon to indicate that exposure simulation has been enabled has been added. (Fig. 027)

Even if [Auto power off : Off] is set, Live View shooting will be automatically terminated after 30 min. of non-operation to save power. (The camera's power does not turn off.)

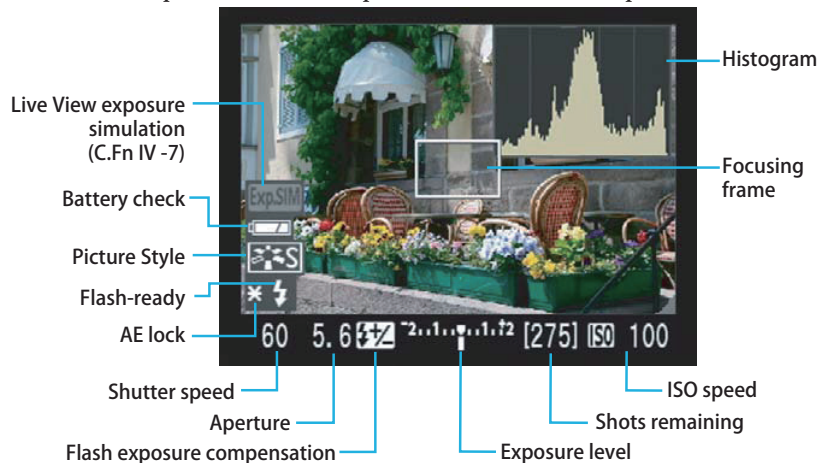

Fig. 027 Live View information display

1.10 Basic operation concept and LCD monitor display

As much as possible, the operation method, screen design, and specifications were kept the same as with the EOS-1D Mark III.

1) Basic operation concept

While based on the EOS 30D's basic operation concept, the camera has a few improvements to make it easier to use. The shooting buttons above the LCD panel have been reassigned, an AF Start button (AF-ON) is provided as with the EOS-1D Mark III, and the Picture Style selection button is new.

2) LCD monitor same as EOS-1D Mark III's

The 3-inch LCD monitor is the same as the EOS-1D Mark III's with approx. 230,000 pixels, wide viewing angle, bright screen, and low power consumption. The color reproduction range and gamma are also the same as the EOS-1D Mark III's LCD monitor. The color reproduction is thereby improved and natural-looking images are displayed.

3) Menu features

The screen design (Fig. 028) and basic menu operations are the same as the EOS-1D Mark III. (The menu options are different.) With the EOS-1D Mark III, menu operations with the Multi-controller were limited to the top menu hierarchy. With the EOS 40D, you can now use the Multi-controller for all menu operations except "Erase images and Format."

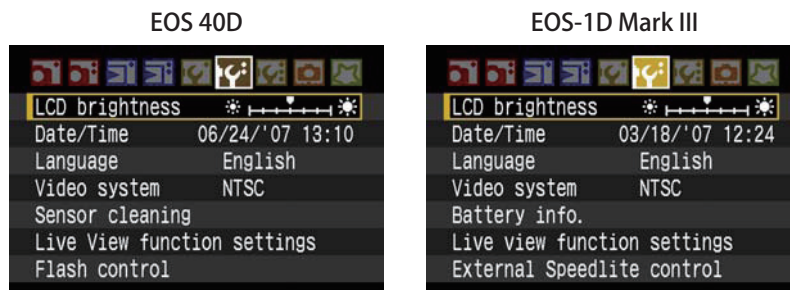

Fig. 028 EOS 40D and EOS-1D Mark III menu comparison

4) Image playback

During playback, pressing the INFO. button will display the information in the sequence shown in Fig. 029.

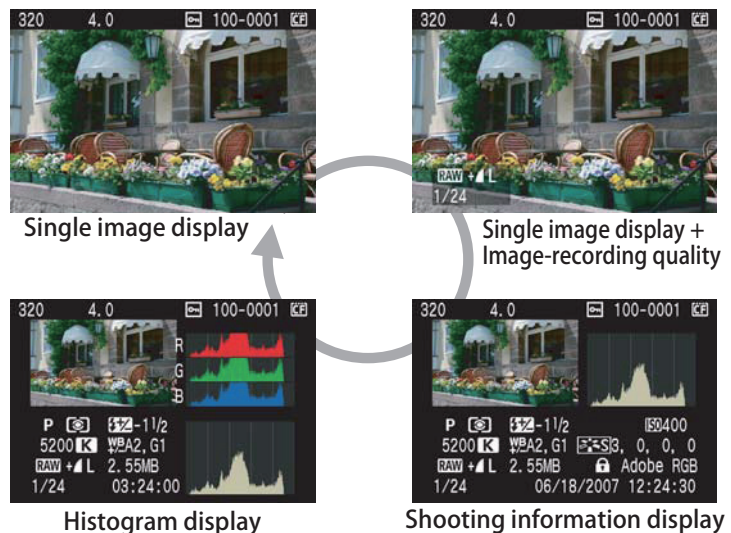

Fig. 029 Information display sequence

1.11 Internal construction

1) External and internal construction

Like the EOS 30D, the main exterior covers (top, front, and rear) are made of magnesium alloy for light weight and high strength (Fig. 030). Also, since the grip portion is integrated with the front cover, excellent body rigidity is attained.

The body's basic construction is the same as the EOS 30D's. It employs a stainless steel chassis and a mirror box made of high-strength engineering plastic.

As with the EOS 30D, the exterior has a high-quality, black satin finish with a non-slip texture. The EOS 40D also has sealing material lining the CF card slot cover and battery compartment cover (not found in the EOS 30D) to improve dust- and water-resistance.

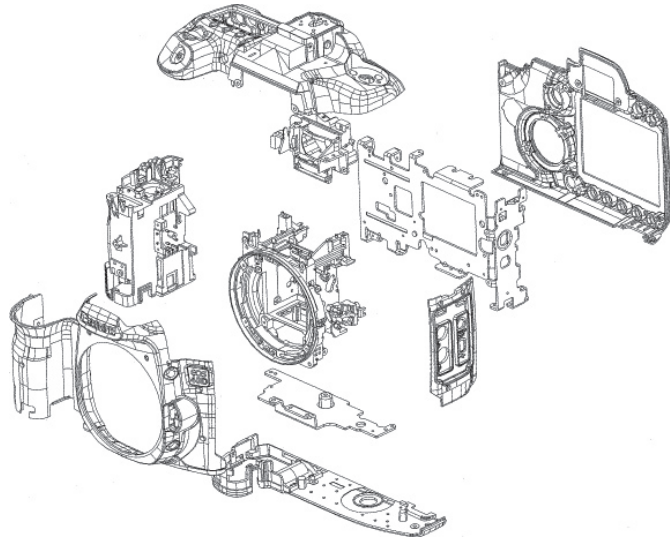

Fig. 030 Exterior covers and internal construction

2) Internal components and configuration

The configuration of the major components is basically the same as the EOS 30D with the exception of the following units which have been added or changed:

- Self Cleaning Sensor Unit
- LCD monitor made bigger from 2.5 in. to 3.0 in.
- Two driving motors to attain approx. 6.5 fps continuous shooting speed
- Extension system terminal

Table 007 shows the parts count, and Fig. 032 on shows a cross section at the center.

Table 007 Parts count

Item	EOS 40D	EOS 30D
Optics	20	20
Mechanical parts	336	338
Electrical parts	1138	1053
Circuit boards	24	27
Lead wires	14	15
Total (Official)	1532	1453

* The shutter unit is counted as 1 part.

* The official parts count excludes the screws and washers (166 in EOS 40D, 164 in EOS 30D).

* For the electrical parts count, previously the DC/DC converter and flash unit were counted as one part. In the case of the EOS 40D, since the unit configuration is different, the parts comprising the unit are counted.

3) Shutter-release mechanism

The shutter-release mechanism and shutter-release stroke and pressure are the same as the EOS 30D's (Table 008). The shutter-release time lag from SW-1 ON is about 0.059 sec. (Aperture stopped down by no more than 3.5 stops.) And the viewfinder blackout time is about 0.1 sec.

Table 008 Shutter-release stroke and pressure

State	Stroke	Pressure
Shutter button protrusion	1.3mm	—
Standby position to SW-1 ON	0.55mm	140g
SW-1 ON to SW-2 ON	0.3mm	330g

4) Electrical components

The major circuit boards are as follows: 1. Main board (digital control circuit and camera control circuit), 2. Bottom board (flash circuit and actuator drive circuit), and 3. Power circuit board. These boards efficiently integrate various control circuits (Fig. 031). There are also 23 flexible boards outfitted with the sensor, switches, etc.

(1) Main board

Highly integrated, 10-layer board containing the digital control circuit and camera control circuit. It includes the following: Image signal-processing circuit consisting of ICs such as the A/D IC which converts the CMOS sensor output to a digital signal and the TG (Timing Generator) which generates the CMOS sensor's drive pulse, the digital image-processing circuit which has DIGIC III, the memory circuit which has DDR-SDRAM as the buffer memory, and the TFT liquid-crystal control circuit. The USB terminal, video OUT terminal, and extension system terminal are also on this board.

This board also has the following: Main CPU which controls various sensors and mechanical parts for camera operations, viewfinder display drive control circuit, and EEPROM memory to store saved data such as adjustment data (AE, AF, etc.)

(2) Bottom board

Highly integrated, 4-layer board containing the flash circuit and actuator drive circuit. It includes the flash circuit which controls the built-in flash's recycling and firing and the external Speedlite control circuit.

It also includes the following: Two-motor control circuit which drives the mirror and shutter-driving actuator, lens power supply control circuit, Self Cleaning Sensor Unit's actuator drive control circuit.

(3) Power circuit board

This has the power circuit which generates and supplies the voltage required by the camera's circuits.

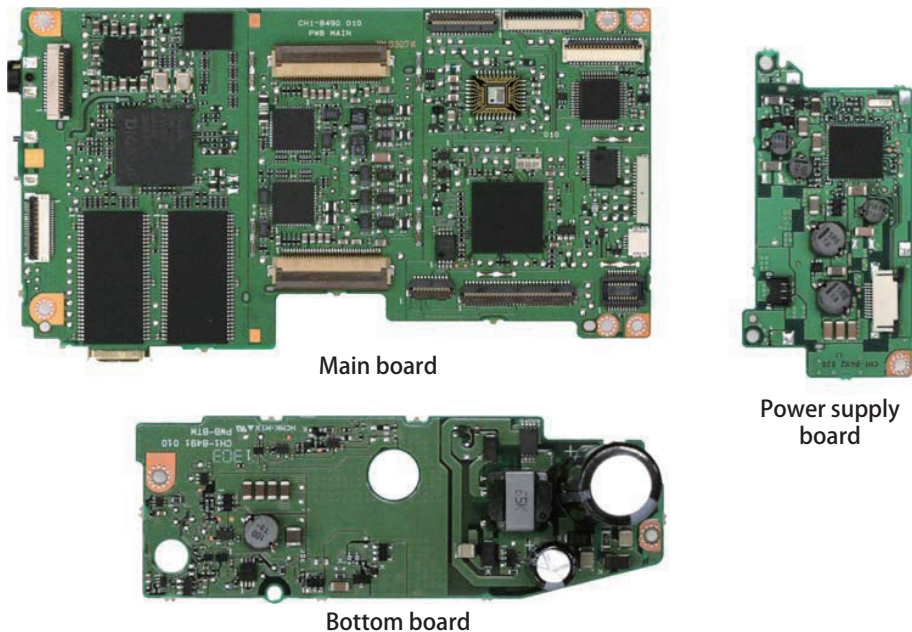

Fig. 031 Major hard boards

5) Compliance to RoHS directive (Restriction of the Use of Certain Hazardous Substances in Electrical and Electronic Equipment)

The RoHS directive restricts the use of six toxic substances: Lead, mercury, cadmium, hexavalent chromium, polybrominated biphenyl, and polybrominated diphenyl ether. It applies to products sold in the EU (effective from July 1, 2006). All of the EOS 40D's parts conform to this directive.

*RoHS directive: Restriction of the use of certain Hazardous Substances in electrical and electronic equipment.

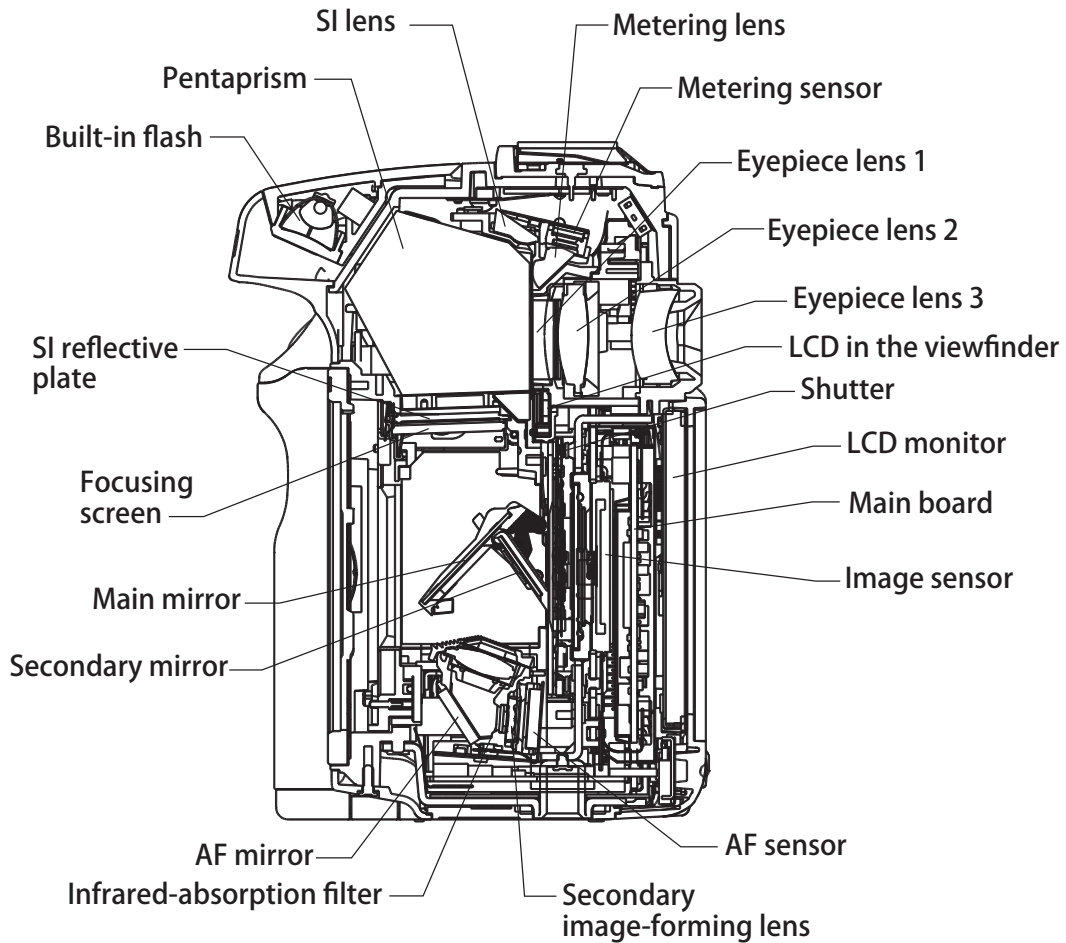

Fig. 032 Cross section at center

Repair Information

Trademarks

The product names and company names described in this Service Manual are the registered trademarks of the individual companies.

Copyright

Canon Inc. retains the copyright to this Service Manual. Reproduction, publication (including on the World Wide Web), alteration, translation into another language, or other use of the data in whole or part, contained on this Service Manual without the written consent of Canon Inc. is prohibited.

CONTENTS

	Page
Repair Information	
1. REPAIR PREPARATIONS	1
1.1 Initial Check List	1
1.2 Current Consumption	3
1.3 Residual Battery Display	3
1.4 Serial No. Location	4
1.5 Repair Tools and Materials	4
1.6 Tool Battery Fabrication	5
1.7 Load Resistor Fabrication	6
1.8 Operational Checks	6
2. DISASSEMBLY AND REASSEMBLY	7
2.1 External Rubber, Battery Cover Ass'y, and Interface Cover Removal	7
2.2 Front Cover Ass'y and Back Cover Ass'y Removal	9
2.3 Top Cover Ass'y and Bottom Cover Ass'y Removal	13
2.4 Base Plate Ass'y, Bottom PCB Ass'y, and AF FPC Ass'y Removal	17
2.5 Main PCB Ass'y and CMOS Sensor Ass'y Removal	22
2.6 DC/DC PCB Ass'y and Mirror Box Ass'y Removal	26
2.7 Main Base Plate Disassembly	29
2.8 Mirror Box Ass'y Disassembly	32
2.9 Back Cover Ass'y Disassembly	36
2.10 Top Cover Ass'y Disassembly	38

1. REPAIR PREPARATIONS

1.1 Initial Check List

Assembly and Disassembly:

1) Antistatic measure

Be sure to use an antistatic wrist strap when assembling or disassembling.

2) Measuring environment

Before using major measuring tools (Light Source, AF Chart Stand, or Standard Tool Lens), be sure to make an inspection and keep a record of the result routinely.

3) Discharge positions

After removing the base plate ass'y, be sure to discharge from the main capacitor.

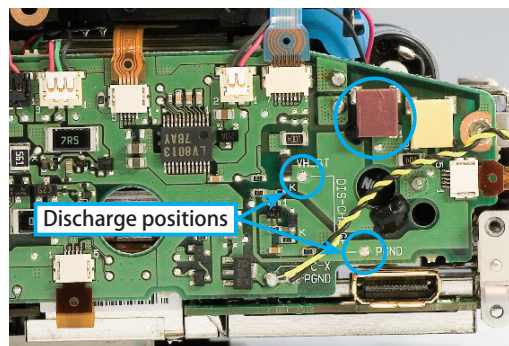

Fig. 001

When removing the lead wire (red connector) prior to discharge, be sure to use plastic tweezers because of high voltage supplied.

4) Charge prevention

There is no pad set for inhibiting charge, but it is possible to inhibit charge with the adjustment software.

5) Parts affecting product reliability

- When reassembling, make sure all parts are in the correct positions and tape is applied properly.
- When reassembling, make sure all tape, lead wires and flexes are in the original positions.

6) Cleaning dust from the imaging surface (LPF surface)

Make sure that DIA (Digital Image Analyzer) displays "PASS" in the dust check when returning repaired products to users.

(1) DIA Software Guide:

The DIA software detects dust elements on designated image and counts them. Based on the location, size and number of dust specs, DIA passes or fails the unit.

1. Take a picture.

Shooting condition:

- EF 50mm f/1.8 II lens
- Av Priority AE (F22)
- ISO 100, AWB
- JPEG Large/Fine
- Light Source (EF-1/EF-8000/Light Box)

2. Download an image to the computer.

3. Open the JPEG file on DIA.

4. Results

In case of "FAIL", click the number and check where the dust is located if necessary. Then clean the dust.

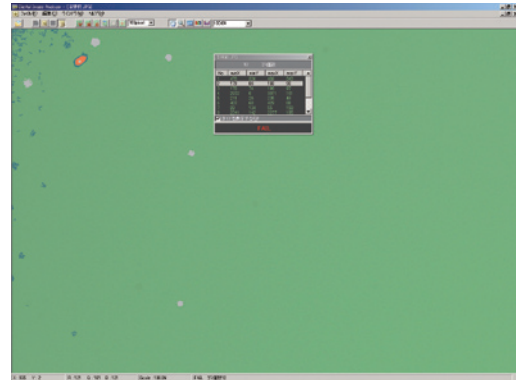

Fig. 002

No	minX	minY	maxX	maxY
1	3007	0	3071	74

Fig. 003

No	minX	minY	maxX	maxY
1	470	326	489	343
2	179	86	188	90
3	150	74	198	97
4	2972	0	3071	161
5	211	26	235	49
6	407	68	429	98
7	28	134	55	158
8	2241	142	2277	195

Fig. 004

(2) Cleaning the imaging surface (LPF surface)

Clean the indicated position in DIA using the dust loupe (CY9-1132).

If the number of specks of dust is low, use a cotton swab to clean the locations where there is dust.

If you want to clean the entire surface, set the sensor cleaning to manual, and clean the sensor in the horizontal directions. The remaining dust on the side edges can be cleaned in the vertical directions.

Also, make sure that the mask around the sensor will not be damaged while cleaning.

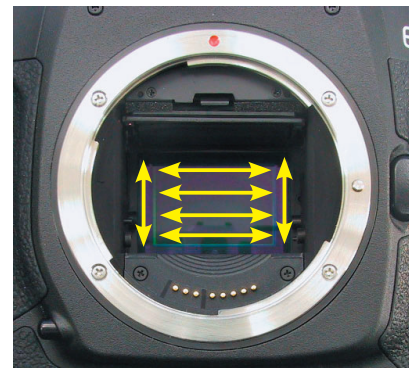

Fig. 005

1.2 Current Consumption

Current Consumption Standards

Lens: EF 50mm f/1.8 II

Power source: Constant voltage 8.0 V, 0.40Ω. (No CF card installed)

Ambient conditions: Room temperature, normal humidity (below 60%)

Camera Status	Standard	Actual Measurement
Main SW off	100μA or lower	45.52μA
SW1-ON	350mA or lower	116.46mA
Self Timer operation	550mA or lower	155.33mA
Red-eye Lamp operation	600mA or lower	179.6mA
AF Search operation	500mA or lower	274.4mA
Standby	100mA or lower	39.8mA
Self-Cleaning Function ON	650mA or lower	420.4mA

*The "Actual Measurement" data was based on rough measurement. Therefore, be sure to refer to average data of multiple cameras at each repair site.

*Standby means the condition where the camera is inactive, but the Main SW is on.

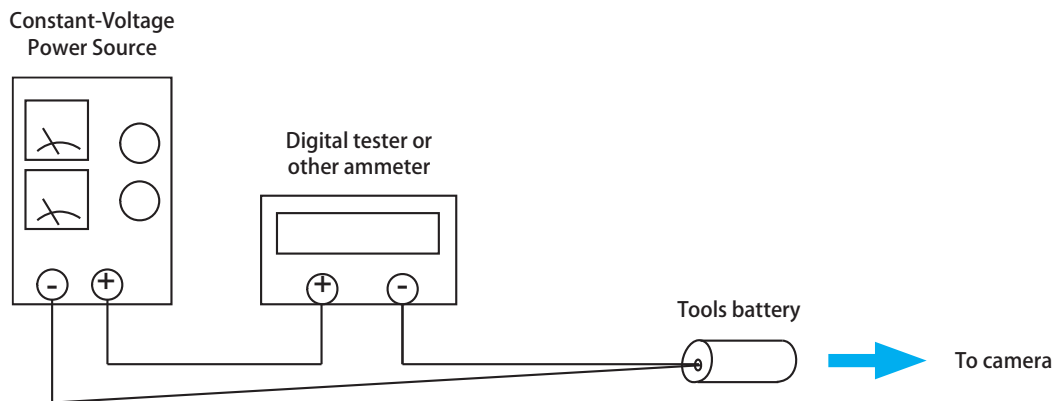

Fig. 006

1.3 Residual Battery Display

Tool: Use the tool battery and resistance part.

Power: Set the power supply to 8.0V.

- (1) Insert the tool battery into the camera.
- (2) Turn on the main SW.
- (3) Raise supply voltage gradually and release the camera within each voltage range to check if the display switches from one to another.

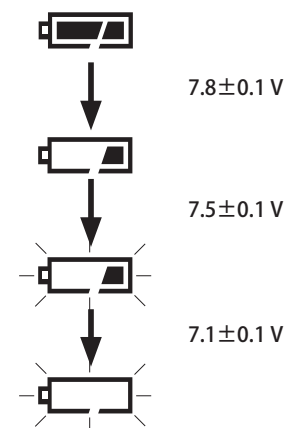

Fig. 007

1.4 Serial No. Location

This number is used in various information such as service information. In particular, when a part is replaced with a service part, the serial number is not reflected. Therefore, be sure to copy the forth and fifth digit of the serial number on the surface of main PCB Ass'y shield plate inside the camera.



Fig. 008

1.5 Repair Tools and Materials

The following tools and materials are required for camera disassembly and reassembly.

1) Tools

New	Name	Part No.
	Lead-free solder	CY9-4045-000
	Wrist Strap (Earth)	CY9-6158-000
	Conductive Sheet	CY9-1061-000
	Liquid Dispenser	CY9-4017-000
	Tweezers (AA type/GG type)	CY9-4018-001/002
	Blower	CY9-4020-000
	Lens Tissue (K-1 thick/K-3 thin)	CY9-4023-001/003
	Screw Driver Handle	CY9-7014-001
	Hi-Torque Screwdriver	CY9-7015-000
	CROSS-RECESS BIT TB35-5 (Φ3mm, l=50mm)	CY9-7014-002
	CROSS-RECESS BIT TB35-6 (Φ2.5mm, l=115mm)	CY9-7014-003
	CROSS-RECESS BIT TB35-7 (Φ2.5mm, l=50mm)	CY9-7014-004
	CROSS-RECESS BIT TB35-8 (Φ2mm, l=50mm)	CY9-7014-005
	ELECTRIC SCREW DRIVER	CY9-7061-000
	POWER SUPPLY (100,120,220,240)	CY9-7062-000 (xxx)
	LOUPE, DUST CHECKING	CY9-1132-000

2) Charts and Locally-Made Tool

New	Name	Part No.	Purpose/Subject
	Tool battery	Locally-made	Inhibit voltage
	Load Resistor	Locally-made	Inhibit voltage

*For details, see "Tool Battery Fabrication".

3) Other Products for Testing

New	Name	Part No.	Purpose/Subject
	EF 50mm f/1.8 II production lens		Camera operations, adjustments, checking
	Speedlite (430EX, 580EX, or other E-TTL model)		Flash metering adjustment

4) Expendables List

New	Name	Part No.	Purpose/Subject
	Bond Super X 8008B	CY9-8118-000	Fiber and shoe spring in place
	Bond 1401C	CY9-8011-000	Screw lock
	Bond 1663G	CY9-8129-000	PC terminal and SI in place and screen retainer cover and screen retainer plate.
	Grease NFH-743C	CY9-8125-000	Lock pin and Mirror Box Ass'y lube
	Grease IF-10	CY9-8088-000	Mount spring lube
	Instant adhesive 201	CY9-8007-000	Securing SPC and SI in place
	Tape (No.315)	CY9-4031-000	Lead Wire in place
	permanent marker (Matte-black)	—	OLC Window
	Double-Sided Tape	CY9-4039-000	Shutter Ass'y
	Double-Sided Tape	CY9-4034-000	Base plate Ass'y

1.6 Tool Battery Fabrication

1) Preparation

- (1)CY9-1101-000 Tool Battery Probe Kit 2 ea.
- (2)DY9-1374-000 Charge Adjustment Tool 1 ea.

2) Fabrication

- (1)Prepare the items listed above.
- (2)Remove the lead wires from DY9-1374, solder the lead wires (CY9-1101) to the battery contacts, and put the wires through the hole of the battery cover.
- (3)Solder the leads to the banana plugs.
- (4)Tape the two halves of the battery case together.



DY9-1374-000

As shown in the right figure, replace the lead wires first and then put the battery cover on.

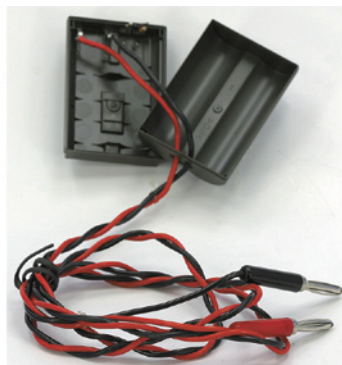

Finished

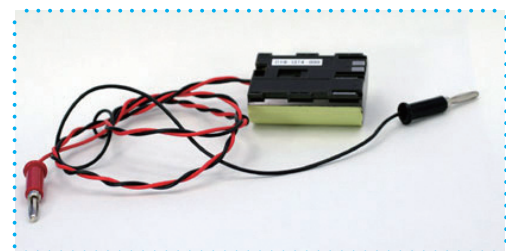

Fig. 009

1.7 Load Resistor Fabrication

1) Preparation

- | | |
|--|---|
| (1)35mm film case (Commercially available) | 1 ea. |
| (2)Banana Clip (Commercially available) | 1 ea. |
| (3)Joint Plug (Commercially available) | 1 ea. |
| (4)0.5Ω, 5W Cement Resistor | 2 ea. |
| | (p/o CY9-1101-000 Tool Battery Probe Kit) |

2) Fabrication

- (1)Prepare the above items.
- (2)Cut holes in the top and bottom of the film case for the plugs. Install the plugs and secure with the washers.
- (3)Connect the two 0.5Ω resistors in parallel, place in the case and solder to the plugs (A-A', B-B').
- (4)Solder the banana plug.

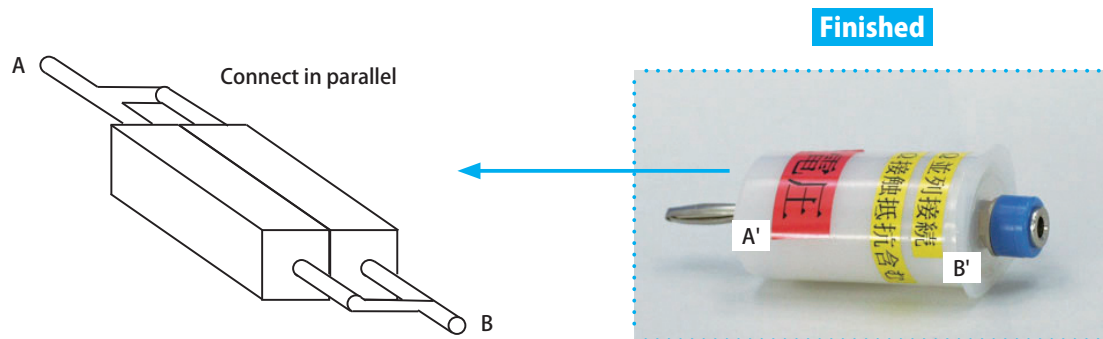

Fig. 010

1.8 Operational Checks

Shutter release without the back cover installed is possible with this model.

2. DISASSEMBLY AND REASSEMBLY

2.1 External Rubber, Battery Cover Ass'y, and Interface Cover Removal

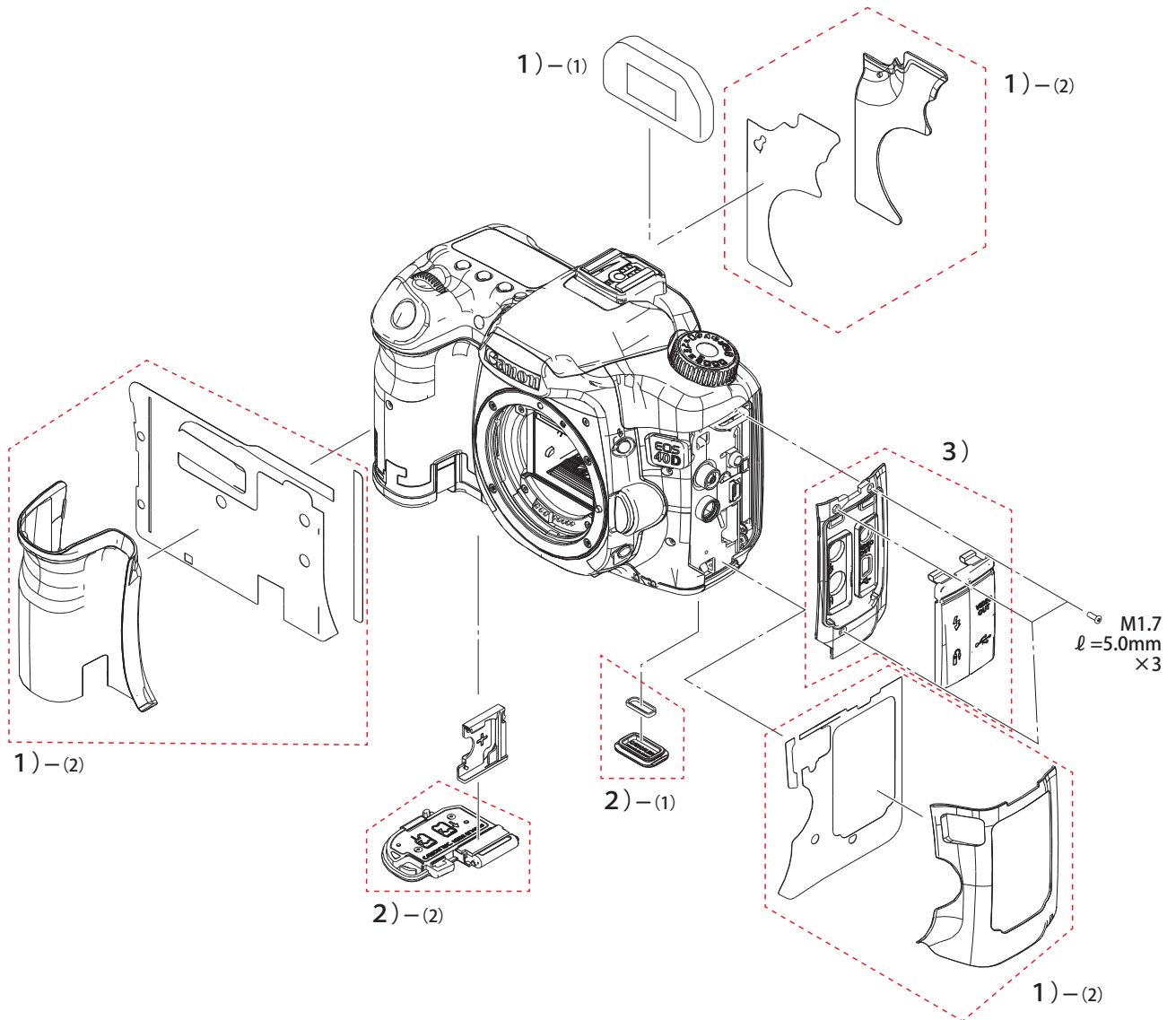

Fig. 011 External Rubber, Battery Cover Ass'y, and Interface Cover Removal

<Disassembly>

1) External Rubber Removal

- (1) Remove the eyecup.
- (2) Remove the back holding cover, grip holding cover, and front cover separately.



Fig. 012 Position of Back Holding Cover



Fig. 013 Position of Grip Holding Cover and Front Cover

2) Battery Cover Ass'y Removal

- (1) Remove the extension terminal cap, and remove the O ring.
- (2) Pull the battery cover ass'y off in the direction shown by the arrow in the figure to remove it.



Fig. 014 Position of Extension Terminal Cap



Fig. 015 Battery Cover Ass'y Removal

3) Interface Cover Removal

- (1) Remove three screws, and remove the interface cover.



Fig. 016 Position of Interface Cover Screws

- (2) Being careful not to damage the rubber, remove the interface cap. (as necessary)

2.2 Front Cover Ass'y and Back Cover Ass'y Removal

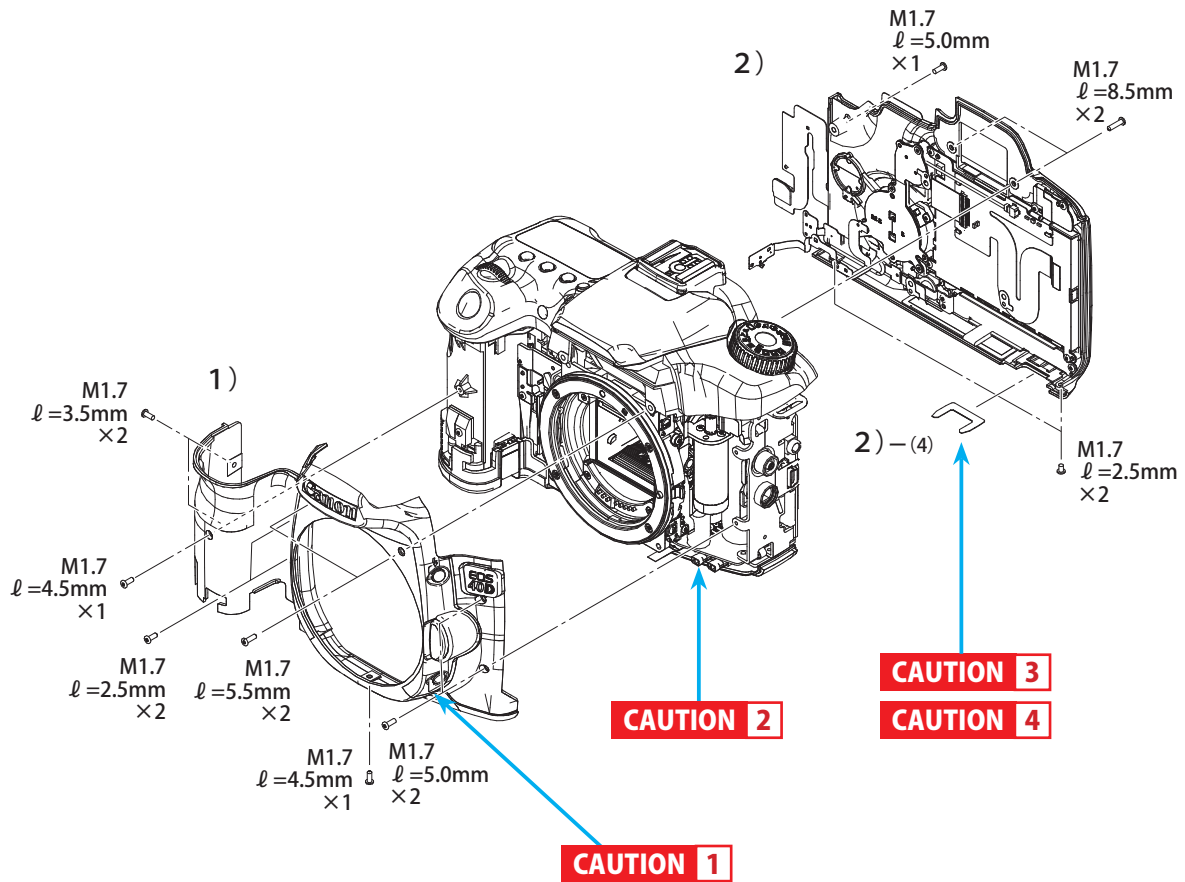

Fig. 017 Front Cover Ass'y and Back Cover Ass'y Removal

<Disassembly>

1) Front Cover Ass'y Removal

- (1) Remove one screw from the bottom of the mount and seven screws from the front.
- (2) Remove 2 screws from the side, and remove the front cover ass'y.

CAUTION 1 Be careful not to lose the depth-of field preview button as it comes off.

CAUTION 2 The lead wire (red connector) has high voltage supplied. Be careful.

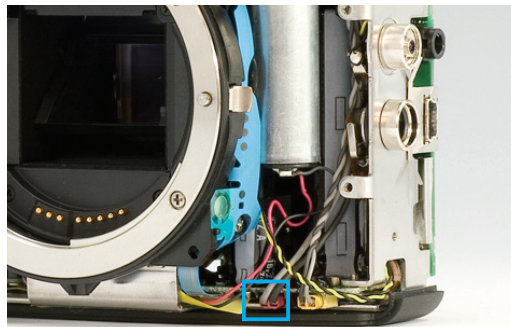

Fig. 018 The Position of the Top Cover Ass'y Lead Wire



Fig. 019 Position of Front Cover Ass'y Screws (Front)



Fig. 020 Position of Front Cover Ass'y Screws (Side)

2) Back Cover Ass'y Removal

- (1) Remove 2 screws from the bottom, one screw from the right side of the back, and 2 screws from the eyepiece.
- (2) Lift the back cover slightly, and remove the 2 FPCs and remove the back cover ass'y.

CAUTION 3 Be careful not to lose the extension terminal sheet as it comes off.



Fig. 021 Position of the Back Cover Ass'y Screws

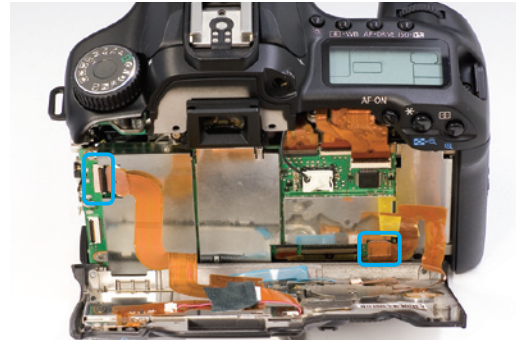

Fig. 022 Position of the Back Cover Ass'y FPCs

- (3) Remove the extension terminal sheet.

<Reassembly Cautions>

1) Front Cover Ass'y Reassembly

- (1) When replacing the service parts, cut off the sheet at the line in the figure so that the click feeling will improve.

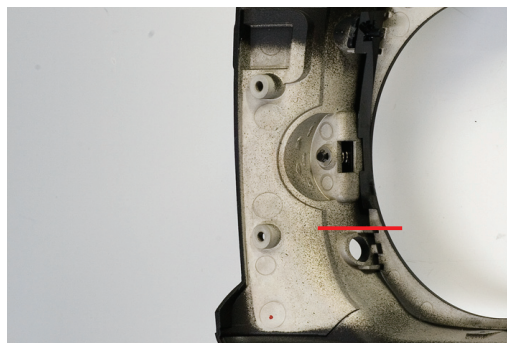

Fig. 023 Front Cover Ass'y Reassembly

2) Extension Terminal Sheet Installation

- (1) When installing the extension terminal sheet, make sure that the O ring has been removed. Install the extension terminal sheet firmly into the bottom cover so as not to create a gap between the extension terminal sheet and the connector.

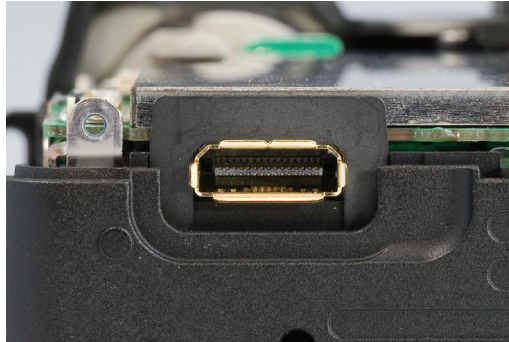

Fig. 024 Extension Terminal Sheet Installation

- (2) When assembling the back cover, make sure that the fitting of the back cover does not ride up on the extension terminal sheet.

CAUTION 4 Note that if the extension terminal sheet is not correctly installed, the dust/water resistant effect will decrease.

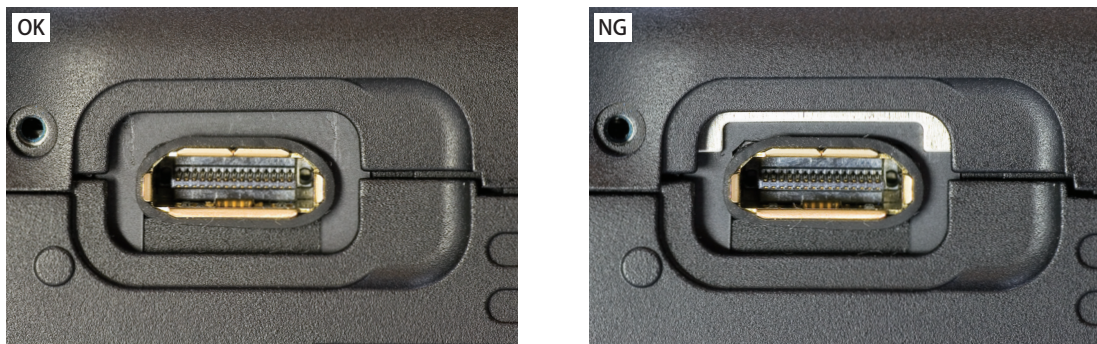

Fig. 025 Back Cover Reassembly

2.3 Top Cover Ass'y and Bottom Cover Ass'y Removal

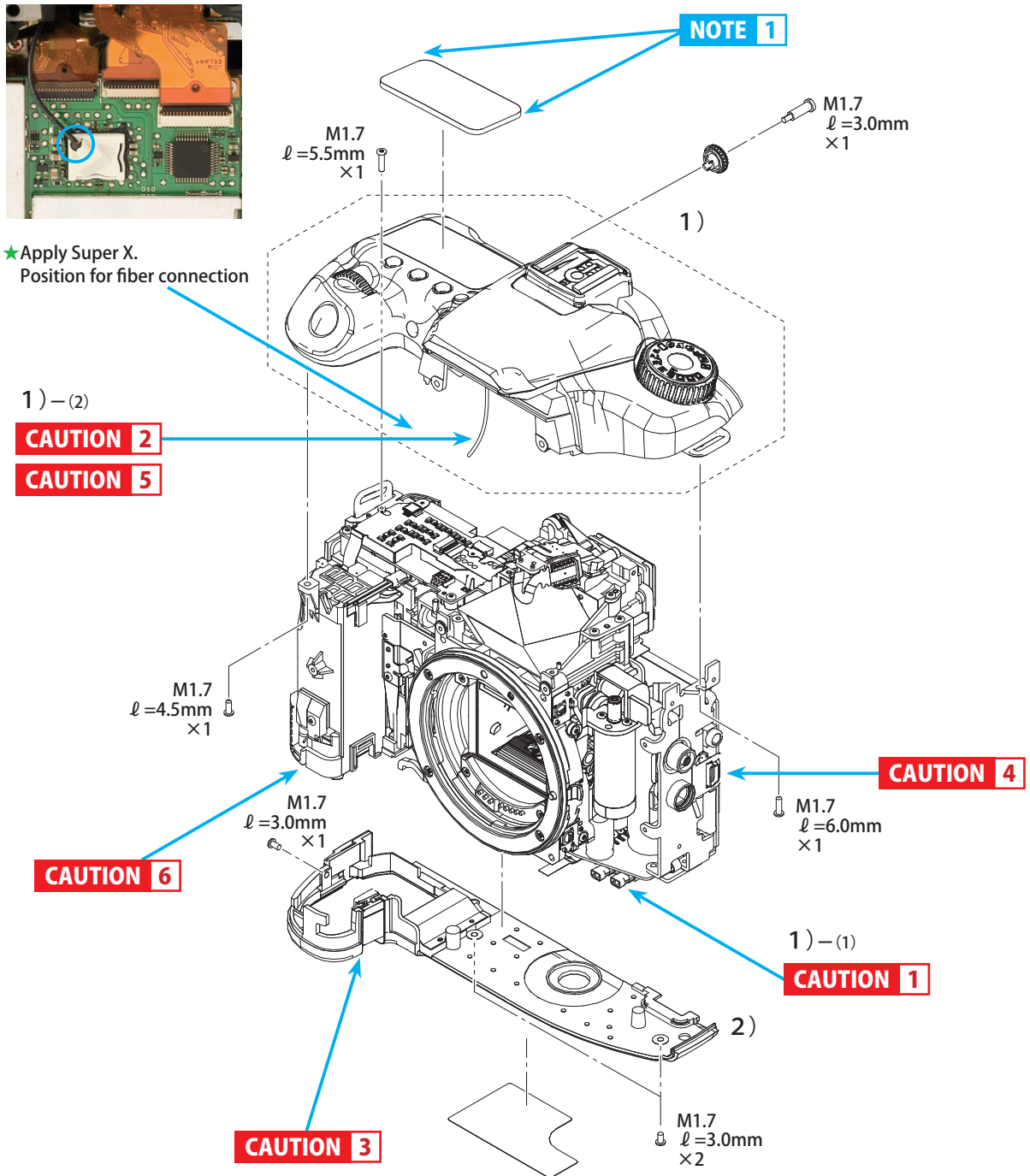

Fig. 026 Top Cover Ass'y and Bottom Cover Ass'y Removal

<Disassembly>

1) Top Cover Ass'y Removal

(1) Disconnect the 2 lead wires that have connectors (yellow connector, red connector) attached.

CAUTION 1 The lead wire (red connector) has a high voltage, so remove it using plastic tweezers.

(2) Remove one FPC, remove the bond, and disconnect the fiber.

CAUTION 2 Be careful not to damage the fiber when disconnecting it.

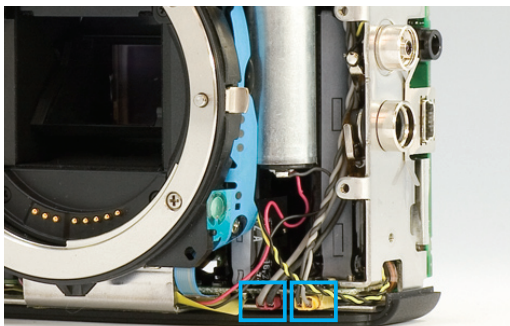

Fig. 027 The Position of the Top Cover Ass'y Lead Wire

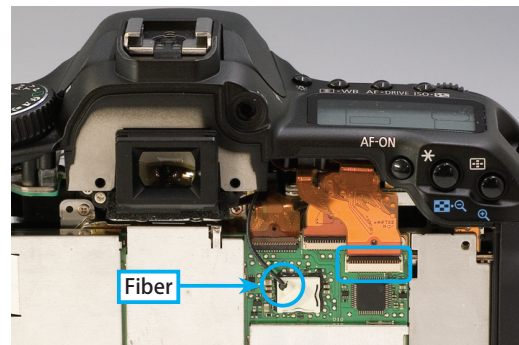

Fig. 028 The Position of the Top Cover Ass'y FPC and Fiber

(3) Remove two screws and diopter correction dial from the top of the top cover and two screws from the bottom, and remove the top cover ass'y.



Fig. 029 The Position of the Top Cover Ass'y Screw (Top)

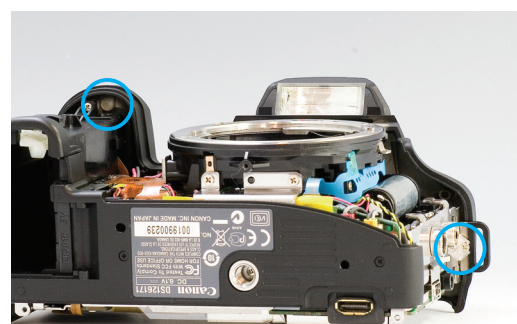

Fig. 030 The Position of the Top Cover Ass'y Screws (Bottom)

(4) Remove the display window. (as necessary)

2) Bottom Cover Ass'y Removal

(1) Remove two screws from the bottom and one screw from the side, and remove the bottom cover ass'y.

CAUTION 3 The battery cable door comes off together with the bottom cover ass'y, so be careful not to lose it.

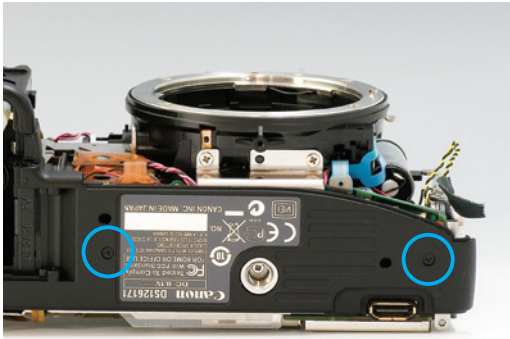

Fig. 031 The Position of the Bottom Cover Ass'y Screws (Bottom)



Fig. 032 The Position of the Bottom Cover Ass'y Screw (Side)

(2) Remove the body number label with tweezers. (as necessary)

<Reassembly Cautions>

NOTE 1

1) Display Window Reassembly

(1)When replacing the service parts, paint the point marked in the figure with a black permanent marker (Matte-black).



Fig. 033 Display Window Reassembly

2) Top Cover Ass'y Reassembly

CAUTION 4 Make sure that the lead wire to the bottom PCB ass'y does not touch the motor drive section when routing the lead wire.

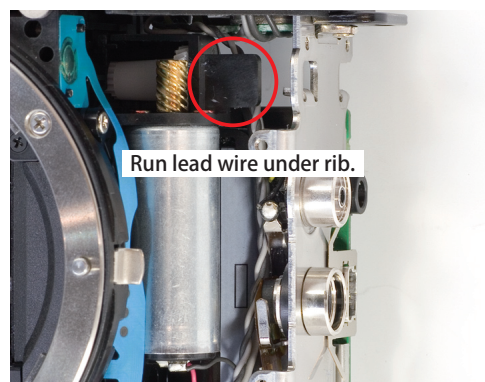

Fig. 034 Top Cover Ass'y Reassembly

CAUTION 5 Insert the fiber until it reaches the end.

3) Bottom Cover Ass'y Reassembly

(1)Install the bottom cover ass'y over the battery cover FPC ass'y from the battery component side.

CAUTION 6 Be careful not to damage the battery cover FPC ass'y.

2.4 Base Plate Ass'y, Bottom PCB Ass'y, and AF FPC Ass'y Removal

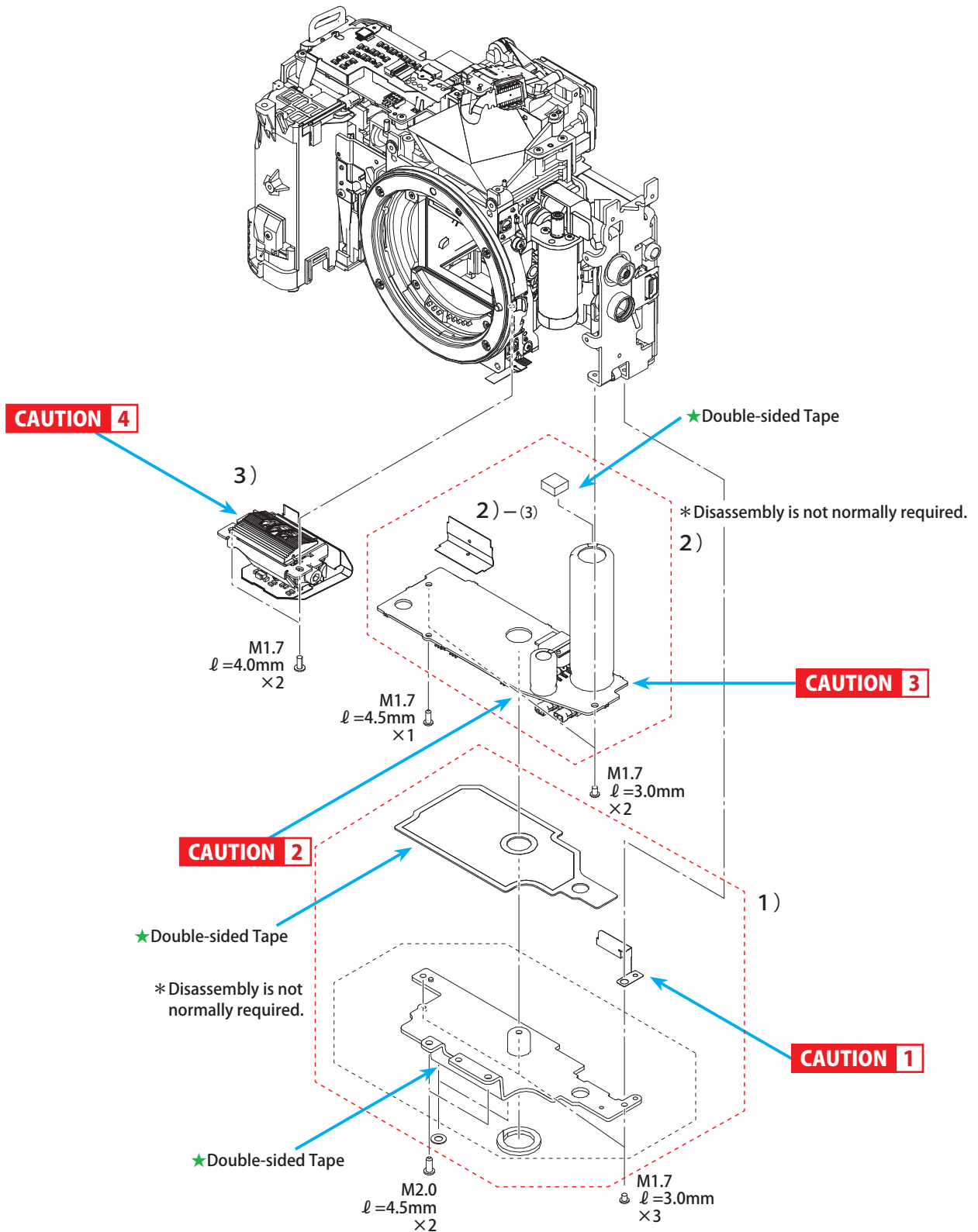

Fig. 035 Base Plate Ass'y, Bottom PCB Ass'y, and AF FPC Ass'y Removal

<Disassembly>

1) Base Plate Ass'y Removal

(1) Remove 5 screws from the bottom, and remove the base plate assembly.

CAUTION 1 The ground plate comes off along with the base plate ass'y, so be careful not to lose it.

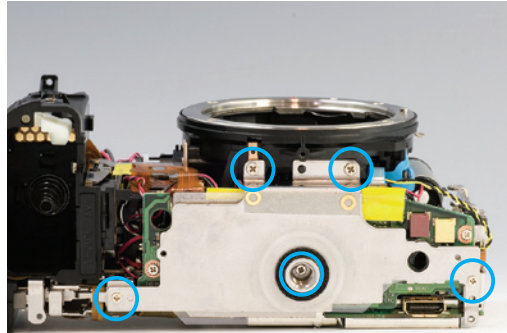

Fig. 036 The Position of the Base Plate Ass'y Screws

2) Bottom PCB Ass'y Removal

(1) Discharge at the "DIS-CHARGE" mark as shown in the figure.

CAUTION 2 Be sure to discharge the main capacitor after removing the base plate ass'y.

(2) Unsolder the yellow and black lead wires.

(3) Remove the BOTTOM-MAIN FPC.

(4) Remove five FPCs.

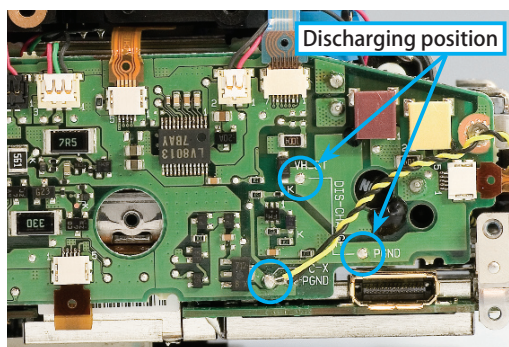

Fig. 037 Discharging Position for Bottom PCB Ass'y

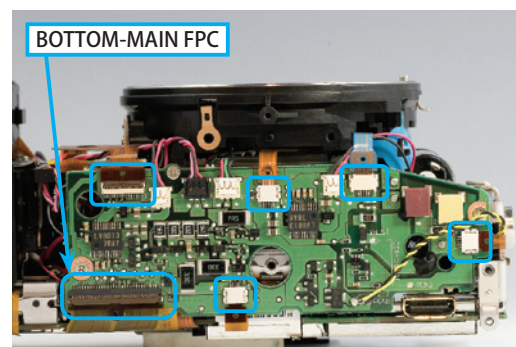

Fig. 038 Position of Bottom PCB Ass'y FPCs

- (5) Disconnect four lead wires.
- (6) Remove three screws and remove the bottom PCB ass'y.

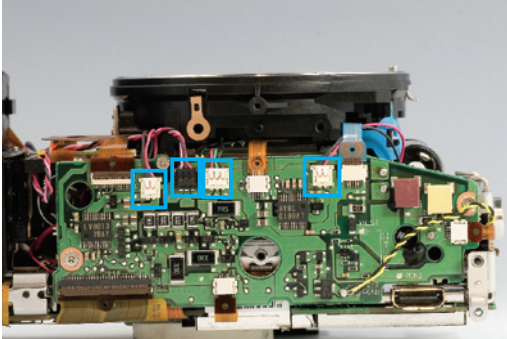

Fig. 039 Position of Bottom PCB Ass'y Lead Wires

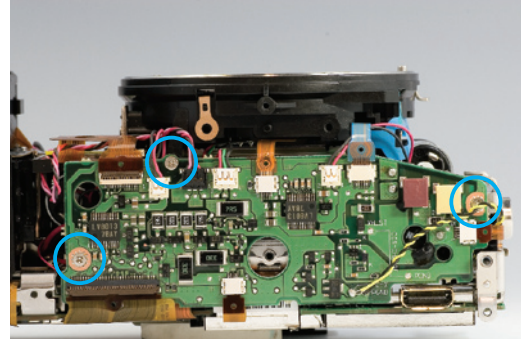

Fig. 040 Position of Bottom PCB Ass'y Screws

3) AF FPC Ass'y Removal

- (1) Remove two screws and one FPC and remove the AF FPC ass'y.

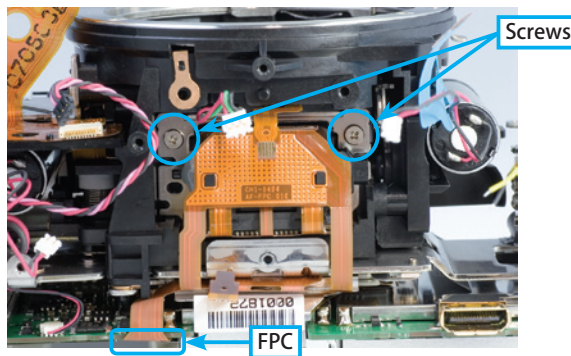

Fig. 041 Position of Screws and FPC of AF FPC Ass'y (Bottom)

<Reassembly Cautions>

1) Base Plate Ass'y Reassembly

- (1) Attach the double-sided tape on the base plate ass'y.
- (2) Attach the washer at the both ends of the double-sided tape.

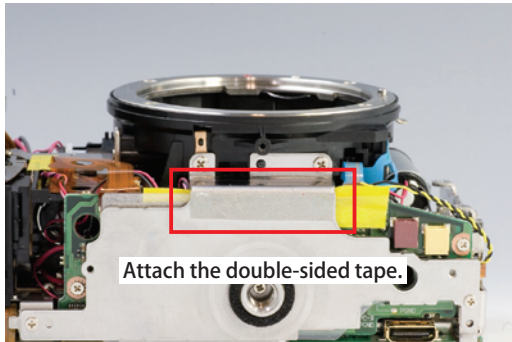

Fig. 042 Position of Double-sided Tape for the Base Plate Ass'y

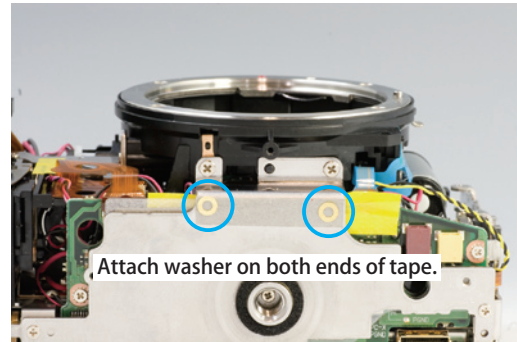

Fig. 043 Position of Base Plate Ass'y Washer

2) Bottom PCB Ass'y Reassembly

CAUTION 3 Route the lead wire correctly so that it will not be pinched when reassembling the exterior.

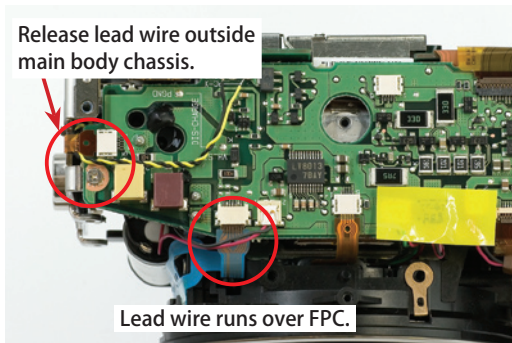

Fig. 044 Routing of Lead Wire on Bottom PCB Ass'y (1)

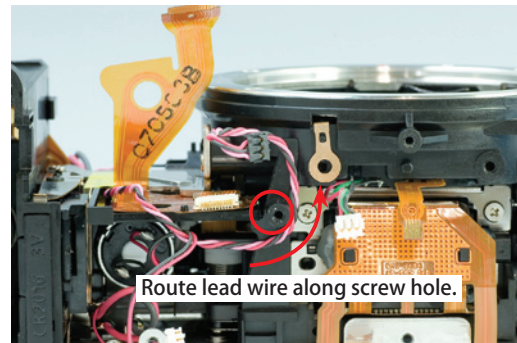

Fig. 045 Routing of Lead Wire on Bottom PCB Ass'y (2)

- (1) Attach the insulation tape (to 2 places) to cover the lead wire to prevent short circuits of the lead wire.

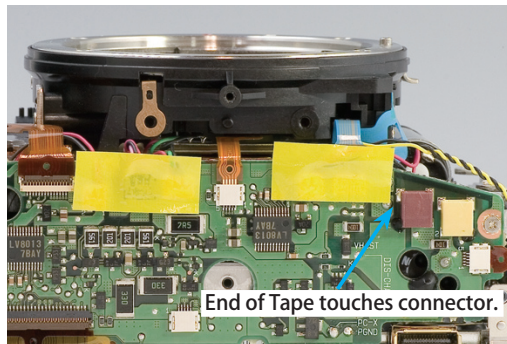

Fig. 046 Position of Insulation Tape for Bottom PCB Ass'y

3) AF FPC Ass'y Reassembly

CAUTION 4 After disassembling the AF FPC ass'y, be sure to adjust the position.

- (1) When replacing the service parts, fold the FPC in a crest form as shown in the image and insert it between the main base plate and the CMOS sensor shield.

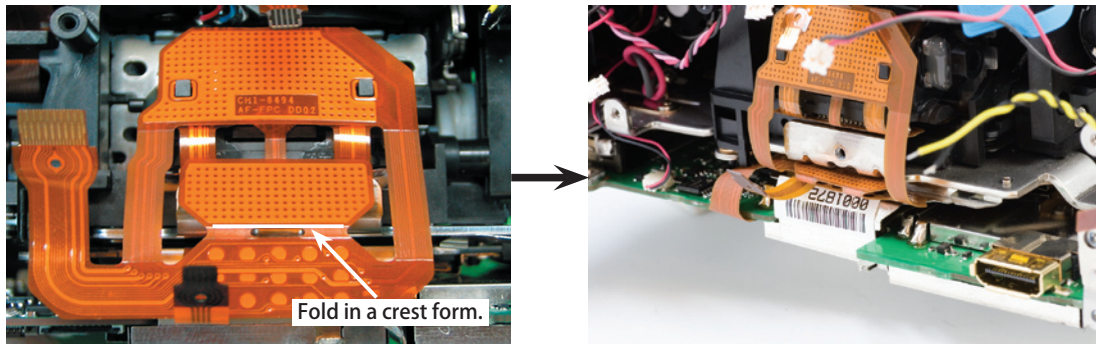

Fig. 047 AF FPC Ass'y FPC Installation

2.5 Main PCB Ass'y and CMOS Sensor Ass'y Removal

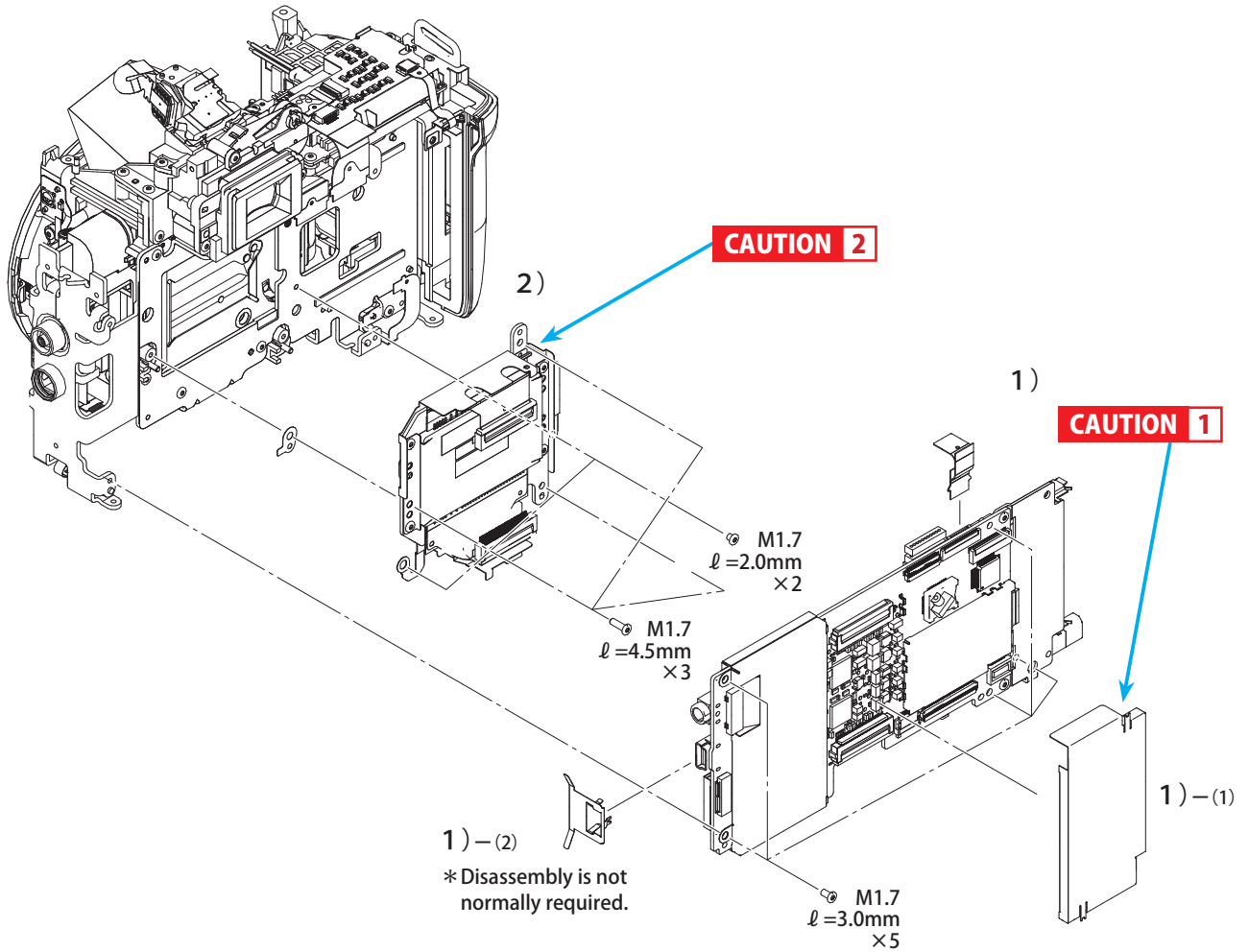

Fig. 048 Main PCB Ass'y and CMOS Sensor Ass'y Removal

<Disassembly>

1) Main PCB Ass'y Removal

(1) Unsolder at two places and remove the main PCB shield cover with tweezers.

CAUTION 1 Be careful not to damage the FPC at the back of the main PCB shield cover when unsoldering.

(2) Unsolder at one place and remove the ground plate.

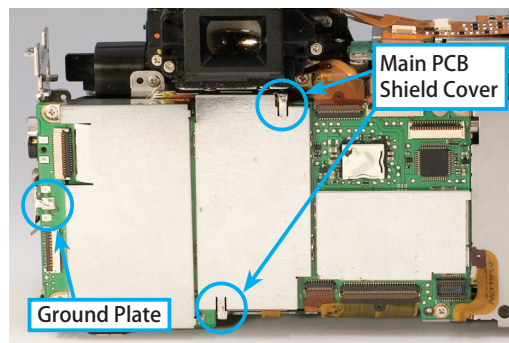

Fig. 049 Soldering Position for Main PCB Shield Cover and Ground Plate

(3) Remove six FPCs.

(4) Disconnect one lead wire.

(5) Remove five screws, and remove the main PCB ass'y while avoiding the metal fittings of the main body.

(6) Disconnect one lead wire (11 pin).

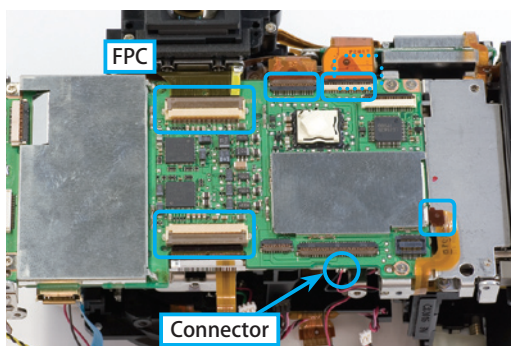

Fig. 050 Position of Main PCB Ass'y FPC and Connector

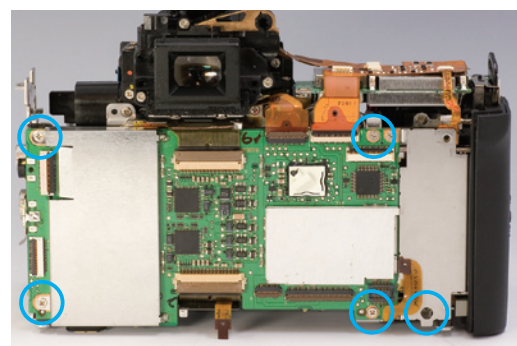

Fig. 051 Position of Main PCB Ass'y Screws

2) CMOS Sensor Ass'y Removal

(1) Remove five screws, and remove the CMOS Sensor Ass'y.

CAUTION 2 Be careful not to scratch or soil the CMOS sensor Ass'y. Also, be careful not to lose the flange back adjust washer, as it comes off together with the CMOS sensor.

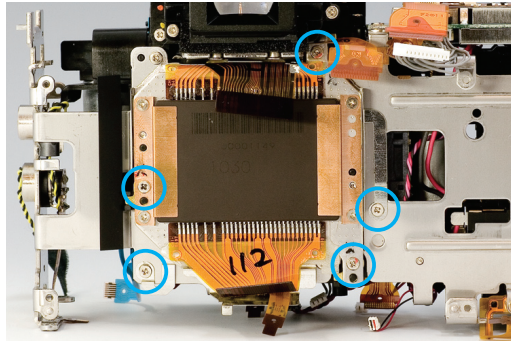

Fig. 052 Position of CMOS Sensor Ass'y Screws

<Reassembly Cautions>

1) Main PCB Shield Cover Reassembly

(1) Attach the main PCB shield cover in the correct position (left, right, up, and down). Make sure that the main PCB shield is held by the four fittings on the main PCB ass'y, and solder the shield.

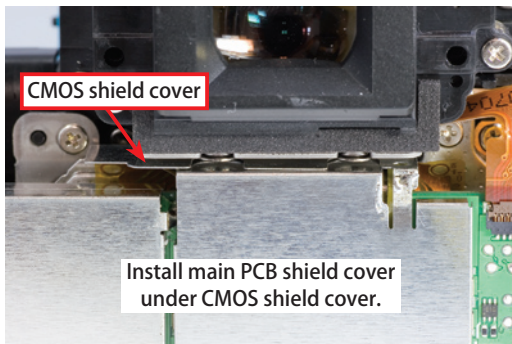

Fig. 053 Soldering Position for the Main PCB Shield Cover (Top)

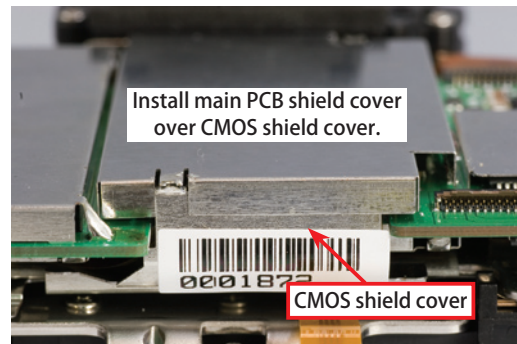

Fig. 054 Soldering Position for the Main PCB Shield Cover (Bottom)

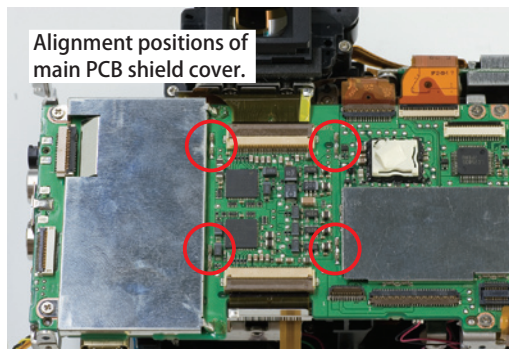

Fig. 055 Position for the Main PCB Shield Cover (on Main PCB Ass'y)

2) Main PCB Ass'y Reassembly

(1)Route the lead wire as shown in the image below.

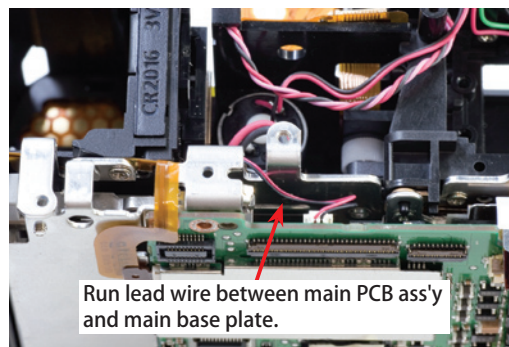

Fig. 056 Routing Lead Wire on Main PCB Ass'y (1)

(2)To make the handling of the lead wire smoother, connect the lead wire (11 pin) into the main body before installing the main PCB ass'y, and rotate the main PCB ass'y 360 degrees to get the lead wire twisted.

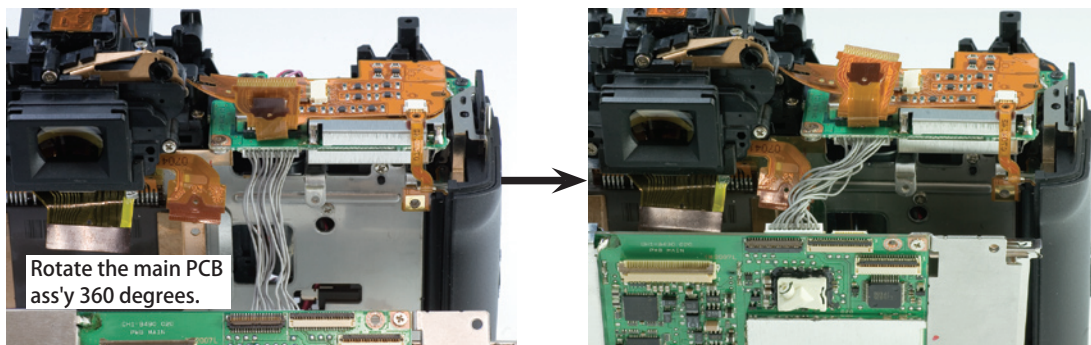

Fig. 057 Routing the Lead Wire on the Main PCB Ass'y (2)

2.6 DC/DC PCB Ass'y and Mirror Box Ass'y Removal

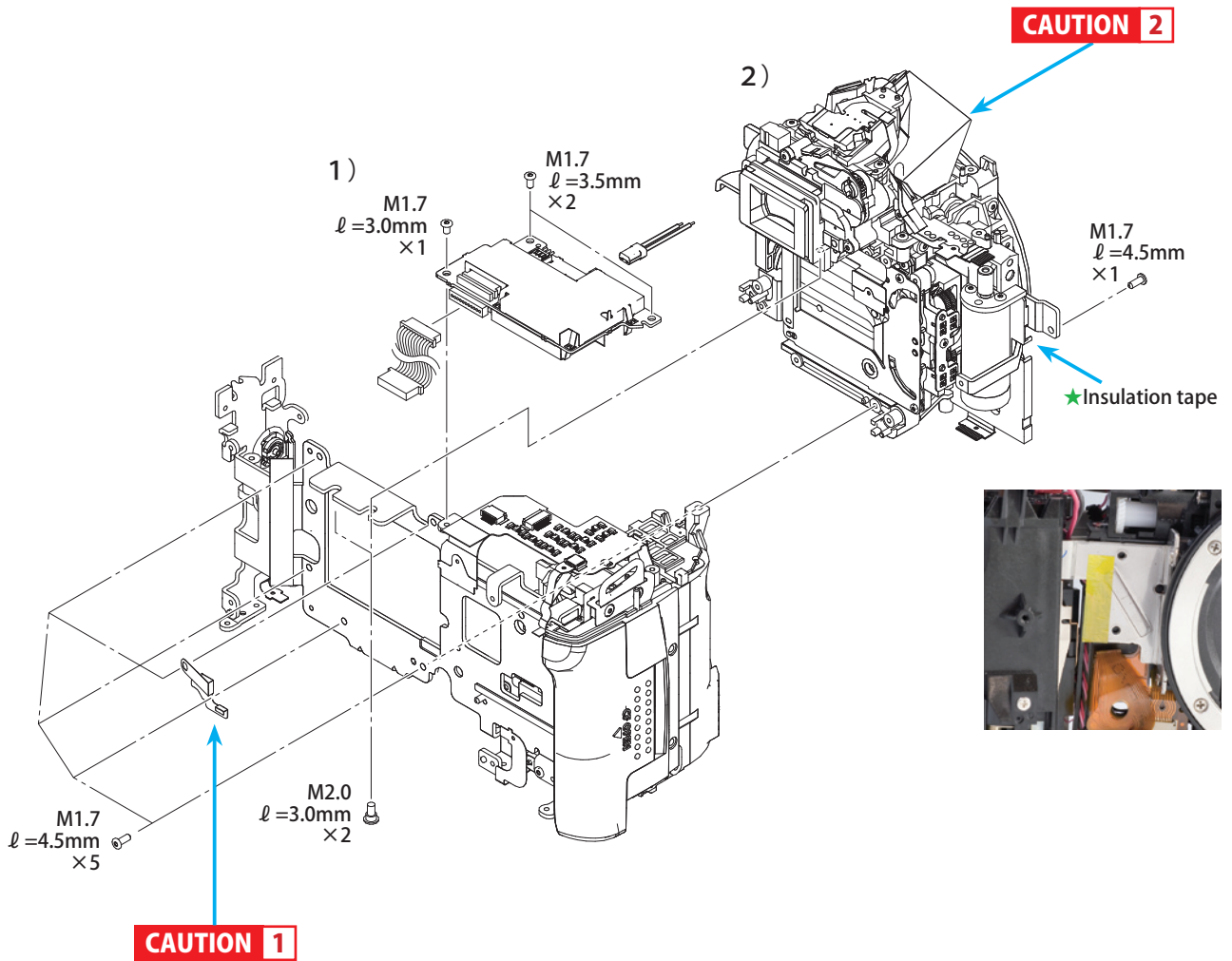

Fig. 058 DC/DC PCB Ass'y and Mirror Box Ass'y Removal

<Disassembly>

1) DC/DC PCB Ass'y Removal

- (1) Remove three FPCs.
- (2) Disconnect the two lead wires with connectors attached.
- (3) Remove three screws and remove the DC/DC PCB Ass'y.

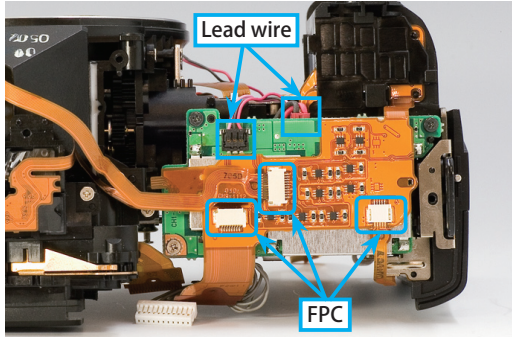

Fig. 059 Position of DC/DC PCB Ass'y FPCs and Lead Wires

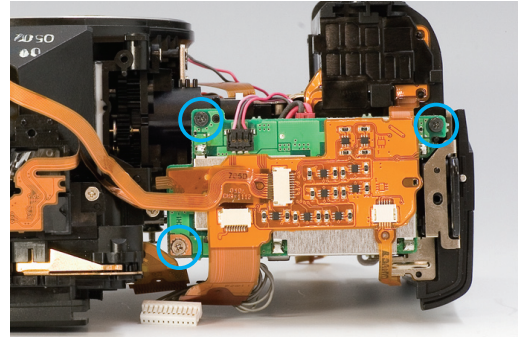

Fig. 060 Position of DC/DC PCB Ass'y Screws

2) Mirror Box Ass'y Removal

- (1) Remove one screw from the front, five screws from the back, and two screws from the eyepiece. Remove the mirror box ass'y.

CAUTION 1 Be careful not to lose the ground plate, as it comes off together with the mirror box ass'y.

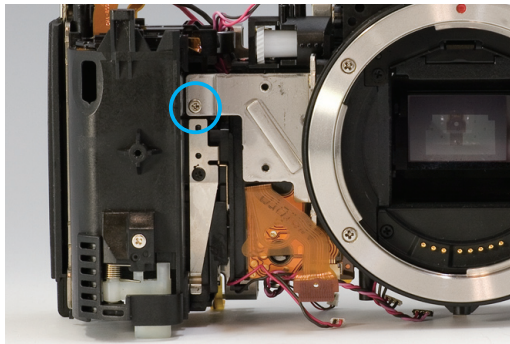

Fig. 061 Position of Mirror Box Ass'y Screws (Front)

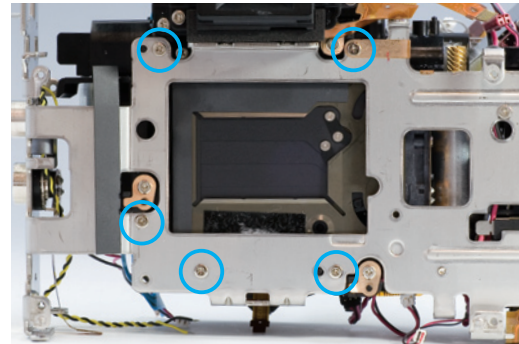

Fig. 062 Position of Mirror Box Ass'y Screws (Back)

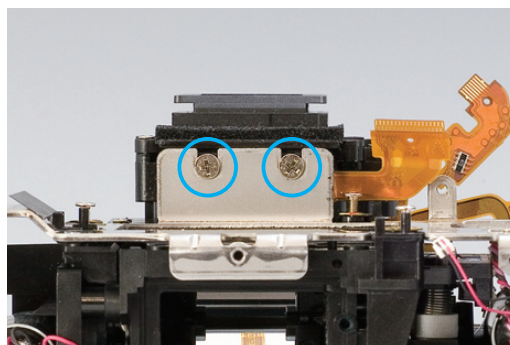

Fig. 063 Position of Eyepiece Screws

<Reassembly Cautions>

1) DC/DC PCB Ass'y Reassembly

(1)When installing the SI FPC ass'y and AE FPC ass'y, run the FPC through the guide and route it as shown in the image below.

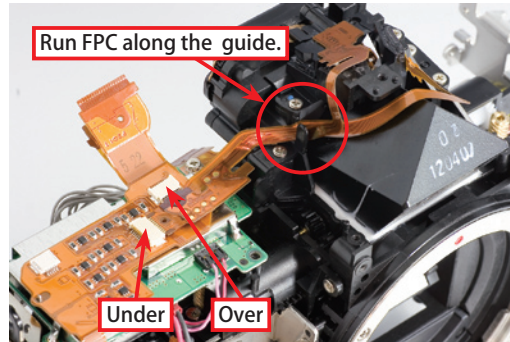

Fig. 064 Routing FPC of DC/DC PCB Ass'y

2) Mirror Box Ass'y Reassembly

(1)When installing the mirror box ass'y, route the lead wire as shown in the image below and attach the insulation tape.

CAUTION 2 When replacing the mirror box ass'y with the service parts, be sure to remove the dummy parts (SI indication plate and focusing screen plate) incorporated.

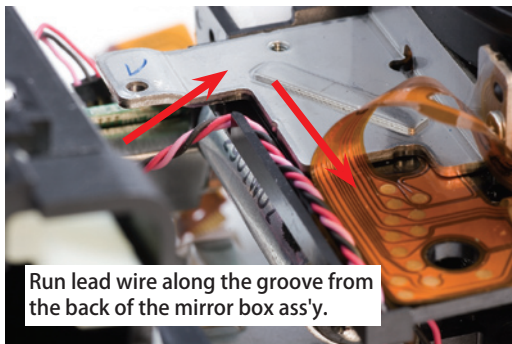

Fig. 065 Routing the Lead Wire of the Mirror Box Ass'y

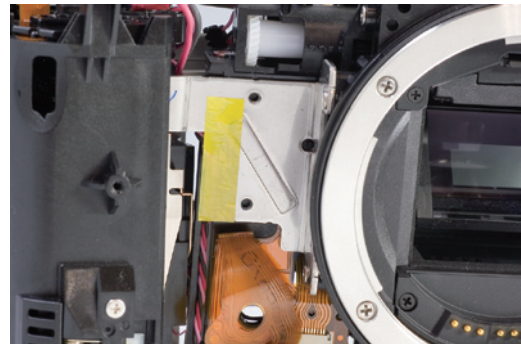

Fig. 066 Position of Mirror Box Ass'y Insulation Tape

2.7 Main Base Plate Disassembly

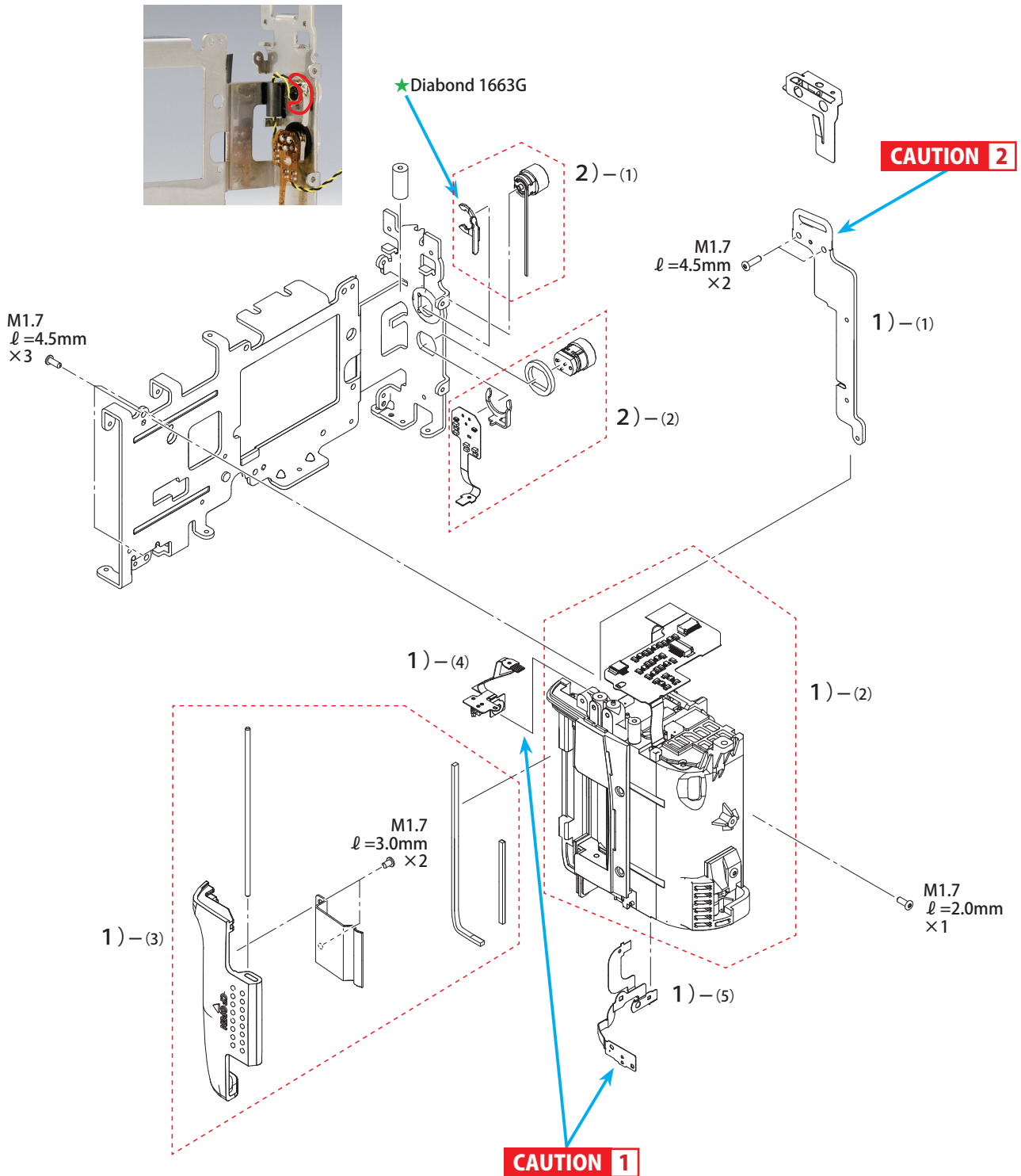

Fig. 067 Main Base Plate Disassembly

<Disassembly>

1) Right Side Cover Ass'y Disassembly (as necessary)

(1) Remove the fitting and two screws, and pull off the strap right holder.

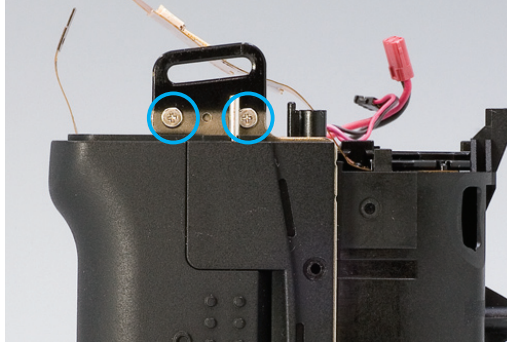

Fig. 068 Position of Strap Right Holder Screws

(2) Remove three screws from the back and one screw from the front, and remove the right side cover ass'y.

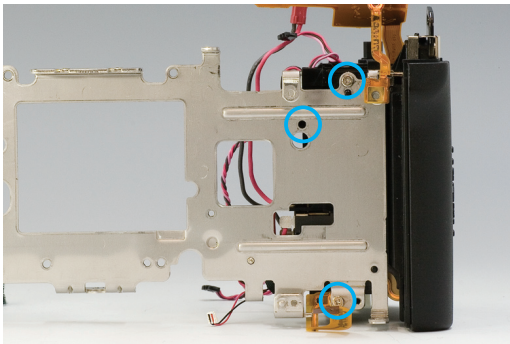

Fig. 069 Position of Right Side Cover Ass'y Screws (Back)

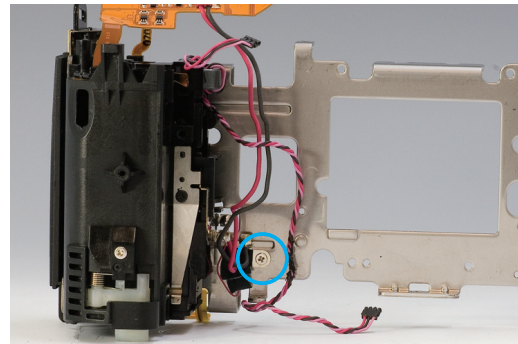

Fig. 070 Position of Right Side Cover Ass'y Screws (Front)

(3) Pull off the CF cover shaft vertically, and remove the CF slot cover.

(4) Remove the CF door FPC ass'y.

(5) Remove the battery cover FPC ass'y.

CAUTION 1 Be careful not to damage the CF door FPC ass'y and the battery cover FPC ass'y.

2) PC Terminal Ass'y and Remote-Control Jack Removal (as necessary)

- (1) Remove the PC retainer ring, and remove the PC terminal ass'y.
- (2) Remove the remote control jack by unsoldering it and removing the fitting.

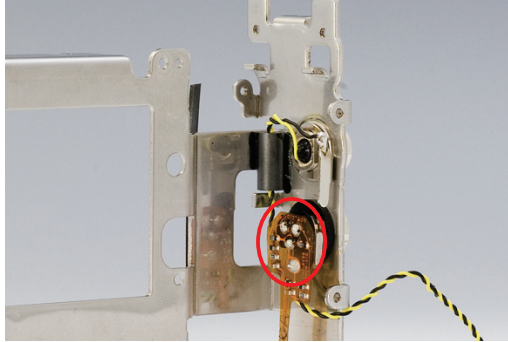

Fig. 071 Soldering Position of Remote Control Jack

<Reassembly Cautions>

1) Strap Right Holder Reassembly

CAUTION 2

Note that the front cover ass'y and the bottom cover ass'y may not be installed properly if the strap right holder is not seated in the correct position.

2.8 Mirror Box Ass'y Disassembly

Apply it to the 2 positions marked with arrows.

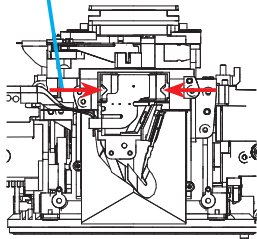

2)

* Disassembly is not normally required.

★ Aron Alpha 201

★ Diabond 1663G

CAUTION 4

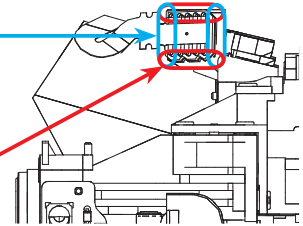

★ Aron Alpha 201
Apply it to the 2 positions marked with arrows.

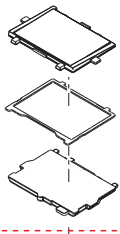

★ Diabond 1663G

3)

M1.7
ℓ=5.0mm
×4

M1.7
ℓ=5.0mm
×2

CAUTION 3

M1.7
ℓ=4.5mm
×2

5) - (2)

5) - (1)

M1.7
ℓ=3.5mm
×2

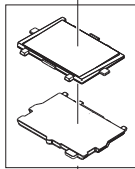

CAUTION 1

★ Grease NFH-743C
Apply an adequate amount.

★ Double-sided Tape
6mm×23mm×2

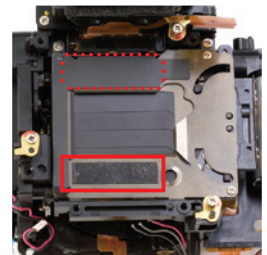

4)

★ IF10

M2.0
ℓ=6.5mm
×4

★ Grease NFH-743C

M1.7
ℓ=4.5mm
×2

6)

CAUTION 2

Fig. 072 Mirror Box Ass'y Disassembly

<Disassembly>

1) Shutter Ass'y Removal

- (1) Remove the FPC from the front wing side.
- (2) Remove two screws, and remove the shutter ass'y.

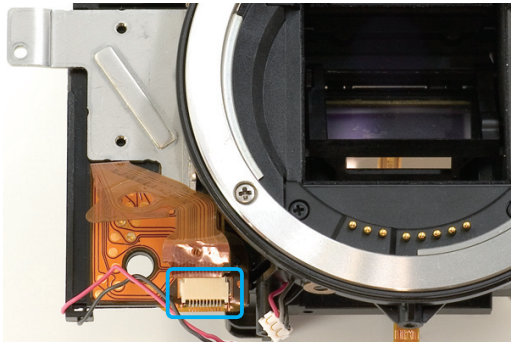

Fig. 073 Position of Shutter Ass'y FPC

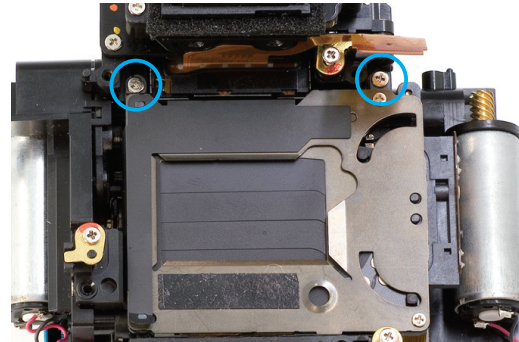

Fig. 074 Position of Shutter Ass'y Screws

2) SI FPC Ass'y and AE FPC Ass'y Removal (as necessary)

- (1) Remove the adhesive part of SI FPC Ass'y with tweezers.
- (2) Remove the glue of AE FPC Ass'y with tweezers.

3) Eyepiece Ass'y Removal

- (1) Remove two screws from the back and four screws from the top, and remove the eyepiece Ass'y.

CAUTION 1 Be careful not to scratch or soil the eyepiece ass'y.

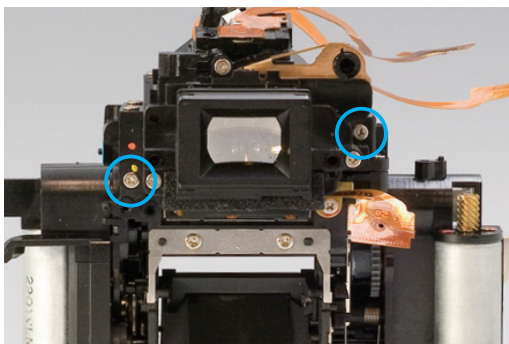

Fig. 075 Position of Eyepiece Ass'y Screws (Back)

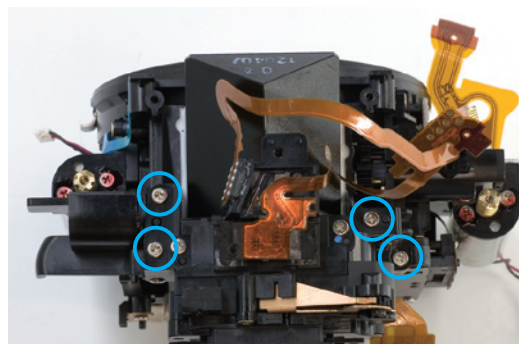

Fig. 076 Position of Eyepiece Ass'y Screws (Top)

4) Mount Removal

(1) Remove four screws, and remove the mount.

CAUTION 2 Be careful not to lose the lens lock pin and the coil spring as they come off together with the mount.

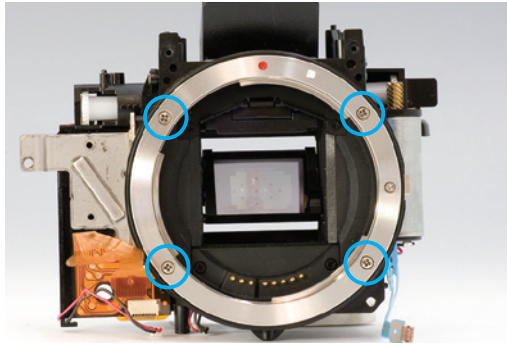

Fig. 077 Position of Mount Screws

5) Focusing Screen Plate Removal

(1) Remove two screws, and remove the screen retainer cover and the screen retainer plate.
 (2) Remove the SI indicate plate, the finder back adjust washer, and the focusing screen plate.

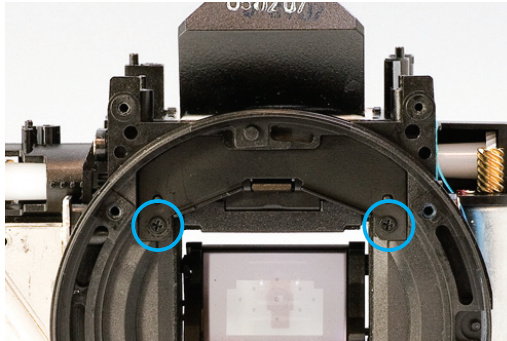

Fig. 078 Position of Screen Retainer Cover Screws

6) Lens Contact Ass'y Removal

(1) Remove two screws, and remove the lens contact ass'y.

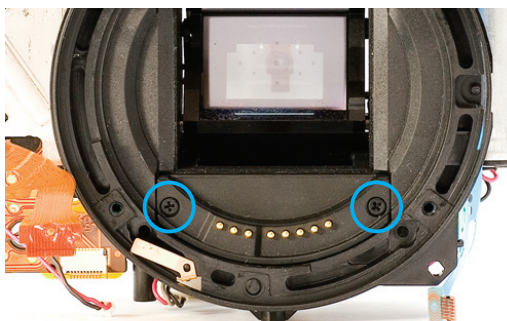

Fig. 079 Position of Lens Contact Ass'y Screws

<Reassembly Cautions>

1) Shutter Ass'y Reassembly

CAUTION 3 When installing the shutter ass'y, mate it in phase with the mirror box ass'y.

2) SI FPC Ass'y and AE FPC Ass'y Reassembly

CAUTION 4 Be sure to adjust the position after disassembling the SI FPC ass'y and AE FPC ass'y.

3) Mirror Box Ass'y Reassembly

(1) Apply grease on the contact position of the mirror ass'y to prevent the mirror box ass'y from becoming worn.

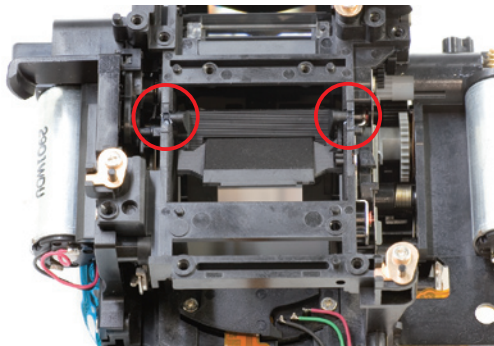

Fig. 080 Position to Apply Grease on Mirror Box Ass'y

4) Screen Retainer Cover Reassembly

(1) Fix one washer with the bond each on the screen retainer cover and on the screen retainer plate.

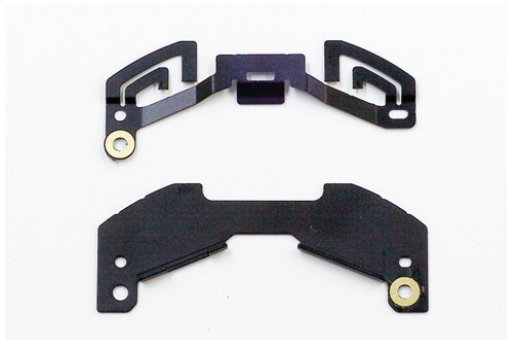

Fig. 081 Position of Screen Retainer Cover Washers

2.9 Back Cover Ass'y Disassembly

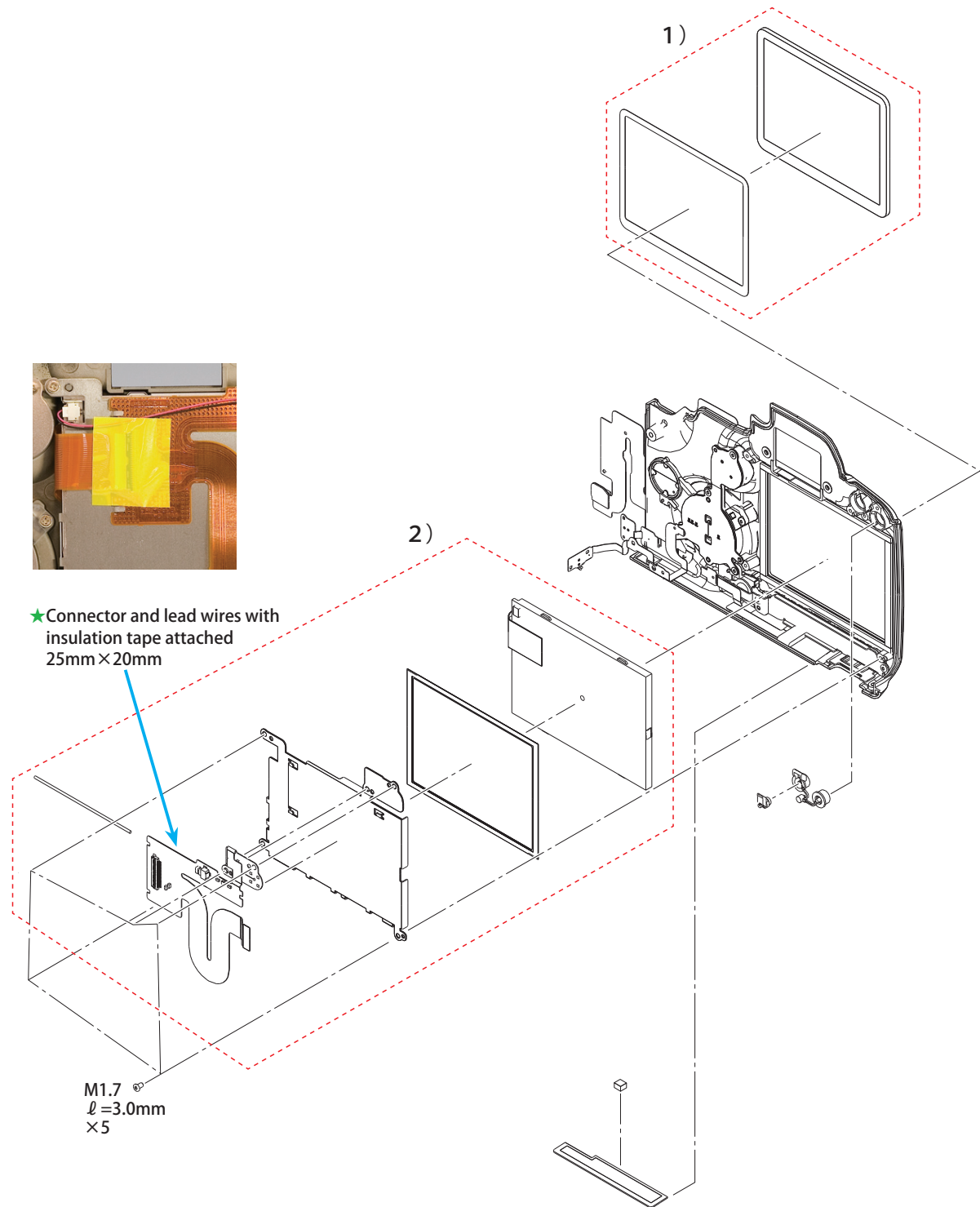

Fig. 082 Back Cover Ass'y Disassembly

<Disassembly>

- 1) TFT Display Window Removal
(1) Remove the TFT display window with tweezers.
- 2) TFT LCD Ass'y Removal
(1) Remove five screws.
(2) Remove one FPC, and remove the TFT LCD Ass'y.

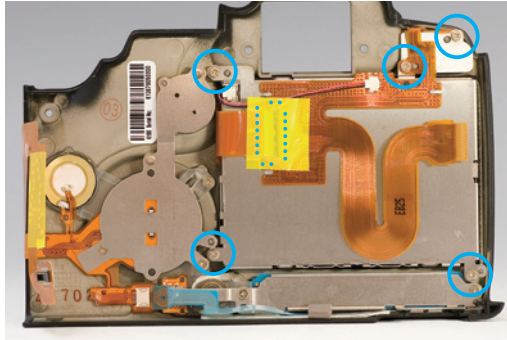

Fig. 083 Position of TFT LCD Ass'y Screws and FPC

- (3) Remove the TFT LCD Ass'y from the TFT holder. (as necessary)

<Reassembly Cautions>

- 1) Back Cover Ass'y Reassembly
(1) Attach the gasket as shown in the image.

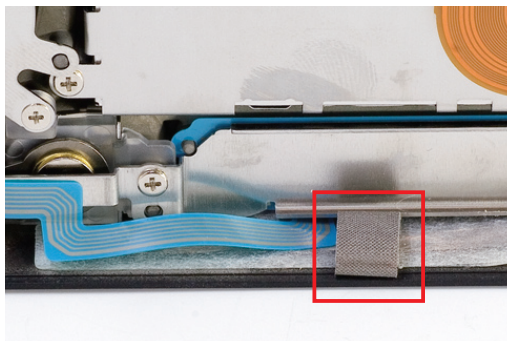

Fig. 084 Position of Back Cover Ass'y Gasket

2.10 Top Cover Ass'y Disassembly

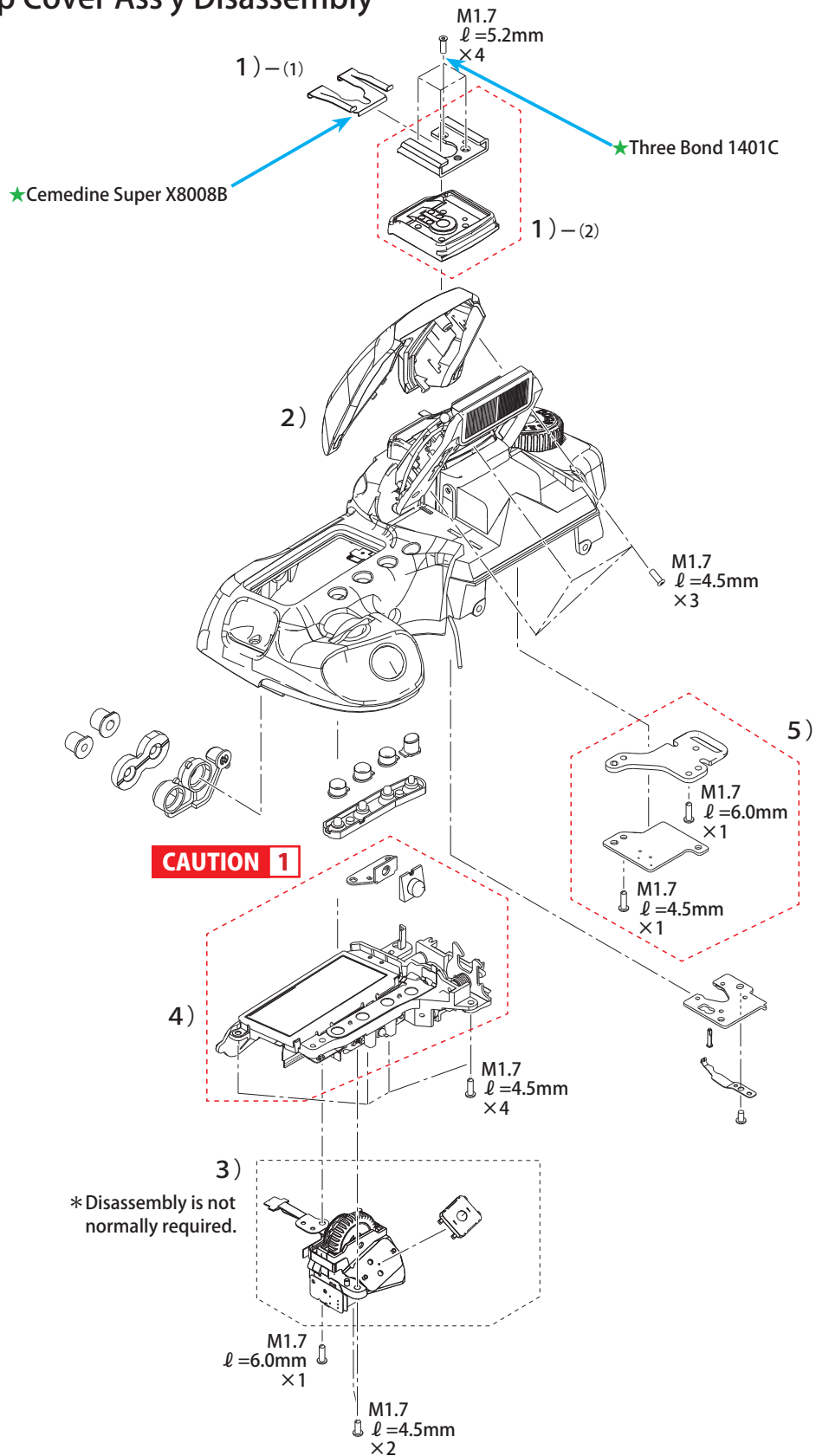

Fig. 085 Top Cover Ass'y Disassembly

<Disassembly>

1) Accessory Shoe Removal

- (1) Lift the clasp slightly with tweezers, and remove the shoe spring.
- (2) Remove four screws, and remove the accessory shoe.



Fig. 086 Position of Accessory Shoe Screws

2) Flash Cover Removal

- (1) Open the flash cover using the inside hook.
- (2) Remove three screws, and remove the flash cover.

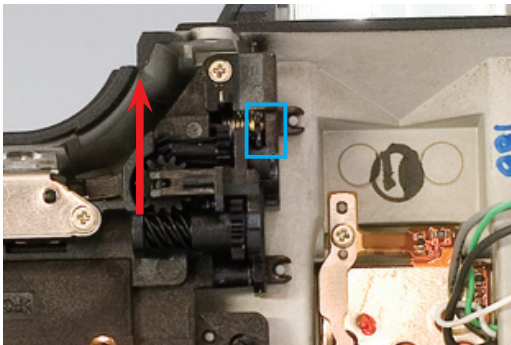

Fig. 087 Position of Flash Cover Hook

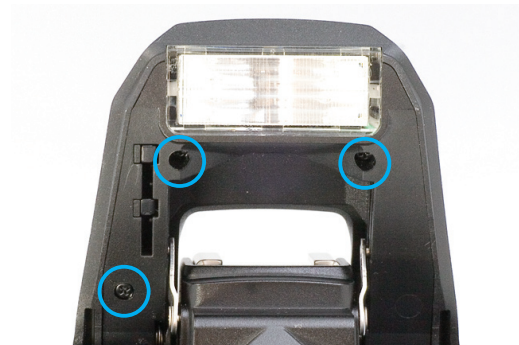

Fig. 088 Position of Flash Cover Screws

3) Dial Ass'y Removal

- (1) Remove three screws and one FPC, and remove the dial ass'y.

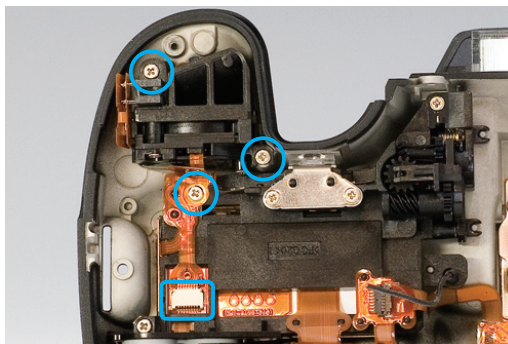

Fig. 089 Position of Dial Ass'y Screws and FPC

4) Outside LCD Ass'y Removal

(1) Remove four screws. With the flash cover popped up, remove the outside LCD ass'y.

CAUTION 1 Be careful not to lose the button as it comes off together with the outside LCD unit.

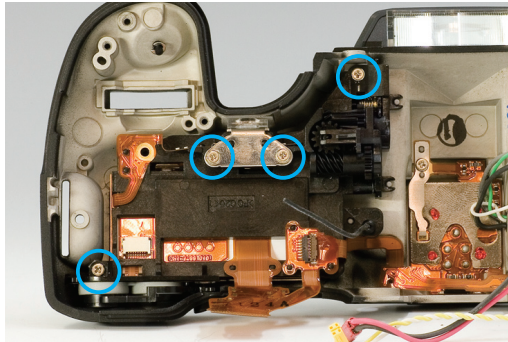

Fig. 090 Position of Outside LCD Ass'y Screws

5) Strap Left Holder Removal

(1) Remove one screw, and remove the PCB.

(2) Remove one screw, and remove the strap left holder.

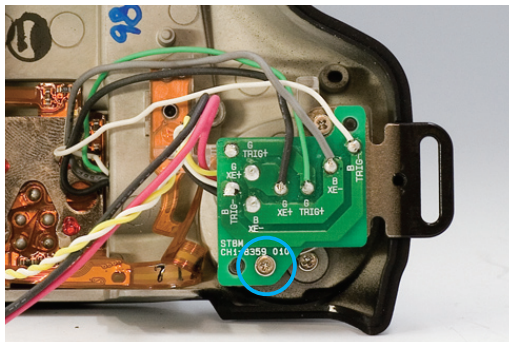

Fig. 091 Position of Strap Left Holder Screws (PCB)

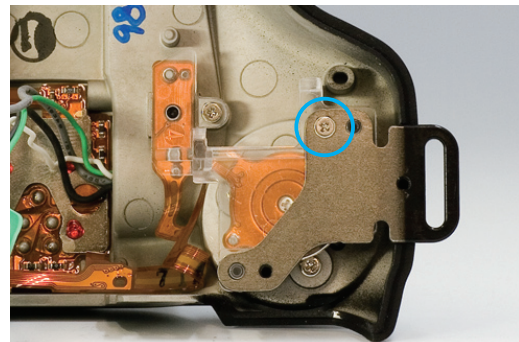

Fig. 092 Position of Strap Left Holder Screws

Adjustments

Trademarks

The product names and company names described in this Service Manual are the registered trademarks of the individual companies.

Copyright

Canon Inc. retains the copyright to this Service Manual. Reproduction, publication (including on the World Wide Web), alteration, translation into another language, or other use of the data in whole or part, contained on this Service Manual without the written consent of Canon Inc. is prohibited.

CONTENTS

Adjustments	Page
1. REPAIR PREPARATIONS	1
1.1 Pre-Adjustment Notes	1
1.2 Tools List.....	1
1.3 Locally-Made Tools	3
2. MECHANICAL ADJUSTMENTS	4
2.1 Flange to Focal Plane Distance (FFD) Adjustment.....	4
2.2 Flange Back Measurement (with the Flange Back Tester).....	9
2.3 Finder Focus Adjustment	12
3. ELECTRICAL ADJUSTMENTS.....	13
3.1 Adjustment Software Operation	13

1. REPAIR PREPARATIONS

1.1 Pre-Adjustment Notes

1) Firmware Upgrade

When the firmware version is upgraded, be sure to download a new version from the Canon site and make sure it is copied to a CF card without fail. Then, perform upgrade.

2) Before Starting the Adjustment

Before starting the adjustment, check the luminance of the EF-1 Multi Camera Tester or EF8000 with BM-3000. Also, check the angle of 3D chart with the angle gauge.

1.2 Tools List

Prepare the following tools required for adjustment.

1) Tools list

New	Name	Part No.	Purpose
	AF Lamp Box Unit	CY9-7122-000	To illuminate the AF chart
	Halogen Lamp (AC100V/250W)	CY9-7122-001	For replacement
	Heat Absorbing Filter	CY9-7122-002	Absorb heat wave of the lamp (replacement)
	Stand, AF Chart	CY9-7123-000	Chart stand for AF charts
	Chart, AF 3D	CY9-7119-000	D Chart
	Chart, AF Single-Point	CY9-7119-001	AF Chart for 3D Chart
*	CHART, AF STANDARD NON-AREA-C	CY9-7119-011	AF adjustment
*	CHART, AF BASE GRID	CY9-7119-012	AF adjustment
	OPTICAL FILTER P01	CY9-6161-000	AF adjustment
	Opal Diffuser Glass ϕ 50 (Edmund Optics Inc.)	Commercially available	AF adjustment
	C2 filter 52mm	CY9-6162-000	Light source adjustment
*	PLATE, AE SENSOR POSITION ADJ.	CY9-1140-000	AE Sensor Positioning
*	PLATE ASS'Y, SI POSITION ADJ.	CY9-1141-000	SI Positioning
	EF-1 Multi Camera Tester (100V)	CY9-7116-100	"A" Light source
	(200V)	CY9-7116-200	"A" Light source
	Color-bar chart	DY9-2002-000	Electrical adjustment (color adjustment)
	Color viewer (5600K/100V)	DY9-2039-100	Electrical adjustment
	(5600K/115V)	DY9-2039-115	Electrical adjustment
	(5600K/220V)	DY9-2039-220	Electrical adjustment
	(5600K/240V)	DY9-2039-240	Electrical adjustment

New	Name	Part No.	Purpose
	DC power source, regulated	Local Purchase	Measure power current consumption
	Mount Fastening Block	CY9-1547-000	Flange focal distance (FFD) adjustment
	Digital micrometer	CY9-7124-000	Flange focal distance (FFD) adjustment
	Digital micrometer stand	CY9-7124-001	Flange focal distance (FFD) adjustment
	Flat rod	CY9-7124-002	Flange focal distance (FFD) adjustment
	AF Tool Lens	CY9-1133-000	AF precision adjustment
	Video light	Local Purchase	AF adjustment
	Stand, AF/AE Positioning	CY9-7126-000	AF/AE Sensor Positioning
	Gauge, AF/AE Positioning	CY9-7126-001	AF/AE Sensor Positioning
	Light Box, AF/AE Positioning	CY9-7126-002	AF/AE Sensor Positioning
	Luminance Meter	CY9-7052-001	Multi-camera Tester Calibration
	Focusing Rail	CY9-1139-000	AF Adjustment
	Screw	CY9-1139-001	AF Adjustment
	Flash meter	Local Purchase	Metering adjustment
	Tripod	Local Purchase	
	Dark bag	Local Purchase	
	Collimator (f=500mm) (100V)	CY9-7057-000 (100)	Finder Focus Adjustment
	(120V)	CY9-7057-000 (120)	Finder Focus Adjustment
	(200V)	CY9-7057-000 (200)	Finder Focus Adjustment
	(240V)	CY9-7057-000 (240)	Finder Focus Adjustment
	Green Filter	CY9-7057-001	
	C12 filters (2 ea.)	CY9-1546-000	White balance adjustment
	Multimeter	Local Purchase	Voltage reading

2) Charts and Locally-Made Tools

New	Name	Part No.	Purpose
	Tool battery	Locally-made	Measure Inhibit voltage & current consumption
	Load Resistor	Local Fabrication	Inhibit voltage check

3) Other Products for Testing

New	Name	Part No.	Purpose
	EF 50mm f/1.8 II	—	Camera operations, adjustments, production lens checking
	Speedlite (580EX, 430EX, or other E-TTL model)	—	Flash metering adjustment
	Clean Booth	CY9-7120-000	Cleaning
	Lupe (Dust check)	CY9-1132-000	Cleaning
	Battery Checker	CY9-7121-000	Battery Pack usability determination

1.3 Locally-Made Tools

1) Tool Battery

The tool battery is the same as the tool battery for the EOS 10D and 20D. The total internal resistance should be $0.4\ \Omega$.

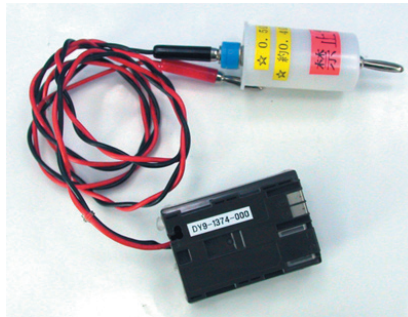

Fig. 001

2. MECHANICAL ADJUSTMENTS

2.1 Flange to Focal Plane Distance (FFD) Adjustment

CAUTION

- The adjustment procedure is same as that of EOS 20D series.
- FFD adjustment is required when replacing the mirror box ass'y or the CMOS sensor ass'y.
- It is also required when images blurred on one side occur due to some impact.

<Purpose>

The FFD is the distance between the lens mount reference plane and the CMOS sensor plane. It cannot be measured directly by service; therefore, measure the distance from the mount plane to CMOS mounting washer plane (washer included) to adjust the FFD.

<Service Parts>

Mirror box ass'y: Compensation washers are not attached as before.

CMOS sensor unit: Offset values based on the specification are written.

<Specifications>

Mirror box ass'y replacement: Set the distance from the lens mount to the CMOS sensor installation surface to same distance as before mirror box ass'y replacement.

CMOS sensor ass'y: Add or subtract the CMOS sensor ass'y compensation amount to/from the difference calculated by subtracting the original distance between the lens mount and the CMOS installation surface (washer included) from the specified distance. Select the washer that meets calculated value to bring the FFD within the specification.

Reference)

FFD: The dimension from the lens mount surface to the imaging surface i.e. the FFD (Flange to focal plane distance) is $44.00 \pm 0.03\text{mm}$.

<Tools>

- Digital micrometer (CY9-7124-000, 001, 002)
- Mount Fastening Tool (CY9-1547-000)

<Preparation>

- Place the mount fastening block on the digital micrometer, and place the measuring tip on the mount reference plane. Reset the meter to "0".

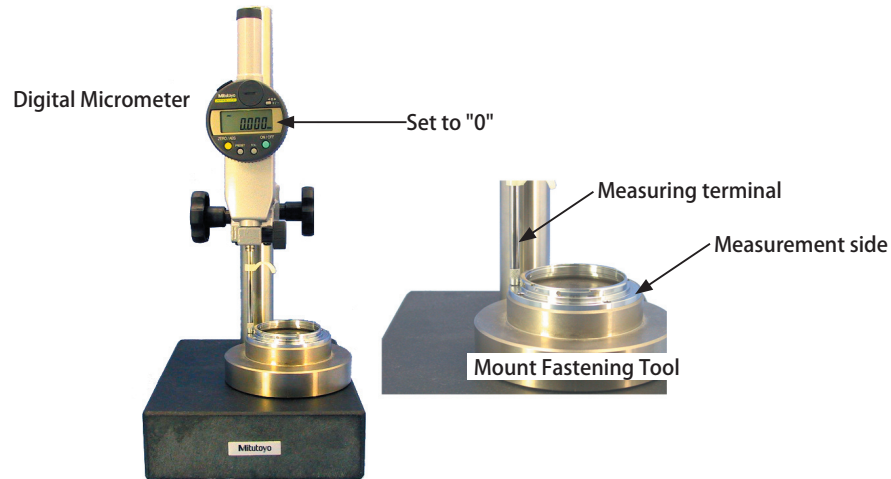

Fig. 002 Set up

<Adjustment Procedure>

1) When replacing CMOS Sensor (Using the original mirror box)

CAUTION Service parts are set to 43.10mm at the factory, and their image units are adjusted. Each offset data is attached to the parts. Therefore, based on the 43.10mm standard, the offset needs to be added or subtracted to calculate the final distance. Then, finally select washer that meet calculated distance.

(1) Measuring the CMOS Sensor position

Measure the distance from the mount surface to the following three points.

- Ex.) P1: 42.964mm
- P2: 42.988mm
- P3: 43.015mm

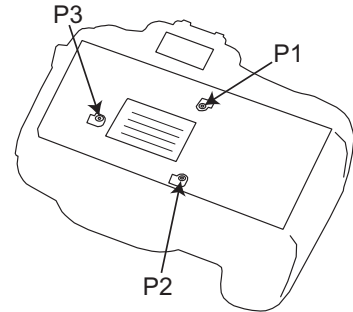

Fig. 003

(2) Offset washer determination (Standard distance: 43.10mm)

The difference between the standard distance and the measured distance (1) for each point is the washer thickness required at that point. (Do not bond washers in place.)

- P1: $43.10 - 42.964 = 0.136$
- P2: $43.10 - 42.988 = 0.112$
- P3: $43.10 - 43.015 = 0.085$

(3) CMOS Sensor Ass'y Offset

The CMOS Sensor Ass'y is marked with the offset values (difference from 43.10mm) for each point. When installing the CMOS sensor, use the indicated washers, but do not bond the washers in place.

- Ex.) P1: (upper right): 0.021
- P2: (lower right): 0.015
- P3: (left) : 0.020

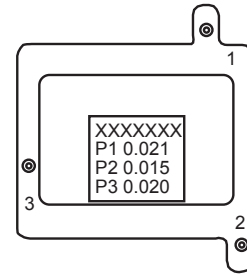

Fig. 004

(4) Tighten the three CMOS Sensor Ass'y screws uniformly.

CB2-0682-000 (XXX)

<p>A</p>	A ± 0.015 SIZE
	0.03 mm (003)
	0.05 mm (005)
	0.08 mm (008)
	0.10 mm (010)
	0.12 mm (012)
	0.15 mm (015)
	0.18 mm (018)
	0.20 mm (020)
	0.25 mm (025)
	0.30 mm (030)
	0.35 mm (035)

Fig. 005

2) When replacing Mirror Box Ass'y (Using the same CMOS Sensor Ass'y)

CAUTION

As the washer offsets for the CMOS Sensor are unknown, select washer offsets and insert the washer to approximate the distance from mount surface of mirror box to image sensor installation surface (washer included) on the camera being repaired.

- (1) Before replacing the mirror box, remove the CMOS Sensor, and measure the existing dimension from the mount surface to the image sensor installation surface (with washer) at the three points.
 - (2) After replacing the mirror box, measure the distance from the mount surface to the image sensor installation surface (three points). Select and attach washers to make the distance the same as before replacement.
- Ex.) If the existing FFD was 42.95mm with a 0.4mm washer for a total of 43.35mm. Since the total is 43.35mm, the washer need not be installed.

3) When replacing both the Mirror Box Ass'y and CMOS Sensor ass'y

CAUTION

Mirror Box Ass'y service parts are factory-adjusted to standard size (43.10mm), and the correction is marked on the parts. Therefore, the mirror boxes are adjusted to 43.10mm, and the offset correction is marked on the CMOS sensor unit. Follow the procedures in Adjustment Procedure 1).

- (1) Measuring the CMOS Sensor position
Measure the distance from the mount surface to the following three points.
Ex.) P1: 42.964mm
P2: 42.988mm
P3: 43.015mm

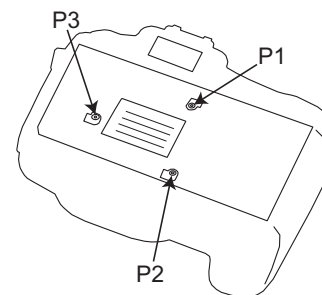

Fig. 006

- (2) Offset washer determination (Standard distance: 43.10mm)
The difference between the standard distance and the measured distance (1) for each point is the washer thickness required at that point. (Do not bond washers in place.)
P1: $43.10 - 42.964 = 0.136$
P2: $43.10 - 42.988 = 0.112$
P3: $43.10 - 43.015 = 0.085$

(3) CMOS Sensor Ass'y Offset

The CMOS Sensor Ass'y is marked with the offset values (difference from 43.10mm) for each point. When installing the CMOS sensor, use the indicated washers, but do not bond the washers in place.

Ex.) P1: (upper right): 0.021
P2: (lower right): 0.015
P3: (left) : 0.020

(4) Tighten the three CMOS Sensor Ass'y screws uniformly.

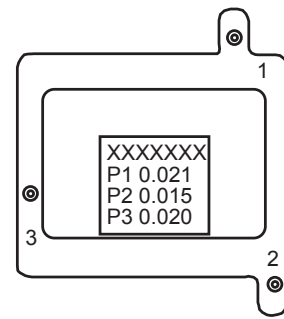

Fig. 007

2.2 Flange Back Measurement (with the Flange Back Tester)

CAUTION

When using the Flange Back Tester, follow the instruction manual supplied with the product and the explanation on preparation below.

<Preparation>

1) Checking of the power cable

Make sure to check for any damage or brakeage of the power cable before connecting it to the tester. The power cable is not provided with this tool, so one that meets local standards should be purchased.



Fig. 008



Fig. 009

Voltage: Depends on the country

Electric power: 60VA

2) Aging and Calibration of the Reference Surface

- (1) Check for dust and dirt on the mount reference surface (including jigs) and the sensor part of the flange back tools.
- (2) Increases in internal temperature will affect the measurement results, so **perform aging for 1 hour** or more before measuring the flange back and perform reference surface calibration with the special calibration tool.
- (3) When flange back is measured more than 1 hour after the previous reference surface calibration, perform the reference surface calibration with the special calibration tool before measuring.



Fig. 010

3) Flange Back Measurement

(1) Make flange back adjustment following the procedures described in Section 2.1.

(2) Attach the Main PCB Ass'y and the Bottom PCB Ass'y.

Connect the necessary FPCs and lead wires (Main PCB: 3 places, Bottom PCB: 6 places).

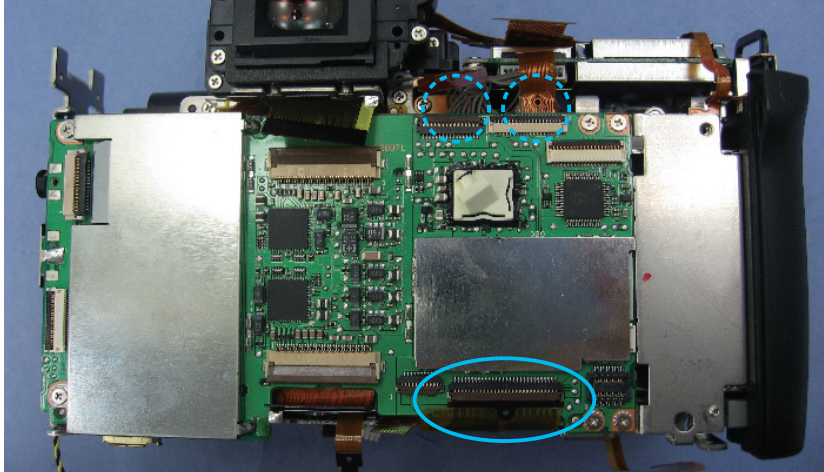

Fig. 011

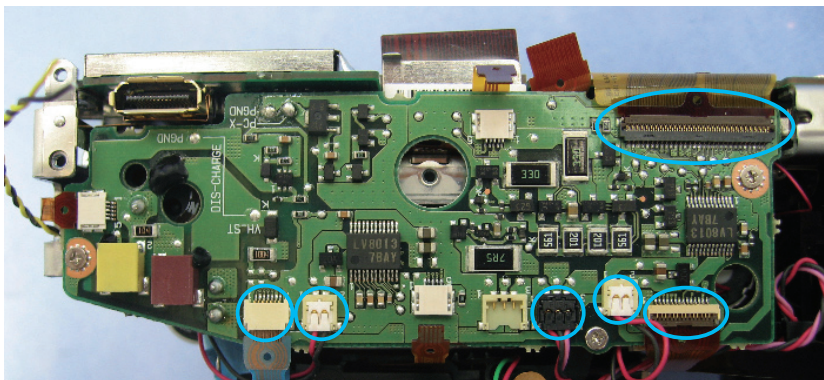

Fig. 012

CAUTION Attach the insulating tape to the FPCs that are not connected so that those FPCs will not short-circuit.

(3) Connect the FPCs to the Back Cover Ass'y (2 places).

(4) Attach the DC coupler, turn on the power, and set the camera to manual cleaning mode.



Fig. 013

(5) Set the camera on the Flange Back Tester and measure the flange back.



Fig. 014

(6) If the flange back is outside the standard, make flange back adjustment once again.

2.3 Finder Focus Adjustment

CAUTION

Be sure to perform the Finder Focus Adjustment after the FFD Adjustment is completed.

<Purpose>

To fit the position of CMOS sensor plane and the viewfinder focus point.

<Specifications>

The center of the infinity mark must be positioned within the 1.5 index line widths of the index line as shown below.

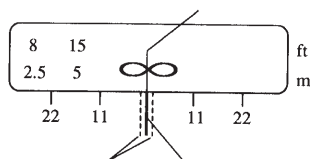

Fig. 015 Focusing Scale Alignment

<Tools>

- Magnifier AD-S.
- Angle finder C, Finder accessories.
- Lens of 100 mm focal length or less is desirable.
- General purpose 500mm collimator

<Preparation>

- 1) Without the lens attached to the camera, turn the diopter adjustment dial of the camera to adjust the AF frame to be at the center of the viewfinder.
- 2) Attach the magnifier to the camera eyepiece and adjust the diopter of the magnifier. (Perform without the lens attached.)

<Adjustment Procedure>

- 1) Look through an object that is located at least 250m away (such as lightning rod or chimney) and turn the manual ring to find the position that gives the clearest view of the object.
- 2) Check if the center of the infinity mark is positioned within the 1.5 index line equivalent widths. If not, replace the focus washer and try again.

* When a collimator is used, select the focus washer that gives the clearest view of the collimator scale.

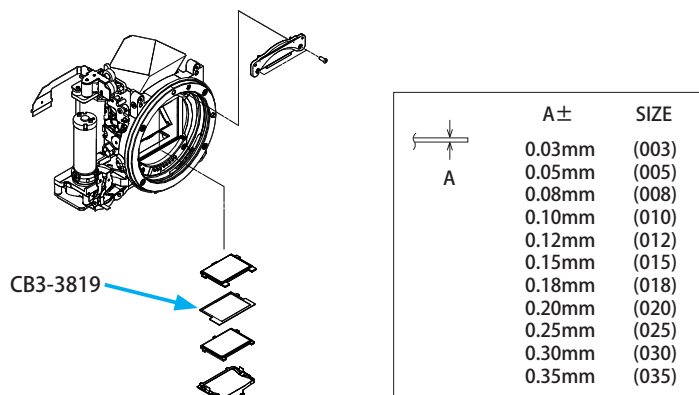

Fig. 016 Focusing Washer Replacement

3. ELECTRICAL ADJUSTMENTS

3.1 Adjustment Software Operation

1) Service Parts

OS: Windows 2000, Windows XP
CPU: Pentium III, 800MHz or better
RAM: 512 MB or more required
Display: 1024 × 768 dots required
Hard disk space: Approx. 100 MB required

2) Operation

See the HELP section of the Adjustment Software for details.

Parts Catalog

Canon

EOS 40D

REF. NO. C12-6171

**PARTS
CATALOG**

CANON EOS 40D

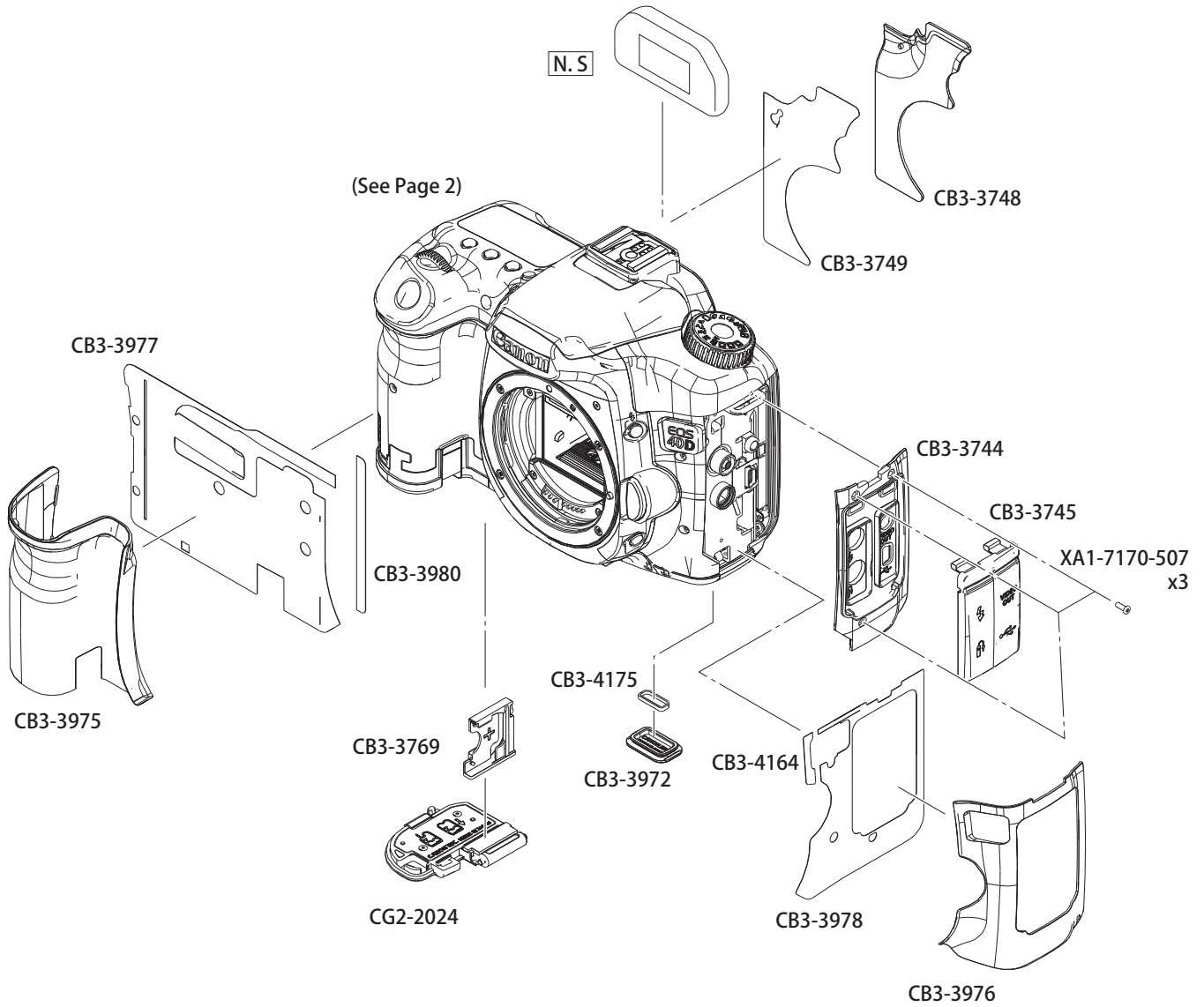

P A R T S L I S T

REF. NO. C12-6171

NEW	PARTS NO.	CLASS	QTY	DESCRIPTION
*	CB3-3744-000 000	C	1	COVER, INTERFACE
*	CB3-3745-000 000	B	1	CAP, INTERFACE
*	CB3-3748-000 000	B	1	COVER, BACK HOLDING
*	CB3-3749-000 000	B	1	TAPE, DOUBLE SIDE
*	CB3-3769-000 000	C	1	CASE, BATTERY
*	CB3-3972-000 000	C	1	CAP, EXTENSION TERMINAL
*	CB3-3975-000 000	B	1	COVER, GRIP HOLDING
*	CB3-3976-000 000	B	1	COVER, FRONT
*	CB3-3977-000 000	B	1	TAPE, DOUBLE SIDE
*	CB3-3978-000 000	B	1	TAPE, DOUBLE SIDE
*	CB3-3980-000 000	B	1	TAPE, DOUBLE SIDE
*	CB3-4164-000 000	B	1	TAPE, DOUBLE SIDE
*	CB3-4175-000 000	C	1	RING, O
*	CG2-2024-000 000	B	1	COVER ASS'Y, BATTERY
	XA1-7170-507 000	F	3	SCREW, CROSS-RECESS, PH

CANON EOS 40D

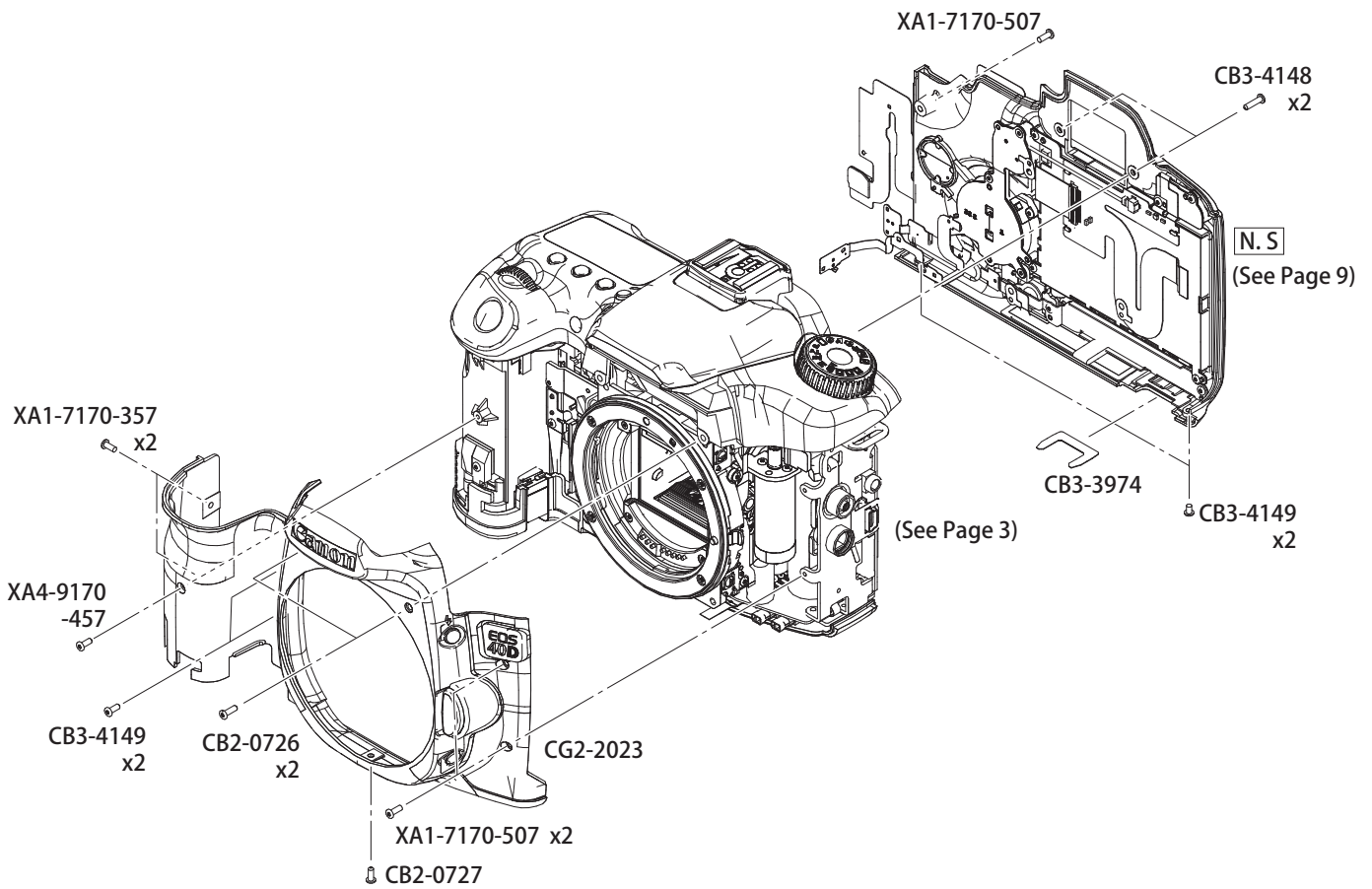

P A R T S L I S T

REF. NO. C12-6171

NEW	PARTS NO.	CLASS	QTY	DESCRIPTION
	CB2-0726-000 000	C	2	SCREW, M17X5.5
	CB2-0727-000 000	C	1	SCREW, M1.7X4.5
*	CB3-3974-000 000	C	1	SHEET, EXTENSION TERMINAL
*	CB3-4148-000 000	C	2	SCREW
*	CB3-4149-000 000	C	4	SCREW
* *	CG2-2023-000 000	B	1	COVER ASS'Y, FRONT
	XA1-7170-357 000	F	2	SCREW, CROSS-RECESS, PH
	XA1-7170-507 000	F	3	SCREW, CROSS-RECESS, PH
	XA4-9170-457 000	F	1	SCREW, CROSS-RECESS, PH

CANON EOS 40D

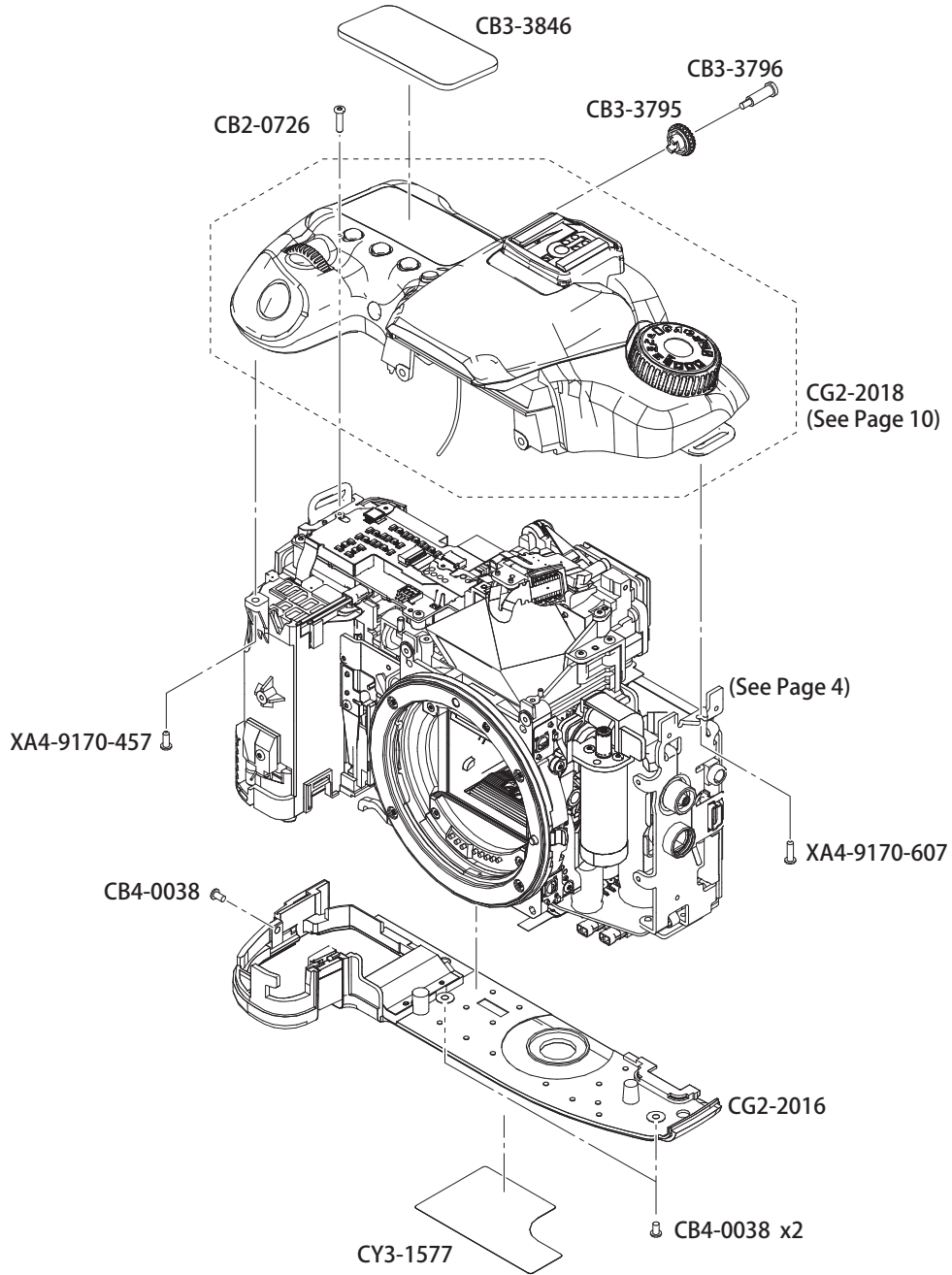

P A R T S L I S T

REF. NO. C12-6171

NEW	PARTS NO.	CLASS	QTY	DESCRIPTION
	CB2-0726-000 000	C	1	SCREW, M17X5.5
*	CB3-3795-000 000	C	1	DIAL, DIOPTER CORRECTION
*	CB3-3796-000 000	C	1	SCREW
*	CB3-3846-000 000	B	1	WINDOW, DISPLAY
	CB4-0038-000 000	B	3	SCREW, CROSS-RECESS, PH
*	CG2-2016-000 000	C	1	COVER ASS'Y, BOTTOM
*	CG2-2018-000 000	B	1	COVER ASS'Y, TOP
*	CY3-1577-000 000	B	1	LABEL, BODY NUMBER
	XA4-9170-457 000	F	1	SCREW, CROSS-RECESS, PH
	XA4-9170-607 000	F	1	SCREW, CROSS-RECESS, PH

CANON EOS 40D

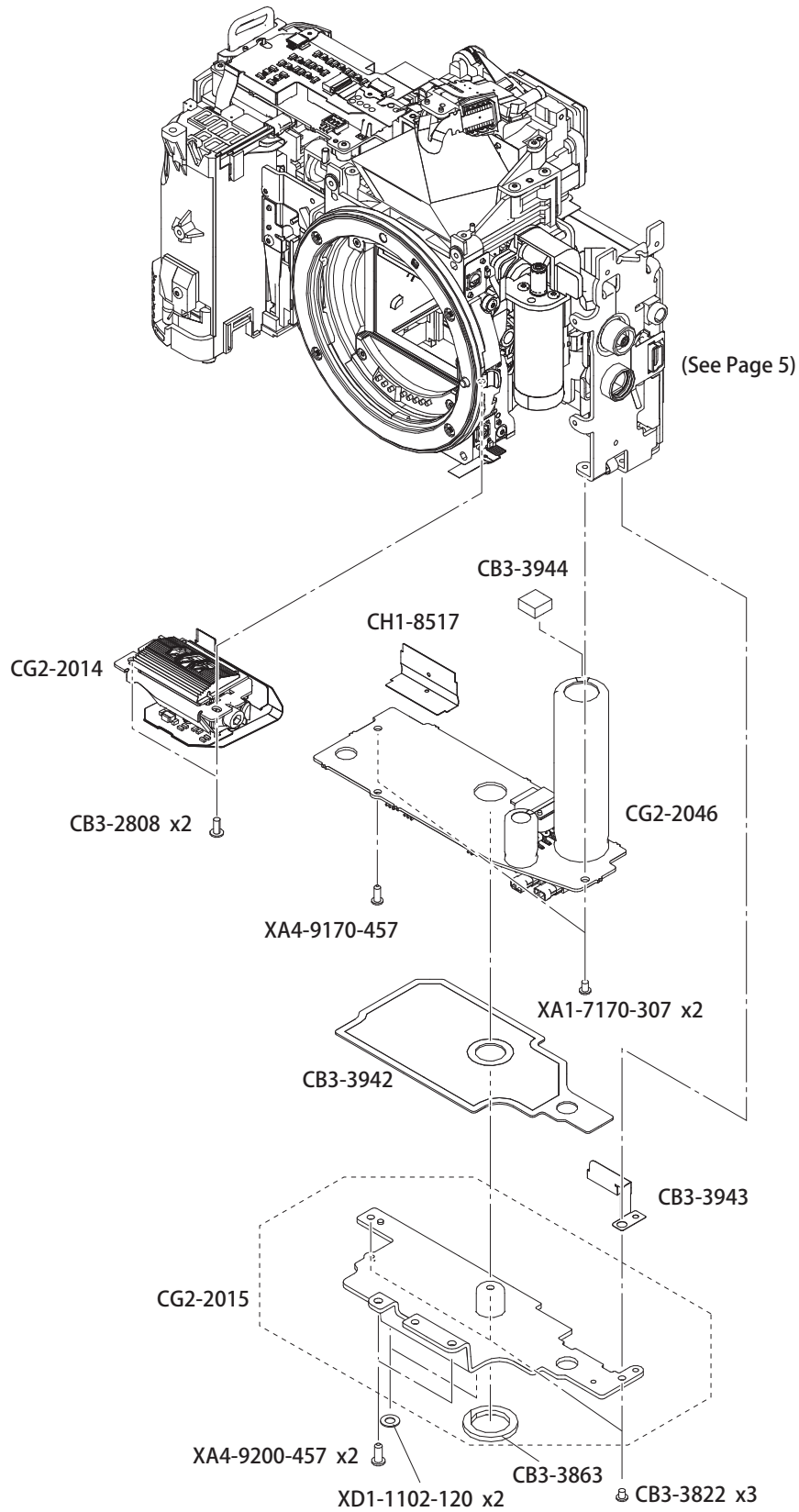

P A R T S L I S T

REF. NO. C12-6171

NEW	PARTS NO.	CLASS	QTY	DESCRIPTION
	CB3-2808-000 000	C	2	SCREW
*	CB3-3822-000 000	C	3	SCREW
*	CB3-3863-000 000	C	1	CUSHION, TRIPOD
*	CB3-3942-000 000	C	1	SHEET, BOTTOM
*	CB3-3943-000 000	C	1	PLATE, GROUND (EXT. TERMINAL)
*	CB3-3944-000 000	C	1	CUSHION, MAIN-CAPACITOR
*	CG2-2014-000 000	C	1	FPC ASS'Y, AF
*	CG2-2015-000 000	C	1	PLATE ASS'Y, BASE
*	CG2-2046-000 000	C	1	PCB ASS'Y, BOTTOM
*	CH1-8517-000 000	C	1	FPC, BOTTOM-MAIN
	XA1-7170-307 000	F	2	SCREW, MACH. PANHEAD, M1.7X3
	XA4-9170-457 000	F	1	SCREW, CROSS-RECESS, PH
	XA4-9200-457 000	F	2	SCREW, CROSS-RECESS, PH
	XD1-1102-120 000	F	2	WASHER, COP

CANON EOS 40D

(See Page 6)

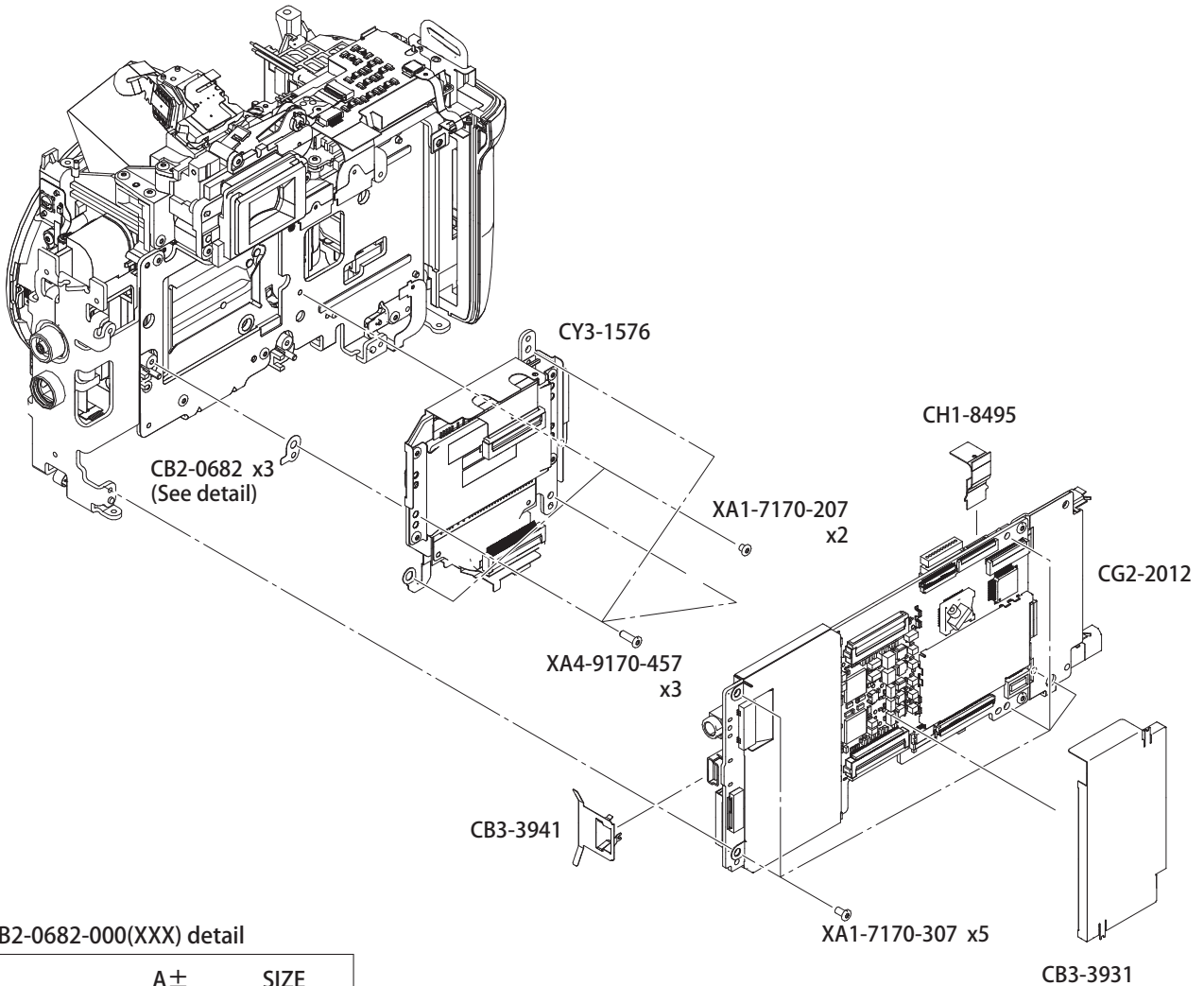

CB2-0682-000(XXX) detail

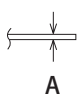
	A ±	SIZE
 A	0.03mm	(003)
	0.05mm	(005)
	0.08mm	(008)
	0.10mm	(010)
	0.12mm	(012)
	0.15mm	(015)
	0.18mm	(018)
	0.20mm	(020)
	0.25mm	(025)
	0.30mm	(030)
	0.35mm	(035)

P A R T S L I S T

REF. NO. C12-6171

NEW	PARTS NO.	CLASS	QTY	DESCRIPTION
	CB2-0682-000 (XXX)	C	3	WASHER, FLANGE BACK
*	CB3-3931-000 000	C	1	COVER, MAIN PCB SHIELD
*	CB3-3941-000 000	C	1	PLATE, GROUND (USB)
*	CG2-2012-000 000	B	1	PCB ASS'Y, MAIN
*	CH1-8495-000 000	C	1	FPC, MAIN-DCDC
*	CY3-1576-000 000	B	1	CMOS SENSOR ASS'Y
	XA1-7170-207 000	F	2	SCREW
	XA1-7170-307 000	F	5	SCREW, MACH. PANHEAD, M1.7X3
	XA4-9170-457 000	F	3	SCREW

CANON EOS 40D

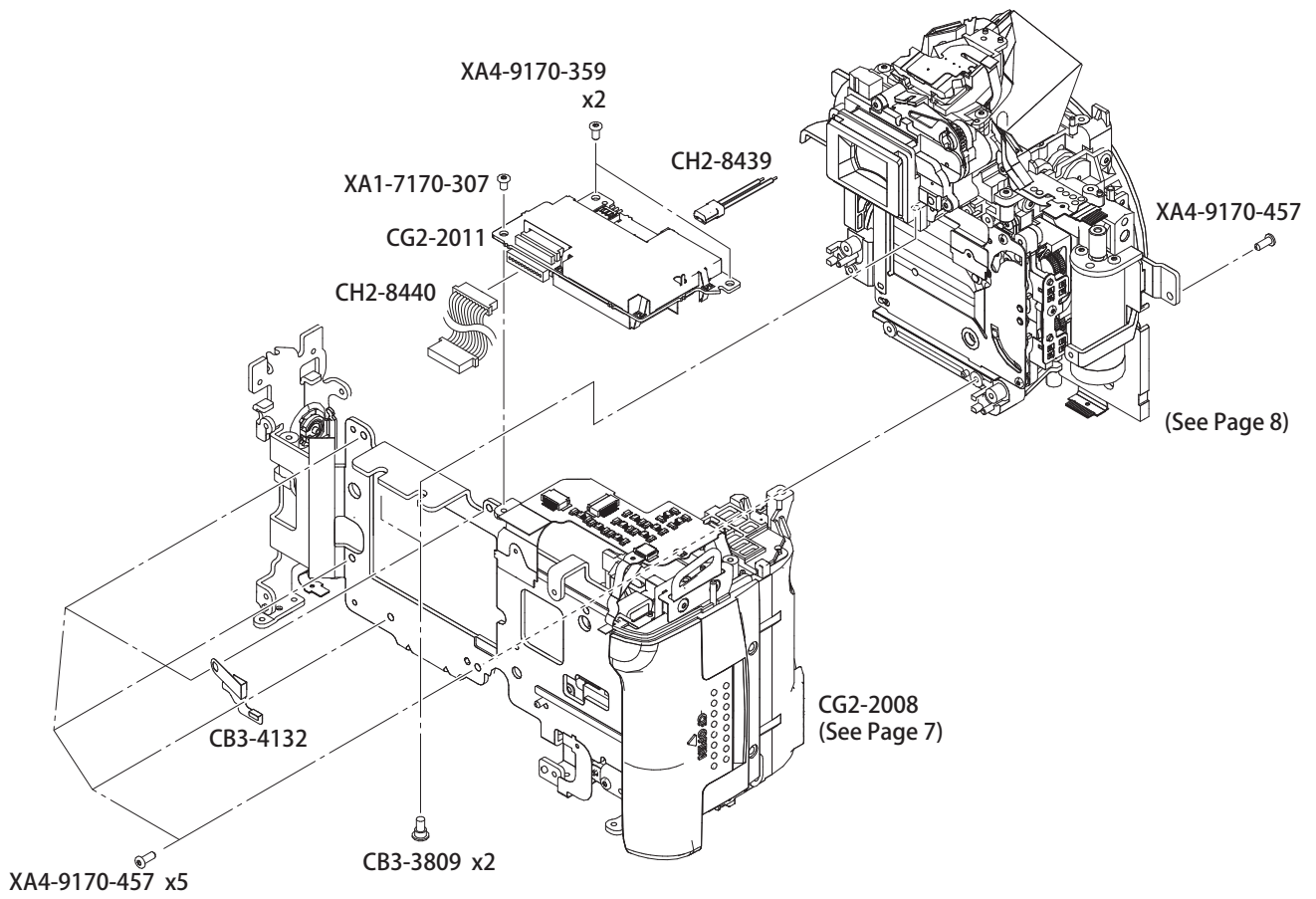

P A R T S L I S T

REF. NO. C12-6171

NEW	PARTS NO.	CLASS	QTY	DESCRIPTION
*	CB3-3809-000 000	C	2	SCREW
*	CB3-4132-000 000	C	1	PLATE, GROUND (MAIN-SHUTTER)
*	CG2-2008-000 000	C	1	PLATE ASS'Y, MAIN BASE
*	CG2-2011-000 000	B	1	PCB ASS'Y, DC/DC
*	CH2-8439-000 000	C	1	WIRE, LEAD
*	CH2-8440-000 000	C	1	WIRE, LEAD
	XA1-7170-307 000	F	1	SCREW, MACH. PANHEAD, M1.7X3
	XA4-9170-359 000	F	2	SCREW, CROSS-RECESS, PH
	XA4-9170-457 000	F	6	SCREW, CROSS-RECESS, PH

CANON EOS 40D

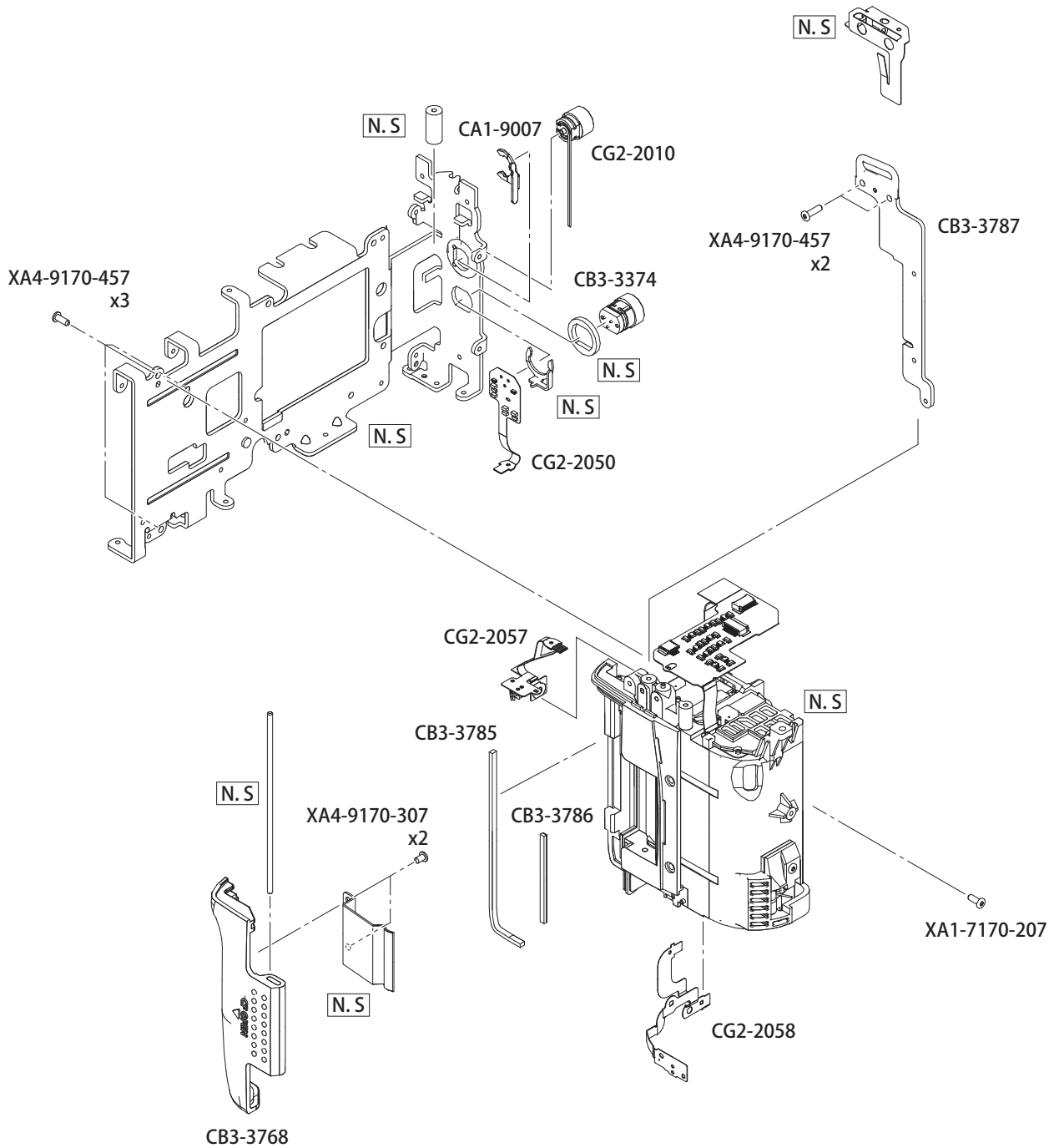

P A R T S L I S T

REF. NO. C12-6171

NEW	PARTS NO.	CLASS	QTY	DESCRIPTION
	CA1-9007-000 000	C	1	RING, PC RETAINER
	CB3-3374-000 000	C	1	JACK, REMOTE-CONTROL
*	CB3-3768-000 000	C	1	COVER, CF SLOT
*	CB3-3785-000 000	C	1	CUSHION, CF SLOT1
*	CB3-3786-000 000	C	1	CUSHION, CF SLOT2
*	CB3-3787-000 000	C	1	HOLDER, STRAP RIGHT
*	CG2-2010-000 000	B	1	TERMINAL ASS'Y, PC
*	CG2-2050-000 000	C	1	FPC ASS'Y, REMOTE CONTROL
*	CG2-2057-000 000	C	1	FPC ASS'Y, CF DOOR
*	CG2-2058-000 000	C	1	FPC ASS'Y, BATTERY COVER
	XA1-7170-207 000	F	1	SCREW, CROSS-RECESS, PH
	XA4-9170-307 000	F	2	SCREW, CROSS-RECESS, PH
	XA4-9170-457 000	F	5	SCREW, CROSS-RECESS, PH

CANON EOS 40D

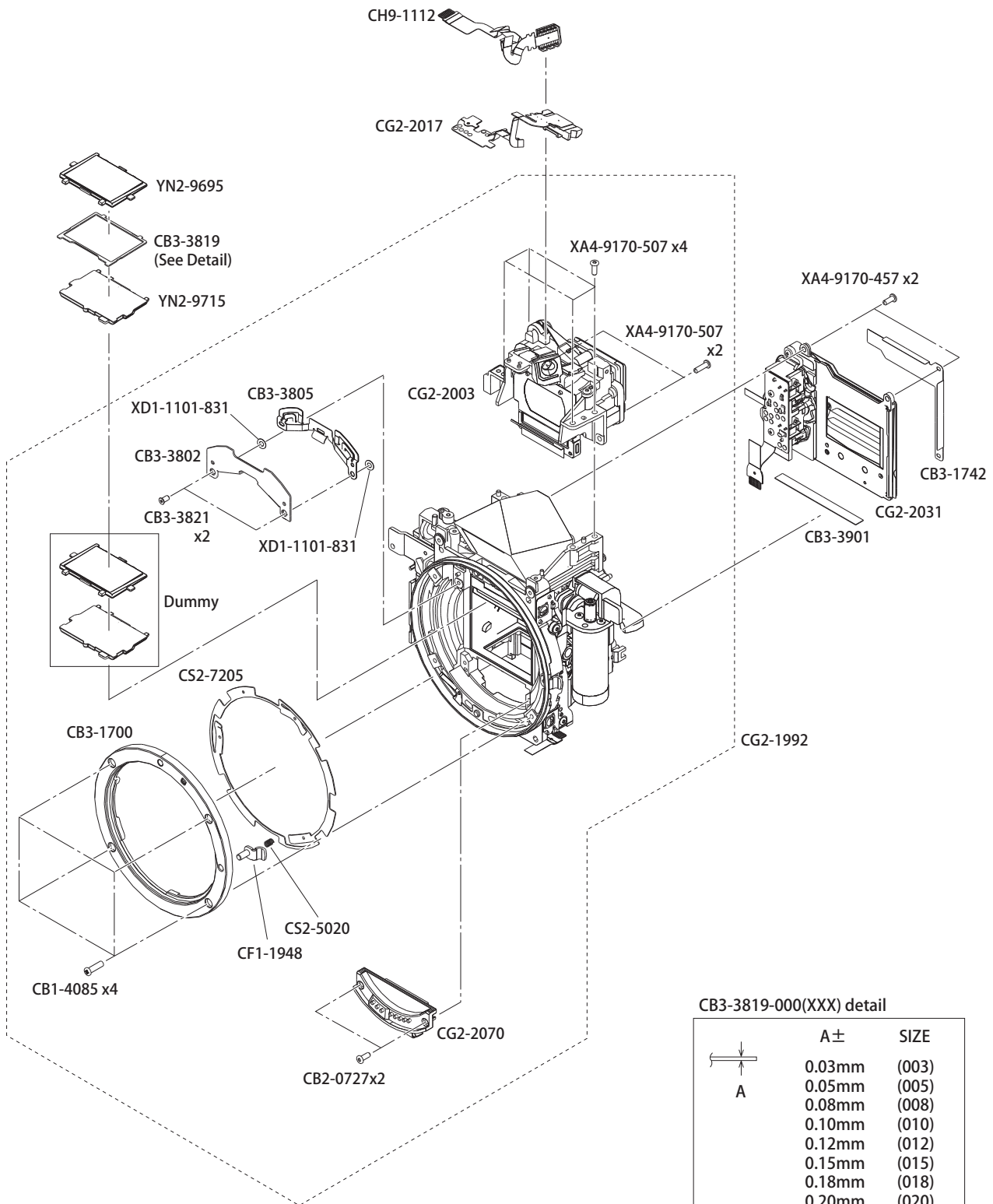

CB3-3819-000(XXX) detail

	A ±	SIZE
 A	0.03mm	(003)
	0.05mm	(005)
	0.08mm	(008)
	0.10mm	(010)
	0.12mm	(012)
	0.15mm	(015)
	0.18mm	(018)
	0.20mm	(020)
	0.25mm	(025)
	0.30mm	(030)
	0.35mm	(035)

P A R T S L I S T

REF. NO. C12-6171

NEW	PARTS NO.	CLASS	QTY	DESCRIPTION
	CB1-4085-000 000	C	4	SCREW, M2X6.5
	CB2-0727-000 000	C	2	SCREW, M1.7X4.5
	CB3-1700-000 000	C	1	MOUNT
	CB3-1742-000 000	C	1	SHEET, SHUTTER LIGHT SHIELD
*	CB3-3802-000 000	C	1	COVER, SCREEN RETAINER
*	CB3-3805-000 000	C	1	PLATE, SCREEN RETAINER
*	CB3-3819-000 (XXX)	C	1	WASHER, FINDER BACK ADJUST
*	CB3-3821-000 000	C	2	SCREW
*	CB3-3901-000 000	B	1	TAPE, DOUBLE SIDE
	CF1-1948-000 000	C	1	LENS LOCK PIN ASS'Y
*	CG2-1992-000 000	B	1	MIRROR BOX ASS'Y
*	CG2-2003-000 000	C	1	EYEPiece ASS'Y
*	CG2-2017-000 000	B	1	FPC ASS'Y, AE
*	CG2-2031-000 000	B	1	SHUTTER ASS'Y
*	CG2-2070-000 000	C	1	CONTACT ASS'Y, LENS
*	CH9-1112-000 000	C	1	FPC ASS'Y, SI
	CS2-5020-000 000	C	1	SPRING, COIL
	CS2-7205-000 000	C	1	SPRING, MOUNT
	XA4-9170-457 000	F	2	SCREW, CROSS-RECESS, PH
	XA4-9170-507 000	F	6	SCREW, CROSS-RECESS, PH
*	XD1-1101-831 000	F	2	WASHER
*	YN2-9695-000 000	C	1	PLATE, SI INDICATE
*	YN2-9715-000 000	B	1	PLATE, FOCUSING SCREEN

CANON EOS 40D

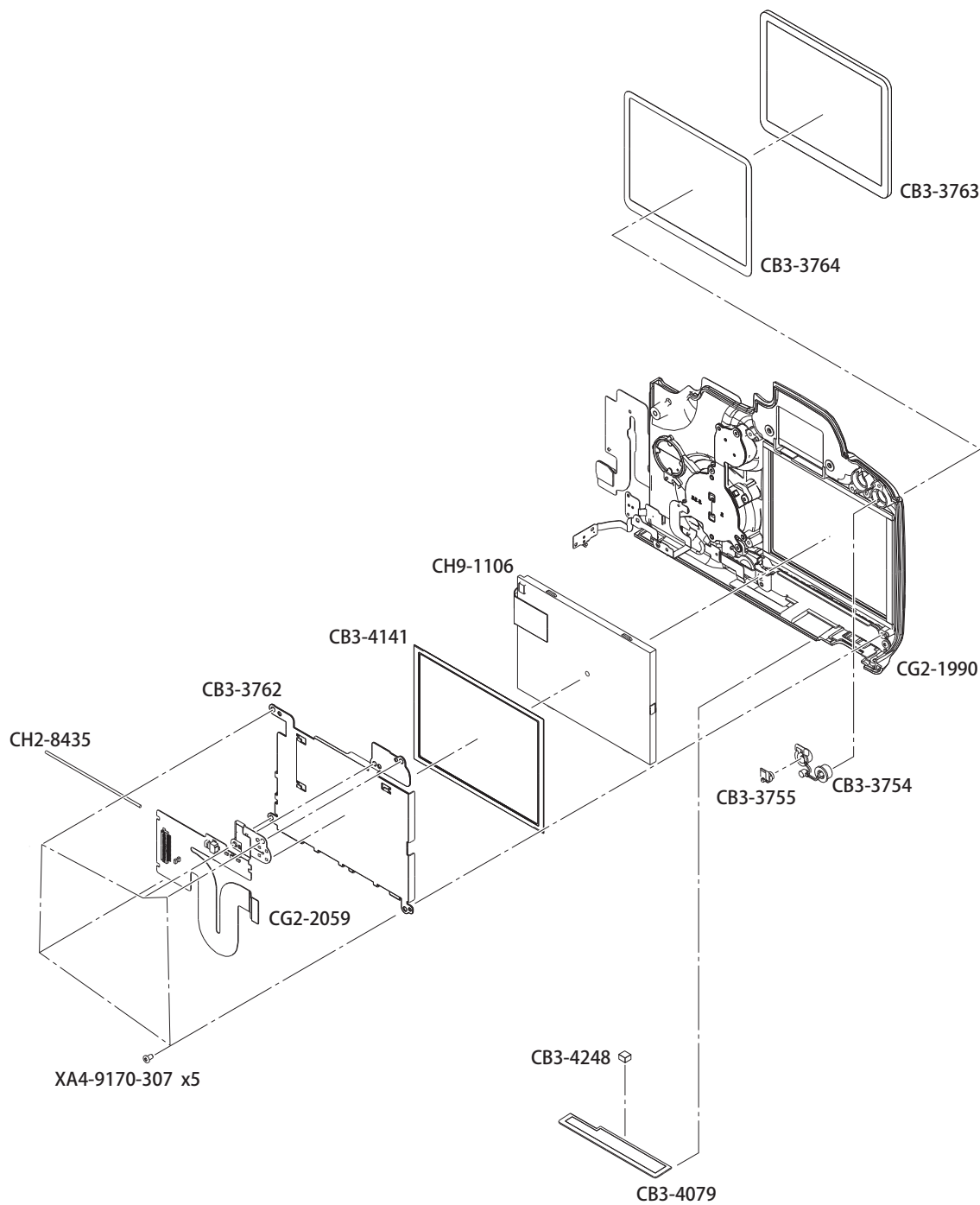

PARTS LIST

REF. NO. C12-6171

NEW	PARTS NO.	CLASS	QTY	DESCRIPTION
*	CB3-3754-000 000	C	1	BUTTON, MENU/PRINT
*	CB3-3755-000 000	C	1	BUTTON, PRINT
*	CB3-3762-000 000	C	1	HOLDER, TFT
*	CB3-3763-000 000	B	1	WINDOW, TFT DISPLAY
*	CB3-3764-000 000	B	1	TAPE, DOUBLE SIDE
* * * * *	CB3-4079-000 000	C	1	SHEET, BACK COVER
	CB3-4141-000 000	C	1	SHEET, TFT
	CB3-4248-000 000	C	1	GASKET
	CG2-1990-000 000	B	1	COVER ASS'Y, BACK
	CG2-2059-000 000	C	1	FPC ASS'Y, TFT
* * *	CH2-8435-000 000	C	1	WIRE, LEAD
	CH9-1106-000 000	B	1	LCD ASS'Y, TFT
	XA4-9170-307 000	F	5	SCREW, CROSS-RECESS, PH

CANON EOS 40D

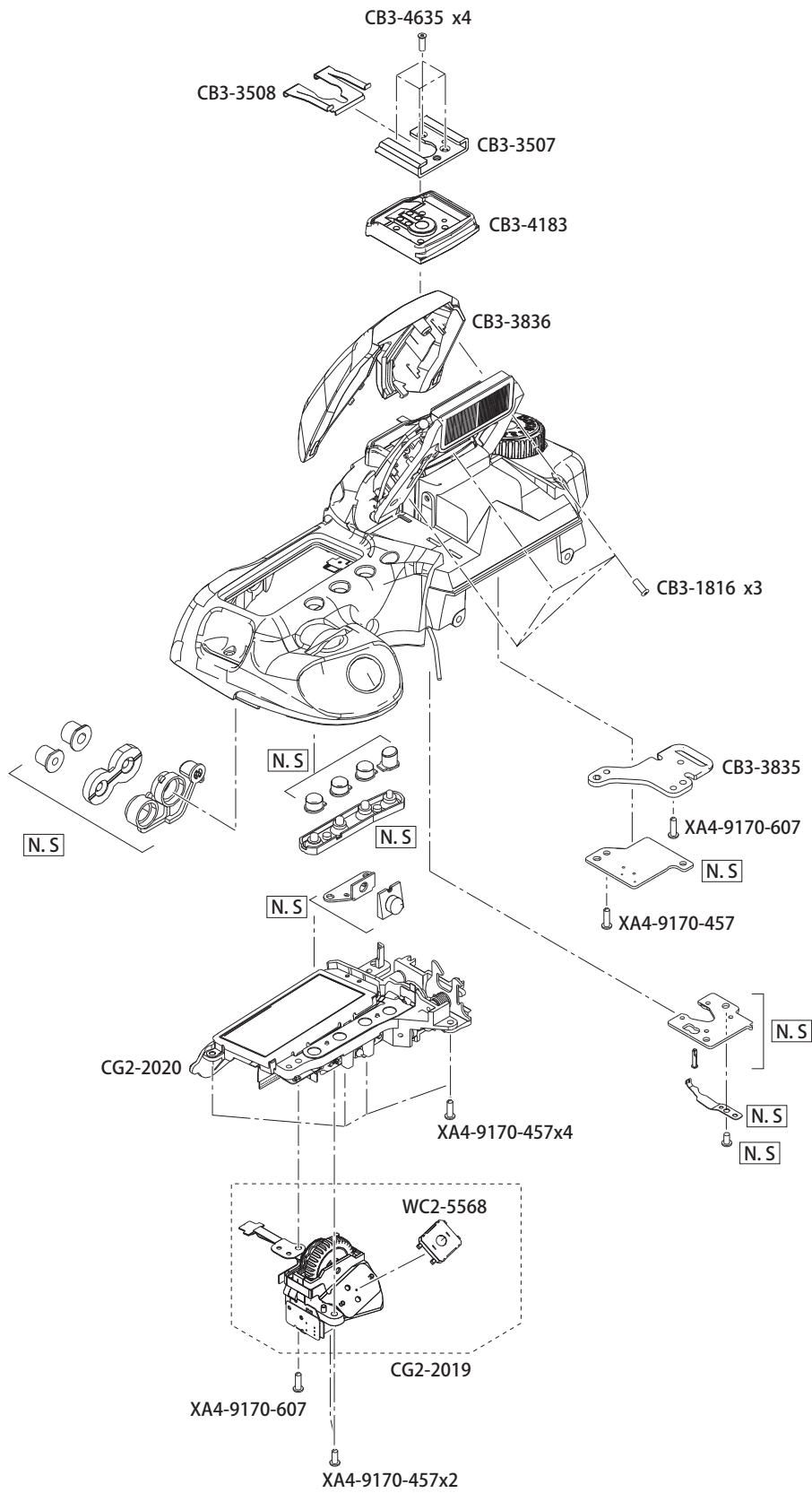

P A R T S L I S T

REF. NO. C12-6171

NEW	PARTS NO.	CLASS	QTY	DESCRIPTION
	CB3-1816-000 000	F	3	SCREW
	CB3-3507-000 000	C	1	SHOE, ACCESSORY
	CB3-3508-000 000	C	1	SPRING, ACC.SHOE PLATE
*	CB3-3835-000 000	C	1	HOLDER, STRAP LEFT
*	CB3-3836-000 000	C	1	COVER, FLASH
*	CB3-4183-000 000	C	1	BASE, ACC.SHOE CONTACT
*	CB3-4635-000 000	C	4	SCREW, M1.7X5.2
*	CG2-2019-000 000	C	1	DIAL ASS'Y
*	CG2-2020-000 000	C	1	LCD ASS'Y, OUTSIDE
	WC2-5568-000 000	B	1	SWITCH, RELEASE (MECH)
	XA4-9170-457 000	F	7	SCREW, CROSS-RECESS, PH
	XA4-9170-607 000	F	2	SCREW, CROSS-RECESS, PH

Accessories

Wide Strap EW-100DGR

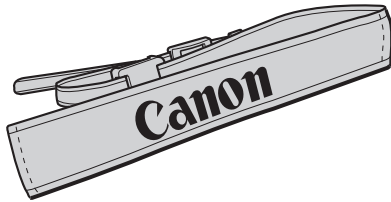

N.S (Product Available)

**Battery Pack 511A
(BP-514/BP-511/BP-512)**

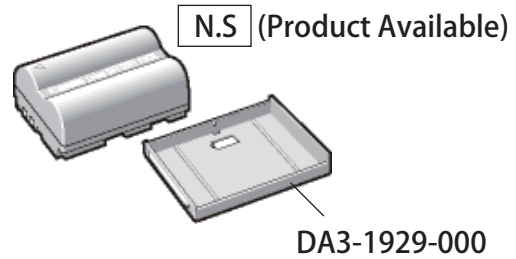

Battery Charger CG-580

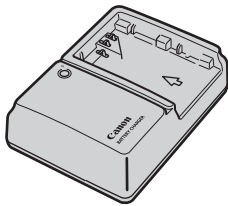

N.S (Product Available)

**Interface Cable
IFC-200 U**



N.S (Product Available)

Battery Charger CB-5L

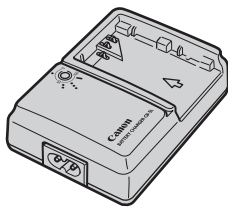

N.S (Product Available)

Video Cable VC-100

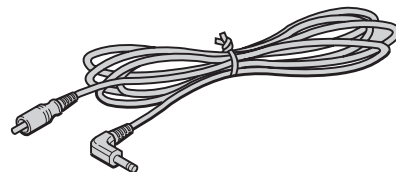

N.S (Product Available)

AC POWER CABLE

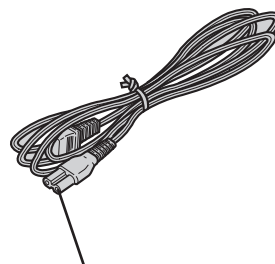

D82-0643(EUROPE)
D82-0645-001(AUSTRALIA)
C50-8221(CHINA)

PARTS LIST

REF. NO. C12-6171

AC POWER CABLE

NEW	PARTS NO.	CLASS	QTY	DESCRIPTION
	D82-0643-000 000	C	1	CABLE, AC, EUROPE
	D82-0645-001 000	A	1	CABLE, AC, AUSTRALIA
	C50-8221-000 000	C	1	CABLE, AC, CHINA

BATTERY PACKBP-511A

NEW	PARTS NO.	CLASS	QTY	DESCRIPTION
	DA3-1929-000 000	C	1	COVER, TERMINAL BP-514/BP-511A

INDEX OF PARTS LIST

NEW	PARTS NO.	PAGE	NEW	PARTS NO.	PAGE
	C50-8221-000 000	11	*	CB3-3821-000 000	8
	CA1-9007-000 000	7	*	CB3-3822-000 000	4
	CB1-4085-000 000	8	*	CB3-3835-000 000	10
	CB2-0682-000 (XXX)	5	*	CB3-3836-000 000	10
	CB2-0726-000 000	2	*	CB3-3846-000 000	3
	CB2-0726-000 000	3	*	CB3-3863-000 000	4
	CB2-0727-000 000	2	*	CB3-3901-000 000	8
	CB2-0727-000 000	8	*	CB3-3931-000 000	5
	CB3-1700-000 000	8	*	CB3-3941-000 000	5
	CB3-1742-000 000	8	*	CB3-3942-000 000	4
	CB3-1816-000 000	10	*	CB3-3943-000 000	4
	CB3-2808-000 000	4	*	CB3-3944-000 000	4
	CB3-3374-000 000	7	*	CB3-3972-000 000	1
	CB3-3507-000 000	10	*	CB3-3974-000 000	2
	CB3-3508-000 000	10	*	CB3-3975-000 000	1
*	CB3-3744-000 000	1	*	CB3-3976-000 000	1
*	CB3-3745-000 000	1	*	CB3-3977-000 000	1
*	CB3-3748-000 000	1	*	CB3-3978-000 000	1
*	CB3-3749-000 000	1	*	CB3-3980-000 000	1
*	CB3-3754-000 000	9	*	CB3-4079-000 000	9
*	CB3-3755-000 000	9	*	CB3-4132-000 000	6
*	CB3-3762-000 000	9	*	CB3-4141-000 000	9
*	CB3-3763-000 000	9	*	CB3-4148-000 000	2
*	CB3-3764-000 000	9	*	CB3-4149-000 000	2
*	CB3-3768-000 000	7	*	CB3-4164-000 000	1
*	CB3-3769-000 000	1	*	CB3-4175-000 000	1
*	CB3-3785-000 000	7	*	CB3-4183-000 000	10
*	CB3-3786-000 000	7	*	CB3-4248-000 000	9
*	CB3-3787-000 000	7	*	CB3-4635-000 000	10
*	CB3-3795-000 000	3		CB4-0038-000 000	3
*	CB3-3796-000 000	3		CF1-1948-000 000	8
*	CB3-3802-000 000	8	*	CG2-1990-000 000	9
*	CB3-3805-000 000	8	*	CG2-1992-000 000	8
*	CB3-3809-000 000	6	*	CG2-2003-000 000	8
*	CB3-3819-000 (XXX)	8	*	CG2-2008-000 000	6

INDEX OF PARTS LIST

REF. NO. C12-6171

NEW	PARTS NO.	PAGE	NEW	PARTS NO.	PAGE
*	CG2-2010-000 000	7		XA1-7170-307 000	4, 5, 6
*	CG2-2011-000 000	6		XA1-7170-357 000	2
*	CG2-2012-000 000	5		XA1-7170-507 000	1, 2
*	CG2-2014-000 000	4		XA4-9170-307 000	7, 9
*	CG2-2015-000 000	4		XA4-9170-359 000	6
*	CG2-2016-000 000	3		XA4-9170-457 000	2, 3, 4, 5, 6, 7, 8, 10
*	CG2-2017-000 000	8		XA4-9170-507 000	8
*	CG2-2018-000 000	3		XA4-9170-607 000	3, 10
*	CG2-2019-000 000	10		XA4-9200-457 000	4
*	CG2-2020-000 000	10	*	XD1-1101-831 000	8
*	CG2-2023-000 000	2		XD1-1102-120 000	4
*	CG2-2024-000 000	1	*	YN2-9695-000 000	8
*	CG2-2031-000 000	8	*	YN2-9715-000 000	8
*	CG2-2046-000 000	4			
*	CG2-2050-000 000	7			
*	CG2-2057-000 000	7			
*	CG2-2058-000 000	7			
*	CG2-2059-000 000	9			
*	CG2-2070-000 000	8			
*	CH1-8495-000 000	5			
*	CH1-8517-000 000	4			
*	CH2-8435-000 000	9			
*	CH2-8439-000 000	6			
*	CH2-8440-000 000	6			
	CH9-1106-000 000	9			
*	CH9-1112-000 000	8			
	CS2-5020-000 000	8			
	CS2-7205-000 000	8			
*	CY3-1576-000 000	5			
*	CY3-1577-000 000	3			
	D82-0643-000 000	11			
	D82-0645-001 000	11			
	DA3-1929-000 000	11			
	WC2-5568-000 000	10			
	XA1-7170-207 000	5, 7			

Circuit Diagrams

Trademarks

The product names and company names described in this Service Manual are the registered trademarks of the individual companies.

Copyright

Canon Inc. retains the copyright to this Service Manual. Reproduction, publication (including on the World Wide Web), alteration, translation into another language, or other use of the data in whole or part, contained on this Service Manual without the written consent of Canon Inc. is prohibited.

CONTENTS

Circuit Diagrams

1. WIRING DIAGRAM
 - LEADWIRE LAYOUT
2. BLOCK DIAGRAM
 - 2-1 GENERAL
 - 2-2 POWER SUPPLY
3. PCB DIAGRAM
 - 3-1 BTM PCB
 - 3-2 DCDC PCB
 - 3-3 MAIN PCB
 - 3-4 STBM PCB
 - 3-5 AE FPC
 - 3-6 AF FPC
 - 3-7 ASW FPC
 - 3-8 BACK FPC
 - 3-9 BATSW FPC
 - 3-10 BM FPC
 - 3-11 BSW FCP
 - 3-12 CFSW FPC
 - 3-13 DCDC FPC
 - 3-14 ILC FPC
 - 3-15 IMG-B FPC
 - 3-16 IMG-T FPC
 - 3-17 MIF FPC
 - 3-18 MMC FPC
 - 3-19 OLC FPC
 - 3-20 RELAY FPC
 - 3-21 RLS FPC
 - 3-22 RMCN FPC
 - 3-23 SH FPC
 - 3-24 SI FPC
 - 3-25 SMC FPC
 - 3-26 TFT-D FPC
 - 3-27 TOP FPC

1. WIRING DIAGRAM
LEADWIRE LAYOUT

REF. NO. C12-6171

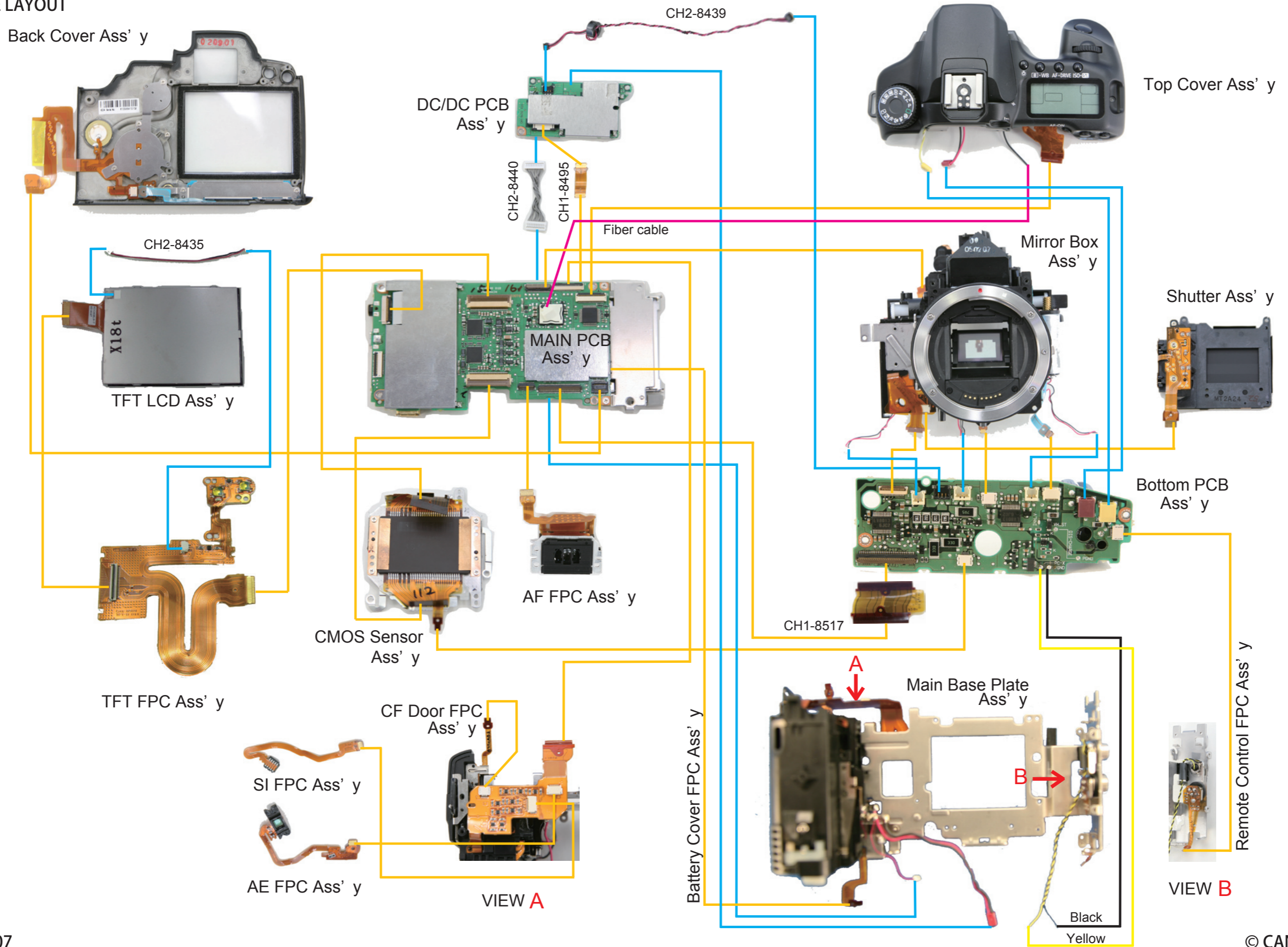

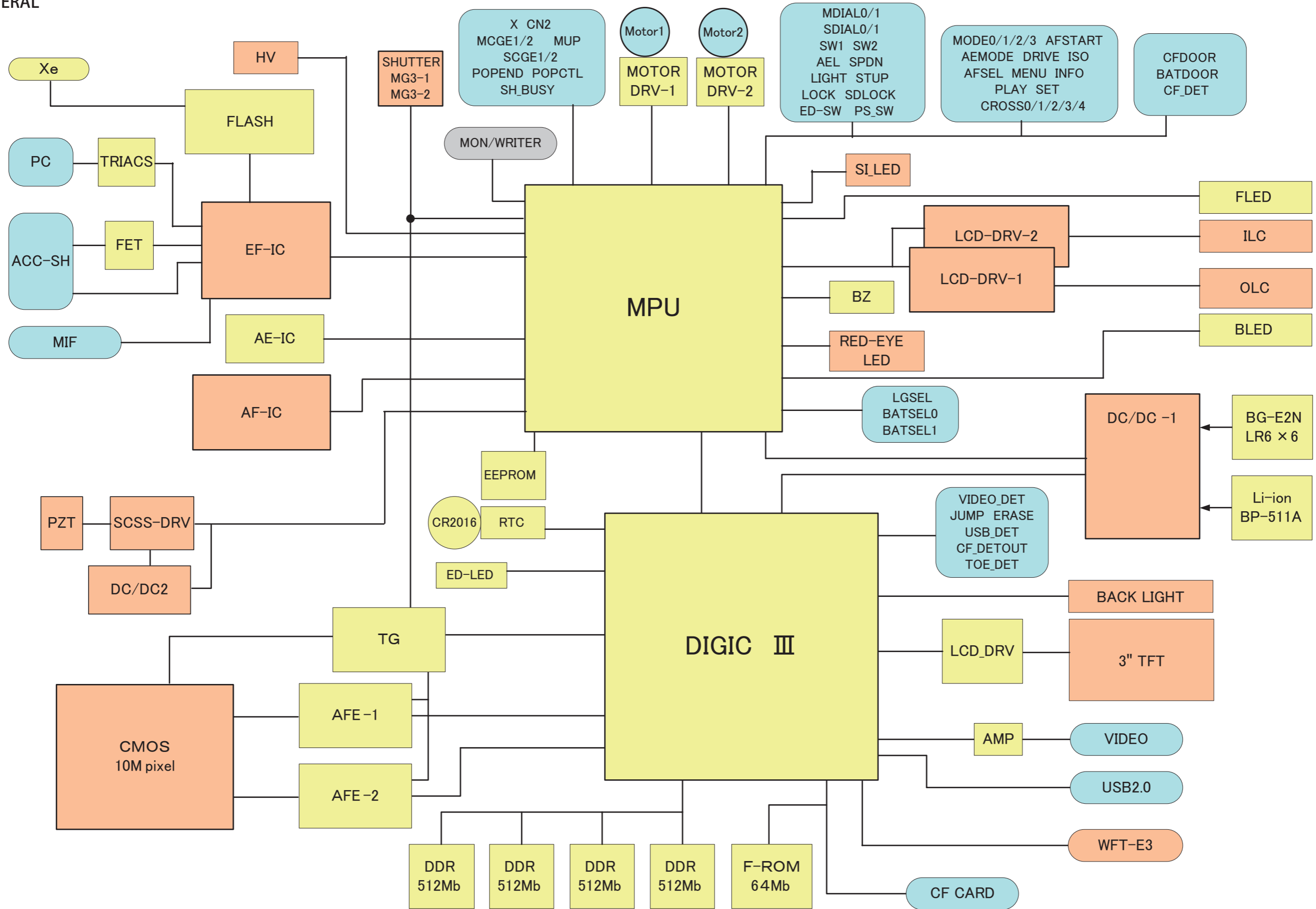

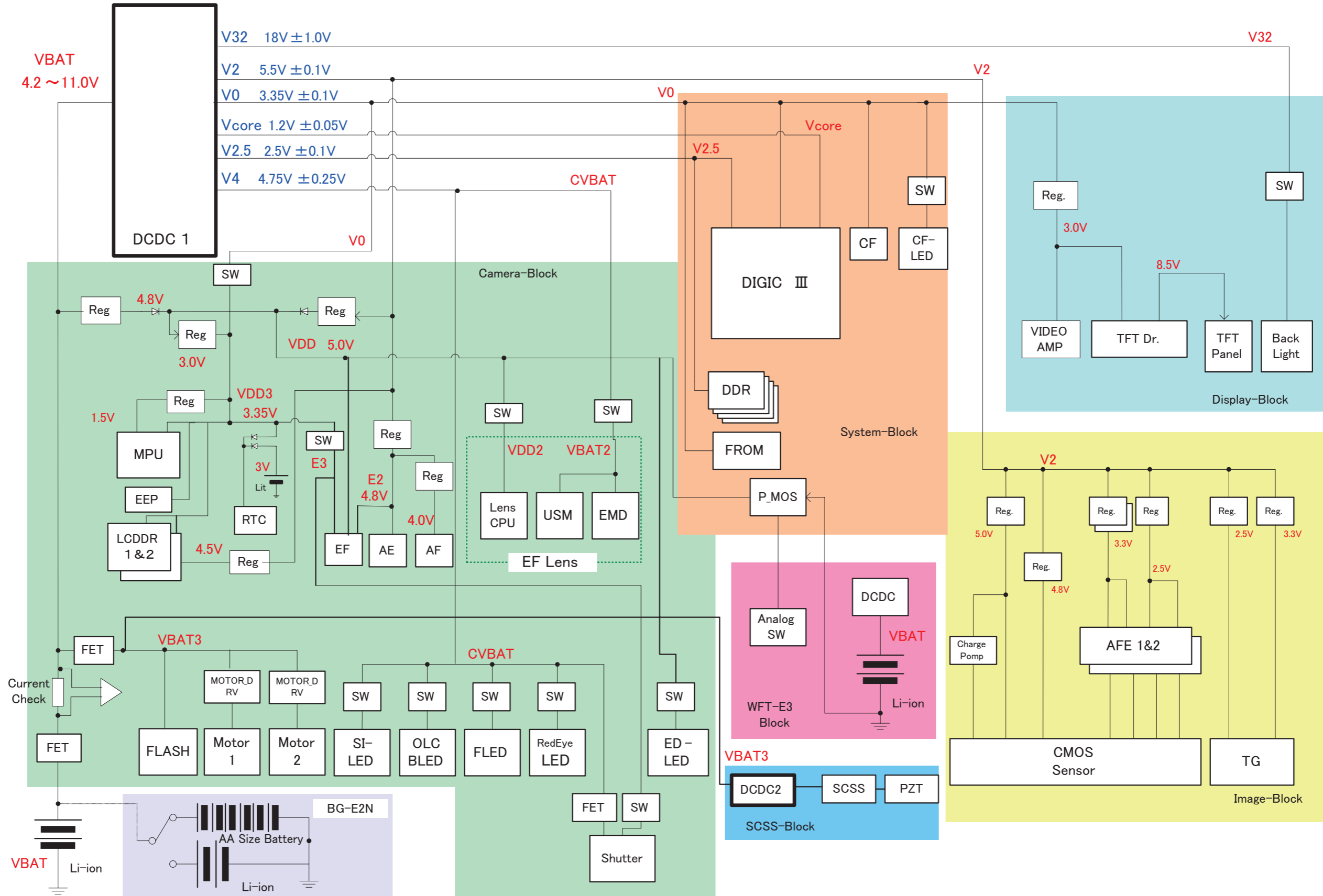

SIDE A

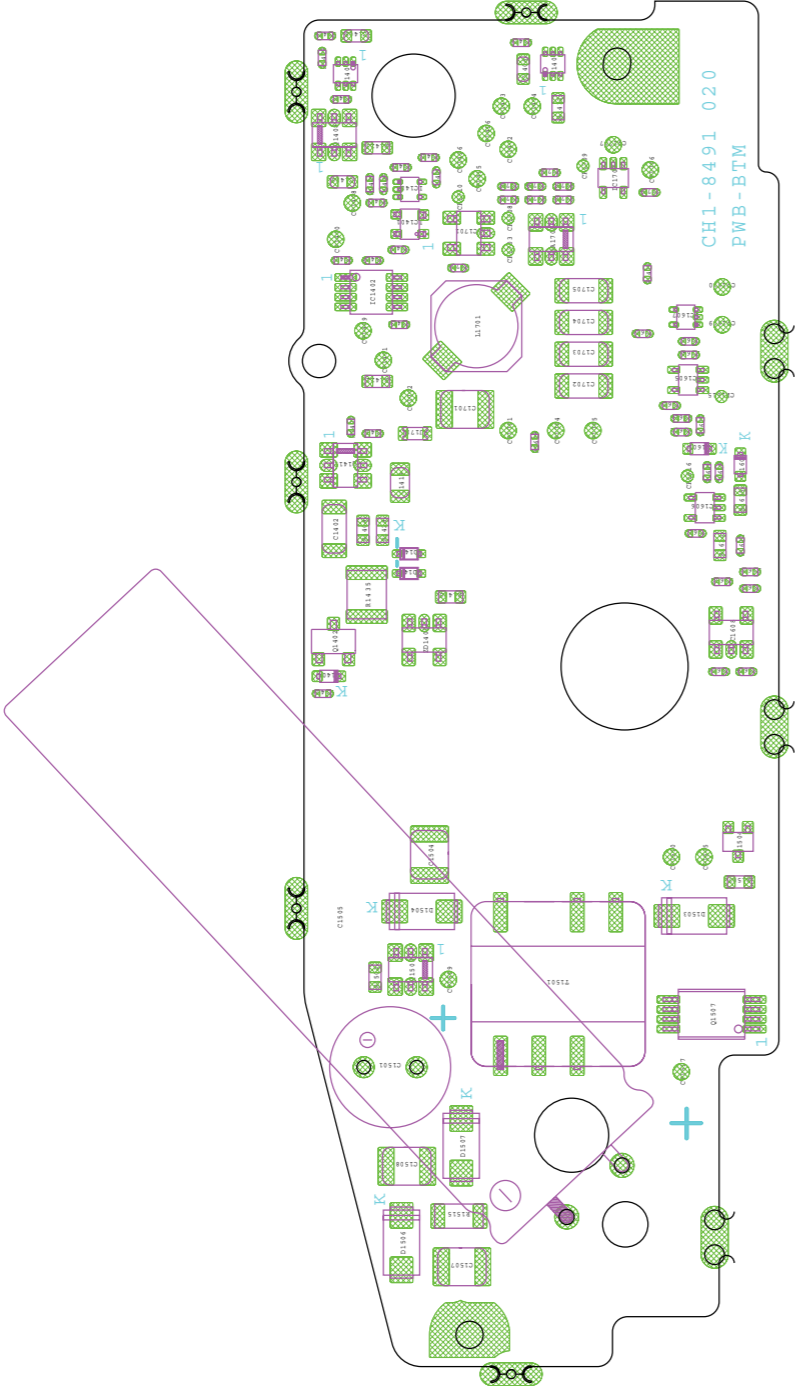

SIDE B

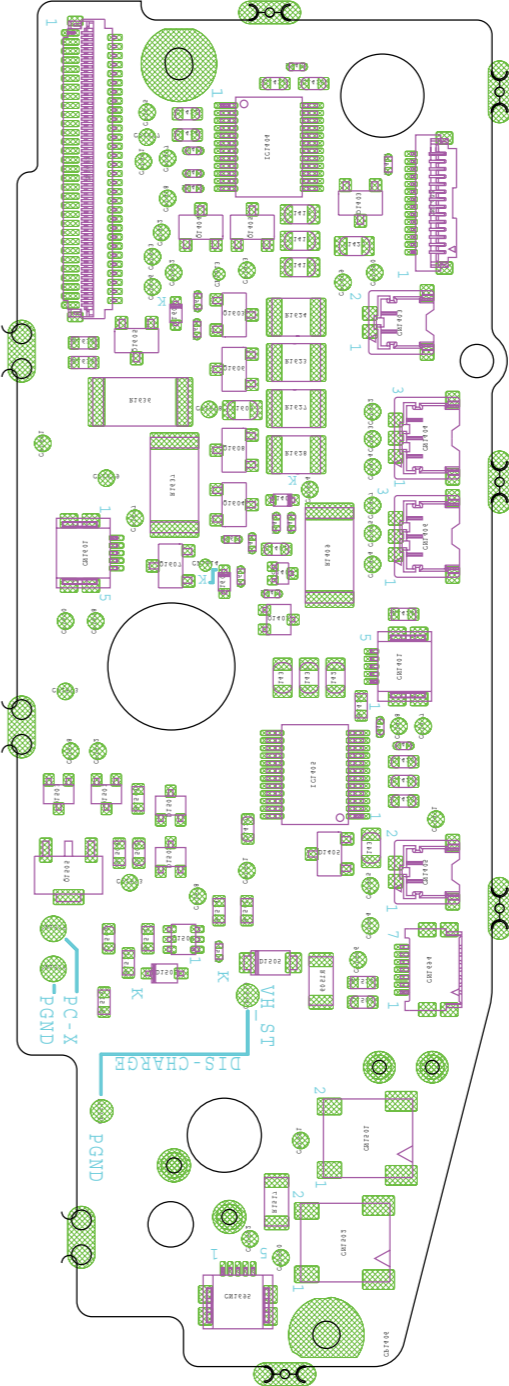

SIDE A

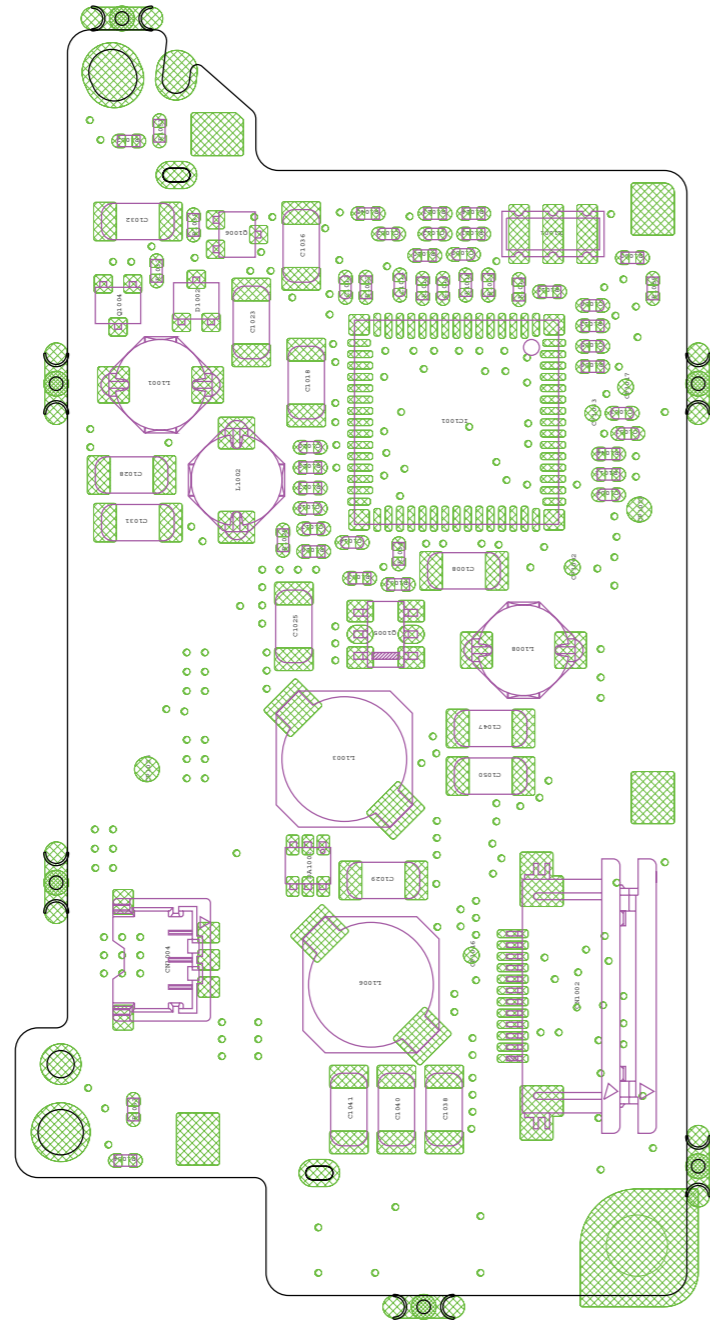

SIDE B

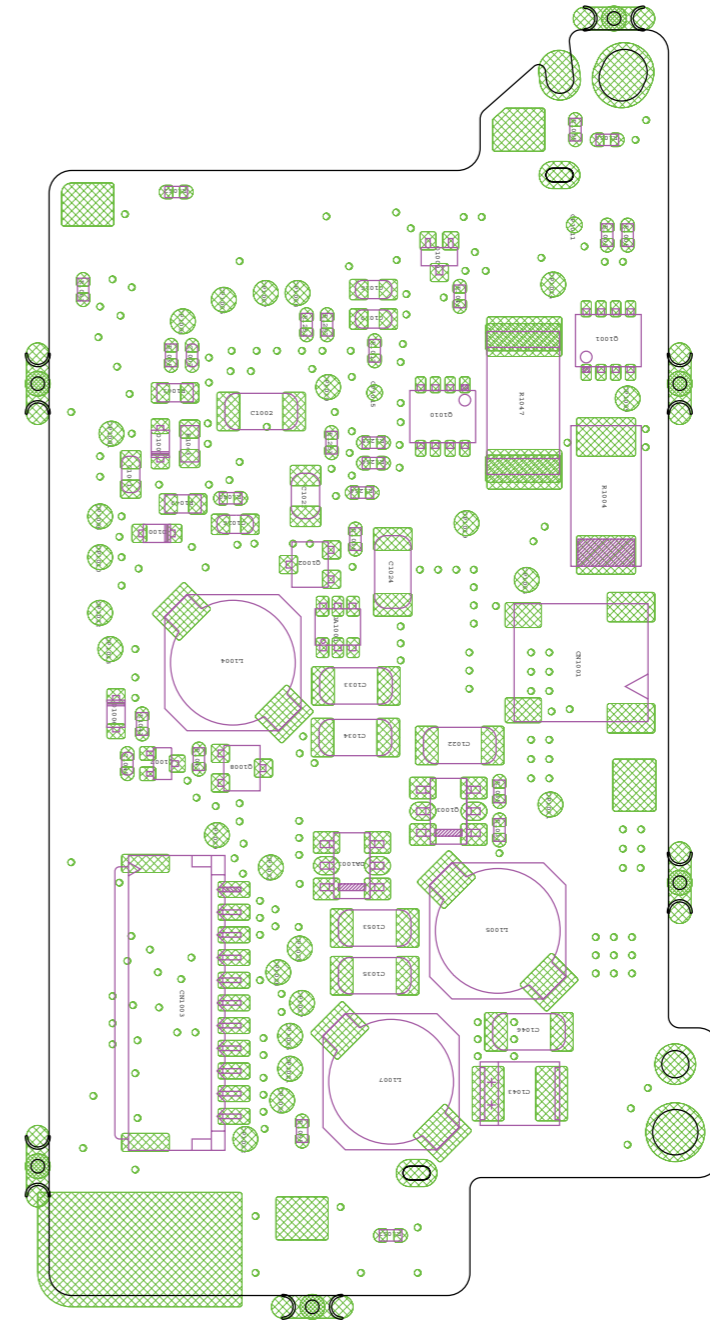

SIDE A

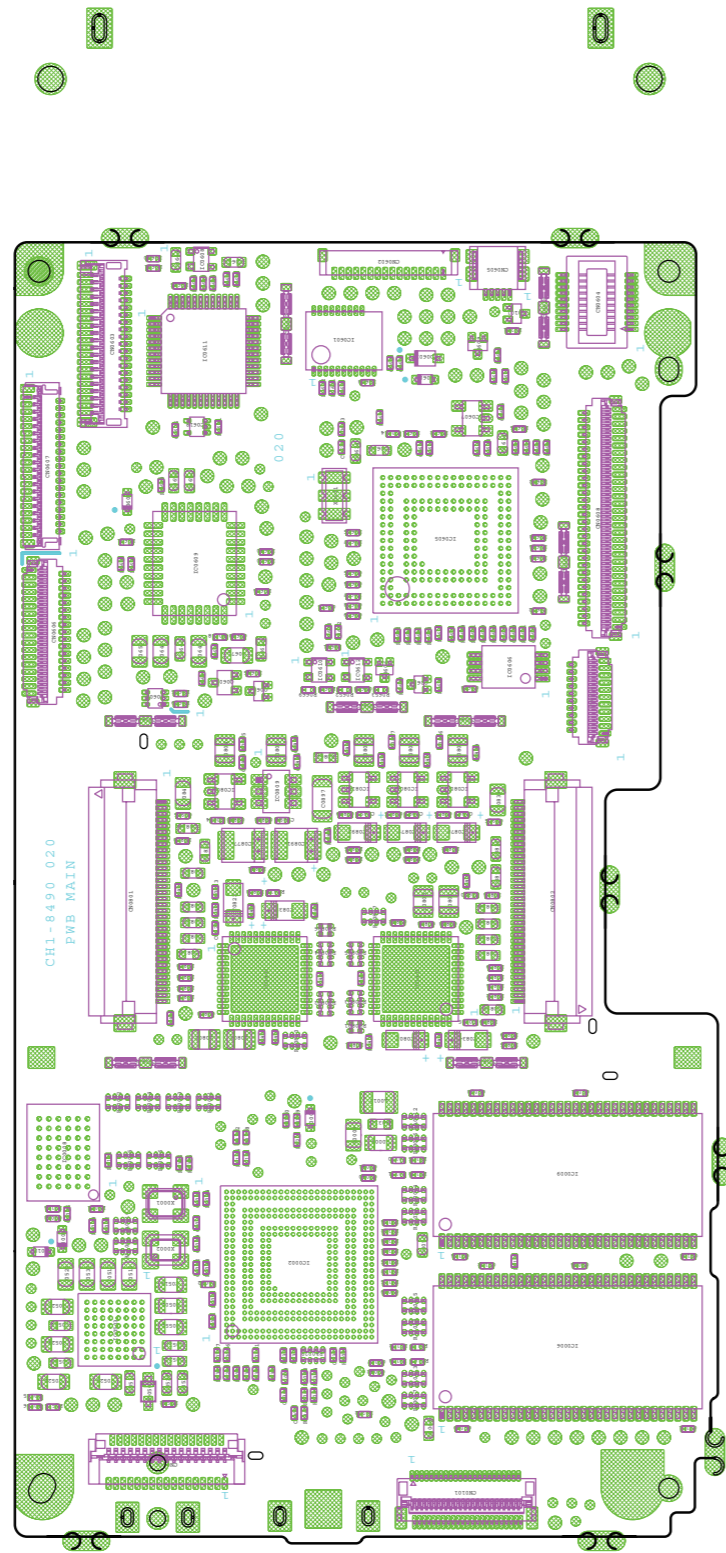

SIDE B

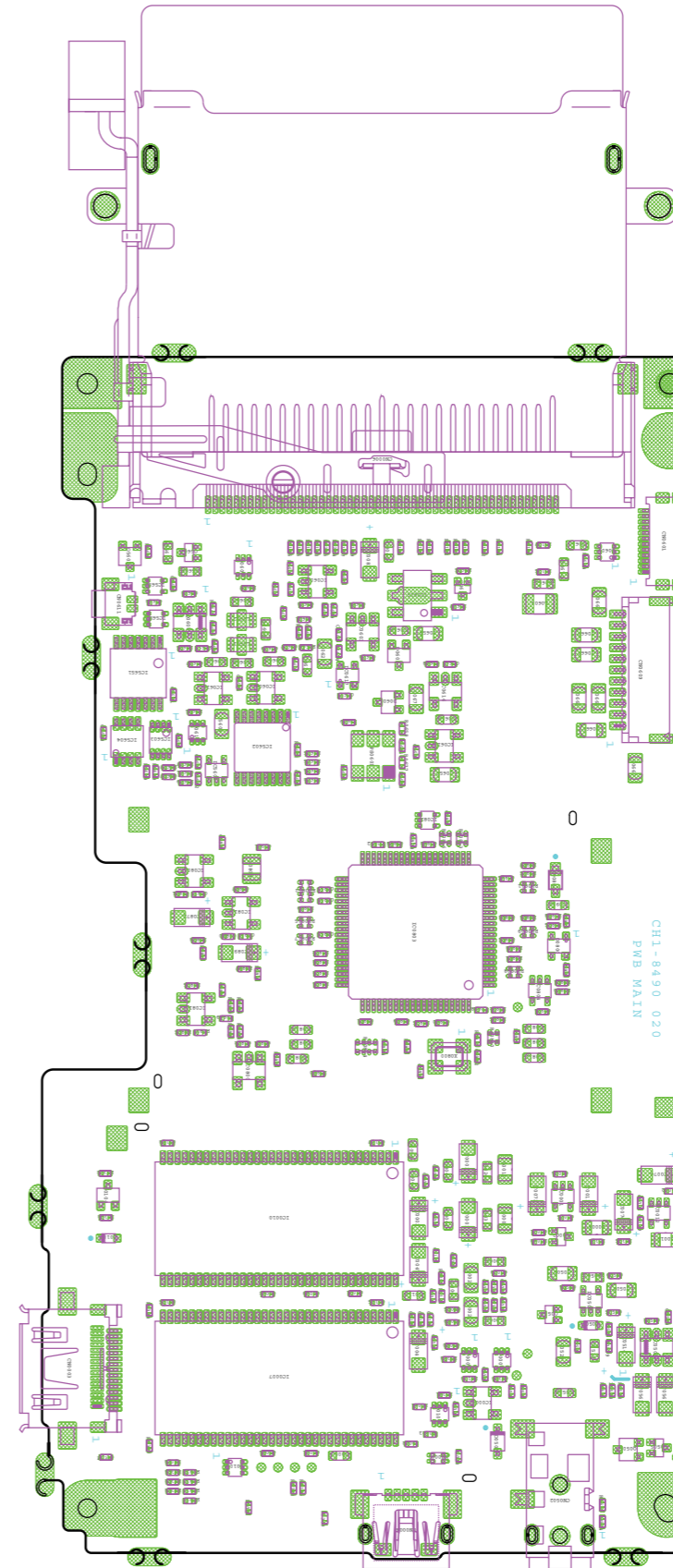

SIDE A

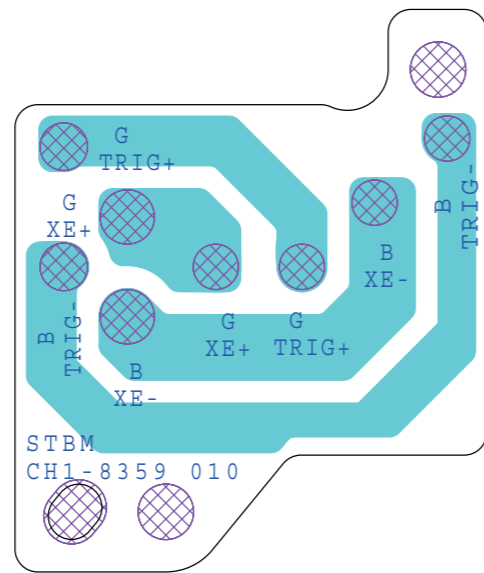

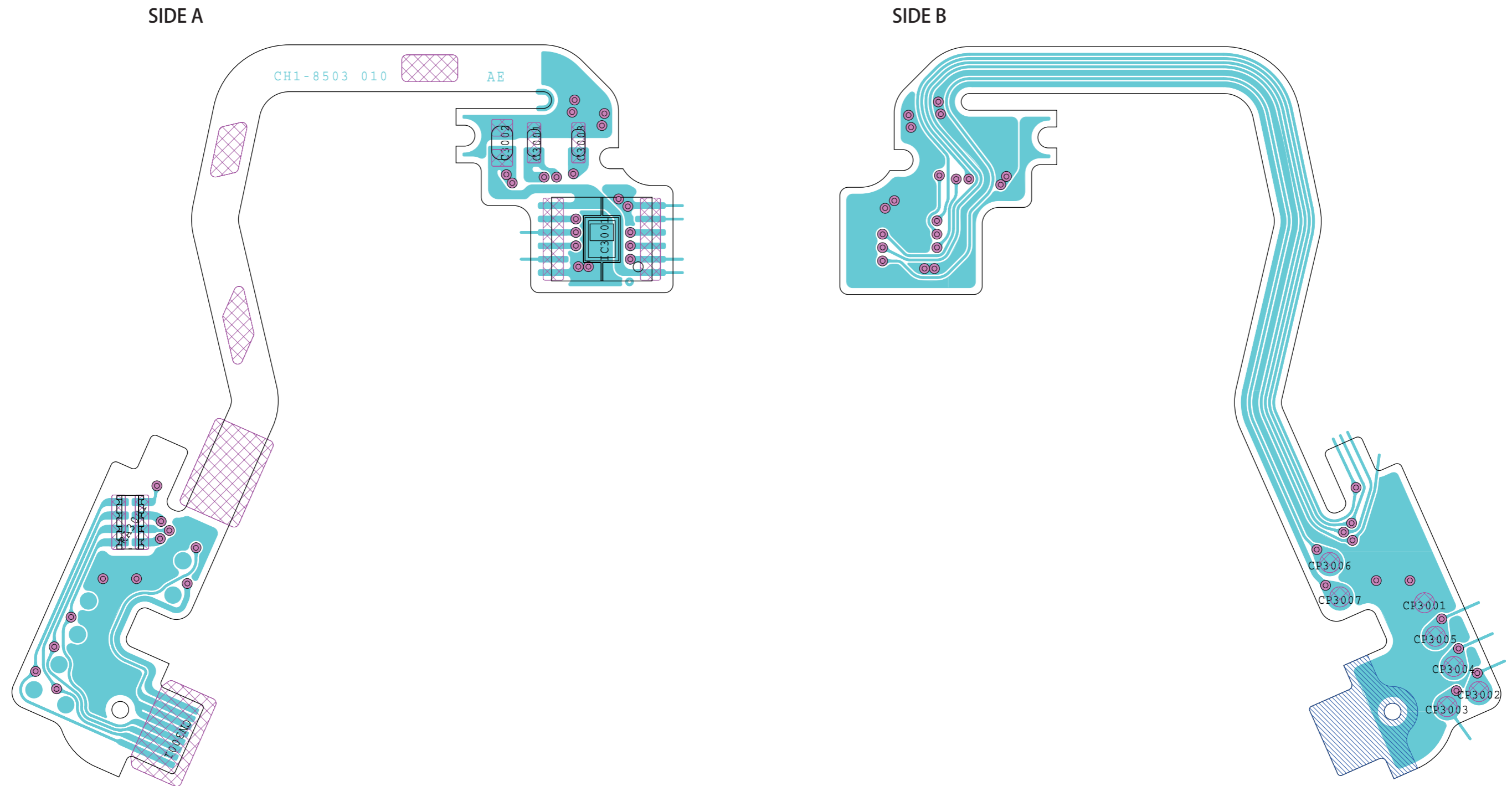

SIDE A

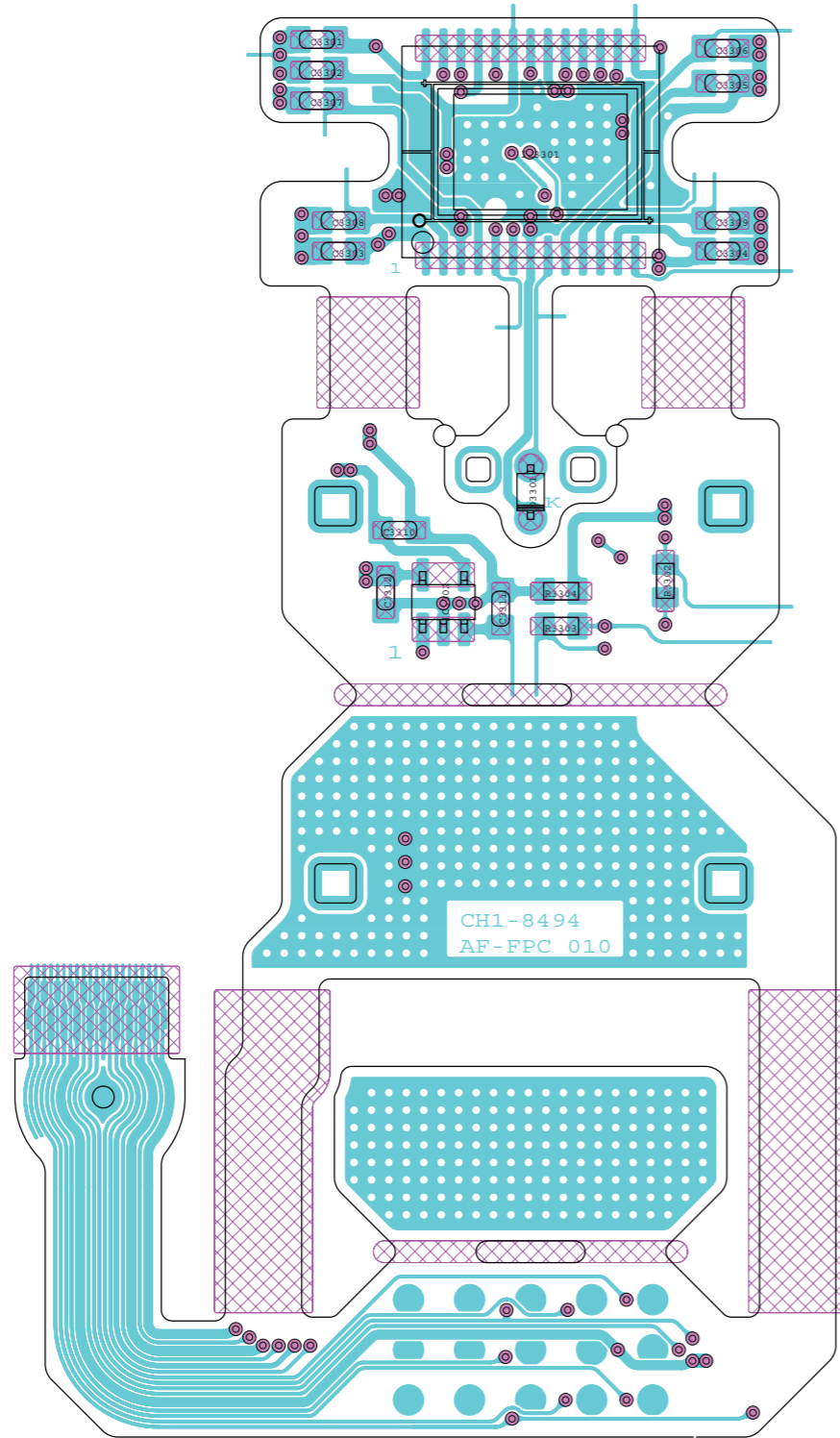

SIDE B

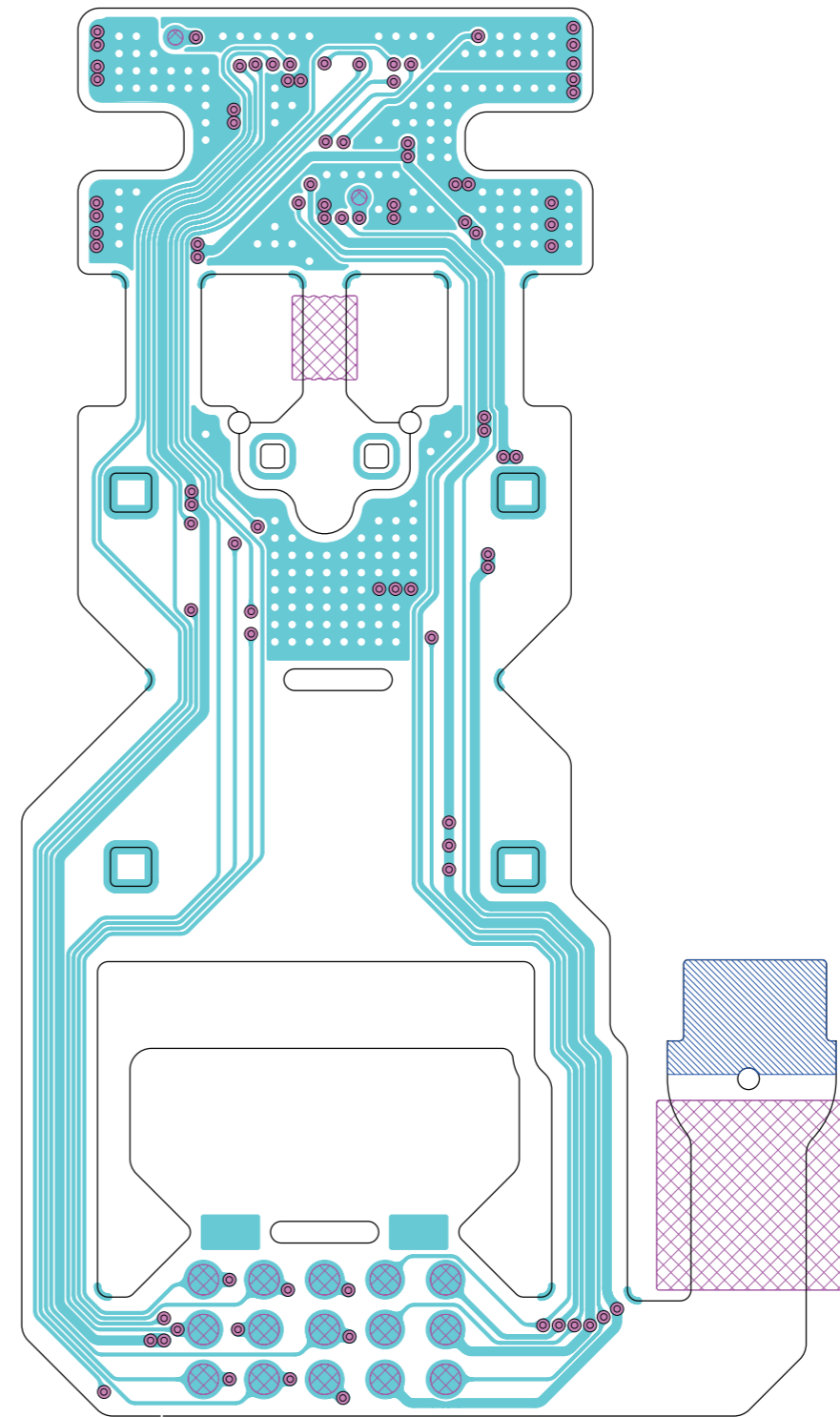

SIDE A

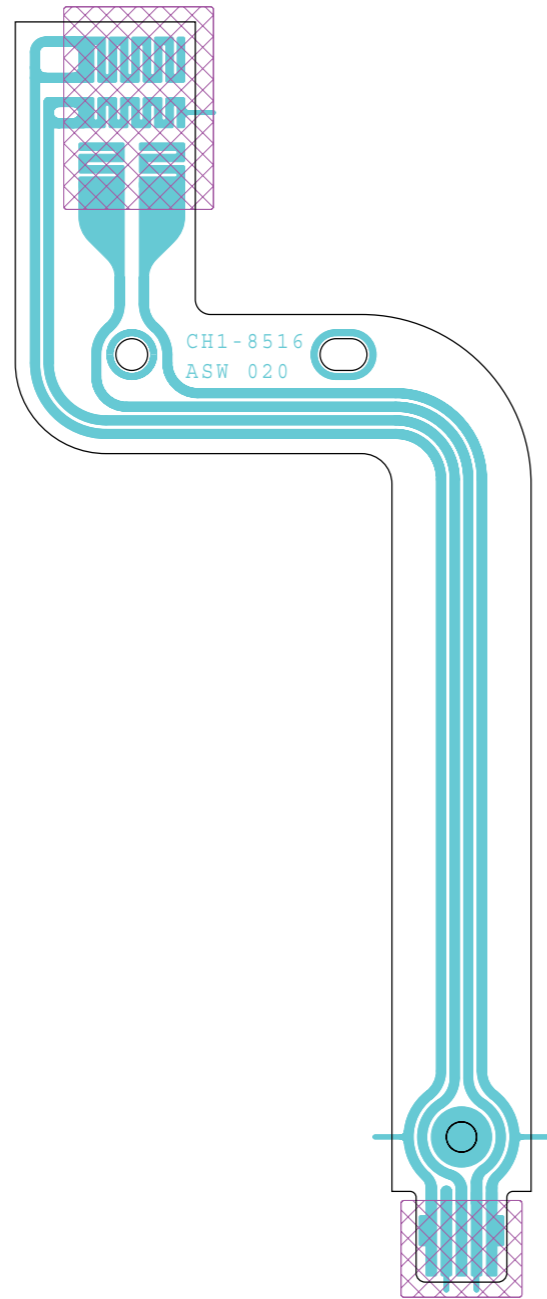

SIDE B

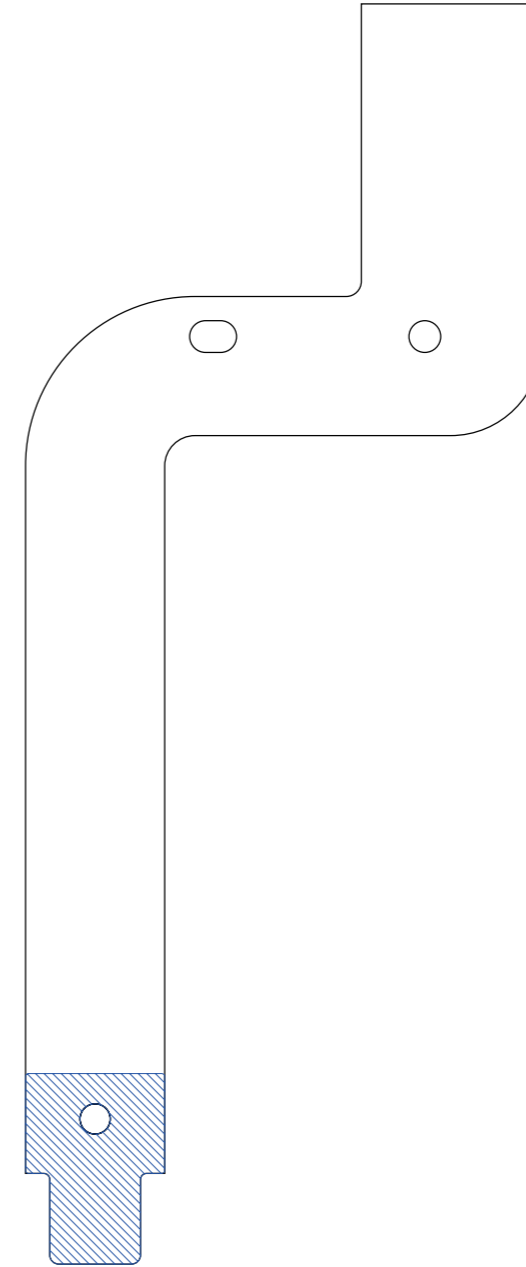

SIDE A

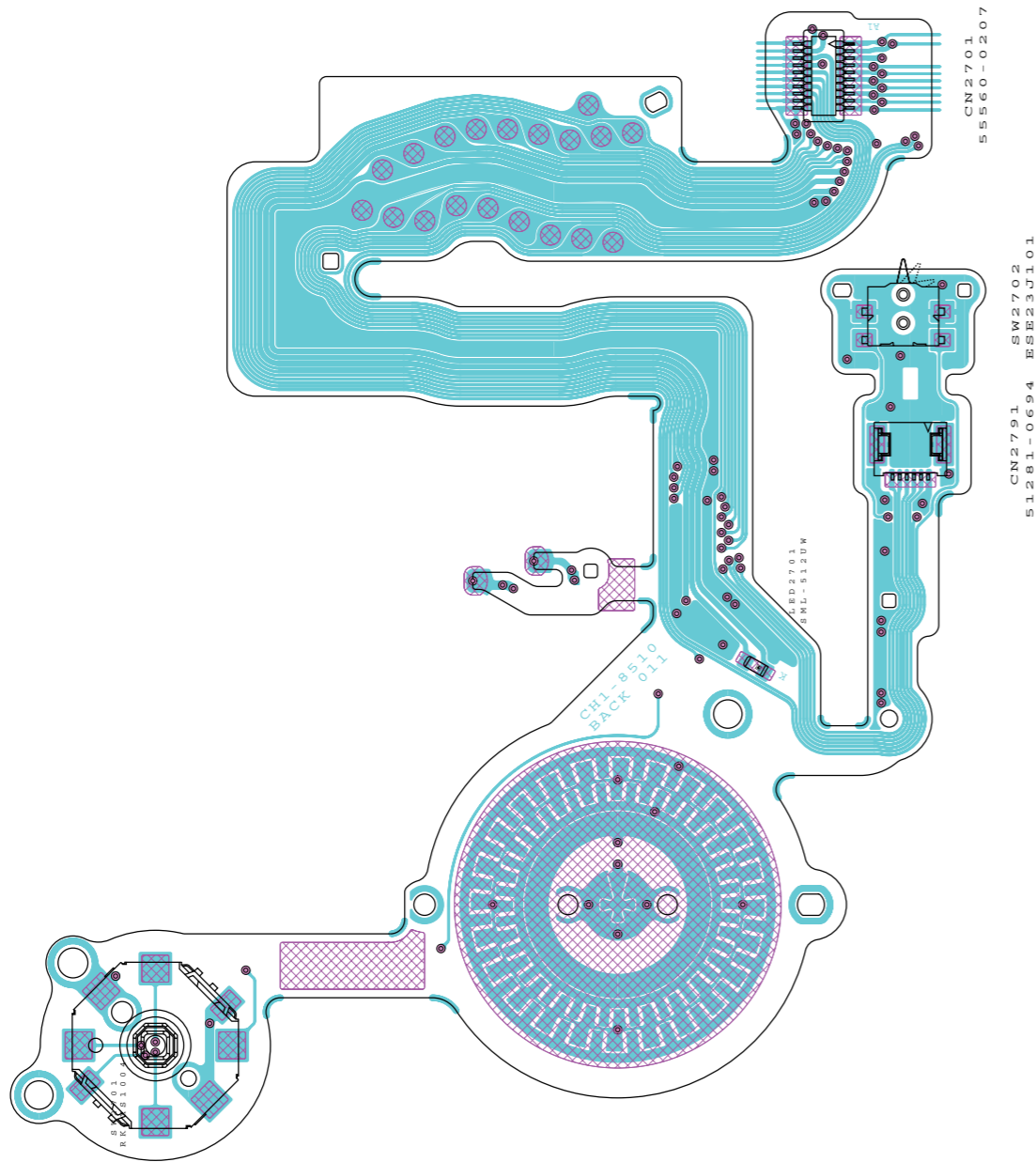

SIDE B

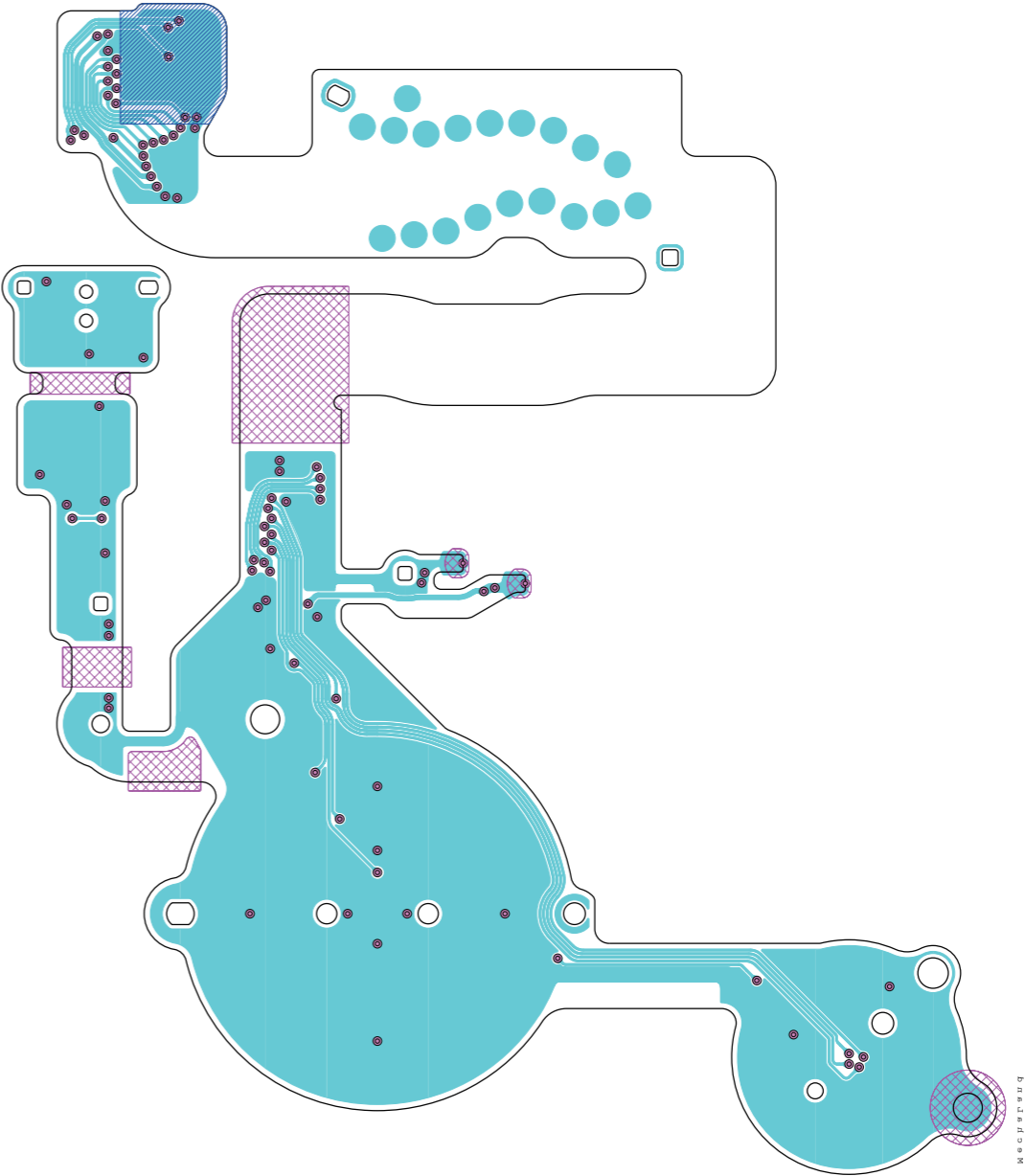

SIDE A

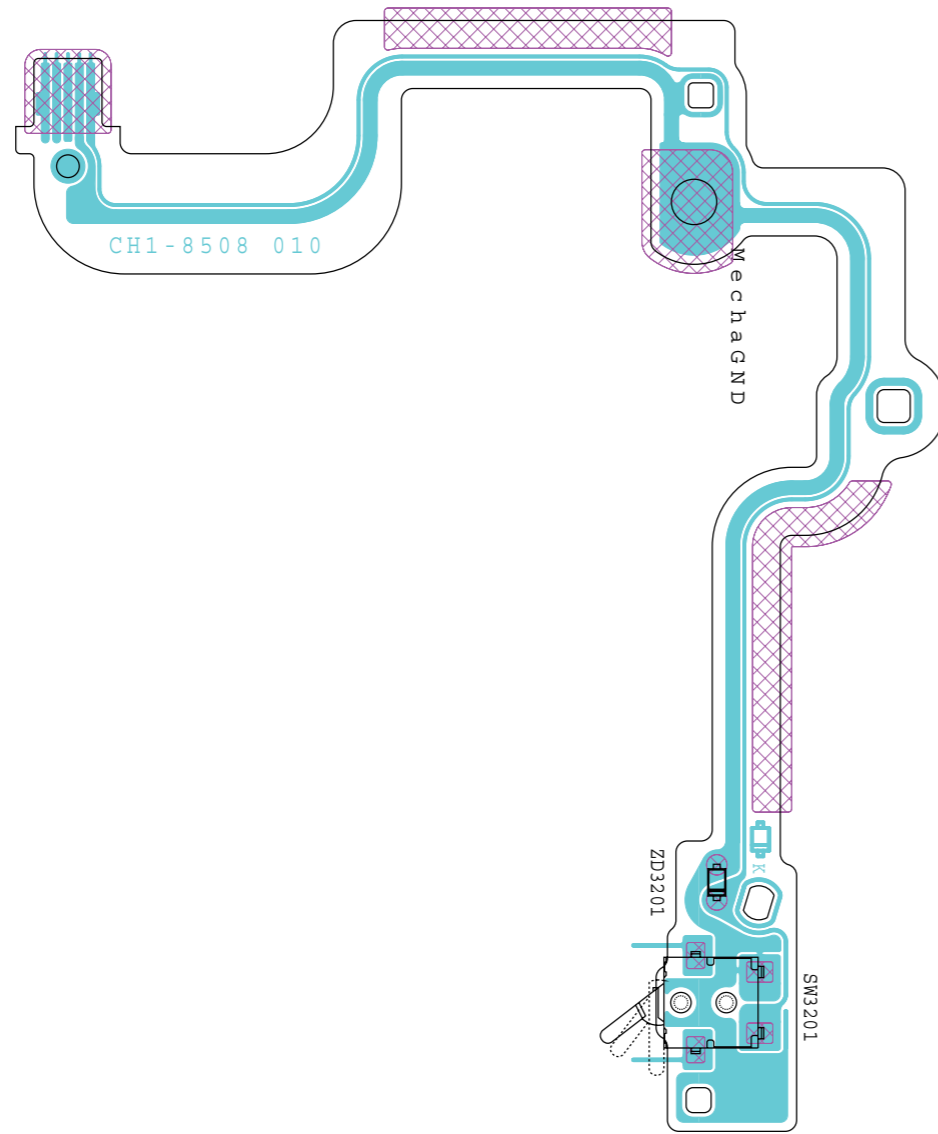

SIDE B

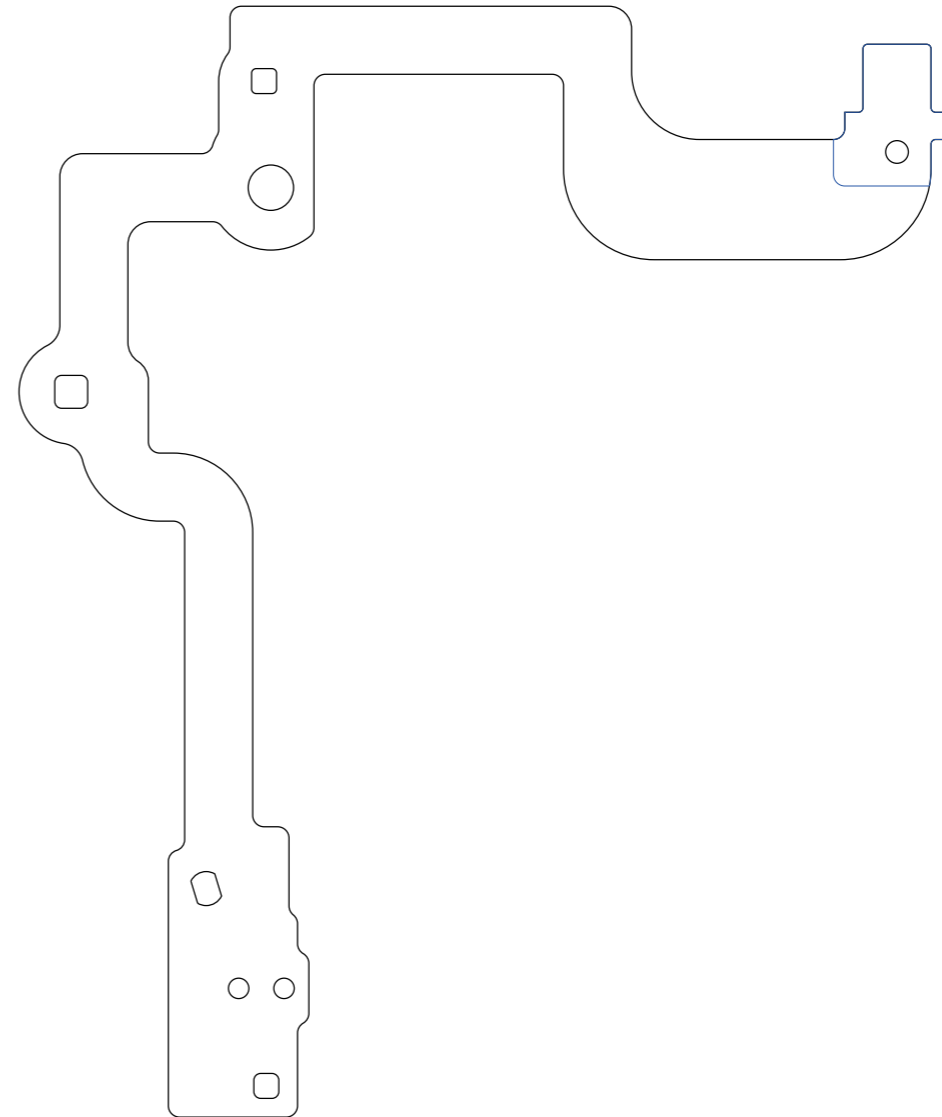

SIDE A

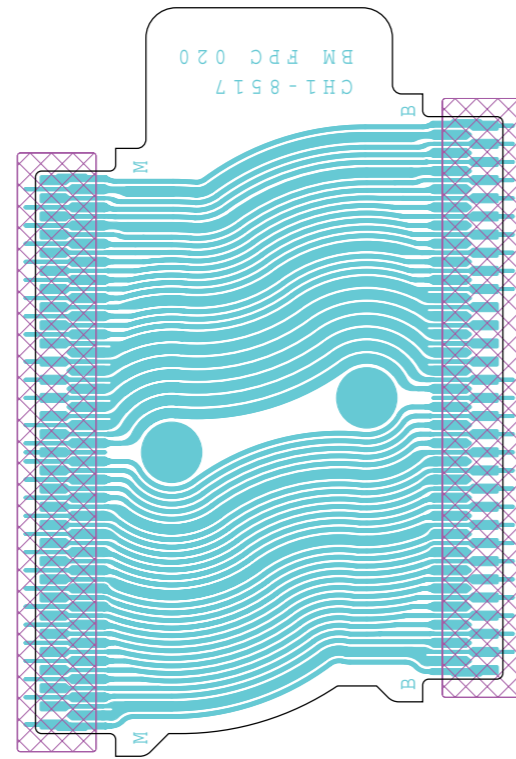

SIDE B

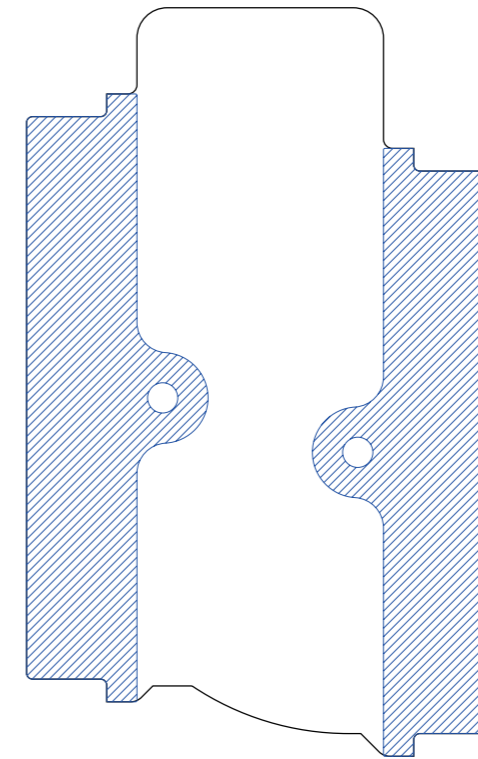

SIDE A

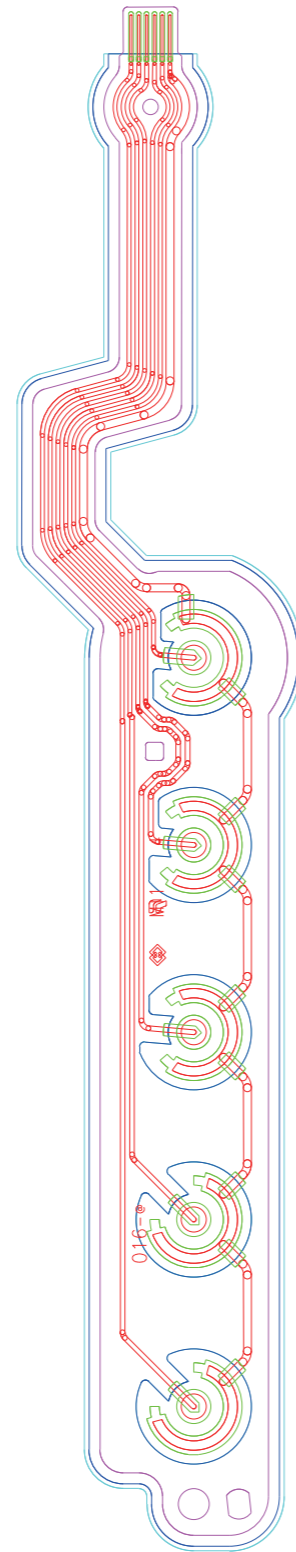

SIDE B

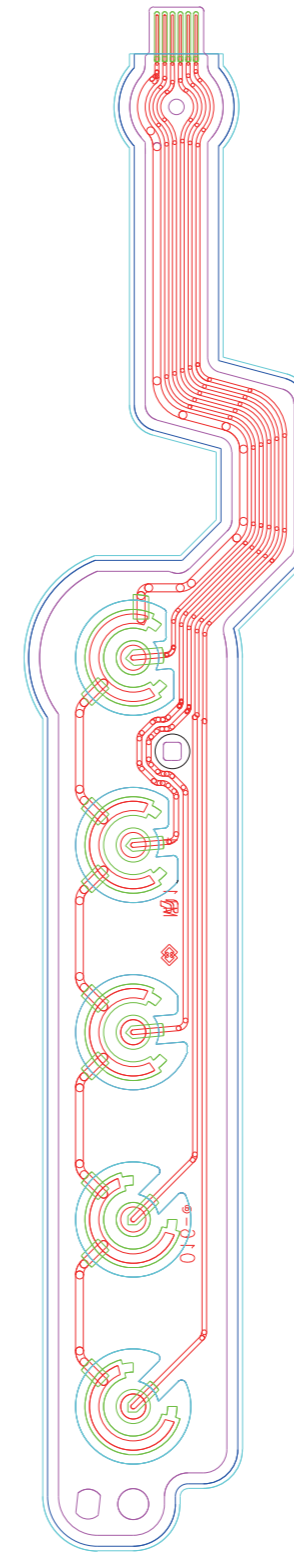

SIDE A

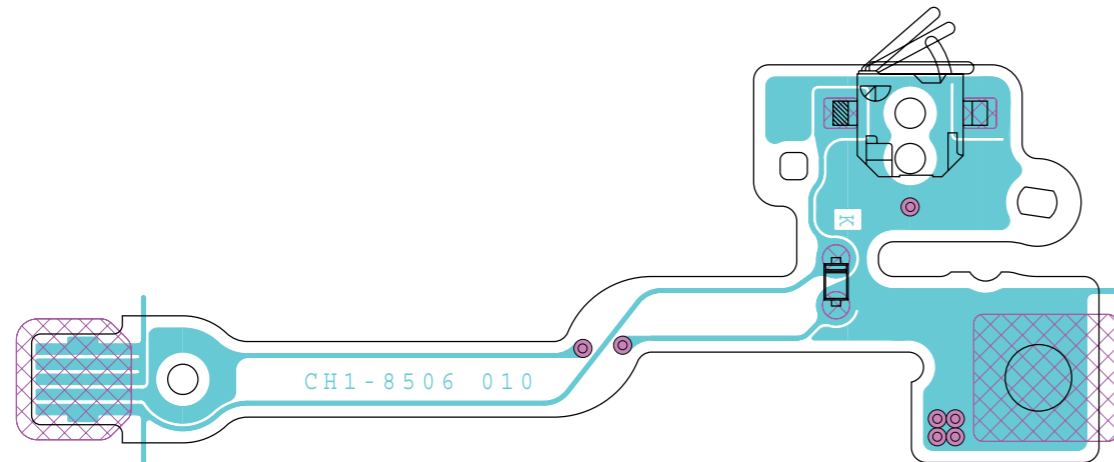

SIDE B

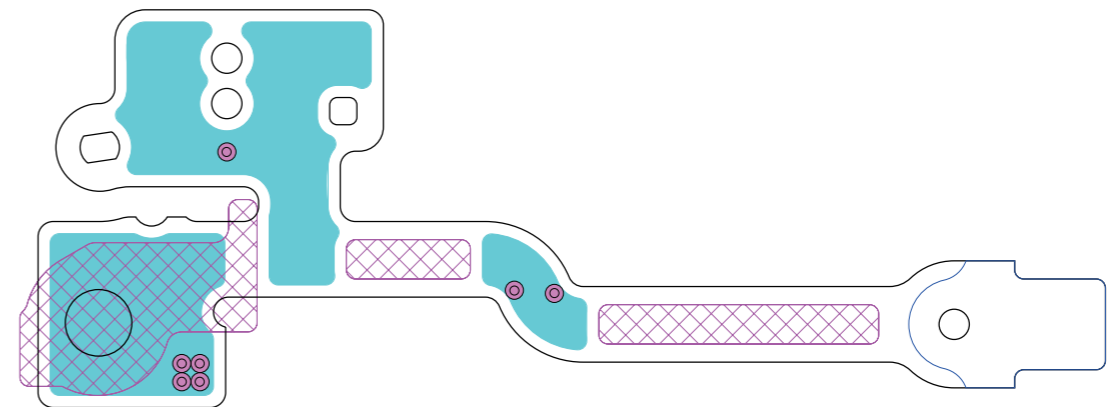

SIDE A

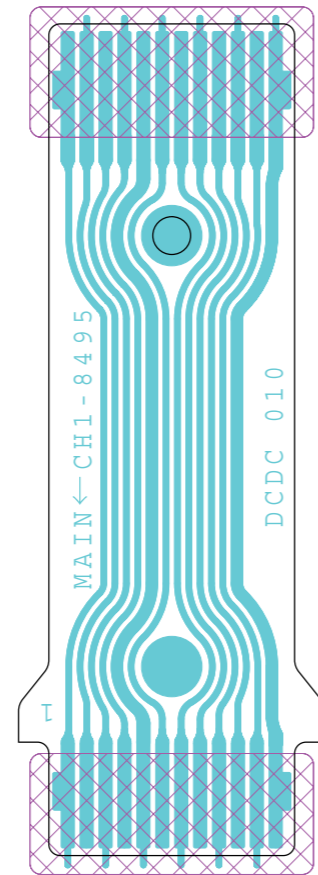

SIDE B

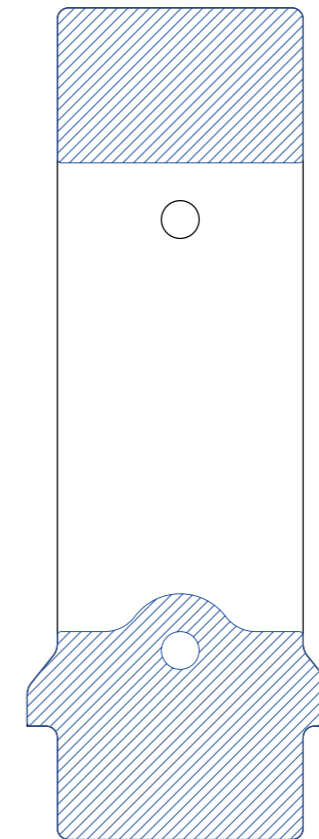

SIDE A

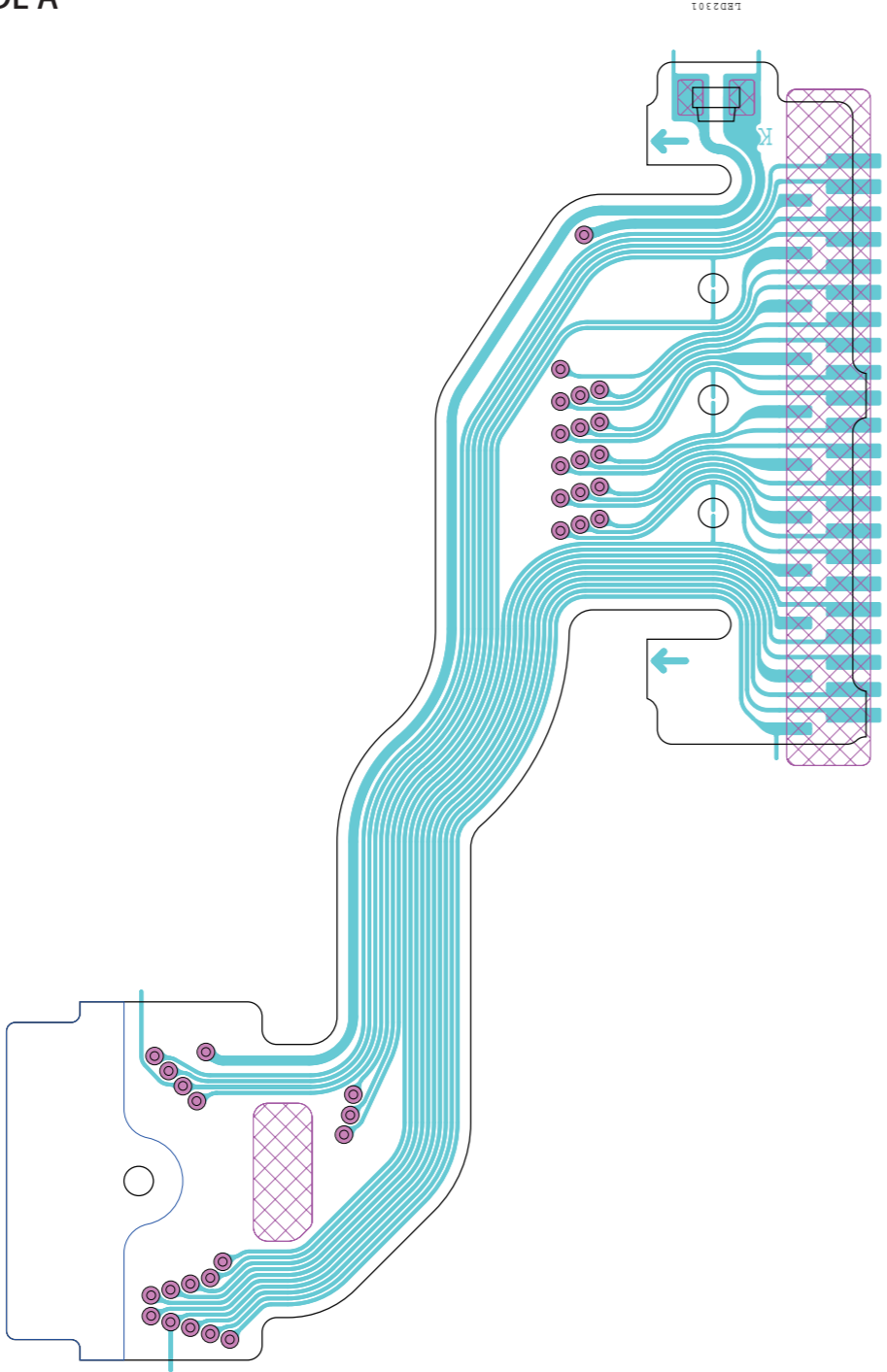

SIDE B

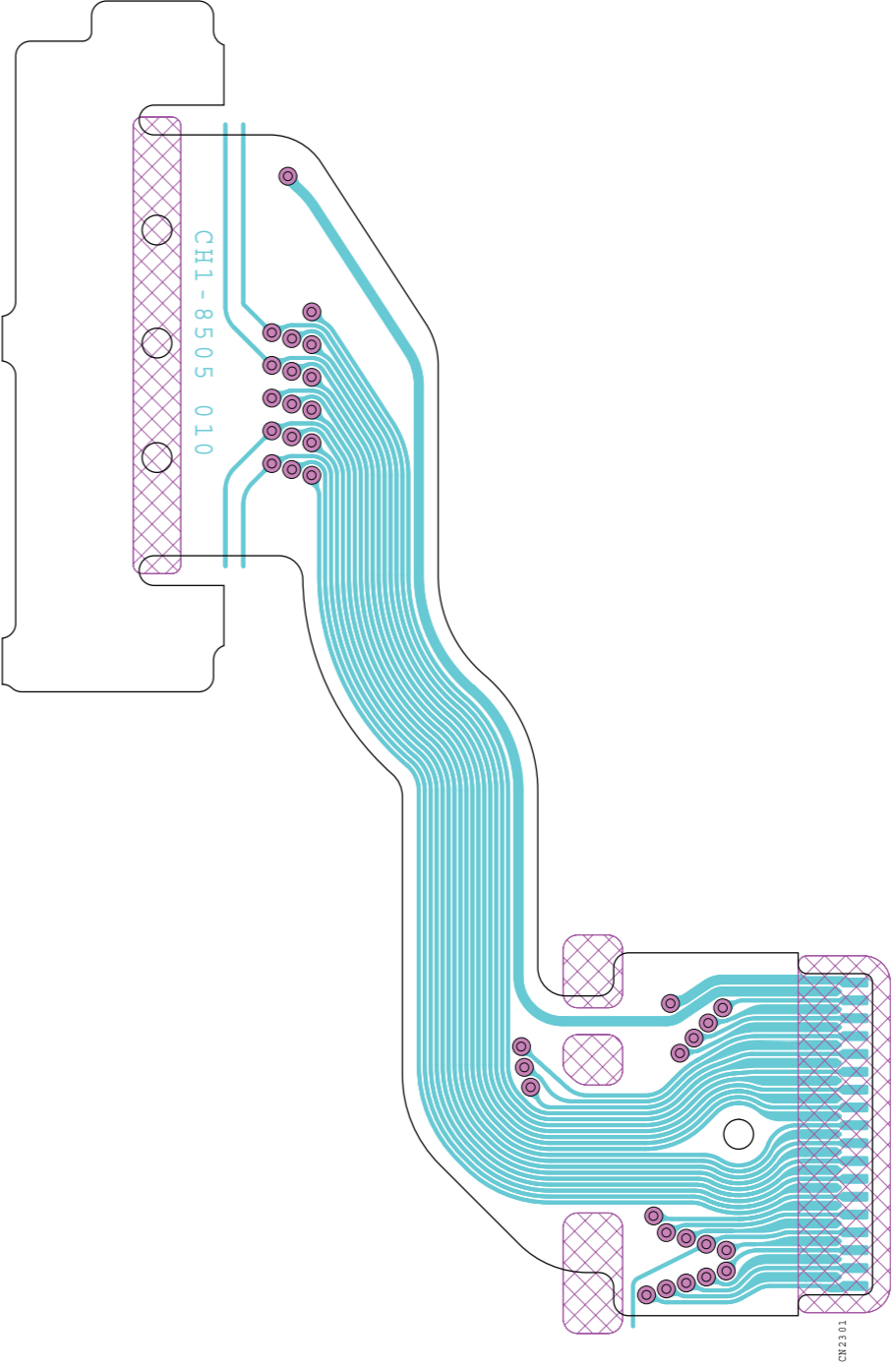

- TB2201
- TB2202
- TB2203
- TB2204
- TB2205
- TB2206
- TB2207
- TB2208
- TB2209
- TB2210
- TB2211
- TB2212
- TB2213
- TB2214
- TB2215
- TB2216
- TB2217
- TB2218
- TB2219
- TB2220
- TB2221
- TB2222
- TB2223
- TB2224
- TB2225
- TB2226
- TB2227
- TB2228
- TB2229
- TB2230
- TB2231
- TB2232
- TB2233

SIDE A

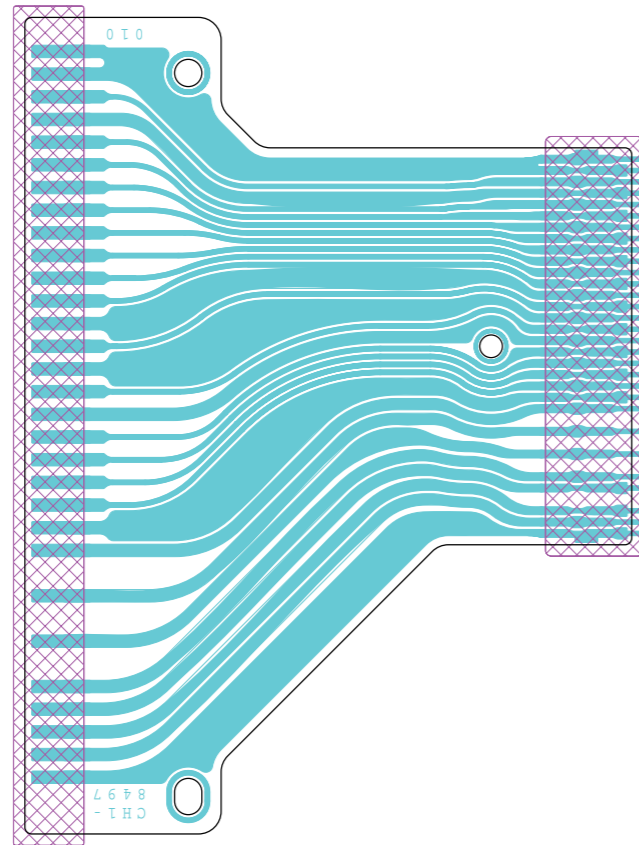

SIDE B

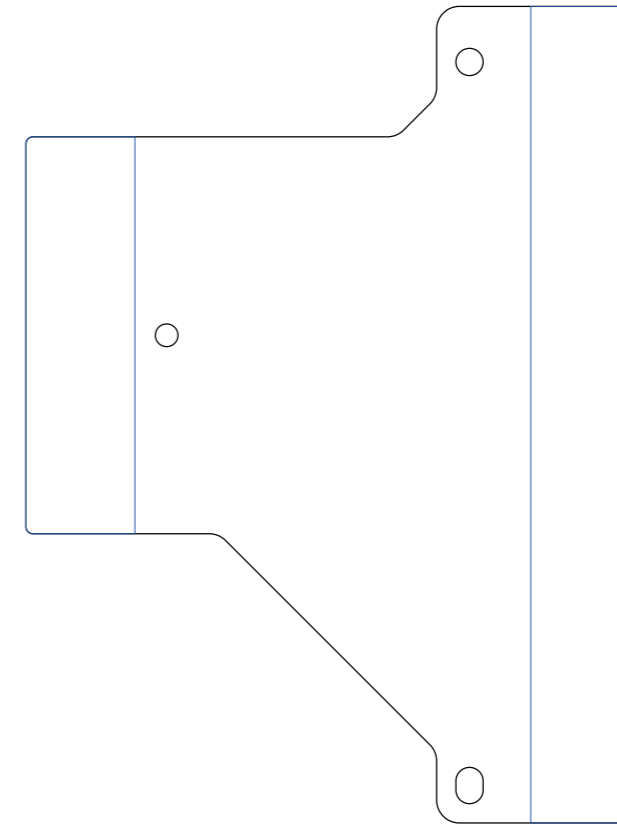

SIDE A

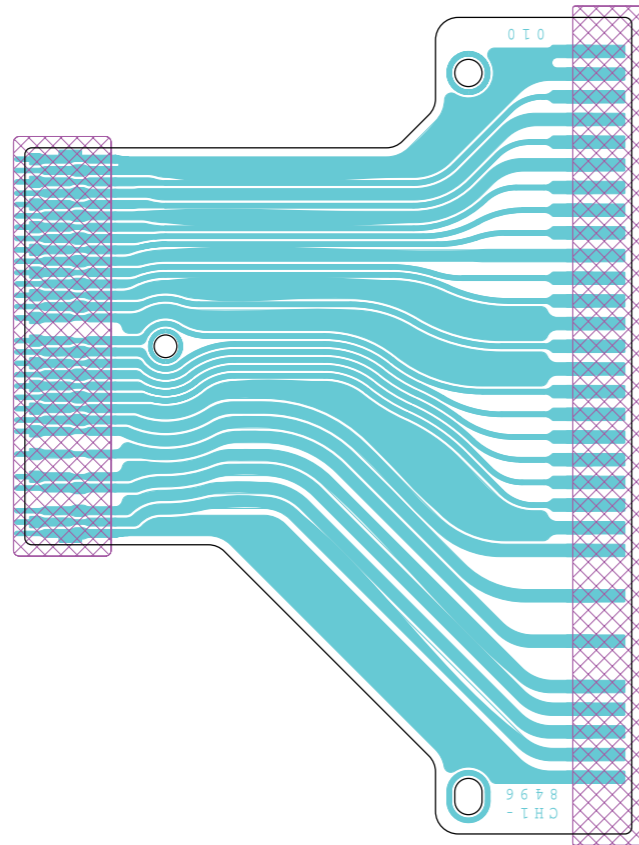

SIDE B

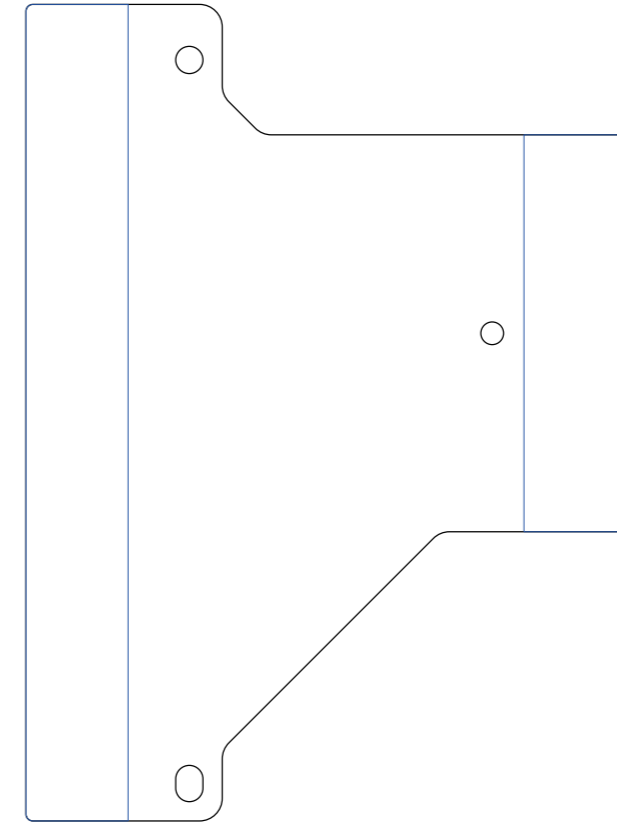

SIDE A

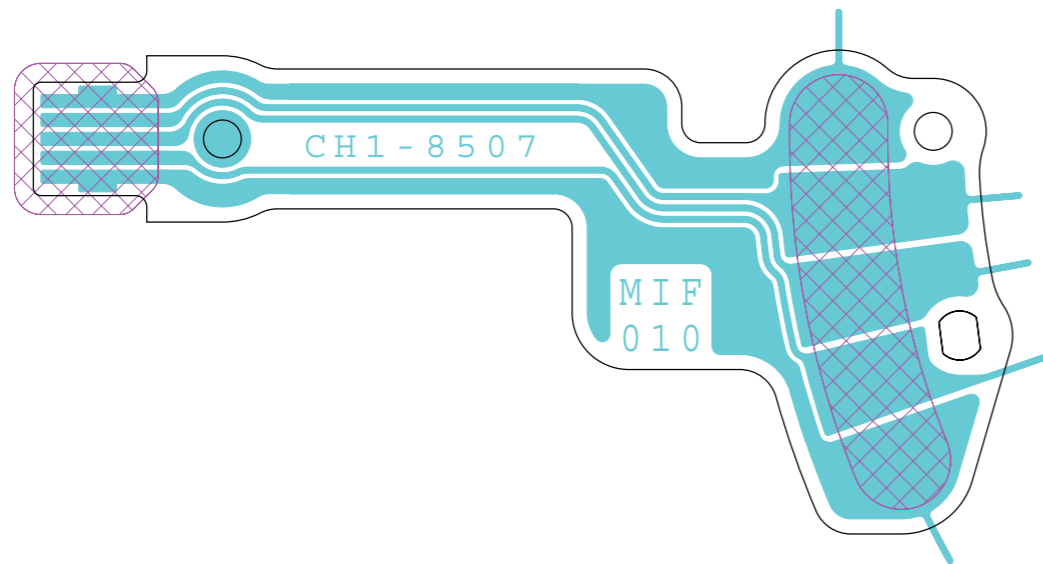

SIDE B

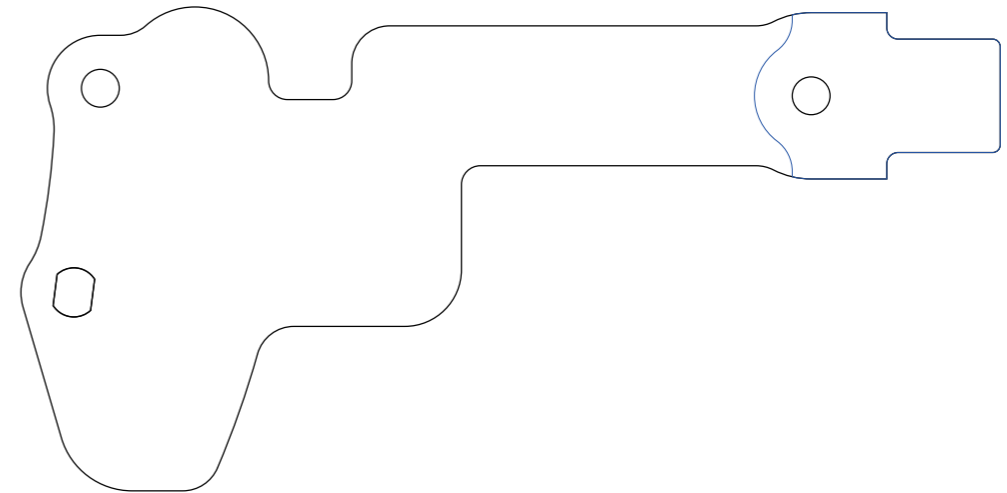

SIDE A

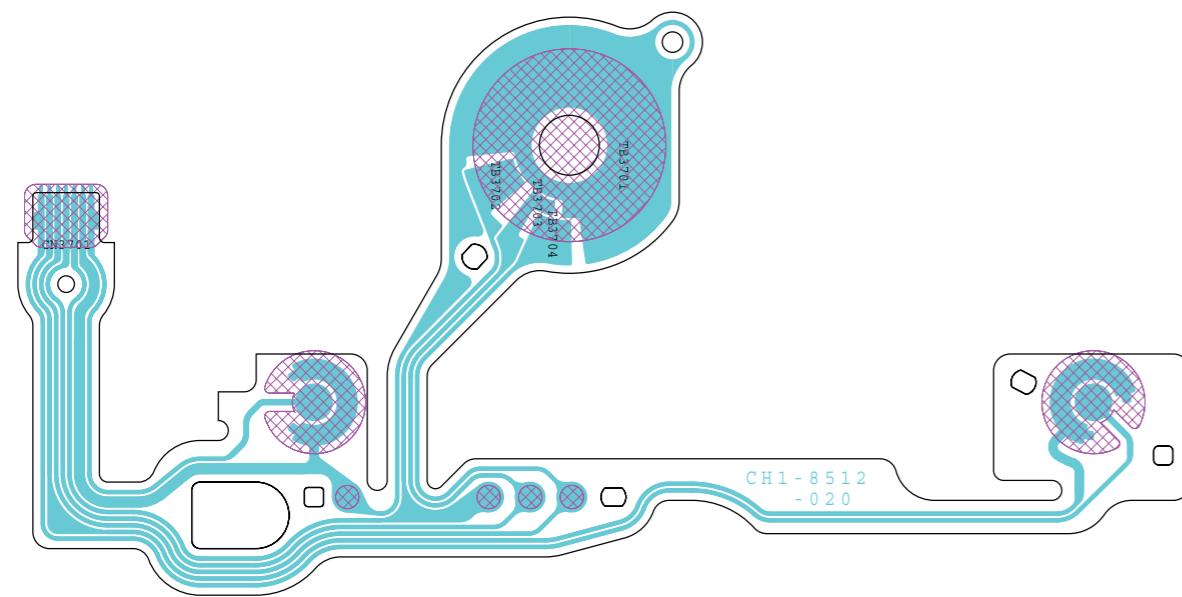

SIDE B

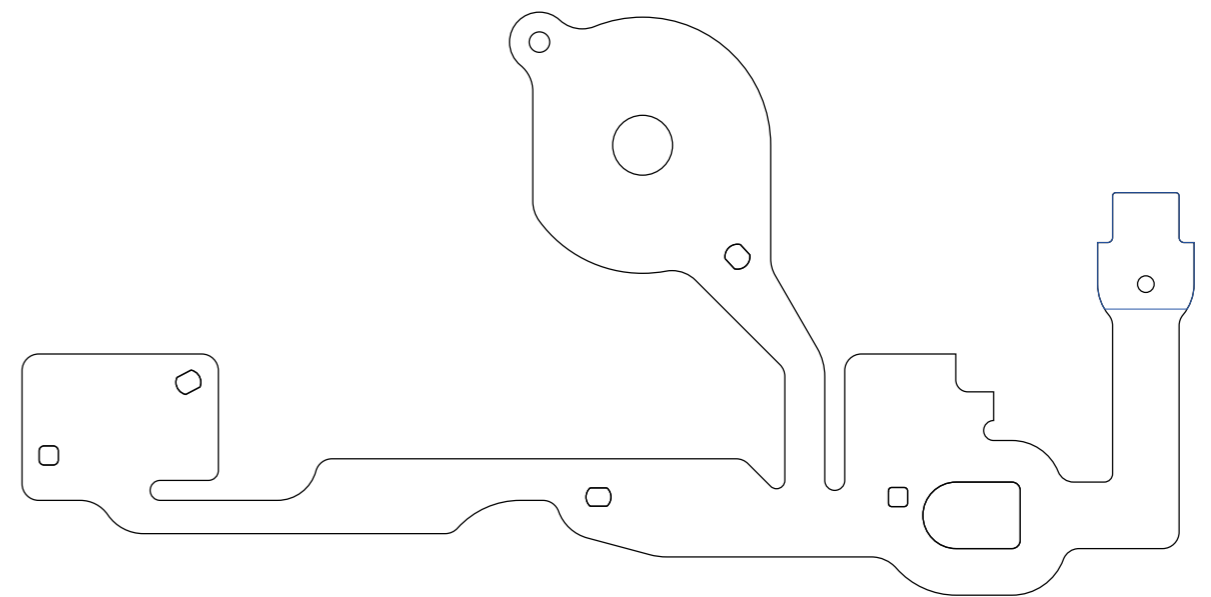

SIDE A

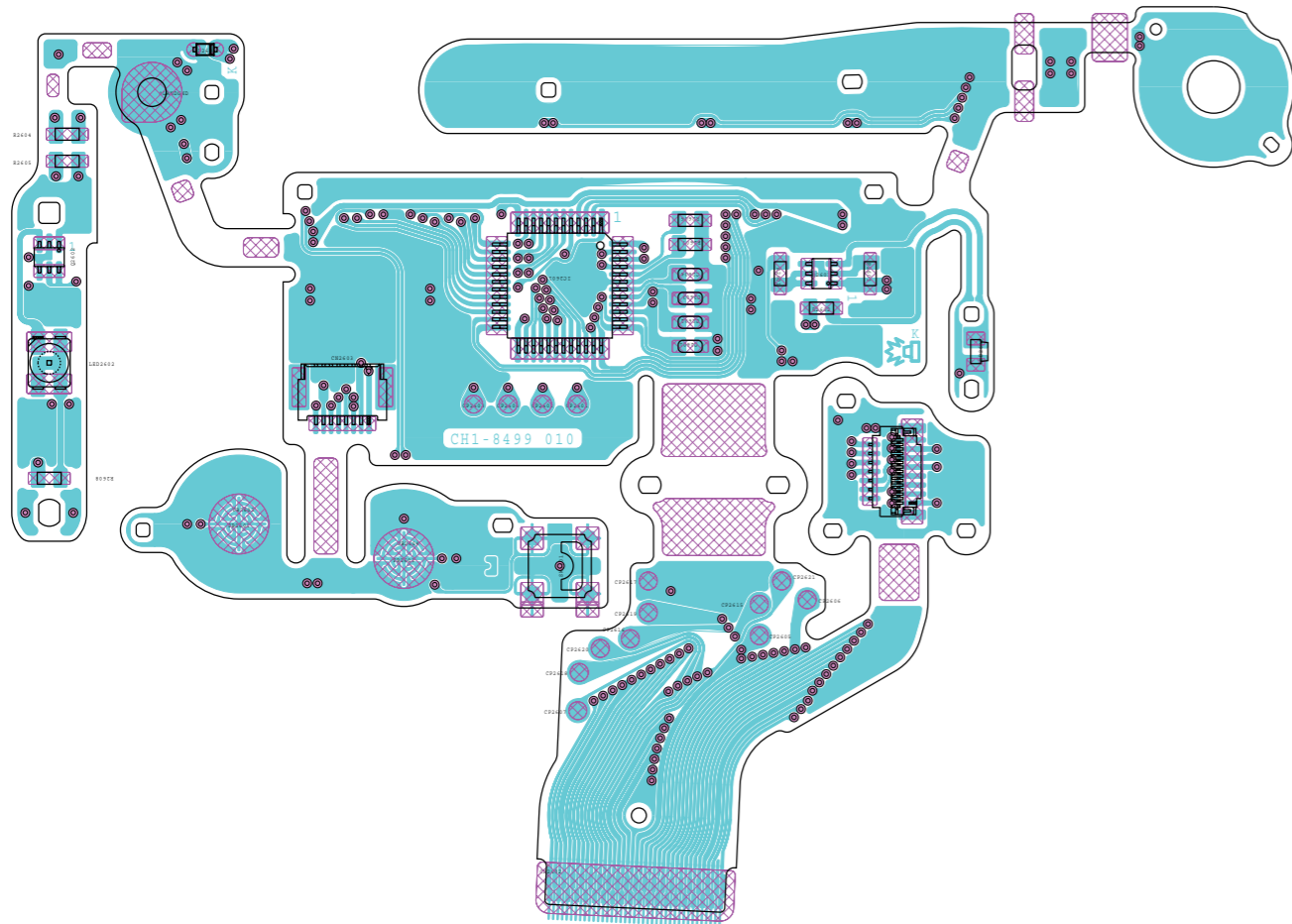

SIDE B

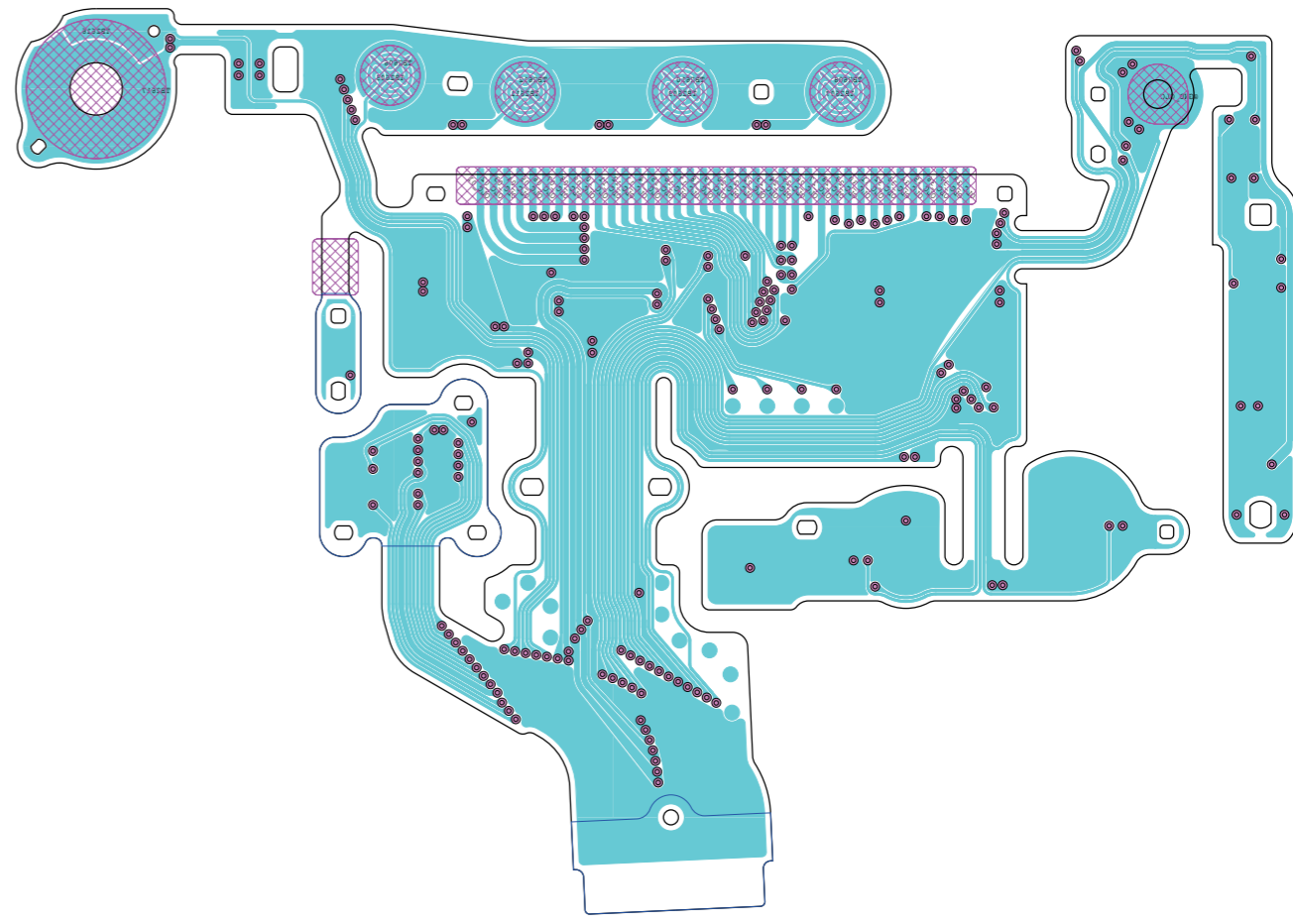

SIDE A

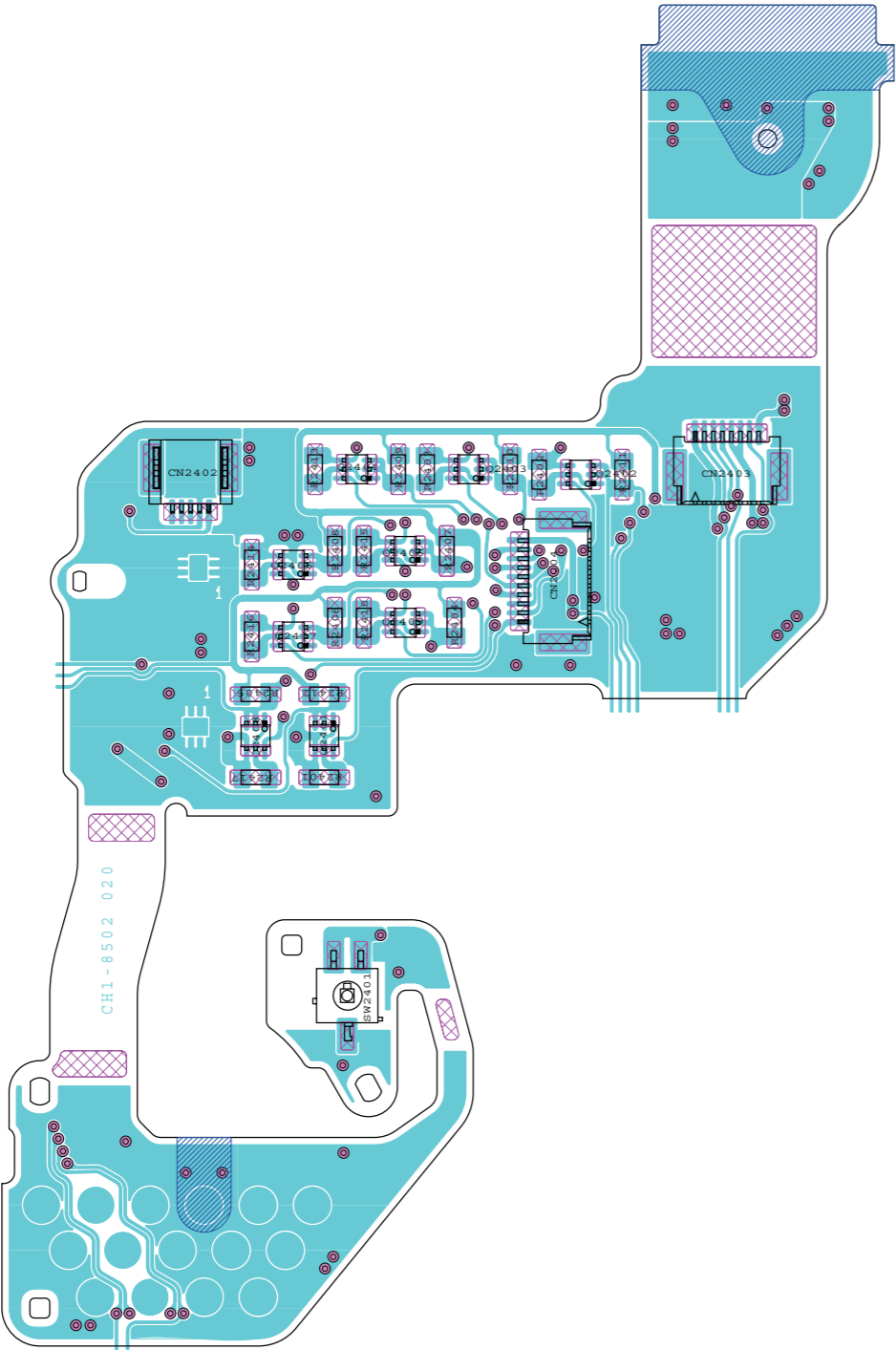

SIDE B

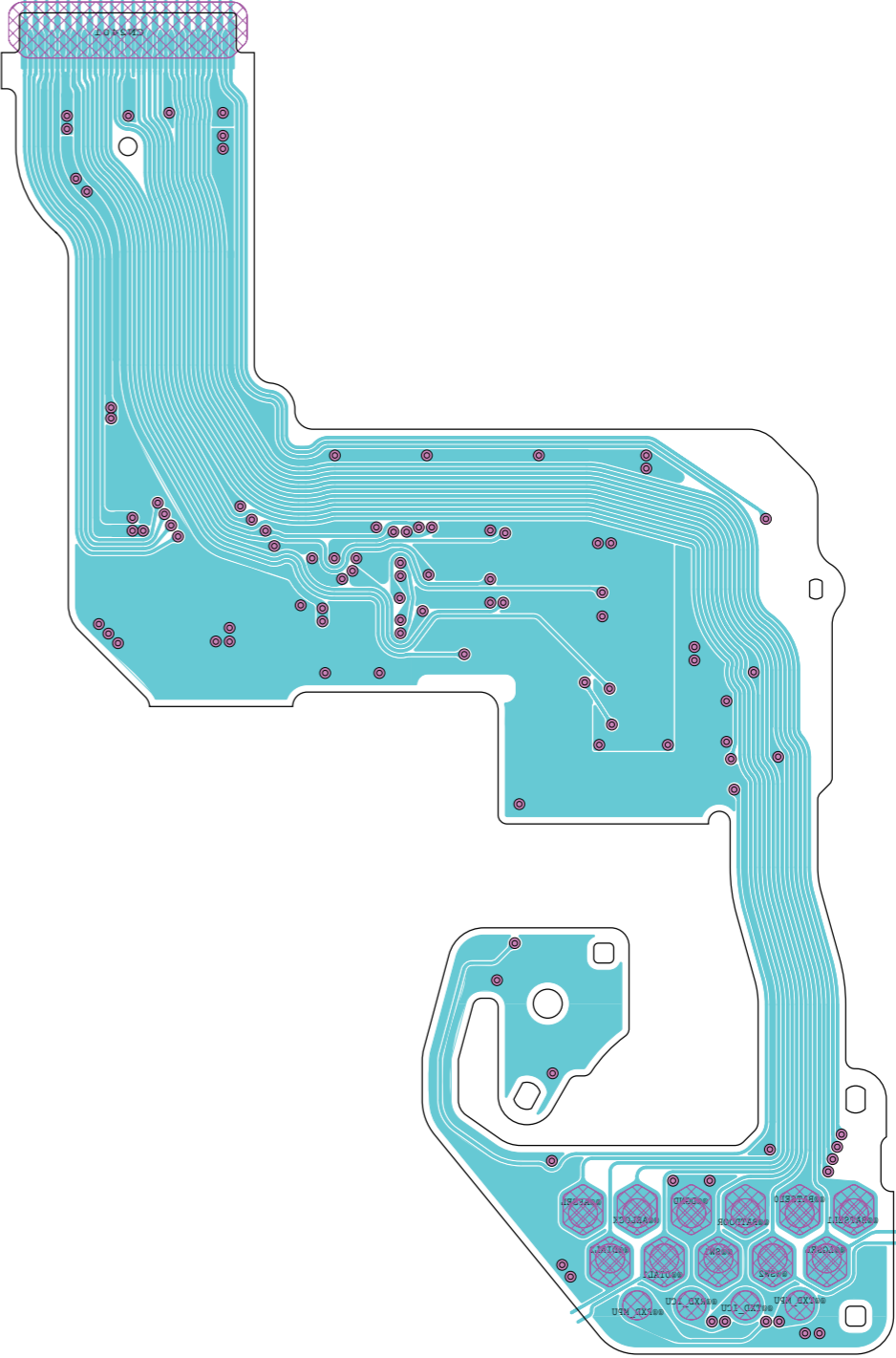

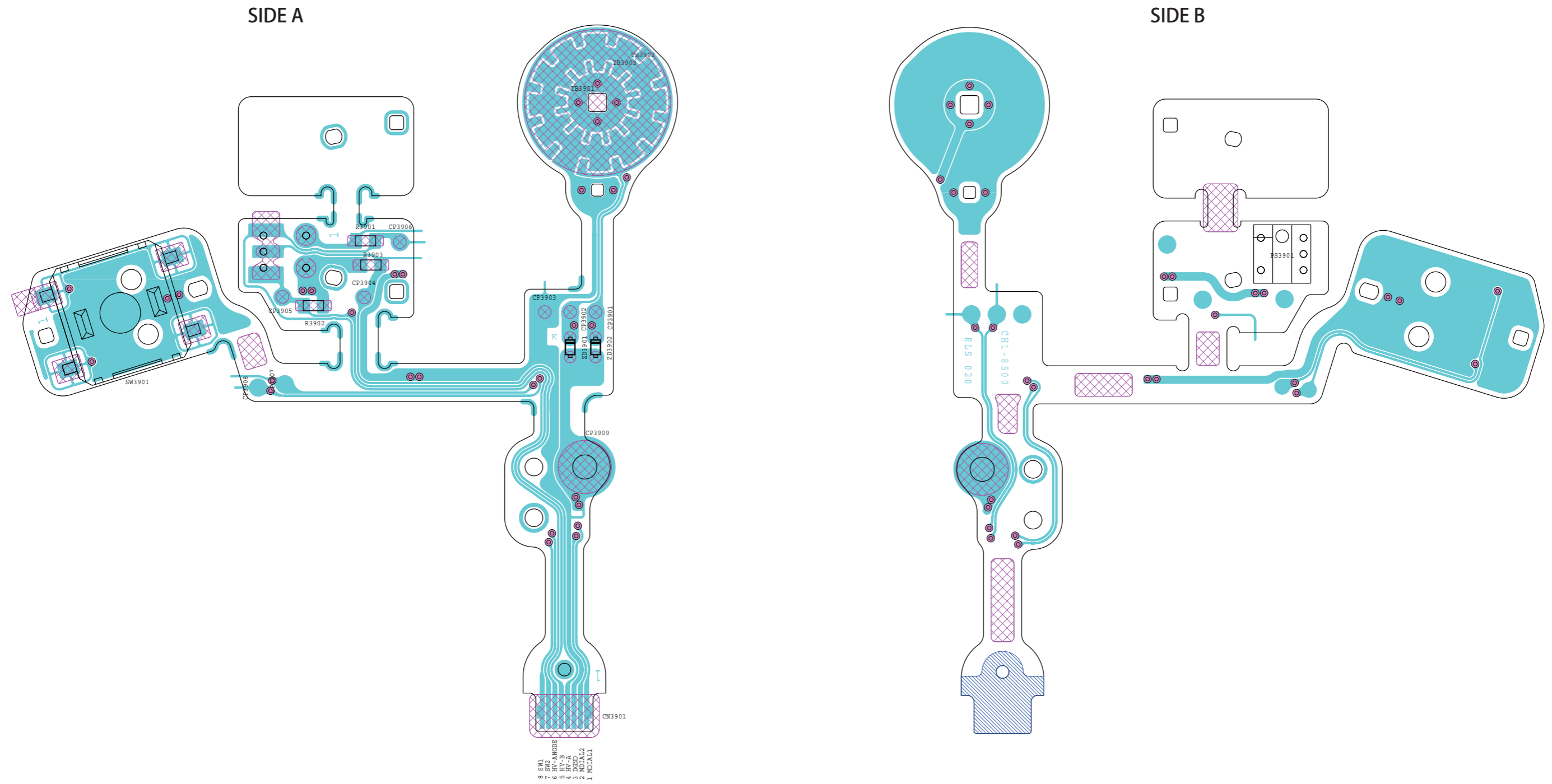

SIDE A

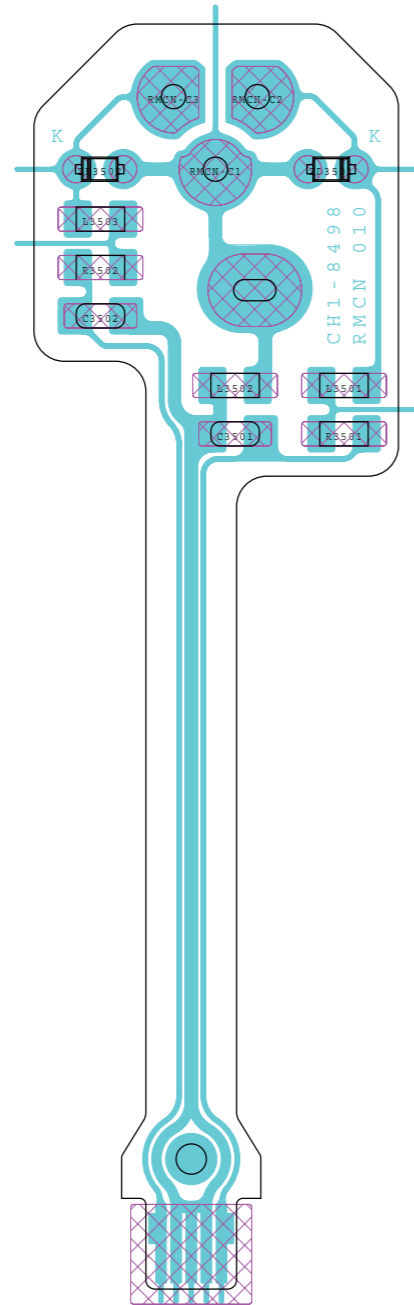

SIDE B

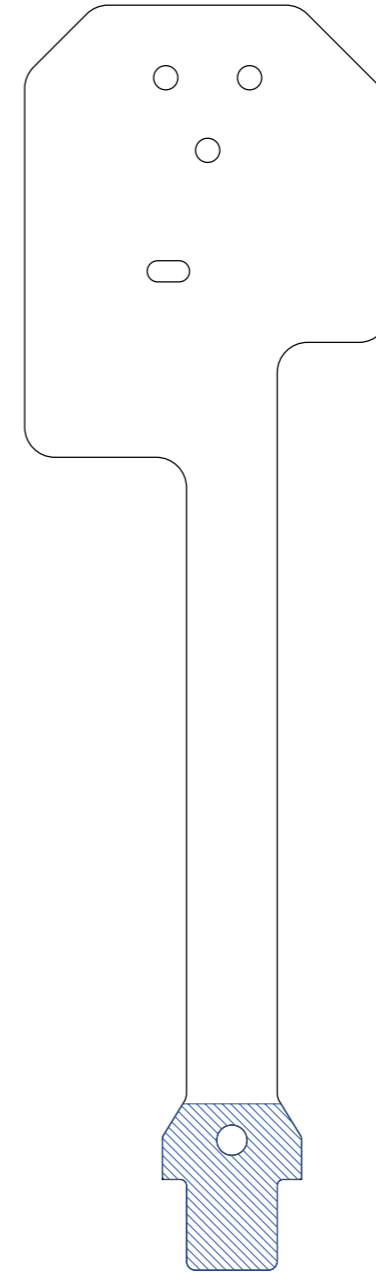

SIDE A

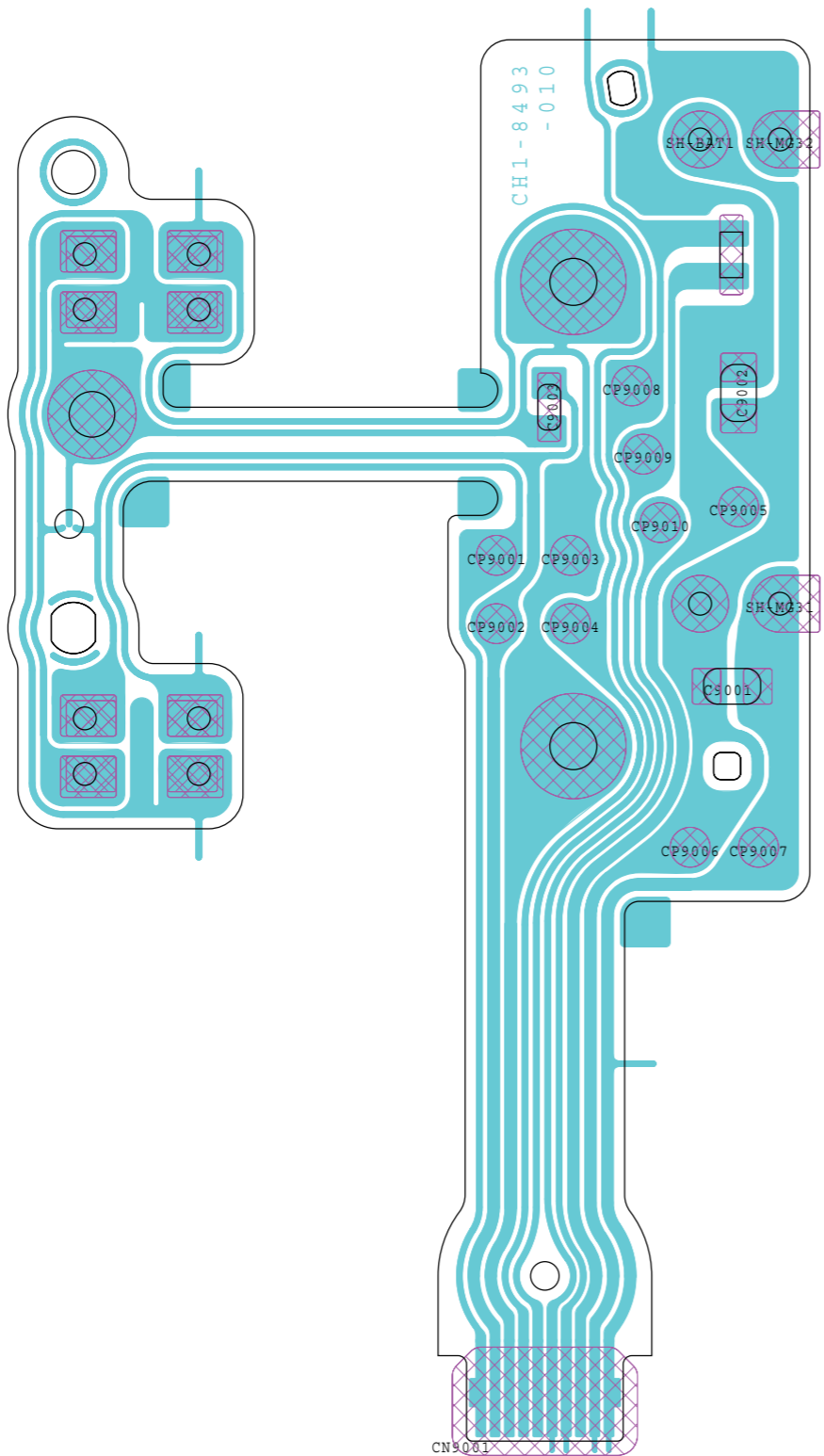

SIDE B

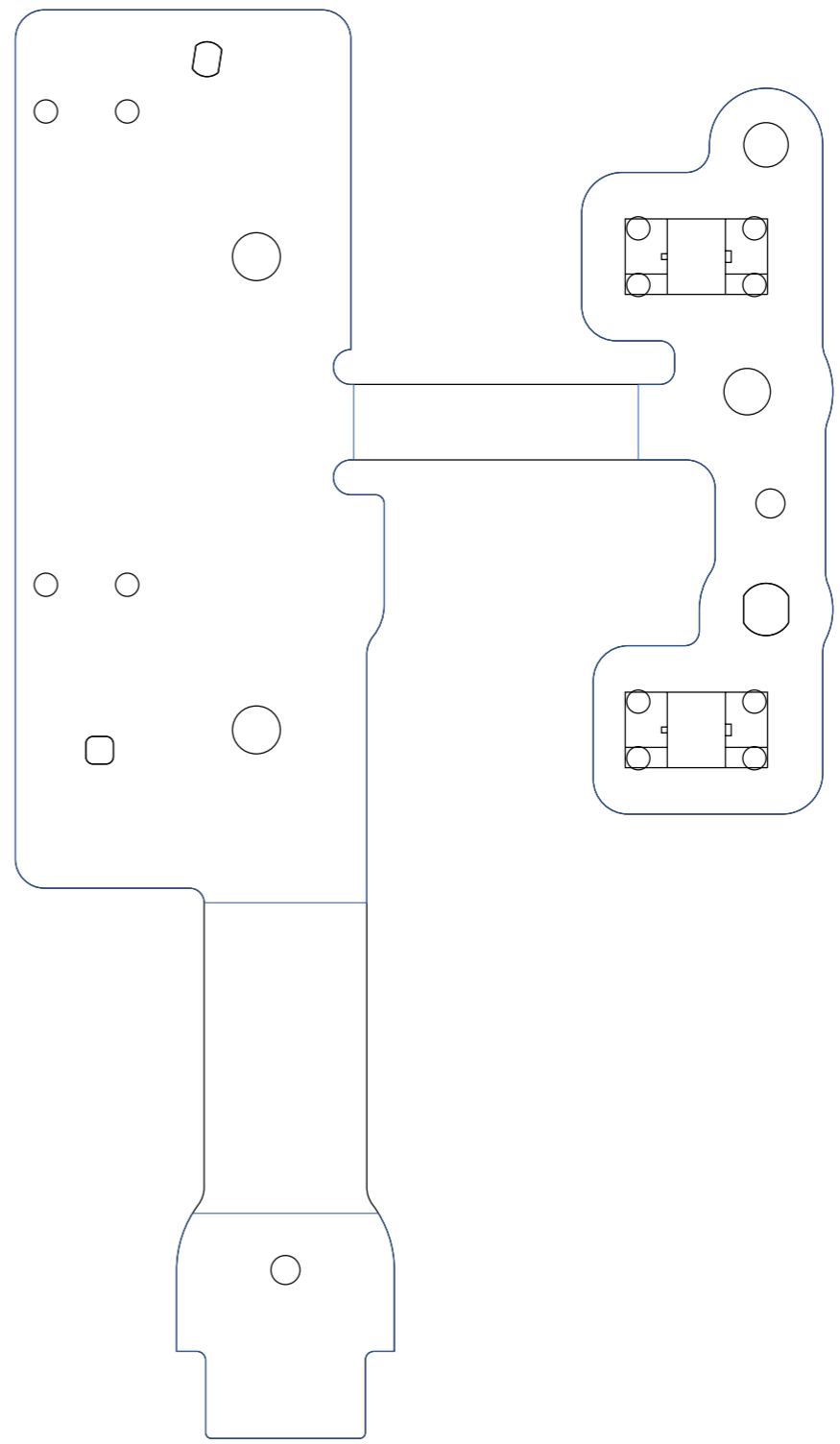

SIDE A

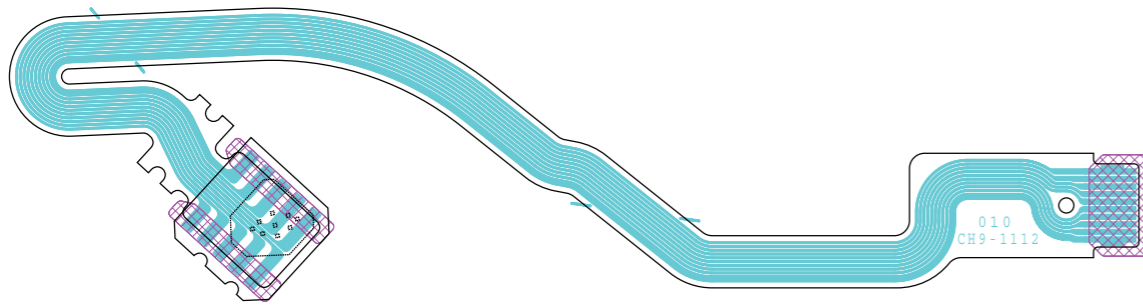

SIDE B

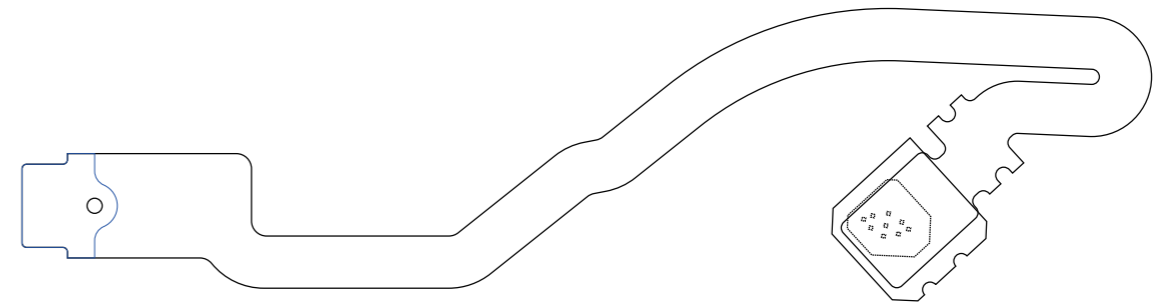

SIDE A

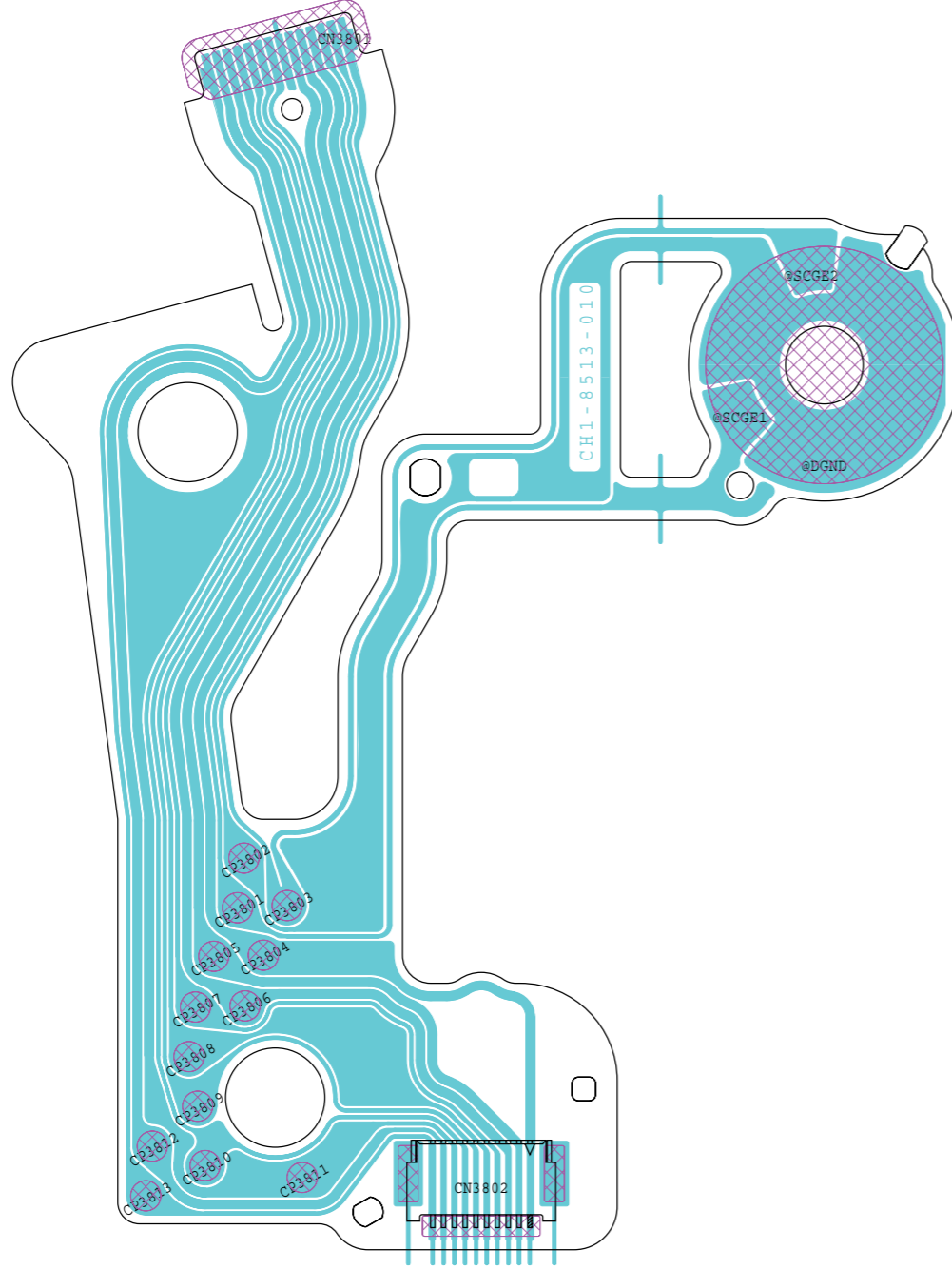

SIDE B

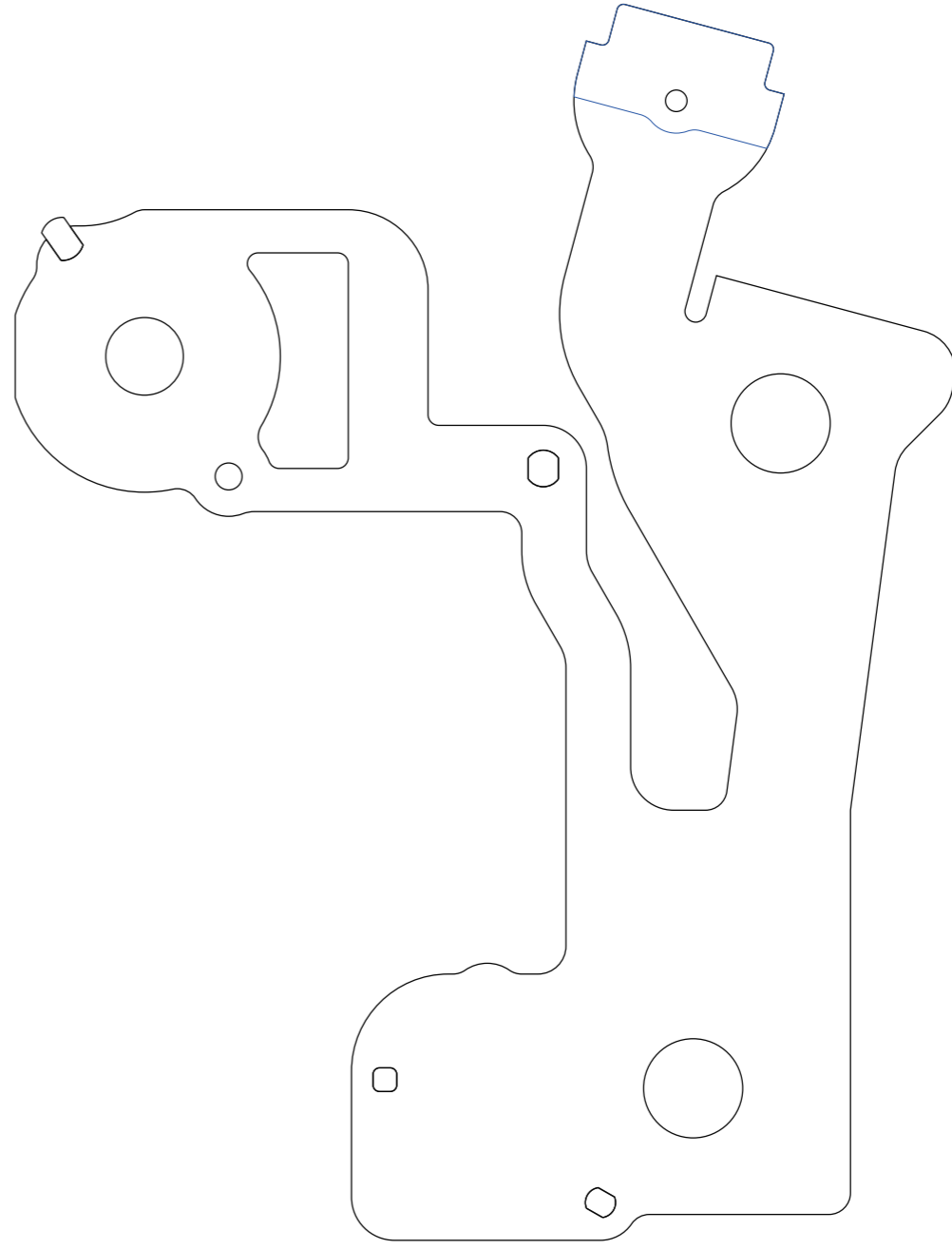

SIDE A

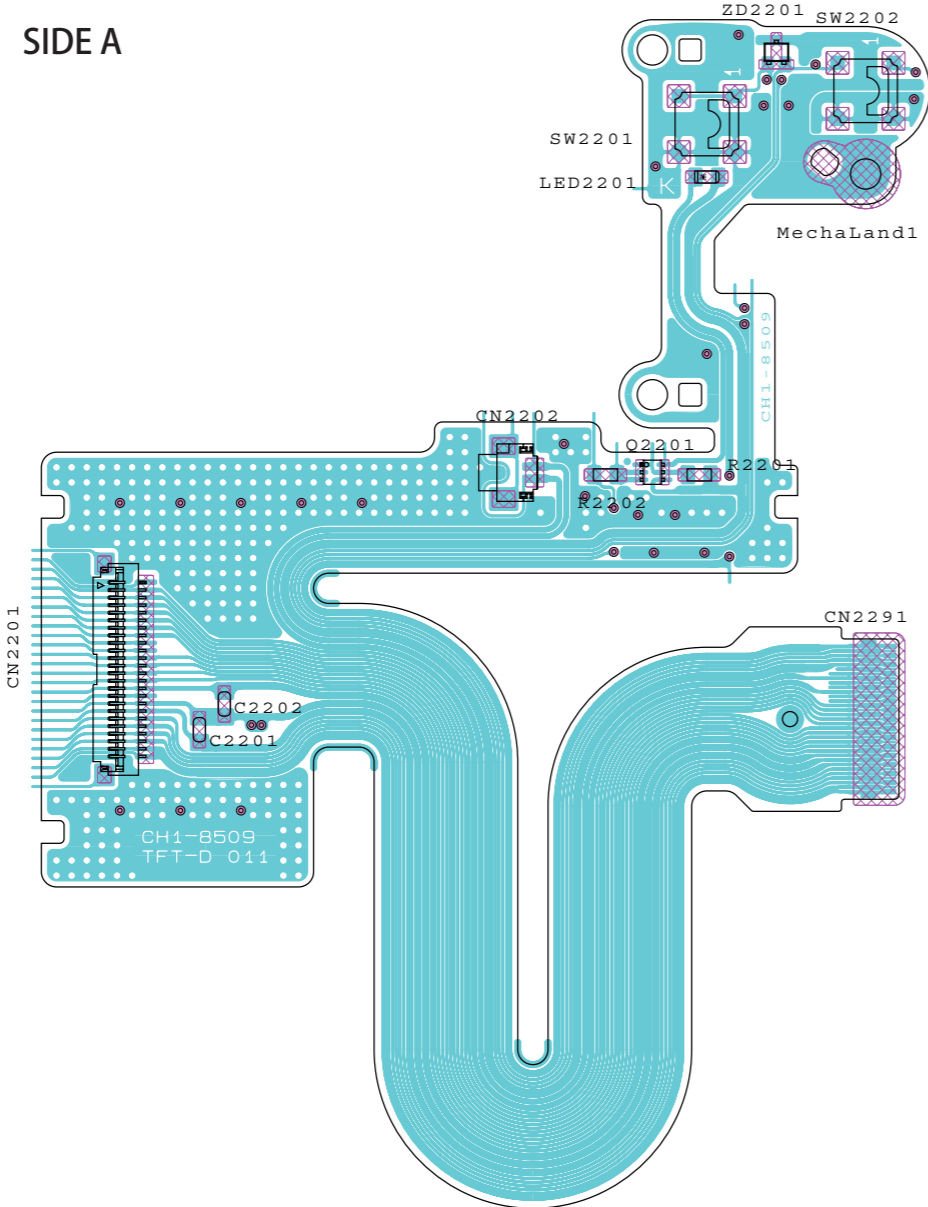

SIDE B

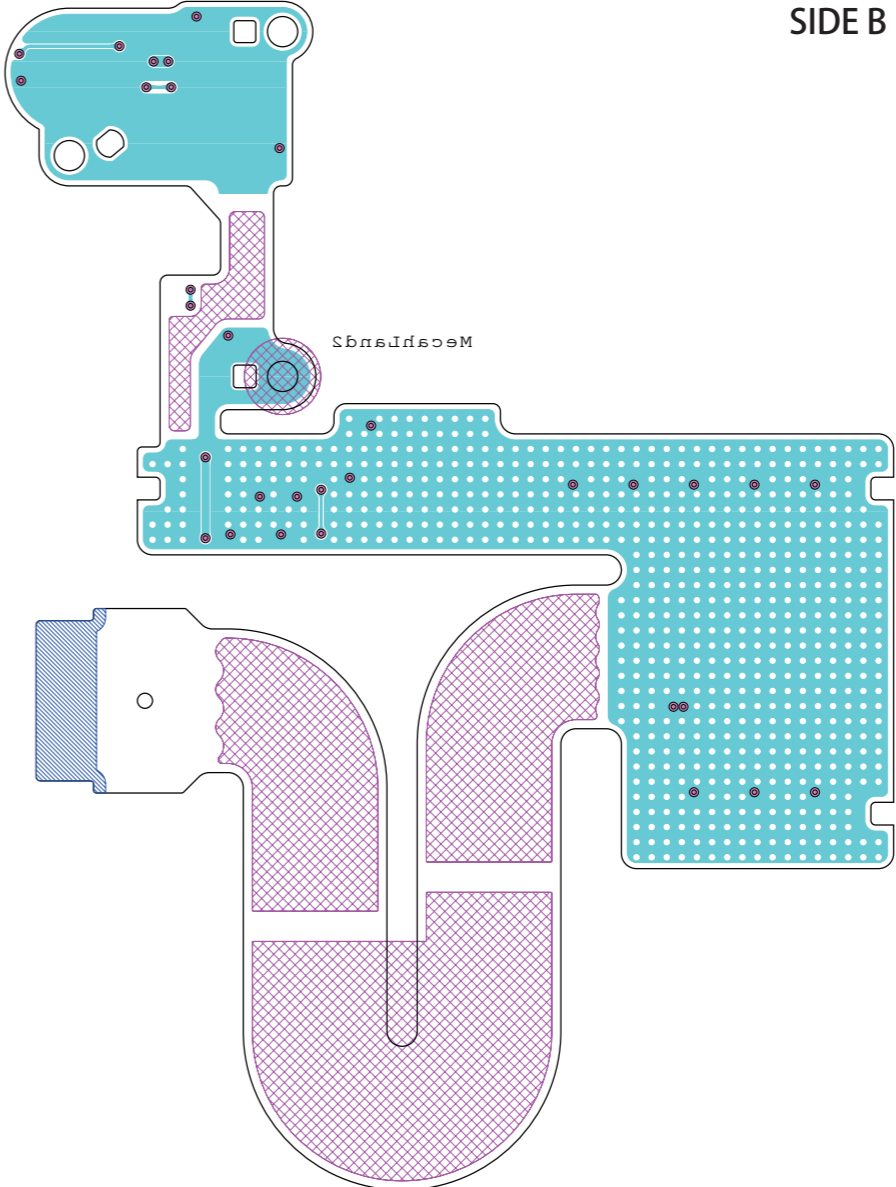

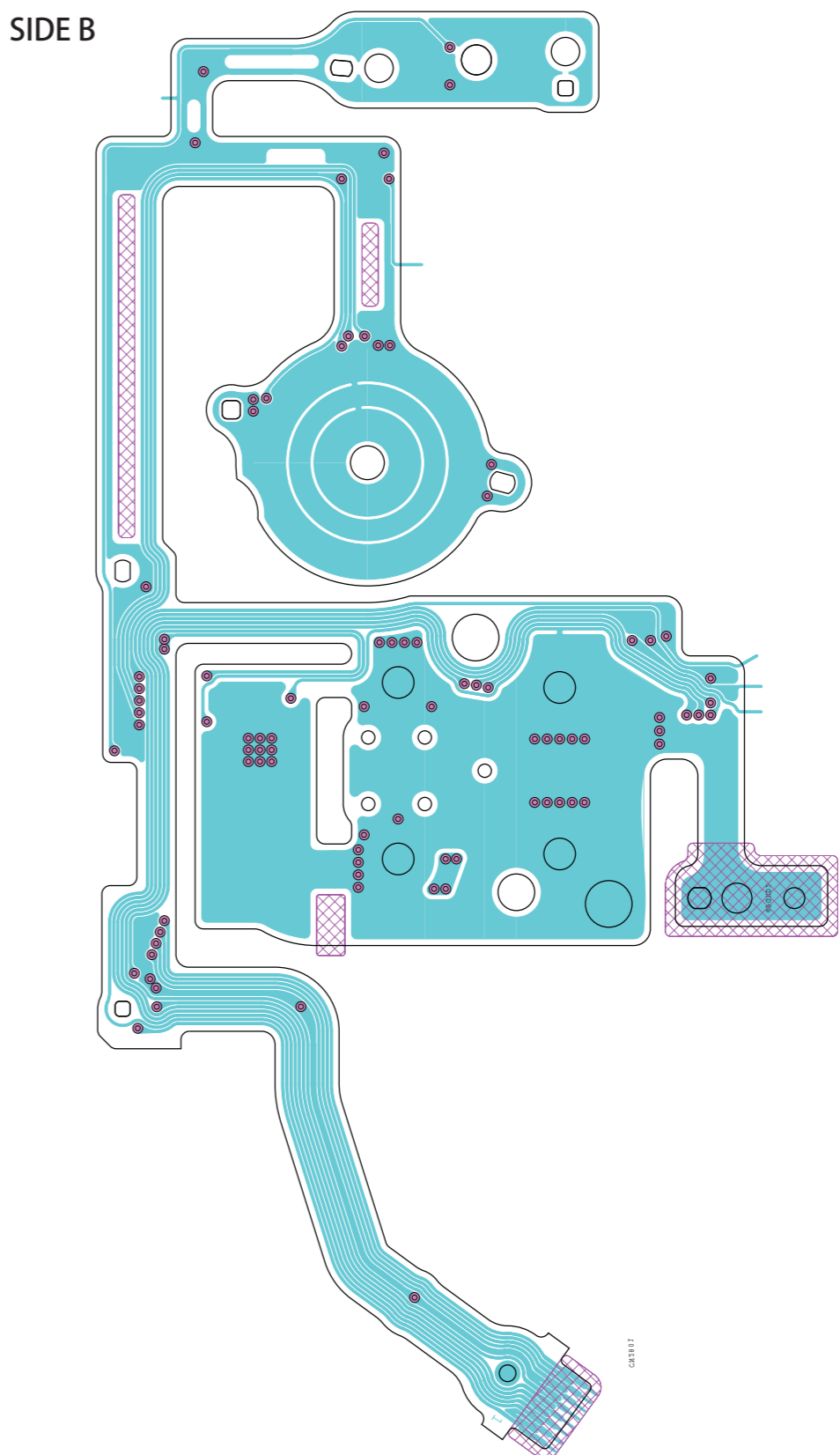
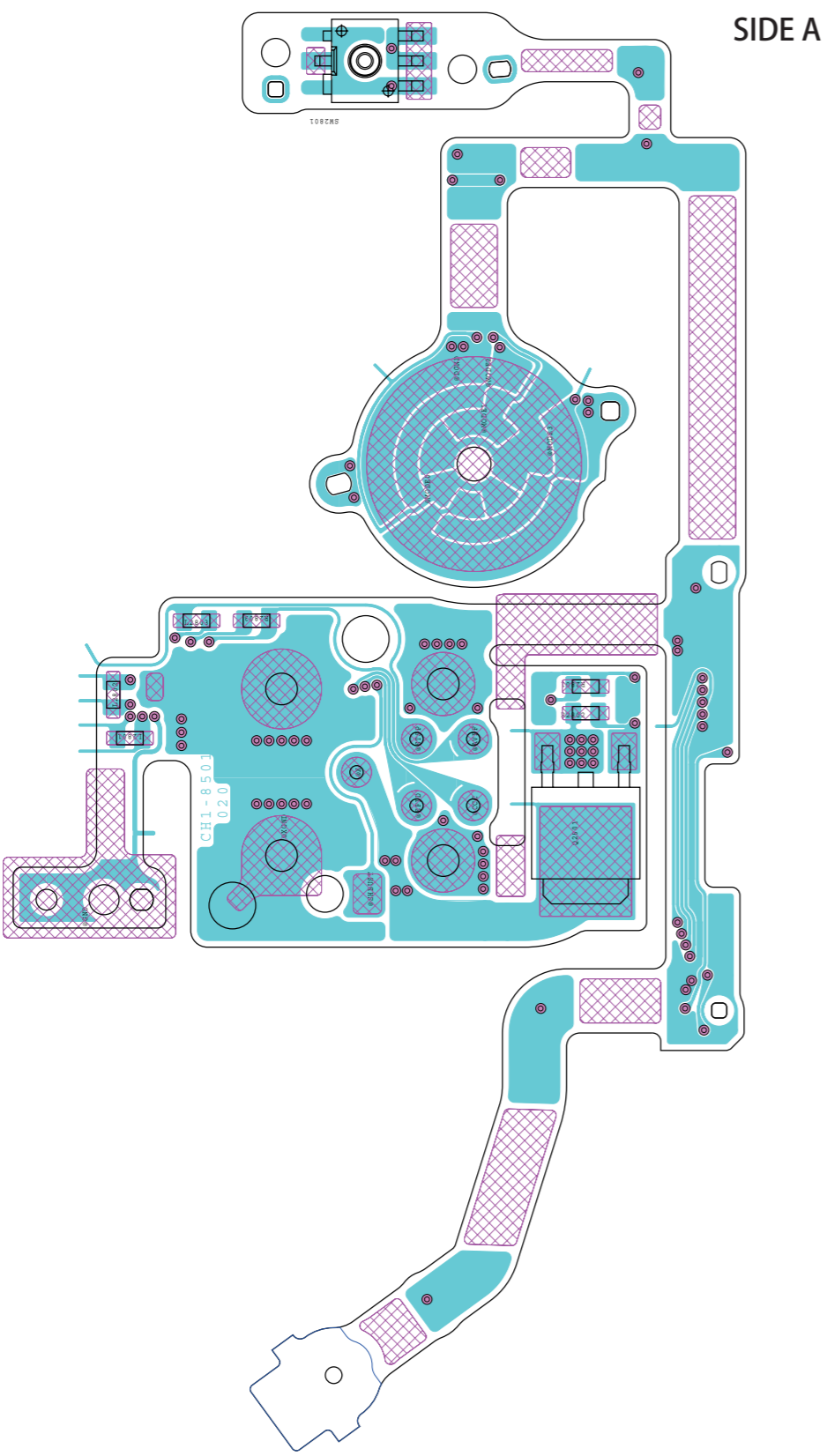

Software Information

Trademarks

Trademarks

The product names and company names described in this Service Manual are the registered trademarks of the individual companies.

Copyright

Canon Inc. retains the copyright to this Service Manual. Reproduction, publication (including on the World Wide Web), alteration, translation into another language, or other use of the data in whole or part, contained on this Service Manual without the written consent of Canon Inc. is prohibited.

CONTENTS

	Page
Software Information	
<hr/>	
1. EOS DIGITAL SOLUTION DISK Ver. 15	1
1.1 Development Objectives.....	1
1.2 Features	1
1.3 Software Configuration and System Requirements	6
1.4 Software Overview	8
1.5 Additional Notes	9

1. EOS DIGITAL SOLUTION DISK Ver. 15

1.1 Development Objectives

EOS DIGITAL SOLUTION DISK Ver.15 is EOS DIGITAL software based on EOS DIGITAL Solution Disk Ver.14 that provides the upgraded functionality described below.

1.2 Features (blue text indicates features changed since Ver. 14)

1) EOS Utility Ver.2.1

- This is software for communicating with EOS DIGITAL cameras that enables you to download images from your camera to a computer, specify camera settings and shoot photos remotely.
- Support for almost all EOS DIGITAL camera models
 - * Does not support the EOS D6000, EOS D2000, EOS DCS1 or EOS DCS3
- Image downloading from the camera
 - Downloads all the images as a batch from the camera to a computer.
 - Displays a list of images saved on the memory card in the camera and downloads selected images.
 - Links with DPP or ZB/IB for instant checking of downloaded images immediately.
 - Also supports automatic image downloading using the Print/Share function.
- Specification of camera settings
 - Specifies basic information settings such as the owner name and the date/time.
 - Specifies settings for features such as Picture Style, processing parameters and Personal Functions, depending on the specifications of the connected camera.
 - Specifies My Menu settings for the [EOS 40D](#) and EOS-1D Mark III.
- Remote shooting
 - Remote Live View shooting that allows you to take pictures while viewing the image of your subject in realtime as captured by the camera^{*1}.
 - Display of a grid showing the camera's horizontal/vertical orientation in the Remote Live View window^{*1}.
 - Display of vertical lines showing the image's specified aspect ratio in the Remote Live View window^{*2}.
 - Equipped with timer, interval timer photography and bulb shooting^{*1} functions.
 - Also supports shooting by pressing the shutter button on the camera.
 - * 1 [EOS 40D](#) and EOS-1D Mark III only
 - * 2 EOS-1D Mark III only
- Folder monitoring
 - When you are using the WFT-E1/E1A or WFT-E2/E2A Wireless File Transmitter, or the [WFT-E3](#), this allows you to transfer shot images in monitored folders to another specified folder and to check images in realtime in DPP, ZB/IB or another designated linked software application.
- Link ups with the software for optional accessories
 - Starting up and working with software for the WFT Utility or Original Data Security Tools from the main menu.
- [Link ups with Picture Style Editor](#)
 - [Allows Picture Style Editor to be launched from the main menu and Picture Style files to be registered on compatible cameras.](#)

2) Digital Photo Professional Ver.3.1

- This is RAW image viewing/processing/editing software aimed primarily at amateur and professional users who mostly shoot RAW images.
- High-speed processing of RAW images
 - High-speed RAW image display and processing using Canon's own powerful algorithms.
 - Processing with high image quality using the latest genuine Canon algorithms.
- Support for RAW images from almost all EOS DIGITAL camera models
 - Also supports RAW images from the EOS D6000 and EOS D2000 that were converted using the CR2 converter.
 - * Does not support RAW images from the EOS DCS1 or EOS DCS3.
- Viewing and editing of JPEG and TIFF images
- Link ups with Canon's EOS software
 - Works with EOS Utility to provide support for all communication functions with the camera, including remote shooting and downloading images from the camera.
- Window displays tailored to professional workflows
 - Image display options to suit a range of applications
 - Thumbnail image list display from the main window
 - Quick check window that is useful for checking the focus and image details
 - Edit window allows an image to be edited while being compared with other images
 - Edit image window that allows multiple images to be edited efficiently
 - Image selection using 3 types of check marks
 - Rearranging of thumbnail images in the main window using drag & drop
 - RAW+JPEG images displayed as single image in the main window
 - Image display that supports aspect ratio settings during Remote Live View shooting with EU*
 - *EOS-1D Mark III only
- Extensive range of image editing functions
 - RAW image adjustment functions that offer greater flexibility than the camera alone.
 - Image adjustment functions that retain the image's original condition.
 - RAW adjustment functions:
 - Camera-like RAW image adjustment functions using the same functions as those provided on the camera.
 - Brightness, white balance, Picture Style, contrast and dynamic range adjustment.
 - RGB adjustment functions (also supports JPEG and TIFF images):
 - Image adjustment using functions similar to those provided in ordinary image editing software applications.
 - Automatic tone curve adjustment (tone curve assist), tone curve, brightness, contrast, dynamic range, color and sharpness adjustment.
 - NR (Noise Reduction) functions:
 - Noise reduction for image shot at night or at high ISO sensitivities.
 - Luminance and chrominance noise reduction for RAW images, chrominance noise reduction for JPEG and TIFF images.
 - Image rotation (90° to the left or right)
 - Trimming
 - Automatic dust erasure (using Dust Delete Data)
 - Dust erasure at specified locations (repair)
 - Image correction (copy stamp)

- Single-image transfer to Photoshop*
*Not supported in Windows Vista.
 - Realtime display of image adjustments and comparison displays of edits
 - Realtime display of a range of adjustments.
 - Before and after editing comparison display that allow you to compare original and edited versions in the same window.
 - Synchronized display that matches the display position and enlargement ratio of multiple edit windows.
 - Faithful, high-quality printing using link ups with Canon inkjet printers
 - Easy-PhotoPrint + Canon inkjet printer
 - Easy-PhotoPrint Pro + new Canon inkjet printer
 - Dedicated Plug-In software + new Canon L printer
 - RAW image printing with the results of editing in DPP applied
 - Printing with seamless compatibility and faithful color reproduction when Canon products are used
 - High-quality printing that supports the extensive Adobe RGB color space
 - 3 printing style specification functions
 - Single-page printing (automatic setting)
 - Single-page printing (shooting information, captioning, flexible layout)
 - Contact sheet printing
 - RAW image conversion and saving
 - Image conversion and saving as TIFF or JPEG images with ICC profiles added
 - Simultaneous generation of JPEG and TIFF images
 - Processing of large RAW images
 - Batch saving/loading/application to other images of recipe data (image adjustments made using the tool palette).
 - Batch conversion/saving of multiple RAW images (batch processing)
 - Batch file renaming.
 - Batch transfer of multiple images to third-party image editing software.
 - Color management
 - Support for Color Management System
 - Support for 5 types of color space
sRGB, Adobe RGB, Apple RGB, ColorMatch RGB, Wide Gamut RGB
 - Addition of ICC profiles to saved images
 - Monitor and printer profiles designatable
 - CMYK simulation function that simulates CMYK environment color tones
- 3) ZoomBrowser EX Ver.5.8c/ImageBrowser Ver.5.8c
- Image viewing/editing/management software aimed squarely at novice to amateur users who mainly shoot JPEG images.
 - Simple operation and straightforward interface
 - Uses task buttons and step-by-step procedures with novice Windows users in mind.
* ImageBrowser is menu-driven.
 - Workflow-compatible from image downloading through to printing
 - Links up with other applications to provide a continuous workflow from image downloading and viewing right through to editing and printing.
 - Image display options to suit a range of applications
 - 3 types of image list display (Zoom, Scroll and Preview)

- "Viewer window" with individual image display and multiple-image comparison display
- Slide show display
- Convenient image management functions
 - Image classifying by shooting date/time
 - Batch file renaming
 - Displayed image selection by rating or keyword
 - Image searching by shooting date, modification date, rating, comment or keyword
- Extensive range of JPEG image editing functions
 - Red-eye correction, automatic image adjustment, color and brightness (color adjustment, levels adjustment and tone curve), sharpness, trimming, captioning
 - Image rotation (90° to the left or right, or rotation by 180°)
 - Image transfer to third-party image editing software
- Panorama image merging
 - Automatic merging of panorama shots by linking with PhotoStitch
- RAW image processing that conforms to the camera processing
 - RAW image processing by linking with RAW Image Task
 - Processing that conforms to the camera's image processing characteristics
- Simple print functions matched to a range of applications
 - Single-page printing (automatic settings)
 - Index printing
 - Printing with Easy-PhotoPrint
- Extensive range of image exporting functions
 - Converting and saving JPEG images as BMP or TIFF images
 - Exporting of shooting information
 - Exporting images as screensavers or wallpaper
 - Writing images to CD-R or CD-RW
- Various types of connection to CANON iIMAGE GATEWAY
- Linking with e-mail software to send images as e-mail attachments
- Support for Color Management System
 - Support for 2 types of work color space (sRGB and Adobe RGB)

4) RAW Image Task Ver.2.7

- RAW image processing software linked to ZB/IB
 - Allows RAW images selected in ZB/IB to be processed in RAW Image Task.
 - Allows the user to apply image adjustments to RAW images (using processing parameter settings) with no loss of image quality.
- Processing faithful to the camera
 - Algorithms tailored to the camera ensure that images are processed with the same processing characteristics as those used on the camera.
 - Allows the user to set the same processing parameters used on the camera or use modified parameters.
- Support for RAW images from almost all EOS DIGITAL camera models.
 - * RAW images from the EOS D6000, EOS D2000, EOS DCS1 and EOS DCS3 are not supported.
 - * EOS D6000 and EOS D2000 RAW images converted using the CR2 converter are also not supported.
- Image conversion/saving as TIFF or JPEG images and the addition of ICC profiles
- Support for Color Management System
 - Support for 2 types of work color space (sRGB and Adobe RGB)

5) **PhotoStitch Ver.3.1**

● JPEG image merging software linked to ZB/IB

- Uses simple procedures to create composite images such as panorama shots.
- Uses a wizard-type interface that caters to novice users.

6) **CameraWindow MC Ver.6.3 (Windows)/6.4 (Macintosh)**

● Image downloading software for use with card readers linked to ZB/IB.

1.3 Software Configuration and System Requirements

1) Configuration

EOS DIGITAL SOLUTION DISK Ver.15 is made up of the software applications shown below. The main changes from version 14 are EOS 40D compatibility and the addition of a new application, Picture Style Editor (indicated by the colored cells in Table 001).

Table 001 EOS DIGITAL Solution Disk Ver. 15 Software Configuration

	Name	Ver.	Windows OS	Mac OS	
				Power PC	Intel
1	EOS Utility	2.1	Yes	Yes	Yes ^{*1}
2	Digital Photo Professional	3.1	Yes	Yes	Yes ^{*1}
3	ZoomBrowser EX	5.8c	Yes	No	No
4	ImageBrowser	5.8c	No	Yes	Yes ^{*2}
5	RAW Image Task ^{*3}	2.7	Yes	Yes	Yes ^{*2}
6	PhotoStitch	3.1	Yes	Yes	Yes ^{*2}
7	CameraWindow MC ^{*3}	6.3/6.4	Yes	Yes	Yes ^{*2}
8	Picture Style Editor	1.0	Yes	Yes	Yes ^{*1}
9	PTP TWAIN Driver	1.5	Yes	No	No
10	WFT Utility	3.1	Yes	Yes	Yes ^{*1}
11	Original Data Security Tools	1.1	Yes	No	No

*1: Because it uses UB (Universal Binary) to provide native-level compatibility, it will run at the speed of a native application on Macintosh machines with Intel CPUs.

*2: Because it runs on Rosetta, it runs slightly slower than UB-compatible applications.

*3: Cannot be launched as a standalone application. Functions with or is launched by 3 or 4.

2) Modes and Supported Cameras

EOS DIGITAL SOLUTION DISK Ver.15 consists of a single CD that contains software applications listed in "1) Configuration". The software is available in 7 languages: Japanese, English, French, German, Italian, Spanish and Chinese (simplified). As with Solution Disk Ver. 14, version 15 is available in 3 region-specific versions (Table 002).

Table 002 Region-specific Versions of Solution Disk and the Supported Languages

Region-specific Versions of Solution Disk	Japanese	English	Chinese	French	Spanish	German	Italian
Japan, China, Asia	Yes	Yes	Yes	No	No	No	No
North/South America	No	Yes	No	Yes	Yes	No	No
Europe	No	Yes	No	No	No	Yes	Yes

EOS DIGITAL SOLUTION DISK Ver.15 will only be bundled with 1 camera model, the EOS 40D. As in the past, the software update modules included on EOS DIGITAL SOLUTION DISK Ver.15 will be available to all EOS users as downloads from the Canon website.

The EOS DIGITAL SOLUTION DISK Ver.15 Instruction Manual (PDF) will be supplied on a separate documentation CD.

3) System Requirements

Tables 003 and 004 show the system requirements for each software application. There are no changes from version 14.

Table 003 System Requirements for Windows

Software	EOS Utility	Digital Photo Professional, Picture Style Editor	ZoomBrowser EX, CameraWindow MC, RAW Image Task, PhotoStitch
OS	Windows Vista (all versions for 32-bit or 64-bit systems except the Starter Edition), Windows XP Service Pack 2 (Home Edition/Professional), Windows 2000 Service Pack 4		
Model	PC equipped with an OHCI-compliant IEEE1394 port or USB port as a standard feature and one of the above OS pre-installed ^(*1)	PC with one of the above OS pre-installed ^(*1)	
CPU	Vista	1.3 GHz Pentium or higher	
	XP, 2000	750 MHz Pentium or higher	500 MHz Pentium or higher
RAM	Vista	Minimum 512 MB	Minimum 512 MB
	XP, 2000	Minimum 256 MB	Minimum 256 MB
Interface	USB 1.1 to 2.0 Hi-Speed ^(*2) , IEEE1394		
Display	Screen resolution: 1024 × 768 pixels or more; Colors: Medium (16 bit) or more		

Table 004 System Requirements for Macintosh

Software	EOS Utility	Digital Photo Professional, Picture Style Editor	ImageBrowser, CameraWindow MC, RAW Image Task, PhotoStitch
OS	Mac OS X 10.3 to 10.4 ^(*3)		
Model	Macintosh equipped with a FireWire (IEEE1394) port or USB port as a standard feature and one of the above OS installed	Macintosh with one of the above OS installed	
CPU	400 MHz Power PC G3 or higher, G4, G5 or Intel processor ^(*4)		Power PC G3, G4, G5 or Intel processor
RAM	Minimum 256 MB	Minimum 512 MB	Minimum 256 MB
Interface	USB 1.1 to 2.0 Hi-Speed ^(*2) , IEEE1394		
Display	Resolution: 1024 × 768 pixels or more; Colors : Thousands or more		

*1: Upgraded machines not supported.

*2: USB 2.0 Hi-Speed is supported on the EOS 40D, EOS-1D Mark III, EOS 5D, EOS 30D, EOS 20D, EOS DIGITAL REBEL XT/350D DIGITAL and EOS DIGITAL REBEL XTi/400D DIGITAL.

*3: The Macintosh UFS (UNIX File System) format is not supported.

*4: To run EOS Utility on Macintosh machines equipped with Intel processors, Mac OS X 10.4.7 or later must be installed.

1.4 Software Overview

The details of each of the software applications are described below.

1) EOS Utility Ver.2.1 (hereafter EU)

This is software used for communication between EOS DIGITAL and your computer. The main functions of EU are downloading images from your camera to a computer, specifying camera settings from the computer, and remote shooting.

The only changes from version 2.0 are the addition of the EOS 40D as a supported camera and the addition of the Picture Style Editor startup/linkage function in the main window.

The specifications* for EOS 40D connection are the same as those for the EOS-1D Mark III.

*Excludes the "Aspect Ratio" setting in the Remote Live View Shooting function.

2) Digital Photo Professional Ver.3.1 (hereafter DPP)

This is image viewing/processing/editing software for EOS DIGITAL RAW images and is aimed at amateur and professional users who work primarily with RAW images.

The only change from version 3.0 is support for EOS 40D RAW images.

3) Picture Style Editor Ver.1.0 (hereafter PSE)

This software is intended primarily for high-end amateur and professional users and can be used to create original Picture Style files.

*For details of the Picture Style Editor, please refer to the Appendix.

4) ZoomBrowser EX Ver.5.8c

This image viewing/editing/management software is aimed primarily at novice and amateur Windows users. This software is bundled with all Canon digital camera models.

The only change from version 5.8b is support for images shot using a EOS 40D (including RAW images).

*Version 5.8b is included on the EOS DIGITAL Solution Disk Ver. 14.

5) ImageBrowser Ver.5.8c

This image viewing/editing/management software is aimed primarily at novice and amateur Macintosh users. This software is bundled with all Canon digital camera models.

The only change from version 5.8b is support for images shot using a EOS 40D (including RAW images).

*Version 5.8b is included on the EOS DIGITAL Solution Disk Ver. 14.

6) Raw Image Task Ver.2.7

This is RAW image processing software that runs in conjunction with 4) or 5). This software is bundled with all Canon digital camera models equipped with a RAW image shooting function.

The only change from version 2.6 is support for RAW images shot on a EOS 40D.

7) PhotoStitch Ver.3.1

This is JPEG panorama image merging software that runs in conjunction with 4) or 5). This software is bundled with all Canon digital camera models. This is the same version as the software bundled with all Canon digital cameras released in Spring 2007.

8) CameraWindow MC Ver.6.3 (Windows)/6.4 (Macintosh)

This is image downloading software for use with card readers and runs in conjunction with 4) or 5). This software is bundled with all Canon digital camera models. This is the same version as the software bundled with all Canon digital cameras released in Spring 2007.

9) PTP TWAIN Driver Ver.1.5

This is software for controlling communication between the camera and PCs running Windows 2000. If this driver is not installed, the camera cannot communicate with PCs running Windows 2000.

* When a EOS 40D, EOS-1D Mark III, EOS 30D or EOS DIGITAL REBEL XTi/400D DIGITAL is connected to a PC with Windows XP or Windows Vista installed, the standard OS functions are used so there is no need for a separate driver.

10) WFT Utility Ver.3.1

This is software for the WFT-E3 and the WFT-E2/E2A and -E1/E1A Wireless File Transmitters, which are available as optional accessories.

11) Original Data Security Tools Ver.1.0

This is software for the Original Data Security Kit OSK-E3, which is available as an optional accessory.

1.5 Additional Notes

1) Additional Notes on Digital Photo Professional

(1)[RAW] tool palette

This is a tool palette for making adjustments to RAW images. Adjustments similar to those that can be performed with the functions of your camera can be performed. Where camera settings were incorrect when a shot was taken or where the results are not what you intended, you can approximate your desired shot with the [RAW] tool palette.

(2)[RGB] tool palette

This is a tool palette for making adjustments to RAW, JPEG or TIFF images. The [RGB] tool palette functions are the same as ordinary image editing software. The width of the adjustment in the [RGB] tool palette is wider than the [RAW] tool palette.

(3)[NR] Noise Reduction tool palette

This allows you to reduce the level of noise in images shot at night or with high ISO speed settings. The types of noise reduction available for RAW images differ from those provided for JPEG and TIFF images. With RAW images, you can reduce both luminance noise and chrominance noise, but with JPEG and TIFF images you can only reduce chrominance noise.

(4)Using the different tool palettes

We recommend that as a general principle you adjust RAW images using the [RAW] tool palette. However, where the adjustment width with the [RAW] tool palette is not wide enough or you wish to use the special functions in the [RGB] tool palette, we recommend that you adjust your images at the necessary lowest limit with the [RGB] tool palette after having completed basic adjustment with the [RAW] tool palette. Note that the [NR] tool palette should only be used where noise reduction is required after necessary adjustments have been made with the [RAW] and [RGB] tool palettes.

(5)Recipes

You can save all the adjustments you make using the tool palettes (the image processing conditions information) with the image as a file called a "recipe". In any case, adjustments are not made to your original image, which is retained in its original condition. You can copy recipes, apply them to other images, and save or load them as separate files distinct from the image.

2) Additional Notes on EOS Utility

(1)Camera operation when the EOS 40D or EOS-1D Mark III is connected and Remote Live View shooting is active.

To operate the camera with the Remote Live View window is displayed, press the camera's <SET> button. The Live View image is then displayed on the camera's rear LCD monitor, and you can operate the camera.

Appendix

Trademarks

The product names and company names described in this Service Manual are the registered trademarks of the individual companies.

Copyright

Canon Inc. retains the copyright to this Service Manual. Reproduction, publication (including on the World Wide Web), alteration, translation into another language, or other use of the data in whole or part, contained on this Service Manual without the written consent of Canon Inc. is prohibited.

CONTENTS

	Page
Appendix	
1. Overview	1
2. PSE Functions	2
2.1 Preparations	2
2.2 Editing	4
2.3 Save	14
2.4 Using Picture Style files	15
3. System Requirements and Supported Languages	16

1. OVERVIEW

The Picture Style Editor (hereinafter PSE), as the name suggests, is software that allows users to create their own Picture Style files. To create his or her own Picture Style file, the user selects and loads a sample RAW image and then adjusts the image characteristics based on one of existing Picture Styles (Standard, Portrait, Landscape, Neutral or Faithful) except for Monochrome.

The created Picture Style file can then be registered in the camera using EOS Utility (hereinafter EU) or used in the Digital Photo Professional (hereinafter DPP) or RAW Image Task (hereinafter RIT) applications.

● Settings that can be adjusted in PSE

① Existing Picture Style Detail settings

- Color Tone, Color saturation, Contrast and Sharpness adjustments

② Color specification and individual minute adjustments to specified colors

- Selection of a specific color in the sample image and adjustment of the hue, saturation and luminosity
- Minute adjustments to the gamma characteristics (tone curve)

The settings in ① were previously available either on the camera or in EU, so that the results of any adjustments had to be checked later after the picture had actually been taken. With PSE, the results of adjustment can be checked in real time. The adjustments in ② are available for the first time (with realtime checking) with PSE.

And up to 100 color points can be selected in the color specifications provided in ②.

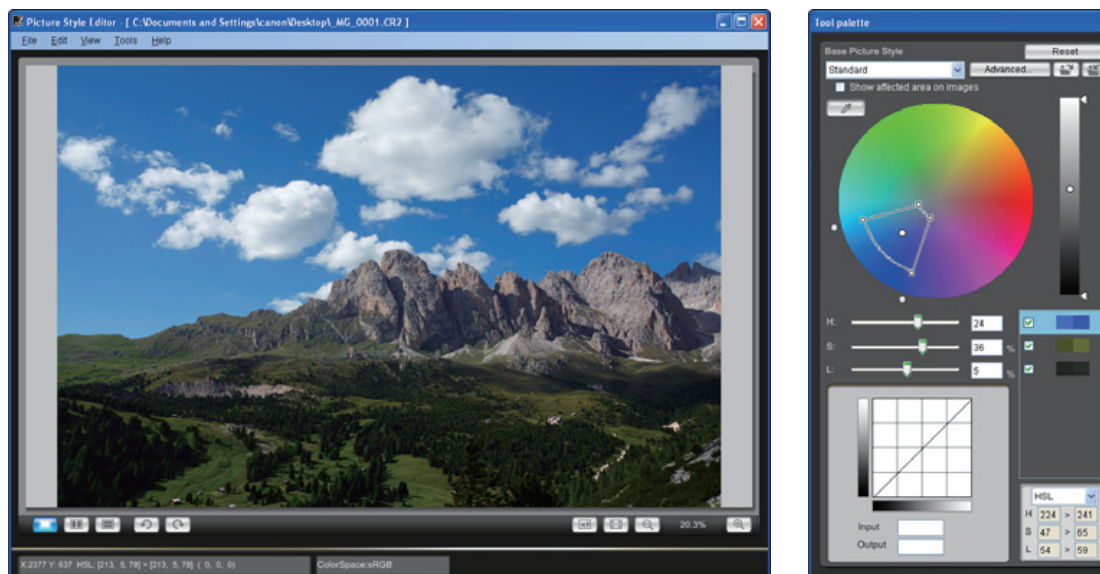

Fig. 001 PSE main window and tool palette

2. PSE FUNCTIONS

2.1 Preparations

1) Preparing a sample RAW image

To create a Picture Style file, the user first selects a sample image.

PSE version 1.0 only supports RAW images shot on EOS 40D as sample images.

To ensure that the sample image is adjusted accurately in PSE, the image should also meet the following conditions:

- Images shot with the correct exposure/white balance
- Images shot under the same environment as that be used for the created Picture Style file

2) Preliminary adjustments to sample images

As mentioned in 1) above, sample images used in the adjustments should ideally have been shot with the correct exposure/white balance. However, if this was not the case for the sample image to be used, the image can be adjusted within set limits in the [Preliminary Adjustment] window.

The [Preliminary Adjustment] window is opened by selecting [Preliminary Adjustment] in the [Tools] menu and can be used to adjust the exposure and white balance for a sample image.

The adjustments in the [Preliminary Adjustment] window are really intended only as a supplementary function to ensure that adjustments made using the tool palette are accurate. As such, the adjustments are not applied in the Picture Style file and are not saved in the sample image.

If the sample image used was shot with the correct exposure/white balance, there is no need to use preliminary adjustment.

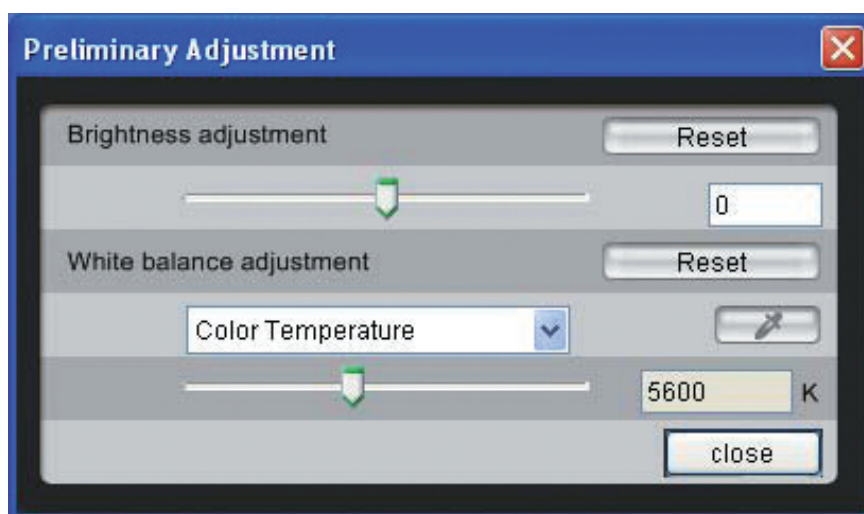

Fig. 002 Preliminary Adjustments window

3) Selecting the color space

PSE supports the sRGB and Adobe RGB color spaces. You can use the [Preferences] window to set the color space for the sample image used in the adjustments and to set the profile for your monitor.

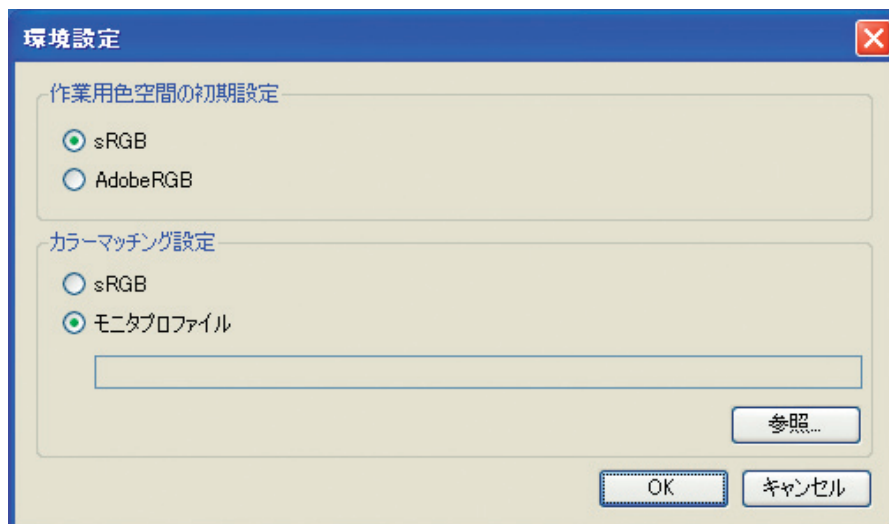

Fig. 003 Preferences window

2.2 Editing

1) Edit window configuration

In PSE, the 3 windows listed below can be used for most of the tasks involved in creating Picture Style files.

- Main window: Displays the sample image.
- Navigator window: Displays the position of a magnified image and also displays histograms.
- Tool palette: Provides the adjustment functions.

Also, because the results of adjustments made using the tool palette functions are immediately applied to the sample image shown in the main window, you can check the results of your adjustments in real time as you work.

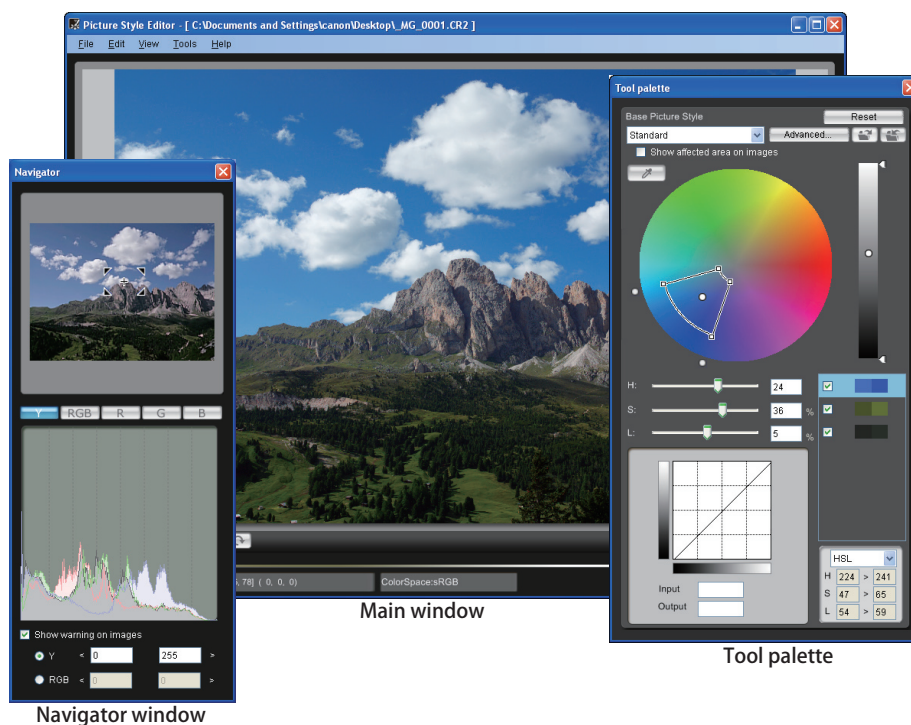

Fig. 004 Main windows in PSE

(1) Main window

You can display a sample image in the main window either by dragging & dropping the image onto the window or by selecting [Open Image] in the [File] menu.

The functions of the main window are as follows:

- Display mode switching: Normal view (single image display) and before and after adjustment comparison display (top/bottom split or left/right split)
- Image rotation: Left or right in 90° increments
- Display magnification switching: Full view, 12.5%, 25%, 50%, 100% and 200%
- Cursor coordinates position and RGB values (8-bit conversion) display
- Work color space display

Note that the sample image is processed and displayed using the camera settings used when the picture was taken.

* Adjustments made in DPP or RIT after shooting are not applied to the sample image.

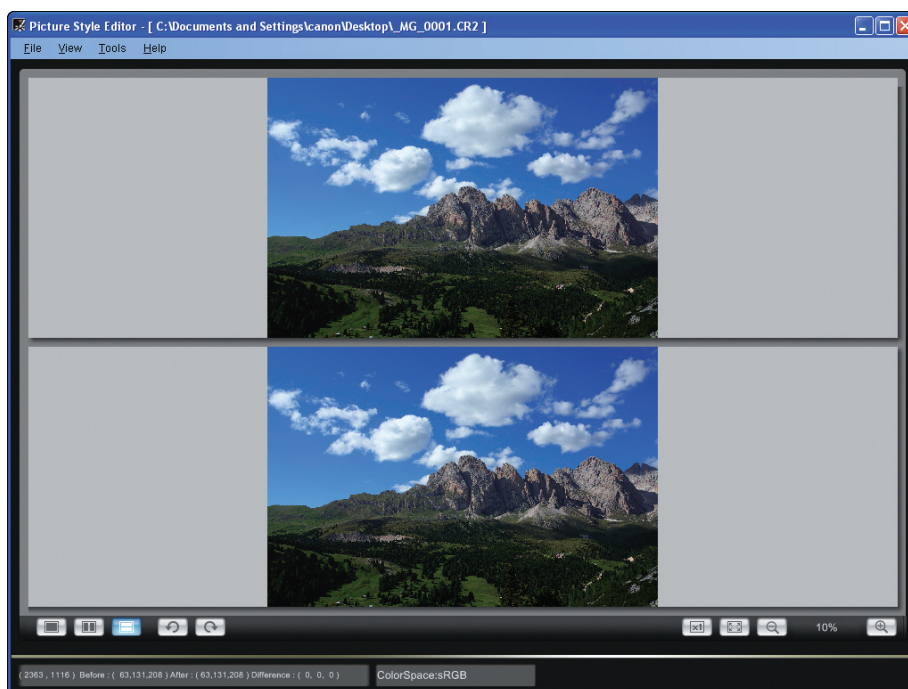

Fig. 005 Main window (before and after adjustment comparison display, top/bottom split)

(2) Navigator window

This window supplements the operations performed in the main window and tool palette and offers the following functions:

① Enlargement display position

This shows the position displayed when the sample image in the main window is enlarged. You can also use this window to drag the enlargement display position around. The sample image in the main window changes in response.

② Histogram display

The histogram shows the distribution of luminance and color components in the sample image displayed in the main window.

The histogram display can be switched using the [Y] (luminance), [RGB], [R], [G] and [B] buttons.

③ Warning indicator setting

If you enter or set upper and lower limits in these fields and there are areas in the sample image displayed in the main window with values that exceed those limits, this feature flashes warnings in the image.

You can choose either [Y] (luminance) or [RGB] (color value) as the warning to be used.



Fig. 006 Navigator window

(3) Tool palette

You can use this tool palette to make a range of adjustments to the image characteristics of a Picture Style file while observing the effects of those changes in the main window. The functions of the tool palette are as follows:

- Selecting the Picture Style used as the basis for your new Picture Style
- Adjusting the color tone, color saturation, contrast and sharpness
- Making minute adjustments to a specified color (hue, saturation and luminosity)
- Adjusting the gamma characteristics

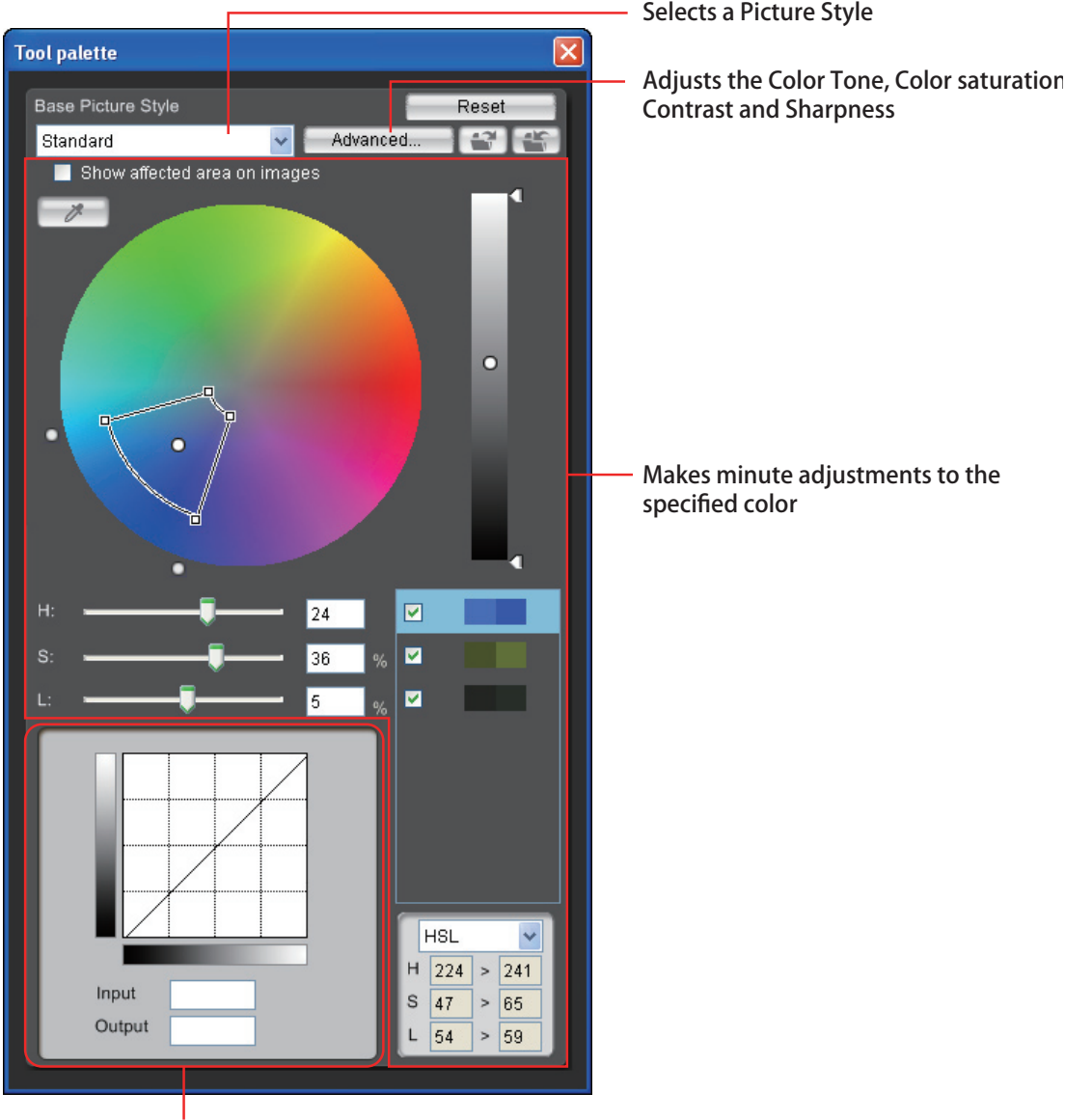

Fig. 007 Tool palette

* PSE uses the DPP algorithms for image processing. This means that the color tones produced by tool palette adjustments tend to be the same as those made in DPP.

2) Editing Picture Styles

(1) Selecting a Picture Style

You can choose any of the 5 preset Picture Styles (Standard, Portrait, Landscape, Neutral or Faithful) (except for Monochrome) as the starting point for Picture Style to be used as a basis.

* You can also download and select one of the purpose-made Picture Style files (e.g. Emerald) from the Canon web site.

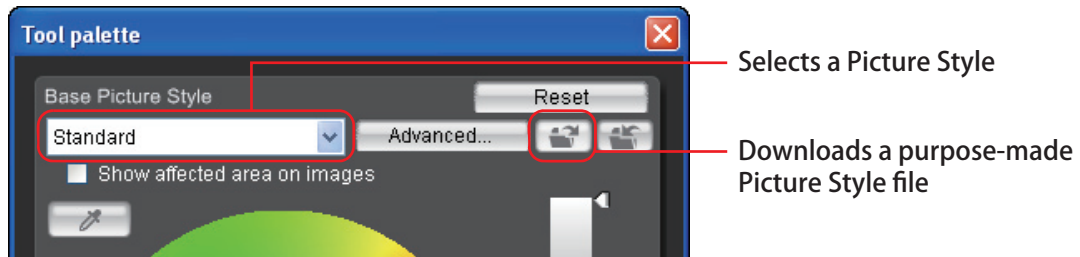

Fig. 008 Picture Style selection

(2) Adjusting the color tone, color saturation, contrast and sharpness

Clicking the [Advanced] button in the tool palette displays the [Advanced Picture Style Settings] window, where you can adjust the [Color Tone], [Color saturation], [Contrast] and [Sharpness] settings.

Note that simply changing the adjustments does not apply those changes to the sample image in the main window. You must click the [OK] button to see the effect of the changes in the sample image.

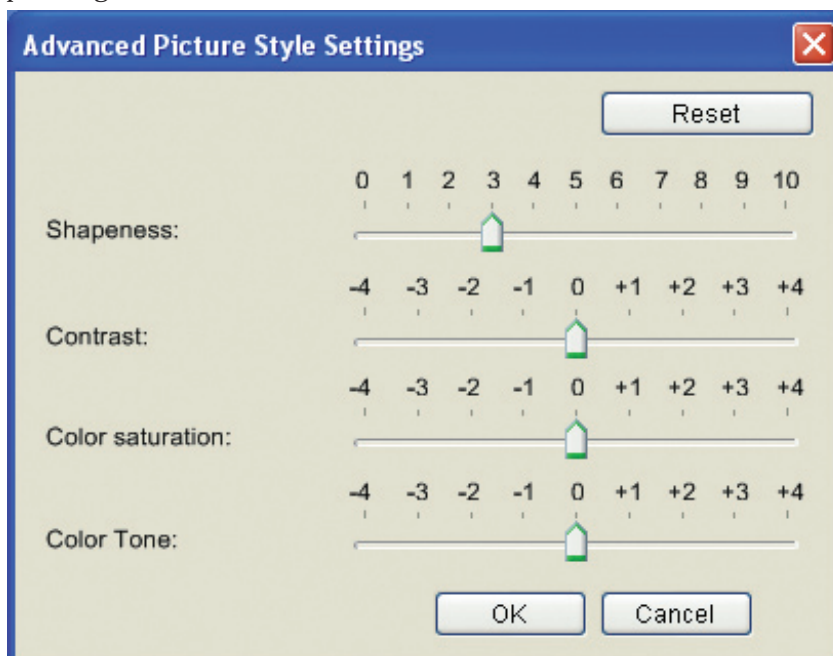

Fig. 009 Advanced Picture Style Settings window

(3) Making minute adjustments to specified colors

This feature allows you fine tune a specified color to any color you like. And the results of your adjustments are applied to the sample image in the main window in real time.

① Specifying the color to be adjusted and the available adjustments

If you click the eye-dropper button and then click the location of the color you want to adjust in the sample image, the specified color is plotted as an adjustment point (Two adjustment points appear, one for hue and saturation and the other for luminosity.) on the color wheel. You can then fine-tune the color in the plotted adjustment points using the [H] (hue), [S] (saturation) and [L] (luminosity) sliders.

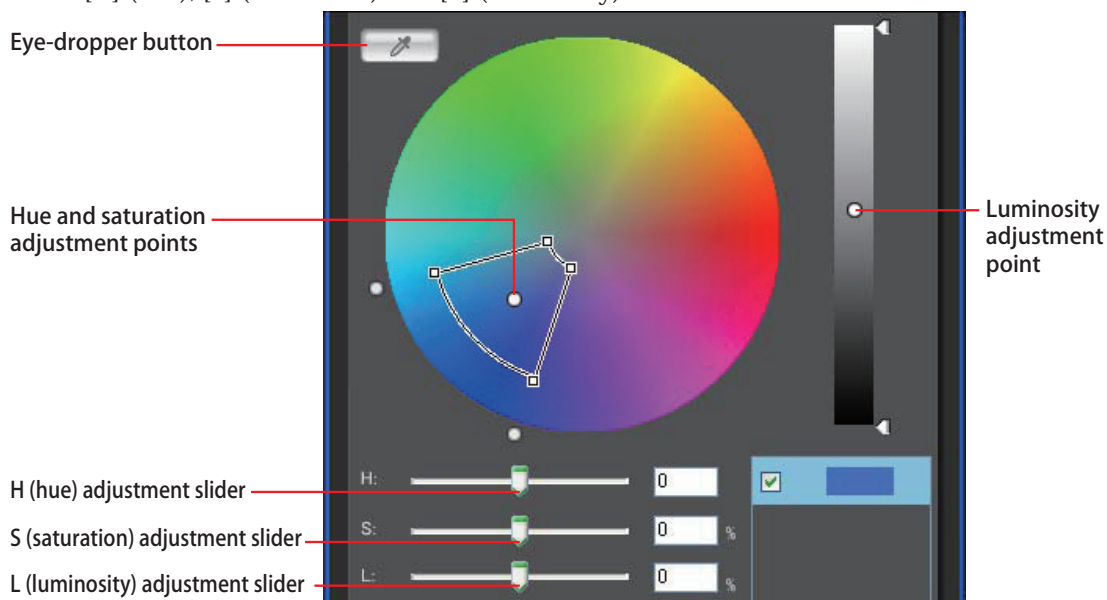

Fig. 010 Panel for minute color adjustment

- * As well as specifying the color by clicking in the image, you can also specify a target color by clicking the color directly in the color wheel. However, bear in mind that this method does not show you the location of the specified color in the sample image.
- * You can also color by selecting [Specify the numerical values for color adjustment] in the [Edit] menu, which then allows you to specify the color by entering the color value in the [Specify the numerical values for color adjustment] window.
- * H, S and L stand for Hue, Saturation and Luminosity respectively.
- * If you change the work color space in the preferences window during the adjustment process, the adjustment points in the tool palette also move in response.

②Setting the range of effect of adjustments

When you change the color of an adjustment point, the change also affects the surrounding colors.

In PSE, you can specify three settings "hue", "saturation" and "luminosity" the same elements as the adjustment settings for this range of effect on the surrounding colors.

You can specify any range setting by dragging the points that indicate the respective range of effect for "hue", "saturation" and "luminosity".

The available ranges of effect are 30 to 180 degrees for "hue", 30 to 100 for "saturation", and 30 to 100 for "luminosity".

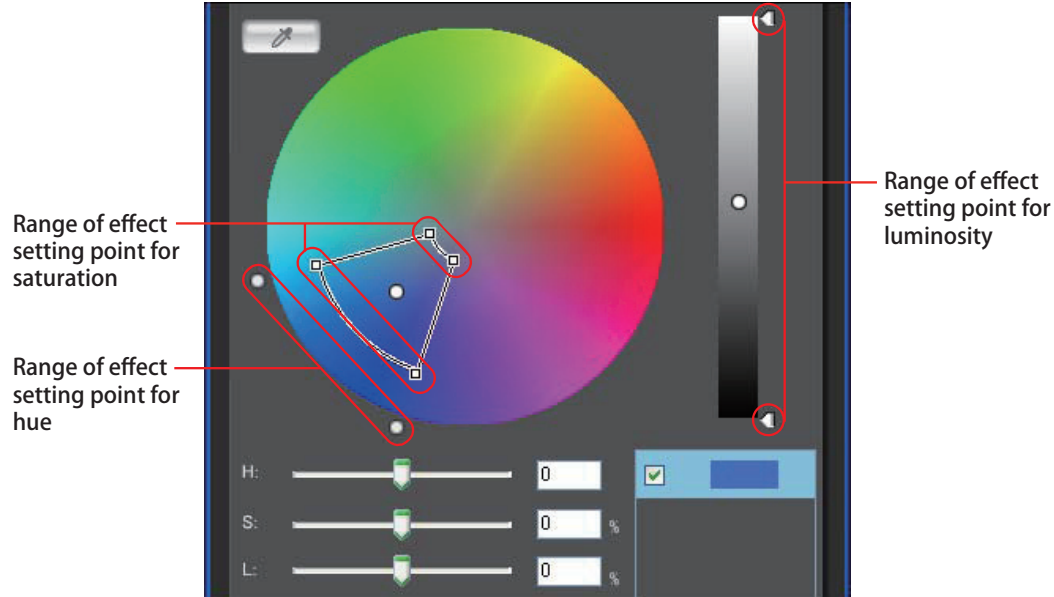

Fig. 011 Range of effect settings for colors

③Displaying the adjustment color list

You can specify up to 100 color adjustment points, and the adjusted colors will be displayed on the adjustment color list.

The adjustment color list displays and their functions are as follows:

- Colors before and after adjustment
- Apply/Do not apply checkbox
- Range of effect overlap indicator

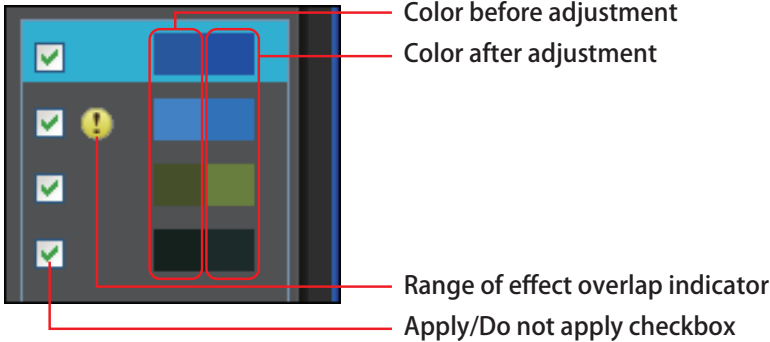

Fig. 012 Adjustment color list

The range of effect overlap indicator is displayed if the range of effect of an adjusted color overlaps the range of effect of another adjusted color. Colors in overlapping ranges are displayed in gary on the color wheel and adjusted using an aggregated value for the respective adjustments.

To avoid overlapping ranges, you must reset the ranges of effect so that they no longer overlap.

Moreover, you can delete an adjusted color by selecting the color in the adjustment color list and pressing the key on the keyboard.

④Switching the color display mode and the color value display

When you choose an adjustment setting for the color selected in the adjustment color list, the color values before and after adjustment of the chosen color display mode are displayed and you can check them.

You can choose from 3 color display modes: HSL, Lab or RGB.

In the HSL color display mode only, you can also enter the color value after adjustment and make fine adjustments.

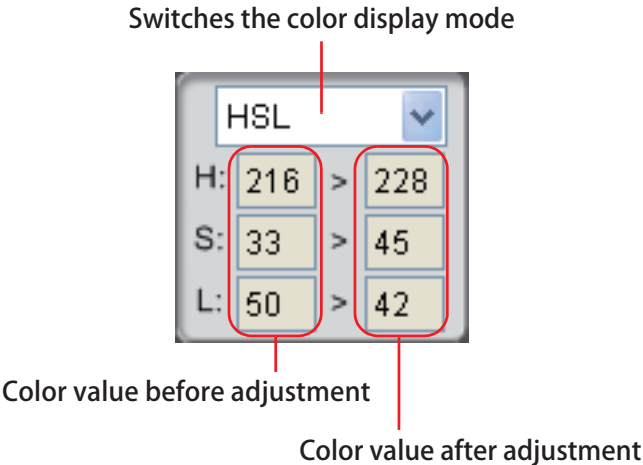
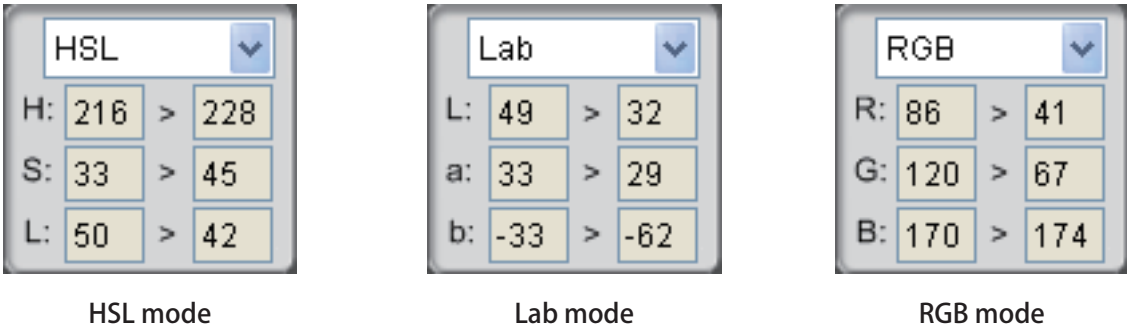

Fig. 013 Color display modes and color value displays



A color mode in which colors are represented in terms of 3 factors: H (Hue), S (Saturation) and L (Luminosity).

A color mode developed by the CIE (Commission Internationale d'Eclairage) where "L" denotes lightness, "a" denotes the color elements from green to magenta and "b" denotes the color elements from blue to yellow.

A color mode in which colors are represented using the three primary colors (and the additive color mixtures) of the visible light spectrum: red (R), green (G) and blue (B).

Fig. 014 Display with each color display mode

(4) Adjusting the gamma characteristics

You can adjust the gamma characteristics of an image using the tone curve.

By creating up to 10 adjustment points anywhere along the tone curve, you can freely adjust the brightness and contrast.

And the results of your adjustments are applied to the sample image in the main window in real time.

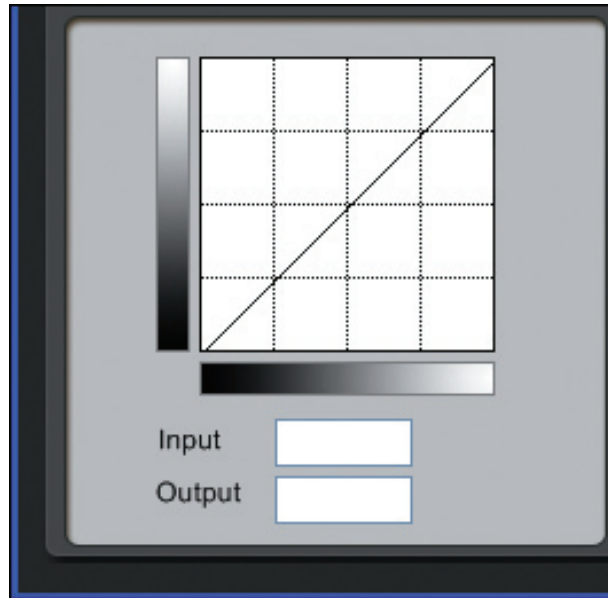

Fig. 015 Adjusting the gamma characteristics

2.3 Save

You can save all the adjustments you have made with the tool palette as an original Picture Style file (with the .PF2 extension).^{*1}

Adjustments are saved in the save window, which appears when you click the save window display button in the tool palette.

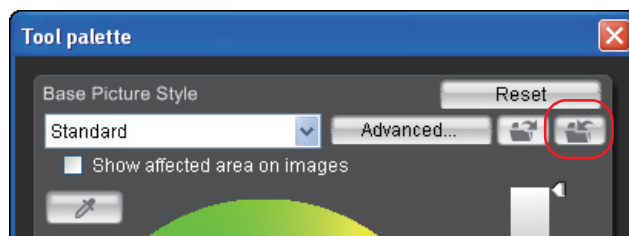

Fig. 016 Save window display button

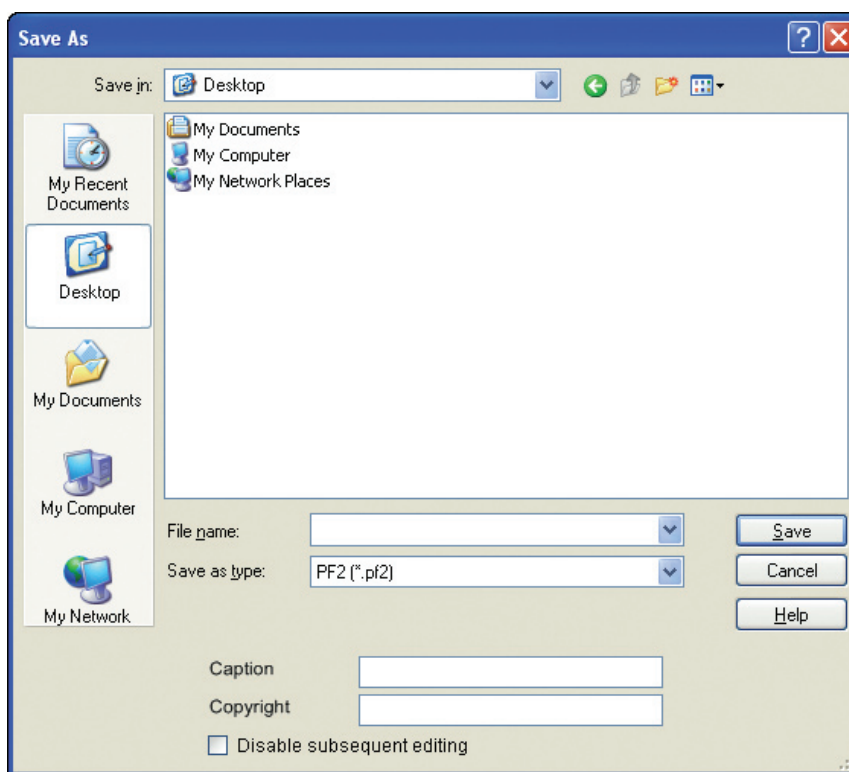

Fig. 017 Save window

When you save the file, there is a [Disable subsequent editing] checkbox that prevents disclosure of the adjustments made in PSE as well as any captions or copyright information. Picture Style files that have been saved with the [Disable subsequent editing] checkbox ticked can be used in cameras and in DPP in the same way as ordinary Picture Style files. However, because they can no longer be opened in PSE^{*2}, you cannot check the adjustments.

*1: Because adjustments made in PSE are saved in Picture Style files, they are not saved in the sample image used for the adjustment process.

*2: We recommend that you also save a separate copy of the Picture Style file without the [Disable subsequent editing] checkbox ticked.

2.4 Using Picture Style files

Like purpose-made Picture Style files downloaded from the Canon web site, saved Picture Style files can be registered and used in cameras and used in the DPP and RIT applications.

1) Using Picture Style files in cameras

You can use EU to register a Picture Style file in a camera equipped with the Picture Style function and then apply the file to photographed images.

2) Using Picture Style files with DPP

You can use DPP to apply Picture Style files to any compatible RAW image.

3) Using Picture Style files with RIT

You can use RIT to apply Picture Style files to RAW images shot on cameras equipped with the Picture Style function.

3. SYSTEM REQUIREMENTS AND SUPPORTED LANGUAGES

Table 001 shows the system requirements for PSE. The software is available in 7 languages: Japanese, English, French, German, Italian, Spanish and Chinese (simplified).

Table 001 System requirements

	Windows	Macintosh
OS	Windows Vista (all versions for 32/64-bit systems except the Starter Edition)	Mac OS X 10.3 to 10.4
	Windows XP Service Pack 2 (Home Edition/Professional)	
	Windows XP Service Pack 4	
Model	PC with one of the above OS pre-installed * Upgraded machines not supported * .NET Framework 2.0 or later is required	Macintosh with one of the above OS installed
CPU	Vista: 1.3 GHz Pentium or higher	400 MHz Power PC G3 or higher, G4, G5 or Intel processor
	XP, 2000: 750 MHz Pentium or higher	
RAM	Vista : Minimum 1 GB	Minimum 512 MB
	XP, 2000: Minimum 512 MB	
Display	Screen resolution: 1024 × 768 pixels or more; Colors: Medium (16 bit) or more	Resolution: 1024 × 768 pixels or more; Colors: Thousands or more