

RIGOL

User's Guide

DS1000Z Series Digital Oscilloscope

Jan. 2014

RIGOL Technologies, Inc.

Guaranty and Declaration

Copyright

© 2013 RIGOL Technologies, Inc. All Rights Reserved.

Trademark Information

RIGOL is a registered trademark of RIGOL Technologies, Inc.

Publication Number

UGA17102-1112

Notices

- **RIGOL** products are protected by patent law in and outside of P.R.C.
- **RIGOL** reserves the right to modify or change parts of or all the specifications and pricing policies at company's sole decision.
- Information in this publication replaces all previously corresponding material.
- **RIGOL** shall not be liable for losses caused by either incidental or consequential in connection with the furnishing, use or performance of this manual as well as any information contained.
- Any part of this document is forbidden to be copied or photocopied or rearranged without prior written approval of **RIGOL**.

Product Certification

RIGOL guarantees this product conforms to the national and industrial standards in China as well as the ISO9001:2008 standard and the ISO14001:2004 standard. Other international standard conformance certification is in progress.

Contact Us

If you have any problem or requirement when using our products or this manual, please contact **RIGOL**.

E-mail: service@rigol.com

Websites: www.rigol.com

Safety Requirement

General Safety Summary

Please review the following safety precautions carefully before putting the instrument into operation so as to avoid any personal injury or damage to the instrument and any product connected to it. To prevent potential hazards, please use the instrument only specified by this manual.

Use Proper Power Cord.

Only the power cord designed for the instrument and authorized for use within the local country could be used.

Ground The Instrument.

The instrument is grounded through the Protective Earth lead of the power cord. To avoid electric shock, it is essential to connect the earth terminal of power cord to the Protective Earth terminal before any inputs or outputs.

Connect the Probe Correctly.

If a probe is used, do not connect the ground lead to high voltage since it has the isobaric electric potential as ground.

Observe All Terminal Ratings.

To avoid fire or shock hazard, observe all ratings and markers on the instrument and check your manual for more information about ratings before connecting.

Use Proper Overvoltage Protection.

Make sure that no overvoltage (such as that caused by a thunderstorm) can reach the product, or else the operator might expose to danger of electrical shock.

Do Not Operate Without Covers.

Do not operate the instrument with covers or panels removed.

Do Not Insert Anything into the Holes of Fan.

Do not insert anything into the holes of the fan to avoid damaging the instrument.

Use Proper Fuse.

Please use the specified fuses.

Avoid Circuit or Wire Exposure.

Do not touch exposed junctions and components when the unit is powered.

Do Not Operate With Suspected Failures.

If you suspect damage occurs to the instrument, have it inspected by qualified service personnel before further operations. Any maintenance, adjustment or replacement especially to circuits or accessories must be performed by **RIGOL** authorized personnel.

Keep Well Ventilation.

Inadequate ventilation may cause increasing of temperature or damages to the device. So please keep well ventilated and inspect the intake and fan regularly.

Do Not Operate in Wet Conditions.

In order to avoid short circuiting to the interior of the device or electric shock, please do not operate in a humid environment.

Do Not Operate in an Explosive Atmosphere.

In order to avoid damages to the device or personal injuries, it is important to operate the device away from an explosive atmosphere.

Keep Product Surfaces Clean and Dry.

To avoid the influence of dust and/or moisture in air, please keep the surface of device clean and dry.

Electrostatic Prevention.

Operate in an electrostatic discharge protective area environment to avoid damages induced by static discharges. Always ground both the internal and external conductors of the cable to release static before connecting.

Handling Safety.

Please handle with care during transportation to avoid damages to buttons, knob interfaces and other parts on the panels.

Safety Terms and Symbols

Terms Used in this Manual. These terms may appear in this manual:



WARNING

Warning statements indicate the conditions or practices that could result in injury or loss of life.



CAUTION

Caution statements indicate the conditions or practices that could result in damage to this product or other property.

Terms Used on the Product. These terms may appear on the Product:

DANGER indicates an injury or hazard may immediately happen.

WARNING indicates an injury or hazard may be accessible potentially.

CAUTION indicates potential damage to the instrument or other property might occur.

Symbols Used on the Product. These symbols may appear on the product:



Hazardous Voltage



Safety Warning



Protective Earth Terminal



Chassis Ground



Test Ground

Allgemeine Sicherheits Informationen

Überprüfen Sie die folgenden Sicherheitshinweise sorgfältig, um Personenschäden oder Schäden am Gerät und an damit verbundenen weiteren Geräten zu vermeiden. Zur Vermeidung von Gefahren, nutzen Sie bitte das Gerät nur so, wie in diesem Handbuche angegeben.

Um Feuer oder Verletzungen zu vermeiden, verwenden Sie ein ordnungsgemäßes Netzkabel.

Verwenden Sie für dieses Gerät nur das für ihr Land zugelassene und genehmigte Netzkabel.

Erden des Gerätes.

Das Gerät ist durch den Schutzleiter im Netzkabel geerdet. Um Gefahren durch elektrischen Schlag zu vermeiden, ist es unerlässlich, die Erdung durchzuführen. Erst dann dürfen weitere Ein- oder Ausgänge verbunden werden.

Anschluss eines Tastkopfes.

Die Erdungsklemmen der Sonden sind auf dem gleichen Spannungspegel des Instruments geerdet. Schließen Sie die Erdungsklemmen an keine hohe Spannung an.

Beachten Sie alle Anschlüsse.

Zur Vermeidung von Feuer oder Stromschlag, beachten Sie alle Bemerkungen und Markierungen auf dem Instrument. Befolgen Sie die Bedienungsanleitung für weitere Informationen, bevor Sie weitere Anschlüsse an das Instrument legen.

Verwenden Sie einen geeigneten Überspannungsschutz.

Stellen Sie sicher, daß keinerlei Überspannung (wie z.B. durch Gewitter verursacht) das Gerät erreichen kann. Andernfalls besteht für den Anwender die Gefahr eines Stromschlages.

Nicht ohne Abdeckung einschalten.

Betreiben Sie das Gerät nicht mit entfernten Gehäuse-Abdeckungen.

Betreiben Sie das Gerät nicht geöffnet.

Der Betrieb mit offenen oder entfernten Gehäuseteilen ist nicht zulässig. Nichts in entsprechende Öffnungen stecken (Lüfter z.B.)

Passende Sicherung verwenden.

Setzen Sie nur die spezifikationsgemäßen Sicherungen ein.

Vermeiden Sie ungeschützte Verbindungen.

Berühren Sie keine unisolierten Verbindungen oder Baugruppen, während das Gerät in Betrieb ist.

Betreiben Sie das Gerät nicht im Fehlerfall.

Wenn Sie am Gerät einen Defekt vermuten, sorgen Sie dafür, bevor Sie das Gerät wieder betreiben, dass eine Untersuchung durch qualifiziertes Kundendienstpersonal durchgeführt wird. Jedwede Wartung, Einstellarbeiten oder Austausch von Teilen am Gerät, sowie am Zubehör dürfen nur von **RIGOL** autorisiertem Personal durchgeführt werden.

Belüftung sicherstellen.

Unzureichende Belüftung kann zu Temperaturanstiegen und somit zu thermischen Schäden am Gerät führen. Stellen Sie deswegen die Belüftung sicher und kontrollieren regelmäßig Lüfter und Belüftungsöffnungen.

Nicht in feuchter Umgebung betreiben.

Zur Vermeidung von Kurzschluß im Geräteinneren und Stromschlag betreiben Sie das Gerät bitte niemals in feuchter Umgebung.

Nicht in explosiver Atmosphäre betreiben.

Zur Vermeidung von Personen- und Sachschäden ist es unumgänglich, das Gerät ausschließlich fernab jedweder explosiven Atmosphäre zu betreiben.

Geräteoberflächen sauber und trocken halten.

Um den Einfluß von Staub und Feuchtigkeit aus der Luft auszuschließen, halten Sie bitte die Geräteoberflächen sauber und trocken.

Schutz gegen elektrostatische Entladung (ESD).

Sorgen Sie für eine elektrostatisch geschützte Umgebung, um somit Schäden und Funktionsstörungen durch ESD zu vermeiden. Erden Sie vor dem Anschluß immer Innen- und Außenleiter der Verbindungsleitung, um statische Aufladung zu entladen.

Die richtige Verwendung des Akkus.

Wenn eine Batterie verwendet wird, vermeiden Sie hohe Temperaturen bzw. Feuer ausgesetzt werden. Bewahren Sie es außerhalb der Reichweite von Kindern auf. Unsachgemäße Änderung der Batterie (Anmerkung: Lithium-Batterie) kann zu einer Explosion führen. Verwenden Sie nur von RIGOL angegebene Akkus.

Sicherer Transport.

Transportieren Sie das Gerät sorgfältig (Verpackung!), um Schäden an Bedienelementen, Anschlüssen und anderen Teilen zu vermeiden.

Sicherheits Begriffe und Symbole

Begriffe in diesem Guide. Diese Begriffe können in diesem Handbuch auftauchen:



WARNING

Die Kennzeichnung WARNING beschreibt Gefahrenquellen die leibliche Schäden oder den Tod von Personen zur Folge haben können.



CAUTION

Die Kennzeichnung Caution (Vorsicht) beschreibt Gefahrenquellen die Schäden am Gerät hervorrufen können.

Begriffe auf dem Produkt. Diese Bedingungen können auf dem Produkt erscheinen:

DANGER

weist auf eine Verletzung oder Gefährdung hin, die sofort geschehen kann.

WARNING

weist auf eine Verletzung oder Gefährdung hin, die möglicherweise nicht sofort geschehen.

CAUTION

bedeutet, dass eine mögliche Beschädigung des Instruments oder anderer Gegenstände auftreten kann.

Symbole auf dem Produkt. Diese Symbole können auf dem Produkt erscheinen:



Gefährliches
pannung



Sicherheits-
Hinweis



Schutz-erde



Gehäusemasse



Erde

Measurement Category

Measurement Category

DS1000Z series digital oscilloscopes can make measurements in Measurement Category I.



WARNING

This oscilloscope can only be used for measurements within its specified measurement categories.

Measurement Category Definitions

Measurement category I is for measurements performed on circuits not directly connected to MAINS. Examples are measurements on circuits not derived from MAINS, and specially protected (internal) MAINS derived circuits. In the latter case, transient stresses are variable; for that reason, the transient withstand capability of the equipment is made known to the user.

Measurement category II is for measurements performed on circuits directly connected to the low voltage installation. Examples are measurements on household appliances, portable tools and similar equipment.

Measurement category III is for measurements performed in the building installation. Examples are measurements on distribution boards, circuit-breakers, wiring, including cables, bus-bars, junction boxes, switches, socket-outlets in the fixed installation, and equipment for industrial use and some other equipment, for example. Stationary motors with permanent connection to the fixed installation.

Measurement category IV is for measurements performed at the source of the low-voltage installation. Examples are electricity meters and measurements on primary overcurrent protection devices and ripple control units.

Ventilation Requirement

This oscilloscope uses fan to force cooling. Please make sure that the air intake and exhaust areas are free from obstructions and have free air. When using the oscilloscope in a bench-top or rack setting, provide at least 10 cm clearance beside, above and behind the instrument for adequate ventilation.



WARNING

Inadequate ventilation may cause temperature increase which would damage the instrument. So please keep the instrument well ventilated during operation and inspect the intake and fan regularly.

Working Environment

Temperature

Operating: 0°C to +50°C

Non-operating: -40°C to +70°C

Humidity

0°C to +30°C: ≤95% relative humidity

+30°C to +40°C: ≤75% relative humidity

+40°C to +50°C: ≤45% relative humidity



WARNING

To avoid short circuit inside the instrument or electric shock, please do not operate in humid environment.

Altitude

Operating: less than 3 km

Non-operating: less than 15 km

Installation (overvoltage) Category

This product is powered by mains conforming to installation (overvoltage) category II.



WARNING

Make sure that no overvoltage (such as that caused by thunderbolt) can reach the product, or else the operator might expose to danger of electric shock.

Installation (overvoltage) Category Definitions

Installation (overvoltage) category I refers to signal level which is applicable to equipment measurement terminals connected to the source circuit. In these terminals, precautions are done to limit the transient voltage to the corresponding low level.

Installation (overvoltage) category II refers to the local power distribution level which is applicable to equipment connected to the AC line (AC power).

Pollution Degree

Degree 2

Pollution Degree Definitions

Pollution degree 1: No pollution or only dry, non-conductive pollution occurs. The pollution has no influence. For example: a clean room or air-conditioned office environment.

Pollution degree 2: Normally only dry, non-conductive pollution occurs. Occasionally a temporary conductivity caused by condensation may occur. For example: general indoor environment.

Pollution degree 3: Conductive pollution occurs, or dry, non-conductive pollution occurs which becomes conductive due to condensation which is expected. For example: sheltered outdoor environment.

Pollution degree 4: Pollution that generates persistent conductivity through conductive dust, rain, or snow. For example: outdoor locations.

Safety Class

Class 1 – Grounded Product

General Care and Cleaning

General Care:

Do not store or leave the instrument in where the instrument will be exposed to direct sunlight for long periods of time.

Cleaning:

Clean the instrument regularly according to its operating conditions. To clean the exterior surface, perform the following steps:

1. Disconnect the instrument from all power sources.
2. Clean the loose dust on the outside of the instrument with a lint- free cloth (with mild detergent or water). When cleaning the LCD, take care to avoid scarifying it.



CAUTION

To avoid damages to the instrument, do not expose them to liquids which have causticity.



WARNING

To avoid injury resulting from short circuit, make sure the instrument is completely dry before reconnecting it to a power source.

Environmental Considerations

The following symbol indicates that this product complies with the WEEE Directives 2002/96/EC.



Product End-of-Life Handling

The equipment may contain substances that could be harmful to the environment or human health. In order to avoid release of such substances into the environment and harm to human health, we encourage you to recycle this product in an appropriate system that will ensure that most of the materials are reused or recycled appropriately. Please contact your local authorities for disposal or recycling information.

DS1000Z Series Overview

DS1000Z is a high-performance digital oscilloscope developed on the basis of the UltraVision technique. DS1000Z, featuring rather deep memory depth, ultra-wide dynamic range, superb waveform capture rate and all-round trigger functions, is an invaluable debug instrument in various fields (such as communication, cosmonautics, national defense, embedded system, computer, research and education) and is the one with the most complete functions and most outstanding specification among the digital oscilloscopes with 100 MHz bandwidth.

Main features:

- 100 MHz and 70 MHz bandwidth.
- UltraVision technique.
- 1 GSa/s maximum real-time sample rate.
- 30,000 wfms/s (dots display) waveform capture rate.
- Real-time hardware waveform recording, waveform playback functions. Up to 60,000 frames of waveform can be recorded.
- 24 Mpts maximum memory depth (option) and 12 Mpts standard memory depth.
- Multi-degree gray scale display.
- Low noise, 1 mV/div to 10 V/div ultra-wide vertical dynamic range.
- 7.0 inches, WVGA (800*480) 160,000 color TFT LCD, vivid picture, low power consumption and long service life.
- Adjustable brightness of analog channel waveform.
- Auto setting of waveform display (**AUTO**).
- 15 kinds of trigger functions including multiple protocol triggers.
- Standard parallel decoding and multiple serial decoding options.
- Auto measurements of 32 waveform parameters and measurement functions with statistic.
- Precise delayed sweep function.
- Built-in FFT function.
- Pass/Fail test function.
- Multiple waveform math operation functions.
- Built-in dual-channel, 25 MHz signal source function (only available for DS1000Z-S).
- Standard configuration interfaces: USB Device, USB Host, LAN and GPIB (optional).
- Conform to LXI Core Device 2011 class instrument standards. Enable quick,

economic and efficient creation and reconfiguration of test system.

- Support remote command control.
- Embedded help enables easier information access.
- Support multiple languages and Chinese/English input.
- Novel and delicate industrial design and easier operation.

Document Overview

Subjects in this Manual:

Chapter 1 Quick Start

Provide information about preparations before using the instrument and a brief introduction of the instrument.

Chapter 2 To Set the Vertical System

Introduce the functions of the vertical system of the oscilloscope.

Chapter 3 To Set the Horizontal System

Introduce the functions of the horizontal system of the oscilloscope.

Chapter 4 To Set the Sample System

Introduce the functions of the sample system of the oscilloscope.

Chapter 5 To Trigger the Oscilloscope

Introduce the trigger mode, trigger coupling, trigger holdoff, external trigger and various trigger types of the oscilloscope.

Chapter 6 To Make Measurements

Introduce how to make math operation, cursor measurement and auto measurement.

Chapter 7 Protocol Decoding

Introduce how to decode the input signal using those common protocols.

Chapter 8 Reference Waveform

Introduce how to compare the input waveform with the reference waveform.

Chapter 9 Pass/Fail Test

Introduce how to monitor the input signal using the Pass/Fail test.

Chapter 10 Waveform Record

Introduce how to analyze the input signal using waveform record.

Chapter 11 Display Control

Introduce how to control the display of the oscilloscope.

Chapter 12 Signal Source

Introduce how to use the built-in signal source.

Chapter 13 Store and Recall

Introduce how to store and recall the measurement result and the setting of the oscilloscope.

Chapter 14 System Function Setting

Introduce how to set the remote interface and system-related functions.

Chapter 15 Remote Control

Introduce how to control the oscilloscope remotely.

Chapter 16 Troubleshooting

Introduce how to deal with common failures of the oscilloscope.

Chapter 17 Specifications





Provide the specifications and general specifications of the oscilloscope.

Chapter 18 Appendix

Provide common information such as options and accessories.

Format Conventions in this Manual:

1. Front panel key: denoted by the format of "Text Box + Button Name (Bold)", for example, **Storage**.
2. Menu softkey: denoted by the format of "Character Shading + Menu Word (Bold)", for example, **Storage**.
3. Operation steps: denoted by the arrow "→", for example, **Storage** → **Storage**.
4. Knob: the expression method of each knob is as shown in the "Logo" column in the table below.

Logo	Knob	Logo	Knob
VERTICAL  SCALE	Vertical Scale Knob	HORIZONTAL  SCALE	Horizontal Scale Knob
VERTICAL  POSITION	Vertical Position Knob	HORIZONTAL  POSITION	Horizontal Position Knob
TRIGGER  LEVEL	Trigger Level Knob		

Content Conventions in this Manual:

DS1000Z series includes the following models. This manual takes DS1104Z-S for example and the descriptions here have contained all the functions and performances of other models.

Model	Analog bandwidth	Channels	Channels for signal source
DS1104Z	100 MHz	4	--
DS1074Z	70 MHz	4	--
DS1104Z-S	100 MHz	4	2
DS1074Z-S	70 MHz	4	2

Contents

Guaranty and Declaration	I
Safety Requirement	II
General Safety Summary	II
Safety Terms and Symbols	IV
Allgemeine Sicherheits Informationen.....	V
Sicherheits Begriffe und Symbole	VII
Measurement Category	VIII
Ventilation Requirement	IX
Working Environment	X
General Care and Cleaning	XII
Environmental Considerations	XIII
DS1000Z Series Overview	XIV
Document Overview.....	XVI
Chapter 1 Quick Start	1-1
General Inspection	1-2
Appearance and Dimensions.....	1-3
To Prepare the Oscilloscope for Use.....	1-4
To Adjust the Supporting Legs.....	1-4
To Connect to Power Supply.....	1-5
Power-on Inspection	1-6
To Connect the Probe	1-7
Function Inspection.....	1-8
Probe Compensation	1-10
Front Panel Overview	1-11
Rear Panel Overview.....	1-12
Front Panel Function Overview.....	1-14
VERTICAL	1-14
Source	1-15
HORIZONTAL	1-15
TRIGGER	1-16
CLEAR	1-16
AUTO.....	1-16

RUN/STOP	1-17
SINGLE.....	1-17
Knob	1-17
Function Menu	1-18
Print.....	1-19
User Interface.....	1-20
Parameter Setting Methods	1-24
To Use the Security Lock.....	1-25
To Use the Built-in Help System.....	1-26
Chapter 2 To Set the Vertical System.....	2-1
To Enable the Channel.....	2-2
Channel Coupling	2-3
Bandwidth Limit.....	2-3
Probe Ratio	2-4
Waveform Invert.....	2-5
Vertical Scale.....	2-5
Vertical Expansion.....	2-6
Amplitude Unit.....	2-6
Channel Label.....	2-7
Delay Calibration.....	2-8
Chapter 3 To Set the Horizontal System	3-1
Delayed Sweep	3-2
Time Base Mode	3-4
YT Mode.....	3-4
XY Mode.....	3-5
Roll Mode	3-8
Chapter 4 To Set the Sample System	4-1
Acquisition Mode.....	4-2
Normal	4-2
Average.....	4-2
Peak Detect	4-3
High Resolution	4-3
Sin(x)/x.....	4-4
Sample Rate.....	4-4
Memory Depth.....	4-6
Antialiasing.....	4-7

Chapter 5 To Trigger the Oscilloscope	5-1
Trigger Source	5-2
Trigger Mode	5-3
Trigger Coupling.....	5-5
Trigger Holdoff.....	5-6
Noise Rejection	5-7
Trigger Type	5-8
Edge Trigger.....	5-9
Pulse Trigger	5-10
Slope Trigger	5-12
Video Trigger.....	5-16
Pattern Trigger	5-18
Duration Trigger	5-20
Setup/Hold Trigger (Option).....	5-22
TimeOut Trigger (Option)	5-24
Runt Trigger (Option)	5-26
Windows Trigger (Option).....	5-29
Delay Trigger (Option).....	5-31
Nth Edge Trigger (Option).....	5-33
RS232 Trigger (Option).....	5-35
I2C Trigger (Option).....	5-37
SPI Trigger (Option)	5-40
Trigger Output Connector.....	5-42
Chapter 6 To Make Measurements.....	6-43
Math Operation	6-44
Addition	6-44
Substraction	6-45
Multiplication.....	6-45
Division.....	6-46
FFT	6-47
"AND" Operation.....	6-50
"OR" Operation.....	6-52
"XOR" Operation	6-53
"NOT" Operation.....	6-54
Integrate	6-55
Differentiate	6-55
Square Root	6-56

Base 10 Logarithm.....	6-57
Natural Logarithm.....	6-57
Exponential.....	6-58
Absolute Value	6-59
Auto Measurement	6-60
Quick Measurement after AUTO	6-60
One-key Measurement of 32 Parameters.....	6-61
Frequency Counter Measurement.....	6-67
Measurement Setting	6-68
To Clear the Measurement.....	6-69
All Measurement.....	6-70
Statistic Function	6-71
Cursor Measurement	6-72
Manual Mode	6-73
Track Mode	6-76
Auto Mode	6-78
XY Cursor Measurement.....	6-79
Chapter 7 Protocol Decoding	7-1
Parallel Decoding	7-2
RS232 Decoding (Option)	7-7
I2C Decoding (Option).....	7-13
SPI Decoding (Option).....	7-17
Chapter 8 Reference Waveform	8-1
To Enable REF Function	8-2
To Select REF Source.....	8-2
To Adjust REF Waveform Display	8-2
To Save to Internal Memory	8-3
To Set the Color	8-3
To reset the REF waveform	8-3
To Export to Internal or External Memory	8-3
To Import from Internal or External Memory	8-4
Chapter 9 Pass/Fail Test	9-1
To Enable Pass/Fail Test.....	9-2
To Select Source	9-2
Mask Range.....	9-2
Test and Ouput	9-3

To Save the Test Mask	9-4
To Load the Test Mask	9-4
Chapter 10 Waveform Record	10-1
Playback Setting.....	10-2
Record Setting	10-3
Chapter 11 Display Control	11-1
To Select the Display Type.....	11-2
To Set the Persistence Time	11-3
To Set the Waveform Intensity.....	11-5
To Set the Screen Grid	11-5
To Set the Grid Brightness.....	11-5
Chapter 12 Signal Source	12-1
To Output Basic Waveform	12-2
To Output Sine Waveform	12-2
To Output Square Waveform	12-4
To Output Ramp Waveform.....	12-4
To Output Pulse Waveform.....	12-5
To Output DC Waveform.....	12-5
To Output Noise Waveform	12-6
To Output Built-In Waveform	12-7
To Output Arbitrary Waveform	12-12
To Select Waveform	12-14
To Create Waveform.....	12-14
To Edit Waveform	12-16
Modulation	12-18
AM	12-18
FM	12-20
Chapter 13 Store and Recall.....	13-1
Storage System.....	13-2
Storage Type	13-3
Internal Storage and Recall	13-5
External Storage and Recall.....	13-6
Disk Management.....	13-7
To Select File Type	13-8
To Create a New File or Folder	13-9

To Delete a File or Folder.....	13-12
To Rename a File or Folder	13-13
To Clear the Local Memory	13-13
Factory.....	13-14
Chapter 14 System Function Setting.....	14-1
Remote Interface Configuration.....	14-2
LAN Setting.....	14-2
To Select USB Device	14-6
To Set the GPIB Address	14-6
System-related	14-7
Sound	14-7
Language	14-7
System Information	14-8
Power-on Recall.....	14-8
Self-calibration	14-9
Option Management	14-10
Auto Options.....	14-11
Key Lock.....	14-12
Chapter 15 Remote Control	15-1
Remote Control via USB.....	15-2
Remote Control via LAN.....	15-6
Remote Control via GPIB.....	15-9
Chapter 16 Troubleshooting	16-1
Chapter 17 Specifications	17-1
Chapter 18 Appendix	18-1
Appendix A: Accessories and Options	18-1
Appendix B: Warranty.....	18-2
Index.....	1

Chapter 1 Quick Start

This chapter introduces the preparations when using the oscilloscope for the first time, the front panel, rear panel and user interface of the oscilloscope as well as the using method of the built-in help system.

The contents of this chapter:

- General Inspection
- Appearance and Dimensions
- To Prepare the Oscilloscope for Use
- Front Panel Overview
- Rear Panel Overview
- Front Panel Function Overview
- User Interface
- Parameter Setting Methods
- To Use the Security Lock
- To Use the Built-in Help System

General Inspection

1. **Inspect the shipping container for damage.**

Keep the damaged shipping container or cushioning material until the contents of the shipment have been checked for completeness and the instrument has passed both electrical and mechanical tests.

The consigner or carrier shall be liable for the damage to instrument resulting from shipment. **RIGOL** would not be responsible for free maintenance/rework or replacement of the unit.

2. **Inspect the instrument.**

In case of any damage, or defect, or failure, notify your **RIGOL** sales representative.

3. **Check the Accessories**

Please check the accessories according to the packing lists. If the accessories are incomplete or damaged, please contact your **RIGOL** sales representative.

Appearance and Dimensions

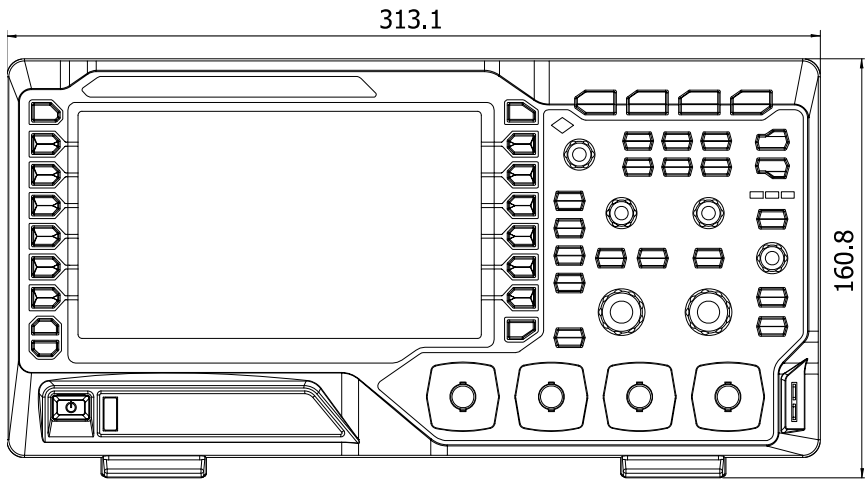

Figure 1-1 Front View

Unit: mm

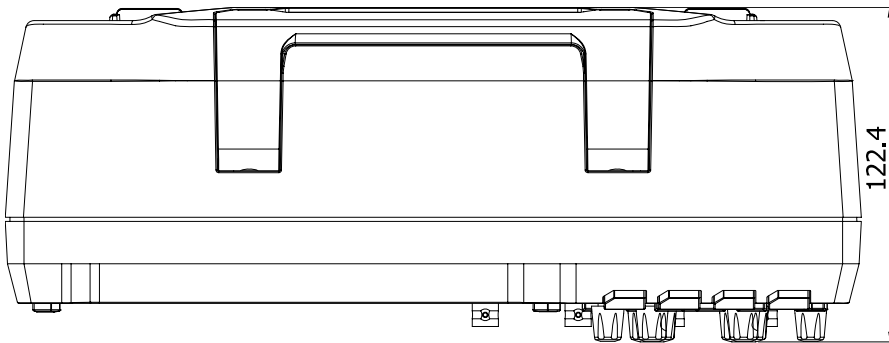

Figure 1-2 Top View

Unit: mm

To Prepare the Oscilloscope for Use

To Adjust the Supporting Legs

Adjust the supporting legs properly to use them as stands to tilt the oscilloscope upwards for stable placement of the oscilloscope as well as better operation and observation.

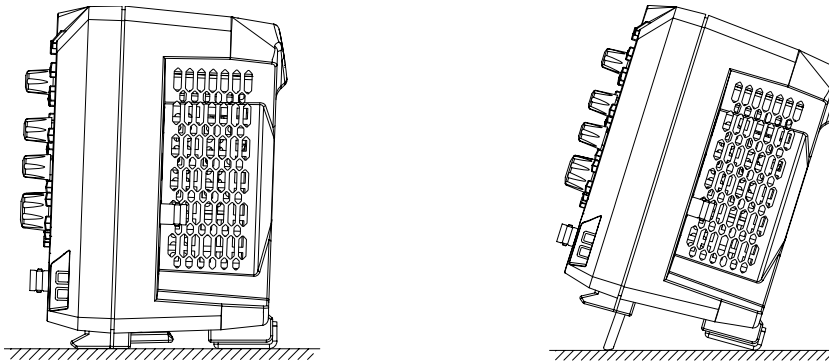

Figure 1-3 To Adjust the Supporting Legs

To Connect to Power Supply

The power requirements of DS1000Z are 100-240 V, 45-440 Hz. Please use the power cord supplied with the accessories to connect the oscilloscope to the AC power source.

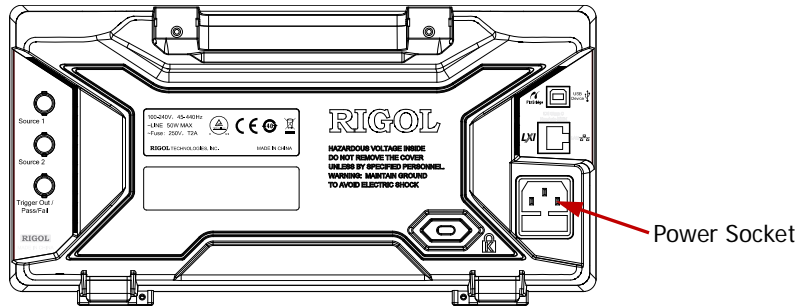



Figure 1-4 To Connect to Power Source

Power-on Inspection

When the oscilloscope is energized, press the power key  at the lower-left corner of the front panel to start the oscilloscope. During the start-up process, the oscilloscope performs a series of self-tests and after the self-test is finished, the welcome screen is displayed and you can view the Option name, Option Edition and Left time of the option currently installed in the "Installed Options" pop-up dialog box on the screen. When the instrument is shipped, a trial version of the option is provided and the left time is about 2000 minutes.

Installed Options			
Name	Detail	Version	Left-Time
TRIGGER	Timeout	Trial	35 hours 54 minutes
	Runt	Trial	35 hours 54 minutes
	Window	Trial	35 hours 54 minutes
	Delay	Trial	35 hours 54 minutes
	Setup	Trial	35 hours 54 minutes
	NthEdge	Trial	35 hours 54 minutes
	RS232	Trial	35 hours 54 minutes
	I2C	Trial	35 hours 54 minutes
DECODER	SPI	Trial	35 hours 54 minutes
	RS232	Trial	35 hours 54 minutes
	I2C	Trial	35 hours 54 minutes
RECORDER	SPI	Trial	35 hours 54 minutes
	Record/Re-Play	Trial	35 hours 54 minutes
MEM-DEPTH	24M/12M/6M	Trial	35 hours 54 minutes

Figure 1-5 Installed Options

To Connect the Probe

RIGOL provides passive probe for the DS1000Z series oscilloscopes, as shown in the table below. For detailed technical information of the probe, please refer to the corresponding Probe User's Guide.

Model	Description
RP2200	150 MHz, passive probe, standard

Connect the Probe:

1. Connect the BNC terminal of the probe to a channel BNC connector of the oscilloscope at the front panel.
2. First connect the ground alligator clip of the probe to the circuit ground terminal and then connect the probe tip to the circuit point to be tested.

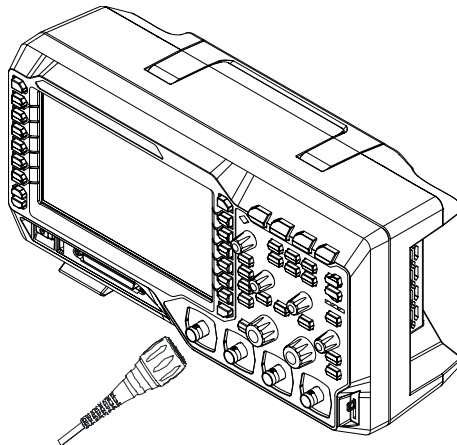

Figure 1-6 To Connect the Probe

Function Inspection

1. Press **Storage** → **Default** to restore the instrument to its default configuration.
2. Connect the ground alligator clip of the probe to the “Ground Terminal” under the probe compensation signal output terminal.
3. Use the probe to connect the input terminal of CH1 of the oscilloscope and the “Compensation Signal Output Terminal” of the probe.

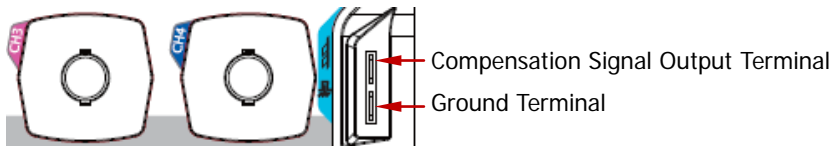

Figure 1-7 To Use the Compensation Signal

4. Press **AUTO**.
5. Observe the waveform on the display. In normal condition, the display should be a square waveform as shown in the figure below:

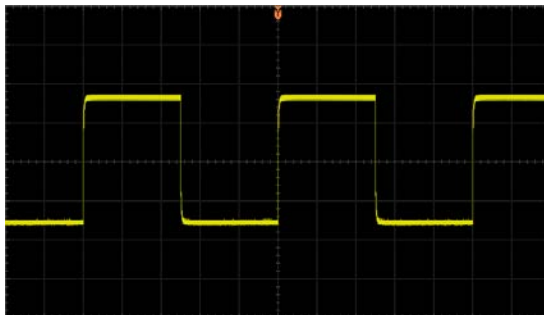

Figure 1-8 Square Waveform

6. Use the same method to test the other channels. If the square waveforms actually shown do not match that in the figure above, please perform “**Probe Compensation**” in the next section.



WARNING

To avoid electric shock during the use of probe, please make sure that the insulated wire of the probe is in good condition and do not touch the metallic part of the probe when the probe is connected to high voltage source.

Tip

The signal output from the probe compensation connector can only be used for probe compensation adjustment and can not be used for calibration.

Probe Compensation

When the probes are used for the first time, you should compensate the probes to match the input channels of the oscilloscope. Non-compensated or poorly compensated probes may cause measurement inaccuracy or error. The probe compensation procedures are as follows.

1. Perform steps 1, 2, 3 and 4 of **“Function Inspection”** in the previous section.
2. Check the waveforms displayed and compare them with the following.

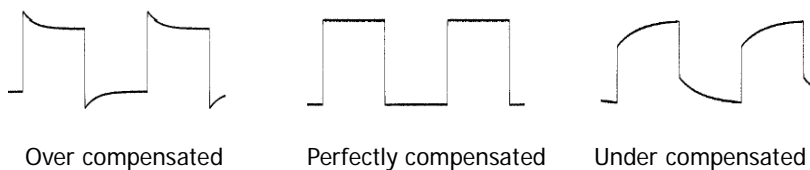

Figure 1-9 Probe Compensation

3. Use a nonmetallic driver to adjust the low-frequency compensation adjustment hole on the probe until the waveform displayed is as the “Perfectly compensated” in the figure above.

Front Panel Overview

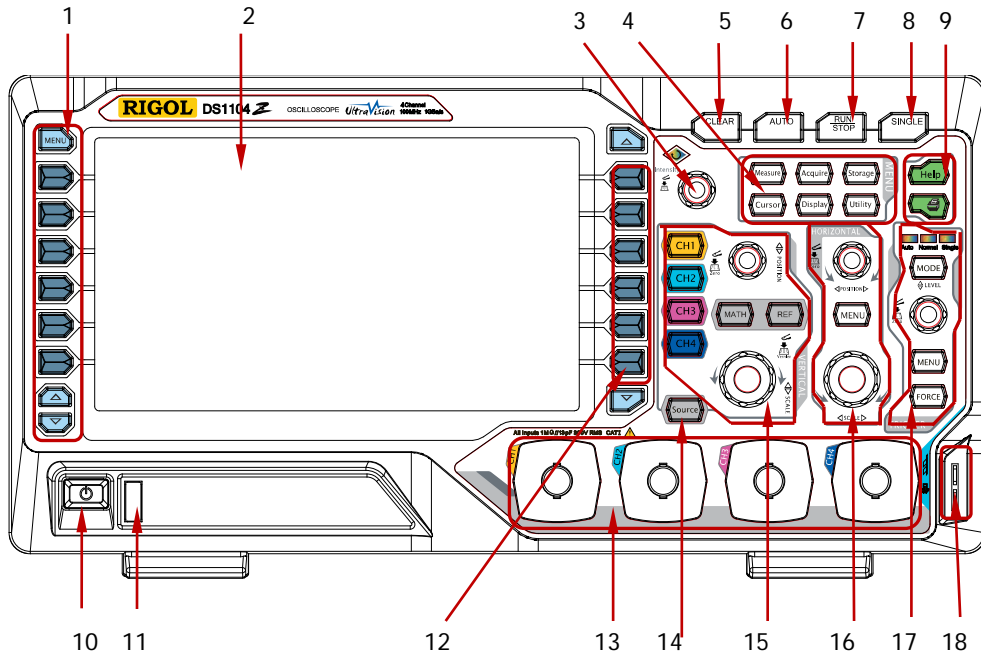

Figure 1-10 Front Panel Overview

Table 1-1 Front Panel Description

No.	Description	No.	Description
1	Measurement Menu Softkeys	10	Power Key
2	LCD	11	USB HOST
3	Multi-function Knob	12	Function Menu Softkeys
4	Function Menu Keys	13	Analog Channel Input Area
5	CLEAR	14	Source ^[1]
6	AUTO	15	VERTICAL
7	RUN/STOP	16	HORIZONTAL
8	SINGLE	17	TRIGGER
9	Help&Print	18	Probe Compensation Signal Output Terminal/Ground Terminal

Note^[1]: Only applicable to DS1104Z-S and DS1074Z-S.

Rear Panel Overview

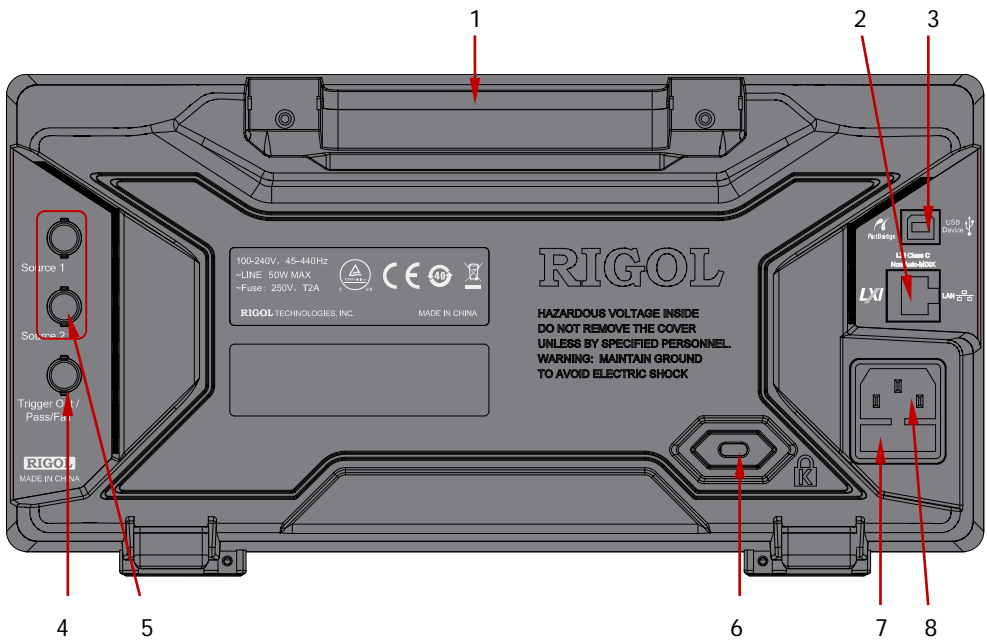

Figure 1-11 Rear Panel Overview

1. Handle

Pull up the handle vertically for easy carrying of the instrument. When you do not need the handle, press it down.

2. LAN

Connect the instrument to the network via this interface for remote control. This oscilloscope conforms to the LXI Core Device 2011 class instrument standards and can quickly build test system with other instruments.

3. USB DEVICE

PictBridge printer or PC can be connected via this interface to print waveform displayed on the screen or control the instrument using PC software by sending SCPI commands or user-defined programming.

4. Trigger Out/Pass/Fail

- **Trigger Out**

The oscilloscope outputs a signal that can reflect the current capture rate of the oscilloscope at each trigger via this connector. You can connect the signal to a waveform display instrument to measure the frequency of the signal. The measurement result is equal to the current capture rate.

- **Pass/Fail**

In the pass/fail test, this connector outputs a high level when failed waveforms are detected by the oscilloscope and outputs low level when passed waveforms are detected by the oscilloscope.

5. Source Output

The oscilloscope provides two built-in source channel output terminals. When the output of Source1 or Source2 is enabled, the **[Source1]** or **[Source2]** connectors at the rear panel outputs the current signal.

6. Lock Hole

You can lock the instrument to a fixed location using the security lock (please buy it yourself) via the lock hole.

7. Fuse

If a new fuse is required, please use the specified fuse (250V, T2A) and follow the steps below.

- a) Turn off the instrument and remove the power cord.
- b) Insert a straight screwdriver into the slot at the power socket and prize out the fuse seat gently.
- c) Take out the fuse and replace it with specified fuse, and then install the fuse seat to the original position.

8. AC Power Socket

AC power input terminal. The power requirements of this oscilloscope are 100-240 V, 45-440 Hz. Use the power cord provided with the accessories to connect the instrument to AC power. Then, you can press the power key at the front panel to start the instrument.

Front Panel Function Overview

VERTICAL

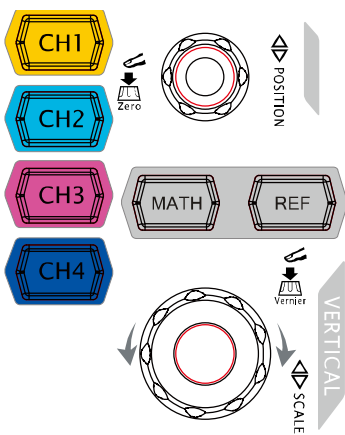

CH1, **CH2**, **CH3**, **CH4**: analog input channels. The 4 channels are marked by different colors which are also used to mark both the corresponding waveforms on the screen and the channel input connectors. Press any key to open the corresponding channel menu and press again to turn off the channel.

MATH: press this key to open the math operation menu under which add, subtract, multiply, divide, FFT, A&B, A||B, A^B, !A, Intg, Diff, Sqrt, Lg, Ln, Exp and Abs are provided.





REF: press this key to enable the reference waveform function to compare the waveform actually tested with the reference waveform.

Vertical **POSITION**: modify the vertical position of the current channel waveform. Turn clockwise to increase the position and turn counterclockwise to decrease. During the modification, the waveform would move up and down and the position message (e.g. **POS: 216.0mV**) at the lower-left corner of the screen would change accordingly. Press down this knob to quickly reset the vertical position to zero.

VERTICAL **SCALE**: modify the vertical scale of the current channel. Turn clockwise to decrease the scale and turn counterclockwise to increase. During the modification, the amplitude of the waveform would enlarge or reduce and the scale information (e.g. **1 = 200mV**) at the lower side of the screen would change accordingly. Press down this knob to quickly switch the vertical scale adjustment modes between “Coarse” and “Fine”.

Tip

How to set the vertical scale and vertical position of each channel?

The four channels of the DS1000Z series digital oscilloscope use the same set of **VERTICAL**  **POSITION** and **VERTICAL**  **SCALE** knobs. To set the vertical scale and vertical position of a channel, press **CH1**, **CH2**, **CH3** or **CH4** to select the desired channel and then rotate the **VERTICAL**  **POSITION** and **VERTICAL**  **SCALE** knobs.

Source

Press this key to enter the source setting interface. You can set the waveform of the output signal of the source and the waveform parameters, turn on or off the outputs of the **[Source1]** and **[Source2]** connectors at the rear panel, view the signal states (such as the frequency, amplitude, offset and phase).

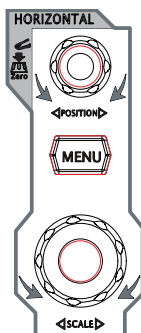
HORIZONTAL

HORIZONTAL  **POSITION**: modify the horizontal position.

The trigger point would move left or right relative to the center of the screen when you turn the knob. During the modification, waveforms of all the channels would move left or right and the horizontal position message (e.g. **D** -200.000000ns) at the upper-right corner of the screen would change accordingly. Press down this knob to quickly reset the horizontal position (or the delayed sweep position).

MENU: press this key to open the horizontal control menu under which to turn on or off the delayed sweep function, switch between different time base modes.

HORIZONTAL  **SCALE**: modify the horizontal time base. Turn clockwise to reduce the time base and turn counterclockwise to increase the time base. During the modification, waveforms of all the channels will be displayed in expanded or

compressed mode and the time base message (e.g. **H 500ns**) at the upper side of the screen would change accordingly. Press down this knob to quickly switch to delayed sweep state.

TRIGGER

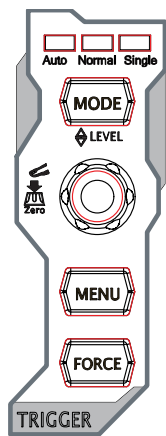

MODE: press this key to switch the trigger mode to **Auto**, **Normal** or **Single** and the corresponding state backlight of the current trigger mode would be illuminated.

TRIGGER LEVEL: modify the trigger level. Turn clockwise to increase the level and turn counterclockwise to reduce the level. During the modification, the trigger level line would move up and down and the value in the trigger level message box (e.g. **Trig Level : 428mV**) at the lower-left corner of the screen would change accordingly. Press down the knob to quickly reset the trigger level to zero point.

MENU: press this key to open the trigger operation menu. This oscilloscope provides various trigger types (for details, refer to the introductions in “**To Trigger the Oscilloscope**”).

FORCE: press this key to generate a trigger signal forcefully.

CLEAR

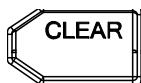

Press this key to clear all the waveforms on the screen. If the oscilloscope is in “RUN” state, new waveforms will still be displayed.

AUTO

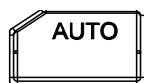

Press this key to enable the waveform auto setting function. The oscilloscope will automatically adjust the vertical scale, horizontal time base and trigger mode according to the input signal to realize

optimum waveform display. Note that auto setting requires that the frequency of the signal under test should be no lower than 41Hz, the duty cycle be greater than 1% and the amplitude be at least 20mVpp. Otherwise, "Auto detected none!" would be displayed after pressing this key and the quick parameter measurement menu might not be displayed.

RUN/STOP

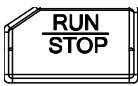

Press this key to set the state of the oscilloscope to "RUN" or "STOP". In "RUN" state, the key is illuminated in yellow. In "STOP" state, the key is illuminated in red.

SINGLE

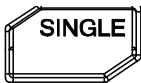

Press this key to set the trigger mode to "Single". In single trigger mode, press **FORCE** to generate a trigger signal immediately.

Knob



Adjust waveform brightness:

In non-menu-operation mode, turn this knob to adjust the brightness of waveform display. The adjustable range is from 0% to 100%. Turn clockwise to increase the brightness and counterclockwise to reduce. Press down this knob to reset the brightness to 50%.

You can also press **Display** → **Intensity** and use the knob to adjust the waveform brightness.

Multifunction Knob (the backlight goes on during operation):

In menu operation, press any menu softkey and turn the knob to switch the desired submenu under this menu and then press down the knob to select the current submenu. It can also be used to modify parameters and input filename. In addition,

for DS1000Z-S models oscilloscope, in the source interface, press the corresponding menu softkey and then press the knob; the numeric keyboard will pop-up on the screen and you can input the desired parameter value and unit directly using this knob.

Function Menu

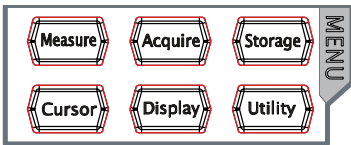

Measure: press this key to open the measurement setting menu. You can set the measurement source as well as turn on or off the frequency counter, all measure and statistic function etc. Press **MENU** at the left of the screen to switch the measurement menus of 32 waveform parameters. Then, press down the corresponding menu softkey to quickly realize one-key measurement and the measurement result will be displayed at the bottom of the screen.

Acquire: press this key to enter the sample setting menu to set the acquisition mode and memory depth of the oscilloscope.

Storage: press this key to enter file store and recall interface. The storable file types include picture, traces, waveforms, setups, CSV and parameter. Internal and external storage as well as disk management are also supported.

Cursor: press this key to enter cursor measurement menu. The oscilloscope provides manual, track, auto and XY cursor modes. Wherein, the XY mode is only valid when the time base mode is "XY".

Display: press this key to enter display setting menu to set the display type, persistence time, wave intensity, grid type and grid brightness of the waveform.

Utility: press this key to enter the system function setting menu to set the system-related functions or parameters, such as I/O setting, sound and language. Besides, some advanced functions (such as pass/fail test, waveform record) are also supported.

Print



pressing this key will save the screen to the USB storage device in “.png” format. If the current storage type is picture, the screen will be saved in the USB storage device in picture format (BMP8, BMP24, PNG and TIFF).

User Interface

DS1000Z provides 7.0 inches, WVGA (800*480) 160,000 color TFT LCD.

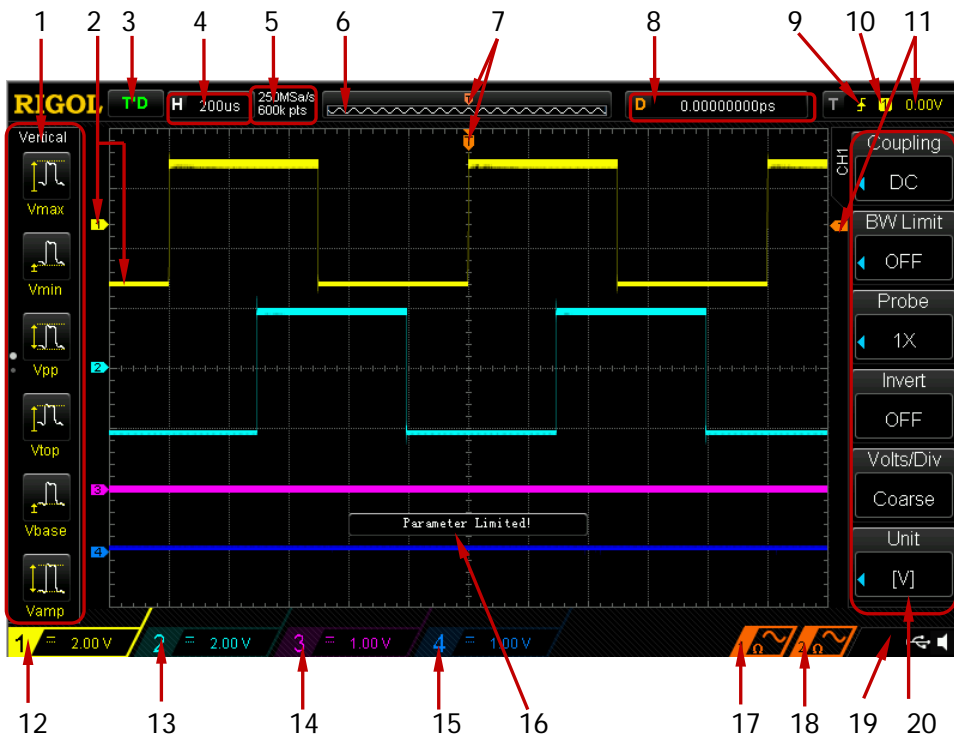

Figure 1-12 User Interface

1. Auto Measurement Items

Provide 16 horizontal (HORIZONTAL) and 16 vertical (VERTICAL) measurement parameters. Press the softkey at the left of the screen to activate the corresponding measurement item. Press **MENU** continuously to switch between the horizontal and vertical parameters.

2. Channel Label/Waveform

Different channels are marked by different colors and the color of the waveform complies with the color of the channel.

3. Status

Available states include RUN, STOP, T'D (triggered), WAIT and AUTO.

4. Horizontal Time Base

- Represent the time per grid on the horizontal axis on the screen.

- Use **HORIZONTAL**  **SCALE** to modify this parameter. The range available is from 5 ns to 50 s.

5. Sample Rate/Memory Depth

- Display the current sample rate and memory depth of the oscilloscope.
- Use **HORIZONTAL**  **SCALE** to modify this parameter.

6. Waveform Memory

Provide the schematic diagram of the memory position of the waveform currently on the screen.

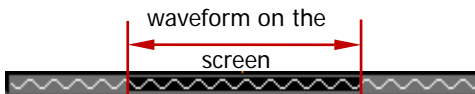

7. Trigger Position

Display the trigger position of the waveform in the waveform memory and on the screen.

8. Horizontal Position

Use **HORIZONTAL**  **POSITION** to modify this parameter. Press down the knob to automatically set the parameter to zero.

9. Trigger Type

Display the currently selected trigger type and trigger condition setting.

Different labels are displayed when different trigger types are selected.



For example:  represents triggering on the rising edge in "Edge" trigger.



10. Trigger Source

Display the trigger source currently selected (CH1-CH4 or AC Line). Different labels are displayed when different trigger sources are selected and the color of the trigger parameter area will change accordingly.



For example:  denotes that CH1 is selected as the trigger source.

11. Trigger Level



-  at the right of the screen is the trigger level label and the trigger level value is displayed at the upper-right corner of the screen.
- When using **TRIGGER**  **LEVEL** to modify the trigger level, the trigger level value will change with the up and down of .

Note: In slope trigger, runt trigger and windows trigger, there are two trigger level labels ( and .



12. CH1 Vertical Scale

- Display the voltage value per grid of CH1 waveform vertically.
- Press **CH1** to select CH1 and use **VERTICAL**  **SCALE** to modify this parameter.
- The following labels will be displayed according to the current channel setting: channel coupling (e.g. ) and bandwidth limit (e.g. .



13. CH2 Vertical Scale

- Display the voltage value per grid of CH2 waveform vertically.
- Press **CH2** to select CH2 and use **VERTICAL**  **SCALE** to modify this parameter.
- The following labels will be displayed according to the current channel setting: channel coupling (e.g. ) and bandwidth limit (e.g. )

14. CH3 Vertical Scale

- Display the voltage value per grid of CH3 waveform vertically.
- Press **CH3** to select CH3 and use **VERTICAL**  **SCALE** to modify this parameter.
- The following labels will be displayed according to the current channel setting: channel coupling (e.g. ) and bandwidth limit (e.g. )



15. CH4 Vertical Scale

- Display the voltage value per grid of CH4 waveform vertically.
- Press **CH4** to select CH4 and use **VERTICAL**  **SCALE** to modify this parameter.
- The following labels will be displayed according to the current channel setting: channel coupling (e.g. ) and bandwidth limit (e.g. )



16. Message Box

Display prompt messages.

17. Source1 Waveform



- Display the type of waveform currently set for Source1.
- When the modulation of Source1 is enabled,  will be displayed at the bottom of the Source1 waveform.
- When the impedance of Source1 is set to 50 Ω,  will be displayed at the bottom of the Source1 waveform.
- Only available to DS1104Z-S and DS1074Z-S.

18. Source2 Waveform

- Display the type of waveform currently set for Source1.
- When the modulation of Source2 is enabled,  will be displayed at the bottom of the Source2 waveform.
- When the impedance of Source2 is set to 50 Ω,  will be displayed at the bottom of the Source2 waveform.
- Only available to DS1104Z-S and DS1074Z-S.

19. Notification Area















Display system time, sound icon and USB disk icon.

- Sound Icon: when sound is enabled,  will be displayed. Press **Utility** → **Sound** to enable or disable the sound.
- USB Disk Icon: when a USB disk is detected,  will be displayed.

20. Operation MENU

Press any softkey to activate the corresponding menu.

The following symbols might be displayed in the menu:

-  Denote that the multifunction knob  at the front panel can be used to select parameter items. The backlight of the multifunction knob  turns on when parameter selection is valid.
-  Denote that you can use the multifunction knob  to adjust the parameter and then press down the multifunction knob  to select the parameter. In this state, the backlight of the multifunction knob  is constant on.
-  Denote that press  to input desired parameter values directly using the pop-up numeric keyboard. The backlight of  turns on when parameter input is valid.
-  Denote that the current menu has several options.
-  Denote that the current menu has a lower level menu.
-  Press this key to return to the previous menu.
-  The number of the dots denotes that the number of the pages the current menu has.

Parameter Setting Methods

DS1000Z supports the following two parameter setting methods.

Method 1:

For parameters displayed with  in the menu, rotate the multifunction knob directly to set the desired value.

Method 2:



For parameters displayed with  in the menu, press the multifunction knob  and the numeric keyboard as shown in the figure below is displayed. Rotate the knob to select the desired number and press the knob to input the number. After inputting all the numbers, rotate the knob to select the desired unit and press the knob to finish the parameter setting.



Figure 1-13 Numeric Keyboard

Note: When using the numeric keyboard to input a parameter value, the length of the value cannot exceed 10 digits. Otherwise, "DEL" will be selected automatically and the input value will be deleted when you press knob again.

To Use the Security Lock

If needed, you can use the security lock (please buy it yourself) to lock the oscilloscope to a fixed location. The method is as follows, align the lock with the lock hole and plug it into the lock hole vertically, turn the key clockwise to lock the oscilloscope and then pull the key out.

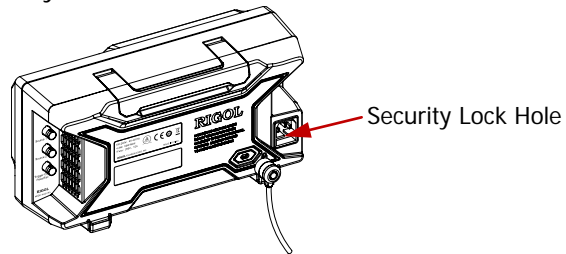

Figure 1-14 To Use the Security Lock

Note: Please do not insert other articles into the security lock hole to avoid damaging the instrument.

To Use the Built-in Help System

The help system of this oscilloscope provides instructions for all the function keys (including menu keys) at the front panel. Press **Help** to open the help interface and press again to close the interface. The help interface mainly consists of two parts. The left is "Help Options" and you can use "Button" or "Index" mode to select. The right is "Help Display Area".

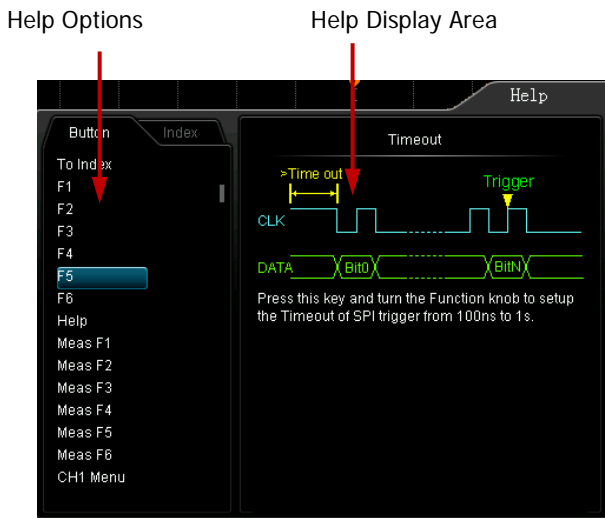







Figure 1-15 Help Information

Button:

Default mode. In this mode, you can press the button (except the power key , the various kinds of knobs  and the menu page up/down key  at the right of the screen) at the front panel directly to get the corresponding help information in the "Help Display Area". Use  to select "To Index" and then press the knob to switch to **Index** mode.

Index:

In this mode, use  to select the item that needs to get help (for example, "Measure"). Press the knob to get the corresponding help information in the "Help Display Area". Use  to select "To Button" and then press the knob to switch to **Button** mode.

Chapter 2 To Set the Vertical System

The contents of this chapter:

- To Enable the Channel
- Channel Coupling
- Bandwidth Limit
- Probe Ratio
- Waveform Invert
- Vertical Scale
- Vertical Expansion
- Amplitude Unit
- Channel Label
- Delay Calibration

To Enable the Channel

DS1000Z provides 4 analog input channels (CH1-CH4) and each channel can be controlled independently. As the vertical system setting methods of the 4 channels are completely the same, this chapter takes CH1 as an example to introduce the setting method of the vertical system.

Connect a signal to the channel connector of CH1 and then press **CH1** in the vertical control area (VERTICAL) at the front panel to enable CH1. At this point, the channel setting menu is displayed at the right side of the screen and the channel label at the bottom of the screen (as shown in the figure below) is highlighted. The information displayed in the channel label is related to the current channel setting.



After the channel is turned on, modify the parameters such as the vertical scale, the horizontal time base, the trigger mode and the trigger level according to the input signal to make the waveform displayed easy to observe and measure.

Channel Coupling

Set the coupling mode to filter out the undesired signals. For example, the signal under test is a square waveform with DC offset.

- When the coupling mode is “DC”: the DC and AC components of the signal under test can both pass the channel.
- When the coupling mode is “AC”: the DC components of the signal under test are blocked. The waveform displayed always takes the zero voltage as the center.
- When the coupling mode is “GND”: the DC and AC components of the signal under test are both blocked.

Press **CH1** → **Coupling** and use  to select the desired coupling mode (the default is DC). The current coupling mode is displayed in the channel label at the bottom of the screen. You can also press **Coupling** continuously to switch the coupling mode.



DC



AC

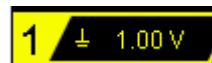

GND

Bandwidth Limit

DS1000Z supports the bandwidth limit function. The bandwidth limit can reduce the noise in the waveform displayed. For example, the signal under test is a pulse with high frequency oscillation.

- When bandwidth limit is disabled, the high frequency components of the signal under test can pass the channel.
- Enable bandwidth limit and limit the bandwidth to 20 MHz, the high frequency components that exceed 20 MHz are attenuated.

Press **CH1** → **BW Limit** and use  to enable or disable bandwidth limit (the default is OFF). When bandwidth limit (20 MHz) is enabled, the character “**B**” will be displayed in the channel label at the bottom of the screen. You can also press **BW**

Limit continuously to switch between on and off of the bandwidth limit.



Note: Although the bandwidth limit can reduce the noise, it will also attenuate or eliminate the high-frequency components of the signal.

Probe Ratio

DS1000Z allows users to set the probe attenuation ratio manually. The probe ratio values available are as shown in the table below.

Table 2-1 Probe Ratio

Menu	Attenuation coefficient (signal under test: waveform displayed)
0.01X	1:100
0.02X	1:50
0.05X	1:20
0.1X	1:10
0.2X	1:5
0.5X	1:2
1X	1:1
2X	2:1
5X	5:1
10X	10:1
20X	20:1
50X	50:1
100X	100:1
200X	200:1
500X	500:1
1000X	1000:1

Waveform Invert

When waveform invert is enabled, the waveform display rotates 180 degree relative to the ground potential. When waveform invert is disabled, the waveform display is normal. Press **CH1** → **Invert** to enable or disable waveform invert.

Vertical Scale

The vertical scale refers to the voltage value per grid in the vertical direction on the screen and is usually expressed in V/div. Adjusting the vertical scale will change the size of the waveform displayed. The vertical scale can be adjusted in “Coarse” or “Fine” mode.

Press **CH1** → **Volts/Div** to select the desired mode. Rotate **VERTICAL**  **SCALE** to adjust the vertical scale (clockwise to reduce the scale and counterclockwise to increase).

The scale information (as shown in the figure below) in the channel label at the bottom of the screen will change accordingly during the adjustment. The adjustable range of the vertical scale is related to the probe ratio currently set. By default, the probe ratio is 10X and the adjustable range of the vertical scale is from 10 mV/div to 100 V/div.



- Coarse adjustment (take counterclockwise as an example): set the vertical scale in 1-2-5 step namely 1 mV/div, 2 mV/div, 5 mV/div, 10 mV/div...10 V/div.
- Fine adjustment: further adjust the vertical scale within a relatively smaller range to improve vertical resolution. If the amplitude of the input waveform is a little bit greater than the full scale under the current scale and the amplitude would be a little bit lower if the next scale is used, fine adjustment can be used to improve the amplitude of waveform display to view signal details.

Note: You can also press **VERTICAL**  **SCALE** to quickly switch between “Coarse” and “Fine” adjustments.

Vertical Expansion

When using **VERTICAL**  **SCALE** to change the vertical scale of the analog channel, you can choose to expand or compress the signal vertically around the center of the screen or the ground point of the signal.

Press **Utility** → **System** → **VerticalExp** to select “Center” or “Ground” and the default is “Ground”.

- Center: when the vertical scale is modified, the waveform will expand or compress around the center of the screen.
- Ground: when the vertical scale is modified, the waveform ground level will remain at the same point on the screen and the waveform will expand or compress around this point.

Amplitude Unit

Select the amplitude display unit for the current channel. The available units are W, A, V and U. When the unit is changed, the unit displayed in the channel label will change accordingly.

Press **CH1** → **Unit** to select the desired unit and the default is V.

Channel Label

To identify different analog channels, you can set another label for each channel (such as **CH1**). Press **CH1** → **Label** to enter the label setting menu, you can use the built-in label or input the label manually and the length of the label inputted manually cannot exceed 4 characters. **Note:** Only English lowercase input method can be used for this operation.

Press **Display** to turn on or off the display of channel label and the default is CH1.

Press **Label Edit** to enable the label editing interface as shown in the figure below.

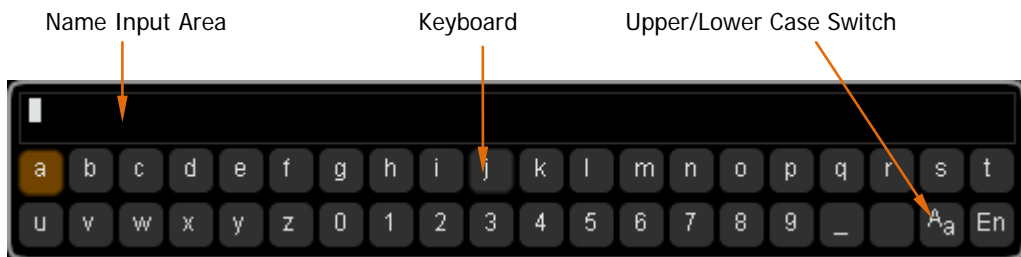







Figure 2-1 Label Editing Interface

For example, set the label to "**Chn1**".

Press **Keyboard** to select the "Keyboard" area. Select "Aa" using  and press down  to switch it to "aA". Select "C" using  and press down  to input the character. Use the same method to input "hn1".

To modify or delete the input character, press **Name** to select the "Name Input Area" and use  to select the character to be modified or deleted. Enter the desired character or press **Delete** to delete the character selected.

After finishing the input, press **OK** to finish the modification. If **Display** is set to "ON", the label **Chn1** will be displayed at the left of the CH1 waveform.

Delay Calibration

When using an oscilloscope for actual measurement, the transmission delay of the probe cable may bring greater error (zero offset). DS1000Z allows users to set a delay time to calibrate the zero offset of the corresponding channel. Zero offset is defined as the offset of the crossing point of the waveform and trigger level line relative to the trigger position, as shown in the figure below.

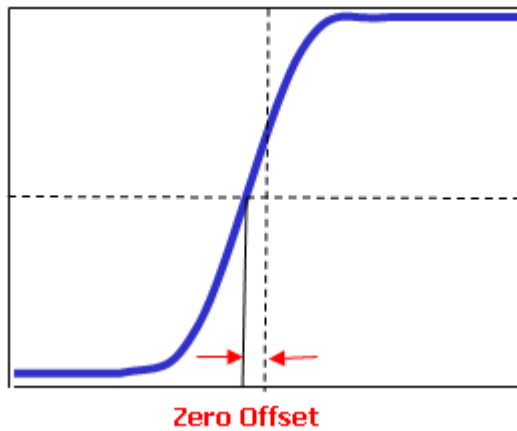



Figure 2-2 Zero Offset

Press **CH1** → **Delay-Cal** and use  to set the desired delay time. The range available is from -100 ns to 100 ns.

Note: This parameter is related to the instrument model and the horizontal time base currently set. The greater the horizontal time base is, the greater the setting step will be. Take DS1104Z as an example and the steps under different horizontal time bases are as shown in the table below.

Table 2-2 Relation between the delay calibration step and horizontal time base (DS1104Z)

Horizontal Base	Time	Delay Calibration Time Step
5ns		100ps
10ns		200ps
20ns		400ps

50ns	1ns
100ns	2ns
200ns	4ns
500ns	10ns
1 μ s and grater	20ns

Chapter 3 To Set the Horizontal System

The contents of this chapter:

- Delayed Sweep
- Time Base Mode

Delayed Sweep

Delayed sweep can be used to enlarge a length of waveform horizontally to view the waveform details.

Press **MENU** in the horizontal control area (HORIZONTAL) at the front panel and press **Delayed** to enable or disable delayed sweep.

Note: To enable delayed sweep, the current time base mode must be "YT".

In delayed sweep mode, the screen is divided into two display areas as shown in the figure below.

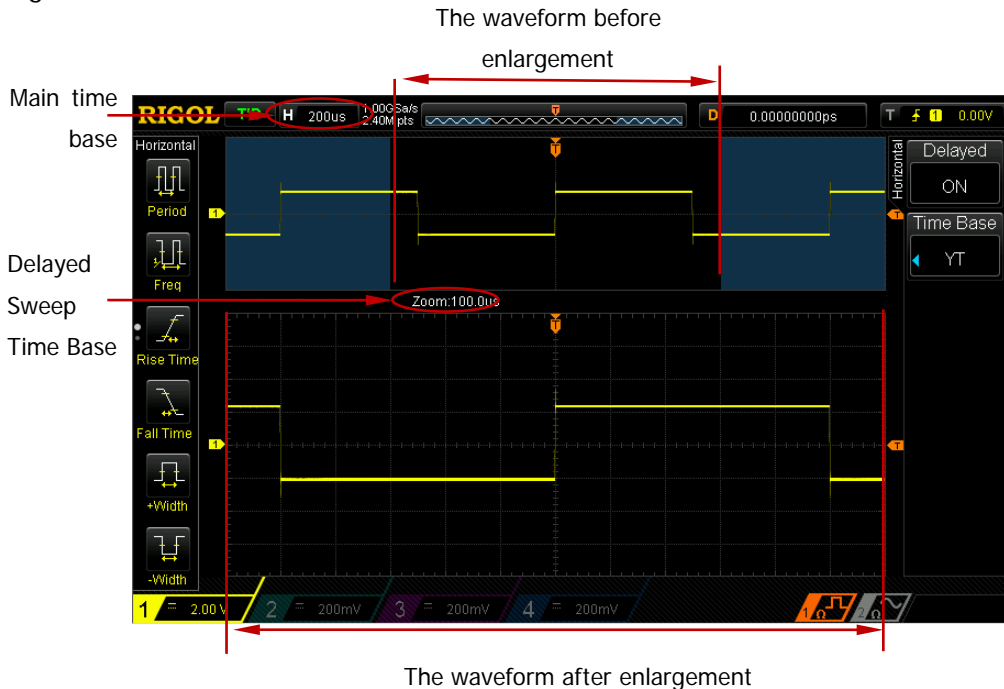

The waveform before enlargement:

The waveform in the area that has not been covered by the subtransparent blue in the upper part of the screen is the waveform before enlargement. You can turn **HORIZONTAL** **POSITION** to move the area left and right or turn **HORIZONTAL** **SCALE** to enlarge or reduce this area.

The waveform after enlargement:

The waveform in the lower part of the screen is the horizontally expanded waveform. **Note:** Compared to the main time base, the delayed time base has increased the waveform resolution (as shown in the figure above). The delayed time base should be less than or equal to the main time base.

Tip

You can also press down **HORIZONTAL** **SCALE** (delayed sweep shortcut key) to directly switch to delayed sweep mode.

Time Base Mode

Press **MENU** in the horizontal control area (HORIZONTAL) at the front panel and then press **Time Base** to select the time base mode of the oscilloscope and the default is YT.

YT Mode

This mode is the main time base mode and is applicable to four input channels. In this mode, the Y axis represents voltage and the X axis represents time.

Note: Only when this mode is enabled can “**Delayed Sweep**” be turned on.

XY Mode

In this mode, the oscilloscope changes the two channels from voltage-time display mode to voltage-voltage display mode. The phase deviation between two signals with the same frequency can be easily measured via Lissajous method. The figure below shows the measurement schematic diagram of the phase deviation.

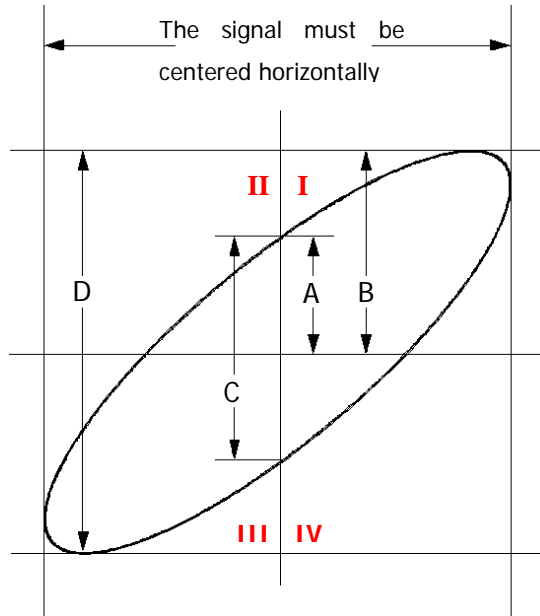

According to $\sin\theta = A/B$ or C/D (wherein, θ is the phase deviation angle between the two channels and the definitions of A, B, C and D are as shown in the figure above), the phase deviation angle is obtained, that is:



$$\theta = \pm \arcsin(A/B) \text{ or } \pm \arcsin(C/D)$$

If the principal axis of the ellipse is within quadrant I and III, the phase deviation angle obtained should be within quadrant I and IV, namely within $(0 \text{ to } \pi/2)$ or $(3\pi/2 \text{ to } 2\pi)$. If the principal axis of the ellipse is within quadrant II and IV, the phase deviation angle obtained should be within quadrant II and III, namely within $(\pi/2 \text{ to } \pi)$ or $(\pi \text{ to } 3\pi/2)$.

XY function can be used to measure the phase deviation occurred when the signal under test passes through a circuit network. Connect the oscilloscope to the circuit to monitor the input and output signals of the circuit.

Application example: measure the phase deviation of the input signals of two channels.

Method 1: Use Lissajous method

1. Connect a sine signal to CH1 and then connect a sine signal with the same frequency and amplitude but a 90° phase deviation to CH2.
2. Press **AUTO** and adjust the vertical position of CH1 and CH2 to 0.
3. Press **X-Y** to select "CH1-CH2", rotate **Horizontal**  **SCALE** to adjust the sample rate properly to get better Lissajous figure for better observation and measurement.
4. Rotate **VERTICAL**  **POSITION** to adjust CH1 and CH2 to get better observation of signals. At this point, the circle as shown in the figure below should be displayed.

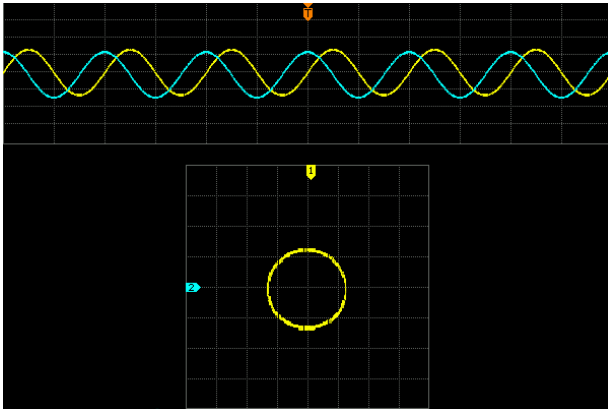

5. As shown in the figure above, the distances from the crossing points of axis and the circle to the origin of the coordinates are approximately equal. Thus, the phase deviation angle $\theta = \pm \arcsin 1 = 90^\circ$.

Note:

- In YT mode, the oscilloscope could use any sample rate (within the guaranteed range) to capture waveform. The maximum sample rate of XY mode is 500 MSa/s. Generally, reducing the sample rate properly could improve the display effect of Lissajous figure.
- When XY mode is enabled, "**Delayed Sweep**" will be disabled automatically.
- Press X-Y to select "CH1-CH2, CH1-CH3, CH1-CH4, CH2-CH3, CH2-CH4,

CH3-CH4" and the two channels corresponding will be enabled automatically and disabled the other two channels at the same time. X axis traces the voltage of the later channel of each option and Y axis traces the voltage of the former channel of each option.

- The following functions are not available in XY mode:
Auto measure, cursor measure, math operation, reference waveform, delayed sweep, vector display, **HORIZONTAL**  **POSITION**, trigger control, memory depth, acquisition mode, Pass/Fail test and waveform record.

Method 2: Use the shortcut measurement function

Please refer to "Phase A→B \overline{f} " and "Phase A→B \overline{t} " measurement functions of "Delay and Phase" on page **6-63**.

Roll Mode

In this mode, the waveform scrolls from the right to the left to update the display and the waveform horizontal position and trigger control are not available. The range of horizontal scale adjustment is from 200.0 ms to 50 s.

Note: When Roll mode is enabled, the "horizontal position", "**Delayed Sweep**", "Protocol Decoding", "Pass/Fail Test", "Waveform Record", "To Set the Persistence Time" and "**To Trigger the Oscilloscope**" are not available.

Slow Sweep

Another mode similar to Roll mode. When the horizontal time base is set to 200 ms/div or slower, the instrument enters "slow sweep" mode in which the instrument first acquires the data at the left of the trigger point and then waits for trigger event. After the trigger occurs, the instrument continues to finish the waveform at the right of the trigger point. When slow sweep mode is used to observe low frequency signal, it is recommended that the "**Channel Coupling**" is set to "DC".

Chapter 4 To Set the Sample System

The contents of this chapter:

- Acquisition Mode
- $\text{Sin}(x)/x$
- Sample Rate
- Memory Depth
- Antialiasing

Acquisition Mode

The acquisition mode is used to control how to generate waveform points from sample points.

Press **Acquire** → **Mode** in the function menu at the front panel and use  to select the desired acquisition mode (the default is normal), then press down the knob to select this mode. You can also press **Mode** continuously to switch the acquisition mode.

Normal

In this mode, the oscilloscope samples the signal at equal time interval to rebuild the waveform. For most of the waveforms, the best display effect can be obtained using this mode.

Average

In this mode, the oscilloscope averages the waveforms from multiple samples to reduce the random noise of the input signal and improve the vertical resolution. The greater the number of averages is, the lower the noise will be and the higher the vertical resolution will be but the slower the response of the displayed waveform to the waveform changes will be.

The available range of the number of averages is from 2 to 1024 and the default is 2. When "Average" mode is selected, press **Averages** and use  to set the desired number of averages as the power function of 2.

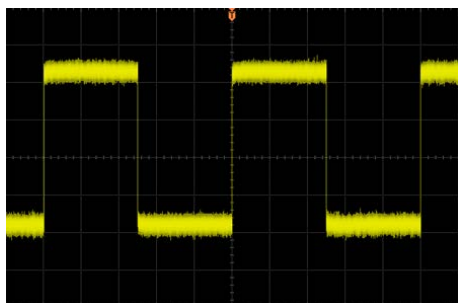

(a) The Waveform before Average

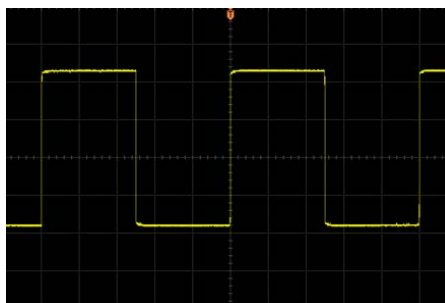

(b) The Waveform after 256 Averages

Figure 4-1 Average Acquisition Mode Example

Peak Detect

In this mode, the oscilloscope acquires the maximum and minimum values of the signal within the sample interval to get the envelope of the signal or the narrow pulse of the signal that might be lost. In this mode, signal confusion can be prevented but the noise displayed would be larger.

In this mode, the oscilloscope can display all the pulses with pulse widths at least as wide as the sample period.

High Resolution

This mode uses a kind of ultra-sample technique to average the neighboring points of the sample waveform to reduce the random noise on the input signal and generate much smoother waveforms on the screen. This is generally used when the sample rate of the digital converter is higher than the storage rate of the acquisition memory.

Note: “Average” and “High Res” modes use different averaging methods. The former uses “multiple sample average” and the latter uses “single sample average”.

Sin(x)/x

Press **Sin(x)/x** to enable or disable the dynamic sine interpolation function. Enable the dynamic sine interpolation can restore the original waveform more real.

Sample Rate

The sample rate of this oscilloscope is up to 1 GSa/s. **Note:** the sample rate is displayed in the status bar at the upper side of the screen and in the **Sa Rate** menu and can be changed by adjusting the horizontal time base (s/div) through **HORIZONTAL**  **SCALE** or modifying the memory depth.

The influence on the waveform when the sample rate is too low:

1. **Waveform Distortion:** when the sample rate is too low, some waveform details are lost and the waveform displayed is rather different from the actual signal.

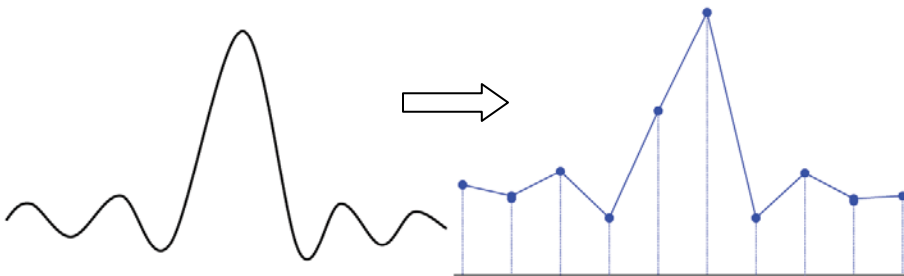

2. **Waveform Confusion:** when the sample rate is lower than twice the actual signal frequency (Nyquist Frequency), the frequency of the waveform rebuilt from the sample data is lower than the actual signal frequency. The most common aliasing is the jitter on fast edge.

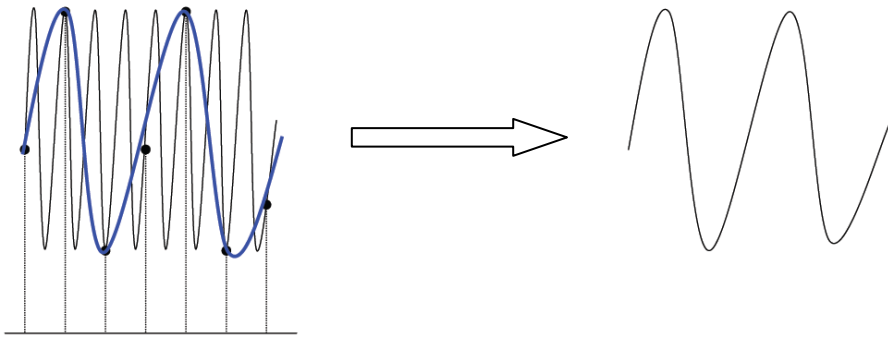

- 3. **Waveform Leakage:** when the sample rate is too low, the waveform rebuilt from the sample data does not reflect all the actual signal information.

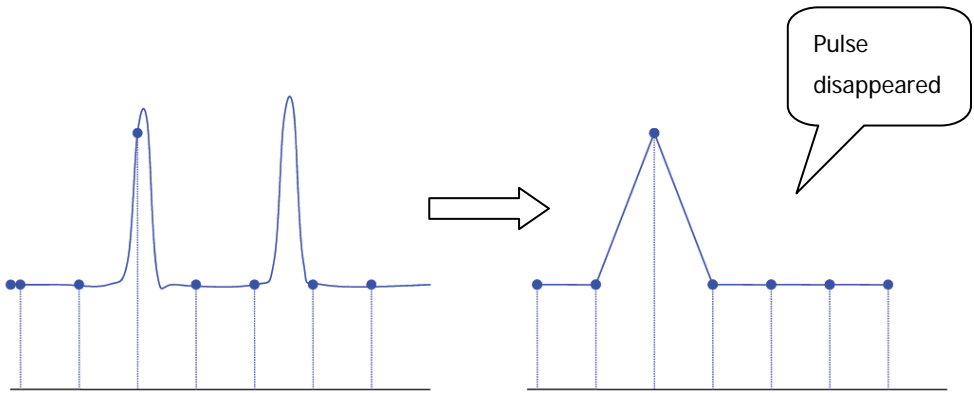

Memory Depth

Memory depth refers to the number of waveform points that the oscilloscope can store in a single trigger sample and it reflects the storage ability of the sample memory. DS1000Z provides up to 24 Mpts memory depth (option) and 12 Mpts standard memory depth.

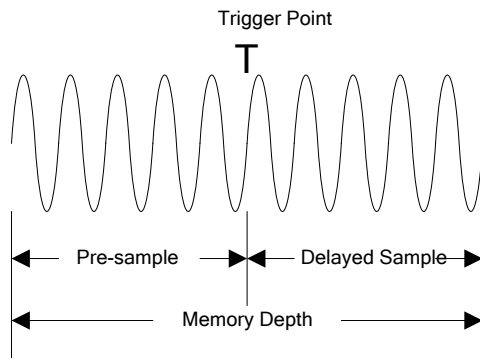

Figure 4-2 Memory Depth Schematic Diagram

The relation of the memory depth, sample rate and horizontal time base scale fulfills the equation below. Therefore, under the same horizontal time base scale, higher memory depth can ensure higher sample rate.

$$MDepth = SRate \times TScale \times HDivs$$

Wherein,

MDepth—memory depth, the unit is pts

SRate—sample rate, the unit is Sa/s

TScale—horizontal time base scale, the unit is s/div

HDivs—the number of grids in the horizontal direction of the screen, the unit is div. For DS1000Z, this value is 12.

Press **Acquire** → **Mem Depth**, use  to switch to the desired memory depth (the default is auto) and then press down the knob to select the option. You can also press **Mem Depth** continuously to switch the memory depth.

When a single channel is enabled, the memory depths available include Auto, 12kPoints, 120kPoints, 1200kPoints, 12MPoints and 24MPoints (optional). In “Auto” mode, the oscilloscope selects the memory depth automatically according to the

current sample rate.

When two channels are enabled, the memory depths available include Auto, 6kPoints, 60kPoints, 600kPoints, 6MPoints and 12MPoints (optional). In "Auto" mode, the oscilloscope selects the memory depth automatically according to the current sample rate.

When four channels are enabled, the memory depths available include Auto, 3kPoints, 30kPoints, 300kPoints, 3MPoints and 6MPoints (optional). In "Auto" mode, the oscilloscope selects the memory depth automatically according to the current sample rate.

Antialiasing

At slower sweep speed, the sample rate is reduced and a dedicated display algorithm is used to minimize the possibility of aliasing.

Press **Acquire** → **Anti_Aliasing** to enable or disable the antialiasing function. By default, antialiasing is disabled. The displayed waveforms will be more susceptible to aliasing when this function is disabled.

Chapter 5 To Trigger the Oscilloscope

For trigger, you set certain trigger condition according to the requirement and when a waveform in the waveform stream meets this condition, the oscilloscope captures this waveform as well as the neighbouring part and displays them on the screen. For digital oscilloscope, it displays waveform continuously no matter whether it is stably triggered, but only stable trigger can ensure stable display. The trigger circuit ensures that every time base sweep or acquisition starts from the input signal and the user-defined trigger condition, namely every sweep is synchronous to the acquisition and the waveforms acquired overlap to display stable waveform.

Trigger setting should be based on the features of the input signal, thus you need to have some knowledge of the signal under test to quickly capture the desired waveform. This oscilloscope provides abundant advanced trigger functions which can help you to focus on the desired waveform details.

The contents of this chapter:

- Trigger Source
- Trigger Mode
- Trigger Coupling
- Trigger Holdoff
- Noise Rejection
- Trigger Type
- Trigger Output Connector

Trigger Source

Press **MENU** → **Source** in the trigger control area (TRIGGER) at the front panel to select the desired trigger source. Signals input from CH1-CH4 and AC can all be used as trigger source.

Analog channel input (CH1 to CH4):

Signals input from analog channels CH1-CH4 can all be used as the trigger source. No matter whether the input of the channel selected is enabled, the channel can work normally.

AC:

The trigger signal is obtained from the AC power input of the oscilloscope. This kind of signals can be used to display the relationship between signal (such as illuminating device) and power (power supply device). For example, to stably trigger the waveform output from the transformer of a transformer substation, which is mainly used in related measurement of the power industry.

Trigger Mode

Trigger mode affects the way in which the oscilloscope searches for the trigger. The following is the schematic diagram of the acquisition memory. As shown in the figure below, the position of the trigger event is determined by the reference time point and the delay setting. Note that the acquisition memory of the oscilloscope is a cyclic buffer and the new data would overwrite the old data until the acquisition finishes.

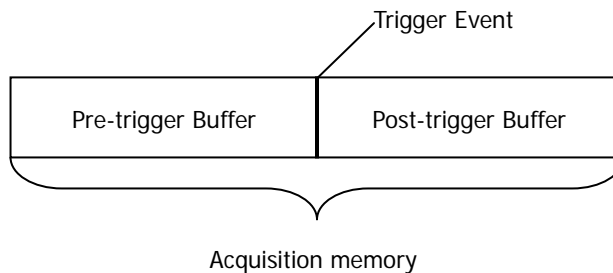



Figure 5-1 Acquisition Memory Schematic Diagram

Pre-trigger/Delayed trigger:

Acquire data before/after the trigger event. The trigger position is usually at the horizontal center of the screen. In full-screen display, six-grid pre-trigger and delayed trigger information are displayed respectively. You can adjust the horizontal position of the waveform through **HORIZONTAL**  **POSITION** to view more pre-trigger information and delayed trigger information, through which the signal information before/after the trigger (such as capture the glitch generated by the circuit and analyze the pre-trigger data to find out the reasons for glitch) can be obtained.

Press **MODE** in the trigger control area (TRIGGER) at the front panel or press **MENU** → **Sweep** to select the desired trigger mode. The corresponding status light of the mode currently selected turns on.

Auto:

No matter whether the trigger condition is met, there is always waveform display. A horizontal line is displayed when no signal is input.

In this mode, the oscilloscope operates by first filling the pre-trigger buffer. It starts searching for a trigger after the pre-trigger buffer is filled and continues to flow data

through this buffer while it searches for the trigger. While searching for the trigger, the oscilloscope overflows the pre-trigger buffer and the first data put into the buffer is first pushed out (First Input First Out, FIFO). When a trigger is found, the pre-trigger buffer would contain the data acquired just before the trigger. If no trigger is found, the oscilloscope will trigger forcefully. If forceful trigger is invalid, the oscilloscope still displays waveform but the waveform is not stable; if forceful trigger is valid, the oscilloscope displays stable waveform.

This trigger mode is applicable to low-repetitive-rate signals and unknown signal levels. To display DC signals, you must use auto trigger mode.

Note: When the horizontal time base is set to 50 ms/div or greater, this trigger mode allows the absence of trigger signal.

Normal:

Display waveform when the trigger condition is met; otherwise, the oscilloscope holds the original waveform and waits for the next trigger.

In this mode, the oscilloscope fills the pre-trigger buffer first and then search for a trigger while at the same time continues filling data. While searching for the trigger, the oscilloscope overflows the pre-trigger buffer and the first data put into the buffer is first pushed out (FIFO). When a trigger is found, the oscilloscope will fill the post-trigger buffer and display the acquisition memory.

Use normal trigger mode for low-repetitive-rate signals or when auto trigger is not required.

Single:

When this mode is selected, the backlight of **SINGLE** turns on. The oscilloscope waits for a trigger and displays the waveform when the trigger condition is met and then stops.

Trigger Coupling

Trigger coupling decides which kind of components will be transmitted to the trigger circuit. Please distinguish it with “**Channel Coupling**”.

- DC: allow DC and AC components into the trigger path.
- AC: block all the DC components and attenuate signals lower than 75 kHz.
- LF Reject: block the DC components and reject the low frequency components (lower than 75 kHz).
- HF Reject: reject the high frequency components (higher than 75 kHz).

Press **MENU** → **Setting** → **Coupling** in the trigger control area (TRIGGER) at the front panel to select the desired coupling type (the default is DC). Note that trigger coupling is only valid in edge trigger.

Trigger Holdoff

Trigger holdoff can be used to stably trigger the complex waveforms (such as pulse series). Holdoff time is the amount of time that the oscilloscope waits before re-arming the trigger circuitry. The oscilloscope will not trigger until the holdoff time expires.

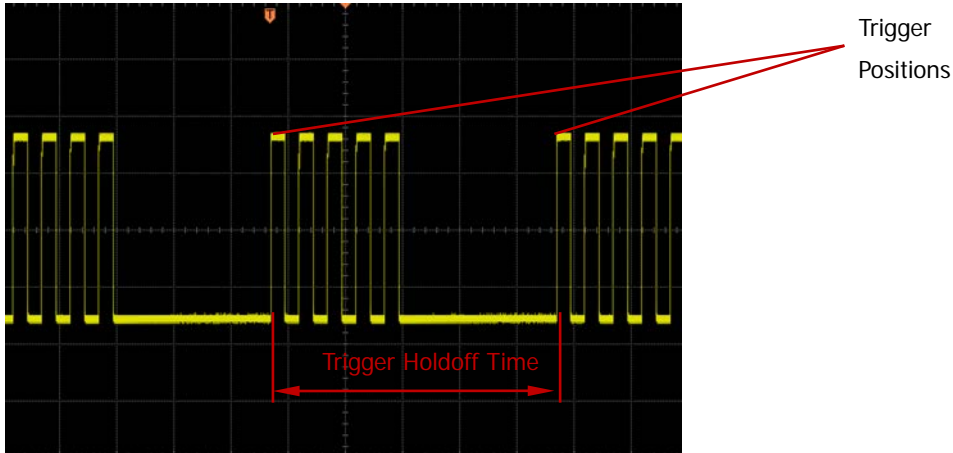



Figure 5-2 Trigger Holdoff

Press **MENU** → **Setting** → **Holdoff** in the trigger control area (TRIGGER) at the front panel and use  to modify the holdoff time (the default is 16 ns) until the waveform triggers stably. The adjustable range of holdoff time is from 16 ns to 10 s. Note that trigger holdoff is not available for video trigger.

Noise Rejection

Noise rejection reduces the possibility of noise trigger.

Press **MENU** → **Setting** → **Noise Reject** in the trigger control area (TRIGGER) at the front panel to enable or disable noise rejection.

Trigger Type

DS1000Z provides various trigger functions, including various serial bus triggers.

- Edge Trigger
- Pulse Trigger
- Slope Trigger
- Video Trigger
- Pattern Trigger
- Duration Trigger
- Setup/Hold Trigger (Option)
- TimeOut Trigger (Option)
- Runt Trigger (Option)
- Windows Trigger (Option)
- Delay Trigger (Option)
- Nth Edge Trigger (Option)
- RS232 Trigger (Option)
- I2C Trigger (Option)
- SPI Trigger (Option)

Edge Trigger

Trigger on the trigger level of the specified edge of the input signal.

Trigger Type:

Press **Type** to select "Edge". At this point, the trigger setting information as shown in the figure below is displayed at the upper right corner of the screen.





Source Selection:

Press **Source** to select CH1-CH4 or AC as the "Trigger Source". The current trigger source is displayed at the upper right corner of the screen.

Note: Select channel with signal input as trigger source to obtain stable trigger.

Edge Type:

Press **Slope** to select the kind of edge of the input signal on which the oscilloscope triggers. The current edge type is displayed at the upper right corner of the screen.

- : trigger on the rising edge of the input signal when the voltage level meets the preset trigger level.
- : trigger on the falling edge of the input signal when the voltage level meets the preset trigger level.
- : trigger on the rising or falling edges of the input signal when the voltage level meets the preset trigger level.

Trigger Mode:



Press **Sweep** to select the "Trigger Mode" under this trigger type as auto, normal or single. The corresponding status light of the current trigger mode turns on.

Trigger Setting:

Press **Setting** to set the trigger parameters (trigger coupling, trigger holdoff and noise rejection) under this trigger type.

Trigger Level:

Trigger occurs only when the signal reaches the preset trigger level.

Use **TRIGGER**  **LEVEL** to modify the trigger level. An orange trigger level line and the trigger mark "" appear on the screen and move up and down with the rotation of the knob, while at the same time, the trigger level value (as shown in the figure below) at the lower left corner of the screen also changes accordingly. When stopping turning the knob, the trigger level line and the trigger mark disappear in about 2 s.



Pulse Trigger

Trigger on the positive or negative pulse with a specified width.

Trigger Type:

Press **Type** to select "Pulse". At this point, the trigger setting information as shown in the figure below is displayed at the upper right corner of the screen.



Source Selection:

Press **Source** to select CH1-CH4 as the "Trigger Source". The current trigger source is displayed at the upper right corner of the screen.

Note: Select channel with signal input as trigger source to obtain stable trigger.

Pulse Condition:

Press **When** to select the desired pulse condition.

- : trigger when the positive pulse width of the input signal is greater than the specified pulse width.
- : trigger when the positive pulse width of the input signal is lower than the specified pulse width.
- : trigger when the positive pulse width of the input signal is greater than the specified lower limit of pulse width and lower than the upper limit of pulse width.
- : trigger when the negative pulse width of the input signal is greater than the specified pulse width.
- : trigger when the negative pulse width of the input signal is lower than the specified pulse width.
- : trigger when the negative pulse width of the input signal is greater than the specified lower limit of pulse width and lower than the upper limit of pulse width.

Pulse Width Setting:

As shown in the figure below, positive pulse width is defined as the time difference between the two crossing points of the trigger level and positive pulse and negative pulse width is defined as the time difference between the two crossing points of the trigger level and negative pulse.

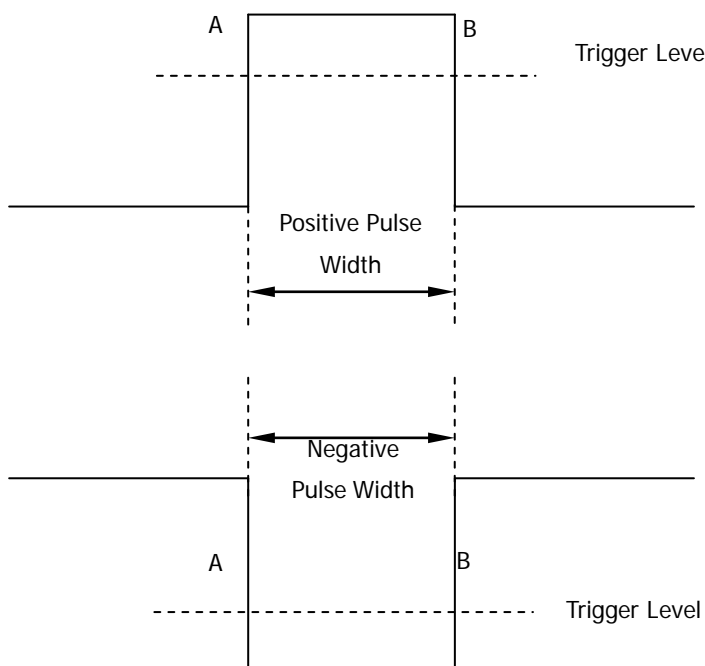









Figure 5-3 Positive Pulse Width/Negative Pulse Width

- When the **Pulse Condition** is set to , ,  or , press **Setting** and use  to input the desired value. The range available is from 8 ns to 10 s.
- When the **Pulse Condition** is set to  or , press **Upper Limit** and **Lower Limit** and use  to input the desired values respectively. The range of the upper limit is from 16 ns to 10 s. The range of the lower limit is from 8 ns to 9.99 s. Note that the lower limit of the pulse width must be lower than the upper limit.

Trigger Mode:

Press **Sweep** to select the “**Trigger Mode**” under this trigger type as auto, normal or single. The corresponding status light of the current trigger mode turns on.

Trigger Setting:

Press **Setting** to set the trigger parameters (trigger holdoff and noise rejection) under this trigger type.

Trigger Level:

Use **TRIGGER**  **LEVEL** to modify the level. For details, please refer to the description of “**Trigger Level**” on page 5-9.

Slope Trigger

Trigger on the positive or negative slope of specified time.

Trigger Type:

Press **Type** to select "Slope". At this point, the trigger setting information as shown in the figure below is displayed at the upper right corner of the screen.



Source Selection:

Press **Source** to select CH1-CH4 as the "Trigger Source". The current trigger source is displayed at the upper right corner of the screen.

Note: Select channel with signal input as trigger source to obtain stable trigger.

Slope Condition:

Press **When** to select the desired slope condition.

- : trigger when the positive slope time of the input signal is greater than the specified time.
- : trigger when the positive slope time of the input signal is lower than the specified time.
- : trigger when the positive slope time of the input signal is greater than the specified lower limit of time and lower than the specified upper limit of time.
- : trigger when the negative slope time of the input signal is greater than the specified time.
- : trigger when the negative slope time of the input signal is lower than the specified time.
- : trigger when the negative slope time of the input signal is greater than the specified lower limit of time and lower than the specified upper limit of time.

Time Setting:

As shown in the figure below, positive slope time is defined as the time difference between the two crossing points of trigger level upper limit and lower limit with the positive edge and negative slope time is defined as the time difference between the two crossing points of trigger level upper limit and lower limit with the negative edge.

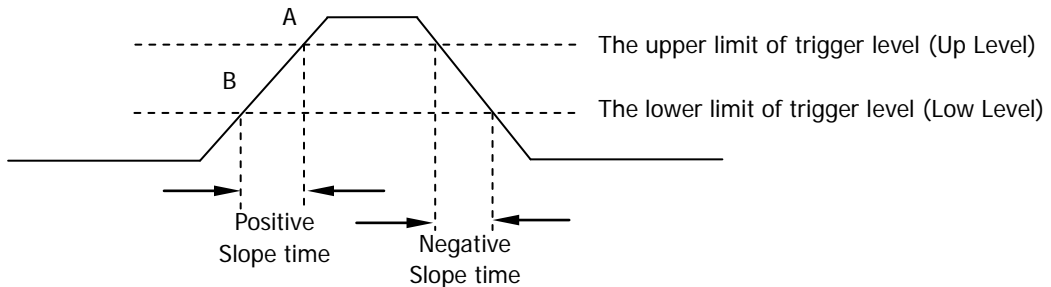

Figure 5-4 Positive Slope Time/Negative Slope Time

- When the **Slope Condition** is set to , , or , press **Time** and use to input the desired value. The range available is from 8 ns to 10 s.
- When the **Slope Condition** is set to or , press **Upper Limit** and **Lower Limit** and use to input the desired values respectively. The range of time upper limit is from 16 ns to 10 s. The range of the time lower limit is from 8 ns to 9.99 s. Note that the time lower limit must be lower than the upper limit.



Vertical Window:

Press **Vertical** to select the desired vertical window and then use **TRIGGER** **LEVEL** to adjust the trigger level. During the adjustment, two orange trigger level lines and two trigger marks (and) appear on the screen and move up and down with the rotation of the knob, while at the same time, the trigger level value and the slope value are displayed at the lower left corner of the screen. When stopping turning the knob, the trigger level lines and trigger marks disappear in about 2 s.

When the **Slope Condition** is set to , , or , the current trigger level and slope will be displayed at the lower left corner of the screen, as shown in figure (a). The slope calculation formula is:

$$SlewRate = \frac{UpLevel - LowLevel}{TimeSetting}$$

Wherein, *TimeSetting* is the time currently set.

When the **Slope Condition** is set to  or , the current trigger level, minimum slope and maximum slope will be displayed at the lower left corner of the screen, as shown in figure (b). The calculation formulas of the minimum slope and maximum slope are:

$$MinRate = \frac{UpLevel - LowLevel}{UpTime}$$

$$MaxRate = \frac{UpLevel - LowLevel}{LowTime}$$

Wherein, *UpTime* and *LowTime* are the time upper limit and time lower limit currently set.

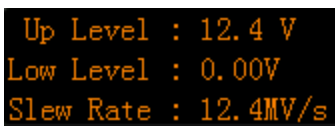

Figure (a)

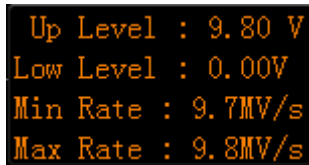





Figure (b)

Figure 5-5 Trigger Level and Slope

The adjustment mode of the trigger level is different when different vertical window is selected.

- : only adjust the upper limit of the trigger level. During the adjustment, "UP Level" and "Slew Rate" change accordingly but "Low Level" remains unchanged.
- : only adjust the lower limit of the trigger level. During the adjustment, "Low Level" and "Slew Rate" change accordingly but "UP Level" remains unchanged.
- : adjust the upper and lower limits of the trigger level at the same time. During the adjustment, "UP Level" and "Low Level" change accordingly but "Slew Rate" remains unchanged.

Note: Under the "Slope" trigger menu, you can also press down the trigger level knob continuously to switch the vertical window.

Trigger Mode:

Press **Sweep** to select the "**Trigger Mode**" under this trigger type as auto, normal or single. The corresponding status light of the current trigger mode turns on.

Trigger Setting:

Press **Setting** to set the trigger parameters (trigger holdoff and noise rejection) under this trigger type.

Video Trigger

Trigger on the specified standard video signal field or line.

Trigger Type:

Press **Type** to select “Video”. At this point, the trigger setting information as shown in the figure below is displayed at the upper right corner of the screen.



Source Selection:

Press **Source** to select CH1-CH4 as the “**Trigger Source**”. The current trigger source is displayed at the upper right corner of the screen.

Note: Select channel with signal input as trigger source to obtain stable trigger.

Video Polarity:

Press **Polarity** to select the desired video polarity. The polarities available are normal polarity (⏏) and inverted polarity (⏏).

Sync:

Press **Sync** to select the desired sync type.

- All Lines: trigger on all the horizontal sync pulses.
- Line Num: for NTSC and PAL/SECAM video standards, trigger on the specified line in the odd or even field; for HDTV video standard, trigger on the specified line. Note that when this sync trigger mode is selected, you can modify the line number using ↻ in the **Line Num** menu with a step of 1. The range of the line number is from 1 to 525 (NTSC), 1 to 625 (PAL/SECAM), 1 to 525 (480P), 1 to 625 (576P).
- Odd field: trigger on the rising edge of the first ramp waveform pulse in the odd field.
- Even field: trigger on the rising edge of the first ramp waveform pulse in the even field.

Video Standard:

Press **Standard** to select the desired video standard.

- NTSC: the field frequency is 60 fields per second and the frame frequency is 30 frames per second. The TV sweep line is 525 with the even field goes first and the odd field follows behind.
- PAL: the frame frequency is 25 frames per second. The TV sweep line is 625 with the odd field goes first and the even field follows behind.
- SECAM: the frame frequency is 25 frames per second. The sweep line is 625

with interlacing sweep.

- 480P: the frame frequency is 60 frames per second; the TV sweep line is 525; line-by-line sweep; the line frequency is 31.5 kHz.
- 576P: the frame frequency is 60 frames per second; the TV sweep line is 625; line-by-line sweep.

Trigger Mode:

Press **Sweep** to select the "Trigger Mode" under this trigger type as auto, normal or single. The corresponding status light of the current trigger mode turns on.

Trigger Setting:

Press **Setting** to set the trigger parameter (noise rejection) under this trigger type.

Trigger Level:

Use **TRIGGER**  **LEVEL** to modify the level. For details, please refer to the description of "Trigger Level" on page 5-9.

Pattern Trigger

Identify a trigger condition by looking for a specified pattern. This pattern is a logical “AND” combination of the values of the four channels. Each channel can have a value of high (H), low (L) or don’t care (X). A rising or falling edge can be specified for one channel included in the pattern. When an edge is specified, the oscilloscope will trigger at the edge specified if the pattern set for the other channel is true (H or L). If no edge is specified, the oscilloscope will trigger on the last edge that makes the pattern true. If both the channels in the pattern are set to “Don’t Care”, the oscilloscope will not trigger.

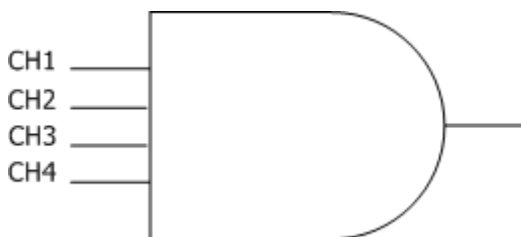

Figure 5-6 Pattern Trigger Schematic Diagram

Trigger Type:

Press **Type** to select “Pattern”. At this point, the trigger setting information as shown in the figure below is displayed at the upper right corner of the screen.



Channel Selection:



Press **Source** to select CH1-CH4 respectively. The current signal source is displayed at the upper right corner of the screen.

Pattern Setting:

Press **Code** to set the pattern of the current channel. At this point, the pattern setting area (as shown in the figure below) is displayed at the bottom of the screen.



- **H**: set the pattern of the channel selected to “H”, namely the voltage level is higher than the trigger level of the channel.
- **L**: set the pattern of the channel selected to “L”, namely the voltage level is lower than the trigger level of the channel.

- : set the pattern of the channel selected to "Don't Care", namely this channel is not used as a part of the pattern. When both the channels in the pattern are set to "Don't Care", the oscilloscope will not trigger.
-  or : set the pattern to the rising or falling edge of the channel selected.

Note: Only one rising or falling edge can be specified in the pattern. If one edge item is currently defined and then another edge item is defined in another channel in the pattern, the former edge item defined will be replaced by X.

Trigger Mode:

Press **Sweep** to select the "Trigger Mode" under this trigger type as auto, normal or single. The corresponding status light of the current trigger mode turns on.

Trigger Setting:

Press **Setting** to set the trigger parameters (trigger holdoff and noise rejection) under this trigger type.

Trigger Level:

Press **Source** to select CH1-CH4 respectively and use **TRIGGER**  **LEVEL** to set the trigger level of each channel. For details, please refer to the description of "Trigger Level" on page 5-9.

Duration Trigger

Identify a trigger condition by looking for the duration of a specified pattern. This pattern is a logical “AND” combination of the four channels. Each channel can have a value of high (H), low (L) or don't care (X). The instrument triggers when the duration (ΔT) of this pattern meets the preset time, as shown in the figure below.

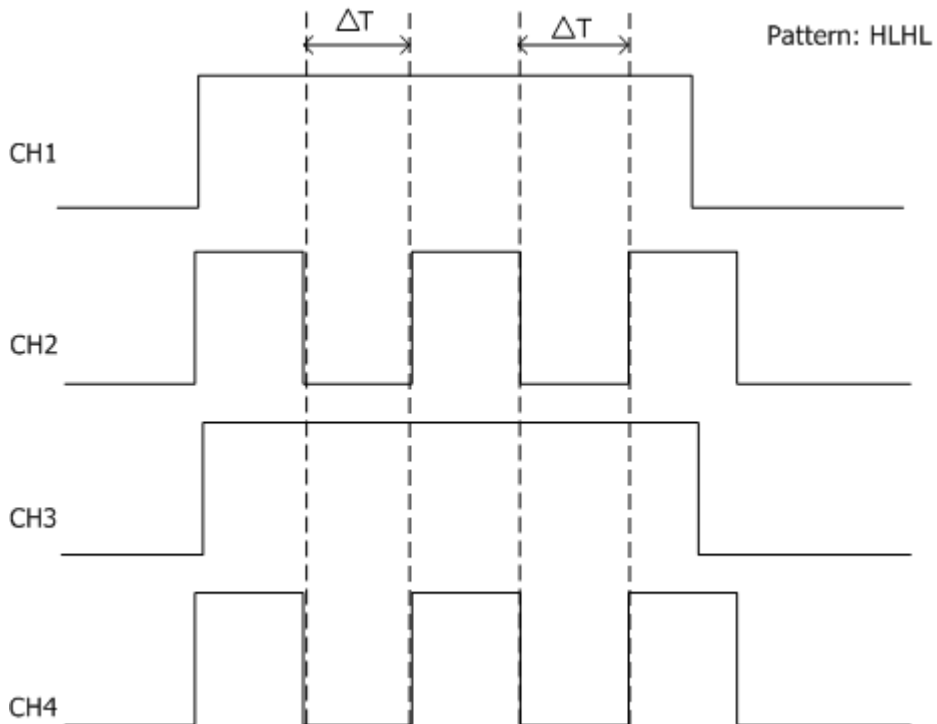

Figure 5-7 Duration Trigger Schematic Diagram

Trigger Type:

Press **Type** to select “Duration”. At this point, the trigger setting information as shown in the figure below is displayed at the upper right corner of the screen.

T Dur 1 0.00V

Source Selection:

Press **Source** to select CH1-CH4 respectively. The current signal source is displayed at the upper right corner of the screen.

Pattern Setting:

Press **Code** to set the pattern of the current channel. At this point, the pattern setting area (as shown in the figure below) is displayed at the bottom of the screen.



- **H**: set the pattern of the channel selected to "H", namely the voltage level is higher than the trigger level of the channel.
- **L**: set the pattern of the channel selected to "L", namely the voltage level is lower than the trigger level of the channel.
- **X**: set the pattern of the channel selected to "Don't Care", namely this channel is not used as a part of the pattern. When both the channels in the pattern are set to "Don't Care", the oscilloscope will not trigger.

Trigger Condition:

Press **When** to select the desired trigger condition.

- **>**: trigger when the duration of the pattern is greater than the preset time. Press **Time** to set the duration of duration trigger and the range is from 8 ns to 10 s.
- **<**: trigger when the duration of the pattern is lower than the preset time. Press **Time** to set the duration of duration trigger and the range is from 8 ns to 10 s.
- **<>**: trigger when the duration of the pattern is lower than the upper limit of the preset time and greater than the lower limit of the preset time. Press **Upper Limit** to set the upper limit of the duration of duration trigger and the range is from 16 ns to 10 s. Press **Lower Limit** to set the lower limit of the duration of duration trigger and the range is from 8 ns to 9.99 s.

Note: The time lower limit must be lower than the time upper limit.

Trigger Mode:

Press **Sweep** to select the "Trigger Mode" under this trigger type as auto, normal or single. The corresponding status light of the current trigger mode turns on.

Trigger Setting:

Press **Setting** to set the trigger parameters (trigger holdoff and noise rejection) under this trigger type.

Trigger Level:

Press **Source** to select CH1-CH4 respectively and use **TRIGGER**  **LEVEL** to set the trigger level of each channel. For details, please refer to the description of "Trigger Level" on page 5-9.

Setup/Hold Trigger (Option)

Trigger when the internal state of the setup or hold time relative to the clock edge is changed by the logic data input, namely trigger when the setup time ($\Delta T1$) is less than the preset setup time or when the hold time ($\Delta T2$) is less than the preset hold time, as shown in the figure below.

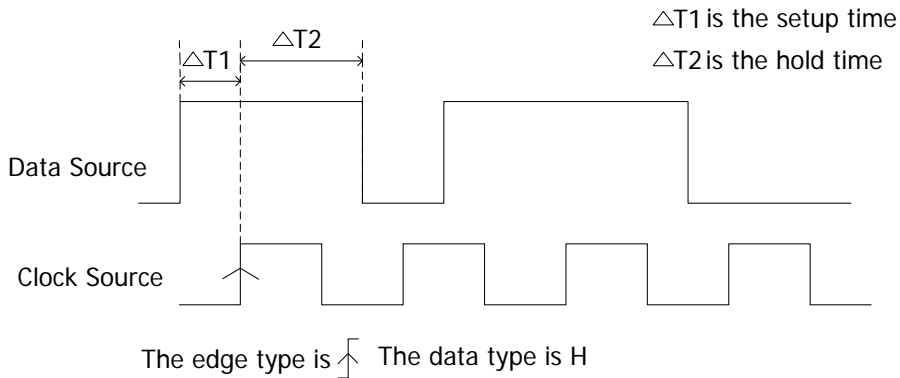

Figure 5-8 Setup/Hold Trigger Schematic Diagram

Trigger Type:

Press **Type** to select "Setup/Hold". At this point, the trigger setting information as shown in the figure below is displayed at the upper right corner of the screen.



Source Selection:

Press **DataSrc** and **ClkSrc** to set the data sources of the data line and clock line respectively. They can be set to CH1-CH4 and the current data sources are displayed at the upper right corner of the screen.

Edge Type:

Press **Slope** to select the desired clock edge type and it can be set to the rising edge or falling edge.

Data Type:

Press **Pattern** to set the effective pattern of the data signal to H (high level) or L (low level).

Setup Type:

Press **SetupType** to select the desired setup type.

- **Setup**: set the time that the data stays stable and constant before the clock edge appears. Press **Setup** to set the setup time and the range is from 8 ns to 1 s.
- **Hold**: set the time that the data stays stable and constant after the clock edge appears. Press **Hold** to set the hold time and the range is from 8 ns to 1 s.
- **SetupHold**: set the time that the data stays stable and constant before and after the clock edge appears. Press **Setup** and **Hold** to set the setup time and hold time respectively and the range is from 8 ns to 1 s.



Trigger Mode:

Press **Sweep** to select the "Trigger Mode" under this trigger type as auto, normal or single. The corresponding status light of the current trigger mode turns on.

Trigger Setting:

Press **Setting** to set the trigger parameters (trigger holdoff and noise rejection) under this trigger type.

Trigger Level:

Press **DataSrc** and use **TRIGGER  LEVEL** to modify the trigger level of the data source. Press **ClkSrc** and use **TRIGGER  LEVEL** to modify the trigger level of the clock source. For details, please refer to the description of "Trigger Level" on page 5-9.

TimeOut Trigger (Option)

Trigger when the time interval (ΔT) from when the rising edge (or falling edge) of the input signal passes through the trigger level to when the neighbouring falling edge (or rising edge) passes through the trigger level is greater than the timeout time set, as shown in the figure below.

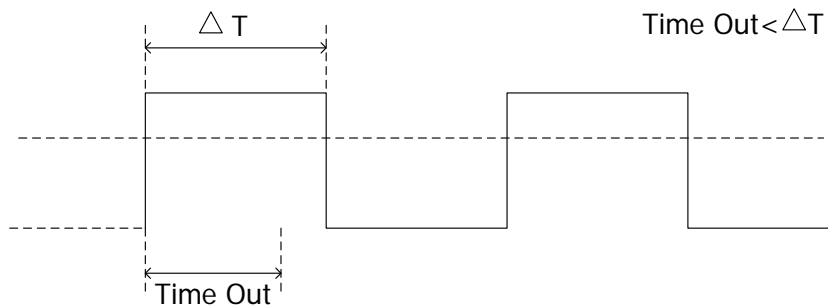

Figure 5-9 TimeOut Trigger Schematic Diagram

Trigger Type:

Press **Type** to select "TimeOut". At this point, the trigger setting information as shown in the figure below is displayed at the upper right corner of the screen.





Source Selection:

Press **Source** to select CH1-CH4 as the "Trigger Source". The current trigger source is displayed at the upper right corner of the screen.

Note: Select channel with signal input as trigger source to obtain stable trigger.

Edge Type:

Press **Slope** to select the type of the first edge of the input signal that passes through the trigger level.

- : start timing when the rising edge of the input signal passes through the trigger level.
- : start timing when the falling edge of the input signal passes through the trigger level.
- : start timing when any edge of the input signal passes through the trigger level.

Timeout Time:

Press **TimeOut** to set the timeout time of timeout trigger and the range is from 16 ns to 10 s.

Trigger Mode:

Press **Sweep** to select the "**Trigger Mode**" under this trigger type as auto, normal or single. The corresponding status light of the current trigger mode turns on.

Trigger Setting:

Press **Setting** to set the trigger parameters (trigger holdoff and noise rejection) under this trigger type.

Trigger Level:

Use **TRIGGER**  **LEVEL** to modify the level. For details, please refer to the description of "**Trigger Level**" on page **5-9**.

Runt Trigger (Option)

This trigger mode is used to trigger pulses that pass through one trigger level but fails to pass through the other trigger level as shown in the figure below.

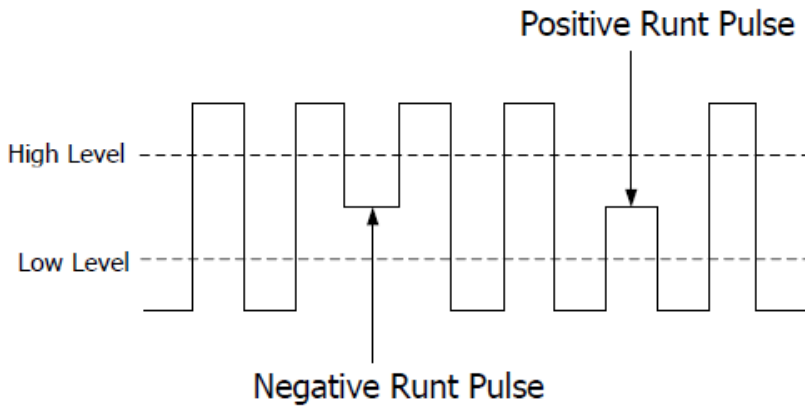

Figure 5-10 Runt Trigger Schematic Diagram

Trigger Type:

Press **Type** to select "Runt". At this point, the trigger setting information as shown in the figure below is displayed at the upper right corner of the screen.



T Runt 1 Δ 10.0 V

Source Selection:

Press **Source** to select CH1-CH4 as the "Trigger Source". The current trigger source is displayed at the upper right corner of the screen.

Pulse Polarity:

Press **Polarity** to select the pulse polarity of runt trigger.

- : positive polarity. The instrument triggers on the positive runt pulse.
- : negative polarity. The instrument triggers on the negative runt pulse.

Qualifier:

Press **Qualifier** to set the trigger conditions of runt trigger.



- **None**: do not set the trigger condition of runt trigger.
- **>**: trigger when the runt pulse width is greater than the lower limit of pulse width. Press **Lower Limit** to set the minimum pulse width of runt trigger. The

range available is from 8 ns to 10 s.

- <: trigger when the runt pulse width is lower than the upper limit of pulse width. Press **Upper Limit** to set the maximum pulse width of runt trigger. The range available is from 8 ns to 10 s.
- <>: trigger when the runt pulse width is greater than the lower limit and lower than the upper limit of pulse width. Press **Upper Limit** to set the maximum pulse width of runt trigger and the range is from 16 ns to 10 s; press **Lower Limit** to set the minimum pulse width of runt trigger and the range is from 8 ns to 9.99 s.

Note: The lower limit of the pulse width must be lower than the upper limit.

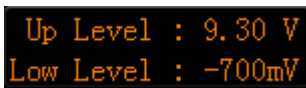

Vertical Window:

Press **Vertical** to select the desired vertical window type and then use **Trigger**  **LEVEL** to adjust the trigger level. During the adjustment, two orange trigger level lines and trigger marks ( and ) appear on the screen and move up and down with the rotation of the knob. At the same time, the current trigger level values are displayed at the lower left corner of the screen. The trigger level lines and trigger marks disappear after you stop rotating the knob for 2 s.



Up Level : 9.30 V
Low Level : -700mV

The adjustment mode of the trigger level differs when different vertical window is selected.

- : only adjust the upper limit of the trigger level. During the adjustment, the “Up Level” changes accordingly and “Low Level” remains unchanged.
- : only adjust the lower limit of the trigger level. During the adjustment, the “Low Level” changes accordingly and the “Up Level” remains unchanged.
- : adjust the upper and lower limits of the trigger level at the same time. During the adjustment, the “Up Level” and “Low Level” change accordingly.

Note: Under the “Runt trigger” menu, you can press the trigger level knob continuously to switch among different vertical window types.

Trigger Mode:

Press **Sweep** to select the “**Trigger Mode**” under this trigger type as auto, normal or single. The corresponding status light of the current trigger mode turns on.

Trigger Setting:

Press **Setting** to set the trigger parameters (trigger holdoff and noise rejection) under this trigger type.

Windows Trigger (Option)

Windows trigger provides a high trigger level and a low trigger level. The instrument triggers when the input signal passes through the high trigger level or the low trigger level.

Trigger Type:

Press **Type** to select "Windows". At this point, the trigger setting information as shown in the figure below is displayed at the upper right corner of the screen.





Source Selection:

Press **Source** to select CH1-CH4 as the "Trigger Source". The current trigger source is displayed at the upper right corner of the screen.

Note: Select channel with signal input as trigger source to obtain stable trigger.

Windows Type:

Press **WndType** to select the kind of edge of the input signal on which the oscilloscope triggers.

- : trigger on the rising edge of the input signal when the voltage level is greater than the preset high trigger level.
- : trigger on the falling edge of the input signal when the voltage level is lower than the preset low trigger level.
- : trigger on any edge of the input signal when the voltage level meets the preset trigger level.

Trigger Position:

After selecting the windows type, press **Position** to further specify the time point of trigger by selecting the trigger position.

- **Enter**: trigger when the trigger signal enters the specified trigger level range.
- **Exit**: trigger when the input signal exits the specified trigger level range.
- **Time**: used to specify the hold time of the input signal after entering the specified trigger level range. The instrument triggers when the accumulated hold time equals the windows time.

Vertical Window:

Press **Vertical** to select the desired vertical window type. For detailed operation, refer to “**Vertical Window**” on page **5-27**.

Trigger Mode:

Press **Sweep** to select the “**Trigger Mode**” under this trigger type as auto, normal or single. The corresponding status light of the current trigger mode turns on.

Trigger Setting:

Press **Setting** to set the trigger parameters (trigger holdoff and noise rejection) under this trigger type.

Delay Trigger (Option)

Trigger when the time difference (ΔT) between the specified edges of source A and source B meets the preset time limit, as shown in the figure below. Note that edge A and edge B must be neighbouring edges.

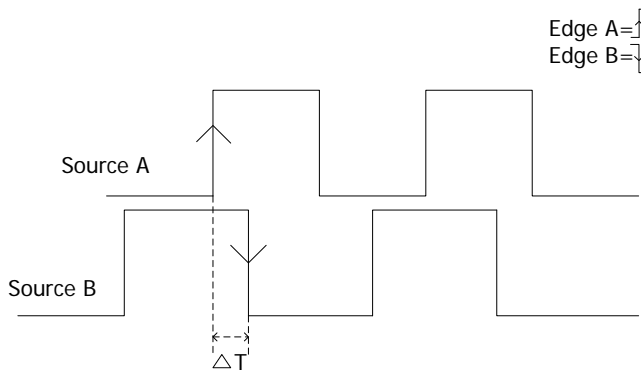

Figure 5-11 Delay Trigger Schematic Diagram

Trigger Type:

Press **Type** to select "Delay". At this point, the trigger setting information as shown in the figure below is displayed at the upper right corner of the screen.



Source A:

Press **SourceA** to select CH1-CH4 as the trigger source of signal source A.

Edge A:

Press **EdgeA** to select the trigger edge type of signal source A in delay trigger. It can be set to the rising edge or falling edge.

Source B:

Press **SourceB** to select CH1-CH4 as the trigger source of signal source B.

Edge B:

Press **EdgeB** to select the trigger edge type of signal source B in delay trigger. It can be set to the rising edge or falling edge.

Delay Type:

Press **DelayType** to set the time limit condition of delay trigger.

- **>**: trigger when the time difference (ΔT) between the specified edges of source A and source B is greater than the preset time limit. Press **Time** to set the delay time in delay trigger and the range is from 8 ns to 10 s.
- **<**: trigger when the time difference (ΔT) between the specified edges of source A and source B is lower than the preset time limit. Press **Time** to set the delay time in delay trigger and the range is from 8 ns to 10 s.
- **<>**: trigger when the time difference (ΔT) between the specified edges of source A and source B is greater than the lower limit of the preset time and lower than the upper limit of the preset time. Press **Upper Limit** to set the upper limit of the delay time in delay trigger and the range is from 16 ns to 10 s. Press **Lower Limit** to set the lower limit of the delay time in delay trigger and the range is from 8 ns to 9.99 s. Note that the time lower limit must be lower than the time upper limit.
- **><**: trigger when the time difference (ΔT) between the specified edges of source A and source B is lower than the lower limit of the preset time or greater than the upper limit of the preset time. Press **Upper Limit** to set the upper limit of the delay time in delay trigger and the range is from 16 ns to 10 s. Press **Lower Limit** to set the lower limit of the delay time in delay trigger and the range is from 8 ns to 9.99 s. Note that the time lower limit must be lower than the time upper limit.

Trigger Mode:

Press **Sweep** to select the "Trigger Mode" under this trigger type as auto, normal or single. The corresponding status light of the current trigger mode turns on.

Trigger Setting:

Press **Setting** to set the trigger parameters (trigger holdoff and noise rejection) under this trigger type.

Trigger Level:

Use **TRIGGER**  **LEVEL** to modify the level. For details, please refer to the description of "Trigger Level" on page 5-9.

Nth Edge Trigger (Option)

Trigger on the nth edge that appears after the specified idle time, as shown in the figure below.

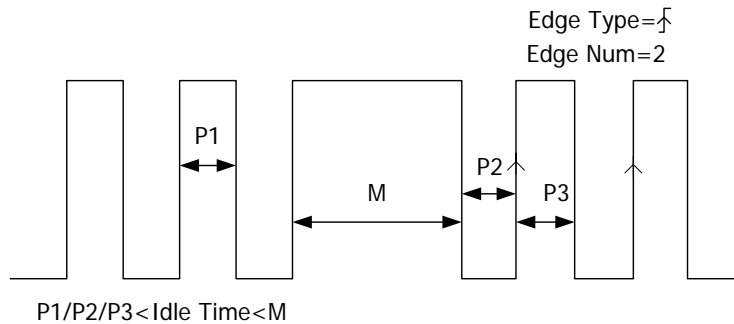

Figure 5-12 Nth Edge Trigger Schematic Diagram

Trigger Type:

Press **Type** to select "Nth Edge". At this point, the trigger setting information as shown in the figure below is displayed at the upper right corner of the screen.





Source Selection:

Press **Source** to select CH1-CH4 as the "Trigger Source". The current trigger source is displayed at the upper right corner of the screen.

Note: Select channel with signal input as trigger source to obtain stable trigger.

Edge Type:

Press **Slope** to select the kind of edge of the input signal on which the oscilloscope triggers.

- : trigger on the rising edge of the input signal when the voltage level meets the specified trigger level.
- : trigger on the falling edge of the input signal when the voltage level meets the specified trigger level.

Idle Time:

Press **Idle** to set the idle time before the edge counting in Nth edge trigger. The range available is from 16 ns to 10 s.

Edge Number:

Press **Edge** to set the value of "N" in Nth edge trigger and the range available is from 1 to 65535.

Trigger Mode:

Press **Sweep** to select the "Trigger Mode" under this trigger type as auto, normal or single. The corresponding status light of the current trigger mode turns on.

Trigger Setting:

Press **Setting** to set the trigger parameter (noise rejection) under this trigger type.

Trigger Level:

Use **TRIGGER**  **LEVEL** to modify the level. For details, please refer to the description of "Trigger Level" on page 5-9.

RS232 Trigger (Option)

The RS232 serial protocol transmits a character as a frame of data. Each frame of data always starts with a 1-bit start bit following which is 5-bit to 8-bit data bit and a 1-bit check bit (this bit can be omitted) and ends with a 1/2-bit of stop bit following which are the idle bit (the length is various). Its format is as shown in the figure below.



Figure 5-13 RS232 Protocol Schematic Diagram

DS1000Z can trigger when frame start, error frame, check error or the specified data on the RS232 signal is detected.

Trigger Type:

Press **Type** to select "RS232". At this point, the trigger setting information as shown in the figure below is displayed at the upper right corner of the screen.



Source Selection:

Press **Source** to select CH1-CH4 as the "Trigger Source". The current trigger source is displayed at the upper right corner of the screen.

Polarity

Press **Polarity** to select the polarity of data transmission. It can be set to "Normal" or "Invert" and the default is normal.

Trigger Condition:

Press **When** to select the desired trigger condition.

- Start: trigger on the start frame position.
- Error: trigger when error frame is detected. After this trigger condition is selected:
 - press **Stop Bit** to select "1 bit" or "2 bit";

--press **Even-OddCheck** to select "None", "Odd Checkout" or "Even Checkout".
The oscilloscope will determine error frame according to the preset parameters.

- Check Error: trigger when check error is detected. When this trigger condition is selected, press **Even-OddCheck** to select "Odd Checkout" or "Even Checkout".
The oscilloscope will determine check error according to the preset parameters.
- Data: trigger on the last bit of the preset data bits and even-odd check bits.
When this trigger condition is selected:
 - press **Data Bits** to select "5 bits", "6 bits", "7 bits" or "8 bits";
 - press **Data** and input the data value according to the setting in **Data Bits** and the upper limits are 31, 63, 127 and 255 respectively.

Baud Rate:

Set the baud rate of data transmission (equal to specifying a clock frequency). Press **Baud** to set the desired baud rate to 2400 (default), 4800, 9600, 19200, 38400, 57600, 115200 and user-defined, the default unit is bps. When "User" is selected, press **Setup** and use  to set a more specific value from 1 to 900000 with an adjustment step of 1 bps.

Trigger Mode:

Press **Sweep** to select the "Trigger Mode" under this trigger type as auto, normal or single. The corresponding status light of the current trigger mode turns on.

Trigger Setting:

Press **Setting** to set the trigger parameter (noise rejection) under this trigger type.

Trigger Level:

Use **TRIGGER**  **LEVEL** to modify the level. For details, please refer to the description of "Trigger Level" on page 5-9.

I2C Trigger (Option)

Trigger on the start condition, restart, stop, missing acknowledgement or on the read/write frame with specific device address and data value. In I2C trigger, you need to specify the SCL and SDA data sources. The figure below shows the complete data transmission of I2C bus.

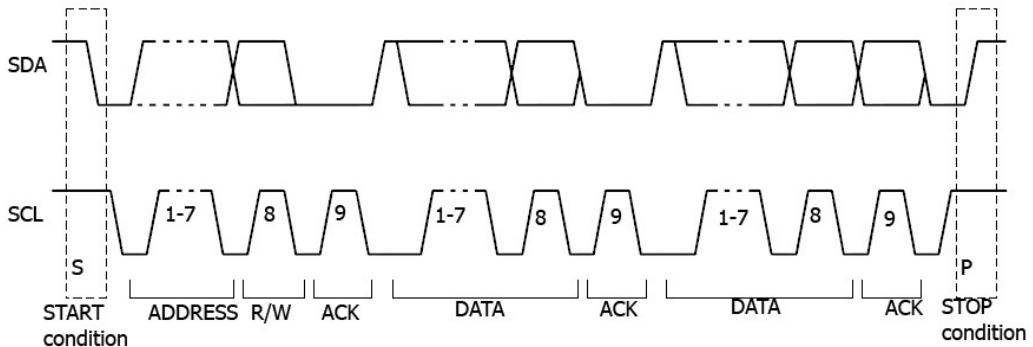

Figure 5-14 I2C Trigger Schematic Diagram

Trigger Type:

Press **Type** to select "I2C". At this point, the trigger setting information as shown in the figure below is displayed at the upper right corner of the screen.



Source Selection:

Press **SCL** and **SDA** to specify the data sources of SCL and SDA respectively. They can be set to CH1-CH4 and the current trigger source is displayed at the upper right corner of the screen.

Trigger Condition:

Press **When** to select the desired trigger condition.

- Start: trigger when SDA data transitions from high to low while SCL is high.
- Restart: trigger when another start condition occurs before a stop condition.
- Stop: trigger when SDA data transitions from low to high while SCL is high.
- Missing ACK: trigger when the SDA data is high during any acknowledgement of SCL clock position.

- Address: trigger on the clock (SCL) edge corresponding to the byte of data (SDA) behind the preset address (Write, Read or R/W direction). After this trigger condition is selected:
 - press **AddrBits** to select "7 bits", "8 bits" or "10 bits";
 - press **Address** to set the address value according to the setting in **AddrBits** and the ranges are from 0x0 to 0x7F, 0x0 to 0xFF and 0x0 to 0x3FF respectively;
 - press **Direction** to select "Read", "Write" or "R/W" (note: when **AddrBits** is set to "8 bits", this setting is not available).
- Data: the trigger searches for the control byte value on the data line (SDA) following which there is a reading bit and an acknowledgement bit and then searches for the specified data value. When this event occurs, the oscilloscope will trigger on the clock edge of the acknowledgement bit behind the data byte. After this trigger condition is selected:
 - press **Byte Length** to set the length of the data and the range is from 1 to 5;
 - press **CurrentBit** to select the desired data bit and the range is from 0 to (Byte Length×8-1);
 - press **Data** to set the data pattern of the current data bit to X, H or L.
 - press **AllBits** to set the data pattern of all the data bits to the data pattern specified in **Data**.
- A&D: trigger when the "Address" and "Data" conditions are met at the same time. After this trigger condition is selected:
 - press **AddrBits** to select "7 bits" ,"8 bits" or "10 bits";
 - press **Address** to set the address value according to the setting in **AddrBits** and the ranges are from 0x0 to 0x7F, 0x0 to 0xFF and 0x0 to 0x3FF respectively;
 - press **Byte Length** to set the length of the data and the range is from 1 to 5;
 - press **CurrentBit** to select the desired data bit and the range is from 0 to (Byte Length×8-1);
 - press **Data** to set the data pattern of the current data bit to X, H or L.
 - press **AllBits** to set the data pattern of all the data bits to the data pattern specified in **Data**.
 - press **Direction** to select "Read", "Write" or "R/W" (note: when **AddrBits** is set to "8 bit", this setting is not available).



Trigger Mode:

Press **Sweep** to select the "Trigger Mode" under this trigger type as auto, normal or single. The corresponding status light of the current trigger mode turns on.

Trigger Setting:

Press **Setting** to set the trigger parameter (noise rejection) under this trigger type.

Trigger Level:

Press **SCL** and use **TRIGGER  LEVEL** to modify the trigger level of the SCL channel. Press **SDA** and use **TRIGGER  LEVEL** to modify the trigger level of the SDA channel. For details, please refer to the description of “**Trigger Level**” on page **5-9**.

SPI Trigger (Option)

Trigger on the data pattern on the specified edge. When using SPI trigger, you need to specify the SCL and SDA data sources. Below is the sequence chart of SPI bus data transmission.

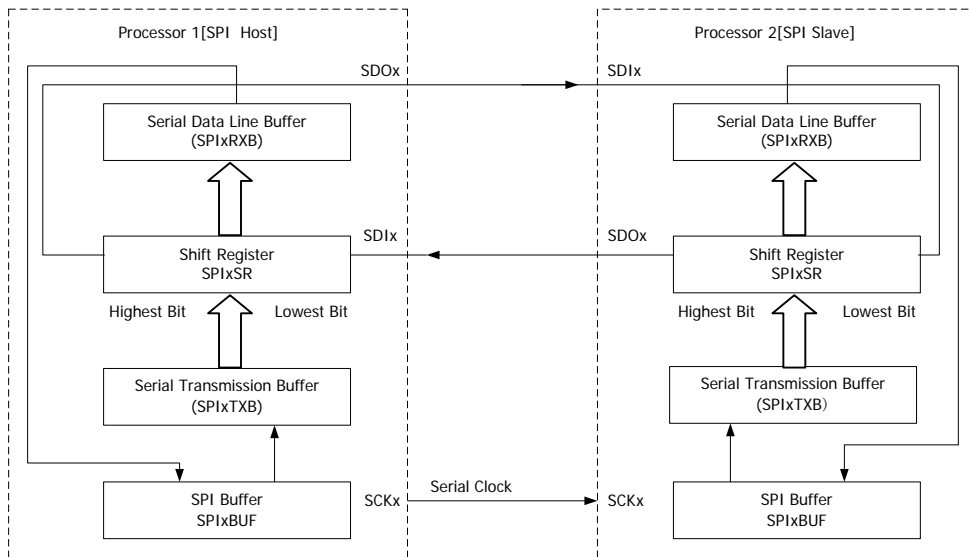

Figure 5-15 SPI Trigger Schematic Diagram

Trigger Type:

Press **Type** to select "SPI". At this point, the trigger setting information as shown in the figure below is displayed at the upper right corner of the screen.



Source Selection:

Press **SCL** and **SDA** to specify the data sources of SCL and SDA respectively. They can be set to CH1-CH4 and the current trigger source is displayed at the upper right corner of the screen.

Trigger Condition:

Press **When** to select the desired trigger condition.

- CS: trigger when the CS channel is high level or low level. After this trigger

condition is selected, press **Mode** to select **1L** (high level is 1) or **L1** (low level is 1). Note that **CS** is valid only when this condition is selected.

- **TimeOut**: set the minimum time that the clock (SCL) signal must be idle before the oscilloscope starts to search for the data (SDA) on which to trigger. Press **TimeOut** to set the timeout value and the range is from 100 ns to 1 s. Note that, at this point, **CS** is invalid (not displayed).



Data Line Setting:

Set the instrument to trigger when the specified bit and length of data is transmitted in the SDA.

- Press **Data Bits** to set the number of bits of the serial data character string. It can be set to any integer between 4 and 32.
- Press **CurrentBit** to set the number of the data bit and the range is from 0 to (value specified in **Data Bits** – 1).
- Press **Data** to set the value of the current bit to H, L or X.
- Press **AllBits** to set all the data bits to the value specified in **Data**.

Clock Edge:

Press **Clock Edge** to select the desired clock edge.

- : sample the SDA data on the rising edge of the clock.
- : sample the SDA data on the falling edge of the clock.



Trigger Mode:

Press **Sweep** to select the “**Trigger Mode**” under this trigger type as auto, normal or single. The corresponding status light of the current trigger mode turns on.

Trigger Setting:

Press **Setting** to set the trigger parameter (noise rejection) under this trigger type.

Trigger Level:

Press **SCL** and use **TRIGGER**  **LEVEL** to modify the trigger level of the SCL channel. Press **SDA** and use **TRIGGER**  **LEVEL** to modify the trigger level of the SDA channel. For details, please refer to the description of “**Trigger Level**” on page 5-9.

Trigger Output Connector

The trigger output connector (**[Trigger Out]**) at the rear panel can output trigger signals determined by the current setting.

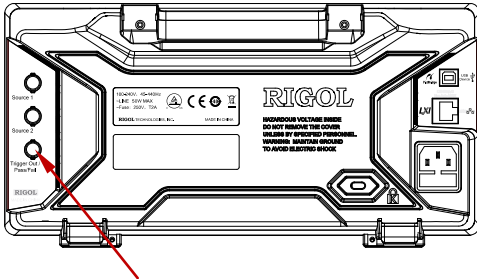

Trigger Output Connector

When the oscilloscope is triggered, a signal that can reflect the current capture rate of the oscilloscope will be outputted via **[Trigger Out]** connector. Connect the signal to a waveform display instrument to measure the frequency of the signal and the result is equal to the current capture rate.

Note: When **Utility** → **AuxOutput** is set to “Pass/Fail” to set or **Utility** → **Pass/Fail** → **AuxOutput** selects “ON”, during the pass/fail test, the **[Trigger Out]** connector outputs high level when failed waveforms are detected by the oscilloscope and outputs low level when no failed waveform is detected by the oscilloscope.

Chapter 6 To Make Measurements

DS1000Z can make math operation, auto measurement and cursor measurement on sampled and displayed data.

The contents of this chapter:

- Math Operation
- Auto Measurement
- Cursor Measurement

Math Operation





DS1000Z can realize various math operations (including: addition (A+B), subtraction (A-B), multiplication (AxB), division (A/B), FFT, A&&B, A||B, A^B, !A, Intg, Diff, Sqrt, Lg, Ln, Exp and Abs. The results of math operation also allows further measurement (for details, please refer to “Cursor Measurement”).

Press **MATH** → **Math** → **Operator** in the vertical control area (VERTICAL) at the front panel to select the desired operator. The result of math operation will be displayed on the waveform marked with “M” on the screen after you press **Display** to enable the operation.

Addition

Add the waveform voltage values of signal source A and B point by point and display the results.



Press **MATH** → **Math** → **Operator** to select “A+B”:

- Press **Display** to turn on or off the addition operation function.
- Press **Source A** and **Source B** to select the desired channels (CH1, CH2, CH3 or CH4).
- Press **Offset** and use  to adjust the vertical offset of the operation result.
- Press **Scale** and use  to adjust the vertical scale of the operation results.
- Press **Scale Reset**, the instrument will adjust the vertical scale to the best value according to the current configuration automatically.
- Press **Options** to set the start point, end point or turn on or off the inverted display of the operation results.
 - Press **Start** to set the start point of the operation results.
 - Press **End** to set the end point of the operation results.
 - Press **Invert** to turn the inverted display of the operation results on or off.
 - Press **Auto Scale** to turn on or off the auto scale function. When “ON” is selected, the instrument will adjust the vertical scale to the best value according to the current configuration automatically.
- **HORIZONTAL**  **POSITION** and **HORIZONTAL**  **SCALE** can also be used to adjust the horizontal position and scale of the operation results.

Substraction

Subtract the waveform voltage values of signal source B from that of source A point by point and display the results.

Press **MATH** → **Math** → **Operator** to select "A-B":



- Press **Display** to turn on or off the subtraction operation function.
- Press **Source A** and **Source B** to select the desired channels (CH1, CH2, CH3 or CH4).
- Press **Offset** and use  to adjust the vertical offset of the operation result.
- Press **Scale** and use  to adjust the vertical scale of the operation results.
- Press **Scale Reset**, the instrument will adjust the vertical scale to the best value according to the current configuration automatically.
- Press **Options** to set the start point, end point or turn on or off the inverted display of the operation results.

Press **Start** to set the start point of the operation results.

Press **End** to set the end point of the operation results.

Press **Invert** to turn the inverted display of the operation results on or off.

Press **Auto Scale** to turn on or off the auto scale function. When "ON" is selected, the instrument will adjust the vertical scale to the best value according to the current configuration automatically.



- **HORIZONTAL**  **POSITION** and **HORIZONTAL**  **SCALE** can also be used to adjust the horizontal position and scale of the operation results.

Multiplication

Multiply the waveform voltage values of signal source A and B point by point and display the results.

Press **MATH** → **Math** → **Operator** to select "A×B":



- Press **Display** to turn on or off the multiplication operation function.
- Press **Source A** and **Source B** to select the desired channels (CH1, CH2, CH3 or CH4).
- Press **Offset** and use  to adjust the vertical offset of the operation result.

- Press **Scale** and use  to adjust the vertical scale of the operation results.
- Press **Scale Reset**, the instrument will adjust the vertical scale to the best value according to the current configuration automatically.
- Press **Options** to set the start point, end point or turn on or off the inverted display of the operation results.
Press **Start** to set the start point of the operation results.
Press **End** to set the end point of the operation results.
Press **Invert** to turn the inverted display of the operation results on or off.
Press **Auto Scale** to turn on or off the auto scale function. When "ON" is selected, the instrument will adjust the vertical scale to the best value according to the current configuration automatically.
- **HORIZONTAL**  **POSITION** and **HORIZONTAL**  **SCALE** can also be used to adjust the horizontal position and scale of the operation results.



Division

Divide the waveform voltage values of signal source A by that of source B point by point and display the results. It can be used to analyze the multiple relationships of waveforms in two channels. Note that when the voltage value of channel B is 0, the result of the division is treated as 0.

Press **MATH** → **Math** → **Operator** to select "A/B":

- Press **Display** to turn on or off the division operation function.
- Press **Source A** and **Source B** to select the desired channels (CH1, CH2, CH3 or CH4).
- Press **Offset** and use  to adjust the vertical offset of the operation result.
- Press **Scale** and use  to adjust the vertical scale of the operation results.
- Press **Scale Reset**, the instrument will adjust the vertical scale to the best value according to the current configuration automatically.
- Press **Options** to set the start point, end point or turn on or off the inverted display of the operation results.
Press **Start** to set the start point of the operation results.
Press **End** to set the end point of the operation results.
Press **Invert** to turn the inverted display of the operation results on or off.
Press **Auto Scale** to turn on or off the auto scale function. When "ON" is

selected, the instrument will adjust the vertical scale to the best value according to the current configuration automatically.

- **HORIZONTAL**  **POSITION** and **HORIZONTAL**  **SCALE** can also be used to adjust the horizontal position and scale of the operation results.

FFT

FFT is used to quickly perform Fourier transform on specified signals and transform time domain signals to frequency domain signals. FFT operation can facilitate the following works:

- Measure harmonic components and distortion in the system
- Measure the characteristics of the noise in DC power
- Analyze vibration

Press **MATH** → **Math** → **Operator** to select “FFT” and set the parameters of FFT operation.

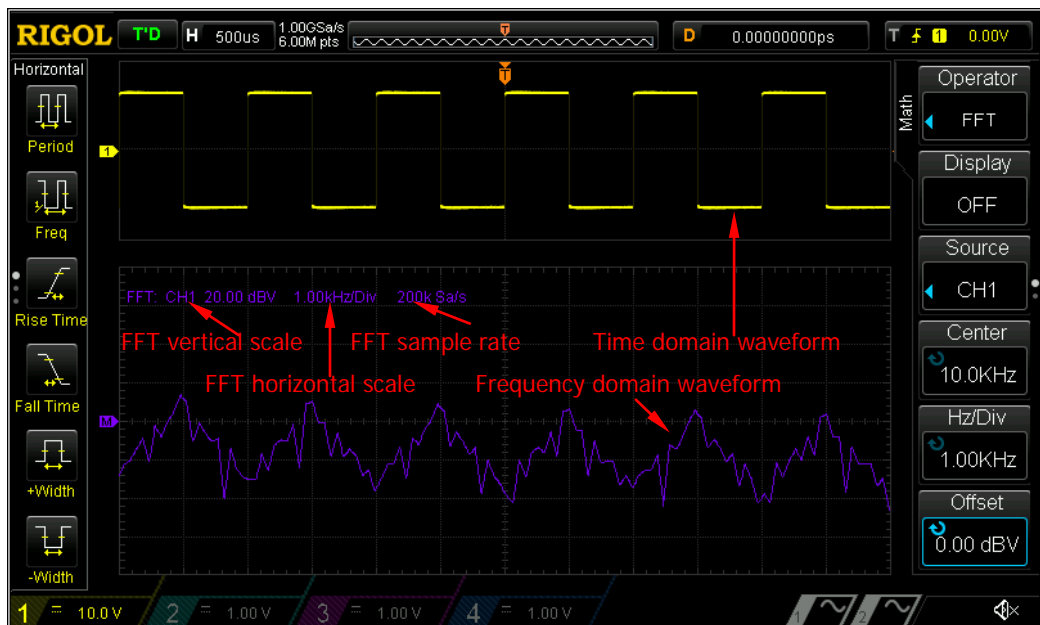

Figure 6-1 FFT Operation

1. Operation

Press **Display** to enable or disable the FFT operation function. When it is enabled, the time domain waveform and frequency domain waveform are displayed in separate areas on the screen by default, as shown in Figure 6-1. In the figure, the FFT sample rate equals the product of 100 divided by the current horizontal time base.

2. Select Source

Press **Source** to select the desired channel (CH1, CH2, CH3 or CH4).

3. Vertical Offset

Press **Offset** and use  to adjust the vertical offset of the operation result.

4. Vertical Scale

Press **Scale** and use  to adjust the vertical scale of the operation results.

5. Center Frequency

Press **Center** to adjust the frequency of frequency domain waveform relative to the horizontal center of screen.

6. Horizontal Scale

Press **Scale** and use  to adjust the horizontal scale of frequency domain waveform.

7. Select Window Function

Spectral leakage can be considerably decreased when a window function is used. DS1000Z provides six kinds of FFT window functions which have different characteristics and are applicable to measure different waveforms. You need to select the window function according to different waveforms and their characteristics. Press **Window** to select the desired window function and the default is "Rectangle".

Table 6-1 Window Functions

Window	Characteristics	Waveforms Suitable for Measurement
Rectangle	The best frequency resolution; the poorest amplitude resolution; similar to the situation when no window is multiplied.	Transient or short pulse, the signal levels before and after the multiplication are basically the same; Sine waveforms with the same amplitude and rather similar frequencies; Wide band random noise with relatively slowly changing waveform spectrum.
Hanning	Better frequency resolution; poorer amplitude resolution.	Sine, periodic and narrow band random noise.
Hamming	A little bit better frequency resolution than Hanning	Transient or short pulse, the signal levels before and after the multiplication are rather different.
Blackman	The best amplitude resolution; the poorest frequency resolution	Single frequency signal, search for higher order harmonics.
Flattop	Measure signal precisely.	The signal that no accurate reference but require accurate measurements
Triangle	Better frequency resolution.	Narrowband signal with strong interference noise.

8. Set the view Mode

Press **View** to select "Half" (default) or "Full" display mode.

Half: the source channel and the FFT operation results are displayed separately.

The time domain and frequency domain signals are displayed clearly.

Full Screen: the source channel and the FFT operation results are displayed in the same window to view the frequency spectrum more clearly and to perform more precise measurement.

Note: In FFT mode and when MATH is the active channel, you can also press **HORIZONTAL**  **SCALE** to switch between "Half" and "Full".

9. Set the Vertical Scale

The unit of the vertical axis can be dB/dBm or Vrms which use logarithmic mode and linear mode to display vertical amplitude respectively. If you need to display the FFT frequency spectrum in a relatively larger dynamic range, dB/dBm is recommended. Press **Unit** to select the desired unit and the default is Vrms.

10. Press **Scale Reset**, the instrument will adjust the vertical scale to the best value according to the current configuration automatically.

Tips

- You can use **HORIZONTAL  SCALE** to adjust the center frequency and horizontal scale at the same time.
- Signals with DC components or deviation would cause error or deviation of the FFT waveform components. To reduce the DC components, set the **"Channel Coupling"** to "AC".
- To reduce the random noise and aliasing frequency components of repetitive or single pulse, set the **"Acquisition Mode"** of the oscilloscope to "Average".

"AND" Operation





Perform logic operation on specified sources waveform point by point and display the results. In operation, when the voltage value of the source channel is greater than the threshold of the corresponding channel, it is regarded as logic "1"; otherwise logic "0".

The results of logic **"AND"** operation of two binary bits are as shown in the table below.

Table 6-2 Logic "AND" Operation

A	B	A&&B
0	0	0
0	1	0
1	0	0
1	1	1

Press **MATH** → **Math** → **Operator** to select "A&&B":

- Press **Display** to turn on or off the AND operation function.
- Press **Source A** and **Source B** to select the desired channels (CH1, CH2, CH3 or CH4).
- Press **Offset** and use  to adjust the vertical offset of the operation result.
- Press **Scale** and use  to adjust the vertical scale of the operation results.
- Press **Scale Reset**, the instrument will adjust the vertical scale to the best value according to the current configuration automatically.
- Press **Tre.A** and use  to set the threshold of source A in logic operation.
- Press **Tre.B** and use  to set the threshold of source B in logic operation.
- Press **Options** to set the start point, end point or turn on or off the inverted display of the operation results.



Press **Start** to set the start point of the operation results.

Press **End** to set the end point of the operation results.

Press **Invert** to turn the inverted display of the operation results on or off.

Press **Sens.** to set the sensitivity of the digital signal converted from the analog signal on the signal source and the range available is 0 div to 0.96 div.

Press **Auto Scale** to turn on or off the auto scale function. When "ON" is selected, the instrument will adjust the vertical scale to the best value according to the current configuration automatically.

- **HORIZONTAL**  **POSITION** and **HORIZONTAL**  **SCALE** can also be used to adjust the horizontal position and scale of the operation results.

“OR” Operation





Perform logic operation on specified sources waveform point by point and display the results. In operation, when the voltage value of the source channel is greater than the threshold of the corresponding channel, it is regarded as logic “1”; otherwise logic “0”.

The results of logic “OR” operation of two binary bits are as shown in the table below.

Table 6-3 Logic “OR” Operation

A	B	A B
0	0	0
0	1	1
1	0	1
1	1	1

Press **MATH** → **Math** → **Operator** to select “A||B”:

- Press **Display** to turn on or off the OR operation function.
- Press **Source A** and **Source B** to select the desired channels (CH1, CH2, CH3 or CH4).
- Press **Offset** and use  to adjust the vertical offset of the operation result.
- Press **Scale** and use  to adjust the vertical scale of the operation results.
- Press **Scale Reset**, the instrument will adjust the vertical scale to the best value according to the current configuration automatically.
- Press **Tre.A** and use  to set the threshold of source A in logic operation.
- Press **Tre.B** and use  to set the threshold of source B in logic operation.
- Press **Options** to set the start point, end point or turn on or off the inverted display of the operation results.

Press **Start** to set the start point of the operation results.

Press **End** to set the end point of the operation results.

Press **Invert** to turn the inverted display of the operation results on or off.

Press **Sens.** to set the sensitivity of the digital signal converted from the analog signal on the signal source and the range available is 0 div to 0.96 div.

Press **Auto Scale** to turn on or off the auto scale function. When “ON” is selected, the instrument will adjust the vertical scale to the best value according to the current configuration automatically.

- **HORIZONTAL**  **POSITION** and **HORIZONTAL**  **SCALE** can also be

used to adjust the horizontal position and scale of the operation results.

“XOR” Operation





Perform logic operation on specified sources waveform point by point and display the results. In operation, when the voltage value of the source channel is greater than the threshold of the corresponding channel, it is regarded as logic “1”; otherwise logic “0”.

The results of logic “XOR” operation of two binary bits are as shown in the table below.

Table 6-4 Logic “XOR” Operation

A	B	A^B
0	0	0
0	1	1
1	0	1
1	1	0

Press **MATH** → **Math** → **Operator** to select “A^B”:

- Press **Display** to turn on or off the XOR operation function.
- Press **Source A** and **Source B** to select the desired channels (CH1, CH2, CH3 or CH4).
- Press **Offset** and use  to adjust the vertical offset of the operation result.
- Press **Scale** and use  to adjust the vertical scale of the operation results.
- Press **Scale Reset**, the instrument will adjust the vertical scale to the best value according to the current configuration automatically.
- Press **Tre.A** and use  to set the threshold of source A in logic operation.
- Press **Tre.B** and use  to set the threshold of source B in logic operation.
- Press **Options** to set the start point, end point or turn on or off the inverted display of the operation results.

Press **Start** to set the start point of the operation results.



Press **End** to set the end point of the operation results.

Press **Invert** to turn the inverted display of the operation results on or off.

Press **Sens.** to set the sensitivity of the digital signal converted from the analog signal on the signal source and the range available is 0 div to 0.96 div.

Press **Auto Scale** to turn on or off the auto scale function. When “ON” is selected, the instrument will adjust the vertical scale to the best value according

to the current configuration automatically.

- **HORIZONTAL**  **POSITION** and **HORIZONTAL**  **SCALE** can also be used to adjust the horizontal position and scale of the operation results.

“NOT” Operation



Perform logic operation on specified sources waveform point by point and display the results. In operation, when the voltage value of the source channel is greater than the threshold of the corresponding channel, it is regarded as logic “1”; otherwise logic “0”.

The results of logic **NOT** operation of a binary bit are as shown in the table below.

Table 6-5 Logic “NOT” Operation

A	!A
0	1
1	0

Press **MATH** → **Math** → **Operator** to select “!A”:

- Press **Display** to turn on or off the NOT operation function.
- Press **Source A** and **Source B** to select the desired channels (CH1, CH2, CH3 or CH4).
- Press **Offset** and use  to adjust the vertical offset of the operation result.
- Press **Scale** and use  to adjust the vertical scale of the operation results.
- Press **Scale Reset**, the instrument will adjust the vertical scale to the best value according to the current configuration automatically.
- Press **Tre.A** and use  to set the threshold of source A in logic operation.
- Press **Options** to set the start point, end point or turn on or off the inverted display of the operation results.

Press **Start** to set the start point of the operation results.

Press **End** to set the end point of the operation results.

Press **Invert** to turn the inverted display of the operation results on or off.

Press **Sens.** to set the sensitivity of the digital signal converted from the analog signal on the signal source and the range available is 0 div to 0.96 div.

Press **Auto Scale** to turn on or off the auto scale function. When “ON” is selected, the instrument will adjust the vertical scale to the best value according to the current configuration automatically.



- **HORIZONTAL**  **POSITION** and **HORIZONTAL**  **SCALE** can also be

used to adjust the horizontal position and scale of the operation results.

Integrate

Calculate the integral of the specified signal source. For example, you can use integrate to calculate the energy of a pulse or measure the area under a waveform.

Press **MATH** → **Math** → **Operator** to select "Intg":



- Press **Display** to turn on or off the integral operation function.
- Press **Source** to select the desired channels (CH1, CH2, CH3 or CH4).
- Press **Offset** and use  to adjust the vertical offset of the operation result.
- Press **Scale** and use  to adjust the vertical scale of the operation results.
- Press **Scale Reset**, the instrument will adjust the vertical scale to the best value according to the current configuration automatically.
- Press **Options** to set the start point, end point or turn on or off the inverted display of the operation results.

Press **Start** to set the start point of the operation results.

Press **End** to set the end point of the operation results.

Press **Invert** to turn the inverted display of the operation results on or off.



Press **Auto Scale** to turn on or off the auto scale function. When "ON" is selected, the instrument will adjust the vertical scale to the best value according to the current configuration automatically.



- **HORIZONTAL**  **POSITION** and **HORIZONTAL**  **SCALE** can also be used to adjust the horizontal position and scale of the operation results.

Differentiate

Calculate the derivative of the specified signal source. For example, you can use differentiate to calculate the instantaneous slope of a waveform.

Press **MATH** → **Math** → **Operator** to select "Diff":

- Press **Display** to turn on or off the derivative operation function.
- Press **Source** to select the desired channels (CH1, CH2, CH3 or CH4).
- Press **Offset** and use  to adjust the vertical offset of the operation result.
- Press **Scale** and use  to adjust the vertical scale of the operation results.
- Press **Scale Reset**, the instrument will adjust the vertical scale to the best value according to the current configuration automatically.

- Press **Options** to set the start point, end point or turn on or off the inverted display of the operation results.
Press **Start** to set the start point of the operation results.
Press **End** to set the end point of the operation results.
Press **Invert** to turn the inverted display of the operation results on or off.
Press **Smooth** to set the width of the smooth window of the differentiate operation. The range is from 3 to 201. The smooth window is a rectangular window used to add smooth processing to the differentiate operation.
Press **Auto Scale** to turn on or off the auto scale function. When "ON" is selected, the instrument will adjust the vertical scale to the best value according to the current configuration automatically.
- **HORIZONTAL**  **POSITION** and **HORIZONTAL**  **SCALE** can also be used to adjust the horizontal position and scale of the operation results.



Tip

Because differentiation is very sensitive to noise, so you can set the "**Acquisition Mode**" to "Average".



Square Root

Calculate the square root of specified signal source point by point and display the results.

Press **MATH** → **Math** → **Operator** to select "Sqrt":

- Press **Display** to turn on or off the square root operation function.
- Press **Source** to select the desired channels (CH1, CH2, CH3 or CH4).
- Press **Offset** and use  to adjust the vertical offset of the operation result.
- Press **Scale** and use  to adjust the vertical scale of the operation results.
- Press **Scale Reset**, the instrument will adjust the vertical scale to the best value according to the current configuration automatically.
- Press **Options** to set the start point, end point or turn on or off the inverted display of the operation results.
Press **Start** to set the start point of the operation results.
Press **End** to set the end point of the operation results.
Press **Invert** to turn the inverted display of the operation results on or off.
Press **Auto Scale** to turn on or off the auto scale function. When "ON" is



selected, the instrument will adjust the vertical scale to the best value according to the current configuration automatically.

- **HORIZONTAL**  **POSITION** and **HORIZONTAL**  **SCALE** can also be used to adjust the horizontal position and scale of the operation results.

Base 10 Logarithm

Calculate the base 10 logarithm of specified signal source point by point and display the results.

Press **MATH** → **Math** → **Operator** to select “Lg”:



- Press **Display** to turn on or off the base 10 logarithm operation function.
- Press **Source** to select the desired channels (CH1, CH2, CH3 or CH4).
- Press **Offset** and use  to adjust the vertical offset of the operation result.
- Press **Scale** and use  to adjust the vertical scale of the operation results.
- Press **Scale Reset**, the instrument will adjust the vertical scale to the best value according to the current configuration automatically.
- Press **Options** to set the start point, end point or turn on or off the inverted display of the operation results.

Press **Start** to set the start point of the operation results.

Press **End** to set the end point of the operation results.

Press **Invert** to turn the inverted display of the operation results on or off.





Press **Auto Scale** to turn on or off the auto scale function. When “ON” is selected, the instrument will adjust the vertical scale to the best value according to the current configuration automatically.

- **HORIZONTAL**  **POSITION** and **HORIZONTAL**  **SCALE** can also be used to adjust the horizontal position and scale of the operation results.

Natural Logarithm

Calculate the natural logarithm of specified signal source point by point and display the results.



Press **MATH** → **Math** → **Operator** to select “Ln”:

- Press **Display** to turn on or off the natural logarithm operation function.
- Press **Source** to select the desired channels (CH1, CH2, CH3 or CH4).
- Press **Offset** and use  to adjust the vertical offset of the operation result.
- Press **Scale** and use  to adjust the vertical scale of the operation results.
- Press **Scale Reset**, the instrument will adjust the vertical scale to the best value according to the current configuration automatically.
- Press **Options** to set the start point, end point or turn on or off the inverted display of the operation results.
Press **Start** to set the start point of the operation results.
Press **End** to set the end point of the operation results.
Press **Invert** to turn the inverted display of the operation results on or off.
Press **Auto Scale** to turn on or off the auto scale function. When "ON" is selected, the instrument will adjust the vertical scale to the best value according to the current configuration automatically.
- **HORIZONTAL**  **POSITION** and **HORIZONTAL**  **SCALE** can also be used to adjust the horizontal position and scale of the operation results.



Exponential

Calculate the exponential of specified signal source point by point and display the results.

Press **MATH** → **Math** → **Operator** to select "Exp":

- Press **Display** to turn on or off the exponential operation function.
- Press **Source** to select the desired channels (CH1, CH2, CH3 or CH4).
- Press **Offset** and use  to adjust the vertical offset of the operation result.
- Press **Scale** and use  to adjust the vertical scale of the operation results.
- Press **Scale Reset**, the instrument will adjust the vertical scale to the best value according to the current configuration automatically.
- Press **Options** to set the start point, end point or turn on or off the inverted display of the operation results.
Press **Start** to set the start point of the operation results.
Press **End** to set the end point of the operation results.
Press **Invert** to turn the inverted display of the operation results on or off.
Press **Auto Scale** to turn on or off the auto scale function. When "ON" is selected, the instrument will adjust the vertical scale to the best value according



to the current configuration automatically.

- **HORIZONTAL**  **POSITION** and **HORIZONTAL**  **SCALE** can also be used to adjust the horizontal position and scale of the operation results.

Absolute Value

Calculate the absolute value of specified signal source point by point and display the results.

Press **MATH** → **Math** → **Operator** to select “Abs”:



- Press **Display** to turn on or off the absolute value operation function.
- Press **Source** to select the desired channels (CH1, CH2, CH3 or CH4).
- Press **Offset** and use  to adjust the vertical offset of the operation result.
- Press **Scale** and use  to adjust the vertical scale of the operation results.
- Press **Scale Reset**, the instrument will adjust the vertical scale to the best value according to the current configuration automatically.
- Press **Options** to set the start point, end point or turn on or off the inverted display of the operation results.

Press **Start** to set the start point of the operation results.

Press **End** to set the end point of the operation results.

Press **Invert** to turn the inverted display of the operation results on or off.

Press **Auto Scale** to turn on or off the auto scale function. When “ON” is selected, the instrument will adjust the vertical scale to the best value according to the current configuration automatically.

- **HORIZONTAL**  **POSITION** and **HORIZONTAL**  **SCALE** can also be used to adjust the horizontal position and scale of the operation results.

Auto Measurement

DS1000Z provides auto measurements of 32 waveform parameters and the statistics and analysis of the measurement results. What's more, you can also use the frequency counter to realize more precise frequency measurement.

Quick Measurement after **AUTO**

When the oscilloscope is correctly connected and has detected input signal, press **Auto** to enable waveform auto setting function and open the following function menu:

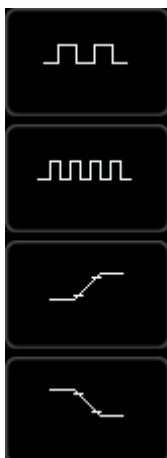

Figure 6-2 Quick Measurement Menu after AUTO

Single-period: measure the "Period" and "Frequency" of the current signal within a single period and display the measurement results at the bottom of the screen.

Multi-period: measure the "Period" and "Frequency" of the current signal within multiple periods and display the measurement results at the bottom of the screen.

Rise Time: measure the "Rise Time" of the current signal and display the measurement result at the bottom of the screen.

Fall Time: measure the "Fall Time" of the current signal and display the measurement result at the bottom of the screen.

Note: The **AUTO** function requires that the frequency of the signal under test should be no lower than 50 Hz, the duty cycle be greater than 1% and the amplitude be at least 20 mVpp. If the parameters of the signal under test exceed these limits, after this softkey is pressed, the quick parameter measurement items might not be displayed in the pop-up menu.

One-key Measurement of 32 Parameters

Press corresponding softkey under the **MENU** at the left of the screen to quickly measure the 32 parameters and realize “One-key” measurement. The measurement result will be displayed at the bottom of the screen.

The icons of time and voltage parameters in the measurement items and the measurement results on the screen are always marked in the same color with the channel (**Measure** → **Source**) currently used.

Note: If the measurement result is displayed as “*****”, it means that there is no signal input in the current source or the measurement result is not within the valid range (too large or too small).

Time Parameters

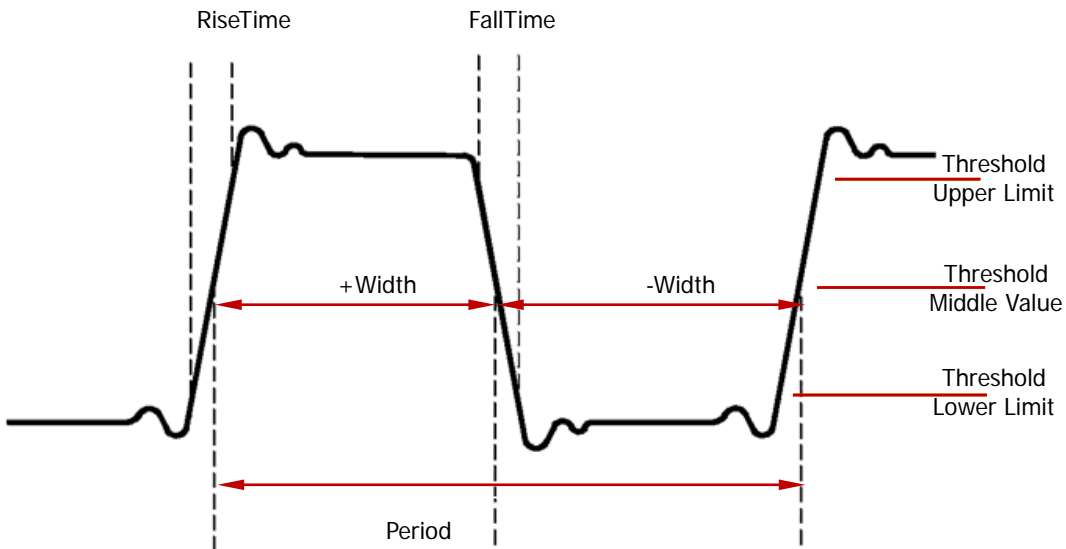

Explanation: Please refer to the explanations in “**Measurement Setting**” to set the threshold upper limit, threshold middle value and threshold lower limit and the default values are 90%, 50% and 10% respectively.

1. **Period:** defined as the time between the threshold middle values of two consecutive, like-polarity edges.
2. **Frequency:** defined as the reciprocal of period.
3. **Rise Time:** the time for the signal amplitude to rise from the threshold lower limit to the threshold upper limit.
4. **Fall Time:** the time for the signal amplitude to fall from the threshold upper limit to the threshold lower limit.
5. **+ Width:** the time difference between the threshold middle value of a rising edge to the threshold middle value of the next falling edge of the pulse.
6. **- Width:** the time difference between the threshold middle value of a falling edge to the threshold middle value of the next rising edge of the pulse.
7. **+ Duty:** the ratio of the positive pulse width to the period.
8. **- Duty:** the ratio of the negative pulse width to the period.
9. **tVmax:** the time value corresponding to the waveform maximum value (V_{max}).
10. **tVmin:** the time value corresponding to the waveform minimum value (V_{min}).

Delay and Phase

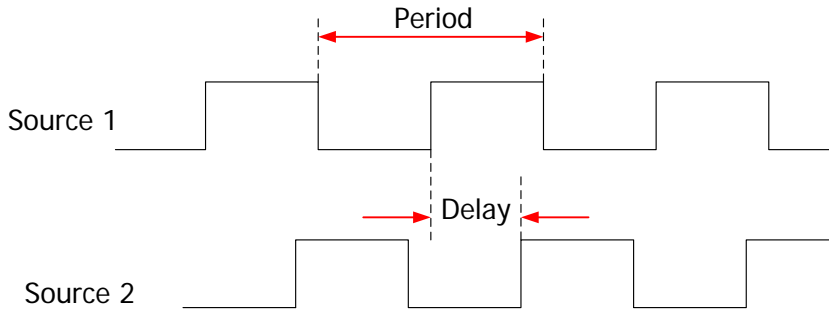

Source 1 and source 2 can be any of CH1 to CH4. For the setting method, please refer to the explanations in “**Measurement Setting**”.

1. **Delay 1→2 \uparrow** : the time difference between the rising edges of source 1 and source 2. Negative delay indicates that the selected rising edge of source 1 occurred after the selected edge of source 2.
2. **Delay 1→2 \downarrow** : the time difference between the falling edges of source 1 and source 2. Negative delay indicates that the selected edge of source 1 occurred after the selected edge of source 2.
3. **Phase 1→2 \uparrow** : phase difference calculated according to “Delay 1→2 \uparrow ” and the period of source 1, expressed in degree. The calculation formula is as follows.
4. **Phase 1→2 \downarrow** : phase difference calculated according to “Delay 1→2 \downarrow ” and the period of source 1, expressed in degree. The calculation formula is as follows.

The calculation formula of the phase is:

$$Phase = \frac{Delay}{Period1} \times 360^\circ$$

Wherein,

Phase denotes “Phase 1→2 \uparrow ” or “Phase 1→2 \downarrow ”

Delay denotes “Delay 1→2 \uparrow ” or “Delay 1→2 \downarrow ”

Period1 denotes the period of source 1

Voltage Parameters

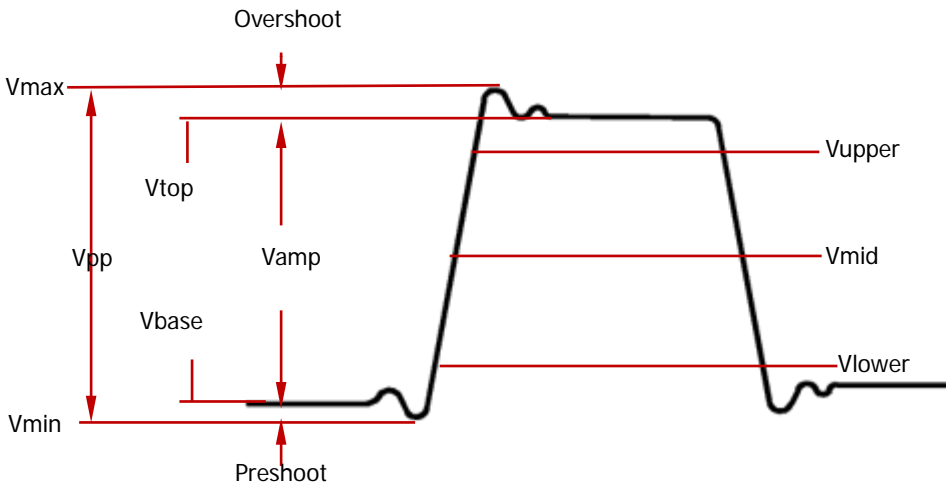

1. **Vmax**: the voltage value from the highest point of the waveform to the GND.
2. **Vmin**: the voltage value from the lowest point of the waveform to the GND.
3. **Vpp**: the voltage value from the highest point to the lowest point of the waveform.
4. **Vtop**: the voltage value from the flat top of the waveform to the GND.
5. **Vbase**: the voltage value from the flat base of the waveform to the GND.
6. **Vamp**: the voltage value from the top of the waveform to the base of the waveform.
7. **Vupper**: 90% of the waveform amplitude.
8. **Vmid**: 50% of the waveform amplitude.
9. **Vlower**: 10% of the waveform amplitude.
10. **Vavg**: the arithmetic average value on the whole waveform or on the gating area.

$$Average = \frac{\sum x_i}{n}$$

Wherein, x_i is the i_{th} point being measured, n is the number of points being measured.

11. **Vrms**: the effective value on the whole waveform or the gating area.

$$RMS = \sqrt{\frac{\sum_{i=1}^n x_i^2}{n}}$$





Wherein, x_i is the i th point being measured, n is the number of points being measured.

- 12. Overshoot:** the ratio of the difference of the maximum value and top value of the waveform to the amplitude value.
- 13. Preshoot:** the ratio of the difference of the minimum value and base value of the waveform to the amplitude value.
- 14. Variance:** the average of the sum of the squares of the differences between the amplitude of all the points on the whole waveform or the gating area and the waveform average. This value reflects the volatility of the waveform.

$$Variance = \frac{\sum_{i=1}^n (Vamp(i) - Average)^2}{n}$$

Wherein, $Vamp(i)$ is the amplitude of the i th point, $Average$ is the waveform average, n is the number of points being measured.

Other Parameters

-  **+ Rate:** the product of the difference between the upper value and lower value divided by the corresponding time on the rising edge.
-  **- Rate:** the product of the difference between the lower value and upper value divided by the corresponding time on the falling edge.
-  **Area:** the area of the whole waveform within the screen and the unit is voltage-second. The area measured above the zero reference (namely the vertical offset) is positive and the area measured below the zero reference is negative. The area measured is the algebraic sum of the area of the whole waveform within the screen.
-  **Period Area:** the area of the first period of waveform on the screen and the unit is voltage-second. The area above the zero reference (namely the vertical offset) is positive and the area below the zero reference is negative. The area measured is the algebraic sum of the area of the whole period waveform. Note that when the waveform on the screen is less than a period, the period area measured is 0.

Frequency Counter Measurement

The hardware frequency counter supplied with this oscilloscope can make more precise measurement of the input signal frequency.

Press **Measure** → **Counter** to select CH1-CH4 as the measurement source. The measurement result is displayed at the upper right corner of the screen and you can identify the current measurement source according to the color of the icon. The following figure is the result of frequency measurement of the input signal of CH1.



Select "OFF" to disable the frequency counter measurement function.

Measurement Setting

1. Source Selection

Press **Measure** → **Source** to select the desired channel for measurement (CH1-CH4). The color of the parameter icons under **MENU** at the left of the screen will change with the source selected.

2. Delayed Measurement Setting

Specify the source 1 and source 2 in the measurement items “**Delay 1→2f**” and “**Delay 1→2t**”.

Press **Measure** → **Setting** → **Type** → “Delay” and then press **SourceA** and **SourceB** to set the two channel sources (CH1-CH4) of delayed measurement respectively.

3. Phase Measurement Setting



Specify the source 1 and source 2 in the measurement items “**Phase 1→2f**” and “**Phase 1→2t**”.

Press **Measure** → **Setting** → **Type** → “Phase” and then press **SourceA** and **SourceB** to set the two channel sources (CH1-CH4) of phase measurement respectively.

4. Threshold Measurement Setting

Specify the vertical level (in percentage) being measured in the analog channel. Measurements of all the time, delay and phase parameters will be influenced by this setting.

Press **Measure** → **Setting** → **Type** → “Threshold” and then:

- Press **Max** and use  to set the maximum value of the measurement. Reducing the maximum value to the current “Mid” will automatically reduce the “Mid” to keep it lower than the maximum value. The default is 90% and the range available is from 7% to 95%.
- Press **Mid** and use  to set the middle value of measurement. The middle value is limited by the settings of “Max” and “Min”. The default is 50% and the range available is from 6% to 94%.
- Press **Min** and use  to set the minimum value of the measurement. Increasing the minimum value to the current “Mid” will automatically increase the “Mid” to keep it higher than the minimum value. The default is 10% and the range available is from 5% to 93%.

To Clear the Measurement

If you have currently enabled one or more items in the 32 measurement parameters, you can “Delete” or “Recover” the last five parameters enabled.

Note that the last five parameters are determined according to the order in which you turned them on and they will not change as you delete one or more measurement items.

Press **Measure** → **Clear** → **Item n** (n=1 to 5) to “Delete” or “Recover” the specified measurement item. When one measurement item is deleted or recovered, the measurement result at the bottom of the screen will move one-item left or right.

Press **Measure** → **Clear** → **All Items** to “Delete” or “Recover” all the 5 measurement items enabled last.

All Measurement

All measurement could measure all the time and voltage parameters (each measurement source has 20 items, measurements can be performed on CH1, CH2, CH3 and CH4 at the same time) of the current measurement source and display the results on the screen. Press **Measure** → **Measure All** to enable or disable the all measurement function. Press **All Measure Source** and use ↻ to select the channel(s) to be measured (CH1-CH4).

- When all measurement is enabled, “One-key” measurement is also valid.
- “To Clear the Measurement” will not clear the results of all measurement.

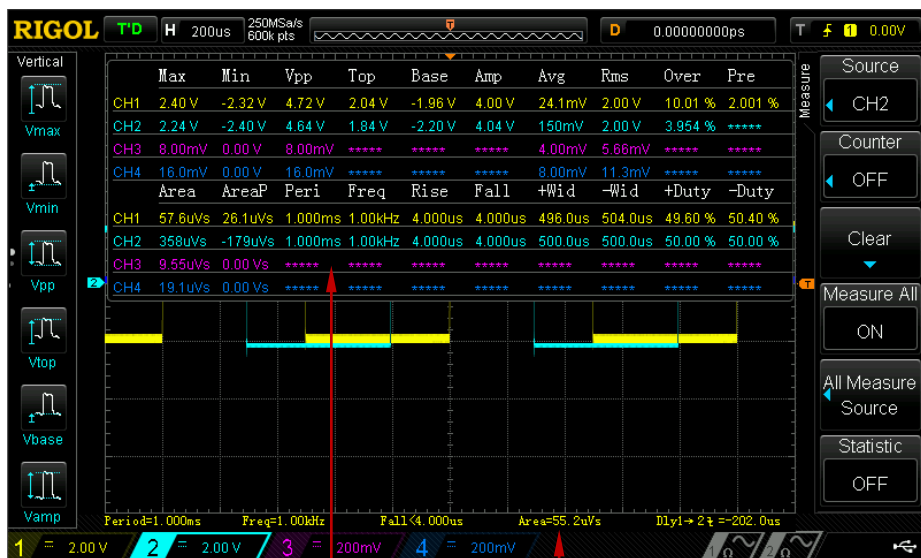

All Measurement One-key
Measurement
Figure 6-3 All Measurement

Statistic Function

Make statistic and display the current, average, minimum (or standard deviation) and maximum (or count) values of at most 5 measurement items that are turned on last.

Press **Measure** → **Statistic** to turn the statistic function on or off. When the statistic function is enabled, press **Stat.Sel** to select “Extremum” or “Difference” measurement. When “Extremum” is selected, minimum and maximum values are displayed. When “Difference” is selected, standard deviation and count values are displayed. Press **Reset Stat** to clear the history data and make statistic again.

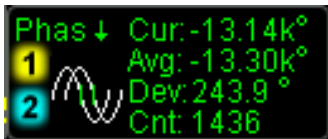

Extremum Measurement



Difference Measurement

Cursor Measurement

Cursors can be used to measure the X axis values (usually Time) and Y axis values (usually Voltage) on a selected waveform. Please connect the signal to the oscilloscope and obtain stable display before using cursor measurement. All the “**Auto Measurement**” parameters can be measured through cursor measurement.

Press **Cursor** → **Mode** at the front panel and use  to select the desired cursor mode (the default is “OFF”) and then press down the knob. The modes available are “Manual”, “Track” and “Auto”. You can also select the “XY” cursor measurement mode when the “**Time Base Mode**” is set to “XY”.

Manual Mode

In this mode, a pair of cursors will appear. You can adjust the cursors manually to measure the X (or Y), X increment (or Y increment) between cursors and the reciprocal of X increment on the waveform of the selected source (CH1 to CH4 or MATH).

Press **Cursor** → **Mode** → "Manual" to turn the manual cursor function on and the measurement results will be displayed at the upper left corner of the screen in the following mode.

```

AX:    = -400.0us
AY:    = 20.00 V
BX:    = 400.0us
BY:    = -20.00 V
BX-AX: = 800.0us
BY-AY: = -40.00 V
1/|dX|: = 1.250kHz

```

- AX: the X value at cursor A. The X value takes the trigger position as reference.
- AY: the Y value at cursor A. The Y value takes the channel GND as reference.
- BX: the X value at cursor B. The X value takes the trigger position as reference.
- BY: the Y value at cursor B. The Y value takes the channel GND as reference.
- BX-AX: the horizontal difference between cursor A and B.
- BY-AY: the vertical difference between cursor A and B.
- $1/|dX|$: the reciprocal of the horizontal difference between cursor A and B.

If needed, please refer to the following steps to modify the parameters of manual cursor measurement.

1. Select Cursor Type

Press **Select** to select "█████" or "█████".



- █████: the X cursors; a vertical dotted line (cursor A) and a vertical solid line (cursor B) and are usually used to measure time parameters.
- █████: the Y cursors; a horizontal dotted line (cursor A) and a horizontal solid line (cursor B) and are usually used to measure voltage parameters.

2. Select Measurement Source

Press **Source** to select the waveform of the analog channels (CH1-CH4) or math operation results (MATH) for measurement.

Note: Only channels currently turned on can be selected.

3. Adjust the Cursor Position (note that you can also press continuously to switch the current cursor)

- Adjust cursor A: press **CursorA** and use  to adjust the position of cursor A. During the adjustment, the measurement result will change accordingly. The adjustable range is limited within the screen.
- Adjust cursor B: press **CursorB** and use  to adjust the position of cursor B. During the adjustment, the measurement result will change accordingly. The adjustable range is limited within the screen.
- Adjust cursor A and B at the same time: press **CursorAB** and use  to adjust the position of cursor A and B at the same time. During the adjustment, the measurement results will change accordingly. The adjustable range is limited within the screen.

4. Select X (Y) Axis Unit

Press **Units** to set the horizontal unit and the vertical unit of the cursor measurement.

Press **Hori. Unit** to select "s", "Hz", "Degree" or "Percent".

- s: when this unit is selected, in the measurement results, AX, BX and BX-AX are in "s" and $1/|dX|$ is in "Hz".
- Hz: when this unit is selected, in the measurement results, AX, BX and BX-AX are in "Hz" and $1/|dX|$ is in "s".
- Degree: when this unit is selected, in the measurement results, AX, BX and BX-AX are in "°". At this point, AX, BX and BX-AX will change to "0°", "360°" and "360°" respectively when you press **Set Range**, no matter where cursor A and B are currently located. At the same time, two cursor lines (unmovable) appear on the screen as the reference positions.
- Percent: when this unit is selected, in the measurement results, AX, BX and BX-AX are in "%". At this point, AX, BX and BX-AX will change to "0%", "100%" and "100%" respectively when you press **Set Range**, no matter where cursor A and B are currently located. At the same time, two cursor lines (unmovable) appear on the screen as the reference positions.

Press **Vert. Unit** to select "Source" or "Percent".

- Source: when this unit is selected, in the measurement results, the units of AY, BY and BY-AY will be automatically set to the unit of the current source.
- Percent: when this unit is selected, in the measurement results, AY, BY and BY-AY are in "%". At this point, AY, BY and BY-AY will change to "0%", "100%" and "100%" when you press **Set Range**, no matter where cursor A and B are currently located. At the same time, two cursor lines (unmovable) appear on the screen as the reference positions.

5. Select Screen Region

- When ZOOM is turned on (press **HORIZONTAL SCALE**), CH1 is displayed in the MAIN/ZOOM areas. You can press **Region** to select "Main" or "Zoom". When measuring the main time base, the cursor value display window is displayed in the extended time base area; when measuring the extended time base, the cursor value display window is displayed in the main time base area.
- In the XY time base mode, the display window of the values of manual cursor measurement is displayed in the lower half of the screen.

6. Measurement Example

Use manual cursor measurement to measure the period (BX-AX) of a square waveform and the result is 1 ms equaling the result from auto measurement.

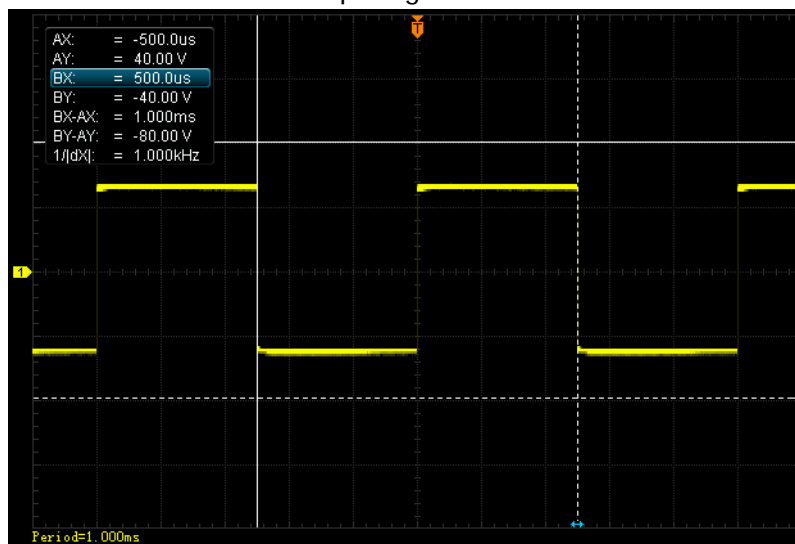



Figure 6-4 Manual Cursor Measurement Example

Track Mode

In this mode, one or two pairs of cursors will appear. You can adjust the two pairs of cursors (cursor A and cursor B) to measure the X and Y values on two different sources respectively. The points being measured on cursor A and B are marked by  and  respectively. When the cursors are moved horizontally, the marks will position on the waveform automatically. When the waveform is expanded or compressed horizontally, the marks will track the points being marked at the last adjustment of the cursors.

Press **Cursor** → **Mode** → "Track" to turn on the cursor track function and the measurement results will be displayed at the upper left corner of the screen in the following mode.

```

AX:    = 552.0us
AY:    = -4.800 V
BX:    = -88.00us
BY:    = -12.80 V
BX-AX: = -640.0us
BY-AY: = -8.000 V
1/|dX|: = 1.562kHz
  
```



- AX: the X value at cursor A. It takes the trigger position as reference and "s" or "Hz" (when measuring FFT waveform) as its unit.
- AY: the Y value at cursor A. It takes the channel GND as reference and use the same unit as the current source.
- BX: the X value at cursor B. It takes the trigger position as reference and "s" or "Hz" (when measuring FFT waveform) as its unit.
- BY: the Y value at cursor B. It takes the channel GND as reference and use the same unit as the current source.
- BX-AX: the horizontal difference between cursor A and B.
- BY-AY: the vertical difference between cursor A and B.
- $1/|dX|$: the reciprocal of the horizontal difference between cursor A and B.

If needed, please refer to the following steps to modify manual cursor track measurement parameters.

1. Select Measurement Source

Press **Cursor A** to select the waveform of analog channels (CH1-CH4) or math operation results (MATH) as the measurement source of cursor A (only channels enabled are available). You can also select "None", namely do not use cursor A. Press **Cursor B** to select the waveform of analog channels (CH1-CH4) or math operation results (MATH) as the measurement source of cursor B (only channels enabled are available). You can also select "None", namely do not use cursor B.

2. Adjust Cursor Position (note that you can also press continuously to switch the current cursor)

- Adjust cursor A: press **CursorA** and use  to adjust the position of cursor A. During the adjustment, the measurement result will change accordingly. The adjustable range is limited within the screen.
- Adjust cursor B: press **CursorB** and use  to adjust the position of cursor B. During the adjustment, the measurement result will change accordingly. The adjustable range is limited within the screen.
- Adjust cursor A and B at the same time: press **CursorAB** and use  to adjust the position of cursor A and B at the same time. During the adjustment, the measurement results will change accordingly. The adjustable range is limited within the screen.

Note: The vertical cursor will track the marked point (namely jumps up and down with the transient change of the waveform). Thus, the Y value might change even though you do not adjust the cursor.

Auto Mode

In this mode, one or more cursors will appear. You can use auto cursor measurement to measure any of the 32 waveform parameters. Before using this mode, you need to at least enable one auto measurement parameter and the number of cursors will change with the measurement parameter enabled.

Press **Cursor** → **Mode** → “Auto” and the number of cursors displayed on the screen is determined by the measurement parameter enabled (different measurement parameter needs different number of cursors). Note that no cursor will be displayed if no auto cursor measurement parameter is enabled or the measurement source has no input. When the waveform is expanded or compressed horizontally, the cursor will move accordingly.

If multiple measurement parameters are turned on later, you can use **Auto Item** to switch among at most five measurement parameters that are turned on last.

The following figure shows the auto measurement of the rise time of sine signal.

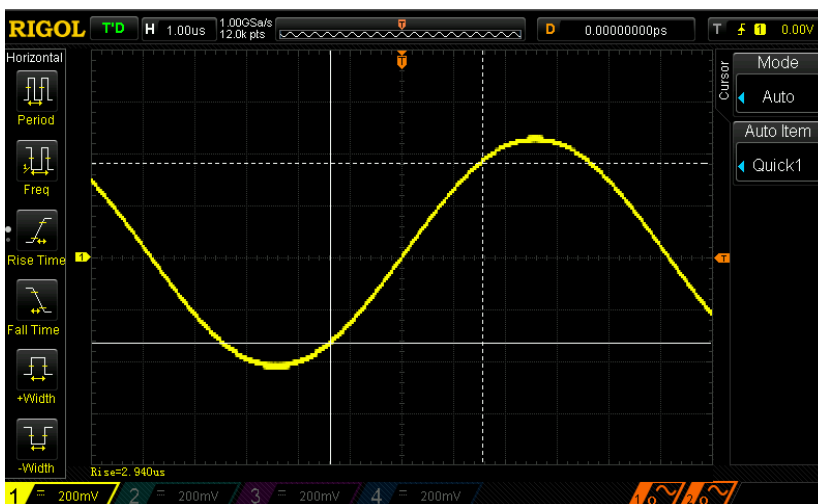

Figure 6-5 Auto Cursor Measurement Example

XY Cursor Measurement

This mode is only available in the XY horizontal time base mode. In this mode, two pairs of cursors are displayed. You can adjust the cursor positions and the instrument will calculate the chord length and ellipse curvature corresponding to the crossing points of the two pairs of cursor lines automatically.

Press **Cursor** → **Mode** → "XY" to turn on the XY mode cursor measurement function. The measurement results will be displayed at the upper-left corner of the screen, as shown in the figure below.

```

AX:      = 4.080 V
AY:      = 4.000 V
BX:      = -4.000 V
BY:      = -4.000 V
BX-AX:   = -8.080 V
BY-AY:   = -8.000 V
dX*dY:   = 64.64
dX/dY:   = 1.010
dY/dX:   = 990.1m
absAA:   = 5.714
absAB:   = 5.714
absBA:   = 5.657
absBB:   = 5.657
argAA:   = 44.43 °
argAB:   = -44.43 °
argBA:   = 135.0 °
argBB:   = -135.0 °

```

- AX: the X value of cursor XA.
- AY: the Y value of cursor YA.
- BX: the X value of cursor XB.
- BY: the Y value of cursor YB.
- BX-AX: the horizontal difference between cursor XB and cursor XA.
- BY-AY: the vertical difference between cursor YB and cursor YA.
- dX*dY: the product of the horizontal difference between cursor XB and cursor XA times the vertical difference between cursor YB and cursor YA.
- dX/dY: the product of the horizontal difference between cursor XB and cursor XA divided by the vertical difference between cursor YB and cursor YA.
- absAA: the chord length of the crossing point of cursor XA and cursor YA relative to the center point. The center point is defined as the crossing point of the the horizontal position (namely the V axis) and vertical position (namely the Y axis) of the two channel labels on the screen.
- absAB: the chord length of the crossing point of cursor XA and cursor YB relative to the center point. The center point is defined as the crossing point of the the horizontal position (namely the V axis) and vertical position (namely the Y axis) of the two channel labels on the screen.
- absBA: the chord length of the crossing point of cursor XB and cursor YA relative to the center point. The center point is defined as the crossing point of the the horizontal position (namely the V axis) and vertical position (namely the Y axis) of the two channel labels on the screen.

of the two channel labels on the screen.

- **absBB**: the chord length of the crossing point of cursor XB and cursor YB relative to the center point. The center point is defined as the crossing point of the the horizontal position (namely the V axis) and vertical position (namely the Y axis) of the two channel labels on the screen.
- **argAA**: the angle between the X axis and chord AA (the distance from the crossing point of cursor XA and cursor YA to the center point). The range is from -180° to $+180^\circ$. The value is positive in the counterclockwise direction and negative in the clockwise direction.
- **argAB**: the angle between the X axis and chord AB (the distance from the crossing point of cursor XA and cursor YB to the center point). The range is from -180° to $+180^\circ$. The value is positive in the counterclockwise direction and negative in the clockwise direction.
- **argBA**: the angle between the X axis and chord BA (the distance from the crossing point of cursor XB and cursor YA to the center point). The range is from -180° to $+180^\circ$. The value is positive in the counterclockwise direction and negative in the clockwise direction.
- **argBB**: the angle between the X axis and chord BB (the distance from the crossing point of cursor XB and cursor YB to the center point). The range is from -180° to $+180^\circ$. The value is positive in the counterclockwise direction and negative in the clockwise direction.

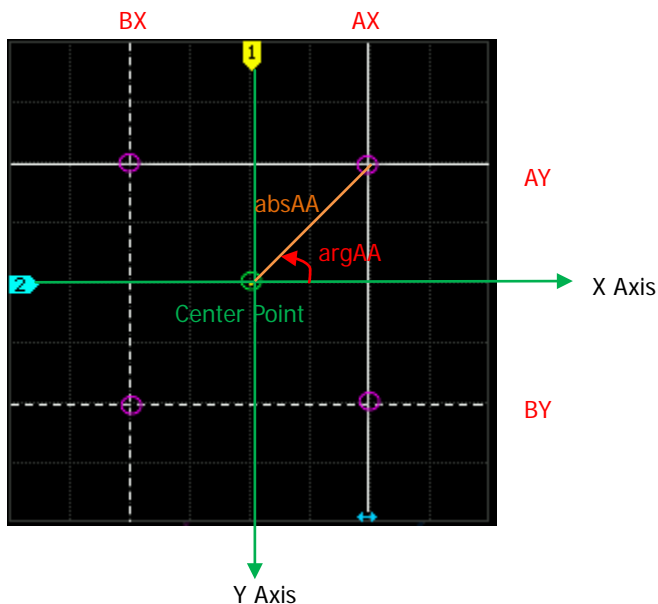



Figure 6-6 Definitions of the XY Cursor Measurement Results







1. Select the item

Press **Values** and use  to turn on or off the value to be measured. The measurement item turned on will be displayed at the upper-left corner of the screen.



- Turn on the BX-AX and BY-AY measurement items.
- Turn on the $dX*dY$ measurement item.
- Turn on the dX/dY measurement item.
- Turn on the dY/dX measurement item.
- Turn on the absAA and argAA measurement items at the same time.
- Turn on the absAB and argAB measurement items at the same time.
- Turn on the absBA and argBA measurement items at the same time.
- Turn on the absBB and argBB measurement items at the same time.

2. Adjust the cursor positions (Note: you can also press continuously to switch the current cursor)

- Adjust cursor AX: press **AX** and use  to adjust the position of cursor AX.
- Adjust cursor BX: press **BX** and use  to adjust the position of cursor BX.
- Adjust cursor AY: press **AY** and use  to adjust the position of cursor AY.
- Adjust cursor BY: press **BY** and use  to adjust the position of cursor BY.
- Adjust cursors AX and BX: press **ABX** and use  to adjust the positions of cursors AX and BX at the same time.
- Adjust cursors AY and BY: press **ABY** and use  to adjust the positions of cursors AY and BY at the same time.

The measurement results change accordingly during the adjustment process and the adjustable range is limited within the screen range.

3. Display the Lissajous schematic diagrams

The oscilloscope provides the Lissajous schematic diagrams under different frequencies and different phase deviations.

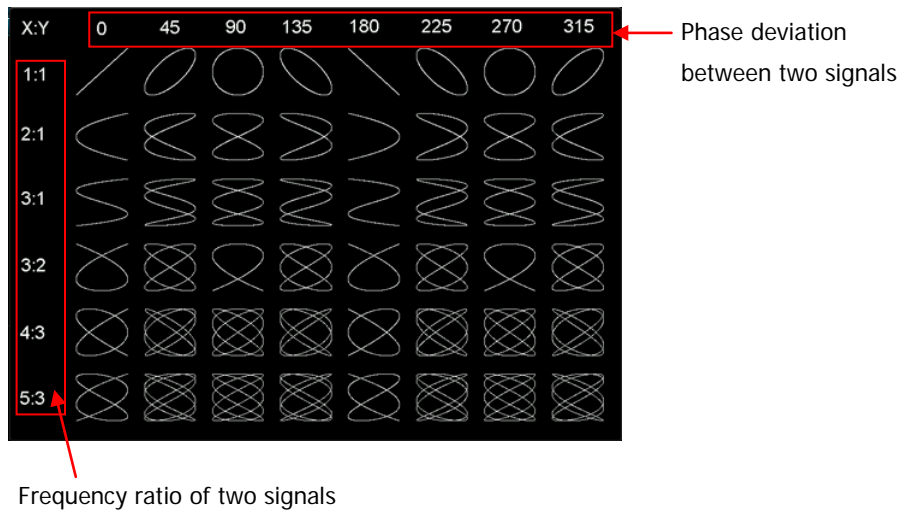

Figure 6-7 Lissajous Schematic Diagrams

Chapter 7 Protocol Decoding

DS1000Z provides two buses to make common protocol decoding (including Parallel (standard), RS232 (option), I2C (option) and SPI (option)) of the analog channels (CH1-CH4). As the decoding functions and setting methods of the two buses are the same, this chapter only takes Decode1 for illustration.

To get the decoding option information, please refer to “**Appendix A: Accessories and Options**”. When you have ordered the decoding option, please refer to “**Option Management**” to activate corresponding option.

The contents of this chapter:

- Parallel Decoding
- RS232 Decoding (Option)
- I2C Decoding (Option)
- SPI Decoding (Option)

Parallel Decoding

Parallel bus consists of clock line and data line. As shown in the figure below, CLK is the clock line, while Bit0 and Bit1 are the 0 bit and 1st bit on the data line respectively. The oscilloscope will sample the channel data on the rising edge, falling edge or the rising&falling edges of the clock and judge each data point (logic "1" or logic "0") according to the preset threshold level.

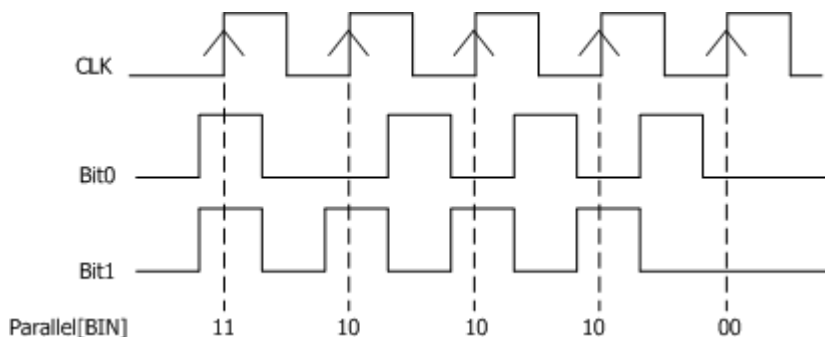

Figure 7-1 Parallel Decoding Schematic Diagram

Press **MATH** → **Decode1** → **Decoder** to select "Parallel" and open the parallel decoding function menu.

1. Press **Decode** to turn on or off the decoding function.
2. **Clock Line Setting (CLK)**
 Press **CLK** to select any channel (CH1-CH4) as the clock channel. If "OFF" is selected, no clock channel is set.
 Press **Edge** to set the oscilloscope to sample the channel data on the rising edge, falling edge or any of the edges. If no clock channel is selected, the instrument will sample when the channel data jumps in the decoding.
3. **Data Line Setting**
 - **Set the bus bits**
 Press **Width** to set the data width of the parallel bus namely the number of bits per frame. The default is 8 and the maximum is 16 bits (Bit0, Bit1...Bit15).

- **Specify data channel for each bit.**

First, press **Bit X** to select the bit that needs to specify channel. Then, press **CH** to specify a channel source (CH1 to CH4).

4. Analog Channel Threshold Setting

To judge logic "1" and logic "0" of the buses, you need to set a threshold for each analog channel (CH1-CH4). When the signal amplitude is greater than the preset value, it is considered as "1"; otherwise "0".

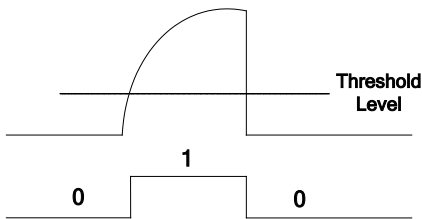

Press **MATH** → **Decode Options** → **Auto Thre.** to turn the auto threshold on or off.

When the auto threshold is turned on, the instrument will calculate the center point according to the current waveform trace automatically as the threshold of each channel before decoding.

When the auto threshold is turned off, you can press **Thre.Set** to turn the auto setting menu. Press **CH1**, **CH2**, **CH3**, **CH4** and use **↺** to set the threshold of each channel. Press **50%** to set the current threshold to 50% of the current waveform trace.

5. Display-related Setting

- Press **Format** to set the display format of the bus to Hex, Decimal, Binary, ASCII or LINE. Note that LINE format is displayed the actual value of the bus in a binary number form, and the order is consistent with the bus transmission sequence. This format is only valid for the serial bus, because the serial bus has the difference of bit sequence of LSB and MSB; if bit sequence of the bus is selected MSB, the LINE format is the same to the binary format.
- Press **Pos** and use **↺** to adjust the vertical display position of the bus.

6. Noise Rejection

Press **NRJ** to turn on or off the noise rejection function. Noise rejection can eliminate the data with inadequate duration time and eliminate the emergent glitches in the actual circuit. When the noise rejection is turned on, press **NRJ**. **Time** to set the desired rejection time and the range is from 0.00 s to 100 ms.

7. Clock Tune

Press **CLK Tune** to set the compensation time to make fine adjustment of the phase deviation between the clock line and data line. The range is from -100 ms to 100 ms; wherein, a negative value denotes that the clock moves forward and a positive value denotes that the clock moves backward.

Note: This function is only available when the CLK is set to CH1 to CH4.

8. Plot

Press **Plot** to turn on or off the pot function. When it is turned on, you can use vector diagram to display the variation tendency of the bus data.

9. Polarity

Press **Polarity** to set the data polarity.

10. Decoding Configuration

Press **Decoding1 Configure** to turn the decoding configuration submenu on.

- Press **Label** to turn the label display function on or off. When it is turned on, the bus label will be displayed at the upper left of the bus (when the bus display is turned on).
- Press **Line** to turn the bus display function on or off. When it is turned on, the bus display will be displayed on the screen (when the bus display is turned on), and you can use **Pos** to adjust the vertical display position of the bus.
- Press **Format** to turn the format display function on or off. When it is turned on, the current format display of the bus will be displayed on the right of the label display (when the bus display is turned on), and you can use **Format** to set the display format of the bus.
- Press **Width** to turn the width display function on or off. When it is turned on, the current bus width will be displayed on the right of the format display (when the bus display is turned on), and you can use **Width** to set the bus

width.

- Press **DataSrc** to select “Trace” or “Memory” as the data source.
- **Dig. Sa** displays the current digital sample rate. The digital sample rate is related to the data source currently selected. When the data source is set to “Trace”, the digital sample rate is related to the horizontal time base; when the data source is set to “Memory”, the digital sample rate is related to the sample rate and memory depth.

11. Event Table

The event table displays the decoded data and the corresponding line number and time in table form. It can be used to observe relatively longer decoded data to solve the problem that some data cannot be viewed cleared on the screen. Press **Evt.Table** → **EventTable** and select “ON” (note: this operation is only available when **Decode** is set to “ON”) to enter the event table interface as shown in Figure 7-2.

Format: set the display format of the “Data” in the event table to HEX, DEC or ASC.

Focus: rotate  to select the desired data.

View: set the display format of the vent table to packets, details or payload.

Data: select the data column to be viwed in the “Details” or “Payload” views.

Order: set the display type of the decoding results in the event table to ascend or descend.

Export: if an USB storage device is currently connected to the instrument, you can press **Export** to export the data table to the external USB storage device in CSV format.

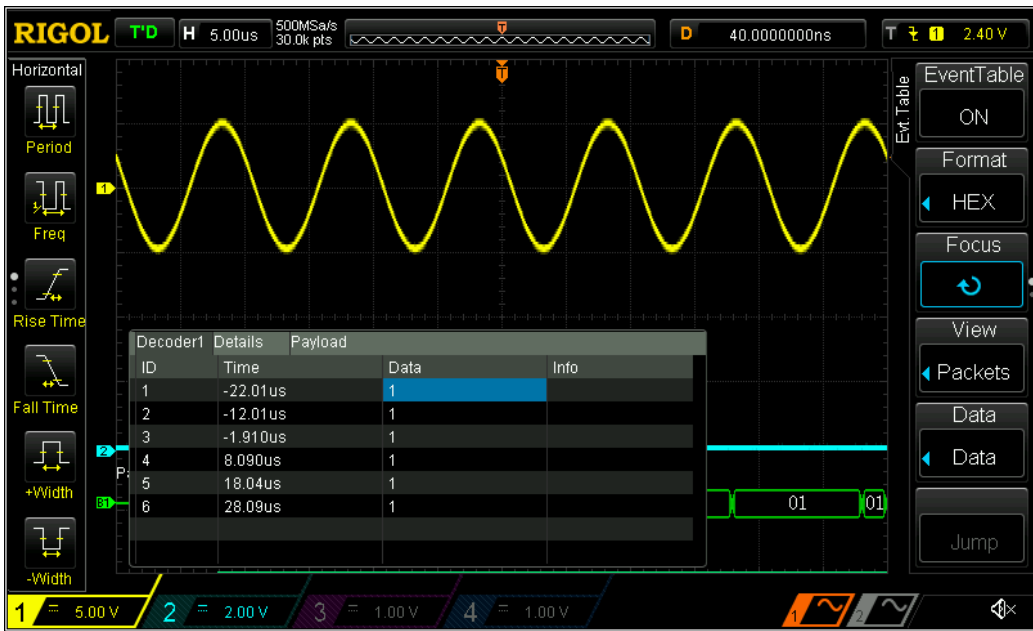

Figure 7-2 Parallel Decoding Event Table

RS232 Decoding (Option)

RS232 serial bus consists of the transmitting data line (TX) and the receiving data line (RX).

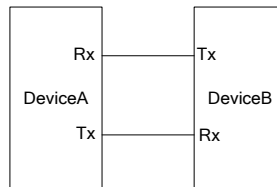

Figure 7-3 RS232 Serial Bus Schematic Diagram

The industry standard of RS232 uses "Negative Logic", namely high level is logic "0" and low level is logic "1".

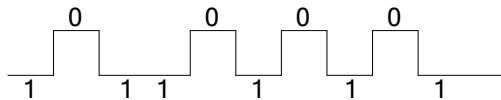
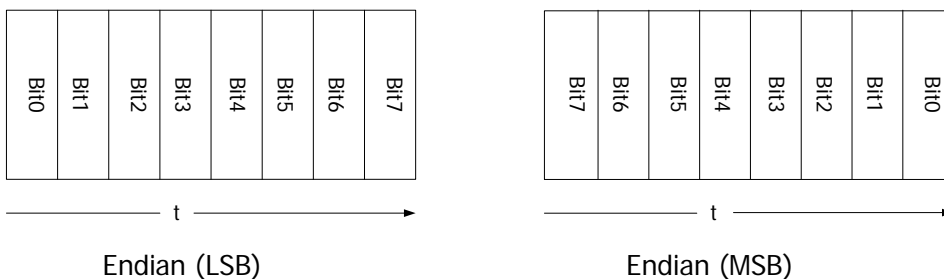

Figure 7-4 Negative Logic Schematic Diagram

By default, RS232 uses LSB (Least Significant Bit) transmission sequence, namely the lowest bit of the data is transmitted first. While for MSB (Most Significant Bit), the highest bit of the data is transmitted first.



In RS232, baud rate is used to represent the transmitting rate (namely bits per second) of the data. The commonly used baud rates include 2400 bps, 4800 bps, 9600 bps, 19200 bps, 38400 bps, 57600 bps and 115200 bps.

In RS232, you need to set the start bit, data bits, check bit (optional) and stop bit of

each frame of data.

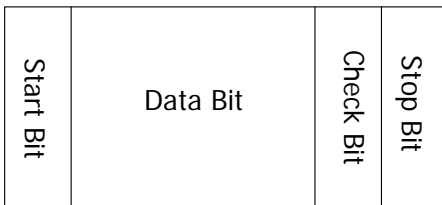

Start Bit: represent when the data starts outputting. Setting the **Polarity** is equivalent to specifying the "Start Bit".

Data Bits: represent the number of data bits actually contained in each frame of data.

Check Bit: used to check the correctness of the data transmission.

- Odd Checkout: the number of "1" in the data bit and check bit is an odd. For example, when 0x55 (01010101) is sent, a 1 needs to be filled in the check bit to make the number of 1 be an odd.
- Even Checkout: the number of "1" in the data bit and check bit is an even. For example, when 0x55 (01010101) is sent, a 0 should be filled in the check bit.
- None: there would not be check bit during the transmission.



Press **MATH** → **Decode1** → **Decoder** to select "RS232" and open the RS232 decoding function menu.

1. Press **Decode** to turn on or off the decoding function.

2. Tx and Rx Channel Setting

Press **Tx** to select any channel (CH1-CH4) as the transmitting channel and when "OFF" is selected, no transmitting channel is set. Use the same method the set the **Rx** channel.

3. Polarity Setting

Press **Polarity** to select " or " and the default is . The oscilloscope will select the rising or falling edge as the start position during decoding.

4. Baud Rate Setting

Press **Baud** use  to select the desired baud rate and you also can press Preset to select 2400, 4800, 9600, 57600, 115200, 230400, 460800, 921600, 1M, 2M, 5M, 10M and 20M and the default is 9600, the unit is bps.

5. Endian Setting

Press **Endian** to select "LSB" or "MSB" and the default is "LSB".

6. Data Packet Setting

As mentioned before, in RS232, you need to set the start bit, data bits, check bit (optional) and stop bit of each frame of data. "Start Bit" is specified by the "Polarity Setting". The setting methods of other parameters are as follows.

- Press **Data** to set the data width of each frame. It can be set to 5, 6, 7 or 8 and the default is 8.
- Press **Stop** to set the stop bit after each frame of data. It can be set to 1 bit, 1.5 bits or 2 bits.
- Press **Parity** to set the even-odd check mode of the data transmission. It can be set to None, Odd or Even.

7. Analog Channel Threshold Setting

To judge logic "1" and logic "0" of the buses, you need to set a threshold for each analog channel (CH1-CH4). When the signal amplitude is greater than the preset value, it is considered as "1"; otherwise "0".

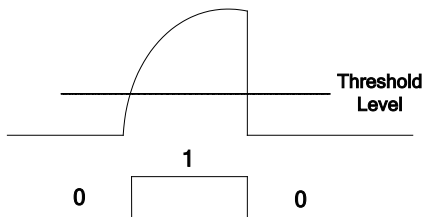

Press **MATH** → **Decode Options** → **Auto Thre.** to turn the auto threshold on or off.

When the auto threshold is turned on, the instrument will calculate the center point according to the current waveform trace automatically as the threshold of each channel before decoding.

When the auto threshold is turned off, you can press **Thre.Set** to turn the auto setting menu. Press **CH1**, **CH2**, **CH3**, **CH4** and use **↺** to set the threshold of each channel. Press **50%** to set the current threshold to 50% of the current waveform trace.

8. Display-related Setting

- Press **Format** to set the display format of the bus to Hex, Decimal, Binary, ASCII or LINE. Note that LINE format is displayed the actual value of the bus in a binary number form, and the order is consistent with the bus transmission sequence. This format is only valid for the serial bus, because the serial bus has the difference of bit sequence of LSB and MSB; if bit sequence of the bus is selected MSB, the LINE format is the same to the binary format.
- Press **Pos** and use  to adjust the vertical display position of the bus.

9. Event Table

The event table displays the decoded data and the corresponding line number and time in table form. It can be used to observe relatively longer decoded data to solve the problem that some data cannot be viewed cleared on the screen. Press **Evt.Table** → **EventTable** and select "ON" (note: this operation is only available when **Decode** is set to "ON") to enter the event table interface as shown in Figure 7-2.

Format: set the display format of the "Data" in the event table to HEX, DEC or ASC.

Focus: rotate  to select the desired data.

View: set the display format of the event table to packets, details or payload.

Data: select the data column to be viewed in the "Details" or "Payload" views.

Order: set the display type of the decoding results in the event table to ascend or descend.

Export: if an USB storage device is currently connected to the instrument, you can press **Export** to export the data table to the external USB storage device in CSV format.

10. Decoding Configuration

Press **Decoding1 Configure** to turn the decoding configuration submenu on.

- Press **Label** to turn the label display function on or off. When it is turned on, the bus label will be displayed at the upper left of the bus (when the bus display is turned on).
- Press **Line** to turn the bus display function on or off. When it is turned on, the bus display will be displayed on the screen, and you can use **Pos** to adjust the vertical display position of the bus.

- Press **Format** to turn the format display function on or off. When it is turned on, the current format display of the bus will be displayed on the right of the label display (when the bus display is turned on), and you can use **Format** to set the display format of the bus.
- Press **Endian** to turn the endian display function on or off. When it is turned on, the current endian display will be displayed on the right of the format display (when the bus display is turned on), and you can use **Endian** to set the bus endian.
- Press **Width** to turn the width display function on or off. When it is turned on, the data width of each frame will be displayed on the right of the endian display (when the bus display is turned on), and you can use **Data** to set the data width of each frame.
- Press **DataSrc** to select "Trace" or "Memory" as the data source.
- **Dig. Sa** displays the current digital sample rate. The digital sample rate is related to the data source currently selected. When the data source is set to "Trace", the digital sample rate is related to the horizontal time base; when the data source is set to "Memory", the digital sample rate is related to the sample rate and memory depth.

11. The Error Expression during Decoding

End Frame Error:

Errors generated when the end frame condition is not met. When the stop bit is set to 1, "?" error mark will be displayed if the stop bit is less than 1.

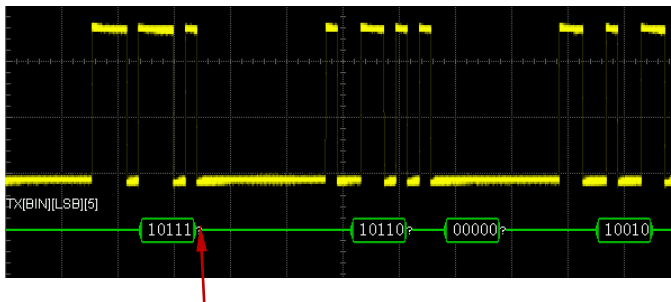

The stop bit is less than 1

Check Error:

When check bit error is detected during the decoding, "?" error mark will be displayed. For example, when the transmitting terminal is set to none check and the decoder is set to odd check, the following check error occurs.

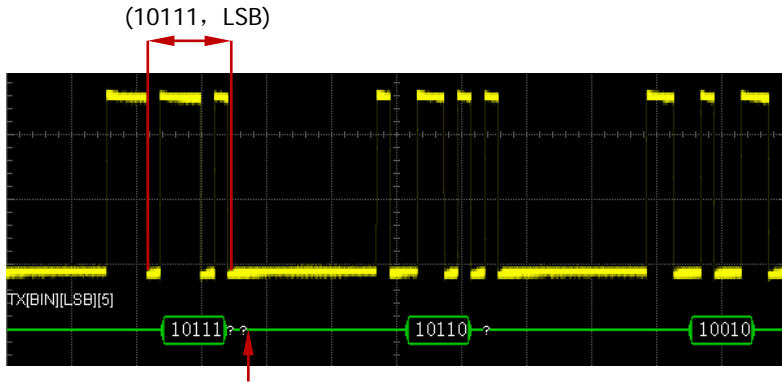

The check bit detected is 0

Wherein, there are odd number (1) of 1 in the 5-bit data 10111 and the check bit should be 1; but the check bit detected on the TX is 0, thus check error occurs.

Note that two error marks will be displayed when end frame error and check error are detected at the same time.

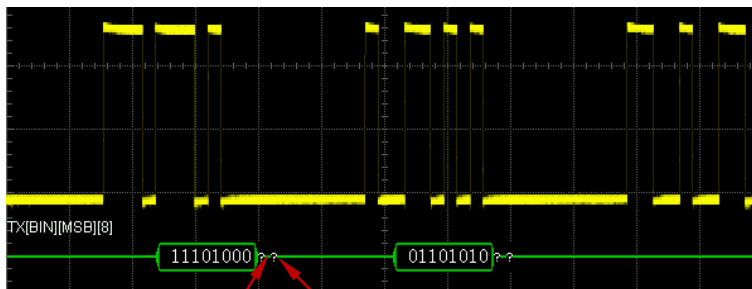

End frame error Check frame error

I2C Decoding (Option)

I2C serial bus consists of the clock line (SCLK) and the data line (SDA).

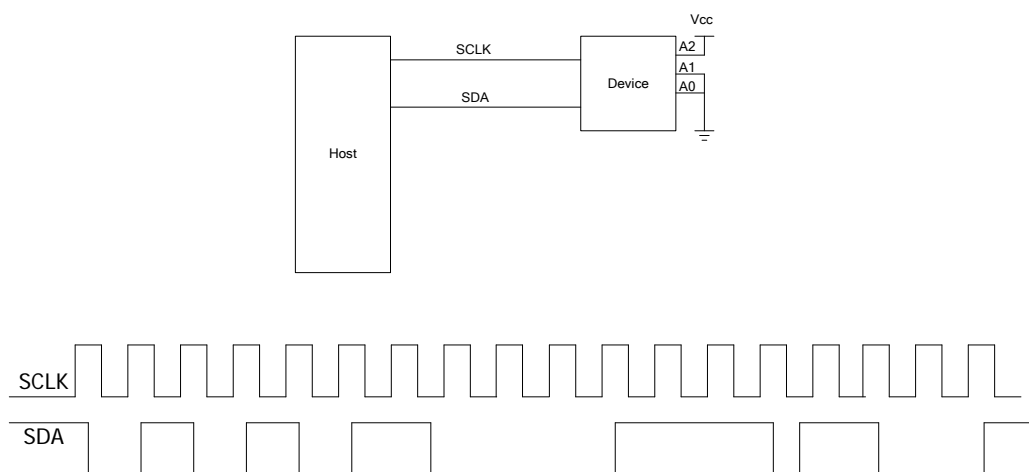

Figure 7-5 I2C Serial Bus

SCLK: sample the SDA on the clock rising edge or falling edge.

SDA: denote the data channel.

Press **MATH** → **Decode1** → **Decoder** to select "I2C" and open the I2C decoding function menu.

1. Press **Decode** to turn on or off the decoding function.
2. **SCLK Setting**
Press **CLK** to select any channel (CH1-CH4) as the clock channel.
3. **SDA Setting**
Press **SDA** to select any channel (CH1-CH4) as the data channel.

Note that press **Exchange** to change the source of clock between the clock source and data source.

4. Analog Channel Threshold Setting

To judge logic "1" and logic "0" of the buses, you need to set a threshold for each analog channel (CH1-CH4). When the signal amplitude is greater than the preset value, it is considered as "1"; otherwise "0".

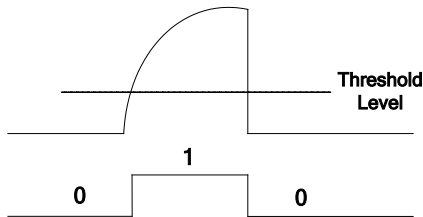

Press **MATH** → **Decode Options** → **Auto Thre.** to turn the auto threshold on or off.

When the auto threshold is turned on, the instrument will calculate the center point according to the current waveform trace automatically as the threshold of each channel before decoding.

When the auto threshold is turned off, you can press **Thre.Set** to turn the auto setting menu. Press **CH1**, **CH2**, **CH3**, **CH4** and use **↺** to set the threshold of each channel. Press **50%** to set the current threshold to 50% of the current waveform trace.

5. Display-related Setting

- Press **Format** to set the display format of the bus to Hex, Decimal, Binary, ASCII or LINE. Note that LINE format is displayed the actual value of the bus in a binary number form, and the order is consistent with the bus transmission sequence. This format is only valid for the serial bus, because the serial bus has the difference of bit sequence of LSB and MSB; if bit sequence of the bus is selected MSB, the LINE format is the same to the binary format.
- Press **Pos** and use **↺** to adjust the vertical display position of the bus.

6. Event Table

The event table displays the decoded data and the corresponding line number and time in table form. It can be used to observe relatively longer decoded data to solve the problem that some data cannot be viewed cleared on the screen.

Press **Evt.Table** → **EventTable** and select “ON” (note: this operation is only available when **Decode** is set to “ON”) to enter the event table interface as shown in Figure 7-2.

Format: set the display format of the “Data” in the event table to HEX, DEC or ASC.

Focus: rotate  to select the desired data.

View: set the display format of the vent table to packets, details or payload.

Data: select the data column to be viwed in the “Details” or “Payload” views.

Order: set the display type of the decoding results in the event table to ascend or descend.

Export: if an USB storage device is currently connected to the instrument, you can press **Export** to export the data table to the external USB storage device in CSV format.

7. Decoding Configuration

Press **Decoding1 Configure** to turn the decoding configuration submenu on.

- Press **Label** to turn the label display function on or off. When it is turned on, the bus label will be displayed at the upper left of the bus (when the bus display is turned on).
- Press **Line** to turn the bus display function on or off. When it is turned on, the bus display will be displayed on the screen, and you can use **Pos** to adjust the vertical display position of the bus.
- Press **Format** to turn the format display function on or off. When it is turned on, the current format display of the bus will be displayed on the right of the label display (when the bus display is turned on), and you can use **Format** to set the display format of the bus.
- Press **Endian** to turn the endian display function on or off. When it is turned on, the current endian display will be displayed on the right of the format display (when the bus display is turned on), and the default is MSB.
- Press **Width** to turn the width display function on or off. When it s turned on, the data width of each frame will be displayed on the right of the endian display (when the bus display is turned on), and the default is 8.
- Press **DataSrc** to select “Trace” or “Memory” as the data source.
- **Dig. Sa** displays the current digital sample rate. The digital sample rate is related to the data source currently selected. When the data source is set to “Trace”, the digital sample rate is related to the horizontal time base; when

the data source is set to “Memory”, the digital sample rate is related to the sample rate and memory depth.

8. Address Information during Decoding

In I2C bus, the front part of each frame of data contains the address information and blue patches are used to represent address ID. In the ID, “Write” is used to represent writing address and “Read” is used to represent reading address.

Press **ADDR** to select “Normal” or “R/W”. when “R/W” is selected, “R/W” bit will be as a part of the address value in the “**AddrBits**”.



9. Error Information during Decoding

When the ACK (ACKnowledge Character) is not met, “?” error marks as shown in the figure below will be displayed.



ACK=1

SPI Decoding (Option)

SPI serial bus consists of clock line (SCLK) and data line (SDA).

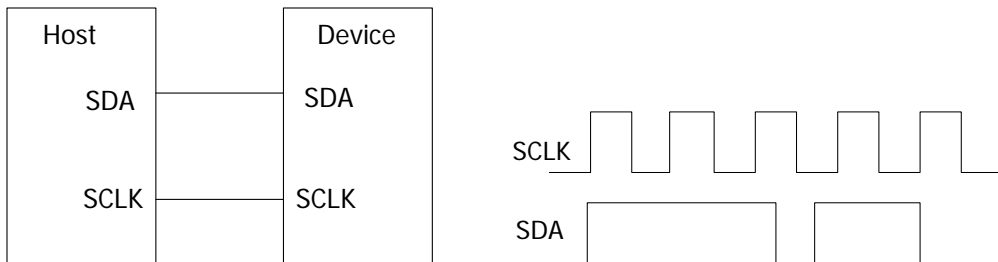

Figure 7-6 SPI Serial Bus

SCLK: sample the SDA on the clock rising edge or falling edge.



SDA: denote the data channel.

Press **MATH** → **Decode1** → **Decoder** to select "RS232" and open the RS232 decoding function menu.

1. Press **Decode** to turn on or off the decoding function.

2. Decoding Mode Setting

Press **Mode** to set the decoding mode of SPI, you can selected "CS" or "Timeout".

CS: when CS selection is valid, the SPI bus samples the data at the jumping point of CLK. After selecting this mode, press **CS** to select any channel (CH1-CH4) as the CS channel. If "OFF" is selected, no CS channel is set. Press **CS/CS** to select  (valid for high level) or  (valid for low level).

Timeout: when this trigger condition is selected, press **Timeout** to set the minimum time that the clock (SCL) signal must be idle before the oscilloscope will search for the data (SDA) on which to decode. The range is from 100 ns to 1 s.

3. CLK Setting

Press **CLK** to select any channel (CH1-CH4) as the clock channel.

4. MISO Setting

Press **MISO** to select any channel (CH1-CH4) as the MISO data channel. When "OFF" is selected, this data line is not set.

5. MOSI Setting

Press **MOSI** to select any channel (CH1-CH4) as the MOSI data. When "OFF" is selected, this data line is not set.

6. Edge Setting

Press **Edge** to sample the MISO and MOSI at the rising edge or falling edge of CLK.

7. Polarity setting

Press **Polarity** to set the polarity of the SDA data line to **TL** (the high level is 1) or **TL** (the low level is 1).

8. Width Setting

Press **Width** to set the bit width of each frame. The range available is from 8 to 32.

9. Endian Setting

Press **Endian** to select "LSB" or "MSB" and the default is "MSB".

10. Display-related Setting

- Press **Format** to set the display format of the bus to Hex, Decimal, Binary, ASCII or LINE. Note that LINE format is displayed the actual value of the bus in a binary number form, and the order is consistent with the bus transmission sequence. This format is only valid for the serial bus, because the serial bus has the difference of bit sequence of LSB and MSB; if bit sequence of the bus is selected MSB, the LINE format is the same to the binary format.
- Press **Pos** and use  to adjust the vertical display position of the bus.

11. Event Table

The event table displays the decoded data and the corresponding line number and time in table form. It can be used to observe relatively longer decoded data to solve the problem that some data cannot be viewed cleared on the screen.

Press **Evt.Table** → **EventTable** and select "ON" (note: this operation is only available when **Decode** is set to "ON") to enter the event table interface as shown in Figure 7-2.

Format: set the display format of the "Data" in the event table to HEX, DEC or ASC.

Focus: rotate  to select the desired data.

View: set the display format of the vent table to packets, details or payload.

Data: select the data column to be viewed in the "Details" or "Payload" views.

Order: set the display type of the decoding results in the event table to ascend or descend.

Export: if an USB storage device is currently connected to the instrument, you can press **Export** to export the data table to the external USB storage device in CSV format.

12. Decoding Configuration

Press **Decoding1 Configure** to turn the decoding configuration submenu on.

- Press **Label** to turn the label display function on or off. When it is turned on, the bus label will be displayed at the upper left of the bus (when the bus display is turned on).
- Press **Line** to turn the bus display function on or off. When it is turned on, the bus display will be displayed on the screen, and you can use **Pos** to adjust the vertical display position of the bus.
- Press **Format** to turn the format display function on or off. When it is turned on, the current format display of the bus will be displayed on the right of the label display (when the bus display is turned on), and you can use **Format** to set the display format of the bus.
- Press **Endian** to turn the endian display function on or off. When it is turned on, the current endian display will be displayed on the right of the format display (when the bus display is turned on), and you can use **Endian** to set the bus endian.
- Press **Width** to turn the width display function on or off. When it is turned on, the data width of each frame will be displayed on the right of the endian display (when the bus display is turned on), and you can use **Width** to set the data width of each frame.
- Press **DataSrc** to select "Trace" or "Memory" as the data source.
- **Dig. Sa** displays the current digital sample rate. The digital sample rate is

related to the data source currently selected. When the data source is set to "Trace", the digital sample rate is related to the horizontal time base; when the data source is set to "Memory", the digital sample rate is related to the sample rate and memory depth.

Chapter 8 Reference Waveform

In actual testing process, the waveform being tested can be compared with the reference waveform to judge the causes of failures.



The contents of this chapter:

- To Enable REF Function
- To Select REF Source
- To Adjust REF Waveform Display
- To Save to Internal Memory
- To Set the Color
- To reset the REF waveform
- To Export to Internal or External Memory
- To Import from Internal or External Memory

To Enable REF Function

Press **REF** in the vertical control area (VERTICAL) at the front panel to enable the REF function.

Note: When the time base is in XY mode, REF function can not be enabled.

DS1000Z provides 10 reference waveform channels. Press **Channel** and use  to set the desired reference channel to on or off and a channel icon (for example, ) of the channel enabled will be display at the left side of the screen grid.



When the REF function is enabled, you can select different color for each reference waveform, set the source of each reference channel, adjust the vertical scale and position of the reference waveform and save the reference waveform to internal or external memory as well as recall it when needed. For details, please refer to the introductions below.

To Select REF Source

Press **Current** and use  to select any of the reference channels (Ref1 to Ref10) enabled and then press **Source** to specify a reference source (CH1-CH4 or MATH) for this channel.

To Adjust REF Waveform Display

To adjust the reference waveform specified in **Current**:



Press **REF** to enable the REF function. Then, press **Offset** and use  to adjust the vertical position of the reference waveform and press **Scale** and use  to adjust the vertical scale of the reference waveform.

To Save to Internal Memory

Press **Save** to save the waveform (screen region) in the specified source to internal memory as reference waveform and display it on the screen. Note that this operation only saves the reference waveform in the volatile memory and the waveform will be cleared at power-off.

To Set the Color

DS1000Z series oscilloscope provides five colors (gray, green, light blue, magenta and orange) to mark the reference waveforms of different channels in order to distinguish them.

Press **Current** and use  to select any of the reference channels (Ref1-Ref10) enabled. Then, press **Color** to specify a different color for the reference waveform of that channel. The corresponding icon at the left of the channel currently selected will be filled with the specified color, for example, .

To reset the REF waveform

Press **Reset** and the reference waveform returns to the position where the source channel waveform is located when the **Save** operation was executed.

To Export to Internal or External Memory

Users can also save the reference waveform to the internal Flash memory or external USB storage device. The file format of the reference waveform is "*.ref".

Press **Export** to enter the file store interface. Please refer to the relative descriptions in "**Store and Recall**" to save the reference waveform to internal or external memory.

To Import from Internal or External Memory

Users can also import the reference waveform stored in the internal Flash memory or external USB storage device to the internal memory.

Press **Import** to enter the file recall interface. Please refer to the relative descriptions in “**Store and Recall**” to import the reference waveform to the internal memory of the instrument.

Chapter 9 Pass/Fail Test

Monitor the change of the signal by judging whether the input signal is within the mask created. The test results can be displayed on the screen as well as be declared through the system sound or the pulse signal output from the **[Trigger Out]** connector at the rear panel.

The contents of this chapter:

- To Enable Pass/Fail Test
- To Select Source
- Mask Range
- Test and Output
- To Save the Test Mask
- To Load the Test Mask

To Enable Pass/Fail Test

Press **Utility** → **Pass/Fail** → **Enable** to select "ON".

Note: When the time base is in XY mode, the Pass/Fail test function can not be enabled.

To start testing, press **Enable** and select "ON". Then, press **Operate** to select "▶" to start testing and select "■" to stop testing.

You can select the signal source, set the test mask range, create mask as well as save and load the test mask. For details, please refer to the following introductions.

To Select Source

Press **Source** to select the channel (CH1-CH4) to be tested and only channels enabled can be selected. During the test, the oscilloscope will judge whether each frame of waveform in the source complies with the current test mask and those waveforms outside the mask area is considered as failed.

Mask Range

Users can define their desired test masks. The test mask is "Screen" by default.

Press **Range** to enter the mask range setting menu. Press **X Mask** and **Y Mask**, rotate  and the mask lines appear on the screen as shown in the figure below. Press **Create Mask** to apply the mask currently created. The horizontal and vertical adjustment ranges are 0.02 div to 4.0 div and 0.04 div to 5.12 div respectively.

Test and Output

Before the test, you can use the following method to set the output mode of the test results.

Press **Stat.Disp** to select "ON" or "OFF". When "ON" is selected, the test results will be displayed at the upper right corner of the screen.

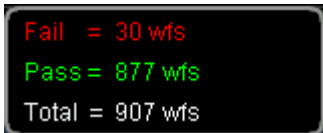

Press **Stat.Disp** to clear the current statistic and restatistic the test result.

Press **Stop On Fail** to select "ON" or "OFF".

- ON: when failed waveforms are detected, the oscilloscope will stop the test and enter the "STOP" state. At this point, the results of the test remain the same on the screen (if display is turned on) and only one pulse is output from the **[Trigger Out]** connector (if enabled) at the rear panel.
- OFF: the oscilloscope will continue with the test even though failed waveforms are detected. The test results on the screen will update continuously and a pulse will be output from the **[Trigger Out]** connector at the rear panel each time a failed waveform is detected.

Press **Output** to select "🔊" or "🔇".

- 🔊: failed waveforms are detected, there are display and output but the beeper does not sound.
- 🔇: failed waveforms are detected, there are display and output and the beeper sounds (not related to the on/off state of the sound).

Press **AuxOutput** to quickly turn "ON" or "OFF" the output of test results from the **[Trigger Out]** connector at the rear panel. You can also press **Utility** → **AuxOutput** and select "PassFail" to set this output.

To Save the Test Mask

Users can save the current test mask to the internal Flash memory or external USB storage device. The file format of the test mask file is "*.pf".

Press **Save** to enter the file store interface. Please refer to the relative descriptions in "**Store and Recall**" to save the test mask file to the internal or external memory.

To Load the Test Mask

Users can also load the test mask files (*.pf) stored in the internal Flash memory or external USB storage device to the internal memory.

Press **Load** to enter the file recall interface. Please refer to the relative descriptions in "**Store and Recall**" to load the test masks to the internal memory of the instrument.

Chapter 10 Waveform Record

Waveform record can record the waveforms of the input channels (CH1-CH4). Waveform playback and analysis can provide better waveform analysis effect.

Note: the horizontal time base must be set to YT mode during waveform record.

Press **Utility** → **Record** → **Record** to turn the waveform record on or off.

1. Waveform Record

Press **Record** to start the waveform record. The current record information at the upper right corner (as shown in the figure below) would change accordingly during the waveform record process and "●" will change into "■" automatically in the menu. At this point, press Record again to stop the waveform record. You can set the parameter of the waveform record according to the instruction of "Record Setting" before waveform record.



2. Playback

Press **Play** to play the waveform recorded. For specified setting of playing, please refer to the instruction of "Playback Setting".

3. Stop

You can press **Stop** to stop the playback during the waveform playback process.

4. Current Frame

Press Current and use  to set the current frame, the default is the maximum number of frames recorded. During the setting, the screen will display the corresponding waveform of the current frame synchronously, namely manual playback.

The contents of this chapter:

- Playback Setting
- Record Setting

Playback Setting



The waveform playback function can play back the waveforms currently recorded. At this point, the information as shown in the figure below is displayed at the upper right corner of the screen. The data on the left indicates the specific frame currently displayed on the screen and during the playback and this value would change continuously. The data on the right indicates the maximum number of frames recorded.



Before playing back the waveform, you can press **Play Opt** to set the playback parameters.



1. Play Mode

Press **Mode** to set the playback mode to cycle or single.

- : cycle. Play from the start frame to the end frame and then repeat until you stop it manually.
- : single. Play from the start frame to the end frame and then stop.

2. Play Direction

Press **Dir** to set the playback direction to forward direction or inverse direction.

- : forward direction, Play from the start frame to the end frame.
- : inverse direction, play from end frame to start frame.

3. Interval

Press **Interval** and use  to set the time interval of playback. The range available is from 100 ns to 10 s and the default is 100 ns.

4. Start Frame

Press **Start** and use  to set the start frame of playback. The default is 1 and the maximum is the maximum number of frames recorded.

5. End Frame

Press **End** and use  to set the end frame of the playback. The default is the total number of frames of the waveform recorded.

Tip

During waveform playback, **RUN/STOP** can be used to switch between playback and pause. Each time **SINGLE** is pressed, the **Current Frame** moves one frame forward.

Record Setting

You can press **Record Opt** to set the following parameters before waveform record.

1. Interval

Press **Interval** to set the time interval between frames in waveform recording and the range available is from 100 ns to 10 s.

2. Record Length



Press **Length** to set the number of frame currently recorded and the range available is from 1 to the maximum number of frames that can be recorded currently. Press **Set Max** to set the number of frame to the maximum number of frames that can be recorded.

3. Maximum Number of Frames

The menu shows the maximum number of frames that can be recorded currently.

As the capacity of the waveform memory is fixed, the more the number of points each frame of waveform has, the less the number of waveform frames can be recorded. Thus, the maximum end frame of waveform record is decided by the "Memory Depth" currently selected. The smaller the memory depth is, the greater the number of waveform frames can be recorded.

4. Beep

- : you can not hear the sound of the beeper when the waveform recording is over.
- : you can hear the sound of the beeper when the waveform recording is over.

Chapter 11 Display Control

You can set the type, persistence time and brightness of waveform display as well as the grid type and grid brightness of the screen display.

The contents of this chapter:

- To Select the Display Type
- To Set the Persistence Time
- To Set the Waveform Intensity
- To Set the Screen Grid
- To Set the Grid Brightness

To Select the Display Type

Press **Display** → **Type** to set the waveform display mode to “Vectors” or “Dots”.

- Vectors: the sample points are connected by lines and displayed. Normally, this mode can provide the most vivid waveform to view the steep edge of the waveform (such as square waveform).
- Dots: display the sample points directly. You can directly view each sample point and use the cursor to measure the X and Y values of the sample point.

To Set the Persistence Time

Press **Display** → **Persis.Time** to set the persistence time of the oscilloscope to Min, specific values (100 ms, 200 ms, 500 ms, 1 s, 2 s, 5 s, 10 s and 20 s) or Infinite.

In the following part, a frequency sweep signal of the sine waveform is used to demonstrate the waveform effects in different persistence times.

1. Min

Enable to view waveform changing in high refresh rate.

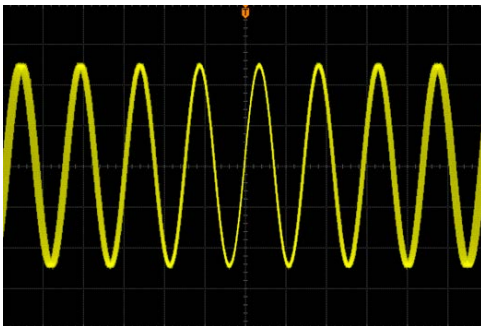

2. Specific Values

Enable to observe glitch that changes relatively slowly or glitch with low occurrence probability. The persistence time can be set to 100 ms, 200 ms, 500 ms, 1 s, 2 s, 5 s, 10 s or 20 s.

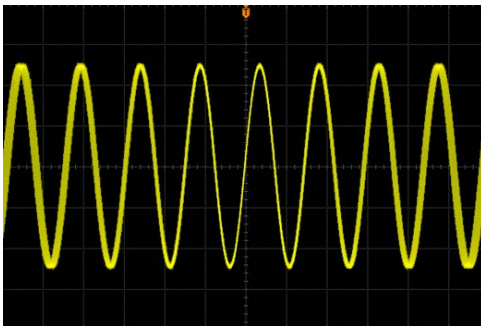

3. Infinite

In this mode, the oscilloscope displays the waveform newly acquired without clearing the waveforms acquired formerly. The waveforms acquired formerly will be displayed in relatively low-brightness color and the waveform newly acquired will be displayed in normal brightness and color. Infinite persistence can be used

to measure noise and jitter and to capture incidental events.





To Set the Waveform Intensity

Press **Display** → **WaveIntensity** or turn  when the menu is hidden to adjust the waveform brightness of the analog channel. The default is 50% and the range available is from 0% to 100%.

To Set the Screen Grid

Press **Display** → **Grid** to set the screen grid type.

- : turn the background grid and coordinate on.
- : turn the background grid off.
- : turn the background grid and coordinate off.

To Set the Grid Brightness

Press **Display** → **Brightness** to set the brightness of the screen grid. Turn  to adjust the grid brightness. The default is 50% and the range available is from 0% to 100%.

Chapter 12 Signal Source

DS1000Z which combines the signal generator and oscilloscope in one by providing a dual-channel, 25 MHz signal source, is very convenient for the engineers who need to use both signal source and oscilloscope at the same time. This chapter introduces how to use the built-in signal source of the oscilloscope. As the function and the setting method of the two channels of the signal source are the same, this chapter only takes Source1 as an example for illustration.

Press **Source** to enter the signal source setting interface. Press **Output** to turn the signal output on or off. When "ON" is selected, the instrument outputs the signal currently set from the **[Source1]** connector at the rear panel. Press **Src1Conf** to select the type of the signal currently output and set the relative parameters of the signal. You can press **StatusDisp** to view the current signal states of SOURCE1 and SOURCE2 (such as the frequency, amplitude, offset, phase, modulation type and modulation frequency).

Note: The function of **Source** → **Output** is the same with that of **Source** → **Src1Conf** → **Output** mentioned below.

The contents of this chapter:

- To Output Basic Waveform
- To Output Built-In Waveform
- To Output Arbitrary Waveform

To Output Basic Waveform

The built-in signal source of DS1000Z can output various kinds of basic waveforms, including sine, square, ramp, pulse, DC and noise.

To Output Sine Waveform

Press **Src1Conf** to enter the waveform setting interface. Press **Wave** to select "Sine", at this point, you can set the sine waveform parameters.

1. Output

Press **Output** to turn the signal output on or off. This function is the same with that of **Source** → **Output**. When "ON" is selected, the instrument outputs the signal currently set from the **[Source1]** connector at the rear panel.

2. To set the frequency

Press **Frequency** to set the frequency of the current signal. For the setting methods, refer to "**Parameter Setting Methods**".

The frequency range of different waveform differs.

Sine: 100 mHz to 25 MHz

Square: 100 mHz to 15 MHz

Ramp: 100 mHz to 100 kHz

Pulse: 100 mHz to 1 MHz

DC and Noise: do not have the frequency parameter

3. To set the amplitude

Press **Amplitude** to set the amplitude of the current signal. For the setting methods, refer to "**Parameter Setting Methods**". When the impedance is set to HighZ, the range available is from $(-2.5 \text{ V} + \text{current amplitude}/2)$ to $(2.5 \text{ V} - \text{current amplitude}/2)$ and when the impedance is set to 50Ω , the range available is $(-1.25 \text{ V} + \text{current amplitude}/2)$ to $(1.25 \text{ V} - \text{current amplitude}/2)$.

4. To set the DC offset voltage

Press **Offset** to set the DC offset of the current signal. For the setting methods, refer to "**Parameter Setting Methods**". When the impedance is set to HighZ,

the range available is from $(-2.5 \text{ V} + \text{current amplitude}/2)$ to $(2.5 \text{ V} - \text{current amplitude}/2)$ and when the impedance is set to 50Ω , the range available is $(-1.25 \text{ V} + \text{current amplitude}/2)$ to $(1.25 \text{ V} - \text{current amplitude}/2)$.

5. To set the start phase

Press **StartPhase** to set the start phase of the current signal. For the setting methods, refer to "**Parameter Setting Methods**". The range available is from 0° to 360° .

6. Align phase

Press **AlignPhase** to re-configure the two channels and enable the signal source to output with specified frequency and phase. For two signals whose frequencies are the same or in multiple, this operation will align their phases. Use the oscilloscope to sample and display the waveforms of the two channels and you will see that the phases of the two waveforms shown on the oscilloscope changed. At this point, press **AlignPhase** and the waveforms on the oscilloscope will restore the current phase deviation of the two channels.

7. Modulation

Press **Modulation** to turn the modulation function on or off. For detailed information about the modulation function, please refer to "**Modulation**".

8. To set impedance

Press **Impedance** to set the output impedance of the current signal, "HighZ" and "50Ω" can be selected.

To Output Square Waveform

Press **Src1Conf** to enter the waveform setting interface. Press **Wave** to select "Square", at this point, you can set the square waveform parameters. For the specified setting method, please refer to the instruction of "**To Output Sine Waveform**".

To Output Ramp Waveform

Press **Src1Conf** to enter the waveform setting interface. Press **Wave** to select "Ramp", at this point, you can set the ramp waveform parameters. For the specified setting method, please refer to the instruction of "**To Output Sine Waveform**". Only "symmetry" is introduced in this chapter.

Symmetry

Symmetry is defined as the percentage that the rising period of ramp waveform takes up in the whole period, as shown in the figure below.

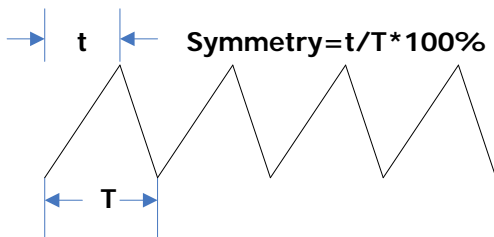

Press **Symmetry** and use  to set the symmetry of the current ramp. For the setting methods, refer to "**Parameter Setting Methods**". The range available is from 0% to 100%.

To Output Pulse Waveform

Press **Src1Conf** to enter the waveform setting interface. Press **Wave** to select "Pulse", at this point, you can set the pulse waveform parameters. For the specified setting method, please refer to the instruction of "To Output Sine Waveform". Only "Duty cycle" is introduced in this chapter.

Duty cycle

Duty cycle is defined as the percentage that the high level takes up in the whole period of pulse, as shown in the figure below.

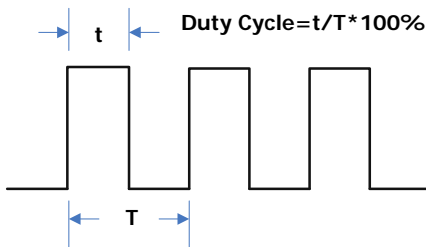

Press **Duty Cycle** and use \curvearrowright to set the duty cycle of the current pulse signal. For the setting methods, refer to "Parameter Setting Methods". The range available is from 10% to 90%.

To Output DC Waveform

Press **Src1Conf** to enter the waveform setting interface. Press **Wave** to select "DC", at this point, you can set the offset and impedance of the DC signal.

1. Output

Press **Output** to turn the signal output on or off.

2. To set the DC offset

Press **Offset** to set the offset value of the current DC signal. For the setting methods, refer to "Parameter Setting Methods". When the impedance is set to HighZ, the range available is -2.5 V to +2.5 V and when the impedance is set

to 50 Ω , the range available is -1.25 V to +1.25 V.

3. To set the impedance

Press **Impedance** to set the output impedance of the signal source to "HighZ" or "50 Ω ".

To Output Noise Waveform

Press **Src1Conf** to enter the waveform setting interface. Press **Wave** to select "Noise", at this point, you can set the amplitude, offset and impedance of the noise signal.

1. Output

Press **Output** to turn the signal output on or off.

2. To set the amplitude

Press **Amplitude** to set the amplitude of the current signal. For the setting methods, refer to "**Parameter Setting Methods**". When the impedance is set to HighZ, the range available is from 20 mVpp to 5Vpp and when the impedance is set to 50 Ω , the range available is from 10 mVpp to 2.5 Vpp.

3. To set the DC offset voltage

Press **Offset** to set the DC offset of the current signal. For the setting methods, refer to "**Parameter Setting Methods**". When the impedance is set to HighZ, the range available is from (-2.5 V+current amplitude/2) to (2.5 V-current amplitude/2) and when the impedance is set to 50 Ω , the range available is (-1.25 V+current amplitude/2) to (1.25 V-current amplitude/2).

Note: The offset value can only maintain three effective digits. For example, when the amplitude is set to 10 mVpp (the impedance is 50 Ω), the offset range calculated is -1.245 V to 1.245 V, but the actual offset range is -1.24 V to 1.24 V.

To Output Built-In Waveform

The built-in signal source of DS1000Z provides 7 kinds of built-in waveforms including Sinc, Exp.Rise, Exp.Fall, ECG, Guass, Lorentz, Haversine. Press **Src1Conf** to enter the waveform setting interface. Press **Wave** to select "Built-In", at this point, you can set the relative parameters of the output signal according to the built-in waveform type selected.

1. Output

Press **Output** to turn the signal output on or off.

2. To select the built-in waveform

Press **Built-In** to select any one of the 7 kinds of built-in waveforms. The 7 kinds of built-in waveforms are as shown in the figures below.

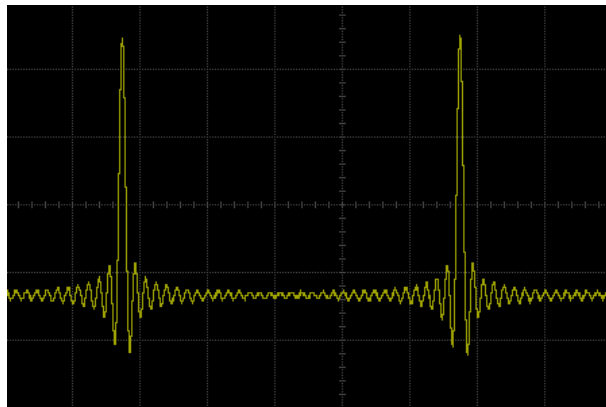

Figure 12-1 Built-in Waveform-Sinc

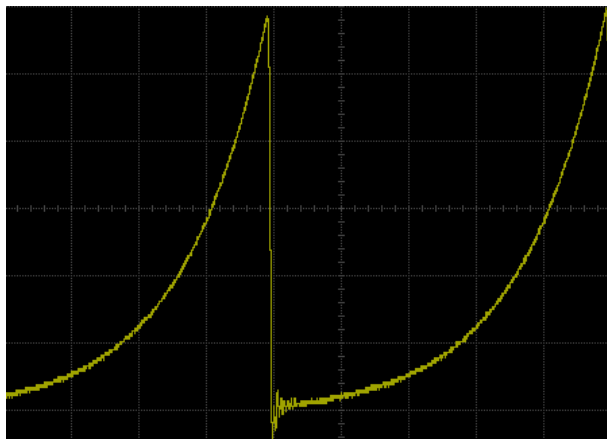

Figure 12-2 Built-in Waveform-Exp.Rise

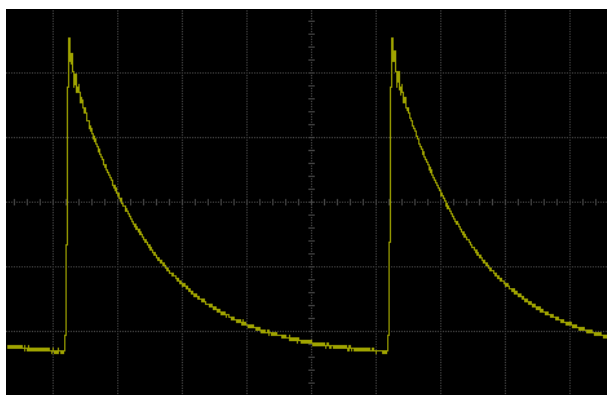

Figure 12-3 Built-in Waveform- Exp.Fall

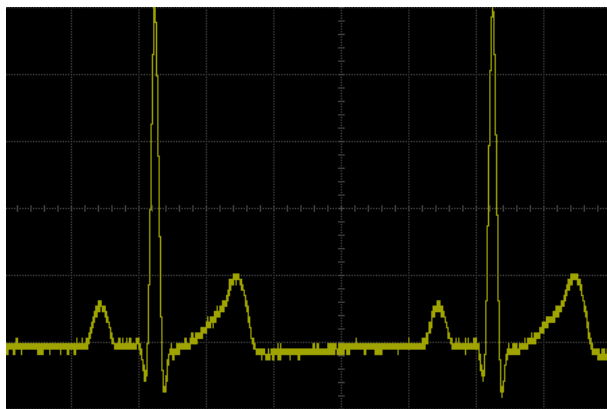

Figure 12-4 Built-in Waveform-ECG

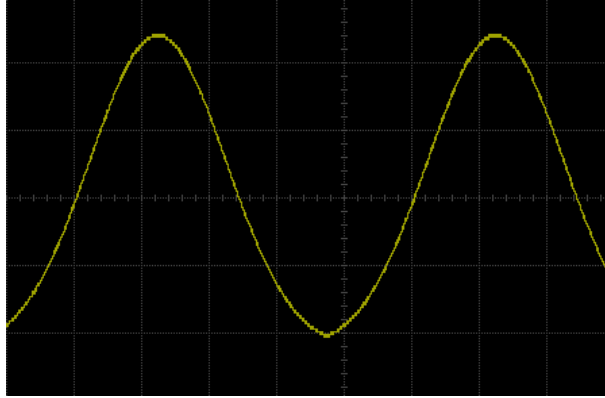

Figure 12-5 Built-in Waveform-Gauss

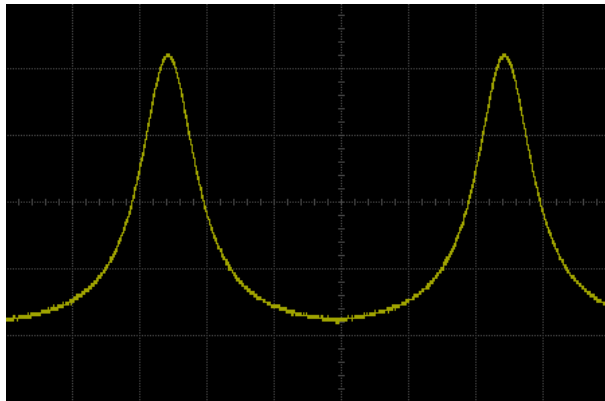

Figure 12-6 Built-in Waveform-Lorentz

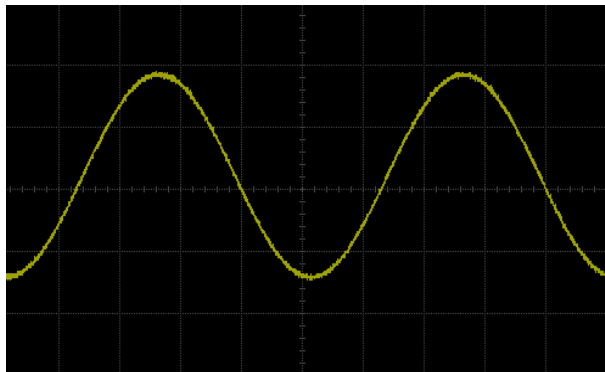

Figure 12-7 Built-in Waveform-Haversine

3. To set the frequency

Press **Frequency** to set the frequency of the current signal. For the setting methods, refer to "**Parameter Setting Methods**". The range available is from

100 mHz to 1 MHz.

4. To set the amplitude

Press **Amplitude** to set the amplitude of the current signal. For the setting methods, refer to “**Parameter Setting Methods**”. When the impedance is set to HighZ, the range available is from $(-2.5 \text{ V} + \text{current amplitude}/2)$ to $(2.5 \text{ V} - \text{current amplitude}/2)$ and when the impedance is set to 50Ω , the range available is $(-1.25 \text{ V} + \text{current amplitude}/2)$ to $(1.25 \text{ V} - \text{current amplitude}/2)$.

5. To set the DC offset voltage

Press **Offset** to set the DC offset of the current signal. For the setting methods, refer to “**Parameter Setting Methods**”. When the impedance is set to HighZ, the range available is from $(-2.5 \text{ V} + \text{current amplitude}/2)$ to $(2.5 \text{ V} - \text{current amplitude}/2)$ and when the impedance is set to 50Ω , the range available is $(-1.25 \text{ V} + \text{current amplitude}/2)$ to $(1.25 \text{ V} - \text{current amplitude}/2)$.

Note: The offset value can only maintain three effective digits. For example, when the amplitude is set to 10 mVpp (the impedance is 50Ω), the offset range calculated is -1.245 V to 1.245 V, but the actual offset range is -1.24 V to 1.24 V.

6. To set the start phase

Press **Start Phase** to set the start phase of the current signal. For the setting methods, refer to “**Parameter Setting Methods**”. The range available is from 0° to 360° .

7. Align phase

Press **AlignPhase** to re-configure the two channels and enable the signal source to output with specified frequency and phase. For two signals whose frequencies are the same or in multiple, this operation will align their phases. Use the oscilloscope to sample and display the waveforms of the two channels and you will see that the phases of the two waveforms shown on the oscilloscope changed. At this point, press **AlignPhase** and the waveforms on the oscilloscope will restore the current phase deviation of the two channels.

8. Modulation

Press **Modulation** to turn the modulation function on or off. For detailed information about modulation function, please refer to “**Modulation**”.

9. To set impedance

Press **Impedance** to set the output impedance of the signal source to "HighZ" or "50Ω".

To Output Arbitrary Waveform

DS1000Z allows users to define arbitrary waveforms and to save them to the internal or external memory. The internal memory can store 10 arbitrary waveforms at most. 1 to 16384 points (namely 1 pts to 16 kpts) can be included in the user-defined waveforms.

1. Output

Press **Output** to turn the signal output on or off.

2. To set the frequency

Press **Frequency** to set the frequency of the current signal. For the setting methods, refer to "**Parameter Setting Methods**". The range available is from 100 mHz to 10 MHz.

3. To set the amplitude

Press **Amplitude** to set the amplitude of the current signal. For the setting methods, refer to "**Parameter Setting Methods**". When the impedance is set to HighZ, the range available is from 20 mVpp to 5Vpp or when the impedance is set to 50 Ω , the range available is from 10 mVpp to 2.5 Vpp.

4. To set the DC offset voltage

Press **Offset** to set the DC offset of the current signal. For the setting methods, refer to "**Parameter Setting Methods**". When the impedance is set to HighZ, the range available is from $(-2.5 \text{ V} + \text{current amplitude}/2)$ to $(2.5 \text{ V} - \text{current amplitude}/2)$ and when the impedance is set to 50 Ω , the range available is $(-1.25 \text{ V} + \text{current amplitude}/2)$ to $(1.25 \text{ V} - \text{current amplitude}/2)$.

Note: The offset value can only maintain three effective digits. For example, when the amplitude is set to 10 mV (the impedance is 50 Ω), the offset range calculated is -1.245 V to 1.245 V, but the actual offset range is -1.24 V to 1.24 V.

5. To set the start phase

Press **Start** Phase to set the start phase of the current signal. For the setting methods, refer to "**Parameter Setting Methods**". The range available is from 0° to 360°.

6. Align phase

Press **AlignPhase** to re-configure the two channels and enable the signal source to output with specified frequency and phase. For two signals whose frequencies are the same or in multiple, this operation will align their phases. Use the oscilloscope to sample and display the waveforms of the two channels and you will see that the phases of the two waveforms shown on the oscilloscope changed. At this point, press **AlignPhase** and the waveforms on the oscilloscope will restore the current phase deviation of the two channels.

7. Select waveform

Select the arbitrary waveform stored in the internal or external memories.

8. Create waveforms

Users can define their own arbitrary waveforms. For detailed information please refer to **"To Create Waveform"**.

9. Edit waveform

Edit the arbitrary waveforms already stored. For detailed information please refer to **"To Edit Waveform"**.

10. Modulation

Press **Modulation** to turn the modulation function on or off. For detailed information about the modulation function, please refer to **"Modulation"**.

11. To set impedance

Press **Impedance** to set the output impedance of the signal source to "HighZ" or "50Ω".

The following parts introduce how **"To Select Waveform"**, **"To Create Waveform"**, and **"To Edit Waveform"**.

To Select Waveform

Users can select arbitrary waveforms stored in the internal memory to output. Press **Select** → **Load** and use  to select the desired waveform. You also can edit the waveform currently selected and please refer to the instruction of “**To Edit Waveform**”.

To Create Waveform

Users can create arbitrary waveforms according to their needs. Press **Create** to enter the waveform creation interface.

1. To set the number of initial points

When creating a new waveform, the waveform editor will automatically create a waveform with two points. By default, point 1 is located at 0 s and point 1 is located at half of the specified period.

Press **InitPoint** and use  to set the number of initial points of the new waveform and the number of arbitrary waveform points can be up to 16384 (16 kpts).

2. Interpolation

Press **Interp** to turn the interpolation between the defined waveform points on or off.

- **ON:** the waveform editor will connect two defined points with a straight line.

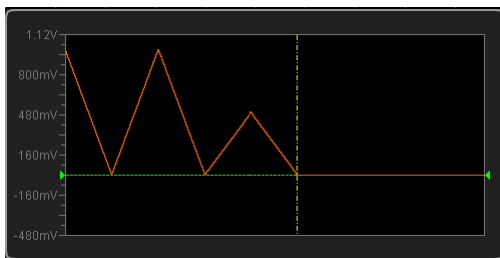

- **OFF:** the waveform editor will hold a constant voltage level between two defined points and create a step waveform.

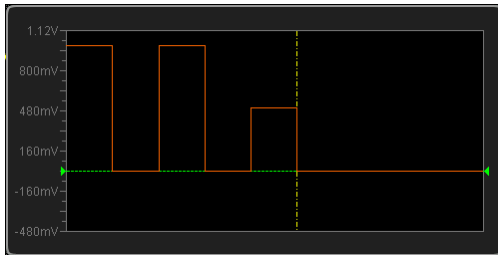

3. Zoom

Press **Zoom** to turn the zoom function on or off.

- **ON**: only display the current point in the middle of the waveform editor window.
- **OFF**: display all the initial points in the waveform editor window.

4. Current point

Press **CurPoint** and use  to set the desired point currently edited and the range available is from 1 to **the number of initial points**.

5. Voltage

Press **Voltage** to set the voltage value of the current point and the range available is from -2.5 V to +2.5 V.

6. Time

Press **Time** to set the duration time of the current point and this setting is limited by the duration times of the previous point and the next point. Point 1 is fixed at 0 s.

7. Insert

Press **Insert** to insert a new point at the middle position of the current edited point and the next edited point.

8. Delete

Press **Delete** to delete the current point from the waveform and connect the remaining points using the current interpolation method. Note that point 1 cannot be deleted.

9. Apply

Press **Apply** to apply the waveform currently edited.

10. Save

Press **Save** to enter the files store interface. Please refer to the instruction of "**Store and Recall**" to save the waveform files currently created in the internal or external memory in ".arb" format (if the current position exist a file, you can overwrite the original file or save the waveform currently edited again). You can output the arbitrary waveforms saved in the internal or external memory and for the specified operation, please refer to the instruction of "**To Select Waveform**".

To Edit Waveform

Users can edit the waveforms which have been already saved. Press **Edit** to enter the waveform editing interface.

1. Interpolation

Press **Interp** to turn the interpolation method between the defined waveform points on or off.

- **ON:** the waveform editor will connect two defined points with a straight line.
- **OFF:** the waveform editor will hold a constant voltage level between two defined points and create a step waveform.

2. Zoom

Press **Zoom** to turn the zoom function on or off.

- **ON:** only display the current point in the middle of the waveform editor window.
- **OFF:** display all the initial points in the waveform editor window.

3. Current point

Press **CurPoint** and use  to set the desired points currently edited and the range available is from 1 to **the number of initial points**.

4. Voltage

Press **Voltage** to set the voltage value of the current point and the range available is from -2.5 V to +2.5 V.

5. Time

Press **Time** to set the duration time of the current point and this setting is limited by the duration times of the previous point and the next point. Point 1 is fixed at 0 s.

6. Insert point

Press **Insert** to insert a new point at the middle position of the current edited point and the next edited point.

7. Delete point

Press **Delete** to delete the current point from the waveform and connect the remaining points using the current interpolation method. Note that point 1 cannot be deleted.

8. Apply

Press **Apply** to apply the waveform currently edited.

9. Save

Press **Save** to enter the files store interface. Please refer to the instruction of "**Store and Recall**" to save the waveform files currently created in the internal or external memory in ".arb" format (if the current position exist a file, you can overwrite the original file or save the waveform currently edited again). You can output the arbitrary waveforms saved in the internal or external memory and for the specified operation, please refer to the instruction of "**To Select Waveform**".

Modulation

The built-in signal source the DS1000Z series oscilloscope supports AM and FM modulations. The modulated waveform consists of carrier waveform and modulating waveform. The carrier waveform is the signal outputted from the signal source and the modulating waveform can be the built-in sine, square, ramp and noise signals of the signal source.

Press **Src1Mod** to open the Source1 modulation setting menu. Press **Mod.Type** to set the modulation type of the current signal to "AM" or "FM". Then, set the modulation parameters according to the modulation type selected. Press **Modulation** to turn the modulation function on or off.

AM

Amplitude modulation, namely the amplitude of the carrier waveform varies with the amplitude of the modulating waveform, as shown in the figure below.

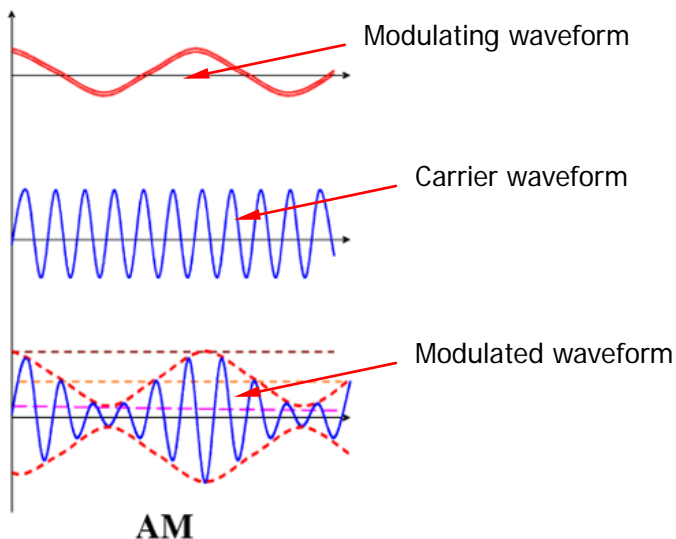

Figure 12-8 Amplitude Modulation

1. Select the carrier waveform

Press **Src1Conf** to enter the waveform setting interface. Press **Wave** to select

the desired carrier waveform.

Note: "Pulse", "DC" and "Noise" cannot be selected.

2. Set the carrier waveform parameters

After selecting the desired carrier waveform, set the carrier parameters (such as the frequency and amplitude) by referring to the corresponding introductions above.

3. Select the modulating waveform

Press **Src1Mod** to open the Source1 modulation setting menu. Press **Shape** to select the desired modulating waveform (sine, square, ramp or noise).

4. Set the modulation frequency

Press **Frequency** to set the frequency of the modulating waveform. The range is from 1 Hz to 50 kHz.

5. Set the modulation depth

Modulation depth is expressed as a percentage that denotes the amplitude variation degree. Press **Depth** to set the modulation depth and the range available is from 0% to 120%. In 0% modulation, the output amplitude is half of the carrier waveform amplitude; in 100% modulation, the output amplitude is equal to the carrier waveform amplitude; when the modulation is larger than 100%, the envelope distortion will be generated and the actual circuit must be avoided. At this point, the output amplitude would not be exceed 5 Vpp (the impedance is 50 Ω).

FM

Frequency modulation, namely the frequency of the carrier waveform varies with the amplitude of the modulating waveform, as shown in the figure below.

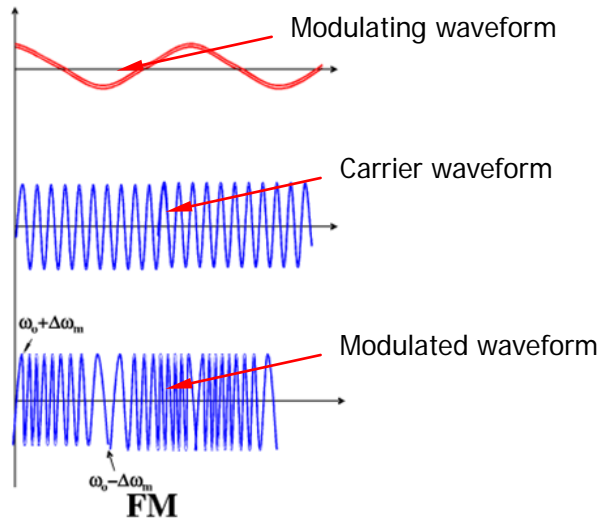

Figure 12-9 Frequency Modulation

1. Select the carrier waveform

Press **Src1Conf** to enter the waveform setting interface. Press **Wave** to select the desired carrier waveform.

Note: "Pulse", "DC" and "Noise" cannot be selected.

2. Set the carrier waveform parameters

After selecting the desired carrier waveform, set the carrier parameters (such as the frequency and amplitude) by referring to the corresponding introductions above.

3. Select the modulating waveform

Press **Src1Mod** to open the Source1 modulation setting menu. Press **Shape** to select the desired modulating waveform (sine, square, ramp or noise).

4. Set the modulation frequency

Press **Frequency** to set the frequency of the modulating waveform. The range is from 1 Hz to 50 kHz.

5. Set the modulation deviation

press **Deviation** to set the deviation of modulating waveform frequency relative to the carrier waveform frequency and the range available is from 0 Hz to the carrier waveform frequency currently set.

Chapter 13 Store and Recall

Users can save the current settings, waveforms, screen image and parameter of the oscilloscope in internal memory or external USB mass storage device (such as USB storage device) in various formats and recall the stored traces, settings or waveforms when needed.

The contents of this chapter:

- Storage System
- Storage Type
- Internal Storage and Recall
- External Storage and Recall
- Disk Management
- Factory

Storage System

Press **Storage** to enter the store and recall setting interface.

The internal memory capacity (Local Disk) of this oscilloscope is 90.5 MByte. This oscilloscope provides a USB Host interface at the front panel to connect USB storage device for external storage and the USB storage device connected is marked as "Disk D".

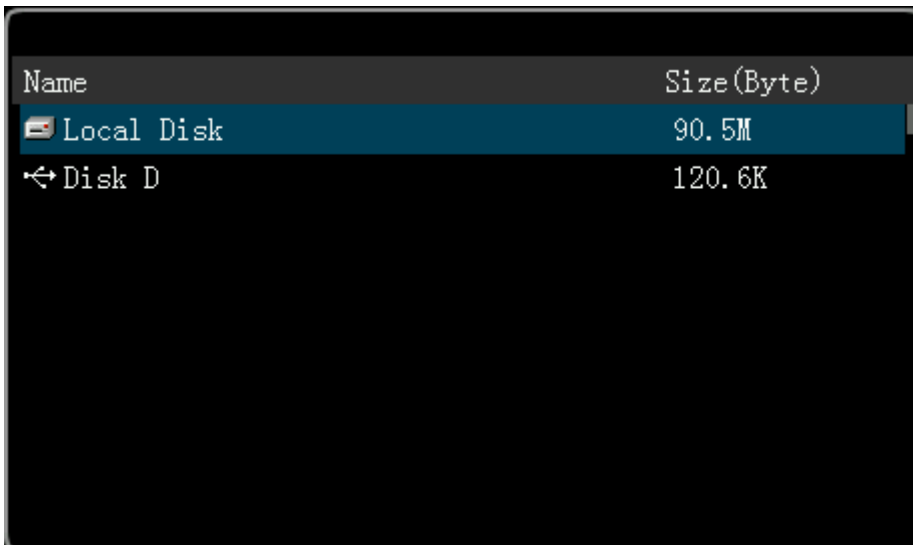

Name	Size(Byte)
Local Disk	90.5M
↔ Disk D	120.6K

Figure 13-1 Disk Management Interface

Storage Type

Press **Storage** → **Storage** to select the desired storage type. The default is "Picture". The storage and recall descriptions of each type are as follows.

1. Picture

Save the screen image in external memory in ".PNG", ".BMP8", ".BMP24", ".JPEG" or ".TIFF" format. You can specify the file name and storage directory and save the corresponding parameter file (.txt) under the same directory using the same file name. The function of this parameter file is the same as that of "Parameters". The recall of image and parameter files is not supported.

After selecting this type:

Press **Pic Type** to select the desired storage format.

Press **Para.Save** to enable or disable the parameter save function.

Tip

After a USB storage device is connected, press  at the front panel to quickly save the current screen image under the root directory of the USB storage device in "png" format.

2. Traces

Save the waveform data in external memory in ".trc" format. The data of all the channels turned on can be saved in the same file. At recall, the data will be displayed on the screen directly.

3. Waveforms

Save the waveform data in external memory in ".wfm" format. The stored files contain the waveform data of the four analog channels and the main setting information of the oscilloscope and all the data can be recalled.

4. Setups

Save the settings of the oscilloscope in internal or external memory in ".stp" format. The stored settings can be recalled.

5. CSV

Save the waveform data displayed on the screen or of the specified channels in

external memory in a single ".csv" file. You can specify the file name and the storage directory and save the corresponding parameter file (.txt) under the same directory using the same file name. The function of this parameter file is the same as that of "**Parameters**". The recall of CVS and parameter files is not supported.

After selecting this type:

Press **DataSrc** to select "Screen" or "Memory". After selecting "Memory", press **Channel** to select the desired channel (note that only channels currently enabled can be selected).

Press **Param** to enable or disable the parameter save function.







6. Parameters

Save the waveform parameters displayed on the screen in external memory in ".txt" format. The parameters include the current system information (such as the model, firmware version and software version) and the current relative settings information of the instrument (such as the vertical system, horizontal system, trigger system and channel on/off states).



Internal Storage and Recall

Internal storage and recall support “Setups” in **Storage**. In the following part, the storage and recall methods and procedures are introduced.

1. Save the specified oscilloscope setting in internal memory.

- 1) Connect the signal to the oscilloscope and obtain stable display.
- 2) Press **Storage** → **Storage** to select “Setups”, press **Save** and use  to select “Local Disk” (displayed with blue shading). Then press down  to open the local disk.
- 3) Press **New File** to create a file name using the pop-up keyboard and for specific operations please refer to the instruction of “**To Create a New File or Folder**”. If the internal memory already contains a file in this type, use  to select the file and **Save** and **Delete** are illuminated; at this point, you can press **Save** to execute the saving operation and the original file will be overwritten, or you can press **Delete** to delete the original file. Use  to select  and then press down  to return to the previous directory.



2. Load the specified type of file in internal memory.

- 1) Press **Storage** → **Storage** to select “Setups” and then press **Load** and use  to select “Local Disk”. Then press down  to open the local disk.
- 2) If the internal memory contains files in this type, use  to select the desired file to load and press **Load** to load the file selected.





External Storage and Recall

Before using external storage and recall, make sure that the USB storage device is connected correctly. External storage supports all the types of files in **Storage** but in recall, "Picture", "CSV" and "Param" are not supported. In the following part, "Trace" file is taken as an example to illustrate the external storage and recall methods and procedures.



1. Save the specified type of file in the external USB storage device.

- 1) Connect the signal to the oscilloscope and obtain stable display.
- 2) Press **Storage** → **Storage** to select "Traces", press **Save** and use  to select "Disk D". Then press down  to open the USB storage device.
- 3) Use  to select the desired storage position. The file can be stored under the root directory or in a certain folder under the root directory of the USB storage device.



Note: You can press **NewFolder** to create a new folder and for specific operation, please refer to the instruction of "To Create a New File or Folder".

- 4) After the storage position is selected, press **New File** to create a new file name using the pop-up keyboard and for detailed operations, please refer to the instruction of "To Create a New File or Folder". If the USB storage device already contains a file in this type, use  to select the file and **Save** and **Delete** are illuminated; at this point, you can press **Save** to execute the saving operation and the original file will be overwritten, or you can press **Delete** to delete the original file. Use  to select  and then press down  to return to the previous directory.
- 5) Press **OK** to execute the saving operation.

2. Load the specified type of file in the external USB storage device.

- 1) Press **Storage** → **Storage** to select "Traces" and then press **Load** and use  to select "Disk D". Then press down  to open the USB storage device.
- 2) If the USB storage device contains files in this type, use  to select the desired file to load and press **Load** to load the file selected.

Disk Management

Press **Storage** → **DiskManage** to turn on the disk management interface as shown in Figure 13-1 and use  to select the desired disk. The disk currently selected is displayed in blue shading and press down  to open the disk selected.

Execute the following operations through the disk management menu:

- To Select File Type
- To Create a New File or Folder
- To Delete a File or Folder
- To Rename a File or Folder
- To Clear the Local Memory

To Select File Type

Except the file types in **Storage**, the oscilloscope can also display, save or read some files for advanced applications such as mask file of the Pass/Fail test (*.pf), waveform record file (*.rec), upgrade file (.rgl), parameter file (*.txt) and reference waveform file (*.ref).

Press **Storage** → **DiskManage** → **File Type** to select the desired file type. The default is "*. *". Under the current directory, only files of which the suffix of the file names matches with the file type selected will be displayed in the current disk.

To Create a New File or Folder

The operation of folder is only valid in external storage. Before using external disk, make sure that the USB storage device is connected correctly.

First, press **Storage** → **Disk.Manage** and use  to select and open the internal memory or external disk ("Disk D"). Then, select the desired file type. Last, select the desired directory under which to create a new file or folder. The default is the root directory of the USB storage device.



Then, press **New File** or **New Folder** to turn on the interface as shown in the figure below.



Figure 13-2 To Create a New File or Folder

This oscilloscope supports Chinese/English input method. The file name or folder name can contain letters, numbers, underscores, spaces and Chinese characters and the length of the characters is limited to 64 bytes. The following part introduces how to input a file name or folder name using Chinese/English input method.





Operation Tip

During the name input, use the menu softkeys to select different operation areas, then turn  to select the desired content and press down  to input the content selected.

English Input Method

For example, create a file or folder with the name "Filename".

1. Press **Keyboard**.

- 1) Use  to select English input method "En" and uppercase input state "aA".
- 2) Use  to input the letter "F". If the input is wrong, press **Delete** to delete the character input.
- 3) Use  to select lowercase input state "Aa".
- 4) Use  to input the remaining letters "ilename".

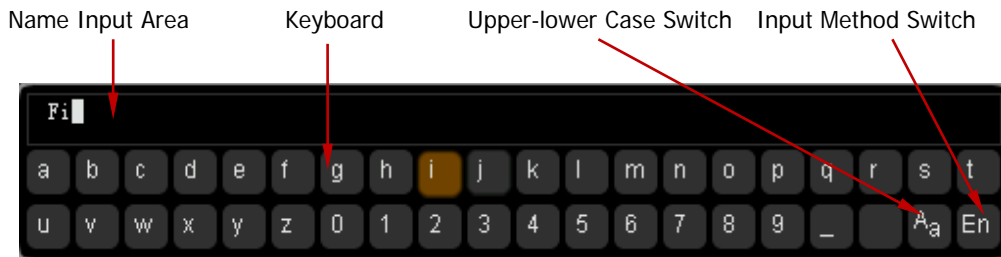



2. During the name input, you can press **Name** to select the "Name Input Area" and use  to move the cursor, then press **Delete** to delete the characters on the left of the cursor one by one.
3. After finishing the input, press **OK** and the oscilloscope will create a folder or a specified type of file with this name under the current directory.

Chinese Input Method

For example, create a file or folder with the name “文件名”.

1. Press **Keyboard**.

- 1) Use  to select Chinese input method “中”. Note that **Chinese** is added in the menu items at the right of the screen.
- 2) Use  to input the pinyin “wen”. If the input is wrong, press **Delete** to delete the pinyin input. After “wen” is input, a series of Chinese characters appear in the “Chinese Character Selecting Area”.
- 3) Press **Chinese** and use  to select and input “文”.
- 4) Use the same method to input “件” and “名”.





2. During the name input, you can press **Name** to select the “Name Input Area” and then press **Delete** to delete the Chinese characters on the left of the cursor one by one.
3. After finishing the input, press **OK** and the oscilloscope will create a folder or a specified type of file with this name under the current directory.



To Delete a File or Folder

Folder operation is valid only in external storage. Before using the external disk, make sure that the USB storage device is connected correctly.

1. Delete a file in internal memory.



- 1) Press **Storage** → **DiskManage** and use  to select and open the local disk ("local Disk").
- 2) Press **File Type** to select the desired type of file to delete.
- 3) Use  to select the desired file to delete.
- 4) Press **Delete** → **OK** to delete the file selected.

2. Delete a file or folder in external memory.

Press **Storage** → **DiskManage** and use  to select and open the external disk ("Disk D"). Use  to select the file (or folder) to be deleted and then press **Delete** → **OK** to delete the selected file (or folder).

To Rename a File or Folder

Rename operation is valid only in external storage. Before using the external disk, make sure that the USB storage device is connected correctly.

Press **Storage** → **DiskManage** and use  to select and open the external disk ("Disk D"). Use  to select the desired file or folder to rename and then press **Rename** to turn on the rename interface. For specific operations, please refer to the descriptions in "To Create a New File or Folder".

To Clear the Local Memory

Press **Storage** → **DiskManage** and select "Local Disk", then press **FlashClear** → **OK** to delete all the files and setups stored in the local memory. At the same time, the instrument will be resotred to the default setting.

Factory

Press **Storage** → **Default** to return the oscilloscope to its factory state (refer to the table below).

Table 13-1 Factory

Parameter	Factory
Horizontal Setting (HORIZONTAL)	
Vertical Setting (VERTICAL)	
Acquisition Setting (Acquire)	
Trigger Setting (TRIGGER)	
Display Setting (Display)	
Signal Source	
Cursor Setting (Cursor)	
Storage Setting (Storage)	
Utility Function Setting (Utility)	
Math Operation Setting (MATH→Operation)	
Protocol Decoding (MATH→Decode1/Decode2)	
Reference Waveform Setting (REF)	
Horizontal Setting (HORIZONTAL)	
Horizontal Time Base	1 μ s
Horizontal Offset	0 s
Delayed Sweep	OFF
Time Base Type	YT
Vertical Setting (VERTICAL)	
Vertical Scale	200 mV
Vertical Offset	0 V
CH1 Switch	ON
CH2 Switch	OFF
CH3 Switch	OFF
CH4 Switch	OFF
Channel Coupling	DC
Bandwidth Limit	OFF
Probe Ratio	10X



Channel Invert	OFF
Amplitude Scale	Coarse
Channel Unit	[V]
Acquisition Setting (Acquire)	
Acquisition Mode	Normal
Sin(x)/x	ON
Memory Depth	Auto
Anti-aliasing	OFF
Trigger Setting (TRIGGER)	
Trigger Type	Edge
Source	CH1
Slope	Rising Edge
Trigger Mode	Auto
Trigger Coupling	DC
Trigger Holdoff	16ns
Noise Reject	OFF
Display Setting (Display)	
Display Type	Vectors
Persistence Time	Min
Waveform Intensity	60%
Screen Grid	
Brightness	50%
Signal Source	
Output	OFF
Src1 Conf	
Wave	Sine
Output	OFF
Frequency	100 kHz
Amplitude	1.000 V
Offset	0.00 V
Start Phase	0.00°
Modulation	OFF

Output	OFF
Src2 Setup	
Wave	Sine
Output	OFF
Frequency	100 kHz
Amplitude	1.000 V
Offset	0.00 V
Start Phase	0.00°
Modulation	OFF
Status Display	OFF
Cursor Setting (Cursor)	
Mode	OFF
Manual	
Select	
Source	CH1
Time Unit	s
CurA	-4*1μs
CurB	4*1μs
Track	
Cursor A	CH1
Cursor B	CH1
CurA	-4*1 μs
CurB	4*1 μs
Storage Setting (Storage)	
Storage Type	Picture
Utility Function Setting (Utility)	
I/O Setting	
Network Configuration Mode	DHCP, Auto IP
Sound	
Sound	OFF
Pass/Fail Test	
Enable Test	OFF
Source	CH1

Operate	OFF
X Mask	0.24 div
Y Mask	0.48 div
Statistic Display	OFF
Stop On Output	OFF
Output	Fail
Aux Output	OFF
System Setting	
Vertical Expansion	Ground
Power On Set	Default
Math Operation Setting (MATH→Operation)	
A+B	
Display	OFF
Source A	CH1
Source B	CH1
Offset	0 V
Scale	500 mV
A-B	
Display	OFF
Source A	CH1
Source B	CH1
Offset	0 V
Scale	500 mV
A*B	
Display	OFF
Source A	CH1
Source B	CH1
Offset	0 U
Scale	500 mU
A/B	
Display	OFF
Source A	CH1
Source B	CH1
Offset	0 U
Scale	500 mU

FFT	
Display	OFF
Source	CH1
Offset	0 dBV
Scale	500 mdBV
Center	5 MHz
Hz/Div	5 MHz
Scale	20 dBV
View	Half
Unit	dB/dBm
A&&B	
Display	OFF
Source A	CH1
Source B	CH1
Offset	0 U
Scale	500 mU
Threshold A	0 V
Threshold B	0 V
A B	
Display	OFF
Source A	CH1
Source B	CH1
Offset	0 U
Scale	500 mU
Threshold A	0 V
Threshold B	0 V
A ^ B	
Display	OFF
Source A	CH1
Source B	CH1
Offset	0 U
Scale	500 mU
Threshold A	0 V
Threshold B	0 V
!A	
Display	OFF

Source A	CH1
Offset	0 U
Scale	500 mU
Threshold A	0 V
Intg	
Display	OFF
Source	CH1
Offset	0 U
Scale	1 μ U
Diff	
Display	OFF
Source	CH1
Offset	0 U
Scale	2 MU
Sqrt	
Display	OFF
Source	CH1
Offset	0 U
Scale	100 mU
Lg	
Display	OFF
Source	CH1
Offset	0 U
Scale	100 mU
Ln	
Display	OFF
Source	CH1
Offset	0 U
Scale	100 mU
Exp	
Display	OFF
Source	CH1
Offset	0 U
Scale	100 mU
Abs	
Display	OFF

Source	CH1
Offset	0 U
Scale	100 mU
Protocol Decoding (MATH→Decode1/Decode2)	
Decoder	RS232
Decode	OFF
Format	ASC
Parallel	
CLK	CH1
Edge	Rising Edge
Width	8
Bit X	0
Channel	CH1
RS232	
TX	CH1
Polarity	
Baud	9600
RX	OFF
Endian	LSB
Data	8
Stop	1
Parity	None
I2C	
SCLK	CH1
SDA	CH2
Address	Normal
SPI	
Mode	Timeout
CLK	CH1
MISO	OFF
MOSI	CH2
Edge	Rising edge
Polarity	
Timeout	20 μs
Width	8

Order	LSB
Configure	
Label	ON
Line	ON
Format	ON
Endian	OFF
Width	OFF
Data Src	Trace
Range	Full
Reference Waveform Setting (REF)	
Channel Setting	Ref1
Current Channel	Ref1
Source	CH1
Offset	0 μ V
Scale	200 mV
Color	Gray

Chapter 14 System Function Setting

The contents of this chapter:

- Remote Interface Configuration
- System-related

Remote Interface Configuration

DS1000Z can communicate with the PC via LAN, USB or GPIB (option) interface. The instrument detects the interface connection states automatically and displays the current interface connection states in **Utility** → **IO Setting** → **RemoteIO**. Please refer to the introduction below to configure the corresponding interface before using the remote interfaces.

LAN Setting

Press **Utility** → **IO Setting** → **LAN Conf.** to turn on the LAN setting interface. You can view the network connection status and configure the network parameters.

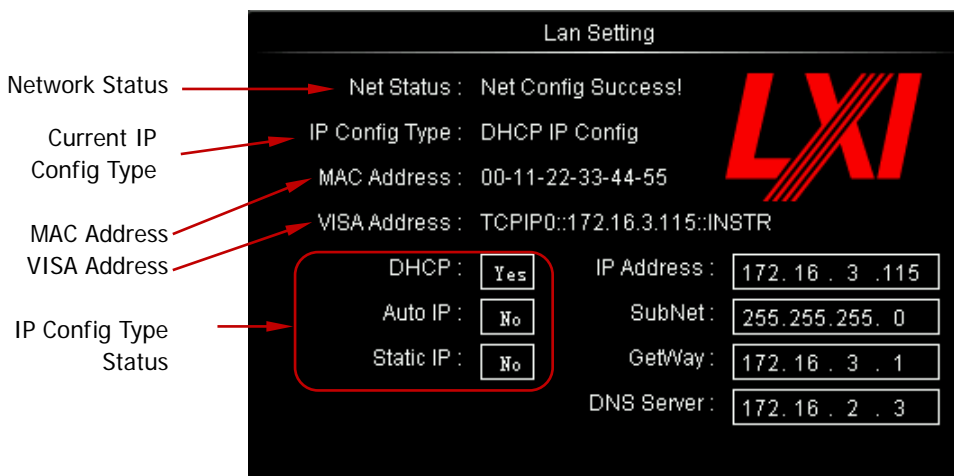



Network Status

Connect the oscilloscope to your local area network using a network cable. The network hole of the oscilloscope is at the rear panel. The oscilloscope will give different prompts according to the current network connection status.

- Net Config Success!
- Acquire IP...
- IP Conflict!
- Unconnected!
- DHCP Fail!
- Read Status Fail!



IP Configuration Type (DHCP)

The configuration type of the IP address can be DHCP, auto IP or static IP. In different IP configuration type, the configuration mode of the network parameters (such as the IP address) is different.

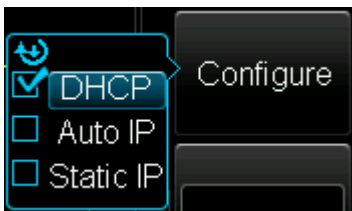

Press **Configure** and use  to select "DHCP". Then press down  to select this type. When DHCP type is valid, the DHCP server in the current network will assign the network parameters (such as the IP address) for the oscilloscope.



IP Configuration Type (Auto IP)

Press **Config Mode** and use  to select "Auto IP". Then press down  to select this type. When the auto IP type is valid, disable DHCP manually, **Gate** and **DNS** are added to the right side of the screen and users can define the gateway and DNS server address of the oscilloscope. In auto IP mode, the oscilloscope will get the IP address ranging from 169.254.0.1 to 169.254.255.254 and the subnet mask 255.255.0.0 automatically according to the current network configuration.

IP Configuration Type (Static IP)

Press **Config Mode** and use  to select "Static IP". Then press down  to select this type. When this type is valid, disable DHCP and auto IP manually, **IP Address**, **Mask**, **Gate** and **DNS** are added to the right of the screen. At this point, users can define their own network parameters (such as the IP address) of the oscilloscope.

1. Set the IP Address

The format of IP address is nnn.nnn.nnn.nnn; wherein, the range of the first nnn is from 0 to 223 (except 127) and the ranges of the other three nnn are

from 0 to 255. You are recommended to ask your network administrator for an IP address available.

Press **IP Address** and use  to input the desired IP address. This setting will be saved in the non-volatile memory and if "**Power-on Recall**" is set to "Last" and **DHCP** and **Auto IP** are "Off", the oscilloscope will load the preset IP address automatically at the next power-on.

2. Set the Subnet Mask

The format of the subnet mask is nnn.nnn.nnn.nnn; wherein, the range of the nnn is from 0 to 255. You are recommended to ask your network administrator for a subnet mask available.

Press **Mask** and use  to input the desired subnet mask. This setting will be saved in the non-volatile memory and if "**Power-on Recall**" is set to "Last" and **DHCP** and **Auto IP** are "Off", the oscilloscope will load the preset subnet mask automatically at the next power-on.

Set the Gateway

You can set this parameter in Auto IP and Static IP modes.

The format of the gateway is nnn.nnn.nnn.nnn; wherein, the range of the first nnn is from 0 to 223 (except 127) and the ranges of the other three nnn are from 0 to 255. You are recommended to ask your network administrator for a gateway address available.

Press **Gate** and use  to input the desired gate address. This setting will be saved in the non-volatile memory and if "**Power-on Recall**" is set to "Last" and **DHCP** and **Auto IP** are "Off", the oscilloscope will load the preset gateway address automatically at the next power-on.

Set the Domain Name Server

You can set this parameter in Auto IP and Static IP modes.

The address format of the domain name server is nnn.nnn.nnn.nnn; wherein, the

range of the first nnn is from 0 to 223 (except 127) and the ranges of the other three nnn are from 0 to 255. You are recommended to ask your network administrator for an address available.

press **DNS** and use  to input the desired address. Generally, users do not need to set the DNS, therefore this parameter setting can be ignored.

Tips

- When the three IP configuration types are all turned on, the priority of the parameter configuration from high to low is "DHCP", "Auto IP" and "Static IP".
- The three IP configuration types cannot be all turned off at the same time.

Apply the Network Parameter Setting

Press **Apply** to validate the current network parameter setting.

Initialize the Network Parameters

Press **Initialize** to return the network parameters to the default state.

MAC Address

For each oscilloscope, the MAC address is unique. When attributing IP address for the oscilloscope, the MAC address is usually used to identify the instrument.

VISA Address

Display the VISA address currently used by the oscilloscope.

To Select USB Device

Press **Utility** → **IO Setting** → **USB Device** to select the type of the device ("Computer" or "PictBridge ") to be connected to the USB Device interface. The default is "Computer". When "computer" is selected, the instrument can communicate with the PC; when "PictBridge" is selected, you can print the content displayed on the screen using the PictBridge printer.

To Set the GPIB Address



When using the GPIB mode to control the oscilloscope, you have to use the USB-GPIB interface converter (order it separately) to extend a GPIB interface for the oscilloscope.

To set the GPIB address of this interface, press **Utility** → **IO Setting** → **GPIB** and use  to input the desired address. The default is 1 and the range is from 1 to 30.



System-related

Sound

When the sound is enabled, you can hear the sound of the beeper when you press a function key or a menu softkey or when the prompt message pops up.

Press **Utility** → **Beeper** to select  or . The default is off. When the sound is turned on, a trumpet icon  will be displayed at the lower right corner of the screen.

Language

This oscilloscope supports multiple language menus, Chinese/English help and prompt messages. Press **Utility** → **Language** and use  to select the desired language. Then press down  to select the language.

System Information

Press **Utility** → **System** → **System Info.** to view the version information of your oscilloscope. The system information contains the following contents as shown in the figure below.

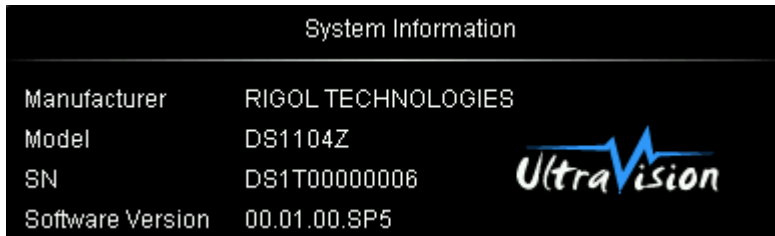

Figure 14-1 System Information

Power-on Recall

You can set the system configuration to be recalled when the oscilloscope is powered on again after power-off. Press **Utility** → **System** → **Power On Set** to select “Last” (default) or “Default”.

- Last: return to the setting of the system at last power-off.
- Default: return to the factory setting of the system.

Self-calibration

The self-calibration program can quickly make the oscilloscope reach the best working state to get the most precise measurement values. You can perform self-calibration at any time especially when the change of the environment temperature is up to or more than 5 °C. Make sure that the oscilloscope has been warmed up or operated for more than 30 minutes before the self-calibration.

Disconnect all the input channels and then press **Utility** → **Self-Cal** and the self-calibration interface as shown in the figure below is displayed.



Figure 14-2 Self-calibration

Press **Start** and the oscilloscope will start to execute the self-calibration program. Press **Exit** to give up the self-calibration operation at any time and return to the previous menu.

Note: Most of the keys are disabled during the self-calibration.

Option Management

This oscilloscope provides multiple options to fulfill your measurement requirements. Please contact your **RIGOL** sales representative or **RIGOL** technical support to order the corresponding options. You can view the options currently installed on the oscilloscope or activate the newly bought option serial number through this menu.

Press **Utility** → **Options** → **Installed** to view the options currently installed and the related option information on the oscilloscope. Press **Setup** to enter the serial number activation operation menu.

- Editor: press this softkey to turn on the serial number input interface as shown in the figure below. Use ↻ to select the characters on the virtual keyboard and press down the knob to input the character.

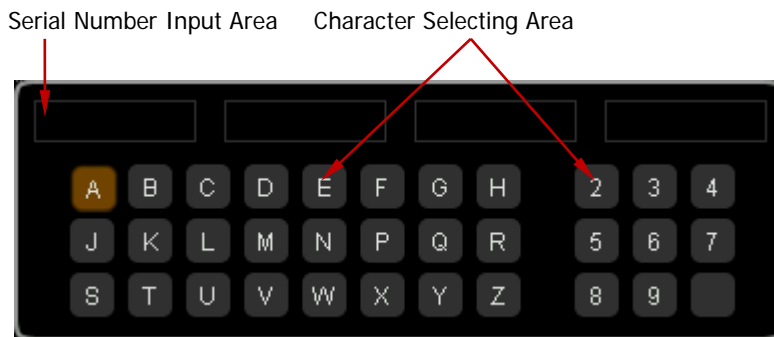

Figure 14-3 To Install Option

- Backspace: press this softkey to delete the characters in the “Serial Number Input Area” from the right to the left.
- Clear: press this softkey to clear all the characters in the “Serial Number Input Area”.
- Apply: press this softkey and the oscilloscope will activate the corresponding option using the serial number currently input.

Auto Options

As mentioned before, you can press **AUTO** at the front panel to enable the waveform autosetting function. The oscilloscope will adjust the vertical scale, horizontal scale and trigger mode automatically according to the input signal to acquire the optimum waveform display effect. This oscilloscope allows users to set the relative parameters of the waveform auto setting function.

Press **Utility** → **Auto Options** to enter the Auto setting menu and you can set the following parameters.

- Press **Lock** to lock **AUTO**, namely this key is disabled.
Note: You can only unlock the key using remote command (:SYSTem:AUToscale 1). For the remote command, refer to the *DS1000Z Programming Guide*.
- Press **Pk.Pk** to turn on or off the peak-peak priority function. When it is turned on, the instrument displays the peak-peak value using the optimum scale. This function is especially useful when you are observing the varying part of the signal with offset.
- Press **CH** to select the channel for the AUTO operation. You can select "OPENed" (channels currently turned on. If no channel is currently turned on, the AUTO operation will be performed on all the channels automatically) or "ALL". The default is "ALL".
- Press **Menu Hold** to turn on or off the menu hold function. When it is turned on, the menu as shown in Figure 6-2 will not be displayed after the AUTO operation, namely the current menu remains unchanged.
- Press **Overlay** to turn on or off the overlay display function. When it is turned on and signals are connected to multiple channels, the channels will be displayed on the screen in overlay mode and each channel occupies 8 grids of vertical range. At this point, it is easier to get stable trigger as the amplitude resolution is low. When the function is turned off, the channels will be displayed on the screen separately and each channel occupies 2 grids of vertical range; at this point, the trigger might not be stable for the amplitude resolution is high.
- Press **Coupling** to turn on or off the coupling hold function. When it is turned on, the coupling setting of the channel in which signal is detected will be held. That is, if the channel is set to DC coupling, the DC coupling will be held after signal is detected in the channel; if the channel is set to AC coupling, the AC coupling will be held after signal is detected in the channel; if the channel is set to GND, DC

coupling will be used by default. When this function is turned off, DC coupling will be used by default when signal is signal is detected in the channel.

Key Lock

Press **Utility** → **KeyLock** → **Lock** and all the softkeys and buttons (except **Unlock**) are locked. Pressing **Unlock** can unlock the keys.

Chapter 15 Remote Control

The oscilloscope can be controlled remotely mainly through the following two methods.

User-defined programming

Users can program and control the oscilloscope by using the SCPI (Standard Commands for Programmable Instruments) commands. For more information about the commands and programming, refer to the *Programming Guide*.

Use PC software provided by RIGOL or other manufacturers

Users can use the PC software **Ultra Sigma** of **RIGOL**, **Measurement & Automation Explorer** of **NI** (National Instruments Corporation) or **Agilent IO Libraries Suite** of **Agilent** (Agilent Technologies, Inc.) to send commands to control the oscilloscope remotely.

This oscilloscope can communicate with the PC through USB and LAN instrument buses. This chapter will give a detailed introduction of how to use **Ultra Sigma** to control DS1000Z remotely through various interfaces. For the **Ultra Sigma** software, please contact **RIGOL** salesmen or technical support.

The contents of this chapter:

- Remote Control via USB
- Remote Control via LAN
- Remote Control via GPIB

Remote Control via USB

1. Connect the device

Connect the USB DEVICE interface at the rear panel of the oscilloscope with the USB Host interface of your PC using a USB cable.

2. Install the USB driver

This oscilloscope is a USBTMC device. Assuming that your PC has already been installed with **Ultra Sigma**, after you connect the oscilloscope to the PC and turn both on for the first time (the oscilloscope is automatically configured to USB interface), the **New Hardware Wizard** as shown in the figure below is displayed on the PC. Please install the "USB Test and Measurement Device" driver following the directions in the wizard. The steps are as follows.

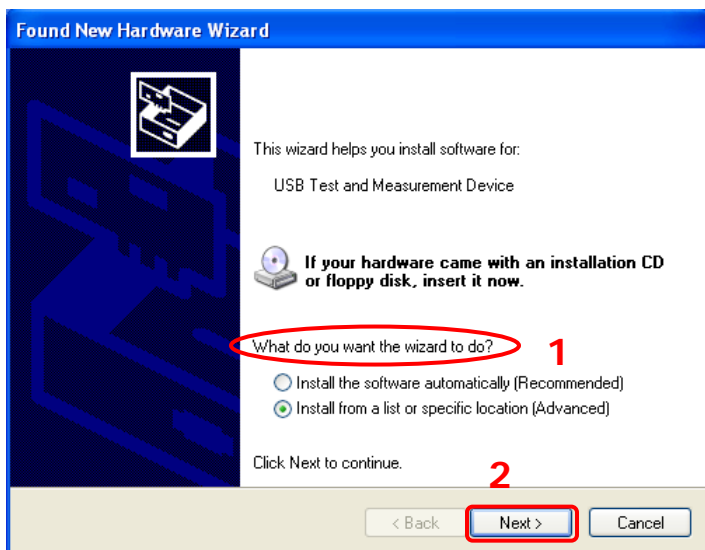

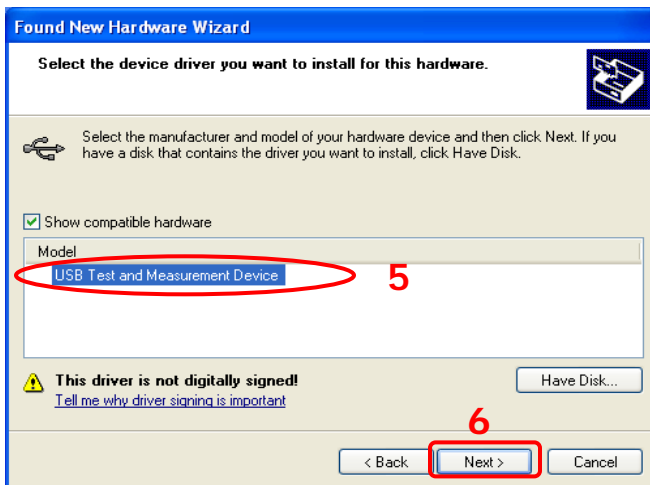
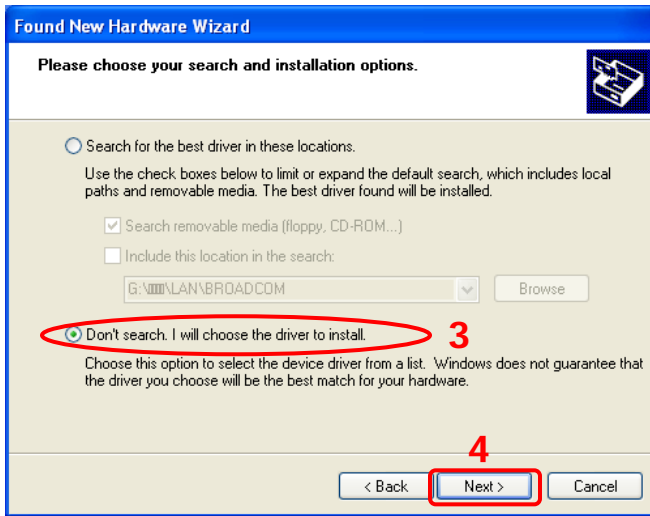

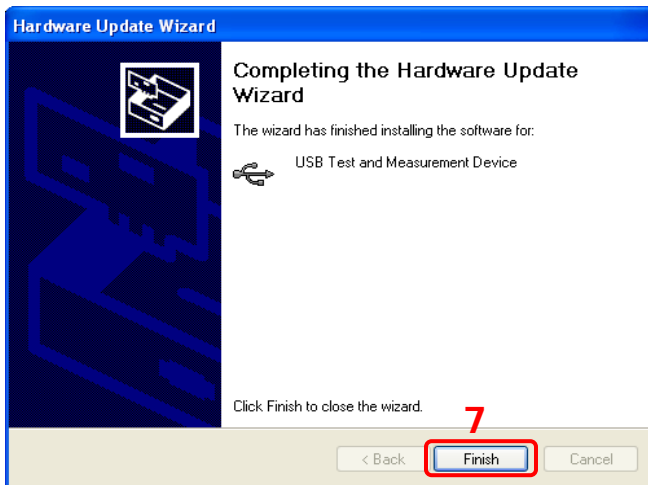
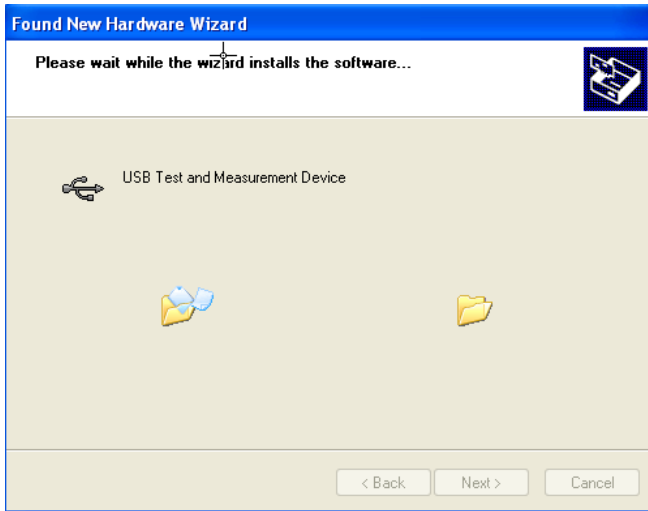

3. Search device resource

Start up the **Ultra Sigma** and the software will automatically search for the oscilloscope resources currently connected to the PC. You can also click

USB-TMC to search for the resources. During the search, the status bar of the software is as shown in the figure below.



4. View the device resource

The resources found will appear under the “RIGOL Online Resource” directory and the model number and USB interface information of the instrument will also be displayed as shown in the figure below.

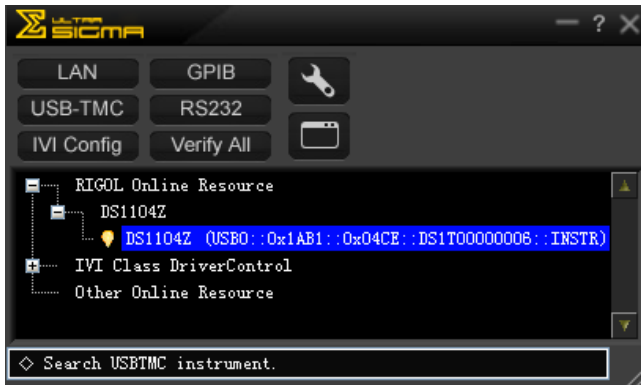

5. Communication test

Right click the resource name

“DS1104Z (USB0::0x1AB1::0x04CE::DS1T00000006::INSTR)” to select “SCPI Panel Control” to turn on the remote command control panel (as shown in the figure below) through which you can send commands and read data.

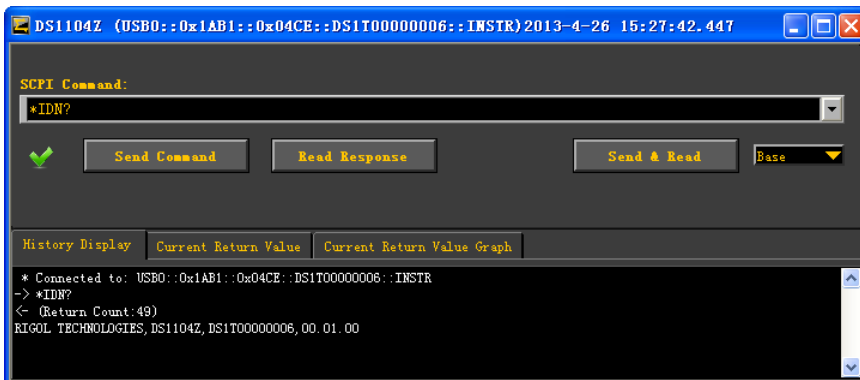

Remote Control via LAN

1. Connect the device

Connect the oscilloscope to your LAN using a network cable.

2. Configure network parameters

Configure the network parameters of the oscilloscope according to the description in "LAN Setting".

3. Search device resource

Start up the **Ultra Sigma** and click **LAN**. The window as shown in the figure below is displayed. Click **Search** and the software searches for the oscilloscope resources currently connected to the LAN.



The resources found are displayed at the right of the window. As shown in the figure below, select the desired resource name and click **OK** to add it.

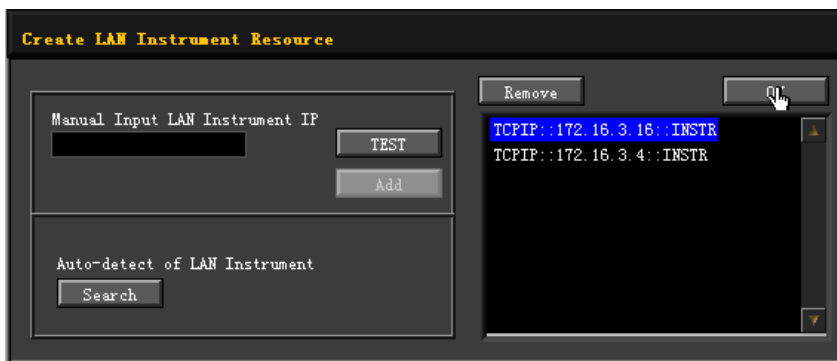

4. View device resource

The resources found will appear under the “RIGOL Online Resource” directory as shown in the figure below.



5. Communication test

Right click the resource name “DS1104Z (TCPIP::172.16.3.16::INSTR)” to select “SCPI Panel Control” to turn on the remote command control panel (as shown in the figure below) through which you can send commands and read data.

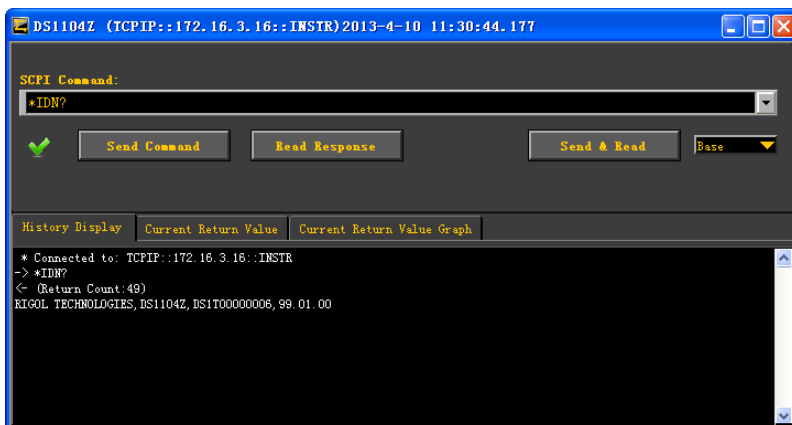

6. Load LXI webpage

As this oscilloscope conforms to LXI Core Device 2011 class instrument standards, you can load LXI webpage through **Ultra Sigma** (right-click the resource name and select LXI-Web; or directly input the IP address in the browser). Various important information about the oscilloscope (including the model number, manufacturer, serial number, description, MAC address and IP address) will be displayed on the webpage as shown in the figure below.



Remote Control via GPIB

1. Connect the device

Use the USB to GPIB interface converter to extend a GPIB interface for the oscilloscope. Then connect the oscilloscope to your PC using a GPIB cable.

2. Install the driver of GPIB card

Install the driver of the GPIB card which has been connected to the PC correctly.

3. Set the GPIB address

Set the GPIB address of the oscilloscope according to the description in **“To Set the GPIB Address”**.

4. Search for device resource

Start up the **Ultra Sigma** and click  to open the panel as shown in the figure below. Click “Search” and the software will search for the GPIB instrument resources connected to the PC. The device resources will be displayed on the right side of the panel.



If resources can not be found automatically:

- Select the GPIB card address of the PC from the comboBox of “GPIB::” and select the GPIB address set in the oscilloscope from the comboBox of “::INSTR”.
- Click “Test” to check whether the GPIB communication works normally; if not, please follow the corresponding prompt messages to solve the problem.

5. View device resource

Click "OK" to return back to the main interface of Ultra Sigma. The resources found will appear under the "RIGOL Online Resource" directory.



6. Communication Test

Right-click the resource name "DS1104Z (GPIB0::9::INSTR" to select "SCPI Panel Control" to turn on the remote command control panel through which you can send commands and read data as shown in the figure below.

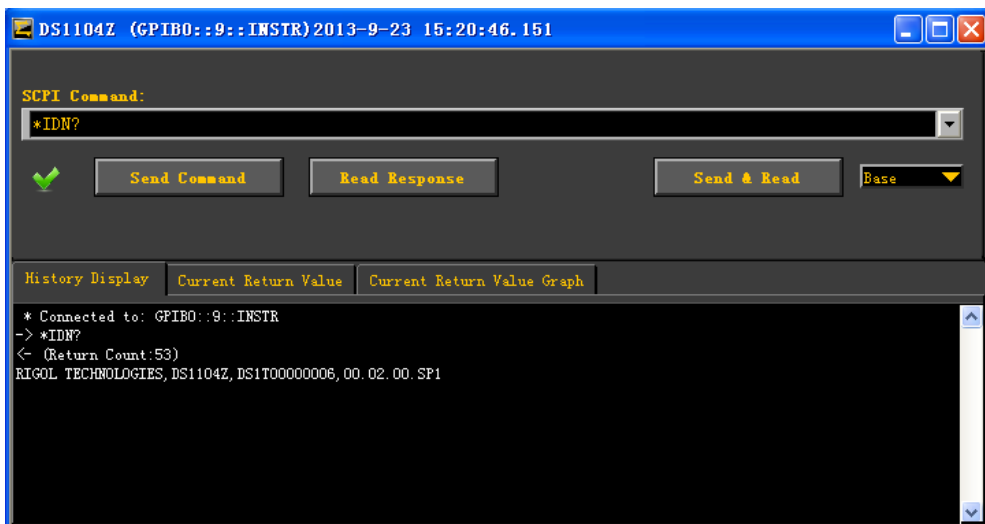

Chapter 16 Troubleshooting

The commonly encountered failures and their solutions are listed below. When you encounter those problems, please solve them following the corresponding steps. If the problem remains still, please contact **RIGOL** and provide your device information (**Utility** → **System** → **System Info**).

1. The screen is still dark (no display) after pressing the power key:

- (1) Check whether the power is correctly connected.
- (2) Check whether the fuse is burned out. If the fuse needs to be changed, please use the specified fuse.
- (3) Restart the instrument after finishing the above inspections.
- (4) If it still does not work correctly, please contact **RIGOL**.

2. The signal is sampled but no waveform of the signal is displayed:

- (1) Check whether the probe is correctly connected to the oscilloscope and the item under test.
- (2) Check whether there are signals generated from the item under test (you can connect the probe compensation signal to the problematic channel to determine which has problems, the channel or the item under test).
- (3) Resample the signal.

3. The voltage amplitude measured is greater or lower than the actual value (note that this failure usually occurs when probe is used):

Check whether the probe ratio of the channel complies with the attenuation ratio of the probe.

4. There is waveform display but not stable:

- (1) Check the trigger signal source: check whether **MENU** → **Source** in the trigger control area (TRIGGER) complies with the signal channel actually used.
- (2) Check the trigger type: general signals should use "Edge" trigger and video signal should use "Video" trigger. Only when the proper trigger type is used, can the waveform be displayed stably.
- (3) Check the trigger level: adjust the trigger level to the middle position of the

signal.

- (4) Change the trigger holdoff setting.

5. No display after pressing **RUN/STOP:**

Check whether the **MODE** at the front panel trigger control area (TRIGGER) is on "Normal" or "Single" and whether the trigger level exceeds the waveform range. If yes, set the trigger level to the middle or set the **MODE** to "Auto".

Note: Using **AUTO** could automatically finish the above setting.

6. The waveform displayed is ladder-like:

- (1) The horizontal time base might be too low. Increase the horizontal time base to increase the horizontal resolution and improve the display.
- (2) If **Display** → **Type** is "Vectors", the lines between the sample points may cause ladder-like display. Set **Type** to "Dots" to solve the problem.

7. Fail to connect PC through USB:

- (1) Check whether the USB data cable is correctly connected to the oscilloscope and PC.
- (2) Check whether the USB data cable is in good condition and if needed, restart the oscilloscope.

8. The USB storage device cannot be recognized:

- (1) Check whether the USB storage device can work normally.
- (2) Make sure that the USB storage device being used is flash type. This oscilloscope does not support hardware type USB storage device.
- (3) Make sure whether the capacity of the USB storage device is too large. It is recommended that the capacity of the USB storage device being used with this oscilloscope is no larger than 8 GBytes.
- (4) Restart the instrument and then insert the USB storage device to check it.
- (5) If the USB storage device still can not be used normally, please contact

RIGOL.

Chapter 17 Specifications

All the specifications are guaranteed except parameters marked with “Typical” and the oscilloscope needs to operate for more than 30 minutes under the specified operation temperature.

Sample

Sample Mode	Real-time sample
Real-time Sample Rate	1 GSa/s (single-channel) 500 MSa/s (dual-channel) 250 MSa/s (four-channel)
Average	After all the channels finish N samples at the same time, N can be 2, 4, 8, 16, 32, 64, 128, 256, 512, 1024.
High Resolution	The highest resolution is 12 bit
Peak Detection	4 ns
Memory Depth	Single-channel: Auto, 12k pts, 120k pts, 1.2M pts, 12M pts and 24M pts (option) are available Dual-channel: Auto, 6k pts, 60k pts, 600k pts, 6M pts and 12M pts (option) are available Four-channel: Auto, 3k pts, 30k pts, 300k pts, 3M pts and 6M pts (option) are available

Input

Number of Channels	four-channel
Input Coupling	DC, AC or GND
Input Impedance	(1 M Ω ±2%) (13 pF±3 pF)
Probe Attenuation Coefficient	0.01X-1000X, 1-2-5 step
Max Input Voltage (1M Ω)	Maximum input voltage of the analog channel CAT I 300 Vrms, CAT II 100 Vrms, transient overvoltage

	1000 Vpk With RP2200 10:1 probe: CAT II 300 Vrms
--	---

Horizontal

Time Base Scale	5 ns/div to 50 s/div
Time Base Accuracy ¹	$\leq \pm 25$ ppm
Time Base Drift	$\leq \pm 5$ ppm/year
Max Delay Range	Pre-trigger (negative delay): $\geq 1/2$ screen width Post-trigger (positive delay): 1 s to 5,000 s
Time Base Mode	Y-T, X-Y, Roll, Delayed
Number of X-Ys	1 path
Waveform Capture Rate ²	30,000 wfms/s (dots display)

Vertical

Bandwidth (-3dB)	DS1104Z: DC to 100 MHz DS1074Z: DC to 70 MHz
Single Bandwidth	DS1104Z: DC to 100 MHz DS1074Z: DC to 70 MHz
Vertical Resolution	8 bit
Vertical Scale	1 mV/div to 10 V/div
Offset Range	1 mV/div to 499 mV/div: ± 2 V 500 mV/div to 10 V/div: ± 100 V
Bandwidth Limit ¹	20 MHz
Low Frequency Response (AC coupling, -3dB)	≤ 5 Hz (on BNC)
Rise Time ¹	DS1104Z: 3.5 ns DS1074Z: 5 ns
DC Gain Accuracy ³	<10 mV: $\pm 4\%$ full scale

	≥ 10 mV: $\pm 3\%$ full scale
DC Offset Accuracy	± 0.1 div ± 2 mV $\pm 1\%$ offset
Channel to Channel Isolation	DC to maximum bandwidth: > 40 dB

Trigger

Trigger Level Range	± 5 div from the center of the screen
Trigger Mode	Auto, Normal, Single
Holdoff Range	16 ns to 10 s
High Frequency Rejection ¹	75 kHz
Low Frequency Rejection ¹	75 kHz
Trigger Sensitivity ¹	1.0div (below 5mV or noise rejection is enabled) 0.3div (above 5mV and noise rejection is disabled)

Edge Trigger

Edge Type	Rising, Falling, Rising&Falling
-----------	---------------------------------

Pulse Trigger

Pulse Condition	Positive Pulse Width (greater than, lower than, within specified interval) Negative Pulse Width (greater than, lower than, within specified interval)
Pulse Width Range	8 ns to 10 s

Runt Trigger (Option)

Pulse Condition	None, > (greater than), < (lower than), <> (within the specified interval)
Polarity	Positive, Negative
Pulse Width Range	8 ns to 10 s

Windows Trigger (Option)

Windows Type	Rising, Falling, Rising&Falling
Trigger Position	Enter, Exit, Time
Windows Time	8 ns to 10 s

Nth Edge Trigger (Option)

Edge Type	Rising, Falling
Idle Time	16 ns to 10 s
Number of Edges	1 to 65535
Slope Trigger	
Slope Condition	Positive Slope (greater than, lower than, within specified interval) Negative Slope (greater than, lower than, within specified interval)
Time Setting	8 ns to 10 s
Video Trigger	
Signal Standard	Support standard NTSC, PAL and SECAM broadcasting standards Support 480P, 576P HDTV standards
Pattern Trigger	
Pattern Setting	H, L, X, Rising Edge, Falling Edge
Delay Trigger (Option)	
Edge Type	Rising, Falling
Delay Type	> (greater than), < (lower than), <> (within the specified interval), >< (outside the specified interval)
Delay Time	8 ns to 10 s
TimeOut Trigger (Option)	
Edge Type	Rising, Falling, Rising&Falling
TimeOut Value	16 ns to 10 s
Duration Trigger	
Pattern Setting	H, L, X
Trigger Condition	> (greater than), < (lower than), <> (within the specified interval)
Duration Time	8 ns to 10 s
Setup/Hold Trigger (Option)	
Edge Type	Rising, Falling
Data Pattern	H, L, X
Setup Time	8 ns to 1 s
Hold Time	8 ns to 1 s
RS232/UART Trigger (Option)	
Polarity	Normal, Invert
Trigger Condition	Start, Error, Check Error, Data

Baud	2400 bps, 4800 bps, 9600 bps, 19200 bps, 38400 bps, 57600 bps, 115200 bps, User
Data Bits	5 bits, 6 bits, 7 bits, 8 bits
I2C Trigger (Option)	
Trigger Condition	Start, Restart, Stop, Missing Ack, Address, Data, A&D
Address Bits	7 bits, 8 bits, 10 bits
Address Range	0x0 to 0x7F, 0x0 to 0xFF, 0x0 to 1023
Byte Length	1 to 5
SPI Trigger (Option)	
Trigger Condition	TimeOut, CS
Timeout Value	16 ns to 10 s
Data Bits	4 bit to 32 bit
Data Line Setting	H, L, X

Measure

Cursor	Manual mode	Voltage deviation between cursors (ΔV) Time deviation between cursors (ΔT) Reciprocal of ΔT (Hz) ($1/\Delta T$)
	Track mode	Voltage and time values of the waveform point
	Auto mode	Allow to display cursors during auto measurement
Auto Measurement	Measurements of Maximum, Minimum, Peak-Peak Value, Top Value, Bottom Value, Amplitude, Average, Mean Square Root, Overshoot, Pre-shoot, Area, Period Area, Frequency, Period, Rise Time, Fall Time, Positive Pulse Width, Negative Pulse Width, Positive Duty Cycle, Negative Duty Cycle, Delay A→B \bar{f} , Delay A→B \bar{t} , Phase A→B \bar{f} , Phase A→B \bar{t}	
Number of Measurements	Display 5 measurements at the same time	
Measurement Range	Screen Region	
Measurement Statistic	Average, Max, Min, Standard Deviation, Number of Measurements	

Counter	Hardware 6 bits counter (channels are selectable)
---------	---

Math

Waveform Operation	A+B, A-B, A×B, A/B, FFT, &&, , ^, !, Intg, Diff, Sqrt, Lg, Ln, Exp, Abs
FFT Window	Rectangle, Hanning, Blackman, Hamming, Flat Top, Triangle
FFT Display	Half, Full
FFT Vertical Scale	dB/dBm, Vrms
Number of Buses for Decoding	2
Decoding Type	Parallel (standard), RS232/UART (option), I2C (option), SPI (option)

Display

Display Type	7.0 inches TFT LCD display
Display Resolution	800 horizontal×RGB×480 vertical pixel
Display Color	160,000 Color (TBD)
Persistence Time	Min, 100 ms, 200 ms, 500 ms, 1 s, 2 s, 5 s, 10 s, 20 s, Infinite
Display Type	Dots, Vectors

I/O

Standard Ports	USB HOST, USB DEVICE, LAN, Aux (TrigOut /PassFail), GPIB (extended via the USB HOST interface)
----------------	--

Signal Source (DS1000Z-S)

Number of Channels	2
Sample Rate	200 MSa/s
Vertical Resolution	14 bits
Highest Frequency	25 MHz

Standard Waveform	Sine, Square, Pulse, Triangle, Noise, DC	
Arbitrary Waveform	Since, Exp.Rise, EXP.Fall, ECG, Gauss, Lorentz, Haversine	
Sine	Frequency Range	0.1 Hz to 25 MHz
	Flatness	±0.5 dB (relative to 1 kHz)
	Harmonic Distortion	-40 dBc
	Stray (Non-Harmonic)	-40 dBc
	Total Harmonic Distortion	1%
	Signal-to-Noise Ratio	40 dB
Square/Pulse	Frequency Range	0.1 Hz to 15 MHz
	Rise/Fall Time	<15 ns
	Overshoot	<5%
	Duty Cycle	10% to 90%
	Duty Cycle Resolution	1% to 10 ns (select the greater one)
	Minimum Pulse Width	20 ns
	Pulse Width Resolution	10 ns or 5 bits (select the greater one)
	Jitter	500 ps
Triangle	Frequency Range	0.1 Hz to 100 kHz
	Linearity	1%
	Symmetry	0 to 100%
Noise ¹	Bandwidth	25 MHz
Internal Generated waveforms	Frequency Range	0.1 Hz to 1 MHz
Arbitrary Waveforms	Frequency Range	0.1 Hz to 10 MHz
	Waveform Length	2 to 16k pts
Frequency	Accuracy	100 ppm (lower than 10 kHz) 50 ppm (greater than 10 kHz)
	Resolution	0.1 Hz or 4 bit, select the greater one
Amplitude	Output Range	20 mVpp to 5 Vpp, HighZ

		10 mVpp to 2.5 Vpp, 50 Ω
	Resolution	100 μ V or 3 bit, select the greater one
	Accuracy	2% (1 kHz)
DC Offset	Range	\pm 2.5 V, HighZ \pm 1.25 V, 50 Ω
	Resolution	100 μ V or 3 bit, select the greater one
	Accuracy	2% (1 kHz)

General Specifications

Probe Compensation Output		
Output Voltage ¹	About 3 V, peak-peak	
Frequency ¹	1 kHz	
Power		
Power Voltage	100-240 V, 45-440 Hz	
Power	Maximum 50 W	
Fuse	2 A, T degree, 250 V	
Environment		
Temperature Range	In operation: 0 $^{\circ}$ C to +50 $^{\circ}$ C Out of operation: -40 $^{\circ}$ C to +70 $^{\circ}$ C	
Cooling Method	Fan	
Humidity Range	0 $^{\circ}$ C to +30 $^{\circ}$ C: \leq 95% relative humidity +35 $^{\circ}$ C to +40 $^{\circ}$ C: \leq 75% relative humidity +40 $^{\circ}$ C to +50 $^{\circ}$ C: \leq 45% relative humidity	
Altitude	In operation: under 3,000 meters Out of operation: under 15,000 meters	
Mechanical		
Dimensions ⁴	Width \times Height \times Depth = 313.1 mm \times 160.8 mm \times 122.4 mm	
Weight ⁴	Without package	3.2 kg \pm 0.2 kg
	With package	3.8 kg \pm 0.5 kg
Adjustment Interval		
The recommended calibration interval is one year.		
Regulation Standards		

Electromagnetic Compatibility	2004/108/EC Execution standard EN 61326-1:2006 EN 61326-2-1:2006
Safety	UL 61010-1:2004; CAN/CSA-C22.2 NO. 61010-1-2004; EN 61010-1:2001; IEC 61010-1:2001

- 1 Typical.
- 2 Maximum value with 50 ns, single-channel, dots display and auto memory depth.
- 3 Tilt tabs and handle folded, knob height included.
- 4 Standard configuration.

Chapter 18 Appendix

Appendix A: Accessories and Options

	Descriptions	Order Number
Models	DS1104Z (100 MHz, 4-channel)	DS1104Z
	DS1104Z-S (100 MHz, 4-channel+dual-channel, 25MHz signal source)	DS1104Z-S
	DS1074Z (70 MHz, 4-channel)	DS1074Z
	DS1074Z-S (70 MHz, 4-channel+dual-channel, 25MHz signal source)	DS1074Z-S
Standard Accessories	Power Cord conforming to the standard of the country	-
	USB data cable	CB-USBA-USBB-FF-150
	4 passive probes (150 MHz)	RP2200
	Quick Guide	-
	Resource CD (include User's Guide and application software)	-
Optional Accessories	Rack Mount Kit	RM-DS1000Z
Memory Depth Options	24Mpts (single-channel) /12Mpts (dual-channel)/6 Mpts (four-channel)	MEM-DS1000Z
Waveform Record Option	The option supports waveform record and waveform playback	REC-DS1000Z
Advanced Trigger Options	The option include RS232/UART trigger, I2C trigger, SPI trigger, Runt trigger, Windows trigger, Nth edge trigger, Delay trigger, Timeout trigger	AT-DS1000Z
Serial Decoding Options	The option include RS232/UART, I2C and SPI decoding functions	SA-DS1000Z

Note: All the options or accessories can be ordered from you local **RIGOL** Office.

Appendix B: Warranty

RIGOL warrants that its products mainframe and accessories will be free from defects in materials and workmanship within the warranty period.

If a product is proven to be defective within the respective period, **RIGOL** guarantees the free replacement or repair of products which are approved defective. To get repair service, please contact with your nearest **RIGOL** sales and service office.

RIGOL does not provide any other warranty items except the one being provided by this summary and the warranty statement. The warranty items include but not being subjected to the hint guarantee items related to tradable characteristic and any particular purpose. **RIGOL** will not take any responsibility in cases regarding to indirect, particular and ensuing damage.

Index

- Duty 6-63
- Rate 6-67
- Width 6-63
- + Duty 6-63
- + Rate 6-67
- + Width 6-63
- Acquisition Mode 4-2
- AM 12-18
- amplitude 12-2
- Antialiasing 4-7
- Area 6-67
- Auto 5-3
- Auto IP 14-3
- Average 4-2
- Bandwidth Limit 2-3
- Blackman 6-50
- Built-In Waveform 12-7
- Channel Coupling 2-3
- Channel Label 2-7
- CSV 13-3
- DC offset voltage 12-2
- DC Waveform 12-5
- Delay 6-64
- Delay Calibration 2-8
- Delay Trigger 5-32
- Delayed Sweep 3-2
- DHCP 14-3
- Domain Name Server 14-4
- Dots 11-2
- Duration Trigger 5-21
- Duty cycle 12-5
- ECG 12-8
- Edge Trigger 5-9
- Edge Type 5-9
- Exp.Fall 12-8
- Exp.Rise 12-8
- Factory 13-14
- Fall Time 6-63
- Flattop 6-50
- FM 12-20
- Frequency 6-63, 12-2
- Frequency Counter 6-68
- Gateway 14-4
- Gauss 12-9
- Hamming 6-50
- Hanning 6-50
- Haversine 12-9
- High Resolution 4-3
- I2C Decoding 7-13
- I2C Trigger 5-8, 5-38
- impedance 12-3
- Interpolation 12-16
- IP Address 14-3
- LAN 14-2
- Lorentz 12-9
- MAC 14-5
- Memory Depth 4-6
- modulating waveform 12-19
- Modulation 12-18
- modulation depth 12-19
- modulation deviation 12-21
- modulation frequency 12-19
- Network Status 14-2
- Noise Rejection 5-7
- Noise Waveform 12-6
- Normal 4-2
- Normal 5-4
- Nth Edge Trigger 5-34

Overshoot.....	6-66	start phase.....	12-3
Parallel Decoding.....	7-2	Static IP.....	14-3
Parameters.....	13-4	Subnet Mask.....	14-4
Pattern Setting.....	5-19, 5-22	Symmetry.....	12-4
Peak Detect.....	4-3	Sync.....	5-17
Period.....	6-63	Threshold.....	6-69
Period Area.....	6-67	Time Setting.....	5-14
Persistence Time.....	11-3	To Create Waveform.....	12-14
Phase.....	6-64	To Edit Waveform.....	12-13, 12-16
Picture.....	13-3	To Select Waveform.....	12-14
Preshoot.....	6-66	Traces.....	13-3
Probe Ratio.....	2-4	Triangle.....	6-50
Pulse Condition.....	5-11	Trigger Coupling.....	5-5
Pulse Polarity.....	5-27	Trigger Holdoff.....	5-6
Pulse Trigger.....	5-11	Trigger Level.....	5-9
Pulse Waveform.....	12-5	Trigger Mode.....	5-3
Pulse Width Setting.....	5-11	Trigger Position.....	5-30
Qualifier.....	5-27	Trigger Source.....	5-2
Ramp Waveform.....	12-4	tVmax.....	6-63
Rectangle.....	6-50	tVmin.....	6-63
Rise Time.....	6-63	USB.....	14-6
Roll.....	3-8	Vamp.....	6-65
RS232 Decoding.....	7-7	Vavg.....	6-65
RS232 Trigger.....	5-8, 5-36	Vbase.....	6-65
Runt Trigger.....	5-27	Vectors.....	11-2
Sample Rate.....	4-4	Vertical Scale.....	2-5
Setup/Hold Trigger.....	5-23	Vertical Window.....	5-14, 5-28
Setups.....	13-3	Video Polarity.....	5-17
Sin(x)/x.....	4-4	Video Standard.....	5-17
Sinc.....	12-7	Video Trigger.....	5-17
Sine Waveform.....	12-2	VISA.....	14-5
Single.....	5-4	Vlower.....	6-65
Slope Condition.....	5-13	Vmax.....	6-65
Slope Trigger.....	5-13	Vmid.....	6-65
SPI Decoding.....	7-17	Vmin.....	6-65
SPI Trigger.....	5-8, 5-41	Vpp.....	6-65
Square Waveform.....	12-4	Vrms.....	6-65

Vtop	6-65	Window Function.....	6-49
Vupper.....	6-65	Windows Trigger	5-8, 5-30
Waveform Confusion	4-4	Windows Type.....	5-30
Waveform Distortion	4-4	X-Y.....	3-5
Waveform Leakage	4-5	Y-T.....	3-4
Waveforms.....	13-3		